

Cincinnati Reds - 1950





| Batter   | 1   | 2   | 3   | 4   | 5   | 6   | 7   | 8   | 9   | AB R H RBI BB SO LOB   | TOP                                     |  |
|--|---|---|---|---|---|---|---|---|---|--|---|--|
| Grady Hatton, L (1, 5)<br>OBP: 0.200, SLG: 0.111   | 4-0<br>BB<br>G6-4-3                                   |   | 0-0<br>4-3  |   |   | 0-0<br>F9   |   | 0-3<br>K  | 0-0<br>F9   | 4 0 0 0 1 1 5  |   |  |
| Bob Usher, R (1, 8)<br>OBP: 0.600, SLG: 2.000  | 0-0<br>G6-4-3<br>1-2f                                 |   |   | 0-3<br>K  |   | 0-0<br>HR   |   | 0-0<br>2B<br>1-H<br>2-H                             |   | 4 2 2 3 0 1 1  |   |  |
| Johnny Wyrostek, L (1, 9)<br>OBP: 0.444, SLG: 0.778  | 0-0<br>1-3  |   |   | 0-0<br>1-3  |   | 0-0<br>4-3  |   | 0-0<br>2B<br>2-H                                    |   | 4 0 1 1 0 0 0  |   |  |
| Walker Cooper, R (1, 2)<br>OBP: 0.111, SLG: 0.111  |   | 0-3<br>K  |   | 0-0<br>F3   |   | 0-0<br>6-3  |   | 0-0<br>F9   |   | 4 0 0 0 0 1 1  |   |  |
| Danny Litwhiler, R (1, 7)<br>OBP: 0.250, SLG: 0.625  |   | 0-0<br>6-3  |   |   | 0-0<br>HR   |   | 0-0<br>F8   | 0-0<br>6-3  |   | 4 1 1 1 0 0 1  |   |  |
| Ted Kluszewski, L (1, 3)<br>OBP: 0.333, SLG: 0.333   |   | 0-0<br>F5   |   |   | 0-0<br>1B   |   | 0-0<br>6-3  |   | 0-0<br>F7   | 4 0 1 0 0 0 0  |   |  |
| Jimmy Bloodworth, R (1, 4)<br>OBP: 0.375, SLG: 0.429   |   |   | 0-0<br>FC4-6<br>1B                                  |   | 0-0<br>F7   |   | 0-0<br>1-3  |   | 0-0<br>F9   | 4 0 1 0 0 0 1  |   |  |
| Virgil Stallcup, R (1, 6)<br>OBP: 0.625, SLG: 0.714  |   |   | 0-0<br>FC4-6<br>1-2f                                |   | 0-0<br>F9   |   |   | 0-0<br>1B<br>2B<br>1B                               | 0-0<br>WP<br>1B                                     | 4 1 2 0 0 0 2  |   |  |
| Herm Wehmeier, R (1, 1)<br>Frank Smith, R (5, 1)<br>Peanuts Lowrey, R (8, PH)<br>Eddie Erautt, R (8, 1)<br>Ron Northey, L (9, PH)<br>Marv Rackley, L (9, PR) |   |   | 0-0<br>F6   |   | 0-0<br>F8   |   |   | 0-0<br>2B<br>1B                                     | 4-0<br>BB   | 2 0 0 0 0 0 2<br>0 0 0 0 0 0 0<br>1 1 1 0 0 0 0<br>0 0 0 0 0 0 0<br>0 0 0 0 1 0 0<br>0 0 0 0 0 0 0 |   |  |
| <b>Inning Stats</b>  | R: 0 H: 0<br>E: 0 LOB: 0<br>K: 0 BB: 1<br>S: 2 P: 6   | R: 0 H: 0<br>E: 0 LOB: 0<br>K: 1 BB: 0<br>S: 5 P: 5 | R: 0 H: 1<br>E: 0 LOB: 1<br>K: 0 BB: 0<br>S: 4 P: 4 | R: 0 H: 0<br>E: 0 LOB: 0<br>K: 1 BB: 0<br>S: 5 P: 5 | R: 1 H: 2<br>E: 0 LOB: 1<br>K: 0 BB: 0<br>S: 5 P: 5 | R: 1 H: 1<br>E: 0 LOB: 0<br>K: 0 BB: 0<br>S: 4 P: 4 | R: 0 H: 0<br>E: 0 LOB: 0<br>K: 0 BB: 0<br>S: 3 P: 3 | R: 3 H: 4<br>E: 0 LOB: 1<br>K: 1 BB: 0<br>S: 9 P: 9 | R: 0 H: 1<br>E: 0 LOB: 2<br>K: 0 BB: 1<br>S: 4 P: 8 | 1B: 5 SF: 0<br>2B: 2 SAC: 0<br>3B: 0 DP: 1<br>HR: 2 HBP: 0   | WP: 1 PA: 37<br>PB: 0<br>SB: 0<br>CS: 0 |  |
| <b>PITCHER</b>   | IP WLS BF H R ER SO BB IBB HBP BLK WP HR S P ERA WHIP |   |   |   |   |   |   |   |   |  |   |  |
| Bill Werle, L (1, 1)<br>ERA: 6.14  | 7.1 W 30 8 5 5 3 1 0 0 0 0 2 35 39 6.14 1.227         |   |   |   |   |   |   |   |   |  |   |  |
| Hal Gregg, R (8, 1)<br>ERA:  | 1.1 6 1 0 0 0 1 0 0 0 1 0 5 9 0.00 1.500              |   |   |   |   |   |   |   |   |  |   |  |
| Vic Lombardi, L (9, 1)<br>ERA:   | 0.1 S 1 0 0 0 0 0 0 0 0 0 0 1 1 0.00 0.000            |   |   |   |   |   |   |   |   |  |   |  |

Cincinnati Reds @ Pittsburgh Pirates  
 Forbes Field, Pittsburgh, PA  
 Fri Apr 21 1950, 3:33 AM EST  
 Att. 32,685 - Cloudy - 52 F

livebaseballscorecards.com

AB 35  
 R 5  
 H 9  
 RBI 5  
 BB 2  
 SO 3  
 LOB 13



| Batter  | 1         | 2         | 3                                    | 4         | 5                       | 6                           | 7              | 8          | 9 |
|---|-----------|-----------|--------------------------------------|-----------|-------------------------|-----------------------------|----------------|------------|---|
| Ted Beard, L<br>OBP: 0.333, SLG: 0.529 (1, 9)       | 0-0<br>G3 |           | 0-0<br>1B<br>E<br>1B                 |           | 0-0<br>3-1              | 4-0<br>FC6-4<br>BB          |                | 0-0<br>4-3 |   |
| Johnny Hopp, L<br>OBP: 0.154, SLG: 0.154 (1, 3)     | 0-0<br>F8 |           | 0-0<br>1B                            |           | 0-0<br>F8               | 0-0<br>F7                   |                | 0-0<br>4-3 |   |
| Ralph Kiner, R<br>OBP: 0.412, SLG: 0.533 (1, 7)     | 0-0<br>HR |           | 4-0<br>E<br>IBB                      |           | 4-0<br>BB<br>HR<br>BB   | 0-0<br>FC6-4<br>1-2f<br>2-3 |                | 0-0<br>1B  |   |
| Nanny Fernandez, R<br>OBP: 0.125, SLG: 0.067 (1, 5) | 0-0<br>F2 |           | 0-3<br>K                             |           | 4-0<br>1-2<br>HR<br>BB  | 0-0<br>F5                   |                | 0-3<br>K   |   |
| Wally Westlake, R<br>OBP: 0.500, SLG: 1.000 (1, 8)  |           | 0-0<br>HR | 0-0<br>E7<br>1-3<br>2-H<br>3-H<br>1B |           | 0-0<br>1-H<br>2-H<br>HR |                             | 0-0<br>1-3     |            |   |
| Danny Murtaugh, R<br>OBP: 0.353, SLG: 0.286 (1, 4)  |           | 0-0<br>F8 | 0-0<br>F9                            |           | 0-0<br>1B<br>1B         |                             | 4-0<br>E<br>BB |            |   |
| Stan Rojek, R<br>OBP: 0.286, SLG: 0.308 (1, 6)      |           | 0-0<br>L8 |                                      | 0-3<br>K  | 0-0<br>1-2<br>1B        |                             | 0-0<br>FC1     |            |   |
| Clyde McCullough, R (1, 2)                          |           | 0-0<br>L8 |                                      | 0-0<br>F9 | 0-3<br>K                |                             | 0-3<br>K       |            |   |
| Bill Werle, L<br>OBP: 0.500, SLG: 0.500 (1, 1)      |           |           | 0-0<br>1B<br>E<br>1B                 | 0-3<br>K  |                         | 0-0<br>FC6-4<br>BB<br>1B    | 0-3<br>K       |            |   |
| Hal Gregg, R (8, 1)                                 |           |           |                                      |           |                         |                             |                |            |   |
| Vic Lombardi, L (9, 1)                              |           |           |                                      |           |                         |                             |                |            |   |

| Inning Stats | R: 1 | H: 1 | E: 0 | LOB: 0 | K: 0 | BB: 0 | S: 4 | P: 4  |
|--------------|------|------|------|--------|------|-------|------|-------|
|              | R: 1 | H: 1 | E: 0 | LOB: 0 | K: 0 | BB: 0 | S: 4 | P: 4  |
|              | R: 2 | H: 4 | E: 1 | LOB: 2 | K: 1 | BB: 1 | S: 8 | P: 12 |
|              | R: 0 | H: 0 | E: 0 | LOB: 0 | K: 2 | BB: 0 | S: 7 | P: 7  |
|              | R: 3 | H: 3 | E: 0 | LOB: 2 | K: 1 | BB: 2 | S: 8 | P: 16 |
|              | R: 0 | H: 1 | E: 0 | LOB: 2 | K: 0 | BB: 1 | S: 4 | P: 8  |
|              | R: 0 | H: 0 | E: 1 | LOB: 2 | K: 2 | BB: 1 | S: 8 | P: 12 |
|              | R: 0 | H: 1 | E: 0 | LOB: 1 | K: 1 | BB: 0 | S: 6 | P: 6  |

| PITCHER                              | IP  | WLS | BF | H | R | ER | SO | BB | IBB | HBP | BLK | WP | HR | S  | P  | ERA   | WHIP  |
|--------------------------------------|-----|-----|----|---|---|----|----|----|-----|-----|-----|----|----|----|----|-------|-------|
| Herm Wehmeier, R<br>ERA: 13.5 (1, 1) | 4.2 | L   | 24 | 8 | 7 | 7  | 3  | 2  | 1   | 0   | 0   | 0  | 3  | 27 | 39 | 13.50 | 2.143 |
| Frank Smith, R<br>ERA: (5, 1)        | 2.1 |     | 12 | 2 | 0 | 0  | 3  | 2  | 0   | 0   | 0   | 0  | 0  | 16 | 24 | 0.00  | 1.714 |
| Eddie Erault, R<br>ERA: 13.5 (8, 1)  | 1.0 |     | 4  | 1 | 0 | 0  | 1  | 0  | 0   | 0   | 0   | 0  | 0  | 6  | 6  | 0.00  | 1.000 |

| AB | R | H | RBI | BB | SO | LOB |
|----|---|---|-----|----|----|-----|
| 4  | 1 | 1 | 0   | 1  | 0  | 0   |
| 5  | 0 | 1 | 0   | 0  | 0  | 2   |
| 3  | 2 | 2 | 1   | 2  | 0  | 2   |
| 4  | 1 | 0 | 0   | 1  | 2  | 6   |
| 4  | 2 | 3 | 6   | 0  | 0  | 0   |
| 3  | 0 | 1 | 0   | 1  | 0  | 2   |
| 4  | 0 | 1 | 0   | 0  | 1  | 1   |
| 4  | 0 | 0 | 0   | 0  | 2  | 4   |
| 4  | 1 | 2 | 0   | 0  | 2  | 2   |
| 0  | 0 | 0 | 0   | 0  | 0  | 0   |
| 0  | 0 | 0 | 0   | 0  | 0  | 0   |

| WP | PA | ERA | WHIP |
|----|----|-----|------|
| 0  | 40 |     |      |
| 0  |    |     |      |
| 0  |    |     |      |

**Cincinnati Reds @ Pittsburgh Pirates**  
**Forbes Field, Pittsburgh, PA**  
 Fri Apr 21 1950, 3:33 AM EST  
 Att: 32,685 - Cloudy - 52 F

|     |    |
|-----|----|
| AB  | 35 |
| R   | 7  |
| H   | 11 |
| RBI | 7  |
| BB  | 5  |
| SO  | 7  |
| LOB | 19 |



| 1B | 2B | 3B | HR | SF | SAC | DP | HBP |
|----|----|----|----|----|-----|----|-----|
| 8  | 0  | 0  | 3  | 0  | 0   | 0  | 0   |

| Batter   | 1                            | 2                                  | 3                            | 4                               | 5                            | 6                               | 7                            | 8                               | 9                            | AB R H RBI BB SO LOB            | TOP                          |                                 |                              |                                 |                              |                                 |                                  |                                    |                                  |        |     |     |    |    |   |   |     |      |  |  |  |  |
|--|------------------------------|------------------------------------|------------------------------|---------------------------------|------------------------------|---------------------------------|------------------------------|---------------------------------|------------------------------|---------------------------------|------------------------------|---------------------------------|------------------------------|---------------------------------|------------------------------|---------------------------------|----------------------------------|------------------------------------|----------------------------------|--------|-----|-----|----|----|---|---|-----|------|--|--|--|--|
| Grady Hatton, L (1, 5)<br>OBP: 0.143, SLG: 0.077     | 0-0<br>4-3                   |                                    | 0-3<br>K                     |                                 | 0-0<br>F8                    |                                 |                              | 0-0<br>F2                       |                              | 4 0 0 0 0 1 1                   |                              |                                 |                              |                                 |                              |                                 |                                  |                                    |                                  |        |     |     |    |    |   |   |     |      |  |  |  |  |
| Lloyd Merriman, L (1, 8)<br>OBP: 0.250, SLG: 0.250   | 0-0<br>G4-6-3<br>1B          |                                    |                              | 0-0<br>4-3                      |                              | 0-0<br>F7                       |                              | 0-0<br>F5                       |                              | 4 0 1 0 0 0 0                   |                              |                                 |                              |                                 |                              |                                 |                                  |                                    |                                  |        |     |     |    |    |   |   |     |      |  |  |  |  |
| Johnny Wyrostek, L (1, 7)<br>OBP: 0.462, SLG: 0.692  | 0-0<br>G4-6-3<br>1-2f        |                                    |                              | 0-0<br>1-3                      |                              | 0-0<br>FC3-6<br>1B              |                              | 0-0<br>1B                       |                              | 4 0 2 0 0 0 1                   |                              |                                 |                              |                                 |                              |                                 |                                  |                                    |                                  |        |     |     |    |    |   |   |     |      |  |  |  |  |
| Ted Kluszewski, L (1, 3)<br>OBP: 0.385, SLG: 0.333   |                              | H<br>1-0<br>1B PB<br>G1-4-3<br>HBP |                              | 0-0<br>1B                       |                              | 0-0<br>FC3-6<br>1-2f            |                              | 0-0<br>G3                       |                              | 3 1 1 0 0 0 2                   |                              |                                 |                              |                                 |                              |                                 |                                  |                                    |                                  |        |     |     |    |    |   |   |     |      |  |  |  |  |
| Ron Northey, L (1, 9)<br>OBP: 0.600, SLG: 0.500      |                              | X<br>0-0<br>G1-4-3<br>1-3<br>1B    |                              | 0-0<br>4-3                      |                              | 0-0<br>4-3                      |                              | 0-0<br>G1-4-3<br>1B             |                              | 4 0 2 0 0 0 2                   |                              |                                 |                              |                                 |                              |                                 |                                  |                                    |                                  |        |     |     |    |    |   |   |     |      |  |  |  |  |
| Walker Cooper, R (1, 2)<br>OBP: 0.091, SLG: 0.091    |                              | X<br>0-0<br>G1-4-3                 |                              |                                 | 0-0<br>E5<br>1B<br>F8        |                                 |                              | 0-0<br>G1-4-3                   |                              | 2 0 0 0 0 0 1                   |                              |                                 |                              |                                 |                              |                                 |                                  |                                    |                                  |        |     |     |    |    |   |   |     |      |  |  |  |  |
| Herm Wehmeier, R (5, PR)                             |                              |                                    |                              |                                 |                              |                                 |                              | 0-0<br>2B                       |                              | 0 1 0 0 0 0 0                   |                              |                                 |                              |                                 |                              |                                 |                                  |                                    |                                  |        |     |     |    |    |   |   |     |      |  |  |  |  |
| Johnny Pramesa, R (5, 2)<br>OBP: 0.500, SLG: 1.000   |                              | 1-2f<br>3-H                        |                              |                                 |                              |                                 |                              | 0-0<br>F2                       |                              | 2 0 1 0 0 0 1                   |                              |                                 |                              |                                 |                              |                                 |                                  |                                    |                                  |        |     |     |    |    |   |   |     |      |  |  |  |  |
| Jimmy Bloodworth, R (1, 4)<br>OBP: 0.333, SLG: 0.364 |                              | X<br>0-0<br>5-3                    |                              |                                 | X<br>0-0<br>1-3<br>1B        |                                 | X<br>0-0<br>6-3              | X<br>0-0<br>F2                  |                              | 4 0 1 0 0 0 1                   |                              |                                 |                              |                                 |                              |                                 |                                  |                                    |                                  |        |     |     |    |    |   |   |     |      |  |  |  |  |
| Virgil Stallcup, R (1, 6)<br>OBP: 0.455, SLG: 0.500  |                              |                                    | X<br>0-0<br>F9               |                                 | X<br>0-0<br>F8               |                                 | X<br>0-0<br>F6               |                                 |                              | 3 0 0 1 0 0 2                   |                              |                                 |                              |                                 |                              |                                 |                                  |                                    |                                  |        |     |     |    |    |   |   |     |      |  |  |  |  |
| Johnny Hetki, R (1, 1)                               |                              |                                    | X<br>0-0<br>F9               |                                 | 0-3<br>K                     |                                 | X<br>0-0<br>F4               |                                 |                              | 0 0 0 0 0 0 0                   |                              |                                 |                              |                                 |                              |                                 |                                  |                                    |                                  |        |     |     |    |    |   |   |     |      |  |  |  |  |
| Kent Peterson, R (2, 1)                              |                              |                                    |                              |                                 |                              |                                 |                              |                                 |                              | 1 0 0 0 0 0 0                   |                              |                                 |                              |                                 |                              |                                 |                                  |                                    |                                  |        |     |     |    |    |   |   |     |      |  |  |  |  |
| Jay Avrea, R (4, 1)                                  |                              |                                    |                              |                                 |                              |                                 |                              |                                 |                              | 1 0 0 0 0 1 1                   |                              |                                 |                              |                                 |                              |                                 |                                  |                                    |                                  |        |     |     |    |    |   |   |     |      |  |  |  |  |
| Danny Litwhiler, R (7, PH)<br>OBP: 0.222, SLG: 0.556 |                              |                                    |                              |                                 |                              |                                 |                              |                                 |                              | 1 0 0 0 0 0 1                   |                              |                                 |                              |                                 |                              |                                 |                                  |                                    |                                  |        |     |     |    |    |   |   |     |      |  |  |  |  |
| Eddie Erautt, R (7, 1)                               |                              |                                    |                              |                                 |                              |                                 |                              |                                 |                              | 0 0 0 0 0 0 0                   |                              |                                 |                              |                                 |                              |                                 |                                  |                                    |                                  |        |     |     |    |    |   |   |     |      |  |  |  |  |
| <b>Inning Stats</b>                                  | R: 0<br>E: 0<br>K: 0<br>S: 3 | H: 1<br>LOB: 0<br>BB: 0<br>P: 3    | R: 1<br>E: 0<br>K: 0<br>S: 3 | H: 1<br>LOB: 0<br>BB: 0<br>P: 4 | R: 0<br>E: 0<br>K: 1<br>S: 5 | H: 0<br>LOB: 0<br>BB: 0<br>P: 5 | R: 0<br>E: 0<br>K: 0<br>S: 4 | H: 1<br>LOB: 1<br>BB: 0<br>P: 4 | R: 1<br>E: 1<br>K: 1<br>S: 7 | H: 1<br>LOB: 1<br>BB: 0<br>P: 7 | R: 0<br>E: 0<br>K: 0<br>S: 4 | H: 1<br>LOB: 1<br>BB: 0<br>P: 4 | R: 0<br>E: 0<br>K: 0<br>S: 4 | H: 1<br>LOB: 1<br>BB: 0<br>P: 4 | R: 0<br>E: 0<br>K: 0<br>S: 3 | H: 1<br>LOB: 0<br>BB: 0<br>P: 3 | 1B: 7<br>2B: 1<br>3B: 0<br>HR: 0 | SF: 0<br>SAC: 0<br>DP: 3<br>HBP: 1 | WP: 0<br>PB: 1<br>SB: 0<br>CS: 0 | PA: 34 |     |     |    |    |   |   |     |      |  |  |  |  |
| <b>PITCHER</b><br>Bob Chesnes, R (1, 1)<br>ERA: 2.25 | IP<br>9.0                    | WLS<br>W                           | BF<br>34                     | H<br>8                          | R<br>2                       | ER<br>0                         | SO<br>2                      | BB<br>0                         | IBB<br>0                     | HBP<br>1                        | BLK<br>0                     | WP<br>0                         | HR<br>0                      | S<br>37                         | P<br>38                      | ERA<br>0.00                     | WHIP<br>0.889                    |                                    |                                  |        |     |     |    |    |   |   |     |      |  |  |  |  |
|  |                              |                                    |                              |                                 |                              |                                 |                              |                                 |                              |                                 | <b>PITCHER</b>               | IP                              | WLS                          | BF                              | H                            | R                               | ER                               | SO                                 | BB                               | IBB    | HBP | BLK | WP | HR | S | P | ERA | WHIP |  |  |  |  |

Cincinnati Reds @ Pittsburgh Pirates  
 Forbes Field, Pittsburgh, PA  
 Sat Apr 22 1950, 3:33 AM EST  
 Att. 14,533 - Unknown

livebaseballscorecards.com

|     |    |
|-----|----|
| AB  | 33 |
| R   | 2  |
| H   | 8  |
| RBI | 1  |
| BB  | 0  |
| SO  | 2  |
| LOB | 13 |



| Batter  | 1          | 2            | 3         | 4          | 5         | 6         | 7          | 8         | 9 | AB | R | H | RBI | BB | SO | LOB |
|---|------------|--------------|-----------|------------|-----------|-----------|------------|-----------|---|----|---|---|-----|----|----|-----|
| Ted Beard, L<br>OBP: 0.391, SLG: 0.650 (1, 9)                     | 0-3<br>K   | 0-0<br>HR    |           | 4-0<br>HR  | 4-0<br>BB |           | 0-0<br>4-3 |           |   | 3  | 2 | 1 | 2   | 2  | 1  | 0   |
| Johnny Hopp, L<br>OBP: 0.167, SLG: 0.118<br>Dale Coogan, L (8, 3) | 0-0<br>F4  | 0-0<br>G3    |           | 0-0<br>F8  | 4-0<br>BB |           | 0-3<br>K   |           |   | 4  | 0 | 0 | 0   | 1  | 1  | 1   |
| Ralph Kiner, R<br>OBP: 0.455, SLG: 0.684 (1, 7)                   | 0-0<br>2B  | 4-0<br>FC6-4 |           | 0-0<br>HR  | 4-3<br>BB |           | 0-0<br>6-3 |           |   | 4  | 2 | 2 | 2   | 1  | 0  | 2   |
| Nanny Fernandez, R<br>OBP: 0.190, SLG: 0.350 (1, 5)               | 0-0<br>2B  | 0-0<br>FC6-4 |           | 0-0<br>HR  | 0-0<br>P3 |           | 0-0<br>F8  |           |   | 5  | 2 | 2 | 1   | 0  | 0  | 3   |
| Wally Westlake, R<br>OBP: 0.471, SLG: 1.000 (1, 8)                | 4-0<br>2B  |              | 0-0<br>HR | 0-0<br>5-3 |           | 0-0<br>F7 |            | 0-0<br>F6 |   | 4  | 2 | 1 | 1   | 1  | 0  | 0   |
| Danny Murtaugh, R<br>OBP: 0.455, SLG: 0.500 (1, 4)                | 0-0<br>FC5 |              | 0-0<br>WP | 0-0<br>1B  |           | 4-0<br>1B |            | 0-0<br>F8 |   | 4  | 0 | 3 | 3   | 1  | 0  | 0   |
| Stan Rojek, R<br>OBP: 0.333, SLG: 0.353 (1, 6)                    | 0-0<br>FC5 |              | 0-0<br>F8 | 0-0<br>1B  |           | 0-0<br>1B |            | 0-0<br>1B |   | 4  | 0 | 2 | 0   | 0  | 0  | 2   |
| Ed Fitz Gerald, R<br>OBP: 0.143, SLG: 0.286 (1, 2)                |            | 0-0<br>5-3   | 0-3<br>K  | 0-3<br>K   |           | 0-0<br>P1 |            |           |   | 4  | 0 | 0 | 0   | 0  | 2  | 5   |
| Bob Chesnes, S<br>OBP: 0.286, SLG: 0.167 (1, 1)                   |            | 0-0<br>HR    | 0-0<br>F3 |            | 0-0<br>L3 |           | 0-0<br>F7  |           |   | 4  | 1 | 1 | 0   | 0  | 0  | 3   |

| Inning Stats | R: 3 | H: 3 | E: 0 | K: 1 | S: 8 | LOB: 1 | P: 12 | R: 2 | H: 2 | E: 0 | K: 0 | S: 5 | LOB: 1 | P: 9 | R: 1 | H: 2 | E: 0 | K: 1 | S: 7 | R: 3 | H: 4 | E: 0 | K: 0 | S: 9 | LOB: 2 | P: 13 | R: 0 | H: 0 | E: 0 | K: 0 | S: 3 | LOB: 2 | P: 11 | R: 0 | H: 1 | E: 0 | K: 0 | S: 4 | LOB: 2 | P: 8 | R: 0 | H: 0 | E: 0 | K: 1 | S: 5 | LOB: 0 | P: 5 | R: 0 | H: 0 | E: 0 | K: 0 | S: 3 | LOB: 0 | P: 3 |
|--------------|------|------|------|------|------|--------|-------|------|------|------|------|------|--------|------|------|------|------|------|------|------|------|------|------|------|--------|-------|------|------|------|------|------|--------|-------|------|------|------|------|------|--------|------|------|------|------|------|------|--------|------|------|------|------|------|------|--------|------|
|--------------|------|------|------|------|------|--------|-------|------|------|------|------|------|--------|------|------|------|------|------|------|------|------|------|------|------|--------|-------|------|------|------|------|------|--------|-------|------|------|------|------|------|--------|------|------|------|------|------|------|--------|------|------|------|------|------|------|--------|------|

| PITCHER                              | IP  | WLS | BF | H | R | ER | SO | BB | IBB | HBP | BLK | WP | HR | S  | P  | ERA   | WHIP  |
|--------------------------------------|-----|-----|----|---|---|----|----|----|-----|-----|-----|----|----|----|----|-------|-------|
| Johnny Hetki, R<br>ERA: 11.12 (1, 1) | 1.1 | L   | 10 | 5 | 5 | 5  | 1  | 0  | 1   | 0   | 0   | 0  | 1  | 11 | 15 | 33.75 | 3.750 |
| Kent Peterson, L<br>ERA: 18.0 (2, 1) | 2.0 |     | 12 | 4 | 4 | 4  | 1  | 2  | 0   | 0   | 0   | 1  | 3  | 12 | 20 | 18.00 | 3.000 |
| Jay Avrea, R<br>ERA: (4, 1)          | 2.2 |     | 14 | 3 | 0 | 0  | 1  | 3  | 0   | 0   | 0   | 0  | 0  | 13 | 25 | 0.00  | 2.250 |
| Eddie Erautt, R<br>ERA: 6.75 (7, 1)  | 2.0 |     | 6  | 0 | 0 | 0  | 1  | 0  | 0   | 0   | 0   | 0  | 0  | 8  | 8  | 0.00  | 0.000 |

**BOTTOM**

**Cincinnati Reds @ Pittsburgh Pirates**

Forbes Field, Pittsburgh, PA

Sat Apr 22 1950, 3:33 AM EST  
Att. 14,533 - Unknown

|     |    |
|-----|----|
| AB  | 36 |
| R   | 9  |
| H   | 12 |
| RBI | 9  |
| BB  | 6  |
| SO  | 4  |
| LOB | 16 |



| 1B | 2B | 3B | HR | SF | SAC | DP | HBP | WP | HR | S  | P  | ERA   | WHIP  |
|----|----|----|----|----|-----|----|-----|----|----|----|----|-------|-------|
| 5  | 3  | 0  | 4  | 0  | 0   | 0  | 0   | 1  | 3  | 11 | 15 | 33.75 | 3.750 |

| Batter  | 1  | 2                               | 3                            | 4                               | 5                            | 6                               | 7                            | 8                               | 9                            | AB R H RBI BB SO LOB            | TOP   |                                 |  |                                 |                              |                                 |                              |                                 |                              |                                 |                                  |                                    |                                  |        |
|---|--|---------------------------------|------------------------------|---------------------------------|------------------------------|---------------------------------|------------------------------|---------------------------------|------------------------------|---------------------------------|---|---------------------------------|--|---------------------------------|------------------------------|---------------------------------|------------------------------|---------------------------------|------------------------------|---------------------------------|----------------------------------|------------------------------------|----------------------------------|--------|
| <b>Bobby Adams, R</b> (1, 5)<br>OBP: 0.600, SLG: 0.750        | 0-3<br>K   |                                 | 0-0<br>FC5-4                 |                                 | 0-0<br>1B                    |                                 | 4-0<br>1B BB                 |                                 | 0-0<br>2B                    | 4 0 2 0 1 1 2                   | <b>Cincinnati Reds @ Pittsburgh Pirates</b><br><b>Forbes Field, Pittsburgh, PA</b><br>Sun Apr 23 1950, 3:33 AM EST<br>Att: 18,049 - Unknown<br><a href="http://livebaseballscorecards.com">livebaseballscorecards.com</a> |                                 |  |                                 |                              |                                 |                              |                                 |                              |                                 |                                  |                                    |                                  |        |
| <b>Bob Usher, R</b> (1, 8)<br>OBP: 0.400, SLG: 1.100          | 0-3<br>K   |                                 | 0-0<br>G3                    |                                 | 0-0<br>F9                    |                                 | 0-0<br>FC4-6 1B              |                                 | 0-0<br>F4                    | 5 0 1 0 0 1 4                   |   |                                 |  |                                 |                              |                                 |                              |                                 |                              |                                 |                                  |                                    |                                  |        |
| <b>Johnny Wyrostek, L</b> (1, 9)<br>OBP: 0.412, SLG: 0.588    | 0-0<br>5-3   |                                 |                              |                                 | 0-0<br>2B F9 1B              |                                 | 0-0<br>F4                    |                                 | 0-0<br>FC4-6                 | 4 1 1 0 0 0 2                   |   |                                 |  |                                 |                              |                                 |                              |                                 |                              |                                 |                                  |                                    |                                  |        |
| <b>Danny Litwhiler, R</b> (1, 7)<br>OBP: 0.231, SLG: 0.417    |  |                                 |                              |                                 | 0-0<br>F4                    |                                 | 4-0<br>HR BB                 |                                 | 0-0<br>F6                    | 3 1 0 0 1 0 1                   |   |                                 |  |                                 |                              |                                 |                              |                                 |                              |                                 |                                  |                                    |                                  |        |
| <b>Joe Adcock, R</b> (1, 3)<br>OBP: 0.500, SLG: 0.750         |  |                                 |                              |                                 | 0-0<br>1-3 2B                |                                 | 0-0<br>F4                    |                                 | 0-0<br>1B                    | 4 0 2 0 0 0 1                   |   |                                 |  |                                 |                              |                                 |                              |                                 |                              |                                 |                                  |                                    |                                  |        |
| <b>Johnny Pramesa, R</b> (1, 2)<br>OBP: 0.333, SLG: 1.000     |  |                                 |                              |                                 | 0-0<br>F9                    |                                 | 0-0<br>HR                    |                                 | 0-0<br>F6                    | 4 1 1 3 0 0 2                   |   |                                 |  |                                 |                              |                                 |                              |                                 |                              |                                 |                                  |                                    |                                  |        |
| <b>Jimmy Bloodworth, R</b> (1, 4)<br>OBP: 0.313, SLG: 0.286   |  |                                 |                              |                                 | 0-0<br>3-H F5                |                                 | 0-0<br>4-3                   |                                 | 0-0<br>F9                    | 3 0 0 0 1 0 2                   |   |                                 |  |                                 |                              |                                 |                              |                                 |                              |                                 |                                  |                                    |                                  |        |
| <b>Virgil Stallcup, R</b> (1, 6)<br>OBP: 0.333, SLG: 0.357    |  |                                 |                              |                                 | 0-0<br>FC5-4 1B BB           |                                 | 0-0<br>P3                    |                                 | 0-0<br>5-3                   | 4 0 0 0 0 0 1                   |   |                                 |  |                                 |                              |                                 |                              |                                 |                              |                                 |                                  |                                    |                                  |        |
| <b>Frank Smith, R</b> (1, 1)<br>OBP: 0.500, SLG: 0.500        |  |                                 |                              |                                 | 0-0<br>F9                    |                                 | 0-0<br>6-3                   |                                 | 0-0<br>6-3                   | 2 0 1 0 0 1 0                   |   |                                 |  |                                 |                              |                                 |                              |                                 |                              |                                 |                                  |                                    |                                  |        |
| <b>Ewell Blackwell, R</b> (6, 1)                              |  |                                 |                              |                                 | 0-0<br>K                     |                                 | 0-0<br>K                     |                                 | 0-0<br>F9                    | 0 0 0 0 0 0 0                   |   |                                 |  |                                 |                              |                                 |                              |                                 |                              |                                 |                                  |                                    |                                  |        |
| <b>Peanuts Lowrey, R</b> (7, PH)<br>OBP: 0.286, SLG: 0.286    |  |                                 |                              |                                 | 1-2<br>FC5-4 1B              |                                 | 0-0<br>F8                    |                                 | 0-0<br>F9                    | 1 0 0 0 0 0 0                   |   |                                 |  |                                 |                              |                                 |                              |                                 |                              |                                 |                                  |                                    |                                  |        |
| <b>Howie Fox, R</b> (7, 1)                                    |  |                                 |                              |                                 |                              |                                 |                              |                                 |                              | 0 0 0 0 0 0 0                   |   |                                 |  |                                 |                              |                                 |                              |                                 |                              |                                 |                                  |                                    |                                  |        |
| <b>Walker Cooper, R</b> (9, PH)<br>OBP: 0.083, SLG: 0.083     |  |                                 |                              |                                 |                              |                                 |                              |                                 |                              | 1 0 0 0 0 0 0                   |   |                                 |  |                                 |                              |                                 |                              |                                 |                              |                                 |                                  |                                    |                                  |        |
| <b>Inning Stats</b>   | R: 0<br>E: 0<br>K: 2<br>S: 7   | H: 0<br>LOB: 0<br>BB: 0<br>P: 7 | R: 0<br>E: 0<br>K: 0<br>S: 3 | H: 0<br>LOB: 0<br>BB: 0<br>P: 3 | R: 0<br>E: 0<br>K: 0<br>S: 4 | H: 1<br>LOB: 2<br>BB: 1<br>P: 8 | R: 1<br>E: 0<br>K: 0<br>S: 5 | H: 2<br>LOB: 1<br>BB: 0<br>P: 5 | R: 0<br>E: 0<br>K: 1<br>S: 6 | H: 1<br>LOB: 1<br>BB: 0<br>P: 6 | R: 2<br>E: 0<br>K: 0<br>S: 4  | H: 1<br>LOB: 0<br>BB: 1<br>P: 8 | R: 0<br>E: 0<br>K: 0<br>S: 4   | H: 1<br>LOB: 2<br>BB: 1<br>P: 8 | R: 0<br>E: 0<br>K: 0<br>S: 4 | H: 1<br>LOB: 1<br>BB: 0<br>P: 4 | R: 0<br>E: 0<br>K: 0<br>S: 4 | H: 1<br>LOB: 1<br>BB: 0<br>P: 4 | R: 0<br>E: 0<br>K: 0<br>S: 4 | H: 1<br>LOB: 1<br>BB: 0<br>P: 4 | 1B: 5<br>2B: 2<br>3B: 0<br>HR: 1 | SF: 0<br>SAC: 0<br>DP: 0<br>HBP: 0 | WP: 0<br>PB: 0<br>SB: 0<br>CS: 0 | PA: 38 |
| <b>PITCHER</b><br><b>Cliff Chambers, L</b> (1, 1)<br>ERA: 2.0 | IP: 9.0<br>WLS: W<br>BF: 38<br>H: 8<br>R: 3<br>ER: 3<br>SO: 3<br>BB: 3<br>IBB: 0<br>HBP: 0<br>BLK: 0<br>WP: 0<br>HR: 1<br>S: 41<br>P: 53<br>ERA: 3.00<br>WHIP: 1.222 |                                 |                              |                                 |                              |                                 |                              |                                 |                              |                                 |   | <b>PITCHER</b>                  | IP: 9.0<br>WLS: W<br>BF: 38<br>H: 8<br>R: 3<br>ER: 3<br>SO: 3<br>BB: 3<br>IBB: 0<br>HBP: 0<br>BLK: 0<br>WP: 0<br>HR: 1<br>S: 41<br>P: 53<br>ERA: 3.00<br>WHIP: 1.222 |                                 |                              |                                 |                              |                                 |                              |                                 |                                  |                                    |                                  |        |





| Batter   | 1         | 2       | 3       | 4      | 5             | 6            | 7 | 8 | 9 | AB R H RBI BB SO LOB |
|--|-----------|---------|---------|--------|---------------|--------------|---|---|---|----------------------|
| Ted Beard, L (1, 9)<br>OBP: 0.407, SLG: 0.652        | 0-0 F7    |         | 0-0 2B  |        | 0-0 F5        | 4-0 FC5 BB   |   |   |   | 3 0 1 1 1 0 1        |
| Johnny Hopp, L (1, 3)<br>OBP: 0.273, SLG: 0.300      | 0-0 WP 3B |         | 0-3 K   |        | 0-0 HBP 1B    | 4-0 BB       |   |   |   | 3 1 2 2 1 1 1        |
| Ralph Kiner, R (1, 7)<br>OBP: 0.423, SLG: 0.591      | 0-3 K     |         | 0-0 1-3 |        | 1-0 FC6-4 HBP | 0-0 FC5      |   |   |   | 3 0 0 0 0 1 4        |
| Nanny Fernandez, R (1, 5)<br>OBP: 0.160, SLG: 0.292  | 0-0 F9    |         | 0-0 F8  |        | 0-0 FC6-4     |              |   |   |   | 4 0 0 0 0 1 3        |
| Wally Westlake, R (1, 8)<br>OBP: 0.429, SLG: 1.000   |           | 0-0 HR  |         | 0-3 K  |               | 0-3 K        |   |   |   | 4 1 1 1 0 2 0        |
| Danny Murtaugh, R (1, 4)<br>OBP: 0.423, SLG: 0.429   |           | 0-3 K   |         | 0-0 F8 |               | 4-0 BB S BB  |   |   |   | 3 1 0 0 1 2 0        |
| Stan Rojek, R (1, 6)<br>OBP: 0.318, SLG: 0.300       |           | 0-0 6-3 |         | 0-0 F7 |               | 4-0 BB BB BB |   |   |   | 3 1 0 0 1 0 0        |
| Clyde McCullough, R (1, 2)<br>OBP: 0.125, SLG: 0.067 |           | 0-0 E5  |         |        | 0-0 SH3-4 1B  | 0-0 F7       |   |   |   | 4 1 1 0 0 0 2        |
| Cliff Chambers, L (1, 1)<br>OBP: 0.429, SLG: 0.200   |           | 0-0 1-3 |         |        | 0-0 SH3-4     | 4-0 BB BB BB |   |   |   | 2 0 0 0 1 1 1        |

| Inning Stats                     | R: 1<br>E: 0<br>K: 1<br>S: 6       | H: 1<br>LOB: 0<br>BB: 0<br>P: 6  | R: 1<br>E: 1<br>K: 1<br>S: 7 | H: 1<br>LOB: 1<br>BB: 0<br>P: 7 | R: 0<br>E: 0<br>K: 1<br>S: 6 | H: 1<br>LOB: 1<br>BB: 0<br>P: 6 | R: 0<br>E: 0<br>K: 1<br>S: 5 | H: 0<br>LOB: 0<br>BB: 0<br>P: 5 | R: 1<br>E: 0<br>K: 0<br>S: 5 | H: 2<br>LOB: 2<br>BB: 0<br>P: 6 | R: 2<br>E: 0<br>K: 1<br>S: 5 | H: 0<br>LOB: 3<br>BB: 5<br>P: 25 | R: 0<br>E: 0<br>K: 2<br>S: 7 | H: 0<br>LOB: 0<br>BB: 0<br>P: 7 | R: 0<br>E: 0<br>K: 1<br>S: 5 | H: 0<br>LOB: 0<br>BB: 0<br>P: 5 |
|----------------------------------|------------------------------------|----------------------------------|------------------------------|---------------------------------|------------------------------|---------------------------------|------------------------------|---------------------------------|------------------------------|---------------------------------|------------------------------|----------------------------------|------------------------------|---------------------------------|------------------------------|---------------------------------|
| 1B: 2<br>2B: 1<br>3B: 1<br>HR: 1 | SF: 0<br>SAC: 1<br>DP: 0<br>HBP: 1 | WP: 1<br>PB: 0<br>SB: 1<br>CS: 0 | PA: 36                       |                                 |                              |                                 |                              |                                 |                              |                                 |                              |                                  |                              |                                 |                              |                                 |

| PITCHER                           | IP  | WLS | BF | H | R | ER | SO | BB | IBB | HBP | BLK | WP | HR | S  | P  | ERA  | WHIP  |
|-----------------------------------|-----|-----|----|---|---|----|----|----|-----|-----|-----|----|----|----|----|------|-------|
| Frank Smith, R (1, 1)<br>ERA: 5.0 | 5.2 | L   | 28 | 5 | 5 | 5  | 5  | 4  | 0   | 1   | 0   | 1  | 1  | 33 | 50 | 7.94 | 1.588 |
| Ewell Blackwell, R (6, 1)<br>ERA: | 0.1 |     | 2  | 0 | 0 | 0  | 0  | 1  | 0   | 0   | 0   | 0  | 0  | 1  | 5  | 0.00 | 3.000 |
| Howie Fox, R (7, 1)<br>ERA:       | 2.0 |     | 6  | 0 | 0 | 0  | 3  | 0  | 0   | 0   | 0   | 0  | 0  | 12 | 12 | 0.00 | 0.000 |

BOTTOM

Cincinnati Reds @ Pittsburgh Pirates  
 Forbes Field, Pittsburgh, PA  
 Sun Apr 23 1950, 3:33 AM EST  
 Att. 18,049 - Unknown

livebaseballscorecards.com

|     |    |
|-----|----|
| AB  | 29 |
| R   | 5  |
| H   | 5  |
| RBI | 4  |
| BB  | 5  |
| SO  | 8  |
| LOB | 12 |



| Batter  | 1   | 2                               | 3                            | 4                               | 5                            | 6                               | 7                            | 8                               | 9                            | AB R H RBI BB SO LOB            | TOP                          |   |                              |                                 |                              |                                 |                              |                                 |                                  |                                    |                                  |        |
|---|---|---------------------------------|------------------------------|---------------------------------|------------------------------|---------------------------------|------------------------------|---------------------------------|------------------------------|---------------------------------|------------------------------|---|------------------------------|---------------------------------|------------------------------|---------------------------------|------------------------------|---------------------------------|----------------------------------|------------------------------------|----------------------------------|--------|
| <b>Tommy Glaviano, R</b> (1, 5)<br>OBP: 0.556, SLG: 0.429         | 0-3<br>K  |                                 | 0-0<br>F8                    |                                 | 0-0<br>1B                    |                                 |                              | 0-0<br>SH3-4                    | 0-0<br>P4                    | 4 0 1 0 0 1 2                   |                              |   |                              |                                 |                              |                                 |                              |                                 |                                  |                                    |                                  |        |
| <b>Chuck Diering, R</b> (1, 8)<br>OBP: 0.462, SLG: 0.500          | 0-3<br>K  |                                 |                              | 0-0<br>P3                       | 0-0<br>1B                    |                                 |                              | 0-0<br>FC6-2                    |                              | 4 0 2 0 0 1 0                   |                              |   |                              |                                 |                              |                                 |                              |                                 |                                  |                                    |                                  |        |
| <b>Stan Musial, L</b> (1, 9)<br>OBP: 0.480, SLG: 0.818            | 0-0<br>F2   |                                 |                              | 0-0<br>2B                       |                              |                                 | 0-0<br>P3                    | 4-0<br>FC5 FC6-2<br>IBB         |                              | 3 0 1 0 1 0 0                   |                              |   |                              |                                 |                              |                                 |                              |                                 |                                  |                                    |                                  |        |
| <b>Enos Slaughter, L</b> (1, 7)<br>OBP: 0.375, SLG: 0.263         |   | 0-0<br>F5                       |                              | 0-0<br>2B                       |                              | 0-0<br>G5-4-3<br>1B             |                              | 0-0<br>FC6-2                    |                              | 4 0 2 0 0 0 3                   |                              |   |                              |                                 |                              |                                 |                              |                                 |                                  |                                    |                                  |        |
| <b>Red Schoendienst, S</b> (1, 4)<br>OBP: 0.192, SLG: 0.346       |   | 0-0<br>P3                       |                              | 0-0<br>P6                       |                              | 0-0<br>G5-4-3<br>1-2f           |                              | 0-0<br>FC5                      |                              | 4 0 0 0 0 0 6                   |                              |   |                              |                                 |                              |                                 |                              |                                 |                                  |                                    |                                  |        |
| <b>Steve Bilko, R</b> (1, 3)<br>OBP: 0.500, SLG: 0.444            |   | 0-0<br>E7                       |                              | 4-0                             |                              |                                 | 0-0<br>F2                    |                                 | 0-0<br>SH1-4<br>2B           | 3 0 2 0 1 0 0                   |                              |   |                              |                                 |                              |                                 |                              |                                 |                                  |                                    |                                  |        |
| <b>Harry Walker, L</b> (9, PR)                                    |   | 1B                              |                              | IBB                             |                              |                                 |                              |                                 |                              | 0 1 0 0 0 0 0                   |                              |   |                              |                                 |                              |                                 |                              |                                 |                                  |                                    |                                  |        |
| <b>Rocky Nelson, L</b> (9, 3)<br>OBP: 0.182, SLG: 0.300           |   |                                 |                              |                                 |                              |                                 |                              |                                 |                              | 0 0 0 0 0 0 0                   |                              |   |                              |                                 |                              |                                 |                              |                                 |                                  |                                    |                                  |        |
| <b>Del Rice, R</b> (1, 2)<br>OBP: 0.143, SLG: 0.143               |   | 0-0<br>F9                       |                              | 0-0<br>F7                       |                              |                                 | 0-0<br>5-3                   |                                 | 0-0<br>SH1-4                 | 3 0 0 0 0 0 4                   |                              |   |                              |                                 |                              |                                 |                              |                                 |                                  |                                    |                                  |        |
| <b>Eddie Miller, R</b> (1, 6)<br>OBP: 0.304, SLG: 0.238           |   |                                 | 0-0<br>F7                    |                                 | 0-0<br>F3                    |                                 | 0-0<br>P5                    |                                 | 0-0<br>F9                    | 4 0 0 0 0 0 2                   |                              |   |                              |                                 |                              |                                 |                              |                                 |                                  |                                    |                                  |        |
| <b>Max Lanier, R</b> (1, 1)<br>OBP: 0.500, SLG: 0.750             |   |                                 | 0-0<br>6-3                   |                                 | 0-0<br>F4                    |                                 |                              | 0-0<br>1B SH3-4<br>FC6-2        | 0-0<br>2B                    | 4 0 2 1 0 0 0                   |                              |   |                              |                                 |                              |                                 |                              |                                 |                                  |                                    |                                  |        |
| <b>Inning Stats</b>   | R: 0<br>E: 0<br>K: 2<br>S: 7  | H: 0<br>LOB: 0<br>BB: 0<br>P: 7 | R: 0<br>E: 1<br>K: 0<br>S: 4 | H: 1<br>LOB: 1<br>BB: 0<br>P: 4 | R: 0<br>E: 0<br>K: 0<br>S: 3 | H: 0<br>LOB: 0<br>BB: 0<br>P: 3 | R: 0<br>E: 0<br>K: 0<br>S: 5 | H: 2<br>LOB: 3<br>BB: 1<br>P: 9 | R: 0<br>E: 0<br>K: 0<br>S: 4 | H: 2<br>LOB: 2<br>BB: 0<br>P: 4 | R: 0<br>E: 0<br>K: 0<br>S: 3 | H: 1<br>LOB: 0<br>BB: 0<br>P: 3   | R: 0<br>E: 0<br>K: 0<br>S: 3 | H: 0<br>LOB: 0<br>BB: 0<br>P: 3 | R: 0<br>E: 0<br>K: 0<br>S: 5 | H: 2<br>LOB: 3<br>BB: 1<br>P: 9 | R: 1<br>E: 0<br>K: 0<br>S: 5 | H: 2<br>LOB: 2<br>BB: 0<br>P: 5 | 1B: 7<br>2B: 3<br>3B: 0<br>HR: 0 | SF: 0<br>SAC: 2<br>DP: 1<br>HBP: 0 | WP: 0<br>PB: 0<br>SB: 0<br>CS: 0 | PA: 37 |
| <b>PITCHER</b><br><b>Ken Raffensberger, L</b> (1, 1)<br>ERA: 3.86 | IP: 9.0<br>WLS: L<br>BF: 37<br>H: 10<br>R: 1<br>ER: 1<br>SO: 2<br>BB: 0<br>IBB: 2<br>HBP: 0<br>BLK: 0<br>WP: 0<br>HR: 0<br>S: 39<br>P: 47<br>ERA: 1.00<br>WHIP: 1.111 |                                 |                              |                                 |                              |                                 |                              |                                 |                              |                                 |                              | <b>PITCHER</b><br>IP: 0<br>WLS: 0<br>BF: 0<br>H: 0<br>R: 0<br>ER: 0<br>SO: 0<br>BB: 0<br>IBB: 0<br>HBP: 0<br>BLK: 0<br>WP: 0<br>HR: 0<br>S: 0<br>P: 0<br>ERA: 0.00<br>WHIP: 0.000 |                              |                                 |                              |                                 |                              |                                 |                                  |                                    |                                  |        |

**St. Louis Cardinals @ Cincinnati Reds**  
Crosley Field, Cincinnati, OH  
Mon Apr 24 1950, 3:33 AM EST  
Att: 10,540 - Unknown

[livebaseballscorecards.com](http://livebaseballscorecards.com)

|            |    |
|------------|----|
| <b>AB</b>  | 33 |
| <b>R</b>   | 1  |
| <b>H</b>   | 10 |
| <b>RBI</b> | 1  |
| <b>BB</b>  | 2  |
| <b>SO</b>  | 2  |
| <b>LOB</b> | 17 |



| Batter  | 1                            | 2   | 3   | 4                               | 5                            | 6                               | 7                            | 8                               | 9                            | AB                               | R                            | H                               | RBI                          | BB                              | SO                           | LOB                             |                              |                                 |                                  |                                    |                                  |        |
|---|------------------------------|---|---|---------------------------------|------------------------------|---------------------------------|------------------------------|---------------------------------|------------------------------|----------------------------------|------------------------------|---------------------------------|------------------------------|---------------------------------|------------------------------|---------------------------------|------------------------------|---------------------------------|----------------------------------|------------------------------------|----------------------------------|--------|
| <b>Bobby Adams, R</b><br>OBP: 0.556, SLG: 0.571<br>(1, 4)     | 0-0<br>HBP<br>1B             | 0-0<br>P4   |   |                                 | 4-0<br>BB                    |                                 |                              | 0-0<br>6-3                      |                              | 3                                | 0                            | 1                               | 0                            | 1                               | 0                            | 2                               |                              |                                 |                                  |                                    |                                  |        |
| <b>Johnny Wyrostek, L</b><br>OBP: 0.381, SLG: 0.500<br>(1, 9) | 1-0<br>HBP                   |   | 0-3<br>K  |                                 | 0-0<br>P6                    |                                 |                              | 0-0<br>F7                       |                              | 3                                | 0                            | 0                               | 0                            | 0                               | 1                            | 2                               |                              |                                 |                                  |                                    |                                  |        |
| <b>Bob Usher, R</b><br>OBP: 0.357, SLG: 0.857<br>(1, 8)       | 0-0<br>P4                    |   | 0-0<br>P4   |                                 | 0-3<br>K                     |                                 |                              | 0-0<br>FC6-4<br>1B              |                              | 4                                | 0                            | 1                               | 0                            | 0                               | 1                            | 4                               |                              |                                 |                                  |                                    |                                  |        |
| <b>Joe Adcock, R</b><br>OBP: 0.250, SLG: 0.375<br>(1, 7)      | 0-3<br>K                     |   | 0-0<br>F8   |                                 | 0-3<br>K                     |                                 |                              | 0-0<br>FC6-4<br>1-2f            |                              | 4                                | 0                            | 0                               | 0                            | 0                               | 2                            | 3                               |                              |                                 |                                  |                                    |                                  |        |
| <b>Walker Cooper, R</b><br>OBP: 0.063, SLG: 0.063<br>(1, 2)   | 0-0<br>F8                    |   |   | 0-0<br>F7                       |                              |                                 | 0-0<br>F2                    |                                 | 0-0<br>F9                    | 4                                | 0                            | 0                               | 0                            | 0                               | 0                            | 2                               |                              |                                 |                                  |                                    |                                  |        |
| <b>Ted Kluszewski, L</b><br>OBP: 0.353, SLG: 0.313<br>(1, 3)  |                              | 0-0<br>FC1-6<br>BB<br>1B                                      |   | 0-0<br>6-3                      |                              | 0-3<br>K                        |                              | 0-3<br>K                        | 0-3<br>K                     | 4                                | 0                            | 1                               | 0                            | 0                               | 2                            | 0                               |                              |                                 |                                  |                                    |                                  |        |
| <b>Grady Hatton, L</b><br>OBP: 0.167, SLG: 0.063<br>(1, 5)    |                              | 4-0<br>FC1-6<br>BB  |   | 0-3<br>K                        |                              |                                 | 0-0<br>F7                    |                                 | 0-0<br>F8                    | 3                                | 0                            | 0                               | 0                            | 1                               | 1                            | 0                               |                              |                                 |                                  |                                    |                                  |        |
| <b>Virgil Stallcup, R</b><br>OBP: 0.333, SLG: 0.353<br>(1, 6) |                              | 0-0<br>F2   |   |                                 | 0-0<br>E<br>1B               |                                 | 0-0<br>P5                    |                                 |                              | 3                                | 0                            | 1                               | 0                            | 0                               | 0                            | 2                               |                              |                                 |                                  |                                    |                                  |        |
| <b>Ken Raffensberger, R</b><br>(1, 1)                         |                              | 0-0<br>FC1-6<br>1-2f<br>2-3                                   |   |                                 | 0-0<br>B1<br>1-2             |                                 | 0-0<br>6-3                   |                                 |                              | 3                                | 0                            | 0                               | 0                            | 0                               | 0                            | 3                               |                              |                                 |                                  |                                    |                                  |        |
| <b>Inning Stats</b>   | R: 0<br>E: 0<br>K: 1<br>S: 6 | H: 1<br>LOB: 2<br>BB: 0<br>P: 7                               | R: 0<br>E: 0<br>K: 0<br>S: 4  | H: 1<br>LOB: 2<br>BB: 1<br>P: 8 | R: 0<br>E: 0<br>K: 1<br>S: 5 | H: 0<br>LOB: 0<br>BB: 0<br>P: 5 | R: 0<br>E: 0<br>K: 1<br>S: 5 | H: 0<br>LOB: 0<br>BB: 0<br>P: 5 | R: 0<br>E: 1<br>K: 1<br>S: 6 | H: 1<br>LOB: 2<br>BB: 1<br>P: 10 | R: 0<br>E: 0<br>K: 2<br>S: 7 | H: 0<br>LOB: 0<br>BB: 0<br>P: 7 | R: 0<br>E: 0<br>K: 0<br>S: 3 | H: 0<br>LOB: 0<br>BB: 0<br>P: 3 | R: 0<br>E: 0<br>K: 0<br>S: 4 | H: 1<br>LOB: 1<br>BB: 0<br>P: 4 | R: 0<br>E: 0<br>K: 1<br>S: 5 | H: 0<br>LOB: 0<br>BB: 0<br>P: 5 | 1B: 4<br>2B: 0<br>3B: 0<br>HR: 0 | SF: 0<br>SAC: 0<br>DP: 0<br>HBP: 1 | WP: 0<br>PB: 0<br>SB: 0<br>CS: 0 | PA: 34 |
| <b>PITCHER</b><br><b>Max Lanier, L</b><br>ERA:                | (1, 1)                       | IP: 9.0<br>WLS: W<br>BF: 34<br>H: 4<br>R: 0<br>ER: 0<br>SO: 7 | BB: 2<br>IBB: 0<br>HBP: 1<br>BLK: 0<br>WP: 0<br>HR: 0<br>S: 45<br>P: 54 | ERA: 0.00<br>WHIP: 0.667        |                              |                                 |                              |                                 |                              |                                  |                              |                                 |                              |                                 |                              |                                 |                              |                                 |                                  |                                    |                                  |        |

**BOTTOM**

**St. Louis Cardinals @ Cincinnati Reds**  
Crosley Field, Cincinnati, OH  
Mon Apr 24 1950, 3:33 AM EST  
Att. 10,540 - Unknown

[livebaseballscorecards.com](http://livebaseballscorecards.com)

|            |           |
|------------|-----------|
| <b>AB</b>  | <b>31</b> |
| <b>R</b>   | <b>0</b>  |
| <b>H</b>   | <b>4</b>  |
| <b>RBI</b> | <b>0</b>  |
| <b>BB</b>  | <b>2</b>  |
| <b>SO</b>  | <b>7</b>  |
| <b>LOB</b> | <b>18</b> |



| Batter   | 1  | 2   | 3   | 4   | 5   | 6   | 7  | 8   | 9   | AB R H RBI BB SO LOB   | TOP  |                |   |
|--|--|---|---|---|---|---|--|---|---|--|--|----------------|---|
| Tommy Glaviano, R (1, 5)<br>OBP: 0.500, SLG: 0.300   | 4-0<br>1B S<br>L8<br>BB  | 0-0<br>F8   |   |   | 4-0<br>3B<br>BB   |   | 0-0<br>4-3   |   | 0-3<br>K  | 3 2 0 0 2 1 2  |  |                |   |
| Chuck Diering, R (1, 8)<br>OBP: 0.389, SLG: 0.375  | 4-0<br>L8-4<br>1B<br>1-2<br>BB                                   |   | 0-0<br>6-3  |   | 0-0<br>F8   |   | 0-3<br>K   |   | 0-3<br>K  | 4 0 0 0 1 2 1  |  |                |   |
| Stan Musial, L (1, 9)<br>OBP: 0.517, SLG: 0.880  | 0-0<br>1-2<br>2-3<br>1B  |   | 0-0<br>L3   |   | 0-0<br>1B<br>3B   |   | 4-0<br>BB  |   |   | 3 1 2 1 1 0 0  |  |                |   |
| Enos Slaughter, L (1, 7)<br>OBP: 0.393, SLG: 0.304   | 0-0<br>L8  |   | 0-0   |   | 0-0<br>FC6-4<br>1B  |   | 0-3<br>K   |   |   | 4 0 2 2 0 1 3  |  |                |   |
| Steve Bilko, R (1, 3)<br>OBP: 0.438, SLG: 0.385<br>Rocky Nelson, L (8, PR)<br>OBP: 0.182, SLG: 0.300 | 0-0<br>L8-4<br>2-3   |   | 0-3<br>K  |   | 0-0<br>FC6-4<br>1-2f  |   |  | 0-0<br>SH1-4<br>1B  |   | 4 0 1 0 0 1 4<br>0 0 0 0 0 0 0   |  |                |   |
| Red Schoendienst, S (1, 4)<br>OBP: 0.172, SLG: 0.310   |  | 0-0<br>P5   |   | 0-0<br>P3   |   | 0-0<br>6-3  |  | 0-0<br>SH1-4<br>1-2   |   | 3 0 0 0 0 0 0  |  |                |   |
| Del Rice, R (1, 2)<br>OBP: 0.182, SLG: 0.182   |  | 0-0<br>FC1-5<br>1B<br>1B  |   | 0-0<br>F8   |   | 0-3<br>K  |  | 0-0<br>P6   |   | 4 0 1 0 0 1 2  |  |                |   |
| Eddie Miller, R (1, 6)<br>OBP: 0.333, SLG: 0.320   |  | 0-0<br>FC1-5<br>1-2<br>1B                                       |   | 0-0<br>F9   |   | 0-0<br>2B   |  | 0-0<br>5-3  |   | 4 0 2 0 0 0 2  |  |                |   |
| Howie Pollet, L (1, 1)   |  | 0-0<br>FC1-5<br>1-2<br>2-3f                                     |   | 0-0<br>F8   |   | 0-0<br>P5   |  | 0-0<br>4-3  |   | 4 0 0 0 0 0 3  |  |                |   |
| <b>Inning Stats</b>  | R: 1<br>E: 0<br>K: 0<br>S: 3<br>H: 1<br>LOB: 1<br>BB: 2<br>P: 11 | R: 0<br>E: 0<br>K: 0<br>S: 5<br>H: 2<br>LOB: 2<br>BB: 0<br>P: 5 | R: 0<br>E: 0<br>K: 1<br>S: 6<br>H: 1<br>LOB: 1<br>BB: 0<br>P: 6 | R: 0<br>E: 0<br>K: 0<br>S: 3<br>H: 0<br>LOB: 0<br>BB: 0<br>P: 3 | R: 2<br>E: 0<br>K: 0<br>S: 5<br>H: 2<br>LOB: 1<br>BB: 1<br>P: 9 | R: 0<br>E: 0<br>K: 1<br>S: 6<br>H: 1<br>LOB: 1<br>BB: 0<br>P: 6 | R: 0<br>E: 0<br>K: 2<br>S: 7<br>H: 0<br>LOB: 1<br>BB: 1<br>P: 11 | R: 0<br>E: 0<br>K: 0<br>S: 4<br>H: 1<br>LOB: 2<br>BB: 0<br>P: 4 | R: 0<br>E: 0<br>K: 2<br>S: 7<br>H: 0<br>LOB: 0<br>BB: 0<br>P: 7 | 1B: 6<br>2B: 2<br>3B: 1<br>HR: 0<br>SF: 0<br>SAC: 1<br>DP: 1<br>HBP: 0 | WP: 0<br>PB: 0<br>SB: 1<br>CS: 0<br>PA: 38 |                |   |
| <b>PITCHER</b>   | IP WLS BF H R ER SO BB IBB HBP BLK WP HR S P ERA WHIP            |   |   |   |   |   |  |   |   |  |  | <b>PITCHER</b> | IP WLS BF H R ER SO BB IBB HBP BLK WP HR S P ERA WHIP |
| Kent Peterson, L (1, 1)<br>ERA: 9.45   | 4.2 L 22 6 3 3 1 3 0 0 0 0 0 0 21 33 5.79 1.929                  |   |   |   |   |   |  |   |   |  |  |                |   |
| Frank Smith, R (5, 1)<br>ERA: 3.65   | 3.1 13 2 0 0 3 1 0 0 0 0 0 0 18 22 0.00 0.900                    |   |   |   |   |   |  |   |   |  |  |                |   |
| Ewell Blackwell, R (9, 1)<br>ERA:  | 1.0 3 0 0 0 2 0 0 0 0 0 0 0 7 7 0.00 0.000                       |   |   |   |   |   |  |   |   |  |  |                |   |

St. Louis Cardinals @ Cincinnati Reds  
 Crosley Field, Cincinnati, OH  
 Wed Apr 26 1950, 3:33 AM EST  
 Att. 2,797 - Unknown

livebaseballscorecards.com

AB 33  
 R 3  
 H 8  
 RBI 3  
 BB 4  
 SO 6  
 LOB 17



| Batter   | 1         | 2           | 3                    | 4                | 5          | 6               | 7         | 8          | 9 | AB | R | H | RBI | BB | SO | LOB |
|--|-----------|-------------|----------------------|------------------|------------|-----------------|-----------|------------|---|----|---|---|-----|----|----|-----|
| <b>Bobby Adams, R</b> (1, 4)<br>OBP: 0.462, SLG: 0.545     | 0-3<br>K  |             | 0-0<br>E9<br>3B      |                  |            | 0-0<br>L8       |           | 0-0<br>2B  |   | 4  | 1 | 1 | 0   | 0  | 1  | 1   |
| <b>Johnny Wyrostek, L</b> (1, 9)<br>OBP: 0.400, SLG: 0.565 | 0-0<br>F7 |             | 0-0<br>3B            |                  |            | 4-0<br>WP<br>BB |           | 0-0<br>F8  |   | 3  | 0 | 1 | 2   | 1  | 0  | 1   |
| <b>Bob Usher, R</b> (1, 8)<br>OBP: 0.278, SLG: 0.667       | 0-3<br>K  |             | 0-0<br>F7            |                  |            | 0-3<br>K        |           | 0-0<br>F8  |   | 4  | 0 | 0 | 0   | 0  | 2  | 3   |
| <b>Danny Litwhiler, R</b> (1, 7)<br>OBP: 0.176, SLG: 0.313 |           | 0-0<br>G6-3 |                      | 0-0<br>P3        |            | 0-0<br>5-3      |           | 0-0<br>F8  |   | 4  | 0 | 0 | 0   | 0  | 0  | 1   |
| <b>Joe Adcock, R</b> (1, 3)<br>OBP: 0.250, SLG: 0.333      |           | 0-0<br>L9   |                      | 0-0<br>PO<br>1B  |            | 0-0<br>5-3      |           | 0-0<br>F9  |   | 4  | 0 | 1 | 0   | 0  | 0  | 0   |
| <b>Walker Cooper, R</b> (1, 2)<br>OBP: 0.050, SLG: 0.050   |           | 0-0<br>5-3  |                      | 0-0<br>F9        |            | 0-3<br>K        |           | 0-0<br>6-3 |   | 4  | 0 | 0 | 0   | 0  | 1  | 1   |
| <b>Grady Hatton, L</b> (1, 5)<br>OBP: 0.190, SLG: 0.105    |           |             | 0-0<br>3-1           | 0-0<br>PO<br>1-2 | 0-0<br>3-1 |                 | 0-0<br>1B |            |   | 3  | 0 | 1 | 0   | 0  | 0  | 0   |
| <b>Virgil Stallcup, R</b> (1, 6)<br>OBP: 0.286, SLG: 0.300 |           |             | 0-0<br>6-3           |                  | 0-0<br>F7  |                 | 0-0<br>F7 |            |   | 3  | 0 | 0 | 0   | 0  | 0  | 1   |
| <b>Kent Peterson, R</b> (1, 1)<br>OBP: 0.500, SLG: 0.500   |           |             | 0-0<br>E<br>3B<br>1B |                  | 0-3<br>K   |                 |           | 0-0<br>1-3 |   | 1  | 1 | 1 | 0   | 0  | 0  | 0   |
| <b>Frank Smith, R</b> (5, 1)<br>OBP: 0.333, SLG: 0.333     |           |             |                      |                  |            |                 |           |            |   | 1  | 0 | 0 | 0   | 0  | 1  | 0   |
| <b>Peanuts Lowrey, R</b> (8, PH)<br>OBP: 0.250, SLG: 0.250 |           |             |                      |                  |            |                 |           |            |   | 1  | 0 | 0 | 0   | 0  | 0  | 0   |
| <b>Ewell Blackwell, R</b> (9, 1)                           |           |             |                      |                  |            |                 |           |            |   | 0  | 0 | 0 | 0   | 0  | 0  | 0   |

| Inning Stats   | R: 0 | H: 0 | E: 0 | LOB: 0 | K: 2 | BB: 0 | S: 7 | P: 7 | R: 0 | H: 0 | E: 0 | LOB: 0 | K: 0 | BB: 0 | S: 3 | P: 3 | R: 2 | H: 2 | E: 1 | LOB: 1 | K: 0 | BB: 0 | S: 6 | P: 6 | R: 0 | H: 1 | E: 0 | LOB: 0 | K: 0 | BB: 0 | S: 3 | P: 3 | R: 0 | H: 0 | E: 0 | LOB: 0 | K: 1 | BB: 1 | S: 5 | P: 5 | R: 0 | H: 0 | E: 0 | LOB: 1 | K: 1 | BB: 1 | S: 5 | P: 9 | R: 0 | H: 1 | E: 0 | LOB: 1 | K: 1 | BB: 0 | S: 6 | P: 6 | R: 0 | H: 1 | E: 0 | LOB: 1 | K: 0 | BB: 0 | S: 4 | P: 4 | R: 0 | H: 0 | E: 0 | LOB: 0 | K: 0 | BB: 0 | S: 3 | P: 3 | 1B: 3 | SF: 0 | 2B: 1 | SAC: 0 | 3B: 1 | DP: 0 | HR: 0 | HBP: 0 | WP: 1 | PA: 34 | PB: 0 | SB: 0 | CS: 0 |
|--|------|------|------|--------|------|-------|------|------|------|------|------|--------|------|-------|------|------|------|------|------|--------|------|-------|------|------|------|------|------|--------|------|-------|------|------|------|------|------|--------|------|-------|------|------|------|------|------|--------|------|-------|------|------|------|------|------|--------|------|-------|------|------|------|------|------|--------|------|-------|------|------|------|------|------|--------|------|-------|------|------|-------|-------|-------|--------|-------|-------|-------|--------|-------|--------|-------|-------|-------|
| <b>PITCHER</b><br><b>Howie Pollet, L</b> (1, 1)<br>ERA: 1.88 | IP   | WLS  | BF   | H      | R    | ER    | SO   | BB   | IBB  | HBP  | BLK  | WP     | HR   | S     | P    | ERA  | WHIP | IP   | WLS  | BF     | H    | R     | ER   | SO   | BB   | IBB  | HBP  | BLK    | WP   | HR    | S    | P    | ERA  | WHIP | IP   | WLS    | BF   | H     | R    | ER   | SO   | BB   | IBB  | HBP    | BLK  | WP    | HR   | S    | P    | ERA  | WHIP |        |      |       |      |      |      |      |      |        |      |       |      |      |      |      |      |        |      |       |      |      |       |       |       |        |       |       |       |        |       |        |       |       |       |

BOTTOM

**St. Louis Cardinals @ Cincinnati Reds**  
Crosley Field, Cincinnati, OH  
Wed Apr 26 1950, 3:33 AM EST  
Att. 2,797 - Unknown

livebaseballscorecards.com

|     |    |
|-----|----|
| AB  | 32 |
| R   | 2  |
| H   | 5  |
| RBI | 2  |
| BB  | 1  |
| SO  | 5  |
| LOB | 8  |



| Batter  | 1   | 2                                | 3                            | 4                               | 5                            | 6                               | 7                            | 8                               | 9                            | AB R H RBI BB SO LOB             | TOP                          |                                 |                              |                                 |                              |                                 |                                  |                                    |                                  |        |
|---|---|----------------------------------|------------------------------|---------------------------------|------------------------------|---------------------------------|------------------------------|---------------------------------|------------------------------|----------------------------------|------------------------------|---------------------------------|------------------------------|---------------------------------|------------------------------|---------------------------------|----------------------------------|------------------------------------|----------------------------------|--------|
| Bobby Adams, R<br>OBP: 0.389, SLG: 0.438<br>(1, 4) X  | 0-0 F8  |                                  | 0-0 F9                       |                                 | 0-0 SH5-4<br>1B              | 0-0 6-3                         |                              |                                 | 0-0 G3-6                     | 5 1 1 0 0 0 1                    |                              |                                 |                              |                                 |                              |                                 |                                  |                                    |                                  |        |
| Peanuts Lowrey, R<br>OBP: 0.273, SLG: 0.273<br>(1, 7) X   | 0-0 E6  |                                  | 0-0 1B                       |                                 | 0-0 SH5-4                    |                                 | 0-0 F7                       |                                 |                              | 3 0 1 0 0 0 0                    |                              |                                 |                              |                                 |                              |                                 |                                  |                                    |                                  |        |
| Johnny Wyrostek, L<br>OBP: 0.379, SLG: 0.500<br>(1, 8) B<br>(6, 9) B  | 4-0 1B<br>1-2 BB                                      |                                  | 0-0 F9                       |                                 | 0-0 F8                       |                                 | 0-0 4-3                      |                                 |                              | 3 0 0 0 1 0 3                    |                              |                                 |                              |                                 |                              |                                 |                                  |                                    |                                  |        |
| Joe Adcock, R<br>OBP: 0.313, SLG: 0.375<br>(1, 3) X   | 0-0 1B  |                                  |                              | 0-0 P3                          | 0-0 BB<br>1B                 |                                 | 0-0 F7                       |                                 |                              | 4 1 2 2 0 0 0                    |                              |                                 |                              |                                 |                              |                                 |                                  |                                    |                                  |        |
| Danny Litwhiler, R<br>OBP: 0.250, SLG: 0.333<br>Lloyd Merriman, L<br>OBP: 0.200, SLG: 0.200<br>(1, 9) S<br>(6, 8) S | 0-3 K   |                                  |                              | 0-0 1B                          | 4-0 BB<br>1B                 |                                 |                              | 0-0 4-3                         |                              | 2 0 1 0 1 1 2<br>1 0 0 0 0 0 0   |                              |                                 |                              |                                 |                              |                                 |                                  |                                    |                                  |        |
| Grady Hatton, L<br>OBP: 0.240, SLG: 0.174<br>(1, 5) X   |   | 0-0 P6                           |                              | 0-0 1B                          | 0-0 1B                       |                                 |                              | 0-0 F9                          |                              | 4 0 2 1 0 0 0                    |                              |                                 |                              |                                 |                              |                                 |                                  |                                    |                                  |        |
| Virgil Stallcup, R<br>OBP: 0.280, SLG: 0.292<br>(1, 6) X  |   | 0-0 K2-3<br>1B                   |                              | 0-0 F8                          | 0-3 K                        |                                 |                              | 0-0 6-3                         |                              | 4 0 1 0 0 1 4                    |                              |                                 |                              |                                 |                              |                                 |                                  |                                    |                                  |        |
| Dixie Howell, R<br>(1, 2) X   | 0-3 K2-3<br>1-2                                       |                                  | 0-0 F8                       |                                 |                              | 0-0 5-3                         |                              | 0-3 K                           |                              | 4 0 0 0 0 2 3                    |                              |                                 |                              |                                 |                              |                                 |                                  |                                    |                                  |        |
| Herm Wehmeier, R<br>OBP: 0.333, SLG: 0.200<br>(1, 1) X  |   |                                  | 0-0 F3                       |                                 | 0-0 SH5-4<br>1B              | 0-0 F8                          |                              | 4-0 BB                          |                              | 3 1 1 0 1 0 0                    |                              |                                 |                              |                                 |                              |                                 |                                  |                                    |                                  |        |
| <b>Inning Stats</b>   | R: 0<br>E: 1<br>K: 1<br>S: 6                          | H: 1<br>LOB: 2<br>BB: 1<br>P: 10 | R: 0<br>E: 0<br>K: 1<br>S: 5 | H: 1<br>LOB: 0<br>BB: 0<br>P: 5 | R: 0<br>E: 0<br>K: 0<br>S: 4 | H: 1<br>LOB: 1<br>BB: 0<br>P: 4 | R: 0<br>E: 0<br>K: 0<br>S: 5 | H: 2<br>LOB: 2<br>BB: 0<br>P: 5 | R: 3<br>E: 0<br>K: 1<br>S: 9 | H: 4<br>LOB: 2<br>BB: 1<br>P: 13 | R: 0<br>E: 0<br>K: 0<br>S: 3 | H: 0<br>LOB: 0<br>BB: 0<br>P: 3 | R: 0<br>E: 0<br>K: 0<br>S: 3 | H: 0<br>LOB: 0<br>BB: 0<br>P: 3 | R: 0<br>E: 0<br>K: 1<br>S: 4 | H: 0<br>LOB: 0<br>BB: 1<br>P: 8 | 1B: 9<br>2B: 0<br>3B: 0<br>HR: 0 | SF: 0<br>SAC: 1<br>DP: 1<br>HBP: 0 | WP: 0<br>PB: 0<br>SB: 0<br>CS: 1 | PA: 37 |
| <b>PITCHER</b>  | IP WLS BF H R ER SO BB IBB HBP BLK WP HR S P ERA WHIP |                                  |                              |                                 |                              |                                 |                              |                                 |                              |                                  |                              |                                 |                              |                                 |                              |                                 |                                  |                                    |                                  |        |
| Paul Minner, L<br>ERA: 5.63<br>(1, 1)   | 4.2 L 24 9 3 3 2 2 0 0 0 0 0 0 26 34 5.79 2.357       |                                  |                              |                                 |                              |                                 |                              |                                 |                              |                                  |                              |                                 |                              |                                 |                              |                                 |                                  |                                    |                                  |        |
| Johnny Vander Meer, L<br>ERA: 4.5<br>(5, 1)   | 0.1 1 0 0 0 1 0 0 0 0 0 0 0 3 3 0.00 0.000            |                                  |                              |                                 |                              |                                 |                              |                                 |                              |                                  |                              |                                 |                              |                                 |                              |                                 |                                  |                                    |                                  |        |
| Frank Hiller, R<br>ERA:<br>(6, 1)   | 3.0 9 0 0 0 0 0 0 0 0 0 0 0 9 9 0.00 0.000            |                                  |                              |                                 |                              |                                 |                              |                                 |                              |                                  |                              |                                 |                              |                                 |                              |                                 |                                  |                                    |                                  |        |
| Monk Dubiel, R<br>ERA:<br>(9, 1)  | 1.0 3 0 0 0 1 1 0 0 0 0 0 0 4 8 0.00 1.000            |                                  |                              |                                 |                              |                                 |                              |                                 |                              |                                  |                              |                                 |                              |                                 |                              |                                 |                                  |                                    |                                  |        |

Cincinnati Reds @ Chicago Cubs  
Wrigley Field, Chicago, IL  
Fri Apr 28 1950, 3:33 AM CST  
Att. 3,640 - Unknown

[livebaseballscorecards.com](http://livebaseballscorecards.com)

|     |    |
|-----|----|
| AB  | 33 |
| R   | 3  |
| H   | 9  |
| RBI | 3  |
| BB  | 3  |
| SO  | 4  |
| LOB | 13 |



| Batter   | 1         | 2               | 3        | 4               | 5          | 6                        | 7          | 8                        | 9 | AB R H RBI BB SO LOB |
|--|-----------|-----------------|----------|-----------------|------------|--------------------------|------------|--------------------------|---|----------------------|
| Wayne Terwilliger, R (1, 4)<br>OBP: 0.353, SLG: 0.467  | 0-3<br>K  |                 |          | 0-0<br>5-3      |            | 4-0<br>1B<br>E<br>BB     |            | 0-0<br>P6                |   | 3 1 0 0 1 1 0        |
| Carmen Mauro, L (1, 9)<br>OBP: 0.429, SLG: 0.333   | 0-0<br>B3 |                 |          | 4-0<br>WP<br>BB |            | 0-0<br>G4-6-3<br>E<br>1B |            | 0-3<br>K                 |   | 3 0 1 0 1 1 0        |
| Preston Ward, L (1, 3)<br>OBP: 0.438, SLG: 0.786   | 0-0<br>F9 |                 |          | 0-0<br>F7       |            | 0-0<br>E1<br>G4-6-3      |            | 4-0<br>FC6-4<br>BB       |   | 3 0 0 0 1 0 2        |
| Hank Sauer, R (1, 7)<br>OBP: 0.385, SLG: 0.417   |           | 0-0<br>6-3      |          | 0-0<br>P6       |            | 0-0<br>G4-6-3            |            | 0-0<br>FC6-4<br>WP<br>BB |   | 1 0 0 0 0 0 0        |
| Hal Jeffcoat, R (3, 7)<br>OBP: 0.250, SLG: 0.583   |           |                 |          |                 |            | 1-2<br>2-3               |            | 1-2<br>BB                |   | 3 0 0 0 0 0 4        |
| Andy Pafko, R (1, 8)<br>OBP: 0.500, SLG: 0.917   |           | 4-0<br>CS<br>BB |          |                 | 0-0<br>L9  | 0-0<br>5-3               |            | 4-0<br>WP<br>BB          |   | 2 0 0 0 2 0 1        |
| Bill Serena, R (1, 5)<br>Phil Cavarretta, L (9, PH)  |           | 0-0<br>P4       |          |                 | 0-0<br>5-3 |                          | 0-0<br>P6  | 0-0<br>F9                |   | 3 0 0 0 0 0 1        |
| Roy Smalley, R (1, 6)<br>OBP: 0.375, SLG: 0.733  |           | 0-0<br>CS       | 0-3<br>K |                 | 0-0<br>2B  |                          | 0-0<br>6-3 | 0-3<br>K                 |   | 1 0 0 0 0 0 0        |
| Mickey Owen, R (1, 2)  |           |                 |          | 0-0<br>6-3      |            | 4-0<br>BB                | 0-0<br>L7  | 1-2<br>2-3               |   | 4 0 1 0 0 2 2        |
| Paul Minner, L (1, 1)<br>Johnny Vander Meer, S (5, 1)<br>Carl Sawatski, L (5, PH)<br>Frank Hiller, R (6, 1)<br>Rube Walker, L (8, PH)<br>Monk Dubiel, R (9, 1) |           |                 |          | 0-0<br>P6       |            | 0-0<br>F8                |            | 0-0<br>4-3               |   | 2 0 0 0 1 0 0        |

| Inning Stats                                    | R: 0 | H: 0 | E: 0 | K: 1 | S: 5 | R: 0 | H: 0 | E: 0 | K: 0 | S: 2 | R: 0 | H: 0 | E: 0 | K: 1 | S: 5 | R: 0 | H: 1 | E: 0 | K: 0 | S: 4 | R: 1 | H: 1 | E: 1 | K: 0 | S: 4 | R: 0 | H: 0 | E: 0 | K: 0 | S: 3 | R: 0 | H: 0 | E: 0 | K: 1 | S: 5 | R: 0 | H: 0 | E: 0 | K: 1 | S: 5 | 1B: 1 | SF: 0 | 2B: 1 | SAC: 0 | 3B: 0 | DP: 1 | HR: 0 | HBP: 0 | WP: 2 | PA: 35 |   |   |     |      |
|---|------|------|------|------|------|------|------|------|------|------|------|------|------|------|------|------|------|------|------|------|------|------|------|------|------|------|------|------|------|------|------|------|------|------|------|------|------|------|------|------|-------|-------|-------|--------|-------|-------|-------|--------|-------|--------|---|---|-----|------|
| PITCHER<br>Herm Wehmeier, R (1, 1)<br>ERA: 4.61 | IP   | WLS  | BF   | H    | R    | ER   | SO   | BB   | IBB  | HBP  | BLK  | WP   | HR   | S    | P    | ERA  | WHIP |      |      |      |      |      |      |      |      |      |      |      |      |      |      |      |      |      |      |      |      | IP   | WLS  | BF   | H     | R     | ER    | SO     | BB    | IBB   | HBP   | BLK    | WP    | HR     | S | P | ERA | WHIP |

**BOTTOM**

**Cincinnati Reds @ Chicago Cubs**  
 Wrigley Field, Chicago, IL  
 Fri Apr 28 1950, 3:33 AM CST  
 Att. 3,640 - Unknown

|     |    |
|-----|----|
| AB  | 28 |
| R   | 1  |
| H   | 2  |
| RBI | 0  |
| BB  | 6  |
| SO  | 4  |
| LOB | 14 |



**Pittsburgh Pirates @ Cincinnati Reds**  
 Crosley Field, Cincinnati, OH

Sat Apr 29 1950, 3:33 AM EST  
 Att. 4,895 - Unknown

[livebaseballscorecards.com](http://livebaseballscorecards.com)

|            |           |
|------------|-----------|
| <b>AB</b>  | <b>33</b> |
| <b>R</b>   | <b>6</b>  |
| <b>H</b>   | <b>8</b>  |
| <b>RBI</b> | <b>6</b>  |
| <b>BB</b>  | <b>5</b>  |
| <b>SO</b>  | <b>5</b>  |
| <b>LOB</b> | <b>17</b> |



| AB | R | H | RBI | BB | SO | LOB |
|----|---|---|-----|----|----|-----|
| 4  | 1 | 0 | 1   | 1  | 1  | 3   |
| 2  | 0 | 1 | 0   | 0  | 1  | 3   |
| 3  | 0 | 1 | 1   | 0  | 0  | 0   |
| 5  | 1 | 1 | 1   | 0  | 1  | 3   |
| 3  | 1 | 0 | 0   | 1  | 1  | 2   |
| 3  | 1 | 1 | 3   | 1  | 0  | 1   |
| 2  | 0 | 0 | 0   | 1  | 0  | 1   |
| 1  | 0 | 0 | 0   | 0  | 1  | 0   |
| 3  | 0 | 2 | 0   | 0  | 0  | 0   |
| 2  | 0 | 0 | 0   | 0  | 0  | 2   |
| 2  | 1 | 1 | 0   | 0  | 0  | 1   |
| 0  | 0 | 0 | 0   | 0  | 0  | 0   |
| 1  | 0 | 0 | 0   | 1  | 0  | 0   |
| 1  | 1 | 1 | 0   | 0  | 0  | 0   |
| 1  | 0 | 0 | 0   | 0  | 0  | 1   |
| 0  | 0 | 0 | 0   | 0  | 0  | 0   |

| Batter  | 1   | 2  | 3   | 4   | 5   | 6   | 7  | 8   | 9   |   |   |   |   |    |    |      |       |  |  |  |  |  |  |  |  |  |  |  |  |  |  |  |  |  |  |
|---|---|--|---|---|---|---|--|---|---|---|---|---|---|----|----|------|-------|--|--|--|--|--|--|--|--|--|--|--|--|--|--|--|--|--|--|
| Ted Beard, L (1, 9)<br>OBP: 0.317, SLG: 0.472       | 0-0 F7  | 4-0 BB   |   |   | 0-3 K   |   | 0-0 FC1-2<br>FC5-4 1B<br>2B                          |   | 0-0 3-1   |   |   |   |   |    |    |      |       |  |  |  |  |  |  |  |  |  |  |  |  |  |  |  |  |  |  |
| Johnny Hopp, L (1, 3)<br>OBP: 0.424, SLG: 0.467     | 0-0   | 0-3 K  |   |   | 0-0 4-3   |   | 0-0  |   | 0-0 G3  |   |   |   |   |    |    |      |       |  |  |  |  |  |  |  |  |  |  |  |  |  |  |  |  |  |  |
| Dale Coogan, L (4, 3)<br>OBP: 0.400, SLG: 0.250     |   |  |   |   |   |   | 0-0  |   |   |   |   |   |   |    |    |      |       |  |  |  |  |  |  |  |  |  |  |  |  |  |  |  |  |  |  |
| Ralph Kiner, R (1, 7)<br>OBP: 0.400, SLG: 0.559     | 0-3 K   |  |   |   | 0-0 5-3<br>1B                                       |   | 0-0  |   | 0-0 6-3   |   |   |   |   |    |    |      |       |  |  |  |  |  |  |  |  |  |  |  |  |  |  |  |  |  |  |
| Nanny Fernandez, R (1, 5)<br>OBP: 0.243, SLG: 0.343 | 0-3 K   |  |   |   | 0-0 F3  |   | 0-0  |   |   |   |   |   |   |    |    |      |       |  |  |  |  |  |  |  |  |  |  |  |  |  |  |  |  |  |  |
| Wally Westlake, R (1, 8)<br>OBP: 0.394, SLG: 0.759  |   |  |   |   | 0-0 5-3   |   | 0-0  |   |   |   |   |   |   |    |    |      |       |  |  |  |  |  |  |  |  |  |  |  |  |  |  |  |  |  |  |
| Danny Murtaugh, R (1, 4)<br>OBP: 0.405, SLG: 0.467  |   |  |   |   |   |   | 0-0  |   |   |   |   |   |   |    |    |      |       |  |  |  |  |  |  |  |  |  |  |  |  |  |  |  |  |  |  |
| Hank Schenz, R (8, 4)<br>(8, 4)                     |   |  |   |   | 0-0 F9  |   | 0-0  |   | 0-3 K   |   |   |   |   |    |    |      |       |  |  |  |  |  |  |  |  |  |  |  |  |  |  |  |  |  |  |
| Stan Rojek, R (1, 6)<br>OBP: 0.310, SLG: 0.333      |   |  |   |   | 0-0 SH5-4<br>F6                                     |   | 0-0  |   | 0-0   |   |   |   |   |    |    |      |       |  |  |  |  |  |  |  |  |  |  |  |  |  |  |  |  |  |  |
| Ed Fitz Gerald, R (1, 2)<br>OBP: 0.067, SLG: 0.133  |   |  |   |   |   |   | 0-0  |   | 0-0   |   |   |   |   |    |    |      |       |  |  |  |  |  |  |  |  |  |  |  |  |  |  |  |  |  |  |
| Earl Turner, R (4, 2)<br>OBP: 0.500, SLG: 0.500     |   |  |   |   | 0-0 F5  |   | 0-0  |   | 0-0 F9  |   |   |   |   |    |    |      |       |  |  |  |  |  |  |  |  |  |  |  |  |  |  |  |  |  |  |
| Bob Chesnes, S (1, 1)<br>OBP: 0.286, SLG: 0.167     |   |  |   |   |   |   | 0-0  |   | 0-0   |   |   |   |   |    |    |      |       |  |  |  |  |  |  |  |  |  |  |  |  |  |  |  |  |  |  |
| Windy McCall, L (1, 1)                              |   |  |   |   | 0-0 6-3   |   | 0-0  |   | 0-0 4-3   |   |   |   |   |    |    |      |       |  |  |  |  |  |  |  |  |  |  |  |  |  |  |  |  |  |  |
| Harry Gumbert, R (6, 1)<br>OBP: 1.000, SLG: 1.000   |   |  |   |   |   |   | 0-0  |   |   |   |   |   |   |    |    |      |       |  |  |  |  |  |  |  |  |  |  |  |  |  |  |  |  |  |  |
| Marv Rickert, L (8, PH)                             |   |  |   |   |   |   | 0-0  |   |   |   |   |   |   |    |    |      |       |  |  |  |  |  |  |  |  |  |  |  |  |  |  |  |  |  |  |
| Hal Gregg, R (8, 1)                                 |   |  |   |   | 0-0 6-3   |   | 0-0  |   |   |   |   |   |   |    |    |      |       |  |  |  |  |  |  |  |  |  |  |  |  |  |  |  |  |  |  |
| <b>Inning Stats</b>                                 | R: 0 H: 1<br>E: 0 LOB: 1<br>K: 2 BB: 0<br>S: 8 P: 8   | R: 1 H: 0<br>E: 0 LOB: 3<br>K: 1 BB: 4<br>S: 5 P: 21 | R: 0 H: 1<br>E: 0 LOB: 1<br>K: 0 BB: 0<br>S: 4 P: 4 | R: 0 H: 0<br>E: 0 LOB: 0<br>K: 0 BB: 0<br>S: 3 P: 3 | R: 0 H: 0<br>E: 0 LOB: 0<br>K: 1 BB: 0<br>S: 5 P: 5 | R: 0 H: 0<br>E: 0 LOB: 0<br>K: 0 BB: 0<br>S: 3 P: 3 | R: 5 H: 5<br>E: 0 LOB: 1<br>K: 0 BB: 1<br>S: 7 P: 11 | R: 0 H: 1<br>E: 0 LOB: 1<br>K: 1 BB: 0<br>S: 6 P: 6 | R: 0 H: 0<br>E: 0 LOB: 0<br>K: 0 BB: 0<br>S: 3 P: 3 |   |   |   |   |    |    |      |       |  |  |  |  |  |  |  |  |  |  |  |  |  |  |  |  |  |  |
| <b>PITCHER</b>                                      | IP WLS BF H R ER SO BB IBB HBP BLK WP HR S P ERA WHIP |  |   |   |   |   |  |   |   |   |   |   |   |    |    |      |       |  |  |  |  |  |  |  |  |  |  |  |  |  |  |  |  |  |  |
| Frank Smith, R (1, 1)<br>ERA: 3.86                  | 1.2   | 10   | 1   | 1   | 1   | 2   | 4  | 0   | 0   | 0 | 0 | 0 | 0 | 10 | 26 | 5.40 | 3.000 |  |  |  |  |  |  |  |  |  |  |  |  |  |  |  |  |  |  |
| Eddie Erault, R (2, 1)<br>ERA: 6.35                 | 7.1   | 29   | 7   | 5   | 5   | 3   | 1  | 0   | 0   | 0 | 0 | 0 | 0 | 34 | 38 | 6.14 | 1.091 |  |  |  |  |  |  |  |  |  |  |  |  |  |  |  |  |  |  |

|       |        |
|-------|--------|
| WP: 0 | PA: 39 |
| PB: 0 |        |
| SB: 0 |        |
| CS: 0 |        |



| Batter  | 1                                   | 2                | 3               | 4                       | 5 | 6                     | 7                      | 8                | 9 | AB | R | H | RBI | BB | SO | LOB |
|---|-------------------------------------|------------------|-----------------|-------------------------|---|-----------------------|------------------------|------------------|---|----|---|---|-----|----|----|-----|
| <b>Bobby Adams, R</b><br>OBP: 0.458, SLG: 0.524<br>(1, 4)     | 4-0<br>BB<br>2B<br>BB               | 0-0<br>F7<br>1-2 |                 | 0-0<br>S<br>1B          |   | 0-0<br>F6<br>1B       | 0-0<br>1B<br>1B        | 0-0<br>1B<br>2B  |   | 5  | 3 | 3 | 0   | 1  | 0  | 1   |
| <b>Lloyd Merriman, L</b><br>OBP: 0.545, SLG: 0.556<br>(1, 8)  | 4-0<br>2B<br>BB                     |                  | 0-0<br>1B<br>2B | 0-3<br>K<br>1-2         |   | 0-0<br>BB<br>HR<br>1B | 0-0<br>1-3<br>F8<br>1B | 4-0<br>1B<br>BB  |   | 4  | 4 | 3 | 1   | 2  | 1  | 1   |
| <b>Johnny Wyrostek, L</b><br>OBP: 0.400, SLG: 0.516<br>(1, 7) | 0-0<br>G3<br>F9<br>1-H<br>2-H<br>2B |                  | 0-0<br>F8<br>1B | 0-3<br>K<br>1-2         |   | 4-0<br>HR<br>BB       | 0-0<br>E3<br>1-3<br>2B | 0-0<br>1-2<br>1B |   | 5  | 3 | 2 | 3   | 1  | 1  | 3   |
| <b>Ted Kluszewski, L</b><br>OBP: 0.348, SLG: 0.455<br>(1, 3)  | 0-0<br>G3                           |                  | 0-0<br>1B<br>1B | 0-0<br>1-3              |   | 0-0<br>HR             | 0-0<br>1-3             | 0-0<br>1-3       |   | 6  | 2 | 2 | 4   | 0  | 0  | 6   |
| <b>Joe Adcock, R</b><br>OBP: 0.313, SLG: 0.375<br>(9, 3)      | 2-3                                 |                  |                 |                         |   | 1-H<br>2-H<br>HR      | 1-2<br>2-3             |                  |   | 0  | 0 | 0 | 0   | 0  | 0  | 0   |
| <b>Ron Northey, L</b><br>OBP: 0.500, SLG: 0.778<br>(1, 9)     | 0-0<br>F9<br>3-H                    |                  | 0-0<br>1B<br>1B |                         |   | 0-0<br>F9<br>HR       | 0-0<br>F8              |                  |   | 5  | 2 | 2 | 3   | 0  | 0  | 1   |
| <b>Peanuts Lowrey, R</b><br>OBP: 0.273, SLG: 0.273<br>(9, 9)  |                                     |                  |                 |                         |   |                       |                        |                  |   | 0  | 0 | 0 | 0   | 0  | 0  | 0   |
| <b>Grady Hatton, L</b><br>OBP: 0.267, SLG: 0.222<br>(1, 5)    | 0-0<br>F8                           |                  | 0-0<br>F5       |                         |   | 0-0<br>4-1<br>BB      | 4-0<br>S<br>BB         | 0-0<br>2-H<br>2B |   | 4  | 0 | 1 | 1   | 1  | 0  | 2   |
| <b>Walker Cooper, R</b><br>OBP: 0.160, SLG: 0.200<br>(1, 2)   |                                     |                  | 0-0<br>PB<br>1B | 0-0<br>1-2<br>2-H<br>1B |   | 0-0<br>2B             | 0-0<br>F4<br>1-2       | 0-0<br>F7        |   | 5  | 0 | 3 | 1   | 0  | 0  | 2   |
| <b>Virgil Stallcup, R</b><br>OBP: 0.333, SLG: 0.296<br>(1, 6) |                                     |                  | 0-0<br>F2<br>1B | 0-0<br>1-2<br>2-H<br>1B |   | 4-0<br>IBB            | 4-0<br>IBB             | 0-0<br>6-3       |   | 3  | 0 | 1 | 1   | 2  | 0  | 1   |
| <b>Frank Smith, R</b><br>OBP: 0.333, SLG: 0.333<br>(1, 1)     |                                     |                  | 0-3<br>K        | 0-3<br>K                |   | 0-3<br>K              | 0-0<br>1-3             | 0-0<br>F4        |   | 0  | 0 | 0 | 0   | 0  | 0  | 0   |
| <b>Eddie ERAUTT, R</b><br>(2, 1)                              |                                     |                  |                 |                         |   |                       |                        |                  |   | 5  | 0 | 0 | 0   | 0  | 3  | 7   |

| Inning Stats                                   | R: 3 | H: 1 | E: 0 | K: 0 | S: 4 | LOB: 0 | BB: 2 | P: 12 | R: 0 | H: 1 | E: 0 | K: 1 | S: 6 | LOB: 1 | BB: 0 | P: 6  | R: 3  | H: 5 | E: 0 | K: 1 | S: 10 | LOB: 2 | BB: 0 | P: 10 | R: 0 | H: 1 | E: 0 | K: 2 | S: 8 | LOB: 1 | BB: 0 | P: 8 | R: 0 | H: 1 | E: 0 | K: 1 | S: 6 | LOB: 2 | BB: 1 | P: 10 | R: 4 | H: 3 | E: 0 | K: 0 | S: 6 | LOB: 2 | BB: 3 | P: 18 | R: 3 | H: 3 | E: 1 | K: 0 | S: 7 | LOB: 1 | BB: 0 | P: 7 | R: 1 | H: 2 | E: 0 | K: 0 | S: 5 | LOB: 2 | BB: 1 | P: 9 |
|--|------|------|------|------|------|--------|-------|-------|------|------|------|------|------|--------|-------|-------|-------|------|------|------|-------|--------|-------|-------|------|------|------|------|------|--------|-------|------|------|------|------|------|------|--------|-------|-------|------|------|------|------|------|--------|-------|-------|------|------|------|------|------|--------|-------|------|------|------|------|------|------|--------|-------|------|
| <b>PITCHER</b>                                 | IP   | WLS  | BF   | H    | R    | ER     | SO    | BB    | IBB  | HBP  | BLK  | WP   | HR   | S      | P     | ERA   | WHIP  |      |      |      |       |        |       |       |      |      |      |      |      |        |       |      |      |      |      |      |      |        |       |       |      |      |      |      |      |        |       |       |      |      |      |      |      |        |       |      |      |      |      |      |      |        |       |      |
| <b>Bob Chesnes, R</b><br>ERA: 3.94<br>(1, 1)   | 0.0  | L    | 3    | 1    | 3    | 3      | 0     | 2     | 0    | 0    | 0    | 0    | 0    | 1      | 9     | ∞     | ∞     |      |      |      |       |        |       |       |      |      |      |      |      |        |       |      |      |      |      |      |      |        |       |       |      |      |      |      |      |        |       |       |      |      |      |      |      |        |       |      |      |      |      |      |      |        |       |      |
| <b>Windy McCall, L</b><br>ERA: 11.81<br>(1, 1) | 5.1  |      | 29   | 11   | 7    | 7      | 5     | 1     | 1    | 0    | 0    | 0    | 2    | 37     | 45    | 11.81 | 2.250 |      |      |      |       |        |       |       |      |      |      |      |      |        |       |      |      |      |      |      |      |        |       |       |      |      |      |      |      |        |       |       |      |      |      |      |      |        |       |      |      |      |      |      |      |        |       |      |
| <b>Harry Gumbert, R</b><br>ERA: 5.4<br>(6, 1)  | 1.2  |      | 11   | 3    | 3    | 1      | 0     | 1     | 1    | 0    | 0    | 0    | 0    | 9      | 17    | 5.40  | 2.400 |      |      |      |       |        |       |       |      |      |      |      |      |        |       |      |      |      |      |      |      |        |       |       |      |      |      |      |      |        |       |       |      |      |      |      |      |        |       |      |      |      |      |      |      |        |       |      |
| <b>Hal Gregg, R</b><br>ERA: 3.86<br>(8, 1)     | 1.0  |      | 6    | 2    | 1    | 1      | 0     | 1     | 0    | 0    | 0    | 0    | 0    | 5      | 9     | 9.00  | 3.000 |      |      |      |       |        |       |       |      |      |      |      |      |        |       |      |      |      |      |      |      |        |       |       |      |      |      |      |      |        |       |       |      |      |      |      |      |        |       |      |      |      |      |      |      |        |       |      |

**BOTTOM**

**Pittsburgh Pirates @ Cincinnati Reds**  
Crosley Field, Cincinnati, OH

Sat Apr 29 1950, 3:33 AM EST  
Att. 4,895 - Unknown

|            |           |
|------------|-----------|
| <b>AB</b>  | <b>42</b> |
| <b>R</b>   | <b>14</b> |
| <b>H</b>   | <b>17</b> |
| <b>RBI</b> | <b>14</b> |
| <b>BB</b>  | <b>7</b>  |
| <b>SO</b>  | <b>5</b>  |
| <b>LOB</b> | <b>24</b> |

livebaseballscores.com



|           |          |            |           |
|-----------|----------|------------|-----------|
| <b>WP</b> | <b>0</b> | <b>PA</b>  | <b>49</b> |
| <b>PB</b> | <b>1</b> | <b>SB</b>  | <b>2</b>  |
| <b>CS</b> | <b>0</b> | <b>HR</b>  | <b>2</b>  |
| <b>SF</b> | <b>0</b> | <b>SAC</b> | <b>0</b>  |
| <b>DP</b> | <b>0</b> | <b>HBP</b> | <b>0</b>  |

| Batter   | 1   | 2                                | 3                            | 4                               | 5                            | 6                               | 7                            | 8                               | 9                            | AB R H RBI BB SO LOB            | TOP                          |                                 |                              |                                 |                              |                                  |                              |                                  |                                  |                                    |   |        |
|--|---|----------------------------------|------------------------------|---------------------------------|------------------------------|---------------------------------|------------------------------|---------------------------------|------------------------------|---------------------------------|------------------------------|---------------------------------|------------------------------|---------------------------------|------------------------------|----------------------------------|------------------------------|----------------------------------|----------------------------------|------------------------------------|---|--------|
| Ted Beard, L (1, 9)<br>OBP: 0.304, SLG: 0.439        | 0-3<br>K  |                                  | 0-0<br>6-3                   |                                 | 0-0<br>5-3                   |                                 | 0-0<br>4-3                   |                                 | 0-0<br>FC4-6<br>1-2<br>1B    | 5 0 1 0 0 1 0                   |                              |                                 |                              |                                 |                              |                                  |                              |                                  |                                  |                                    |   |        |
| Johnny Hopp, L (1, 3)<br>OBP: 0.421, SLG: 0.457      | 0-0<br>F6   |                                  | 0-0<br>E9<br>2B<br>1B        |                                 | 0-0<br>1B                    |                                 | 0-0<br>G3                    |                                 | 0-0<br>FC4-6<br>1-2<br>2-3   | 5 1 2 0 0 0 2                   |                              |                                 |                              |                                 |                              |                                  |                              |                                  |                                  |                                    |   |        |
| Ralph Kiner, R (1, 7)<br>OBP: 0.400, SLG: 0.526      | 4-0<br>1B<br>BB   |                                  | 0-0<br>F9                    |                                 | 0-3<br>K                     |                                 |                              | 0-0<br>IBB<br>K<br>SH5-4<br>1B  | 0-3<br>K                     | 4 0 1 0 1 2 4                   |                              |                                 |                              |                                 |                              |                                  |                              |                                  |                                  |                                    |   |        |
| Nanny Fernandez, R (1, 5)<br>OBP: 0.275, SLG: 0.395  | 0-0<br>1-2<br>1B  |                                  | 0-0<br>1B<br>2B              |                                 | 0-0<br>F9                    |                                 |                              | 0-0<br>SH5-4<br>1-2             |                              | 3 1 2 1 0 0 1                   |                              |                                 |                              |                                 |                              |                                  |                              |                                  |                                  |                                    |   |        |
| Wally Westlake, R (1, 8)<br>OBP: 0.405, SLG: 0.710   | 0-0<br>F7   |                                  | 4-0<br>1B<br>IBB             |                                 | 0-0<br>F5                    |                                 |                              | 4-0<br>IBB<br>IBB               |                              | 2 0 0 0 2 0 2                   |                              |                                 |                              |                                 |                              |                                  |                              |                                  |                                  |                                    |   |        |
| Danny Murtaugh, R (1, 4)<br>OBP: 0.463, SLG: 0.515   |   |                                  | 0-0<br>G3<br>1B              |                                 | 0-0<br>FC4-6<br>1B           |                                 |                              | 4-0<br>1-2<br>2-3<br>IBB        |                              | 3 0 3 1 1 0 0                   |                              |                                 |                              |                                 |                              |                                  |                              |                                  |                                  |                                    |   |        |
| Stan Rojek, R (1, 6)<br>OBP: 0.281, SLG: 0.300       |   |                                  | 0-0<br>G3                    |                                 | 0-0<br>F9                    |                                 |                              | 0-0<br>FC4-6                    |                              | 3 0 0 0 0 0 2                   |                              |                                 |                              |                                 |                              |                                  |                              |                                  |                                  |                                    |   |        |
| Marv Rickert, L (8, PH)                              |   |                                  | 1-2                          |                                 | 1-3<br>2-H                   |                                 |                              | 1-2<br>2-3<br>IBB               |                              | 1 0 0 0 0 1 3                   |                              |                                 |                              |                                 |                              |                                  |                              |                                  |                                  |                                    |   |        |
| Pete Castiglione, R (8, 6)                           |   |                                  |                              |                                 |                              |                                 |                              | 0-3<br>K<br>3-H                 |                              | 0 0 0 0 0 0 0                   |                              |                                 |                              |                                 |                              |                                  |                              |                                  |                                  |                                    |   |        |
| Clyde McCullough, R (1, 2)<br>OBP: 0.100, SLG: 0.053 |   |                                  | 0-0<br>P4                    |                                 | 0-0<br>F3                    |                                 |                              | 0-0<br>F4                       |                              | 3 0 0 0 0 0 2                   |                              |                                 |                              |                                 |                              |                                  |                              |                                  |                                  |                                    |   |        |
| Tom Saffell, L (9, PH)                               |   |                                  |                              |                                 |                              |                                 |                              | 4-0<br>FC4-6<br>1B<br>BB        |                              | 0 0 0 0 1 0 0                   |                              |                                 |                              |                                 |                              |                                  |                              |                                  |                                  |                                    |   |        |
| Cliff Chambers, L (1, 1)<br>OBP: 0.300, SLG: 0.125   |   |                                  | 0-0<br>6-3                   |                                 | 0-0<br>F7                    |                                 |                              | 0-0<br>6-3                      |                              | 3 0 0 0 0 0 1                   |                              |                                 |                              |                                 |                              |                                  |                              |                                  |                                  |                                    |   |        |
| Woody Main, R (8, 1)                                 |   |                                  |                              |                                 |                              |                                 |                              |                                 | 0-3<br>K                     | 0 0 0 0 0 0 0                   |                              |                                 |                              |                                 |                              |                                  |                              |                                  |                                  |                                    |   |        |
| Vic Lombardi, L (8, 1)<br>OBP: 1.000, SLG: 1.000     |   |                                  |                              |                                 |                              |                                 |                              |                                 |                              | 0 0 0 0 0 0 0                   |                              |                                 |                              |                                 |                              |                                  |                              |                                  |                                  |                                    |   |        |
| Dale Coogan, L (9, PH)<br>OBP: 0.333, SLG: 0.200     |   |                                  |                              |                                 |                              |                                 |                              |                                 |                              | 1 0 0 0 0 1 1                   |                              |                                 |                              |                                 |                              |                                  |                              |                                  |                                  |                                    |   |        |
| <b>Inning Stats</b>                                  | R: 0<br>E: 0<br>K: 1<br>S: 6  | H: 1<br>LOB: 2<br>BB: 1<br>P: 10 | R: 0<br>E: 0<br>K: 0<br>S: 4 | H: 1<br>LOB: 1<br>BB: 0<br>P: 4 | R: 2<br>E: 1<br>K: 0<br>S: 5 | H: 3<br>LOB: 2<br>BB: 1<br>P: 9 | R: 0<br>E: 0<br>K: 0<br>S: 3 | H: 0<br>LOB: 0<br>BB: 0<br>P: 3 | R: 0<br>E: 0<br>K: 1<br>S: 6 | H: 1<br>LOB: 1<br>BB: 0<br>P: 6 | R: 0<br>E: 0<br>K: 0<br>S: 4 | H: 1<br>LOB: 1<br>BB: 0<br>P: 4 | R: 0<br>E: 0<br>K: 0<br>S: 3 | H: 0<br>LOB: 0<br>BB: 0<br>P: 3 | R: 0<br>E: 0<br>K: 1<br>S: 5 | H: 1<br>LOB: 3<br>BB: 2<br>P: 13 | R: 0<br>E: 0<br>K: 2<br>S: 8 | H: 1<br>LOB: 2<br>BB: 1<br>P: 12 | 1B: 8<br>2B: 1<br>3B: 0<br>HR: 0 | SF: 0<br>SAC: 1<br>DP: 0<br>HBP: 0 | WP: 0<br>PB: 0<br>SB: 0<br>CS: 0  | PA: 39 |
| <b>PITCHER</b>                                       | IP<br>WLS<br>BF<br>H<br>R<br>ER<br>SO<br>BB<br>IBB<br>HBP<br>BLK<br>WP<br>HR<br>S<br>P<br>ERA<br>WHIP |                                  |                              |                                 |                              |                                 |                              |                                 |                              |                                 |                              |                                 |                              |                                 |                              |                                  |                              |                                  |                                  |                                    | IP<br>WLS<br>BF<br>H<br>R<br>ER<br>SO<br>BB<br>IBB<br>HBP<br>BLK<br>WP<br>HR<br>S<br>P<br>ERA<br>WHIP |        |
| Howie Fox, R (1, 1)<br>ERA: 1.74                     | 8.1<br>W<br>37<br>9<br>2<br>2<br>4<br>2<br>3<br>0<br>0<br>0<br>0<br>40<br>60<br>2.16<br>1.320         |                                  |                              |                                 |                              |                                 |                              |                                 |                              |                                 |                              |                                 |                              |                                 |                              |                                  |                              |                                  |                                  |                                    |   |        |
| Herm Wehmeier, R (9, 1)<br>ERA: 4.4                  | 0.2<br>S<br>2<br>0<br>0<br>0<br>1<br>0<br>0<br>0<br>0<br>0<br>0<br>4<br>4<br>0.00<br>0.000            |                                  |                              |                                 |                              |                                 |                              |                                 |                              |                                 |                              |                                 |                              |                                 |                              |                                  |                              |                                  |                                  |                                    |   |        |

Pittsburgh Pirates @ Cincinnati Reds  
 Crosley Field, Cincinnati, OH  
 Sun Apr 30 1950, 3:33 AM EDT  
 Unknown

livebaseballscorecards.com

AB 33  
 R 2  
 H 9  
 RBI 2  
 BB 5  
 SO 5  
 LOB 18



| Batter   | 1                 | 2          | 3                  | 4          | 5         | 6                     | 7          | 8                              | 9 |
|--|-------------------|------------|--------------------|------------|-----------|-----------------------|------------|--------------------------------|---|
| <b>Bobby Adams, R</b> (1, 4)<br>OBP: 0.464, SLG: 0.520     | 0-0<br>F9         |            | 0-0<br>FC6-4       |            |           | 0-0<br>1B<br>F9<br>1B |            | 0-0<br>FC<br>BB<br>1B          |   |
| <b>Peanuts Lowrey, R</b> (1, 7)<br>OBP: 0.333, SLG: 0.286  | 4-0<br>F8-3<br>BB |            |                    | 0-0<br>F3  |           | 0-0<br>1-3<br>1B      |            | 0-0<br>FC<br>BB<br>HBP<br>1B   |   |
| <b>Johnny Wyrostek, L</b> (1, 8)<br>OBP: 0.385, SLG: 0.471 | 0-0<br>F8-3       |            |                    | 0-0<br>4-3 |           | 0-0<br>F9             |            | 1-0<br>BB<br>1B<br>HBP         |   |
| <b>Lloyd Merriman, L</b> (8, PR)<br>OBP: 0.545, SLG: 0.556 | 1-1               |            |                    |            |           | 3-H                   |            | 1-2<br>HBP                     |   |
| <b>Joe Adcock, R</b> (1, 3)<br>OBP: 0.300, SLG: 0.316      |                   | 0-3<br>K   |                    | 0-0<br>F9  |           | 0-3<br>K              |            | 4-0<br>1B<br>BB                |   |
| <b>Walker Cooper, R</b> (1, 2)<br>OBP: 0.172, SLG: 0.207   |                   | 0-0<br>4-3 |                    |            | 0-0<br>F7 |                       | 0-0<br>5-3 | 0-0<br>1-2<br>2-3<br>3-H<br>1B |   |
| <b>Danny Litwhiler, R</b> (1, 9)<br>OBP: 0.217, SLG: 0.286 |                   | 0-0<br>F8  |                    |            | 0-0<br>E5 |                       | 0-3<br>K   | 0-0<br>L4-3                    |   |
| <b>Ron Northey, L</b> (8, PH)<br>OBP: 0.455, SLG: 0.700    |                   |            |                    |            |           |                       |            | 1-1                            |   |
| <b>Bob Usher, R</b> (9, 9)<br>OBP: 0.278, SLG: 0.667       |                   |            |                    |            |           |                       |            |                                |   |
| <b>Grady Hatton, L</b> (1, 5)<br>OBP: 0.273, SLG: 0.233    |                   |            | 0-0<br>F3          |            | 0-0<br>F5 |                       | 0-0<br>1B  |                                |   |
| <b>Virgil Stallcup, R</b> (1, 6)<br>OBP: 0.303, SLG: 0.267 |                   |            | 0-0<br>F6          |            | 0-0<br>F9 |                       | 0-0<br>F5  |                                |   |
| <b>Howie Fox, R</b> (1, 1)<br>OBP: 0.333, SLG: 0.333       |                   |            | 0-0<br>FC6-4<br>1B |            |           | 0-0<br>4-3            |            | 0-0<br>F6                      |   |
| <b>Herm Wehmeier, R</b> (9, 1)<br>OBP: 0.333, SLG: 0.200   |                   |            |                    |            |           |                       |            |                                |   |

| AB | R | H | RBI | BB | SO | LOB |
|----|---|---|-----|----|----|-----|
| 4  | 2 | 2 | 0   | 0  | 0  | 1   |
| 3  | 1 | 1 | 0   | 1  | 0  | 1   |
| 3  | 0 | 0 | 1   | 0  | 0  | 2   |
| 0  | 1 | 0 | 0   | 0  | 0  | 0   |
| 3  | 0 | 0 | 1   | 1  | 2  | 1   |
| 4  | 0 | 1 | 2   | 0  | 0  | 0   |
| 3  | 0 | 0 | 0   | 0  | 1  | 0   |
| 1  | 0 | 0 | 0   | 0  | 0  | 2   |
| 0  | 0 | 0 | 0   | 0  | 0  | 0   |
| 3  | 0 | 1 | 0   | 0  | 0  | 1   |
| 3  | 0 | 0 | 0   | 0  | 0  | 2   |
| 3  | 0 | 1 | 0   | 0  | 0  | 0   |
| 0  | 0 | 0 | 0   | 0  | 0  | 0   |

**BOTTOM**

**Pittsburgh Pirates @ Cincinnati Reds**  
Crosley Field, Cincinnati, OH

Sun Apr 30 1950, 3:33 AM EDT  
Unknown

|            |           |
|------------|-----------|
| <b>AB</b>  | <b>30</b> |
| <b>R</b>   | <b>4</b>  |
| <b>H</b>   | <b>6</b>  |
| <b>RBI</b> | <b>4</b>  |
| <b>BB</b>  | <b>2</b>  |
| <b>SO</b>  | <b>3</b>  |
| <b>LOB</b> | <b>10</b> |



| Inning Stats                                 |         | R: 0   | H: 0   | E: 0 | K: 0 | S: 2  | R: 0  | H: 0  | E: 0   | K: 1   | S: 5   | R: 0  | H: 1  | E: 0  | K: 0  | S: 4      | R: 0        | H: 0  | E: 0 | K: 0 | S: 3 | R: 0 | H: 0 | E: 1 | K: 0 | S: 4 | R: 1 | H: 2 | E: 0 | K: 1 | S: 7 | R: 0 | H: 1 | E: 0 | K: 1 | S: 6 | R: 3 | H: 2 | E: 0 | K: 0 | S: 5 |
|--|---------|--------|--------|------|------|-------|-------|-------|--------|--------|--------|-------|-------|-------|-------|-----------|-------------|-------|------|------|------|------|------|------|------|------|------|------|------|------|------|------|------|------|------|------|------|------|------|------|------|
| <b>Cliff Chambers, L</b> (1, 1)<br>ERA: 2.84 | IP: 7.1 | WLS: L | BF: 31 | H: 5 | R: 4 | ER: 4 | SO: 3 | BB: 2 | IBB: 0 | HBP: 1 | BLK: 0 | WP: 1 | HR: 0 | S: 34 | P: 43 | ERA: 4.91 | WHIP: 0.955 |       |      |      |      |      |      |      |      |      |      |      |      |      |      |      |      |      |      |      |      |      |      |      |      |
| <b>Woody Main, R</b> (8, 1)<br>ERA:          | 0.0     |        | 1      | 1    | 0    | 0     | 0     | 0     | 0      | 0      | 0      | 0     | 0     | 0     | 1     | 1         | ∞           | ∞     |      |      |      |      |      |      |      |      |      |      |      |      |      |      |      |      |      |      |      |      |      |      |      |
| <b>Vic Lombardi, L</b> (8, 1)<br>ERA:        | 0.2     |        | 1      | 0    | 0    | 0     | 0     | 0     | 0      | 0      | 0      | 0     | 0     | 0     | 1     | 1         | 0.00        | 0.000 |      |      |      |      |      |      |      |      |      |      |      |      |      |      |      |      |      |      |      |      |      |      |      |

| WP | PA | 3B | SF | SAC | DP | HBP |
|----|----|----|----|-----|----|-----|
| 1  | 33 | 0  | 0  | 0   | 2  | 1   |

| Batter   | 1   | 2   | 3   | 4   | 5  | 6   | 7   | 8   | 9   | AB R H RBI BB SO LOB                                       | TOP                                     |   |
|--|---|---|---|---|--|---|---|---|---|--|---|---|
| Ted Beard, L (1, 9) X<br>OBP: 0.333, SLG: 0.489                                | 0-0<br>WP BB<br>1B                                    |   | 0-0<br>3B   |   | 4-0<br>4-3 BB<br>BB                                  | 0-3<br>K  |   |   | 0-0<br>4-3  | 4 0 2 0 1 1 1  |   |   |
| Tom Saffell, L (1, 8) BBB  | 4-0<br>1-2 WP<br>BB                                   |   | 1-0<br>BB<br>HBP                                    |   | 4-0<br>1-2 4-3<br>BB                                 |   | 0-0<br>G3   | 0-0<br>F8   | 2 0 0 0 2 0 0                                       |  |   |   |
| Johnny Hopp, L (1, 3) X  | 0-0<br>F7   |   | 4-0<br>1-2 G6-4-3<br>BB                             |   | 0-0<br>4-3<br>1-2 2-3                                |   | 0-0<br>3-1  |   | 3 0 0 0 1 0 4                                       |  |   |   |
| Ralph Kiner, R (1, 7)  | 4-0<br>1-2 2-3<br>IBB                                 |   | 0-0<br>G6-4-3<br>1-2f                               |   | 4-0<br>IBB   |   | 4-0<br>FC6-4<br>BB                                  |   | 1 0 0 0 3 0 3                                       |  |   |   |
| Nanny Fernandez, R (1, 5) X  | 0-0<br>G6-4-3<br>1-2f                                 |   |   | 0-0<br>FC1-5<br>2B                                  |  | 0-0<br>F7   |   | 0-0<br>FC6-4<br>1-2f                                | 4 0 1 0 0 0 7                                       |  |   |   |
| Danny Murtaugh, R (1, 4)   |   | 0-3<br>K  |   | 0-0<br>5-3  |  | 0-3<br>K  |   | 0-0<br>F2   | 4 0 0 0 0 2 1                                       |  |   |   |
| Pete Castiglione, R (1, 6)   |   | 0-0<br>1-3  |   | 0-0<br>FC1-5<br>2-3                                 |  | 0-3<br>K  |   | 0-0<br>K2-6-2<br>1B                                 | 4 0 1 0 0 1 1                                       |  |   |   |
| Clyde McCullough, R (1, 2)<br>Marv Rickert, L (8, PH)<br>Earl Turner, R (8, 2) |   | 0-0<br>5-3  |   | 0-3<br>K  |  | 0-0<br>E<br>2B  |   | 0-3<br>K2-6-2<br>1-2f                               | 3 1 1 0 0 1 1<br>1 0 0 0 0 1 1<br>0 0 0 0 0 0 0     |  |   |   |
| Mel Queen, R (1, 1)<br>Wally Westlake, R (9, PH)                               |   |   | 0-0<br>1-3  |   | 0-0<br>1-3   | 0-0<br>E6<br>2-H                                      |   | 0-0<br>6-3  | 3 0 0 0 0 0 0<br>1 0 0 0 0 0 0                      |  |   |   |
| <b>Inning Stats</b>  | R: 0 H: 1<br>E: 0 LOB: 2<br>K: 0 BB: 2<br>S: 3 P: 11  | R: 0 H: 0<br>E: 0 LOB: 0<br>K: 1 BB: 0<br>S: 5 P: 5 | R: 0 H: 1<br>E: 0 LOB: 2<br>K: 1 BB: 1<br>S: 3 P: 8 | R: 0 H: 1<br>E: 0 LOB: 1<br>K: 1 BB: 0<br>S: 6 P: 6 | R: 0 H: 0<br>E: 0 LOB: 3<br>K: 0 BB: 3<br>S: 3 P: 15 | R: 1 H: 1<br>E: 1 LOB: 1<br>K: 3 BB: 0<br>S: 11 P: 11 | R: 0 H: 0<br>E: 0 LOB: 1<br>K: 0 BB: 1<br>S: 3 P: 7 | R: 0 H: 1<br>E: 0 LOB: 1<br>K: 1 BB: 0<br>S: 5 P: 5 | R: 0 H: 0<br>E: 0 LOB: 0<br>K: 0 BB: 0<br>S: 3 P: 3 | 1B: 2 SF: 0<br>2B: 3 SAC: 0<br>3B: 1 DP: 3<br>HR: 0 HBP: 1 | WP: 1 PA: 38<br>PB: 0<br>SB: 0<br>CS: 0 |   |
| <b>PITCHER</b><br>Ewell Blackwell, R (1, 1)<br>ERA:                            | IP WLS BF H R ER SO BB IBB HBP BLK WP HR S P ERA WHIP |   |   |   |  |   |   |   |   |  |   | <b>PITCHER</b><br>IP WLS BF H R ER SO BB IBB HBP BLK WP HR S P ERA WHIP |

Pittsburgh Pirates @ Cincinnati Reds  
 Crosley Field, Cincinnati, OH  
 Sun Apr 30 1950, 3:38 AM EDT  
 Att: 10,759 - Unknown

livebaseballscorecards.com

|     |    |
|-----|----|
| AB  | 30 |
| R   | 1  |
| H   | 5  |
| RBI | 0  |
| BB  | 7  |
| SO  | 6  |
| LOB | 19 |



| Batter  | 1                      | 2           | 3            | 4            | 5 | 6                       | 7                      | 8           | 9 |
|---|------------------------|-------------|--------------|--------------|---|-------------------------|------------------------|-------------|---|
| <b>Bobby Adams, R</b><br>OBP: 0.469, SLG: 0.481<br>(1, 4)<br>BBB  | 4-0<br>3-1 SH5-3<br>BB |             | x 0-0<br>F8  |              |   | BBB<br>4-0<br>1-2<br>BB |                        | x 0-0<br>F9 |   |
| <b>Lloyd Merriman, L</b><br>OBP: 0.429, SLG: 0.417<br>(1, 8)<br>x   | 0-0<br>SH5-3<br>1-2    |             |              | x 0-0<br>F7  |   | SSS<br>0-3<br>K         |                        | x 0-0<br>F8 |   |
| <b>Johnny Wyrostek, L</b><br>OBP: 0.349, SLG: 0.421<br>(1, 7)<br>(8, 9)<br>x  | 0-0<br>3-1<br>2-3      |             |              | x 0-0<br>F9  |   | x 0-0<br>F8             |                        | x 0-0<br>F9 |   |
| <b>Ted Kluszewski, L</b><br>OBP: 0.346, SLG: 0.417<br>(1, 3)<br>x   | 0-0<br>F8              |             |              | x 0-0<br>4-3 |   | BBB<br>4-0<br>HR<br>BB  |                        |             |   |
| <b>Ron Northey, L</b><br>OBP: 0.429, SLG: 0.846<br><b>Peanuts Lowrey, R</b><br>OBP: 0.333, SLG: 0.286<br>(1, 9)<br>(8, 7) |                        | x 0-0<br>G3 |              | x 0-0<br>F8  |   | x 0-0<br>1-H<br>HR      |                        |             |   |
| <b>Grady Hatton, L</b><br>OBP: 0.250, SLG: 0.212<br>(1, 5)<br>x   | 0-0<br>F7              |             |              | x 0-0<br>4-3 |   | x 0-0<br>4-3            |                        |             |   |
| <b>Virgil Stallcup, R</b><br>OBP: 0.306, SLG: 0.273<br>(1, 6)<br>x  | 0-0<br>P3              |             |              | x 0-0<br>5-3 |   | x 0-0<br>FC6-4<br>1B    |                        |             |   |
| <b>Dixie Howell, R</b><br>(1, 2)<br>x   |                        |             | x 0-0<br>5-3 |              |   | x 0-0<br>F6             | x 0-0<br>F6            |             |   |
| <b>Ewell Blackwell, R</b><br>(1, 1)<br>x  |                        |             | x 0-0<br>4-3 |              |   | BBB<br>4-0<br>BB<br>BB  | x 0-0<br>FC6-4<br>1-2f |             |   |

| AB | R | H | RBI | BB | SO | LOB |
|----|---|---|-----|----|----|-----|
| 2  | 0 | 0 | 0   | 2  | 0  | 0   |
| 3  | 0 | 0 | 0   | 0  | 1  | 2   |
| 4  | 0 | 0 | 0   | 0  | 0  | 3   |
| 2  | 1 | 0 | 0   | 1  | 0  | 1   |
| 3  | 1 | 1 | 2   | 0  | 0  | 0   |
| 0  | 0 | 0 | 0   | 0  | 0  | 0   |
| 3  | 0 | 0 | 0   | 0  | 0  | 0   |
| 3  | 0 | 1 | 0   | 0  | 0  | 0   |
| 3  | 0 | 0 | 0   | 0  | 0  | 1   |
| 2  | 0 | 0 | 0   | 1  | 0  | 1   |

**BOTTOM**

**Pittsburgh Pirates @ Cincinnati Reds**  
Crosley Field, Cincinnati, OH  
Sun Apr 30 1950, 3:38 AM EDT  
Att. 10,759 - Unknown

[livebaseballscorecards.com](http://livebaseballscorecards.com)

|            |           |
|------------|-----------|
| <b>AB</b>  | <b>25</b> |
| <b>R</b>   | <b>2</b>  |
| <b>H</b>   | <b>2</b>  |
| <b>RBI</b> | <b>2</b>  |
| <b>BB</b>  | <b>4</b>  |
| <b>SO</b>  | <b>1</b>  |
| <b>LOB</b> | <b>8</b>  |



|       |        |
|-------|--------|
| 1B: 1 | SF: 0  |
| 2B: 0 | SAC: 1 |
| 3B: 0 | DP: 0  |
| HR: 1 | HBP: 0 |

|       |        |
|-------|--------|
| WP: 0 | PA: 30 |
| PB: 0 |        |
| SB: 0 |        |
| CS: 0 |        |

| Inning Stats | R: 0 | H: 0 | E: 0 | LOB: 1 | K: 0 | BB: 1 | S: 3 | R: 0 | H: 0 | E: 0 | LOB: 0 | K: 0 | BB: 0 | S: 3 | R: 0 | H: 0 | E: 0 | LOB: 0 | K: 0 | BB: 0 | S: 3 | R: 0 | H: 0 | E: 0 | LOB: 0 | K: 0 | BB: 0 | S: 3 | R: 0 | H: 0 | E: 0 | LOB: 0 | K: 1 | BB: 2 | S: 5 | R: 2 | H: 2 | E: 0 | LOB: 1 | K: 0 | BB: 1 | S: 3 | R: 0 | H: 0 | E: 0 | LOB: 0 | K: 0 | BB: 0 | S: 3 |
|--------------|------|------|------|--------|------|-------|------|------|------|------|--------|------|-------|------|------|------|------|--------|------|-------|------|------|------|------|--------|------|-------|------|------|------|------|--------|------|-------|------|------|------|------|--------|------|-------|------|------|------|------|--------|------|-------|------|
|--------------|------|------|------|--------|------|-------|------|------|------|------|--------|------|-------|------|------|------|------|--------|------|-------|------|------|------|------|--------|------|-------|------|------|------|------|--------|------|-------|------|------|------|------|--------|------|-------|------|------|------|------|--------|------|-------|------|

| PITCHER                                    | IP  | WLS | BF | H | R | ER | SO | BB | IBB | HBP | BLK | WP | HR | S  | P  | ERA  | WHIP  |
|--|-----|-----|----|---|---|----|----|----|-----|-----|-----|----|----|----|----|------|-------|
| <b>Mel Queen, R</b><br>ERA: 2.25<br>(1, 1) | 8.0 | L   | 30 | 2 | 2 | 2  | 1  | 4  | 0   | 0   | 0   | 0  | 1  | 28 | 44 | 2.25 | 0.750 |

| PITCHER | IP | WLS | BF | H | R | ER | SO | BB | IBB | HBP | BLK | WP | HR | S | P | ERA | WHIP |
|---------|----|-----|----|---|---|----|----|----|-----|-----|-----|----|----|---|---|-----|------|
|---------|----|-----|----|---|---|----|----|----|-----|-----|-----|----|----|---|---|-----|------|

| Batter   | 1   | 2                               | 3                            | 4                               | 5                            | 6                               | 7                            | 8                               | 9                            | AB R H RBI BB SO LOB            | TOP                          |                                 |                              |                                 |                              |                                 |                              |                                 |                                  |                                    |                                  |        |
|--|---|---------------------------------|------------------------------|---------------------------------|------------------------------|---------------------------------|------------------------------|---------------------------------|------------------------------|---------------------------------|------------------------------|---------------------------------|------------------------------|---------------------------------|------------------------------|---------------------------------|------------------------------|---------------------------------|----------------------------------|------------------------------------|----------------------------------|--------|
| <b>Eddie Stanky, R</b><br>OBP: 0.410, SLG: 0.323<br>(1, 4) X | 0-0<br>L4   |                                 | 0-0<br>F5                    |                                 |                              |                                 |                              |                                 | 0-0<br>4-3                   | 4 1 1 2 1 0 0                   |                              |                                 |                              |                                 |                              |                                 |                              |                                 |                                  |                                    |                                  |        |
| <b>Alvin Dark, R</b><br>OBP: 0.375, SLG: 0.484<br>(1, 6) X   | 0-0<br>F8   |                                 |                              | 0-0<br>F3                       | 0-0<br>5-3                   |                                 |                              | 0-0<br>F8                       | 0-0<br>1-3                   | 5 0 0 0 0 0 2                   |                              |                                 |                              |                                 |                              |                                 |                              |                                 |                                  |                                    |                                  |        |
| <b>Don Mueller, L</b><br>OBP: 0.351, SLG: 0.405<br>(1, 9) X  | 0-0<br>4-3  |                                 |                              | 0-0<br>1B                       |                              | 0-0<br>1B 2B                    | 0-0<br>1B                    | 0-0<br>1B                       | 0-0<br>FC6-4 1B              | 5 0 4 0 0 0 0                   |                              |                                 |                              |                                 |                              |                                 |                              |                                 |                                  |                                    |                                  |        |
| <b>Bobby Thomson, R</b><br>OBP: 0.333, SLG: 0.294<br>(1, 8)  |   | 0-0<br>6-3                      |                              | 0-0<br>F3                       |                              | 0-0<br>G3 1B                    | 0-0<br>1B                    | 0-0<br>1B                       | 0-0<br>FC6-4                 | 5 1 2 1 0 0 2                   |                              |                                 |                              |                                 |                              |                                 |                              |                                 |                                  |                                    |                                  |        |
| <b>Hank Thompson, L</b><br>OBP: 0.485, SLG: 0.750<br>(1, 5)  |   | 0-0<br>F6                       |                              | 0-0<br>F8                       |                              | 0-0<br>G3                       |                              | 0-0<br>SH1-3 1B 2B              |                              | 4 1 1 0 0 0 2                   |                              |                                 |                              |                                 |                              |                                 |                              |                                 |                                  |                                    |                                  |        |
| <b>Whitey Lockman, L</b><br>OBP: 0.297, SLG: 0.343<br>(1, 7) |   | 4-0<br>BB                       |                              |                                 | 0-0<br>6-3                   | 0-0<br>1B                       |                              | 0-0<br>SH1-3                    |                              | 2 0 1 1 1 0 0                   |                              |                                 |                              |                                 |                              |                                 |                              |                                 |                                  |                                    |                                  |        |
| <b>Wes Westrum, R</b><br>OBP: 0.533, SLG: 0.565<br>(1, 2)    |   | 0-0<br>F6                       |                              |                                 | 0-0<br>5-3                   | 0-0<br>1B                       |                              | 0-0<br>FC4-6 1B                 |                              | 4 0 2 1 0 0 1                   |                              |                                 |                              |                                 |                              |                                 |                              |                                 |                                  |                                    |                                  |        |
| <b>Jack Harshman, L</b><br>OBP: 0.219, SLG: 0.345<br>(1, 3)  |   |                                 | 0-0<br>4-3                   |                                 | 0-0<br>E3 1B 3B              | 0-3<br>K                        |                              | 0-0<br>FC4-6                    |                              | 4 1 0 0 0 1 3                   |                              |                                 |                              |                                 |                              |                                 |                              |                                 |                                  |                                    |                                  |        |
| <b>Monty Kennedy, R</b><br>OBP: 0.143, SLG: 0.143<br>(1, 1)  |   |                                 | 0-0<br>F9                    |                                 | 0-0<br>3B 1B                 |                                 | 0-0<br>F4                    | 0-0<br>4-3                      |                              | 4 1 1 0 0 0 1                   |                              |                                 |                              |                                 |                              |                                 |                              |                                 |                                  |                                    |                                  |        |
| <b>Inning Stats</b>  | R: 0<br>E: 0<br>K: 0<br>S: 3                          | H: 0<br>LOB: 0<br>BB: 0<br>P: 3 | R: 0<br>E: 0<br>K: 0<br>S: 3 | H: 0<br>LOB: 1<br>BB: 1<br>P: 7 | R: 0<br>E: 0<br>K: 0<br>S: 3 | H: 0<br>LOB: 0<br>BB: 0<br>P: 3 | R: 0<br>E: 0<br>K: 0<br>S: 4 | H: 1<br>LOB: 1<br>BB: 0<br>P: 4 | R: 2<br>E: 1<br>K: 0<br>S: 6 | H: 2<br>LOB: 1<br>BB: 0<br>P: 6 | R: 1<br>E: 0<br>K: 1<br>S: 8 | H: 4<br>LOB: 2<br>BB: 0<br>P: 8 | R: 1<br>E: 0<br>K: 0<br>S: 4 | H: 2<br>LOB: 2<br>BB: 1<br>P: 8 | R: 1<br>E: 0<br>K: 0<br>S: 5 | H: 2<br>LOB: 1<br>BB: 0<br>P: 5 | R: 0<br>E: 0<br>K: 0<br>S: 4 | H: 1<br>LOB: 1<br>BB: 0<br>P: 4 | 1B: 9<br>2B: 2<br>3B: 1<br>HR: 0 | SF: 0<br>SAC: 1<br>DP: 0<br>HBP: 0 | WP: 0<br>PB: 0<br>SB: 0<br>CS: 0 | PA: 40 |
| <b>PITCHER</b>   | IP WLS BF H R ER SO BB IBB HBP BLK WP HR S P ERA WHIP |                                 |                              |                                 |                              |                                 |                              |                                 |                              |                                 |                              |                                 |                              |                                 |                              |                                 |                              |                                 |                                  |                                    |                                  |        |
| <b>Ken Raffensberger, L</b><br>ERA: 3.38<br>(1, 1)           | 7.0 L 31 9 4 2 1 2 0 0 0 0 0 0 31 39 2.57 1.571       |                                 |                              |                                 |                              |                                 |                              |                                 |                              |                                 |                              |                                 |                              |                                 |                              |                                 |                              |                                 |                                  |                                    |                                  |        |
| <b>Harry Perkowski, L</b><br>ERA: 4.5<br>(8, 1)              | 2.0 9 3 1 1 0 0 0 0 0 0 0 0 9 9 4.50 1.500            |                                 |                              |                                 |                              |                                 |                              |                                 |                              |                                 |                              |                                 |                              |                                 |                              |                                 |                              |                                 |                                  |                                    |                                  |        |

**New York Giants @ Cincinnati Reds**  
Crosley Field, Cincinnati, OH

Wed May 03 1950, 3:33 AM EDT  
Att: 3,214 - Sunny - 82 F

[livebaseballscorecards.com](http://livebaseballscorecards.com)

|            |    |
|------------|----|
| <b>AB</b>  | 37 |
| <b>R</b>   | 5  |
| <b>H</b>   | 12 |
| <b>RBI</b> | 5  |
| <b>BB</b>  | 2  |
| <b>SO</b>  | 1  |
| <b>LOB</b> | 11 |



| Batter   | 1                    | 2          | 3                         | 4          | 5          | 6                  | 7         | 8                     | 9                     | AB | R | H | RBI | BB | SO | LOB |
|--|----------------------|------------|---------------------------|------------|------------|--------------------|-----------|-----------------------|-----------------------|----|---|---|-----|----|----|-----|
| <b>Bobby Adams, R</b> (1, 4)<br>OBP: 0.457, SLG: 0.467       | 0-0<br>FC6-4<br>1B   |            | 0-0<br>SH2-3              |            | 0-0<br>6-3 |                    | 0-0<br>F7 |                       |                       | 3  | 0 | 1 | 0   | 0  | 0  | 0   |
| <b>Peanuts Lowrey, R</b> (1, 7)<br>OBP: 0.316, SLG: 0.333    | 0-0<br>F6            |            | 0-0<br>4-3                |            | 0-0<br>2B  |                    | 0-0<br>F3 |                       |                       | 4  | 0 | 1 | 0   | 0  | 0  | 2   |
| <b>Johnny Wyrostek, L</b> (1, 8)<br>OBP: 0.340, SLG: 0.405   | 0-0<br>L4            |            | 0-0<br>F8                 |            | 0-0<br>F8  |                    |           | 0-0<br>G6-4-3<br>1B   |                       | 4  | 0 | 1 | 0   | 0  | 0  | 3   |
| <b>Joe Adcock, R</b> (1, 3)<br>OBP: 0.250, SLG: 0.261        | 0-0<br>FC6-4<br>1-2f |            |                           | 0-0<br>6-3 |            | 0-0<br>4-3         |           | 0-0<br>G6-4-3<br>1-2f |                       | 4  | 0 | 0 | 0   | 0  | 0  | 2   |
| <b>Walker Cooper, R</b> (1, 2)<br>OBP: 0.182, SLG: 0.212     |                      | 0-0<br>5-3 |                           | 0-0<br>1B  |            | 0-0<br>F6          |           | 0-0<br>6-3            |                       | 4  | 0 | 1 | 0   | 0  | 0  | 0   |
| <b>Danny Litwhiler, R</b> (1, 9)<br>OBP: 0.259, SLG: 0.292   |                      | 0-0<br>F8  |                           | 0-0<br>F9  |            | 4-0<br>1B<br>BB    |           |                       | 0-0<br>DI<br>F7<br>1B | 3  | 1 | 1 | 0   | 1  | 0  | 1   |
| <b>Grady Hatton, L</b> (1, 5)<br>OBP: 0.275, SLG: 0.270      |                      | 0-0<br>2B  |                           | 0-0<br>F7  |            | 0-0<br>FC6-4<br>1B |           |                       | 0-0<br>4-1<br>1-2     | 4  | 0 | 2 | 0   | 0  | 0  | 2   |
| <b>Virgil Stallcup, R</b> (1, 6)<br>OBP: 0.300, SLG: 0.351   |                      | 0-0<br>6-3 |                           |            | 0-0<br>HR  | 0-0<br>FC6-4       |           | 0-0<br>F7             |                       | 4  | 1 | 1 | 2   | 0  | 0  | 3   |
| <b>Ken Raffensberger, R</b> (1, 1)<br>OBP: 0.167, SLG: 0.167 |                      |            | 0-0<br>4-3<br>SH2-3<br>1B |            | 0-0<br>F8  |                    | 0-0<br>F8 |                       | 0-3<br>K              | 2  | 0 | 1 | 0   | 0  | 0  | 0   |
| <b>Bob Usher, R</b> (7, PH)<br>OBP: 0.263, SLG: 0.632        |                      |            |                           |            |            |                    |           |                       |                       | 1  | 0 | 0 | 0   | 0  | 0  | 0   |
| <b>Harry Perkowski, L</b> (8, 1)                             |                      |            |                           |            |            |                    |           |                       |                       | 0  | 0 | 0 | 0   | 0  | 0  | 0   |
| <b>Ted Kluszewski, L</b> (9, PH)<br>OBP: 0.333, SLG: 0.400   |                      |            |                           |            |            |                    |           |                       |                       | 1  | 0 | 0 | 0   | 0  | 1  | 0   |

| Inning Stats   | R: 0    | H: 1   | E: 0   | K: 0   | S: 4  | R: 0   | H: 1   | E: 0   | K: 0   | S: 4   | R: 0   | H: 1  | E: 0      | K: 0        | S: 4  | R: 0      | H: 1        | E: 0  | K: 0   | S: 4   | R: 1  | H: 2   | E: 0  | K: 0  | S: 5   | R: 0  | H: 1      | E: 0        | K: 0  | S: 4  | R: 0   | H: 0  | E: 0  | K: 0   | S: 3  | R: 0   | H: 1   | E: 0  | K: 0 | S: 3   | R: 1      | H: 1        | E: 0 | K: 1 | S: 6 |  |  |
|--|---------|--------|--------|--------|-------|--------|--------|--------|--------|--------|--------|-------|-----------|-------------|-------|-----------|-------------|-------|--------|--------|-------|--------|-------|-------|--------|-------|-----------|-------------|-------|-------|--------|-------|-------|--------|-------|--------|--------|-------|------|--------|-----------|-------------|------|------|------|--|--|
|  | LOB: 1  | BB: 0  | P: 4   | LOB: 1 | BB: 0 | P: 4   | LOB: 1 | BB: 0  | P: 4   | LOB: 1 | BB: 0  | P: 4  | LOB: 1    | BB: 0       | P: 4  | LOB: 2    | BB: 1       | P: 8  | LOB: 0 | BB: 0  | P: 3  | LOB: 0 | BB: 0 | P: 3  | LOB: 0 | BB: 0 | P: 3      | LOB: 0      | BB: 0 | P: 3  | LOB: 0 | BB: 0 | P: 3  | LOB: 0 | BB: 0 | P: 3   | LOB: 0 | BB: 0 | P: 6 | LOB: 0 | BB: 0     | P: 6        |      |      |      |  |  |
|  | 1B: 6   | 2B: 2  | 3B: 0  | HR: 1  | SF: 0 | SAC: 1 | DP: 1  | HBP: 0 | WP: 0  | HR: 1  | S: 1   | P: 4  | ERA: 2.00 | WHIP: 1.111 | 1B: 6 | 2B: 2     | 3B: 0       | HR: 1 | SF: 0  | SAC: 1 | DP: 1 | HBP: 0 | WP: 0 | HR: 1 | S: 1   | P: 4  | ERA: 2.00 | WHIP: 1.111 | 1B: 6 | 2B: 2 | 3B: 0  | HR: 1 | SF: 0 | SAC: 1 | DP: 1 | HBP: 0 | WP: 0  | HR: 1 | S: 1 | P: 4   | ERA: 2.00 | WHIP: 1.111 |      |      |      |  |  |
| <b>PITCHER</b><br><b>Monty Kennedy, L</b> (1, 1)<br>ERA: 1.1 | IP: 9.0 | WLS: W | BF: 36 | H: 9   | R: 2  | ER: 2  | SO: 1  | BB: 1  | IBB: 0 | HBP: 0 | BLK: 0 | WP: 0 | HR: 1     | S: 37       | P: 41 | ERA: 2.00 | WHIP: 1.111 |       |        |        |       |        |       |       |        |       |           |             |       |       |        |       |       |        |       |        |        |       |      |        |           |             |      |      |      |  |  |

**BOTTOM**

**New York Giants @ Cincinnati Reds**  
Crosley Field, Cincinnati, OH

Wed May 03 1950, 3:33 AM EDT  
Att. 3,214 - Sunny - 82 F

livebaseballscorecards.com

|            |           |
|------------|-----------|
| <b>AB</b>  | <b>34</b> |
| <b>R</b>   | <b>2</b>  |
| <b>H</b>   | <b>9</b>  |
| <b>RBI</b> | <b>2</b>  |
| <b>BB</b>  | <b>1</b>  |
| <b>SO</b>  | <b>1</b>  |
| <b>LOB</b> | <b>13</b> |



WP: 0 PA: 36  
PB: 0  
SB: 0  
CS: 0

| Batter   | 1   | 2   | 3  | 4   | 5   | 6   | 7   | 8  | 9  | AB R H RBI BB SO LOB   | TOP  |  |   |
|--|---|---|--|---|---|---|---|--|--|--|--|--|---|
| Sam Jethroe, S<br>OBP: 0.384, SLG: 0.523<br>(1, 8)   | 0-0<br>6-3  |   | 0-0<br>E4<br>HR  |   | 0-0<br>F7   |   | 0-0<br>2-H<br>HR  |  | 0-0<br>F9  | 5 2 1 2 0 0 0  |  |  |   |
| Earl Torgeson, L<br>OBP: 0.403, SLG: 0.315<br>(1, 3)   | 4-0<br>1B<br>BB   |   | 0-0<br>1-H<br>HR   |   | 0-0<br>F8   |   | 0-0<br>6-3  |  | 4-0<br>2B<br>BB  | 3 2 1 2 2 0 0  |  |  |   |
| Bob Elliott, R<br>OBP: 0.294, SLG: 0.417<br>(1, 5)   | 0-0<br>F9   |   | 0-0<br>E<br>1B   |   | 0-0<br>F8   |   |   | 4-0<br>SH<br>HR<br>BB  | 0-0<br>E<br>2B   | 4 2 2 0 1 0 1  |  |  |   |
| Sid Gordon, R<br>OBP: 0.353, SLG: 0.452<br>Luis Olmo, R<br>(8, 7)  | 0-0<br>1-2<br>1B  |   | 0-0<br>L7  |   | 0-0<br>F7   |   |   | 0-0<br>1-2<br>SH<br>HR   | 4-0<br>E<br>F8<br>IBB  | 3 1 1 0 0 0 1<br>0 1 0 0 1 0 0   |  |  |   |
| Willard Marshall, L<br>OBP: 0.304, SLG: 0.338<br>(1, 9)  | 0-0<br>G3   |   | 4-0<br>1-2<br>IBB  |   | 0-0<br>L7   |   |   | 0-0<br>1-H<br>2-H<br>HR  | 0-0<br>1-3<br>2-H<br>3-H<br>E<br>E<br>1B                         | 4 2 2 5 1 0 2  |  |  |   |
| Del Crandall, R<br>OBP: 0.267, SLG: 0.268<br>(1, 2)  |   | 0-0<br>F3   | 0-0<br>F4  |   | 0-0<br>F7   |   |   | 0-0<br>F7  | 0-0<br>F8  | 5 0 0 1 0 0 2  |  |  |   |
| Connie Ryan, R<br>OBP: 0.324, SLG: 0.368<br>(1, 4)   |   | 0-0<br>F2   |  | 0-0<br>6-3  |   |   | 0-0<br>5-3  | 0-0<br>HR  | 0-0<br>F7  | 5 1 1 1 0 0 1  |  |  |   |
| Buddy Kerr, R<br>OBP: 0.270, SLG: 0.333<br>(1, 6)  |   | 0-3<br>K  |  | 0-3<br>K  |   |   | 0-0<br>HR<br>2B   | 0-0<br>F3  |  | 4 1 1 0 0 2 0  |  |  |   |
| Vern Bickford, R<br>OBP: 0.100, SLG: 0.100<br>Pete Reiser, L<br>OBP: 0.438, SLG: 0.538<br>Bob Chipman, L<br>(7, 1)                               |   |   | 0-0<br>F2  | 0-0<br>6-3  |   |   | 0-0<br>F2   | 0-3<br>K   |  | 2 0 0 0 0 0 0<br>1 0 0 0 0 0 1<br>1 0 0 0 0 1 0                        |  |  |   |
| <b>Inning Stats</b>  | R: 0<br>E: 0<br>K: 0<br>S: 4<br>H: 1<br>LOB: 2<br>BB: 1<br>P: 8 | R: 0<br>E: 0<br>K: 1<br>S: 5<br>H: 0<br>LOB: 0<br>BB: 0<br>P: 5 | R: 2<br>E: 2<br>K: 0<br>S: 6<br>H: 2<br>LOB: 2<br>BB: 1<br>P: 10 | R: 0<br>E: 0<br>K: 1<br>S: 5<br>H: 0<br>LOB: 0<br>BB: 0<br>P: 5 | R: 0<br>E: 0<br>K: 0<br>S: 3<br>H: 0<br>LOB: 0<br>BB: 0<br>P: 3 | R: 0<br>E: 0<br>K: 0<br>S: 3<br>H: 0<br>LOB: 0<br>BB: 0<br>P: 3 | R: 2<br>E: 0<br>K: 0<br>S: 5<br>H: 2<br>LOB: 0<br>BB: 0<br>P: 5 | R: 4<br>E: 1<br>K: 1<br>S: 8<br>H: 2<br>LOB: 0<br>BB: 1<br>P: 12 | R: 4<br>E: 2<br>K: 0<br>S: 5<br>H: 2<br>LOB: 1<br>BB: 2<br>P: 13 | 1B: 3<br>2B: 2<br>3B: 0<br>HR: 4<br>SF: 0<br>SAC: 1<br>DP: 0<br>HBP: 0 | WP: 0<br>PB: 0<br>SB: 1<br>CS: 0<br>PA: 43 |  |   |
| <b>PITCHER</b><br>Herm Wehmeier, R<br>ERA: 5.06<br>Eddie Erault, R<br>ERA: 6.57<br>Kent Peterson, L<br>ERA: 12.86<br>Frank Smith, R<br>ERA: 3.68 | IP WLS BF H R ER SO BB IBB HBP BLK WP HR S P ERA WHIP           |   |  |   |   |   |   |  |  |  |  |  | <b>PITCHER</b><br>IP WLS BF H R ER SO BB IBB HBP BLK WP HR S P ERA WHIP |
|  | 7.0 L 32 6 7 5 2 2 1 0 0 0 0 3 33 45 6.43 1.143                 |   |  |   |   |   |   |  |  |  |  |  |   |
|  | (8, 1) 1.0 4 1 1 1 1 0 0 0 0 0 1 6 6 9.00 1.000                 |   |  |   |   |   |   |  |  |  |  |  |   |
|  | (9, 1) 0.1 5 2 4 3 0 1 1 0 0 0 0 3 11 81.00 9.000               |   |  |   |   |   |   |  |  |  |  |  |   |
|  | (9, 1) 0.2 2 0 0 0 0 0 0 0 0 0 0 2 2 0.00 0.000                 |   |  |   |   |   |   |  |  |  |  |  |   |

**Boston Braves @ Cincinnati Reds**  
Crosley Field, Cincinnati, OH  
Thu May 04 1950, 3:33 AM EDT  
Att: 2,617 - Unknown - 92 F

livebaseballscorecards.com

|     |    |
|-----|----|
| AB  | 37 |
| R   | 12 |
| H   | 9  |
| RBI | 11 |
| BB  | 5  |
| SO  | 3  |
| LOB | 8  |





BOTTOM

Boston Braves @ Cincinnati Reds  
Crosley Field, Cincinnati, OH  
Thu May 04 1950, 3:33 AM EDT  
Att. 2,617 - Unknown - 92 F

livebaseballscorecards.com

AB 39  
R 6  
H 14  
RBI 6  
BB 2  
SO 4  
LOB 17



WP: 0 PA: 41  
PB: 0  
SB: 0  
CS: 0

AB R H RBI BB SO LOB

5 0 0 0 0 1 6

5 0 2 1 0 0 0

4 0 1 1 1 0 1

5 1 1 0 0 0 3

5 1 1 0 0 1 1

4 2 4 3 0 0 0

4 0 1 0 0 0 3

2 1 1 1 1 1 1

1 0 0 0 0 0 1

3 1 2 0 0 1 1  
0 0 0 0 0 0 0  
1 0 1 0 0 0 0  
0 0 0 0 0 0 0  
0 0 0 0 0 0 0  
0 0 0 0 0 0 0

1B: 11 SF: 0  
2B: 2 SAC: 0  
3B: 0 DP: 1  
HR: 1 HBP: 0

| Batter   | 1       | 2       | 3       | 4          | 5       | 6       | 7       | 8       | 9       |
|--|---------|---------|---------|------------|---------|---------|---------|---------|---------|
| <b>Bobby Adams, R</b> (1, 4)<br>OBP: 0.400, SLG: 0.400   | 0-0 L5  | 0-0 FC5 |         |            | 0-3 K   |         | 0-0 5-3 | 0-0 6-3 |         |
| <b>Lloyd Merriman, L</b> (1, 8)<br>OBP: 0.421, SLG: 0.412  | 0-0 F8  |         | 0-0 4-3 |            | 0-0 1B  |         | 0-0 F9  |         | 0-0 G3  |
| <b>Johnny Wyrostek, L</b> (1, 7)<br>OBP: 0.346, SLG: 0.391   | 4-0 BB  |         | 0-0 4-3 |            | 0-0 1B  |         | 0-0 F7  |         | 0-0 G3  |
| <b>Ted Kluszewski, L</b> (1, 3)<br>OBP: 0.313, SLG: 0.367  | 0-0 4-3 |         | 0-0 F6  |            | 0-0 4-3 |         |         | 0-0 1B  | 0-0 F7  |
| <b>Ron Northey, L</b> (1, 9)<br>OBP: 0.388, SLG: 0.722   |         | 0-3 K   |         | 0-0 4-3    |         | 0-0 F8  |         | 0-0 1B  | 0-0 4-1 |
| <b>Grady Hatton, L</b> (1, 5)<br>OBP: 0.341, SLG: 0.439  |         | 0-0 HR  |         | 0-0 G6-4-3 |         | 0-0 1B  |         | 0-0 1B  |         |
| <b>Virgil Stallcup, R</b> (1, 6)<br>OBP: 0.295, SLG: 0.341   |         | 0-0 FC5 |         | 0-0 G6-4-3 |         | 0-0 5-3 |         | 0-0 F9  |         |
| <b>Dixie Howell, R</b> (1, 2)<br><b>Walker Cooper, R</b> (8, PH)<br>OBP: 0.176, SLG: 0.206   |         | 0-3 K   |         | 4-0 1B     |         | 0-0 1B  |         | 0-0 F7  |         |
| <b>Herm Wehmeier, R</b> (1, 1)<br><b>Eddie Erault, R</b> (8, 1)<br><b>Danny Litwhiler, R</b> (8, PH)<br><b>Mary Rackley, L</b> (8, PR)<br><b>Kent Peterson, R</b> (9, 1)<br><b>Frank Smith, R</b> (9, 1) |         | 0-0 1B  |         | 0-0 1B     |         | 0-0 K   |         | 0-0 1B  |         |

| Inning Stats | R: 0 | H: 0 | E: 0 | K: 0 | S: 3 | H: 0 | LOB: 1 | BB: 1 | P: 7 | R: 1 | H: 3 | E: 0 | K: 2 | S: 10 | H: 0 | LOB: 0 | BB: 0 | P: 3 | R: 0 | H: 1 | E: 0 | K: 0 | S: 3 | H: 1 | LOB: 0 | BB: 0 | P: 3 | R: 2 | H: 3 | E: 0 | K: 1 | S: 7 | H: 2 | LOB: 1 | BB: 0 | P: 7 | R: 0 | H: 0 | E: 0 | K: 0 | S: 3 | H: 0 | LOB: 0 | BB: 0 | P: 3 | R: 2 | H: 4 | E: 0 | K: 0 | S: 7 | H: 1 | LOB: 1 | BB: 0 | P: 4 | R: 0 | H: 1 | E: 0 | K: 0 | S: 4 | H: 1 | LOB: 1 | BB: 0 | P: 4 |
|--------------|------|------|------|------|------|------|--------|-------|------|------|------|------|------|-------|------|--------|-------|------|------|------|------|------|------|------|--------|-------|------|------|------|------|------|------|------|--------|-------|------|------|------|------|------|------|------|--------|-------|------|------|------|------|------|------|------|--------|-------|------|------|------|------|------|------|------|--------|-------|------|
|--------------|------|------|------|------|------|------|--------|-------|------|------|------|------|------|-------|------|--------|-------|------|------|------|------|------|------|------|--------|-------|------|------|------|------|------|------|------|--------|-------|------|------|------|------|------|------|------|--------|-------|------|------|------|------|------|------|------|--------|-------|------|------|------|------|------|------|------|--------|-------|------|

| PITCHER                                    | IP  | WLS | BF | H | R | ER | SO | BB | IBB | HBP | BLK | WP | HR | S  | P  | ERA  | WHIP  |
|--|-----|-----|----|---|---|----|----|----|-----|-----|-----|----|----|----|----|------|-------|
| <b>Vern Bickford, R</b> (1, 1)<br>ERA: 3.3 | 6.0 |     | 27 | 9 | 4 | 4  | 4  | 2  | 0   | 0   | 0   | 0  | 1  | 33 | 41 | 6.00 | 1.833 |
| <b>Bob Chipman, L</b> (7, 1)<br>ERA: 3.38  | 3.0 | W   | 14 | 5 | 2 | 2  | 0  | 0  | 0   | 0   | 0   | 0  | 0  | 14 | 14 | 6.00 | 1.667 |

| Batter   | 1   | 2                                | 3                            | 4                               | 5                            | 6                               | 7                            | 8                                | 9                            | AB R H RBI BB SO LOB            | TOP                          |                                 |                              |                                 |                              |                                  |                              |                                 |                                  |                                    |                                  |        |
|--|---|----------------------------------|------------------------------|---------------------------------|------------------------------|---------------------------------|------------------------------|----------------------------------|------------------------------|---------------------------------|------------------------------|---------------------------------|------------------------------|---------------------------------|------------------------------|----------------------------------|------------------------------|---------------------------------|----------------------------------|------------------------------------|----------------------------------|--------|
| Sam Jethroe, S<br>OBP: 0.392, SLG: 0.592<br>(1, 8)   |   |                                  |                              |                                 |                              |                                 |                              |                                  |                              | 6 3 3 1 0 1 2                   |                              |                                 |                              |                                 |                              |                                  |                              |                                 |                                  |                                    |                                  |        |
| Earl Torgeson, L<br>OBP: 0.417, SLG: 0.368<br>(1, 3)   |   |                                  |                              |                                 |                              |                                 |                              |                                  |                              | 3 1 1 2 2 0 1                   |                              |                                 |                              |                                 |                              |                                  |                              |                                 |                                  |                                    |                                  |        |
| Bob Elliott, R<br>OBP: 0.315, SLG: 0.477<br>Gene Mauch, R<br>(8, PR)<br>(8, 5)                                 |   |                                  |                              |                                 |                              |                                 |                              |                                  |                              | 5 2 3 1 0 0 1<br>0 0 0 0 0 0 0  |                              |                                 |                              |                                 |                              |                                  |                              |                                 |                                  |                                    |                                  |        |
| Sid Gordon, R<br>OBP: 0.364, SLG: 0.511<br>Pete Reiser, L<br>OBP: 0.412, SLG: 0.500<br>(8, PH)<br>(8, 7)       |   |                                  |                              |                                 |                              |                                 |                              |                                  |                              | 3 2 1 1 1 0 2<br>1 0 0 0 0 0 1  |                              |                                 |                              |                                 |                              |                                  |                              |                                 |                                  |                                    |                                  |        |
| Willard Marshall, L<br>OBP: 0.311, SLG: 0.333<br>Tommy Holmes, L<br>OBP: 0.667, SLG: 0.500<br>(9, 9)<br>(9, 9) |   |                                  |                              |                                 |                              |                                 |                              |                                  |                              | 4 1 1 1 1 0 1<br>0 0 0 0 0 0 0  |                              |                                 |                              |                                 |                              |                                  |                              |                                 |                                  |                                    |                                  |        |
| Del Crandall, R<br>OBP: 0.281, SLG: 0.271<br>Paul Burris, R<br>OBP: 0.250, SLG: 0.250<br>(9, PH)<br>(9, 2)     |   |                                  |                              |                                 |                              |                                 |                              |                                  |                              | 3 1 1 2 1 0 0<br>1 0 0 0 0 0 0  |                              |                                 |                              |                                 |                              |                                  |                              |                                 |                                  |                                    |                                  |        |
| Connie Ryan, R<br>OBP: 0.329, SLG: 0.377<br>(1, 4)   |   |                                  |                              |                                 |                              |                                 |                              |                                  |                              | 4 2 1 0 1 1 3                   |                              |                                 |                              |                                 |                              |                                  |                              |                                 |                                  |                                    |                                  |        |
| Buddy Kerr, R<br>OBP: 0.265, SLG: 0.355<br>Sibby Sisti, R<br>(9, 6)  |   |                                  |                              |                                 |                              |                                 |                              |                                  |                              | 5 1 1 1 0 1 3<br>0 0 0 0 0 0 0  |                              |                                 |                              |                                 |                              |                                  |                              |                                 |                                  |                                    |                                  |        |
| Warren Spahn, L<br>OBP: 0.353, SLG: 0.313<br>(1, 1)  |   |                                  |                              |                                 |                              |                                 |                              |                                  |                              | 5 0 2 3 0 1 0                   |                              |                                 |                              |                                 |                              |                                  |                              |                                 |                                  |                                    |                                  |        |
| <b>Inning Stats</b>  | R: 6<br>E: 1<br>K: 1<br>S: 10                         | H: 4<br>LOB: 1<br>BB: 2<br>P: 18 | R: 0<br>E: 0<br>K: 0<br>S: 3 | H: 1<br>LOB: 1<br>BB: 1<br>P: 7 | R: 0<br>E: 0<br>K: 1<br>S: 4 | H: 0<br>LOB: 0<br>BB: 1<br>P: 8 | R: 3<br>E: 0<br>K: 1<br>S: 9 | H: 4<br>LOB: 2<br>BB: 1<br>P: 13 | R: 0<br>E: 0<br>K: 0<br>S: 3 | H: 0<br>LOB: 0<br>BB: 0<br>P: 3 | R: 1<br>E: 0<br>K: 0<br>S: 4 | H: 1<br>LOB: 0<br>BB: 0<br>P: 4 | R: 0<br>E: 0<br>K: 0<br>S: 3 | H: 0<br>LOB: 0<br>BB: 0<br>P: 3 | R: 1<br>E: 0<br>K: 1<br>S: 6 | H: 1<br>LOB: 1<br>BB: 1<br>P: 10 | R: 2<br>E: 0<br>K: 0<br>S: 6 | H: 3<br>LOB: 1<br>BB: 0<br>P: 6 | 1B: 7<br>2B: 2<br>3B: 2<br>HR: 4 | SF: 0<br>SAC: 0<br>DP: 1<br>HBP: 0 | WP: 0<br>PB: 0<br>SB: 0<br>CS: 1 | PA: 46 |
| <b>PITCHER</b>   | IP WLS BF H R ER SO BB IBB HBP BLK WP HR S P ERA WHIP |                                  |                              |                                 |                              |                                 |                              |                                  |                              |                                 |                              |                                 |                              |                                 |                              |                                  |                              |                                 |                                  |                                    |                                  |        |
| Howie Fox, R<br>ERA: 6.55<br>(1, 1)  | 0.2 L 9 4 6 6 0 2 0 0 0 0 0 0 7 15 81.00 9.000        |                                  |                              |                                 |                              |                                 |                              |                                  |                              |                                 |                              |                                 |                              |                                 |                              |                                  |                              |                                 |                                  |                                    |                                  |        |
| Frank Smith, R<br>ERA: 4.58<br>(1, 1)  | 3.0 14 5 3 3 2 2 0 0 0 0 0 2 16 24 9.00 2.333         |                                  |                              |                                 |                              |                                 |                              |                                  |                              |                                 |                              |                                 |                              |                                 |                              |                                  |                              |                                 |                                  |                                    |                                  |        |
| Johnny Hetki, R<br>ERA: 9.0<br>(4, 1)  | 5.1 23 5 4 4 2 2 0 0 0 0 0 2 25 33 6.75 1.312         |                                  |                              |                                 |                              |                                 |                              |                                  |                              |                                 |                              |                                 |                              |                                 |                              |                                  |                              |                                 |                                  |                                    |                                  |        |

**Boston Braves @ Cincinnati Reds**  
Crosley Field, Cincinnati, OH  
Fri May 05 1950, 3:33 AM EDT  
Att. 12,260 - Unknown

livebaseballscorecards.com

|     |    |
|-----|----|
| AB  | 40 |
| R   | 13 |
| H   | 14 |
| RBI | 12 |
| BB  | 6  |
| SO  | 4  |
| LOB | 14 |



**BOTTOM**

**Boston Braves @ Cincinnati Reds**  
 Crosley Field, Cincinnati, OH  
 Fri May 05 1950, 3:33 AM EDT  
 Att. 12,260 - Unknown

livebaseballscorecards.com

|            |           |
|------------|-----------|
| <b>AB</b>  | <b>31</b> |
| <b>R</b>   | <b>1</b>  |
| <b>H</b>   | <b>5</b>  |
| <b>RBI</b> | <b>1</b>  |
| <b>BB</b>  | <b>4</b>  |
| <b>SO</b>  | <b>9</b>  |
| <b>LOB</b> | <b>14</b> |



|       |        |
|-------|--------|
| WP: 0 | PA: 35 |
| PB: 0 | SB: 0  |
| CS: 0 |        |

AB R H RBI BB SO LOB

|   |   |   |   |   |   |   |
|---|---|---|---|---|---|---|
| 4 | 0 | 1 | 0 | 0 | 1 | 1 |
| 4 | 0 | 1 | 0 | 0 | 0 | 3 |
| 3 | 0 | 0 | 0 | 1 | 1 | 1 |
| 3 | 0 | 1 | 0 | 0 | 1 | 0 |
| 1 | 0 | 0 | 0 | 0 | 1 | 2 |
| 3 | 0 | 1 | 0 | 1 | 0 | 0 |
| 4 | 0 | 0 | 0 | 0 | 1 | 3 |
| 3 | 1 | 1 | 1 | 1 | 1 | 1 |
| 2 | 0 | 0 | 0 | 0 | 0 | 3 |
| 2 | 0 | 0 | 0 | 0 | 1 | 0 |
| 1 | 0 | 0 | 0 | 1 | 1 | 0 |

| Batter   | 1                     | 2 | 3                     | 4 | 5                  | 6 | 7 | 8                      | 9 |
|--|-----------------------|---|-----------------------|---|--------------------|---|---|------------------------|---|
| <b>Bobby Adams, R</b> (1, 4)<br>OBP: 0.386, SLG: 0.385     | 0-0<br>G6-4-3<br>1B   |   | 0-3<br>K              |   | 0-0<br>FC1-6       |   |   | 0-0<br>E5<br>BB        |   |
| <b>Peanuts Lowrey, R</b> (1, 7)<br>OBP: 0.304, SLG: 0.364  | 0-0<br>G6-4-3<br>1-2f |   | 0-0<br>2B             |   | 0-0<br>5-3         |   |   | 0-0<br>F8              |   |
| <b>Grady Hatton, L</b> (1, 5)<br>OBP: 0.333, SLG: 0.409    | 0-0<br>4-3            |   | 0-3<br>K              |   |                    |   |   | 4-0<br>F8<br>1-2<br>BB |   |
| <b>Walker Cooper, R</b> (1, 2)<br>OBP: 0.199, SLG: 0.243   |                       |   | 0-3<br>K<br>BB        |   | 0-0<br>1B<br>2B    |   |   | 0-0<br>F7              |   |
| <b>Johnny Pramesa, R</b> (8, PH)<br>OBP: 0.286, SLG: 0.857 |                       |   |                       |   |                    |   |   | 0-3<br>K               |   |
| <b>Bob Usher, R</b> (1, 8)<br>OBP: 0.304, SLG: 0.591       |                       |   | 4-0<br>BB             |   | 0-0<br>1B          |   |   | 0-0<br>4-3             |   |
| <b>Ted Kluszewski, L</b> (1, 3)<br>OBP: 0.278, SLG: 0.324  |                       |   | 0-3<br>K              |   | 0-0<br>1-3         |   |   | 0-0<br>F3              |   |
| <b>Ron Northey, L</b> (1, 9)<br>OBP: 0.391, SLG: 0.810     |                       |   | 4-0<br>BB             |   | 0-0<br>F5          |   |   | 0-0<br>HR              |   |
| <b>Virgil Stallcup, R</b> (1, 6)<br>OBP: 0.283, SLG: 0.326 |                       |   | 0-0<br>G6-4-3         |   | 0-0<br>6-3         |   |   | 0-3<br>K               |   |
| <b>Sammy Meeks, R</b> (7, PH)<br>OBP: 0.250, SLG: 0.250    |                       |   | 0-0<br>G6-4-3<br>1-2f |   | 4-0<br>FC1-6<br>BB |   |   | 0-0<br>K               |   |
| <b>Howie Fox, R</b> (1, 1)<br>OBP: 0.333, SLG: 0.333       |                       |   | 0-3<br>K              |   |                    |   |   |                        |   |
| <b>Frank Smith, R</b> (1, 1)<br>OBP: 0.250, SLG: 0.250     |                       |   |                       |   |                    |   |   |                        |   |
| <b>Johnny Hetki, R</b> (4, 1)                              |                       |   |                       |   |                    |   |   |                        |   |

| Inning Stats | R: 0 | H: 1 | E: 0 | K: 0 | S: 3 | LOB: 0 | BB: 0 | P: 3 | R: 0 | H: 0 | E: 1 | K: 2 | S: 7 | LOB: 2 | BB: 2 | P: 15 | R: 0 | H: 1 | E: 0 | K: 3 | S: 10 | LOB: 1 | BB: 0 | P: 10 | R: 0 | H: 2 | E: 0 | K: 0 | S: 4 | LOB: 1 | BB: 0 | P: 4 | R: 0 | H: 0 | E: 0 | K: 0 | S: 3 | LOB: 0 | BB: 0 | P: 3 | R: 0 | H: 0 | E: 0 | K: 1 | S: 5 | LOB: 0 | BB: 0 | P: 5 | R: 0 | H: 0 | E: 1 | K: 2 | S: 8 | LOB: 2 | BB: 1 | P: 12 | R: 1 | H: 1 | E: 0 | K: 1 | S: 6 | LOB: 0 | BB: 0 | P: 6 | 1B: 2 | 2B: 2 | 3B: 0 | HR: 1 | SF: 0 | SAC: 0 | DP: 2 | HBP: 0 | WP: 0 | PA: 35 |
|--------------|------|------|------|------|------|--------|-------|------|------|------|------|------|------|--------|-------|-------|------|------|------|------|-------|--------|-------|-------|------|------|------|------|------|--------|-------|------|------|------|------|------|------|--------|-------|------|------|------|------|------|------|--------|-------|------|------|------|------|------|------|--------|-------|-------|------|------|------|------|------|--------|-------|------|-------|-------|-------|-------|-------|--------|-------|--------|-------|--------|
|--------------|------|------|------|------|------|--------|-------|------|------|------|------|------|------|--------|-------|-------|------|------|------|------|-------|--------|-------|-------|------|------|------|------|------|--------|-------|------|------|------|------|------|------|--------|-------|------|------|------|------|------|------|--------|-------|------|------|------|------|------|------|--------|-------|-------|------|------|------|------|------|--------|-------|------|-------|-------|-------|-------|-------|--------|-------|--------|-------|--------|

| PITCHER                                    | IP  | WLS | BF | H | R | ER | SO | BB | IBB | HBP | BLK | WP | HR | S  | P  | ERA  | WHIP  |
|--|-----|-----|----|---|---|----|----|----|-----|-----|-----|----|----|----|----|------|-------|
| <b>Warren Spahn, L</b> (1, 1)<br>ERA: 2.89 | 9.0 | W   | 35 | 5 | 1 | 1  | 9  | 4  | 0   | 0   | 0   | 0  | 1  | 49 | 65 | 1.00 | 1.000 |

| Batter   | 1                            | 2                                | 3                                 | 4                               | 5                             | 6                               | 7                            | 8                                | 9                            | AB R H RBI BB SO LOB   | TOP                          |                                 |                              |                                  |                              |                                  |                              |                                 |                                   |                                    |                                  |        |  |  |  |  |  |    |     |    |   |   |    |    |    |     |     |     |    |    |   |   |     |      |  |  |  |  |  |  |  |  |
|--|------------------------------|----------------------------------|-----------------------------------|---------------------------------|-------------------------------|---------------------------------|------------------------------|----------------------------------|------------------------------|--|------------------------------|---------------------------------|------------------------------|----------------------------------|------------------------------|----------------------------------|------------------------------|---------------------------------|-----------------------------------|------------------------------------|----------------------------------|--------|--|--|--|--|--|----|-----|----|---|---|----|----|----|-----|-----|-----|----|----|---|---|-----|------|--|--|--|--|--|--|--|--|
| Sam Jethroe, S<br>OBP: 0.424, SLG: 0.632 (1, 8)<br>BB<br>BB  | 4-0<br>S<br>1B<br>BB         | 0-0<br>HR<br>3B                  |                                   | 0-3<br>K<br>1B                  | 0-0<br>E<br>1B                |                                 | 0-0<br>FC5<br>BB<br>1B       |                                  | 0-0<br>E<br>1B               | 5 3 4 1 1 1 0  |                              |                                 |                              |                                  |                              |                                  |                              |                                 |                                   |                                    |                                  |        |  |  |  |  |  |    |     |    |   |   |    |    |    |     |     |     |    |    |   |   |     |      |  |  |  |  |  |  |  |  |
| Earl Torgeson, L<br>OBP: 0.423, SLG: 0.429 (1, 3)<br>X   | 0-0<br>F8<br>1-2             | 0-0<br>HR                        |                                   | 0-0<br>HR<br>1B                 | 0-0<br>E6<br>1-3<br>3-H<br>1B |                                 | 0-3<br>K<br>2                |                                  | 0-0<br>G4-6-3<br>1B<br>1-H   | 6 2 3 4 0 1 4  |                              |                                 |                              |                                  |                              |                                  |                              |                                 |                                   |                                    |                                  |        |  |  |  |  |  |    |     |    |   |   |    |    |    |     |     |     |    |    |   |   |     |      |  |  |  |  |  |  |  |  |
| Bob Elliott, R<br>OBP: 0.329, SLG: 0.514 (1, 5)<br>X   | 0-0<br>HR<br>1B<br>2-H       | 0-0<br>5-3                       |                                   | 0-0<br>HR<br>1B<br>1-H          | 0-0<br>1-3                    |                                 | 4-0<br>BB<br>1-2<br>2-3      |                                  | 0-0<br>G4-6-3<br>1-2f        | 5 2 2 3 1 0 2  |                              |                                 |                              |                                  |                              |                                  |                              |                                 |                                   |                                    |                                  |        |  |  |  |  |  |    |     |    |   |   |    |    |    |     |     |     |    |    |   |   |     |      |  |  |  |  |  |  |  |  |
| Sid Gordon, R<br>OBP: 0.379, SLG: 0.574 (1, 7)<br>Pete Reiser, L<br>OBP: 0.389, SLG: 0.467 (5, PH)<br>(5, 7)<br>Luis Olmo, R<br>OBP: 0.400, SLG: 1.000 (6, 7)  | 0-0<br>HR<br>1-H             | 0-0<br>6-3                       |                                   | 4-0<br>HR<br>BB<br>1-H          | 0-3<br>K<br>3                 |                                 | 0-0<br>FC5<br>2-3f           |                                  | 0-0<br>HR                    | 2 2 1 2 1 0 0<br>1 0 0 0 0 1 1<br>2 1 1 1 0 0 3                  |                              |                                 |                              |                                  |                              |                                  |                              |                                 |                                   |                                    |                                  |        |  |  |  |  |  |    |     |    |   |   |    |    |    |     |     |     |    |    |   |   |     |      |  |  |  |  |  |  |  |  |
| Willard Marshall, L<br>OBP: 0.325, SLG: 0.378 (1, 9)<br>X  | 0-0<br>4-3                   |                                  | 0-0<br>5-3<br>1B<br>1B            | 0-0<br>HR<br>1-H                |                               | 0-0<br>5-3                      |                              | 0-0<br>4-3                       | 1-0<br>BLK<br>HBP            | 5 2 2 2 0 0 0  |                              |                                 |                              |                                  |                              |                                  |                              |                                 |                                   |                                    |                                  |        |  |  |  |  |  |    |     |    |   |   |    |    |    |     |     |     |    |    |   |   |     |      |  |  |  |  |  |  |  |  |
| Connie Ryan, R<br>OBP: 0.354, SLG: 0.385 (1, 4)<br>X   | 0-0<br>E<br>1B               |                                  | 0-0<br>5-3<br>1B<br>1B            | 0-0<br>5-3                      |                               | 0-0<br>6-3                      |                              | 4-0<br>WP<br>BB                  | 1-0<br>HBP<br>1-2            | 4 1 2 0 1 0 0  |                              |                                 |                              |                                  |                              |                                  |                              |                                 |                                   |                                    |                                  |        |  |  |  |  |  |    |     |    |   |   |    |    |    |     |     |     |    |    |   |   |     |      |  |  |  |  |  |  |  |  |
| Paul Burris, R<br>OBP: 0.125, SLG: 0.125 (1, 2)<br>Del Crandall, R<br>OBP: 0.273, SLG: 0.262 (6, 2)<br>X   | 0-0<br>E6<br>1-2             |                                  | 0-0<br>5-3<br>1-2<br>2-3          | 0-0<br>5-3                      |                               | 0-0<br>F9                       |                              | 0-0<br>F6<br>1-2                 | 0-3<br>K<br>3                | 4 0 0 0 0 0 3<br>2 0 0 0 0 1 3                                   |                              |                                 |                              |                                  |                              |                                  |                              |                                 |                                   |                                    |                                  |        |  |  |  |  |  |    |     |    |   |   |    |    |    |     |     |     |    |    |   |   |     |      |  |  |  |  |  |  |  |  |
| Buddy Kerr, R<br>OBP: 0.288, SLG: 0.379 (1, 6)<br>X  | 0-0<br>F9                    |                                  | 0-0<br>G1-6-3<br>1B<br>2-H<br>3-H |                                 | 0-0<br>1B<br>1B<br>2B         |                                 | 0-0<br>F7                    | 4-0<br>IBB                       |                              | 4 1 2 2 1 0 2  |                              |                                 |                              |                                  |                              |                                  |                              |                                 |                                   |                                    |                                  |        |  |  |  |  |  |    |     |    |   |   |    |    |    |     |     |     |    |    |   |   |     |      |  |  |  |  |  |  |  |  |
| Normie Roy, R<br>OBP: 0.111, SLG: 0.111 (1, 1)<br>Johnny Antonelli, L<br>OBP: 0.500, SLG: 0.500 (6, 1)<br>Roy Hartsfield, R<br>OBP: 0.500, SLG: 0.500 (7, PH)<br>Bob Chipman, L<br>OBP: 0.500, SLG: 0.500 (7, 1) |                              | 0-0<br>4-3                       | 0-0<br>G1-6-3<br>1-2f             |                                 | 0-0<br>1B<br>E<br>1B<br>2-3   |                                 | 0-0<br>BB<br>1B<br>1B        | 0-0<br>F8                        |                              | 3 1 1 0 0 0 1<br>0 0 0 0 0 0 0<br>1 0 1 0 0 0 0<br>1 0 0 0 0 0 2 |                              |                                 |                              |                                  |                              |                                  |                              |                                 |                                   |                                    |                                  |        |  |  |  |  |  |    |     |    |   |   |    |    |    |     |     |     |    |    |   |   |     |      |  |  |  |  |  |  |  |  |
| Inning Stats   | R: 3<br>E: 1<br>K: 0<br>S: 7 | H: 3<br>LOB: 2<br>BB: 1<br>P: 11 | R: 2<br>E: 0<br>K: 0<br>S: 5      | H: 2<br>LOB: 0<br>BB: 0<br>P: 5 | R: 2<br>E: 0<br>K: 0<br>S: 5  | H: 3<br>LOB: 0<br>BB: 0<br>P: 5 | R: 4<br>E: 0<br>K: 1<br>S: 8 | H: 3<br>LOB: 0<br>BB: 1<br>P: 12 | R: 2<br>E: 1<br>K: 1<br>S: 8 | H: 3<br>LOB: 1<br>BB: 0<br>P: 8                                  | R: 0<br>E: 0<br>K: 0<br>S: 3 | H: 0<br>LOB: 0<br>BB: 0<br>P: 3 | R: 0<br>E: 0<br>K: 1<br>S: 7 | H: 2<br>LOB: 3<br>BB: 1<br>P: 11 | R: 0<br>E: 0<br>K: 0<br>S: 3 | H: 0<br>LOB: 2<br>BB: 2<br>P: 11 | R: 2<br>E: 1<br>K: 1<br>S: 7 | H: 3<br>LOB: 2<br>BB: 0<br>P: 9 | 1B: 12<br>2B: 1<br>3B: 1<br>HR: 5 | SF: 0<br>SAC: 0<br>DP: 2<br>HBP: 2 | WP: 1<br>PB: 0<br>SB: 1<br>CS: 0 | PA: 52 |  |  |  |  |  |    |     |    |   |   |    |    |    |     |     |     |    |    |   |   |     |      |  |  |  |  |  |  |  |  |
| PITCHER  | IP                           | WLS                              | BF                                | H                               | R                             | ER                              | SO                           | BB                               | IBB                          | HBP  | BLK                          | WP                              | HR                           | S                                | P                            | ERA                              | WHIP                         | PITCHER                         |                                   |                                    |                                  |        |  |  |  |  |  | IP | WLS | BF | H | R | ER | SO | BB | IBB | HBP | BLK | WP | HR | S | P | ERA | WHIP |  |  |  |  |  |  |  |  |
| Ken Raffensberger, L<br>ERA: 6.1 (1, 1)  | 2.0                          | L                                | 15                                | 7                               | 7                             | 7                               | 0                            | 1                                | 0                            | 0  | 0                            | 0                               | 2                            | 14                               | 18                           | 31.50                            | 4.000                        |                                 |                                   |                                    |                                  |        |  |  |  |  |  |    |     |    |   |   |    |    |    |     |     |     |    |    |   |   |     |      |  |  |  |  |  |  |  |  |
| Harry Perkowski, L<br>ERA: 13.5 (3, 1)   | 1.1                          |                                  | 8                                 | 4                               | 4                             | 4                               | 1                            | 1                                | 0                            | 0  | 0                            | 0                               | 2                            | 9                                | 13                           | 27.00                            | 3.750                        |                                 |                                   |                                    |                                  |        |  |  |  |  |  |    |     |    |   |   |    |    |    |     |     |     |    |    |   |   |     |      |  |  |  |  |  |  |  |  |
| Jay Avrea, R<br>ERA: 3.38 (4, 1)   | 2.2                          |                                  | 11                                | 3                               | 2                             | 2                               | 1                            | 0                                | 0                            | 0  | 0                            | 0                               | 0                            | 13                               | 13                           | 6.75                             | 1.125                        |                                 |                                   |                                    |                                  |        |  |  |  |  |  |    |     |    |   |   |    |    |    |     |     |     |    |    |   |   |     |      |  |  |  |  |  |  |  |  |
| Kent Peterson, L<br>ERA: 10.0 (7, 1)   | 2.0                          |                                  | 11                                | 2                               | 0                             | 0                               | 1                            | 2                                | 1                            | 0  | 0                            | 1                               | 0                            | 10                               | 22                           | 0.00                             | 2.000                        |                                 |                                   |                                    |                                  |        |  |  |  |  |  |    |     |    |   |   |    |    |    |     |     |     |    |    |   |   |     |      |  |  |  |  |  |  |  |  |
| Eddie Erault, R<br>ERA: 7.43 (9, 1)  | 1.0                          |                                  | 7                                 | 3                               | 2                             | 2                               | 1                            | 0                                | 0                            | 2  | 1                            | 0                               | 1                            | 7                                | 9                            | 18.00                            | 3.000                        |                                 |                                   |                                    |                                  |        |  |  |  |  |  |    |     |    |   |   |    |    |    |     |     |     |    |    |   |   |     |      |  |  |  |  |  |  |  |  |

**Boston Braves @ Cincinnati Reds**  
Crosley Field, Cincinnati, OH  
Sat May 06 1950, 3:33 AM EDT  
Att. 3,328 - Unknown

[livebaseballscorecards.com](http://livebaseballscorecards.com)

AB 45  
R 15  
H 19  
RBI 15  
BB 5  
SO 4  
LOB 21



**BOTTOM**

**Boston Braves @ Cincinnati Reds**  
 Crosley Field, Cincinnati, OH  
 Sat May 06 1950, 3:33 AM EDT  
 Att. 3,328 - Unknown

| Batter   | 1           | 2   | 3           | 4  | 5   | 6              | 7   | 8        | 9 |
|--|-------------|-----|-------------|----|-----|----------------|-----|----------|---|
| Bobby Adams, R (1, 4)<br>OBP: 0.388, SLG: 0.432  | F8          |     | FC5-4       |    | HR  | F9             |     | 4-3      |   |
| Lloyd Merriman, L (1, 8)<br>OBP: 0.417, SLG: 0.429   | BLK<br>1B   |     | G4-6-3      |    | L3  | HBP            |     | F7       |   |
| Grady Hatton, L (1, 5)<br>OBP: 0.358, SLG: 0.490   | FC6-4<br>1B |     |             | 2B | HR  | F9             |     | 3-1      |   |
| Ron Northey, L (1, 9)<br>OBP: 0.357, SLG: 0.808  | FC6-4       |     |             | F7 | HR  | F9             |     | F8       |   |
| Johnny Wyrostek, L (1, 7)<br>OBP: 0.368, SLG: 0.451  | F8          |     |             | 2B | 2B  |                | L4  | 1B       |   |
| Ted Kluszewski, L (1, 3)<br>OBP: 0.268, SLG: 0.333   |             | 4-3 |             | 2B | 1-3 |                | F2  | F7       |   |
| Virgil Stallcup, R (1, 6)<br>OBP: 0.271, SLG: 0.311<br>Sammy Meeks, R (6, 6)   |             | F8  |             | F2 |     | G3             | 1-3 | K        |   |
| Dixie Howell, R (1, 2)<br>OBP: 0.214, SLG: 0.231   |             | F9  |             | F9 |     | E<br>2B        |     | E6<br>HR |   |
| Ken Raffensberger, R (1, 1)<br>OBP: 0.187, SLG: 0.167<br>Harry Perkowski, L (3, 1)<br>OBP: 1.000, SLG: 1.000<br>Jay Arrighi, R (4, 1)<br>Walker Cooper, R (6, PH)<br>OBP: 0.211, SLG: 0.263<br>Kent Peterson, R (7, 1)<br>OBP: 0.600, SLG: 0.500<br>Bob Usher, R (8, PH)<br>OBP: 0.533, SLG: 0.739<br>Eddie Eruitt, R (9, 1) |             |     | FC5-4<br>1B |    | K   | E9<br>3B<br>1B |     | HR       |   |

|                   | AB | R | H | RBI | BB | SO | LOB |
|-------------------|----|---|---|-----|----|----|-----|
| Bobby Adams       | 5  | 2 | 2 | 1   | 0  | 0  | 1   |
| Lloyd Merriman    | 4  | 1 | 1 | 0   | 0  | 0  | 2   |
| Grady Hatton      | 5  | 2 | 3 | 4   | 0  | 0  | 1   |
| Ron Northey       | 5  | 1 | 1 | 1   | 0  | 0  | 3   |
| Johnny Wyrostek   | 5  | 1 | 3 | 1   | 0  | 0  | 1   |
| Ted Kluszewski    | 5  | 0 | 1 | 1   | 0  | 0  | 2   |
| Virgil Stallcup   | 2  | 0 | 0 | 0   | 0  | 0  | 1   |
| Sammy Meeks       | 3  | 0 | 0 | 0   | 0  | 0  | 1   |
| Dixie Howell      | 4  | 2 | 1 | 0   | 0  | 0  | 1   |
| Ken Raffensberger | 0  | 0 | 0 | 0   | 0  | 0  | 0   |
| Harry Perkowski   | 1  | 0 | 1 | 0   | 0  | 0  | 0   |
| Jay Arrighi       | 1  | 0 | 0 | 0   | 0  | 1  | 0   |
| Walker Cooper     | 1  | 1 | 1 | 0   | 0  | 0  | 0   |
| Kent Peterson     | 0  | 0 | 0 | 0   | 0  | 0  | 0   |
| Bob Usher         | 0  | 0 | 0 | 0   | 0  | 0  | 0   |
| Eddie Eruitt      | 0  | 1 | 1 | 2   | 0  | 0  | 0   |
| Eddie Eruitt      | 0  | 0 | 0 | 0   | 0  | 0  | 0   |

| Inning Stats | R | H | E | K | S | R | H | E | K | S | R | H | E | K | S | R | H | E | K | S | R | H | E | K | S | R | H | E | K | S | 1B | 2B | 3B | HR | SF | SAC | DP | HBP | WP | HR | S | P | ERA | WHIP |   |   |   |   |   |   |   |   |   |   |   |
|--------------|---|---|---|---|---|---|---|---|---|---|---|---|---|---|---|---|---|---|---|---|---|---|---|---|---|---|---|---|---|---|----|----|----|----|----|-----|----|-----|----|----|---|---|-----|------|---|---|---|---|---|---|---|---|---|---|---|
| 1            | 1 | 2 | 0 | 0 | 5 | 0 | 0 | 0 | 3 | 3 | 0 | 0 | 0 | 0 | 0 | 0 | 0 | 0 | 0 | 0 | 0 | 0 | 0 | 0 | 0 | 0 | 0 | 0 | 0 | 0 | 0  | 0  | 0  | 0  | 0  | 0   | 0  | 0   | 0  | 0  | 0 | 0 | 0   | 0    | 0 | 0 | 0 | 0 |   |   |   |   |   |   |   |
| 2            | 0 | 0 | 0 | 0 | 3 | 0 | 0 | 0 | 0 | 0 | 0 | 0 | 0 | 0 | 0 | 0 | 0 | 0 | 0 | 0 | 0 | 0 | 0 | 0 | 0 | 0 | 0 | 0 | 0 | 0 | 0  | 0  | 0  | 0  | 0  | 0   | 0  | 0   | 0  | 0  | 0 | 0 | 0   | 0    | 0 | 0 | 0 | 0 | 0 | 0 |   |   |   |   |   |
| 3            | 0 | 1 | 0 | 0 | 3 | 0 | 0 | 0 | 0 | 0 | 0 | 0 | 0 | 0 | 0 | 0 | 0 | 0 | 0 | 0 | 0 | 0 | 0 | 0 | 0 | 0 | 0 | 0 | 0 | 0 | 0  | 0  | 0  | 0  | 0  | 0   | 0  | 0   | 0  | 0  | 0 | 0 | 0   | 0    | 0 | 0 | 0 | 0 | 0 | 0 |   |   |   |   |   |
| 4            | 2 | 3 | 0 | 0 | 6 | 0 | 0 | 0 | 0 | 0 | 0 | 0 | 0 | 0 | 0 | 0 | 0 | 0 | 0 | 0 | 0 | 0 | 0 | 0 | 0 | 0 | 0 | 0 | 0 | 0 | 0  | 0  | 0  | 0  | 0  | 0   | 0  | 0   | 0  | 0  | 0 | 0 | 0   | 0    | 0 | 0 | 0 | 0 | 0 | 0 | 0 | 0 |   |   |   |
| 5            | 3 | 4 | 0 | 1 | 9 | 0 | 0 | 0 | 1 | 0 | 0 | 0 | 0 | 0 | 0 | 0 | 0 | 0 | 0 | 0 | 0 | 0 | 0 | 0 | 0 | 0 | 0 | 0 | 0 | 0 | 0  | 0  | 0  | 0  | 0  | 0   | 0  | 0   | 0  | 0  | 0 | 0 | 0   | 0    | 0 | 0 | 0 | 0 | 0 | 0 | 0 | 0 |   |   |   |
| 6            | 2 | 3 | 0 | 0 | 6 | 0 | 0 | 0 | 0 | 0 | 0 | 0 | 0 | 0 | 0 | 0 | 0 | 0 | 0 | 0 | 0 | 0 | 0 | 0 | 0 | 0 | 0 | 0 | 0 | 0 | 0  | 0  | 0  | 0  | 0  | 0   | 0  | 0   | 0  | 0  | 0 | 0 | 0   | 0    | 0 | 0 | 0 | 0 | 0 | 0 | 0 | 0 | 0 | 0 | 0 |
| 7            | 0 | 0 | 0 | 0 | 3 | 0 | 0 | 0 | 0 | 0 | 0 | 0 | 0 | 0 | 0 | 0 | 0 | 0 | 0 | 0 | 0 | 0 | 0 | 0 | 0 | 0 | 0 | 0 | 0 | 0 | 0  | 0  | 0  | 0  | 0  | 0   | 0  | 0   | 0  | 0  | 0 | 0 | 0   | 0    | 0 | 0 | 0 | 0 | 0 | 0 | 0 | 0 | 0 | 0 | 0 |
| 8            | 2 | 1 | 1 | 0 | 5 | 0 | 0 | 0 | 0 | 0 | 0 | 0 | 0 | 0 | 0 | 0 | 0 | 0 | 0 | 0 | 0 | 0 | 0 | 0 | 0 | 0 | 0 | 0 | 0 | 0 | 0  | 0  | 0  | 0  | 0  | 0   | 0  | 0   | 0  | 0  | 0 | 0 | 0   | 0    | 0 | 0 | 0 | 0 | 0 | 0 | 0 | 0 | 0 | 0 | 0 |
| 9            | 0 | 1 | 0 | 1 | 6 | 0 | 0 | 0 | 1 | 0 | 0 | 0 | 0 | 0 | 0 | 0 | 0 | 0 | 0 | 0 | 0 | 0 | 0 | 0 | 0 | 0 | 0 | 0 | 0 | 0 | 0  | 0  | 0  | 0  | 0  | 0   | 0  | 0   | 0  | 0  | 0 | 0 | 0   | 0    | 0 | 0 | 0 | 0 | 0 | 0 | 0 | 0 | 0 | 0 | 0 |

|  | IP  | WLS | BF | H  | R | ER | SO | BB | IBB | HBP | BLK | WP | HR | S  | P  | ERA   | WHIP  |
|--|-----|-----|----|----|---|----|----|----|-----|-----|-----|----|----|----|----|-------|-------|
| <b>PITCHER</b><br>Normie Roy, R (1, 1)<br>ERA: 4.5 | 5.0 | W   | 24 | 10 | 6 | 6  | 1  | 0  | 0   | 0   | 1   | 0  | 2  | 26 | 26 | 10.80 | 2.000 |
| Johnny Antonelli, L (6, 1)<br>ERA: 33.75           | 1.0 |     | 7  | 3  | 3 | 3  | 0  | 0  | 0   | 1   | 0   | 0  | 0  | 6  | 7  | 27.00 | 3.000 |
| Bob Chipman, L (7, 1)<br>ERA: 3.24                 | 3.0 | S   | 12 | 2  | 2 | 1  | 1  | 0  | 0   | 0   | 0   | 0  | 1  | 14 | 14 | 3.00  | 0.667 |

livebaseballscorecards.com

|            |    |
|------------|----|
| <b>AB</b>  | 42 |
| <b>R</b>   | 11 |
| <b>H</b>   | 15 |
| <b>RBI</b> | 10 |
| <b>BB</b>  | 0  |
| <b>SO</b>  | 2  |
| <b>LOB</b> | 13 |



| Batter  | 1   | 2  | 3   | 4   | 5   | 6   | 7  | 8   | 9   | AB R H RBI BB SO LOB                                       | TOP                                     |  |
|---|---|--|---|---|---|---|--|---|---|--|---|--|
| Richie Ashburn, L (1, 8)<br>OBP: 0.431, SLG: 0.354  | 0-0<br>G6-4-3<br>1B                                   | 0-0<br>FC4-6   |   |   | 0-3<br>K  | 0-0<br>F8   |  | 0-0<br>4-3  |   | 5 0 1 0 0 1 4  |   |  |
| Granny Hamner, R (1, 6)<br>OBP: 0.349, SLG: 0.364   | 0-0<br>G6-4-3<br>1-2f                                 |  | 4-0<br>HR<br>BB                                     |   | 0-0<br>F3   |   | 0-0<br>1B<br>F7<br>1B                                | 0-0<br>6-3  |   | 4 2 1 0 1 0 1  |   |  |
| Eddie Waitkus, L (1, 3)<br>OBP: 0.395, SLG: 0.403   | 4-0<br>BB   |  | 0-0<br>HR   |   | 0-0<br>1B   |   | 0-0<br>1B<br>BB<br>1B                                |   | 0-0<br>F8   | 4 2 3 2 1 0 0  |   |  |
| Del Ennis, R (1, 9)<br>OBP: 0.365, SLG: 0.525   | 0-3<br>K  |  | 0-0<br>F5   |   | 0-3<br>K  |   | 0-0<br>F7  |   | 0-0<br>F9   | 5 0 0 1 0 2 3  |   |  |
| Willie Jones, R (1, 5)<br>OBP: 0.392, SLG: 0.634<br>Putsy Caballero, R (7, 5)<br>OBP: 0.250, SLG: 0.143 |   | 0-3<br>K   | 0-0<br>3-1  |   | 4-0<br>2B<br>BB                                     |   | 4-0<br>1B<br>BB                                      |   | 0-0<br>1B   | 2 0 0 0 2 1 0<br>1 0 1 0 0 0 0                             |   |  |
| Dick Sister, L (1, 7)<br>OBP: 0.481, SLG: 0.606   |   | 0-0<br>HR  | 0-0<br>F8   |   | 0-0<br>E<br>FC6-4<br>2B                             |   | 0-0<br>F7  |   | 0-0<br>4-3  | 5 2 2 1 0 0 3  |   |  |
| Mike Goliat, R (1, 4)<br>OBP: 0.329, SLG: 0.347   |   | 0-0<br>PB<br>1B                                      |   | 0-0<br>G4-6-3<br>1B                                 |   | 0-0<br>E1<br>FC6-4<br>FC                            |  | 0-0<br>1-2<br>2-H<br>1B                             |   | 4 0 3 1 0 0 1  |   |  |
| Stan Lopata, R (1, 2)<br>OBP: 0.339, SLG: 0.260   |   | 4-0<br>FC4-6<br>BB                                   |   | 0-0<br>G4-6-3                                       |   | 0-0<br>FC<br>FC6-4                                  |  | 0-3<br>K  |   | 3 0 0 0 1 1 5  |   |  |
| Ken Heintzelman, R (1, 1)   |   | 0-3<br>K   |   | 0-3<br>K  |   | 0-0<br>FC6-4  |  | 0-0<br>P4   |   | 4 0 0 1 0 2 4  |   |  |
| <b>Inning Stats</b>   | R: 0 H: 1<br>E: 0 LOB: 1<br>K: 1 BB: 1<br>S: 5 P: 9   | R: 1 H: 2<br>E: 0 LOB: 2<br>K: 2 BB: 1<br>S: 9 P: 13 | R: 2 H: 1<br>E: 0 LOB: 0<br>K: 0 BB: 1<br>S: 4 P: 8 | R: 0 H: 1<br>E: 0 LOB: 0<br>K: 1 BB: 0<br>S: 5 P: 5 | R: 0 H: 1<br>E: 0 LOB: 1<br>K: 2 BB: 0<br>S: 8 P: 8 | R: 1 H: 1<br>E: 1 LOB: 2<br>K: 0 BB: 1<br>S: 5 P: 9 | R: 2 H: 3<br>E: 0 LOB: 2<br>K: 1 BB: 1<br>S: 8 P: 12 | R: 0 H: 0<br>E: 0 LOB: 0<br>K: 0 BB: 0<br>S: 3 P: 3 | R: 0 H: 1<br>E: 0 LOB: 1<br>K: 0 BB: 0<br>S: 4 P: 4 | 1B: 8 SF: 0<br>2B: 1 SAC: 0<br>3B: 0 DP: 2<br>HR: 2 HBP: 0 | WP: 0 PA: 42<br>PB: 1<br>SB: 0<br>CS: 0 |  |
| <b>PITCHER</b>  | IP WLS BF H R ER SO BB IBB HBP BLK WP HR S P ERA WHIP |  |   |   |   |   |  |   |   |  |   |  |
| Howie Fox, R (1, 1)<br>ERA: 7.41  | 6.0 L 30 9 6 6 6 4 0 0 0 0 0 2 38 54 9.00 2.167       |  |   |   |   |   |  |   |   |  |   |  |
| Frank Smith, R (7, 1)<br>ERA: 4.12  | 2.0 8 1 0 0 1 1 0 0 0 0 0 0 9 13 0.00 1.000           |  |   |   |   |   |  |   |   |  |   |  |
| Kent Peterson, L (9, 1)<br>ERA: 9.0   | 1.0 4 1 0 0 0 0 0 0 0 0 0 0 4 4 0.00 1.000            |  |   |   |   |   |  |   |   |  |   |  |

Philadelphia Phillies @ Cincinnati Reds  
Crosley Field, Cincinnati, OH  
Sun May 07 1950, 3:33 AM EDT  
Unknown

|     |    |
|-----|----|
| AB  | 37 |
| R   | 6  |
| H   | 11 |
| RBI | 6  |
| BB  | 5  |
| SO  | 7  |
| LOB | 21 |



livebaseballscorecards.com

| Batter  | 1                            | 2                               | 3                            | 4                               | 5                            | 6                               | 7                            | 8                               | 9                            | AB                              | R                            | H                               | RBI                          | BB                              | SO                           | LOB                              | BOTTOM   |                                 |                                  |                                    |                                  |        |
|---|------------------------------|---------------------------------|------------------------------|---------------------------------|------------------------------|---------------------------------|------------------------------|---------------------------------|------------------------------|---------------------------------|------------------------------|---------------------------------|------------------------------|---------------------------------|------------------------------|----------------------------------|--|---------------------------------|----------------------------------|------------------------------------|----------------------------------|--------|
| Bobby Adams, R (1, 4)<br>OBP: 0.358, SLG: 0.396     | 0-0<br>5-3                   |                                 | 0-0<br>F8                    |                                 | 0-0<br>F9                    |                                 |                              | 0-0<br>FC4<br>BB<br>1-2f        |                              | 4                               | 0                            | 0                               | 0                            | 0                               | 0                            | 1                                | <b>Philadelphia Phillies @ Cincinnati Reds</b><br>Crosley Field, Cincinnati, OH<br>Sun May 07 1950, 3:33 AM EDT<br>Unknown |                                 |                                  |                                    |                                  |        |
| Peanuts Lowrey, R (1, 7)<br>OBP: 0.370, SLG: 0.375  | 4-0<br>BLK<br>BB             |                                 | 0-0<br>1B<br>1B              |                                 |                              | 0-0<br>1-3                      |                              | 4-0<br>1-2<br>BB                |                              | 2                               | 0                            | 1                               | 0                            | 2                               | 0                            | 0                                |  |                                 |                                  |                                    |                                  |        |
| Grady Hatton, L (1, 5)<br>OBP: 0.351, SLG: 0.472    | 0-0<br>F9<br>1-2             |                                 | 0-0<br>1-2<br>1B             |                                 |                              | 0-0<br>F9                       |                              | 0-0<br>F9                       |                              | 4                               | 0                            | 1                               | 0                            | 0                               | 0                            | 3                                |  |                                 |                                  |                                    |                                  |        |
| Ron Northey, L (1, 9)<br>OBP: 0.344, SLG: 0.724     | 0-0<br>F5                    |                                 | 0-0<br>P5                    |                                 |                              | 0-0<br>F8                       |                              |                                 | 4-0<br>BB<br>G6-4-3          | 3                               | 0                            | 0                               | 0                            | 1                               | 0                            | 3                                |  |                                 |                                  |                                    |                                  |        |
| Walker Cooper, R (1, 2)<br>OBP: 0.190, SLG: 0.238   |                              | 0-0<br>5-3                      |                              | 0-0<br>6-3                      |                              |                                 | 0-0<br>P3                    |                                 | 0-0<br>F9                    | 4                               | 0                            | 0                               | 0                            | 0                               | 0                            | 1                                |  |                                 |                                  |                                    |                                  |        |
| Bob Usher, R (1, 8)<br>OBP: 0.321, SLG: 0.667       |                              | 0-0<br>F9                       |                              | 0-0<br>G4-6-3<br>1B             |                              | 0-3<br>K                        |                              | 0-0<br>G6-4-3<br>1-2f           |                              | 4                               | 0                            | 1                               | 0                            | 0                               | 1                            | 1                                |  |                                 |                                  |                                    |                                  |        |
| Ted Kluszewski, L (1, 3)<br>OBP: 0.250, SLG: 0.310  |                              | 0-0<br>E7                       |                              | 0-0<br>G4-6-3<br>1-2f           |                              | 0-0<br>4-3                      |                              |                                 |                              | 3                               | 0                            | 0                               | 0                            | 0                               | 0                            | 1                                |  |                                 |                                  |                                    |                                  |        |
| Virgil Stallcup, R (1, 6)<br>OBP: 0.255, SLG: 0.292 |                              | 0-0<br>P5                       |                              | 0-3<br>K                        |                              |                                 | 0-0<br>5-3                   |                                 |                              | 3                               | 0                            | 0                               | 0                            | 0                               | 1                            | 1                                |  |                                 |                                  |                                    |                                  |        |
| Howie Fox, R (1, 1)<br>OBP: 0.200, SLG: 0.200       |                              |                                 | 0-0<br>F7                    |                                 | 0-0<br>P5                    |                                 |                              | 4-0<br>FC4<br>BB                |                              | 2                               | 0                            | 0                               | 0                            | 0                               | 0                            | 0                                |  |                                 |                                  |                                    |                                  |        |
| Frank Smith, R (7, 1)<br>OBP: 0.250, SLG: 0.250     |                              |                                 |                              |                                 |                              |                                 |                              |                                 |                              | 0                               | 0                            | 0                               | 0                            | 0                               | 0                            | 0                                |  |                                 |                                  |                                    |                                  |        |
| Sammy Meeks, R (8, PH)                              |                              |                                 |                              |                                 |                              |                                 |                              |                                 |                              | 0                               | 0                            | 0                               | 0                            | 1                               | 0                            | 0                                |  |                                 |                                  |                                    |                                  |        |
| Kent Peterson, R (9, 1)<br>OBP: 0.500, SLG: 0.500   |                              |                                 |                              |                                 |                              |                                 |                              |                                 |                              | 0                               | 0                            | 0                               | 0                            | 0                               | 0                            | 0                                |  |                                 |                                  |                                    |                                  |        |
| <b>Inning Stats</b>                                 | R: 0<br>E: 0<br>K: 0<br>S: 3 | H: 0<br>LOB: 1<br>BB: 1<br>P: 7 | R: 0<br>E: 1<br>K: 0<br>S: 4 | H: 0<br>LOB: 1<br>BB: 0<br>P: 4 | R: 0<br>E: 0<br>K: 0<br>S: 5 | H: 2<br>LOB: 2<br>BB: 0<br>P: 5 | R: 0<br>E: 0<br>K: 0<br>S: 3 | H: 1<br>LOB: 0<br>BB: 0<br>P: 3 | R: 0<br>E: 0<br>K: 1<br>S: 5 | H: 0<br>LOB: 0<br>BB: 0<br>P: 5 | R: 0<br>E: 0<br>K: 1<br>S: 5 | H: 0<br>LOB: 0<br>BB: 0<br>P: 5 | R: 0<br>E: 0<br>K: 0<br>S: 3 | H: 0<br>LOB: 0<br>BB: 0<br>P: 5 | R: 0<br>E: 0<br>K: 1<br>S: 5 | H: 0<br>LOB: 2<br>BB: 2<br>P: 11 | R: 0<br>E: 0<br>K: 0<br>S: 2   | H: 0<br>LOB: 0<br>BB: 1<br>P: 6 | 1B: 3<br>2B: 0<br>3B: 0<br>HR: 0 | SF: 0<br>SAC: 0<br>DP: 2<br>HBP: 0 | WP: 0<br>PB: 0<br>SB: 0<br>CS: 0 | PA: 33 |
| PITCHER<br>Ken Heintzelman, L (1, 1)<br>ERA: 2.92   | IP<br>9.0                    | WLS<br>W                        | BF<br>33                     | H<br>3                          | R<br>0                       | ER<br>0                         | SO<br>2                      | BB<br>4                         | IBB<br>0                     | HBP<br>0                        | BLK<br>1                     | WP<br>0                         | HR<br>0                      | S<br>33                         | P<br>49                      | ERA<br>0.00                      | WHIP<br>0.778  |                                 |                                  |                                    |                                  |        |
|   |                              |                                 |                              |                                 |                              |                                 |                              |                                 |                              |                                 |                              |                                 |                              |                                 |                              |                                  | <b>PITCHER</b><br>IP WLS BF H R ER SO BB IBB HBP BLK WP HR S P ERA WHIP  |                                 |                                  |                                    |                                  |        |

|            |           |
|------------|-----------|
| <b>AB</b>  | <b>29</b> |
| <b>R</b>   | <b>0</b>  |
| <b>H</b>   | <b>3</b>  |
| <b>RBI</b> | <b>0</b>  |
| <b>BB</b>  | <b>4</b>  |
| <b>SO</b>  | <b>2</b>  |
| <b>LOB</b> | <b>11</b> |



|       |        |
|-------|--------|
| WP: 0 | PA: 33 |
| PB: 0 |        |
| SB: 0 |        |
| CS: 0 |        |

|     |      |
|-----|------|
| ERA | WHIP |
|     |      |

| Batter  | 1                            | 2                                       | 3                            | 4                                | 5                            | 6                               | 7                            | 8                               | 9                            | AB R H RBI BB SO LOB            | TOP                          |                                 |                              |                                 |                              |                                 |                              |                                  |                                  |                                    |                                  |        |  |  |
|---|------------------------------|---|------------------------------|----------------------------------|------------------------------|---------------------------------|------------------------------|---------------------------------|------------------------------|---------------------------------|------------------------------|---------------------------------|------------------------------|---------------------------------|------------------------------|---------------------------------|------------------------------|----------------------------------|----------------------------------|------------------------------------|----------------------------------|--------|--|--|
| <b>Richie Ashburn, L</b><br>OBP: 0.429, SLG: 0.346 (1, 8) X | 0-0<br>WP S<br>2B<br>1B      | 4-0<br>FC4-6<br>1B<br>1-2<br>2-3<br>3-H |                              | 0-0<br>F7                        |                              |                                 | 0-0<br>F8                    |                                 | 0-0<br>F7                    | 4 1 1 1 1 0 2                   |                              |                                 |                              |                                 |                              |                                 |                              |                                  |                                  |                                    |                                  |        |  |  |
| <b>Granny Hamner, R</b><br>OBP: 0.363, SLG: 0.390 (1, 6) X  | 0-0<br>F7                    | 0-0<br>FC4-6<br>1B                      |                              | 0-3<br>K                         |                              |                                 | 0-0<br>1B                    |                                 | 0-0<br>2B                    | 5 0 3 2 0 1 2                   |                              |                                 |                              |                                 |                              |                                 |                              |                                  |                                  |                                    |                                  |        |  |  |
| <b>Eddie Waitkus, L</b><br>OBP: 0.396, SLG: 0.407 (1, 3) X  | 0-0<br>2B                    | 0-0<br>FC4-6<br>FC5-4                   |                              |                                  |                              |                                 | 0-0<br>F7                    |                                 | 4-0<br>BB                    | 4 0 1 2 1 0 3                   |                              |                                 |                              |                                 |                              |                                 |                              |                                  |                                  |                                    |                                  |        |  |  |
| <b>Del Ennis, R</b><br>OBP: 0.356, SLG: 0.541 (1, 9) X      | 0-0<br>F7                    | 0-0<br>FC5-4                            |                              |                                  |                              |                                 | 0-0<br>5-3                   |                                 | 0-0<br>HR                    | 5 1 1 1 0 0 5                   |                              |                                 |                              |                                 |                              |                                 |                              |                                  |                                  |                                    |                                  |        |  |  |
| <b>Willie Jones, R</b><br>OBP: 0.373, SLG: 0.600 (1, 5) X   | 0-0<br>F9                    |   |                              | 0-0<br>1-3                       |                              |                                 | 0-3<br>K                     |                                 | 0-0<br>6-3                   | 4 0 0 0 0 1 1                   |                              |                                 |                              |                                 |                              |                                 |                              |                                  |                                  |                                    |                                  |        |  |  |
| <b>Putsy Caballero, R</b><br>OBP: 0.250, SLG: 0.143 (8, 5)  |                              |   |                              |                                  |                              |                                 |                              |                                 |                              | 0 0 0 0 0 0 0                   |                              |                                 |                              |                                 |                              |                                 |                              |                                  |                                  |                                    |                                  |        |  |  |
| <b>Dick Sister, L</b><br>OBP: 0.469, SLG: 0.586 (1, 7) X    |                              | 0-0<br>HBP BB<br>BB<br>1B               |                              | 0-0<br>F5                        |                              |                                 | 0-0<br>L3                    |                                 | 0-0<br>4-3                   | 4 1 1 0 0 0 0                   |                              |                                 |                              |                                 |                              |                                 |                              |                                  |                                  |                                    |                                  |        |  |  |
| <b>Mike Goliat, R</b><br>OBP: 0.325, SLG: 0.333 (1, 4) X    |                              | 4-0<br>BB HBP<br>1B<br>BB               |                              | 0-3<br>K                         |                              |                                 | 0-0<br>4-3                   |                                 | 0-0<br>P3                    | 3 1 0 0 1 1 0                   |                              |                                 |                              |                                 |                              |                                 |                              |                                  |                                  |                                    |                                  |        |  |  |
| <b>Andy Seminick, R</b><br>OBP: 0.308, SLG: 0.364 (1, 2) X  |                              | 1-0<br>1B BB<br>FC4-6<br>HBP            |                              |                                  |                              |                                 | 0-0<br>F7                    |                                 | 4-0<br>FC3-6<br>BB           | 2 1 1 0 1 0 0                   |                              |                                 |                              |                                 |                              |                                 |                              |                                  |                                  |                                    |                                  |        |  |  |
| <b>Bubba Church, R</b><br>(1, 1)                            |                              | 0-3<br>K                                |                              |                                  |                              |                                 |                              |                                 | 0-0<br>FC3-6<br>2B           | 2 0 0 0 0 1 4                   |                              |                                 |                              |                                 |                              |                                 |                              |                                  |                                  |                                    |                                  |        |  |  |
| <b>Curt Simmons, L</b><br>OBP: 0.231, SLG: 0.167 (6, 1) X   |                              |   |                              | 0-0<br>F6                        |                              |                                 | 0-0<br>F7                    |                                 |                              | 2 1 0 0 0 0 1                   |                              |                                 |                              |                                 |                              |                                 |                              |                                  |                                  |                                    |                                  |        |  |  |
| <b>Inning Stats</b>   | R: 1<br>E: 0<br>K: 0<br>S: 5 | H: 2<br>LOB: 1<br>BB: 0<br>P: 5         | R: 3<br>E: 0<br>K: 1<br>S: 7 | H: 2<br>LOB: 2<br>BB: 2<br>P: 16 | R: 0<br>E: 0<br>K: 1<br>S: 5 | H: 0<br>LOB: 0<br>BB: 0<br>P: 5 | R: 0<br>E: 0<br>K: 1<br>S: 6 | H: 1<br>LOB: 1<br>BB: 0<br>P: 6 | R: 0<br>E: 0<br>K: 1<br>S: 5 | H: 0<br>LOB: 0<br>BB: 0<br>P: 5 | R: 0<br>E: 0<br>K: 0<br>S: 3 | H: 0<br>LOB: 0<br>BB: 0<br>P: 3 | R: 0<br>E: 0<br>K: 0<br>S: 4 | H: 1<br>LOB: 1<br>BB: 0<br>P: 4 | R: 1<br>E: 0<br>K: 0<br>S: 4 | H: 1<br>LOB: 0<br>BB: 0<br>P: 4 | R: 1<br>E: 0<br>K: 0<br>S: 4 | H: 1<br>LOB: 2<br>BB: 2<br>P: 12 | 1B: 4<br>2B: 3<br>3B: 0<br>HR: 1 | SF: 0<br>SAC: 0<br>DP: 0<br>HBP: 1 | WP: 1<br>PB: 0<br>SB: 1<br>CS: 0 | PA: 40 |  |  |
| <b>PITCHER</b>  | IP                           | WLS                                     | BF                           | H                                | R                            | ER                              | SO                           | BB                              | IBB                          | HBP                             | BLK                          | WP                              | HR                           | S                               | P                            | ERA                             | WHIP                         |                                  |                                  |                                    |                                  |        |  |  |
| <b>Ewell Blackwell, R</b><br>ERA: 2.45 (1, 1)               | 8.0                          | L                                       | 34                           | 7                                | 5                            | 5                               | 4                            | 2                               | 0                            | 1                               | 0                            | 1                               | 1                            | 39                              | 48                           | 5.62                            | 1.125                        |                                  |                                  |                                    |                                  |        |  |  |
| <b>Kent Peterson, L</b><br>ERA: 9.28 (9, 1)                 | 0.2                          |   | 5                            | 1                                | 1                            | 1                               | 0                            | 2                               | 0                            | 0                               | 0                            | 0                               | 0                            | 3                               | 11                           | 13.50                           | 4.500                        |                                  |                                  |                                    |                                  |        |  |  |
| <b>Johnny Hetki, R</b><br>ERA: 8.74 (9, 1)                  | 0.1                          |   | 1                            | 0                                | 0                            | 0                               | 0                            | 0                               | 0                            | 0                               | 0                            | 0                               | 0                            | 1                               | 1                            | 0.00                            | 0.000                        |                                  |                                  |                                    |                                  |        |  |  |

Philadelphia Phillies @ Cincinnati Reds  
Crosley Field, Cincinnati, OH  
Sun May 07 1950, 3:38 AM EDT  
Att. 13,313 - Unknown

livebaseballscorecards.com

|     |    |
|-----|----|
| AB  | 35 |
| R   | 6  |
| H   | 8  |
| RBI | 6  |
| BB  | 4  |
| SO  | 4  |
| LOB | 18 |





| Batter   | 1          | 2         | 3             | 4             | 5            | 6             | 7          | 8         | 9             | AB R H RBI BB SO LOB   |
|--|------------|-----------|---------------|---------------|--------------|---------------|------------|-----------|---------------|--|
| <b>Bobby Adams, R</b> (1, 4)<br>OBP: 0.379, SLG: 0.392   | 0-0<br>5-3 |           | 0-0<br>F7     |               | 4-0<br>HR BB | 0-0<br>2-6 1B |            |           | 4-0<br>4-3 BB | 3 1 1 1 2 0 1  |
| <b>Lloyd Merriman, L</b> (1, 8)<br>OBP: 0.393, SLG: 0.400<br><b>Bob Usher, R</b> (9, PH)<br>OBP: 0.310, SLG: 0.643   | 0-0<br>1-3 |           | 0-0<br>1-2 1B |               | 0-3<br>K     | 0-0<br>2-6    | 0-0<br>F7  |           | 0-3<br>K      | 4 0 1 0 0 1 1<br>1 0 0 0 0 1 1                                   |
| <b>Grady Hatton, L</b> (1, 5)<br>OBP: 0.355, SLG: 0.509  | 4-0<br>BB  |           | 0-0<br>F5     |               | 0-0<br>HR    |               | 0-0<br>4-3 |           | 0-0<br>4-3    | 4 1 1 2 1 0 3  |
| <b>Ron Northey, L</b> (1, 9)<br>OBP: 0.378, SLG: 0.719   | 0-0<br>G3  |           |               | 4-0<br>1B BB  | 0-0<br>2B    |               | 4-0<br>BB  |           | 0-0<br>4-3    | 3 0 1 0 2 0 2  |
| <b>Johnny Wyrostek, L</b> (1, 7)<br>OBP: 0.344, SLG: 0.418   |            | 0-0<br>F7 |               | 0-0<br>F9     | 4-3          |               | 0-0<br>F8  |           |               | 4 0 0 0 0 0 3  |
| <b>Ted Kluszewski, L</b> (1, 3)<br>OBP: 0.250, SLG: 0.370  |            | 0-0<br>F5 |               | 0-0<br>F8     |              | 0-0<br>HR     |            | 0-3<br>K  |               | 4 1 1 1 0 1 1  |
| <b>Virgil Stallcup, R</b> (1, 6)<br>OBP: 0.255, SLG: 0.288   |            | 0-0<br>F8 |               | 0-0<br>1-2 1B |              | 0-0<br>F8     |            | 0-3<br>K  |               | 4 0 1 0 0 1 0  |
| <b>Dixie Howell, R</b> (1, 2)<br>OBP: 0.278, SLG: 0.294<br><b>Mary Rackley, L</b> (8, PR)<br>OBP: 1.000, SLG: 1.000<br><b>Kent Peterson, R</b> (9, 1)<br>OBP: 0.500, SLG: 0.500<br><b>Johnny Hetki, R</b> (9, 1) |            |           | 0-0<br>1-3    | 0-0<br>F5     |              | 0-0<br>1-3 1B |            | 0-0<br>1B |               | 4 1 2 0 0 0 2<br>0 0 0 0 0 0 0<br>0 0 0 0 0 0 0<br>0 0 0 0 0 0 0 |
| <b>Ewell Blackwell, R</b> (1, 1)<br>OBP: 0.333, SLG: 0.200<br><b>Walker Cooper, R</b> (8, PH)<br>OBP: 0.186, SLG: 0.233  |            |           | 0-0<br>1B     |               | 4-3          | 0-0<br>1-3    |            | 0-0<br>F7 |               | 3 0 1 0 0 0 1<br>1 0 0 0 0 0 1                                   |

| Inning Stats | R: 0<br>E: 0<br>K: 3<br>S: 3 | H: 0<br>LOB: 1<br>BB: 1<br>P: 7 | R: 0<br>E: 0<br>K: 3<br>S: 3 | H: 0<br>LOB: 0<br>BB: 0<br>P: 3 | R: 0<br>E: 0<br>K: 5<br>S: 5 | H: 2<br>LOB: 2<br>BB: 0<br>P: 5 | R: 0<br>E: 0<br>K: 4<br>S: 4 | H: 1<br>LOB: 2<br>BB: 1<br>P: 8 | R: 2<br>E: 0<br>K: 1<br>S: 7 | H: 2<br>LOB: 1<br>BB: 1<br>P: 11 | R: 2<br>E: 0<br>K: 5<br>S: 5 | H: 3<br>LOB: 1<br>BB: 0<br>P: 5 | R: 0<br>E: 0<br>K: 3<br>S: 3 | H: 0<br>LOB: 1<br>BB: 1<br>P: 7 | R: 0<br>E: 0<br>K: 2<br>S: 8 | H: 1<br>LOB: 1<br>BB: 0<br>P: 8 | R: 0<br>E: 0<br>K: 1<br>S: 5 | H: 0<br>LOB: 1<br>BB: 1<br>P: 9 | 1B: 6<br>2B: 1<br>3B: 0<br>HR: 2 | SF: 0<br>SAC: 0<br>DP: 0<br>HBP: 0 |
|--------------|------------------------------|---------------------------------|------------------------------|---------------------------------|------------------------------|---------------------------------|------------------------------|---------------------------------|------------------------------|----------------------------------|------------------------------|---------------------------------|------------------------------|---------------------------------|------------------------------|---------------------------------|------------------------------|---------------------------------|----------------------------------|------------------------------------|
|--------------|------------------------------|---------------------------------|------------------------------|---------------------------------|------------------------------|---------------------------------|------------------------------|---------------------------------|------------------------------|----------------------------------|------------------------------|---------------------------------|------------------------------|---------------------------------|------------------------------|---------------------------------|------------------------------|---------------------------------|----------------------------------|------------------------------------|

| PITCHER                                    | IP  | WLS | BF | H | R | ER | SO | BB | IBB | HBP | BLK | WP | HR | S  | P  | ERA  | WHIP  |
|--|-----|-----|----|---|---|----|----|----|-----|-----|-----|----|----|----|----|------|-------|
| <b>Bubba Church, R</b> (1, 1)<br>ERA: 3.6  | 5.2 |     | 28 | 8 | 4 | 4  | 1  | 3  | 0   | 0   | 0   | 0  | 2  | 27 | 39 | 6.35 | 1.941 |
| <b>Curt Simmons, L</b> (6, 1)<br>ERA: 2.93 | 3.1 | W   | 13 | 1 | 0 | 0  | 3  | 2  | 0   | 0   | 0   | 0  | 0  | 16 | 24 | 0.00 | 0.900 |

**BOTTOM**

**Philadelphia Phillies @ Cincinnati Reds**  
Crosley Field, Cincinnati, OH

Sun May 07 1950, 3:38 AM EDT  
Att. 13,313 - Unknown

livebaseballscorecards.com

|            |           |
|------------|-----------|
| <b>AB</b>  | <b>35</b> |
| <b>R</b>   | <b>4</b>  |
| <b>H</b>   | <b>9</b>  |
| <b>RBI</b> | <b>4</b>  |
| <b>BB</b>  | <b>5</b>  |
| <b>SO</b>  | <b>4</b>  |
| <b>LOB</b> | <b>16</b> |



| WP | PA |
|----|----|
| 0  | 40 |
| 0  | 0  |
| 2  | 0  |
| 0  | 0  |

| Batter  | 1   | 2                               | 3                            | 4                               | 5                            | 6                               | 7                            | 8                               | 9                            | AB R H RBI BB SO LOB                            | TOP  |                                  |                              |                                 |                              |                                 |                                  |                                    |                                  |        |
|---|---|---------------------------------|------------------------------|---------------------------------|------------------------------|---------------------------------|------------------------------|---------------------------------|------------------------------|---|--|----------------------------------|------------------------------|---------------------------------|------------------------------|---------------------------------|----------------------------------|------------------------------------|----------------------------------|--------|
| Richie Ashburn, L (1, 8)<br>OBP: 0.426, SLG: 0.368  | 0-0<br>6-3  |                                 | 0-0<br>4-1                   |                                 | 0-0<br>FC5-4<br>1B           |                                 | 0-0<br>1-H<br>E<br>2B        |                                 | 0-3<br>K                     | 5 1 2 1 0 1 0                                   | <b>Philadelphia Phillies @ Cincinnati Reds</b><br>Crosley Field, Cincinnati, OH<br>Mon May 08 1950, 3:33 AM EDT<br>Att. 5,141 - Unknown<br><br><a href="http://livebaseballscorecards.com">livebaseballscorecards.com</a><br><br><b>AB 39</b><br><b>R 6</b><br><b>H 12</b><br><b>RBI 5</b><br><b>BB 1</b><br><b>SO 6</b><br><b>LOB 17</b><br><br> |                                  |                              |                                 |                              |                                 |                                  |                                    |                                  |        |
| Granny Hamner, R (1, 6)<br>OBP: 0.354, SLG: 0.379   | 0-0<br>F2   |                                 | 0-0<br>5-3                   |                                 | 0-0<br>F7                    |                                 | 0-3<br>2-H<br>K              |                                 | 0-0<br>5-3<br>1B             | 5 0 1 1 0 1 1                                   |  |                                  |                              |                                 |                              |                                 |                                  |                                    |                                  |        |
| Eddie Waitkus, L (1, 3)<br>OBP: 0.396, SLG: 0.407   | 0-0<br>4-3  |                                 | 0-0<br>F4                    |                                 | 0-0<br>FC5-4<br>1-2f         |                                 | 0-0<br>1B                    |                                 | 0-0<br>1-2<br>1B             | 5 0 2 0 0 0 1                                   |  |                                  |                              |                                 |                              |                                 |                                  |                                    |                                  |        |
| Del Ennis, R (1, 9)<br>OBP: 0.347, SLG: 0.522       |   | 0-0<br>F6                       |                              | 0-0<br>F9                       |                              | 0-0<br>F9                       |                              | 0-0<br>1-3<br>1B                | 0-0<br>5-3                   | 5 0 1 0 0 0 2                                   |  |                                  |                              |                                 |                              |                                 |                                  |                                    |                                  |        |
| Willie Jones, R (1, 5)<br>OBP: 0.368, SLG: 0.582    |   | 0-0<br>E6<br>2B<br>1B           |                              | 0-0<br>6-3                      |                              | 0-0<br>6-3                      |                              | 0-0<br>2B<br>FC6-2-5-2<br>1B    | 0-0<br>F6                    | 4 1 1 0 0 0 0<br>1 0 0 0 0 0 2                  |  |                                  |                              |                                 |                              |                                 |                                  |                                    |                                  |        |
| Putsy Caballero, R (8, 5)<br>OBP: 0.222, SLG: 0.125 |   |                                 |                              |                                 |                              |                                 |                              |                                 |                              |   |  |                                  |                              |                                 |                              |                                 |                                  |                                    |                                  |        |
| Dick Sisk, L (1, 7)<br>OBP: 0.482, SLG: 0.616       |   | 0-0<br>1B<br>2B                 |                              | 0-3<br>K                        |                              | 4-0<br>BB                       |                              | 0-0<br>1-3<br>2B                |                              | 3 1 2 0 1 1 0                                   |  |                                  |                              |                                 |                              |                                 |                                  |                                    |                                  |        |
| Mike Goliat, R (1, 4)<br>OBP: 0.333, SLG: 0.380     |   | 0-0<br>6-3<br>2-H<br>3-H<br>1B  |                              |                                 | 0-0<br>HR                    | 0-3<br>K                        |                              | 0-0<br>6-3                      |                              | 4 1 2 3 0 1 3                                   |  |                                  |                              |                                 |                              |                                 |                                  |                                    |                                  |        |
| Ken Silvestri, S (1, 2)<br>OBP: 0.474, SLG: 0.429   |   | 0-0<br>6-3                      |                              |                                 | 1-0<br>FC1-6<br>HBP          |                                 | 0-0<br>2B<br>1B              |                                 | 0-0<br>FC6-2-5-2             | 1 0 0 0 0 0 1<br>1 1 1 0 0 0 0<br>1 0 0 0 0 0 2 |  |                                  |                              |                                 |                              |                                 |                                  |                                    |                                  |        |
| Dick Whitman, L (7, PH)<br>OBP: 0.293, SLG: 0.237   |   |                                 |                              |                                 |                              |                                 |                              |                                 |                              |   |  |                                  |                              |                                 |                              |                                 |                                  |                                    |                                  |        |
| Bob Miller, R (7, 1)<br>OBP: 0.143, SLG: 0.143      |   | 0-0<br>2-3                      |                              |                                 | 0-0<br>FC1-6<br>1B<br>F7     |                                 | 0-3<br>K                     |                                 | 0-3<br>K                     | 2 1 0 0 0 0 2<br>2 0 0 0 0 2 3                  |  |                                  |                              |                                 |                              |                                 |                                  |                                    |                                  |        |
| Ken Johnson, L (1, 1)<br>OBP: 0.143, SLG: 0.143     |   | 0-0<br>1-6-3                    |                              |                                 |                              |                                 |                              |                                 |                              |   |  |                                  |                              |                                 |                              |                                 |                                  |                                    |                                  |        |
| Andy Seminick, R (7, PH)<br>OBP: 0.267, SLG: 0.308  |   |                                 |                              |                                 |                              |                                 |                              |                                 |                              |   |  |                                  |                              |                                 |                              |                                 |                                  |                                    |                                  |        |
| <b>Inning Stats</b>                                 | R: 0<br>E: 0<br>K: 0<br>S: 3                          | H: 0<br>LOB: 0<br>BB: 0<br>P: 3 | R: 2<br>E: 1<br>K: 0<br>S: 6 | H: 2<br>LOB: 1<br>BB: 0<br>P: 6 | R: 0<br>E: 0<br>K: 1<br>S: 5 | H: 0<br>LOB: 0<br>BB: 0<br>P: 5 | R: 2<br>E: 0<br>K: 1<br>S: 5 | H: 2<br>LOB: 1<br>BB: 0<br>P: 6 | R: 0<br>E: 0<br>K: 1<br>S: 5 | H: 0<br>LOB: 1<br>BB: 1<br>P: 9                 | R: 2<br>E: 1<br>K: 2<br>S: 10  | H: 4<br>LOB: 2<br>BB: 0<br>P: 10 | R: 0<br>E: 0<br>K: 1<br>S: 7 | H: 2<br>LOB: 2<br>BB: 0<br>P: 7 | R: 0<br>E: 0<br>K: 1<br>S: 7 | H: 2<br>LOB: 2<br>BB: 0<br>P: 7 | 1B: 8<br>2B: 3<br>3B: 0<br>HR: 1 | SF: 0<br>SAC: 0<br>DP: 0<br>HBP: 1 | WP: 0<br>PB: 0<br>SB: 0<br>CS: 0 | PA: 41 |
| <b>PITCHER</b>                                      | IP WLS BF H R ER SO BB IBB HBP BLK WP HR S P ERA WHIP |                                 |                              |                                 |                              |                                 |                              |                                 |                              |   |  |                                  |                              |                                 |                              |                                 |                                  |                                    |                                  |        |
| Herm Wehmeier, R (1, 1)<br>ERA: 5.4                 | 7.0 L 33 10 6 5 4 1 0 1 0 0 0 1 39 44 6.43 1.571      |                                 |                              |                                 |                              |                                 |                              |                                 |                              |   |  |                                  |                              |                                 |                              |                                 |                                  |                                    |                                  |        |
| Eddie Erault, R (8, 1)<br>ERA: 6.46                 | 2.0 8 2 0 0 2 0 0 0 0 0 0 0 12 12 0.00 1.000          |                                 |                              |                                 |                              |                                 |                              |                                 |                              |   |  |                                  |                              |                                 |                              |                                 |                                  |                                    |                                  |        |

BOTTOM

Philadelphia Phillies @ Cincinnati Reds  
Crosley Field, Cincinnati, OH  
Mon May 08 1950, 3:33 AM EDT  
Att. 5,141 - Unknown

livebaseballscores.com

|     |    |
|-----|----|
| AB  | 32 |
| R   | 5  |
| H   | 6  |
| RBI | 5  |
| BB  | 5  |
| SO  | 2  |
| LOB | 13 |



|     |   |     |    |
|-----|---|-----|----|
| WP: | 1 | PA: | 37 |
| PB: | 0 |     |    |
| SB: | 0 |     |    |
| CS: | 0 |     |    |

AB R H RBI BB SO LOB

5 0 0 0 0 1 1  
1 0 0 0 2 0 0  
1 0 0 0 0 0 0

4 0 0 1 0 0 2

4 1 1 0 0 1 2

3 0 1 0 0 0 1  
0 0 0 0 1 0 0

1 1 0 0 2 0 0  
1 0 0 0 0 0 1

4 1 1 3 0 0 3

4 1 2 1 0 0 2

3 1 1 0 0 0 1  
0 0 0 0 0 0 0  
1 0 0 0 0 0 0

|     |   |      |   |
|-----|---|------|---|
| 1B: | 2 | SF:  | 0 |
| 2B: | 2 | SAC: | 0 |
| 3B: | 0 | DP:  | 1 |
| HR: | 2 | HBP: | 0 |

| Batter   | 1                      | 2                                     | 3                       | 4         | 5          | 6                       | 7         | 8                             | 9        |
|--|------------------------|---------------------------------------|-------------------------|-----------|------------|-------------------------|-----------|-------------------------------|----------|
| Bobby Adams, R (1, 4)<br>OBP: 0.349, SLG: 0.357  | 0-0<br>6-3             |                                       | 0-0<br>F7               |           | 0-0<br>F7  |                         | 0-0<br>F6 |                               | 0-3<br>K |
| Peanuts Lowrey, R (1, 7)<br>OBP: 0.400, SLG: 0.360<br>Johnny Wyrostek, L (7, 7)<br>OBP: 0.339, SLG: 0.411                        | 4-0<br>FC3-5-4<br>BB   |                                       | 4-0<br>WP<br>BB         |           | 0-0<br>F3  |                         | 0-0<br>F7 |                               |          |
| Grady Hatton, L (1, 5)<br>OBP: 0.333, SLG: 0.475   | 0-0<br>FC3-5-4<br>1-2f |                                       | 0-0<br>F8<br>1-2<br>2-H |           |            | 0-0<br>4-3              | 0-0<br>F9 |                               |          |
| Walker Cooper, R (1, 2)<br>OBP: 0.191, SLG: 0.255  | 0-0<br>4-3             |                                       | 0-0<br>F8               |           |            | 0-0<br>HR<br>2B         |           | 0-3<br>K                      |          |
| Danny Litwhiler, R (1, 9)<br>OBP: 0.290, SLG: 0.321<br>Ron Northey, L (7, 9)<br>OBP: 0.395, SLG: 0.719                           |                        | 0-0<br>FC4-3<br>BB<br>1B              |                         | 0-0<br>F4 |            | 0-0<br>F9               |           | 4-0<br>FC3-8<br>BB            |          |
| Bob Usher, R (1, 8)<br>OBP: 0.344, SLG: 0.621<br>Lloyd Merriman, L (8, PH)<br>OBP: 0.379, SLG: 0.385<br>(9, 8)                   |                        | 4-0<br>FC4-3<br>1-2<br>BB             |                         | 0-0<br>F9 |            | 4-0<br>HR<br>BB         |           | 0-0<br>FC3-6<br>FC4-8<br>1-2f |          |
| Ted Kluszewski, L (1, 3)<br>OBP: 0.250, SLG: 0.420   |                        | 0-0<br>FC4-3<br>G5-4-3<br>1-2f<br>2-3 |                         | 0-0<br>F8 |            | 0-0<br>1-H<br>2-H<br>HR |           | 0-0<br>FC4-6<br>1-2f          |          |
| Virgil Stallcup, R (1, 6)<br>OBP: 0.271, SLG: 0.357  |                        | 0-0<br>G5-4-3<br>1-2f                 |                         |           | 0-0<br>HR  | 0-0<br>1B               |           | 0-0<br>F6                     |          |
| Herm Wehmeier, R (1, 1)<br>OBP: 0.417, SLG: 0.455<br>Eddie Erault, R (8, 1)<br>Mary Rackley, L (9, PH)<br>OBP: 0.500, SLG: 0.500 |                        |                                       | 0-0<br>WP<br>F8<br>2B   |           | 0-0<br>1-3 | 0-0<br>1-3              |           | 0-0<br>F6                     |          |

| Inning Stats | R: 0 | H: 0 | E: 0 | K: 0 | S: 3 | R: 0 | H: 1 | E: 0 | K: 0 | S: 3 | R: 0 | H: 1 | E: 0 | K: 0 | S: 4 | R: 0 | H: 0 | E: 0 | K: 0 | S: 3 | R: 1 | H: 1 | E: 0 | K: 0 | S: 4 | R: 3 | H: 3 | E: 0 | K: 0 | S: 6 | R: 0 | H: 0 | E: 0 | K: 0 | S: 3 | R: 0 | H: 0 | E: 0 | K: 1 | S: 5 | R: 0 | H: 0 | E: 0 | K: 1 | S: 5 | 1B: 2 | 2B: 2 | 3B: 0 | HR: 2 | SF: 0 | SAC: 0 | DP: 1 | HBP: 0 | WP: 1 | PA: 37 |
|--------------|------|------|------|------|------|------|------|------|------|------|------|------|------|------|------|------|------|------|------|------|------|------|------|------|------|------|------|------|------|------|------|------|------|------|------|------|------|------|------|------|------|------|------|------|------|-------|-------|-------|-------|-------|--------|-------|--------|-------|--------|
|              | 0    | 0    | 0    | 0    | 7    | 0    | 1    | 0    | 0    | 7    | 0    | 1    | 0    | 0    | 8    | 0    | 0    | 0    | 0    | 3    | 1    | 1    | 0    | 0    | 4    | 3    | 3    | 0    | 0    | 10   | 0    | 0    | 0    | 0    | 3    | 0    | 0    | 0    | 1    | 9    | 0    | 0    | 0    | 1    | 5    |       |       |       |       |       |        |       |        |       |        |

| PITCHER                            | IP  | WLS | BF | H | R | ER | SO | BB | IBB | HBP | BLK | WP | HR | S  | P  | ERA  | WHIP  |
|------------------------------------|-----|-----|----|---|---|----|----|----|-----|-----|-----|----|----|----|----|------|-------|
| Ken Johnson, L (1, 1)<br>ERA: 3.94 | 6.0 | W   | 27 | 6 | 5 | 5  | 0  | 4  | 0   | 0   | 0   | 1  | 2  | 23 | 39 | 7.50 | 1.667 |
| Bob Miller, R (7, 1)<br>ERA: 1.69  | 3.0 | S   | 10 | 0 | 0 | 0  | 2  | 1  | 0   | 0   | 0   | 0  | 0  | 13 | 17 | 0.00 | 0.333 |

| Batter   | 1                            | 2                                | 3                             | 4                                | 5                            | 6                                | 7                            | 8                                | 9                            | AB R H RBI BB SO LOB                            | TOP   |                                  |                              |                                  |                              |                                  |                              |                                  |                                  |                                    |                                  |        |    |    |   |   |     |      |  |  |  |
|--|------------------------------|----------------------------------|-------------------------------|----------------------------------|------------------------------|----------------------------------|------------------------------|----------------------------------|------------------------------|---|---|----------------------------------|------------------------------|----------------------------------|------------------------------|----------------------------------|------------------------------|----------------------------------|----------------------------------|------------------------------------|----------------------------------|--------|----|----|---|---|-----|------|--|--|--|
| <b>Pee Wee Reese, R</b> (1, 6)<br>OBP: 0.370, SLG: 0.385   | 0-1<br>F4                    |                                  | 2-3<br>K                      |                                  | 1-1<br>F6                    |                                  |                              | 0-2<br>F7                        |                              | 4 0 0 0 0 1 0                                   | <b>Brooklyn Dodgers @ Cincinnati Reds</b><br>Crosley Field, Cincinnati, OH<br>Wed May 10 1950, 3:33 AM EDT<br>Att. 11,736 - Unknown |                                  |                              |                                  |                              |                                  |                              |                                  |                                  |                                    |                                  |        |    |    |   |   |     |      |  |  |  |
| <b>Billy Cox, R</b> (1, 5)<br>OBP: 0.318, SLG: 0.350   | 3-3<br>K                     |                                  | 3-2<br>F6                     |                                  |                              | 4-2<br>CS<br>BB                  |                              | 1-2<br>F8                        |                              | 3 0 0 0 1 1 0                                   |   |                                  |                              |                                  |                              |                                  |                              |                                  |                                  |                                    |                                  |        |    |    |   |   |     |      |  |  |  |
| <b>Jim Russell, S</b> (1, 7)<br>OBP: 0.325, SLG: 0.618   | 0-1<br>5-3                   |                                  | 0-0<br>F7                     |                                  |                              | 1-2<br>F8                        |                              | 0-0<br>F7                        |                              | 4 0 0 0 0 0 1                                   |   |                                  |                              |                                  |                              |                                  |                              |                                  |                                  |                                    |                                  |        |    |    |   |   |     |      |  |  |  |
| <b>Jackie Robinson, R</b> (1, 4)<br>OBP: 0.440, SLG: 0.614   |                              | 2-2<br>F6                        |                               | 2-2<br>5-3                       |                              | 4-0<br>CS<br>BB                  |                              | 1-1<br>F4                        |                              | 3 0 0 0 1 0 0                                   |   |                                  |                              |                                  |                              |                                  |                              |                                  |                                  |                                    |                                  |        |    |    |   |   |     |      |  |  |  |
| <b>Carl Furillo, R</b> (1, 9)<br>OBP: 0.318, SLG: 0.350  |                              | 0-0<br>BB<br>1B<br>1B            |                               | H<br>1-0<br>HBP                  |                              | 3-2<br>6-3<br>1-2<br>2-3         |                              | 2-2<br>F6                        |                              | 3 0 1 0 0 0 2                                   |   |                                  |                              |                                  |                              |                                  |                              |                                  |                                  |                                    |                                  |        |    |    |   |   |     |      |  |  |  |
| <b>Gil Hodges, R</b> (1, 3)<br>OBP: 0.402, SLG: 0.549  |                              | 1-0<br>BB<br>1-2<br>1B           |                               | 3-2<br>F4                        |                              |                                  | 0-1<br>F5                    |                                  | 1-2<br>F2                    | 4 0 1 0 0 0 1                                   |   |                                  |                              |                                  |                              |                                  |                              |                                  |                                  |                                    |                                  |        |    |    |   |   |     |      |  |  |  |
| <b>Duke Snider, L</b> (1, 8)<br>OBP: 0.407, SLG: 0.471   |                              | 4-1<br>BB<br>1-2<br>2-3<br>BB    |                               | 2-2<br>F5                        |                              |                                  | 1-0<br>F8                    |                                  |                              | 2 0 0 0 1 0 1                                   |   |                                  |                              |                                  |                              |                                  |                              |                                  |                                  |                                    |                                  |        |    |    |   |   |     |      |  |  |  |
| <b>Bruce Edwards, R</b> (1, 2)<br>OBP: 0.194, SLG: 0.367   |                              | 1-3<br>K                         |                               |                                  | 0-1<br>F8                    |                                  | 0-0<br>BB<br>1B              |                                  |                              | 3 0 1 0 0 1 3                                   |   |                                  |                              |                                  |                              |                                  |                              |                                  |                                  |                                    |                                  |        |    |    |   |   |     |      |  |  |  |
| <b>Preacher Roe, R</b> (1, 1)<br>OBP: 0.222, SLG: 0.250<br><b>Bobby Morgan, R</b> (7, PH)<br>OBP: 0.346, SLG: 0.275<br><b>Rex Barney, R</b> (7, 1) |                              | 2-2<br>L9                        |                               |                                  | 0-3<br>K                     |                                  | 2-2<br>F7                    |                                  |                              | 2 0 0 0 0 1 3<br>1 0 0 0 0 0 1<br>0 0 0 0 0 0 0 |   |                                  |                              |                                  |                              |                                  |                              |                                  |                                  |                                    |                                  |        |    |    |   |   |     |      |  |  |  |
| <b>Inning Stats</b>  | R: 0<br>E: 0<br>K: 1<br>S: 7 | H: 0<br>LOB: 0<br>BB: 0<br>P: 10 | R: 0<br>E: 0<br>K: 1<br>S: 12 | H: 2<br>LOB: 3<br>BB: 1<br>P: 22 | R: 0<br>E: 0<br>K: 1<br>S: 7 | H: 0<br>LOB: 0<br>BB: 0<br>P: 12 | R: 0<br>E: 0<br>K: 0<br>S: 9 | H: 0<br>LOB: 1<br>BB: 0<br>P: 17 | R: 0<br>E: 0<br>K: 1<br>S: 7 | H: 0<br>LOB: 0<br>BB: 0<br>P: 8                 | R: 0<br>E: 0<br>K: 0<br>S: 8  | H: 0<br>LOB: 1<br>BB: 2<br>P: 20 | R: 0<br>E: 0<br>K: 0<br>S: 7 | H: 1<br>LOB: 1<br>BB: 0<br>P: 10 | R: 0<br>E: 0<br>K: 0<br>S: 9 | H: 0<br>LOB: 0<br>BB: 0<br>P: 10 | R: 0<br>E: 0<br>K: 0<br>S: 8 | H: 0<br>LOB: 0<br>BB: 0<br>P: 12 | 1B: 3<br>2B: 0<br>3B: 0<br>HR: 0 | SF: 0<br>SAC: 0<br>DP: 0<br>HBP: 1 | WP: 0<br>PB: 0<br>SB: 1<br>CS: 2 | PA: 33 |    |    |   |   |     |      |  |  |  |
| <b>PITCHER</b><br><b>Ken Raffensberger, L</b> (1, 1)<br>ERA: 4.25  | IP<br>9.0                    | WLS<br>W                         | BF<br>33                      | H<br>3                           | R<br>0                       | ER<br>0                          | SO<br>4                      | BB<br>3                          | IBB<br>0                     | HBP<br>1  | BLK<br>0  | WP<br>0                          | HR<br>0                      | S<br>74                          | P<br>121                     | ERA<br>0.00                      | WHIP<br>0.667                |                                  |                                  |                                    |                                  |        |    |    |   |   |     |      |  |  |  |
|  |                              |                                  |                               |                                  |                              |                                  |                              |                                  |                              |   | <b>PITCHER</b>  | IP                               | WLS                          | BF                               | H                            | R                                | ER                           | SO                               | BB                               | IBB                                | HBP                              | BLK    | WP | HR | S | P | ERA | WHIP |  |  |  |

|            |    |
|------------|----|
| <b>AB</b>  | 29 |
| <b>R</b>   | 0  |
| <b>H</b>   | 3  |
| <b>RBI</b> | 0  |
| <b>BB</b>  | 3  |
| <b>SO</b>  | 4  |
| <b>LOB</b> | 12 |



livebaseballscorecards.com

| Batter   | 1      | 2      | 3      | 4            | 5            | 6      | 7       | 8       | 9 |
|--|--------|--------|--------|--------------|--------------|--------|---------|---------|---|
| <b>Bobby Adams, R</b> (1, 4)<br>OBP: 0.338, SLG: 0.344       | 3-2 F3 |        | 2-2 F8 |              | 1-2 F8       |        | 3-2 F9  | 1-0 F7  |   |
| <b>Peanuts Lowrey, R</b> (1, 7)<br>OBP: 0.353, SLG: 0.310    | 3-3 K  |        | 1-1 F8 |              | 2-2 1-3      |        | 0-0 6-3 |         |   |
| <b>Grady Hatton, L</b> (1, 5)<br>OBP: 0.343, SLG: 0.484      | 2-2 L8 |        |        | 3-2 F9       |              | 1-1 2B | 2-1 HBP |         |   |
| <b>Danny Litwhiler, R</b> (1, 9)<br>OBP: 0.294, SLG: 0.300   |        | 1-0 F2 |        | 4-1 FC5-4 1B |              | 1-1 F4 | 3-1 F8  |         |   |
| <b>Ron Northey, L</b> (7, PH)<br>OBP: 0.365, SLG: 0.697      |        |        |        | BB           |              |        |         |         |   |
| <b>Bob Usher, R</b> (1, 8)<br>OBP: 0.361, SLG: 0.636         |        | 2-0 F2 |        | 3-2 FC5-4 1B |              | 2-0 2B |         | 0-0 5-3 |   |
| <b>Ted Kluszewski, L</b> (1, 3)<br>OBP: 0.232, SLG: 0.389    |        | 2-1 F6 |        | 2-2 FC5-4    |              | 1-0 F8 |         | 1-1 E1  |   |
| <b>Virgil Stallcup, R</b> (1, 6)<br>OBP: 0.286, SLG: 0.383   |        |        | 0-1 F3 |              | 0-0 F7       |        | 0-1 2B  | 1-1 E   |   |
| <b>Dixie Howell, R</b> (1, 2)<br>OBP: 0.409, SLG: 0.400      |        |        | 1-1 1B |              | 2-2 FC2-6 1B |        | 4-0 IBB | 1-1 E7  |   |
| <b>Ken Raffensberger, R</b> (1, 1)<br>OBP: 0.100, SLG: 0.100 |        |        | 2-3 K  |              | 0-0 FC2-6    |        | 1-3 K   | 1-2 5-3 |   |

| Inning Stats | R: 0   | H: 0  | E: 0  | K: 1  | S: 9  | R: 0   | H: 0   | E: 0   | K: 0   | S: 4   | R: 0   | H: 2   | E: 0   | K: 1   | S: 12   | R: 0   | H: 1   | E: 0   | K: 0   | S: 11   | R: 0   | H: 1   | E: 0   | K: 0   | S: 12  | R: 2   | H: 3   | E: 0   | K: 1   | S: 11  | R: 0   | H: 0   | E: 0   | K: 0    | S: 7   | R: 2   | H: 2   | E: 2    | K: 0 | S: 11 |
|--------------|--------|-------|-------|-------|-------|--------|--------|--------|--------|--------|--------|--------|--------|--------|---------|--------|--------|--------|--------|---------|--------|--------|--------|--------|--------|--------|--------|--------|--------|--------|--------|--------|--------|---------|--------|--------|--------|---------|------|-------|
|              | LOB: 0 | BB: 0 | BB: 0 | BB: 0 | BB: 0 | LOB: 0 | LOB: 0 | LOB: 0 | LOB: 0 | LOB: 0 | LOB: 0 | LOB: 2 | LOB: 2 | LOB: 0 | LOB: 18 | LOB: 1 | LOB: 2 | LOB: 1 | LOB: 0 | LOB: 17 | LOB: 2 | LOB: 3 | LOB: 2 | LOB: 1 | LOB: 0 | LOB: 1 | LOB: 2 | LOB: 1 | LOB: 1 | LOB: 0 | LOB: 1 | LOB: 1 | LOB: 0 | LOB: 15 | LOB: 2 | LOB: 1 | LOB: 0 | LOB: 16 |      |       |

| PITCHER                                   | IP  | WLS | BF | H | R | ER | SO | BB | IBB | HBP | BLK | WP | HR | S  | P   | ERA  | WHIP  |
|---|-----|-----|----|---|---|----|----|----|-----|-----|-----|----|----|----|-----|------|-------|
| <b>Preacher Roe, L</b> (1, 1)<br>ERA: 3.7 | 6.0 | L   | 27 | 7 | 2 | 2  | 3  | 1  | 1   | 0   | 0   | 0  | 0  | 59 | 105 | 3.00 | 1.333 |
| <b>Rex Barney, R</b> (7, 1)<br>ERA: 1.46  | 2.0 |     | 10 | 2 | 2 | 0  | 0  | 0  | 0   | 1   | 0   | 0  | 0  | 18 | 31  | 0.00 | 1.000 |

**BOTTOM**

**Brooklyn Dodgers @ Cincinnati Reds**  
Crosley Field, Cincinnati, OH

Wed May 10 1950, 3:33 AM EDT  
Att. 11,736 - Unknown

|     |    |
|-----|----|
| AB  | 34 |
| R   | 4  |
| H   | 9  |
| RBI | 3  |
| BB  | 2  |
| SO  | 3  |
| LOB | 17 |



| 1B | 2B | 3B | HR | SF | SAC | DP | HBP | WP | HR | S | P | ERA | WHIP |
|----|----|----|----|----|-----|----|-----|----|----|---|---|-----|------|
| 6  | 3  | 0  | 0  | 0  | 0   | 0  | 1   | 0  | 0  | 0 | 0 | 0   | 0    |

| Batter  | 1   | 2                               | 3                            | 4                               | 5                            | 6                                | 7                            | 8                               | 9                            | AB R H RBI BB SO LOB  | TOP                          |                                  |                              |                                  |                              |                                  |                                  |                                    |                                  |        |
|---|---|---------------------------------|------------------------------|---------------------------------|------------------------------|----------------------------------|------------------------------|---------------------------------|------------------------------|---|------------------------------|----------------------------------|------------------------------|----------------------------------|------------------------------|----------------------------------|----------------------------------|------------------------------------|----------------------------------|--------|
| <b>Grady Hatton, L</b> (1, 5)<br>OBP: 0.333, SLG: 0.447   | 0-0<br>F8   |                                 | 0-3<br>K                     |                                 | 0-0<br>F8                    |                                  | 4-0<br>3B BB                 |                                 | 0-0<br>F9                    | 4 1 0 0 1 1 0   |                              |                                  |                              |                                  |                              |                                  |                                  |                                    |                                  |        |
| <b>Lloyd Merriman, L</b> (1, 8)<br>OBP: 0.424, SLG: 0.483<br><b>Peanuts Lowrey, R</b> (9, PH)<br>OBP: 0.364, SLG: 0.324   | 4-0<br>G1-6-3<br>BB                                   |                                 | 0-0<br>BB<br>1B              |                                 | 0-0<br>P6                    |                                  | 0-0<br>1B<br>3B              |                                 | 4-0<br>BB                    | 3 1 2 3 1 0 0<br>0 1 0 0 0 0 0  |                              |                                  |                              |                                  |                              |                                  |                                  |                                    |                                  |        |
| <b>Johnny Wyrostek, L</b> (1, 7)<br>OBP: 0.400, SLG: 0.463  | 0-0<br>G1-6-3<br>1-2f                                 |                                 | 0-0<br>P4                    |                                 | 0-3<br>K                     |                                  | 0-0<br>1B                    |                                 | 0-0<br>2B<br>1B              | 5 1 2 1 0 1 2   |                              |                                  |                              |                                  |                              |                                  |                                  |                                    |                                  |        |
| <b>Ron Northey, L</b> (1, 9)<br>OBP: 0.409, SLG: 0.703<br><b>Herm Wehmeier, R</b> (9, PR)<br>OBP: 0.333, SLG: 0.357   |   | 0-0<br>F8                       | 4-0<br>1-2<br>BB             |                                 | 0-0<br>L4-3<br>1B            |                                  | 0-3<br>K                     |                                 | 0-0<br>1B<br>2B              | 4 0 2 1 1 1 1<br>0 0 0 0 0 0 0  |                              |                                  |                              |                                  |                              |                                  |                                  |                                    |                                  |        |
| <b>Ted Kluszewski, L</b> (1, 3)<br>OBP: 0.261, SLG: 0.394   |   | 0-0<br>2B<br>1B                 | 0-0<br>F8                    |                                 | 0-0<br>L4-3                  |                                  | 4-0<br>FC4-6<br>BB           |                                 | 0-0<br>6-3                   | 4 1 1 1 1 0 4   |                              |                                  |                              |                                  |                              |                                  |                                  |                                    |                                  |        |
| <b>Connie Ryan, R</b> (1, 4)<br>OBP: 0.333, SLG: 0.345  |   | 0-0<br>F9                       |                              | 4-0<br>CS<br>BB                 |                              | 0-0<br>FC6-4<br>1B<br>3B<br>1B   |                              | 0-0<br>FC4-6<br>FC5-6           | 0-0<br>FC5-4                 | 4 1 2 0 1 0 2   |                              |                                  |                              |                                  |                              |                                  |                                  |                                    |                                  |        |
| <b>Virgil Stallcup, R</b> (1, 6)<br>OBP: 0.303, SLG: 0.397  |   | 0-0<br>1-H<br>2B                |                              | 0-0<br>1-3                      |                              | 0-0<br>FC6-4<br>1B               |                              | 0-0<br>FC5-6<br>BB              | 0-0<br>FC5-4                 | 5 0 2 1 0 0 5   |                              |                                  |                              |                                  |                              |                                  |                                  |                                    |                                  |        |
| <b>Dixie Howell, R</b> (1, 2)<br>OBP: 0.382, SLG: 0.310   |   | 4-0<br>BB                       |                              | 0-0<br>F8                       |                              | 0-0<br>F9                        |                              | 4-0<br>BB                       |                              | 2 0 0 0 2 0 2   |                              |                                  |                              |                                  |                              |                                  |                                  |                                    |                                  |        |
| <b>Ken Raffensberger, R</b> (1, 1)<br>OBP: 0.091, SLG: 0.091<br><b>Bobby Adams, R</b> (5, PH)<br>OBP: 0.329, SLG: 0.333<br><b>Eddie ERAutt, R</b> (5, 1)<br><b>Joe Adcock, R</b> (7, PH)<br>OBP: 0.240, SLG: 0.250<br><b>Willie Ramsdell, R</b> (7, 1)<br><b>Bob Usher, R</b> (8, PH)<br>OBP: 0.333, SLG: 0.537<br><b>Harry Parkowski, L</b> (8, 1)<br>OBP: 1.000, SLG: 1.000 |   | 0-0<br>1-3                      |                              | 0-0<br>F9                       |                              | 0-0<br>FC6-4<br>BB<br>3B         |                              | 0-3<br>K                        |                              | 1 0 0 0 0 0 2<br>1 0 0 0 0 0 0<br>0 0 0 0 0 0 0<br>1 1 0 0 0 0 2<br>0 0 0 0 0 0 0<br>1 0 0 0 0 1 2<br>0 0 0 0 0 0 0 |                              |                                  |                              |                                  |                              |                                  |                                  |                                    |                                  |        |
| <b>Inning Stats</b>   | R: 0<br>E: 0<br>K: 0<br>S: 2                          | H: 0<br>LOB: 0<br>BB: 1<br>P: 6 | R: 1<br>E: 0<br>K: 0<br>S: 5 | H: 2<br>LOB: 2<br>BB: 1<br>P: 9 | R: 0<br>E: 0<br>K: 1<br>S: 6 | H: 1<br>LOB: 2<br>BB: 1<br>P: 10 | R: 0<br>E: 0<br>K: 0<br>S: 3 | H: 0<br>LOB: 0<br>BB: 0<br>P: 3 | R: 0<br>E: 0<br>K: 1<br>S: 5 | H: 1<br>LOB: 0<br>BB: 0<br>P: 5   | R: 4<br>E: 0<br>K: 1<br>S: 9 | H: 4<br>LOB: 1<br>BB: 1<br>P: 13 | R: 0<br>E: 0<br>K: 1<br>S: 5 | H: 0<br>LOB: 2<br>BB: 2<br>P: 13 | R: 2<br>E: 0<br>K: 0<br>S: 6 | H: 3<br>LOB: 3<br>BB: 1<br>P: 10 | 1B: 8<br>2B: 3<br>3B: 1<br>HR: 0 | SF: 0<br>SAC: 0<br>DP: 2<br>HBP: 0 | WP: 0<br>PB: 0<br>SB: 0<br>CS: 1 | PA: 43 |
| <b>PITCHER</b>  | IP WLS BF H R ER SO BB IBB HBP BLK WP HR S P ERA WHIP |                                 |                              |                                 |                              |                                  |                              |                                 |                              |   |                              |                                  |                              |                                  |                              |                                  |                                  |                                    |                                  |        |
| <b>Red Munger, R</b> (1, 1)<br>ERA: 3.82  | 6.2 W 30 8 5 5 2 5 0 0 0 0 0 0 29 49 6.75 1.950       |                                 |                              |                                 |                              |                                  |                              |                                 |                              |   |                              |                                  |                              |                                  |                              |                                  |                                  |                                    |                                  |        |
| <b>Al Brazle, L</b> (7, 1)<br>ERA: 1.93   | 2.1 S 13 3 2 2 2 3 0 0 0 0 0 0 14 26 7.71 2.571       |                                 |                              |                                 |                              |                                  |                              |                                 |                              |   |                              |                                  |                              |                                  |                              |                                  |                                  |                                    |                                  |        |

Cincinnati Reds @ St. Louis Cardinals  
 Sportsman's Park, St. Louis, MO  
 Sun May 14 1950, 4:33 AM EDT  
 Att. 9,632 - Unknown

livebaseballscorecards.com

|     |    |
|-----|----|
| AB  | 35 |
| R   | 7  |
| H   | 11 |
| RBI | 7  |
| BB  | 7  |
| SO  | 4  |
| LOB | 22 |



| Batter   | 1                             | 2          | 3                     | 4                       | 5                         | 6                     | 7          | 8               | 9 | AB | R | H | RBI | BB | SO | LOB |
|--|-------------------------------|------------|-----------------------|-------------------------|---------------------------|-----------------------|------------|-----------------|---|----|---|---|-----|----|----|-----|
| Tommy Glaviano, R<br>OBP: 0.489, SLG: 0.486<br>(1, 5)  | 0-0<br>1B<br>E<br>1B<br>1B    | 0-0<br>5-3 |                       | 0-0<br>2B<br>E<br>2B    | 4-0<br>1-2<br>FC6-4<br>BB |                       | 0-0<br>6-3 |                 |   | 4  | 2 | 2 | 0   | 1  | 0  | 1   |
| Chuck Diering, R<br>OBP: 0.368, SLG: 0.420<br>(1, 8)   | 0-0<br>F9                     |            | 0-0<br>1B<br>2B       | 0-0<br>F2               | 0-0<br>1-2<br>FC6-4       |                       | 0-0<br>6-3 |                 |   | 5  | 1 | 1 | 0   | 0  | 0  | 5   |
| Stan Musial, L<br>OBP: 0.524, SLG: 0.747<br>(1, 3)   | 0-0<br>1B<br>1-2<br>1B        |            | 0-0<br>1-3            | 0-0<br>E4<br>1B<br>2B   |                           | 0-0<br>1B<br>3B       |            | 0-0<br>4-1      |   | 5  | 2 | 3 | 1   | 0  | 0  | 1   |
| Enos Slaughter, L<br>OBP: 0.410, SLG: 0.346<br>(1, 9)  | 0-0<br>E5<br>1-3<br>2-H<br>1B |            | 0-0<br>4-3            | 0-0<br>FC4<br>1B        |                           | 0-0<br>G3<br>1B<br>1B |            | 0-0<br>P2       |   | 5  | 1 | 3 | 2   | 0  | 0  | 1   |
| Red Schoendienst, S<br>OBP: 0.263, SLG: 0.319<br>(1, 4)  | 0-0<br>P4                     |            | 0-0<br>BB<br>BB<br>1B | 0-0<br>FC4<br>1-2f      |                           | 0-0<br>G3<br>1B<br>1B |            | 4-0<br>CS<br>BB |   | 4  | 1 | 2 | 1   | 1  | 0  | 3   |
| Marty Marion, R<br>OBP: 0.400, SLG: 0.367<br>(1, 6)  | 0-0<br>F7                     |            | 4-0<br>BB<br>BB       | 0-0<br>F7               |                           | 0-3<br>K              |            | 0-3<br>K        |   | 4  | 0 | 0 | 0   | 1  | 2  | 6   |
| Johnny Blatnik, R<br>OBP: 0.310, SLG: 0.167<br>Bill Howerton, L<br>OBP: 0.459, SLG: 0.516<br>(5, PH)<br>(6, 7) |                               | 0-0<br>6-3 |                       | 4-0<br>1-2<br>2-3<br>BB |                           | 0-3<br>K              |            | 0-0<br>G3       |   | 1  | 0 | 0 | 0   | 1  | 0  | 0   |
| Del Rice, R<br>OBP: 0.216, SLG: 0.333<br>(1, 2)  |                               | 0-0<br>P4  |                       | 0-0<br>6-3              |                           | 0-0<br>5-3            |            | 0-0<br>1B       |   | 4  | 0 | 1 | 2   | 0  | 0  | 3   |
| Red Munger, R<br>OBP: 0.333, SLG: 0.273<br>Al Brazle, L<br>OBP: 0.250, SLG: 0.250<br>(1, 1)<br>(7, 1)          |                               | 0-0<br>1B  |                       | 0-0<br>2B<br>E<br>1B    |                           | 0-0<br>E6<br>WP       |            | 0-0<br>4-3      |   | 4  | 1 | 2 | 0   | 0  | 0  | 1   |
|  |                               |            |                       |                         |                           |                       |            |                 |   | 0  | 0 | 0 | 0   | 0  | 0  | 0   |

| Inning Stats | R: 1 | H: 3 | LOB: 2 | K: 0 | S: 6 | P: 6 | R: 0 | H: 1 | LOB: 1 | K: 0 | S: 4 | P: 4 | R: 0 | H: 2 | LOB: 3 | K: 0 | S: 5 | P: 13 | R: 3 | H: 4 | LOB: 1 | K: 0 | S: 7 | P: 7 | R: 0 | H: 0 | LOB: 2 | K: 1 | S: 6 | P: 10 | R: 3 | H: 4 | LOB: 1 | K: 1 | S: 9 | P: 9 | R: 0 | H: 0 | LOB: 0 | K: 0 | S: 3 | R: 0 | H: 0 | LOB: 1 | K: 1 | S: 4 | P: 8 |
|--------------|------|------|--------|------|------|------|------|------|--------|------|------|------|------|------|--------|------|------|-------|------|------|--------|------|------|------|------|------|--------|------|------|-------|------|------|--------|------|------|------|------|------|--------|------|------|------|------|--------|------|------|------|
|--------------|------|------|--------|------|------|------|------|------|--------|------|------|------|------|------|--------|------|------|-------|------|------|--------|------|------|------|------|------|--------|------|------|-------|------|------|--------|------|------|------|------|------|--------|------|------|------|------|--------|------|------|------|

| PITCHER                                     | IP  | WLS | BF | H  | R | ER | SO | BB | IBB | HBP | BLK | WP | HR | S  | P  | ERA   | WHIP  |
|---|-----|-----|----|----|---|----|----|----|-----|-----|-----|----|----|----|----|-------|-------|
| Ken Raffensberger, L<br>ERA: 4.81<br>(1, 1) | 4.0 | L   | 24 | 10 | 5 | 4  | 0  | 2  | 0   | 0   | 0   | 0  | 0  | 22 | 30 | 9.00  | 3.000 |
| Eddie Erault, R<br>ERA: 7.27<br>(5, 1)      | 2.0 |     | 12 | 4  | 3 | 3  | 2  | 1  | 0   | 0   | 0   | 1  | 0  | 15 | 19 | 13.50 | 2.500 |
| Willie Ramsdell, R<br>ERA: 2.45<br>(7, 1)   | 1.0 |     | 3  | 0  | 0 | 0  | 0  | 0  | 0   | 0   | 0   | 0  | 0  | 3  | 3  | 0.00  | 0.000 |
| Harry Perkowski, L<br>ERA: 10.38<br>(8, 1)  | 1.0 |     | 3  | 0  | 0 | 0  | 1  | 1  | 0   | 0   | 0   | 0  | 0  | 4  | 8  | 0.00  | 1.000 |

**BOTTOM**

**Cincinnati Reds @ St. Louis Cardinals**  
**Sportsman's Park, St. Louis, MO**  
 Sun May 14 1950, 4:33 AM EDT  
 Att. 9,632 - Unknown

[livebaseballscorecards.com](http://livebaseballscorecards.com)

**AB 38**  
**R 8**  
**H 14**  
**RBI 6**  
**BB 4**  
**SO 3**  
**LOB 23**



1B: 10 SF: 0  
 2B: 4 SAC: 0  
 3B: 1 DP: 1  
 HR: 0 HBP: 0  
 WP: 1 PA: 42  
 PB: 0  
 SB: 0  
 CS: 1  
 ERA  
 WHIP

| Batter   | 1   | 2   | 3   | 4   | 5   | 6   | 7   | 8   | 9   | AB R H RBI BB SO LOB                                       | TOP   |   |
|--|---|---|---|---|---|---|---|---|---|--|---|---|
| Grady Hatton, L (1, 5)<br>OBP: 0.318, SLG: 0.425   | 0-0 1-3   |   | 0-3 K   |   |   | 0-0 F7  |   | 0-0 4-3   |   | 4 0 0 0 0 1 2  | <b>Cincinnati Reds @ Philadelphia Phillies</b><br>Shibe Park, Philadelphia, PA<br>Tue May 16 1950, 3:33 AM EDT<br>Att. 16,041 - Sunny<br><a href="http://livebaseballscorecards.com">livebaseballscorecards.com</a> |   |
| Lloyd Merriman, L (1, 8)<br>OBP: 0.378, SLG: 0.424   | 0-3 K   |   |   |   | 0-0 F2  | 0-0 F5  |   | 0-0 F7  |   | 4 0 0 0 0 1 2  |   |   |
| Johnny Wyrostek, L (1, 7)<br>OBP: 0.380, SLG: 0.437  | 0-0 4-3   |   |   |   | 0-0 F6  | 0-0 F3  |   | 0-0 4-3   |   | 4 0 0 0 0 0 0  |   |   |
| Ron Northey, L (1, 9)<br>OBP: 0.426, SLG: 0.725<br>Bob Usher, R (7, 9)<br>OBP: 0.326, SLG: 0.524   |   | 0-0 2B  |   |   | 0-0 1B  |   | 0-0 4-3   | 0-0 F6  |   | 3 0 2 0 0 0 0<br>1 0 0 0 0 0 0                             |   |   |
| Joe Adcock, R (1, 3)<br>OBP: 0.207, SLG: 0.214   |   | 0-0 F9  |   |   | 0-0 F9  |   | 0-0 F2  | 0-0 6-3   |   | 4 0 0 0 0 0 2  |   |   |
| Connie Ryan, R (1, 4)<br>OBP: 0.333, SLG: 0.337<br>Bobby Adams, R (7, 4)<br>OBP: 0.329, SLG: 0.333   |   | 0-0 5-3   |   |   | 0-0 6-3   |   | 4-0 BB  |   |   | 2 0 0 0 1 0 1<br>0 0 0 0 0 0 0                             |   |   |
| Virgil Stallcup, R (1, 6)<br>OBP: 0.291, SLG: 0.382  |   | 0-0 6-3   |   |   | 0-0 F8  |   | 0-0 F5  |   |   | 3 0 0 0 0 0 2  |   |   |
| Dixie Howell, R (1, 2)<br>OBP: 0.405, SLG: 0.300<br>Herm Wehmeier, R (8, PR)<br>OBP: 0.333, SLG: 0.357<br>Johnny Pramesa, R (8, 2)<br>OBP: 0.286, SLG: 0.857 |   |   | 0-0 F3  |   | 4-0 BB  |   | 4-0 SH3-4 BB  |   |   | 1 0 0 0 2 0 0<br>0 0 0 0 0 0 0<br>0 0 0 0 0 0 0            |   |   |
| Ewell Blackwell, R (1, 1)<br>OBP: 0.250, SLG: 0.100  |   |   | 0-3 K   |   | 0-3 K   |   | 0-0 SH3-4   |   |   | 2 0 0 0 0 2 1  |   |   |
| <b>Inning Stats</b>  | R: 0 H: 0<br>E: 0 LOB: 0<br>K: 1 BB: 0<br>S: 5 P: 5   | R: 0 H: 1<br>E: 0 LOB: 1<br>K: 0 BB: 0<br>S: 4 P: 4 | R: 0 H: 0<br>E: 0 LOB: 0<br>K: 2 BB: 0<br>S: 7 P: 7 | R: 0 H: 1<br>E: 0 LOB: 1<br>K: 0 BB: 0<br>S: 4 P: 4 | R: 0 H: 0<br>E: 0 LOB: 1<br>K: 1 BB: 1<br>S: 5 P: 9 | R: 0 H: 0<br>E: 0 LOB: 0<br>K: 0 BB: 0<br>S: 3 P: 3 | R: 0 H: 0<br>E: 0 LOB: 1<br>K: 0 BB: 1<br>S: 3 P: 7 | R: 0 H: 0<br>E: 0 LOB: 2<br>K: 0 BB: 1<br>S: 3 P: 7 | R: 0 H: 0<br>E: 0 LOB: 0<br>K: 0 BB: 0<br>S: 3 P: 3 | 1B: 1 SF: 0<br>2B: 1 SAC: 1<br>3B: 0 DP: 0<br>HR: 0 HBP: 0 |   | WP: 0 PA: 32<br>PB: 0<br>SB: 0<br>CS: 0 |
| <b>PITCHER</b><br>Robin Roberts, R (1, 1)<br>ERA: 1.95   | IP WLS BF H R ER SO BB IBB HBP BLK WP HR S P ERA WHIP | 9.0 W 32 2 0 0 4 3 0 0 0 0 0 0 37 49 0.00 0.556     |   |   |   |   |   |   |   |  |   |   |





| Batter | 1 | 2 | 3 | 4 | 5 | 6 | 7 | 8 | 9 | AB R H RBI BB SO LOB | BOTTOM |
|--------|---|---|---|---|---|---|---|---|---|----------------------|--------|
|--------|---|---|---|---|---|---|---|---|---|----------------------|--------|

|  |  |  |  |  |  |  |  |  |  |               |   |
|--|--|--|--|--|--|--|--|--|--|---------------|---|
| <b>Richie Ashburn, L</b> (1, 8)<br><small>OBP: 0.433, SLG: 0.392</small> |  |  |  |  |  |  |  |  |  | 2 1 1 0 2 0 0 | <b>Cincinnati Reds @ Philadelphia Phillies</b><br>Shibe Park, Philadelphia, PA<br>Tue May 16 1950, 3:33 AM EDT<br>Att. 16,041 - Sunny |
| <b>Granny Hamner, R</b> (1, 6)<br><small>OBP: 0.319, SLG: 0.336</small>  |  |  |  |  |  |  |  |  |  | 4 0 1 0 0 0 3 |   |
| <b>Eddie Waitkus, L</b> (1, 3)<br><small>OBP: 0.397, SLG: 0.394</small>  |  |  |  |  |  |  |  |  |  | 2 0 0 0 1 0 1 |   |
| <b>Del Ennis, R</b> (1, 9)<br><small>OBP: 0.357, SLG: 0.556</small>      |  |  |  |  |  |  |  |  |  | 3 0 0 0 0 1 2 |   |
| <b>Willie Jones, R</b> (1, 5)<br><small>OBP: 0.364, SLG: 0.592</small>   |  |  |  |  |  |  |  |  |  | 3 0 1 0 0 0 2 |   |
| <b>Dick Sisler, L</b> (1, 7)<br><small>OBP: 0.442, SLG: 0.630</small>    |  |  |  |  |  |  |  |  |  | 3 0 0 0 0 0 1 |   |
| <b>Mike Goliat, R</b> (1, 4)<br><small>OBP: 0.321, SLG: 0.365</small>    |  |  |  |  |  |  |  |  |  | 3 0 0 0 0 2 0 |   |
| <b>Stan Lopata, R</b> (1, 2)<br><small>OBP: 0.348, SLG: 0.276</small>    |  |  |  |  |  |  |  |  |  | 2 0 0 0 1 0 0 |   |
| <b>Robin Roberts, S</b> (1, 1)<br><small>OBP: 0.154, SLG: 0.043</small>  |  |  |  |  |  |  |  |  |  | 3 0 0 0 0 2 1 |   |

|                     |   |   |   |   |   |   |   |  |  |   |
|---------------------|---|---|---|---|---|---|---|--|--|---|
| <b>Inning Stats</b> | R: 1 H: 2<br>E: 0 LOB: 1<br>K: 0 BB: 1<br>S: 4 P: 8 | R: 0 H: 0<br>E: 0 LOB: 0<br>K: 0 BB: 0<br>S: 3 P: 3 | R: 0 H: 0<br>E: 0 LOB: 1<br>K: 1 BB: 1<br>S: 5 P: 9 | R: 0 H: 1<br>E: 0 LOB: 0<br>K: 1 BB: 0<br>S: 5 P: 5 | R: 0 H: 0<br>E: 0 LOB: 0<br>K: 1 BB: 0<br>S: 5 P: 5 | R: 0 H: 0<br>E: 0 LOB: 0<br>K: 1 BB: 0<br>S: 3 P: 3 | R: 0 H: 0<br>E: 1 LOB: 0<br>K: 0 BB: 0<br>S: 3 P: 3 | R: 0 H: 0<br>E: 0 LOB: 2<br>K: 2 BB: 2<br>S: 7 P: 15 | 1B: 3 SF: 0<br>2B: 0 SAC: 0<br>3B: 0 DP: 3<br>HR: 0 HBP: 0 | WP: 0 PA: 29<br>PB: 0<br>SB: 2<br>CS: 0 |
|---------------------|---|---|---|---|---|---|---|--|--|---|

|  |   |   |
|--|---|---|
| <b>PITCHER</b><br><b>Ewell Blackwell, R</b> (1, 1)<br><small>ERA: 1.53</small> | IP 8.0 WLS L BF 29 H 3 R 1 ER 1 SO 5 BB 4 IBB 0 HBP 0 BLK 0 WP 0 HR 0 S 35 P 51 ERA 1.12 WHIP 0.875 | <b>PITCHER</b><br>IP WLS BF H R ER SO BB IBB HBP BLK WP HR S P ERA WHIP |
|--|---|---|

livebaseballscores.com

|            |           |
|------------|-----------|
| <b>AB</b>  | <b>25</b> |
| <b>R</b>   | <b>1</b>  |
| <b>H</b>   | <b>3</b>  |
| <b>RBI</b> | <b>0</b>  |
| <b>BB</b>  | <b>4</b>  |
| <b>SO</b>  | <b>5</b>  |
| <b>LOB</b> | <b>10</b> |



| Batter  | 1  | 2   | 3   | 4   | 5  | 6  | 7   | 8   | 9   | AB R H RBI BB SO LOB   | TOP  |
|---|--|---|---|---|--|--|---|---|---|--|--|
| <b>Bobby Adams, R</b> (1, 4)<br>OBP: 0.333, SLG: 0.318      | 4-0<br>1B<br>BB  | 0-0<br>5-3  |   | 0-0<br>FC6-4<br>1-2f  |  | 4-0<br>FC6-4<br>BB   |   | 0-0<br>F9   |   | 3 0 0 0 2 0 2  | <b>Cincinnati Reds @ Philadelphia Phillies</b><br>Shibe Park, Philadelphia, PA<br>Wed May 17 1950, 3:33 AM EDT<br>Att. 12,655 - Unknown - 70 F |
| <b>Johnny Wrosteck, L</b> (1, 8)<br>OBP: 0.381, SLG: 0.461  | 0-0<br>F8  |   | 0-0<br>6-3<br>3B  |   | 0-0<br>F3  | 0-0<br>FC6-4<br>BB<br>1-2f                                       |   | 0-0<br>FC6-4<br>1B  |   | 5 1 2 0 0 0 2  |  |
| <b>Peanuts Lowrey, R</b> (1, 7)<br>OBP: 0.388, SLG: 0.341   | 0-0<br>1-2<br>1B   |   | 0-0<br>6-3  |   | 0-0<br>1B<br>FC1-2-5<br>1B                                       | 4-0<br>1-2<br>BB   |   | 0-0<br>FC6-4<br>1-2f  |   | 4 0 2 1 1 0 1  |  |
| <b>Ron Northey, L</b> (1, 9)<br>OBP: 0.423, SLG: 0.711      | 0-0<br>F5  |   | 0-0<br>3-H<br>2B  |   | 0-0<br>FC1-2-5<br>1B<br>1-3                                      | 0-0<br>F9  |   | 0-0<br>F4   |   | 5 1 2 0 0 0 4  |  |
| <b>Joe Adcock, R</b> (1, 3)<br>OBP: 0.176, SLG: 0.182       | 0-3<br>K   |   | 0-0<br>F7   |   | 0-0<br>FC1-2-5<br>1B<br>1-3<br>3-H                               | 0-0<br>F8  |   | 0-0<br>5-3  |   | 5 1 0 0 0 1 7  |  |
| <b>Grady Hatton, L</b> (1, 5)<br>OBP: 0.323, SLG: 0.410     |  | 4-0<br>SH5-4<br>1B<br>F9<br>BB                                  | 0-0<br>F4   |   | 4-0<br>1B<br>1-2<br>BB   |  | 0-0<br>F8   |   | 0-3<br>K  | 3 1 0 0 2 1 1  |  |
| <b>Virgil Stallcup, R</b> (1, 6)<br>OBP: 0.301, SLG: 0.388  |  | 0-0<br>F9<br>SH5-4<br>1-2<br>1B                                 |   | 0-0<br>F5   | 0-0<br>1B<br>1-2<br>2-3<br>3-H<br>1B                             |  | 0-0<br>5-3  |   |   | 4 0 2 1 0 0 0  |  |
| <b>Dixie Howell, R</b> (1, 2)<br>OBP: 0.400, SLG: 0.303     |  | 0-0<br>SH5-4<br>1-2<br>2-3<br>1B                                |   | 0-0<br>E6<br>FC6-4  | 0-0<br>1B<br>1-2<br>2-3<br>3-H<br>1B                             |  | 0-0<br>F5   |   |   | 3 0 1 1 0 0 0  |  |
| <b>Herm Wehmeier, R</b> (1, 1)<br>OBP: 0.263, SLG: 0.278    |  | 0-0<br>F9<br>2-3<br>3-H   |   | 0-0<br>F9   | 0-0<br>1-3   |  | 0-0<br>4-3  |   |   | 4 0 0 1 0 0 5  |  |
| <b>Inning Stats</b>   | R: 0<br>E: 0<br>K: 1<br>S: 6<br>H: 1<br>LOB: 2<br>BB: 1<br>P: 10   | R: 1<br>E: 0<br>K: 0<br>S: 4<br>H: 1<br>LOB: 1<br>BB: 1<br>P: 8 | R: 1<br>E: 0<br>K: 0<br>S: 5<br>H: 2<br>LOB: 1<br>BB: 0<br>P: 5 | R: 0<br>E: 1<br>K: 0<br>S: 4<br>H: 0<br>LOB: 1<br>BB: 0<br>P: 4 | R: 2<br>E: 0<br>K: 0<br>S: 7<br>H: 4<br>LOB: 3<br>BB: 1<br>P: 11 | R: 0<br>E: 0<br>K: 0<br>S: 3<br>H: 0<br>LOB: 2<br>BB: 2<br>P: 11 | R: 0<br>E: 0<br>K: 0<br>S: 3<br>H: 0<br>LOB: 0<br>BB: 0<br>P: 3 | R: 0<br>E: 0<br>K: 0<br>S: 4<br>H: 1<br>LOB: 1<br>BB: 0<br>P: 4 | R: 0<br>E: 0<br>K: 1<br>S: 5<br>H: 0<br>LOB: 0<br>BB: 0<br>P: 5 | 1B: 7<br>2B: 1<br>3B: 1<br>HR: 0<br>SF: 0<br>SAC: 1<br>DP: 0<br>HBP: 0 | WP: 0<br>PB: 0<br>SB: 0<br>CS: 0<br>PA: 42   |
| <b>PITCHER</b><br><b>Ken Johnson, L</b> (1, 1)<br>ERA: 3.96 | IP<br>9.0<br>WLS<br>W<br>BF<br>42<br>H<br>9<br>R<br>4<br>ER<br>4<br>SO<br>2<br>BB<br>5<br>IBB<br>0<br>HBP<br>0<br>BLK<br>0<br>WP<br>0<br>HR<br>0<br>S<br>41<br>P<br>61<br>ERA<br>4.00<br>WHIP<br>1.556 |   |   |   |  |  |   |   |   |  |  |

livebaseballscorecards.com

|            |    |
|------------|----|
| <b>AB</b>  | 36 |
| <b>R</b>   | 4  |
| <b>H</b>   | 9  |
| <b>RBI</b> | 4  |
| <b>BB</b>  | 5  |
| <b>SO</b>  | 2  |
| <b>LOB</b> | 22 |



| Batter | 1 | 2 | 3 | 4 | 5 | 6 | 7 | 8 | 9 | AB | R | H | RBI | BB | SO | LOB |
|--------|---|---|---|---|---|---|---|---|---|----|---|---|-----|----|----|-----|
|--------|---|---|---|---|---|---|---|---|---|----|---|---|-----|----|----|-----|

**BOTTOM**

|   |            |            |            |            |            |            |            |            |            |   |   |   |   |   |   |   |
|---|------------|------------|------------|------------|------------|------------|------------|------------|------------|---|---|---|---|---|---|---|
| <p><b>Richie Ashburn, L</b> (1, 8)<br/>OBP: 0.426, SLG: 0.410</p> |            |            | <p>0-0</p> |            |            | <p>0-0</p> |            | <p>0-0</p> |            | 4 | 1 | 1 | 0 | 0 | 0 | 0 |
| <p><b>Granny Hamner, R</b> (1, 6)<br/>OBP: 0.308, SLG: 0.324</p>  | <p>0-3</p> |            | <p>0-0</p> |            |            | <p>0-0</p> |            | <p>0-3</p> |            | 4 | 0 | 0 | 0 | 0 | 2 | 1 |
| <p><b>Eddie Waitkus, L</b> (1, 3)<br/>OBP: 0.392, SLG: 0.407</p>  |            |            | <p>0-0</p> |            |            | <p>0-0</p> |            |            | <p>0-0</p> | 4 | 1 | 1 | 1 | 0 | 0 | 0 |
| <p><b>Del Ennis, R</b> (1, 9)<br/>OBP: 0.353, SLG: 0.541</p>      | <p>0-3</p> |            |            | <p>0-0</p> |            | <p>0-0</p> |            | <p>4-0</p> | 3          | 0 | 0 | 0 | 0 | 1 | 1 | 0 |
| <p><b>Willie Jones, R</b> (1, 5)<br/>OBP: 0.369, SLG: 0.584</p>   |            | <p>0-3</p> |            | <p>0-3</p> |            | <p>4-0</p> |            | <p>0-0</p> | 3          | 1 | 1 | 1 | 1 | 2 | 0 |   |
| <p><b>Dick Sisler, L</b> (1, 7)<br/>OBP: 0.449, SLG: 0.628</p>    |            | <p>4-0</p> |            | <p>0-0</p> |            | <p>0-0</p> |            | <p>0-0</p> | 2          | 1 | 1 | 0 | 1 | 0 | 0 |   |
| <p><b>Mike Goliat, R</b> (1, 4)<br/>OBP: 0.321, SLG: 0.394</p>    |            | <p>0-0</p> |            |            | <p>0-0</p> |            | <p>0-3</p> |            | 3          | 1 | 1 | 2 | 0 | 1 | 1 |   |
| <p><b>Ken Silvestri, S</b> (1, 2)<br/>OBP: 0.429, SLG: 0.375</p>  |            | <p>0-3</p> |            |            | <p>0-0</p> |            | <p>0-0</p> |            | 2          | 0 | 0 | 0 | 0 | 1 | 0 |   |
| <p><b>Dick Whitman, L</b> (7, PH)<br/>OBP: 0.295, SLG: 0.268</p>  |            | <p>0-3</p> |            |            | <p>0-0</p> |            |            |            | 1          | 0 | 0 | 0 | 0 | 0 | 1 |   |
| <p><b>Andy Seminick, R</b> (8, 2)<br/>OBP: 0.217, SLG: 0.200</p>  |            | <p>0-0</p> |            |            | <p>0-0</p> |            |            |            | 0          | 0 | 0 | 0 | 0 | 0 | 0 |   |
| <p><b>Ken Johnson, L</b> (1, 1)<br/>OBP: 0.100, SLG: 0.100</p>    |            |            |            |            |            |            | <p>0-0</p> |            | 3          | 0 | 0 | 0 | 0 | 0 | 0 |   |

**Cincinnati Reds @ Philadelphia Phillies**  
 Shibe Park, Philadelphia, PA  
 Wed May 17 1950, 3:33 AM EDT  
 Att. 12,655 - Unknown - 70 F

livebaseballscorecards.com

|            |           |
|------------|-----------|
| <b>AB</b>  | <b>29</b> |
| <b>R</b>   | <b>5</b>  |
| <b>H</b>   | <b>5</b>  |
| <b>RBI</b> | <b>4</b>  |
| <b>BB</b>  | <b>3</b>  |
| <b>SO</b>  | <b>7</b>  |
| <b>LOB</b> | <b>3</b>  |



|  |                              |                                 |                              |                                  |                              |                                 |                              |                                 |                              |                                 |                              |                                 |                              |                                  |                              |                                 |                              |                                 |                                  |                                    |                                  |        |
|--|------------------------------|---------------------------------|------------------------------|----------------------------------|------------------------------|---------------------------------|------------------------------|---------------------------------|------------------------------|---------------------------------|------------------------------|---------------------------------|------------------------------|----------------------------------|------------------------------|---------------------------------|------------------------------|---------------------------------|----------------------------------|------------------------------------|----------------------------------|--------|
| <b>Inning Stats</b>                                    | R: 1<br>E: 0<br>K: 2<br>S: 8 | H: 1<br>LOB: 0<br>BB: 0<br>P: 8 | R: 2<br>E: 0<br>K: 2<br>S: 8 | H: 1<br>LOB: 0<br>BB: 1<br>P: 12 | R: 0<br>E: 0<br>K: 0<br>S: 3 | H: 0<br>LOB: 0<br>BB: 0<br>P: 3 | R: 0<br>E: 0<br>K: 1<br>S: 5 | H: 0<br>LOB: 0<br>BB: 0<br>P: 5 | R: 0<br>E: 0<br>K: 0<br>S: 3 | H: 0<br>LOB: 0<br>BB: 0<br>P: 3 | R: 0<br>E: 0<br>K: 0<br>S: 3 | H: 0<br>LOB: 0<br>BB: 0<br>P: 3 | R: 1<br>E: 0<br>K: 1<br>S: 6 | H: 1<br>LOB: 1<br>BB: 1<br>P: 10 | R: 0<br>E: 0<br>K: 1<br>S: 5 | H: 0<br>LOB: 0<br>BB: 0<br>P: 5 | R: 1<br>E: 0<br>K: 0<br>S: 2 | H: 2<br>LOB: 2<br>BB: 1<br>P: 6 | 1B: 2<br>2B: 0<br>3B: 2<br>HR: 1 | SF: 0<br>SAC: 0<br>DP: 0<br>HBP: 0 | WP: 1<br>PB: 0<br>SB: 1<br>CS: 0 | PA: 32 |
| <b>PITCHER</b><br>Herm Wehmeier, R (1, 1)<br>ERA: 5.31 | IP                           | WLS                             | BF                           | H                                | R                            | ER                              | SO                           | BB                              | IBB                          | HBP                             | BLK                          | WP                              | HR                           | S                                | P                            | ERA                             | WHIP                         |                                 |                                  |                                    |                                  |        |
|  | 8.0                          | L                               | 32                           | 5                                | 5                            | 5                               | 7                            | 2                               | 1                            | 0                               | 0                            | 1                               | 1                            | 43                               | 55                           | 5.62                            | 0.875                        |                                 |                                  |                                    |                                  |        |

|                |    |     |    |   |   |    |    |    |     |     |     |    |    |   |   |     |      |
|----------------|----|-----|----|---|---|----|----|----|-----|-----|-----|----|----|---|---|-----|------|
| <b>PITCHER</b> | IP | WLS | BF | H | R | ER | SO | BB | IBB | HBP | BLK | WP | HR | S | P | ERA | WHIP |
|----------------|----|-----|----|---|---|----|----|----|-----|-----|-----|----|----|---|---|-----|------|

| Batter   | 1   | 2                               | 3                            | 4                               | 5                            | 6                               | 7                            | 8                               | 9                            | AB R H RBI BB SO LOB            | TOP                          |                                 |                              |                                 |                              |                                 |                              |                                 |                                  |                                    |                                  |        |  |  |  |  |  |  |  |  |  |  |  |  |  |  |  |
|--|---|---------------------------------|------------------------------|---------------------------------|------------------------------|---------------------------------|------------------------------|---------------------------------|------------------------------|---------------------------------|------------------------------|---------------------------------|------------------------------|---------------------------------|------------------------------|---------------------------------|------------------------------|---------------------------------|----------------------------------|------------------------------------|----------------------------------|--------|--|--|--|--|--|--|--|--|--|--|--|--|--|--|--|
| <b>Bobby Adams, R</b> (1, 4)<br>OBP: 0.316, SLG: 0.300     | 0-0<br>F9   |                                 | 0-0<br>L7-4-6                |                                 |                              | 0-0<br>5-3                      |                              | 0-3<br>K                        |                              | 4 0 0 0 0 1 1                   |                              |                                 |                              |                                 |                              |                                 |                              |                                 |                                  |                                    |                                  |        |  |  |  |  |  |  |  |  |  |  |  |  |  |  |  |
| <b>Johnny Wrostek, L</b> (1, 8)<br>OBP: 0.364, SLG: 0.438  | 0-3<br>K  |                                 |                              | 0-0<br>F6                       |                              | 0-0<br>1-3                      |                              | 0-0<br>5-3                      |                              | 4 0 0 0 0 1 0                   |                              |                                 |                              |                                 |                              |                                 |                              |                                 |                                  |                                    |                                  |        |  |  |  |  |  |  |  |  |  |  |  |  |  |  |  |
| <b>Peanuts Lowrey, R</b> (1, 7)<br>OBP: 0.358, SLG: 0.311  | 0-0<br>F7   |                                 |                              | 0-0<br>F4                       |                              | 0-0<br>E6                       |                              |                                 | 0-0<br>F3                    | 4 0 0 0 0 0 0                   |                              |                                 |                              |                                 |                              |                                 |                              |                                 |                                  |                                    |                                  |        |  |  |  |  |  |  |  |  |  |  |  |  |  |  |  |
| <b>Ron Northey, L</b> (1, 9)<br>OBP: 0.429, SLG: 0.681     |   | 4-0<br>BB                       |                              | 0-0<br>E3<br>1B                 |                              | 0-0<br>F9                       |                              |                                 | 4-0<br>BB                    | 2 0 0 0 2 0 1                   |                              |                                 |                              |                                 |                              |                                 |                              |                                 |                                  |                                    |                                  |        |  |  |  |  |  |  |  |  |  |  |  |  |  |  |  |
| <b>Grady Hatton, L</b> (1, 5)<br>OBP: 0.330, SLG: 0.407    |   | 0-0<br>F3                       |                              | 0-0<br>1B                       |                              |                                 | 4-0<br>BB                    |                                 | 0-0<br>F7                    | 3 0 1 0 1 0 2                   |                              |                                 |                              |                                 |                              |                                 |                              |                                 |                                  |                                    |                                  |        |  |  |  |  |  |  |  |  |  |  |  |  |  |  |  |
| <b>Virgil Stallcup, R</b> (1, 6)<br>OBP: 0.287, SLG: 0.369 |   | 0-0<br>F7                       |                              | 0-0<br>F6                       |                              |                                 | 0-0<br>L5-3                  |                                 | 0-0<br>F4                    | 4 0 0 0 0 0 5                   |                              |                                 |                              |                                 |                              |                                 |                              |                                 |                                  |                                    |                                  |        |  |  |  |  |  |  |  |  |  |  |  |  |  |  |  |
| <b>Joe Adcock, R</b> (1, 3)<br>OBP: 0.189, SLG: 0.194      |   | 0-0<br>F6                       |                              |                                 | 0-0<br>L5                    |                                 |                              |                                 |                              | 3 0 1 0 0 0 1                   |                              |                                 |                              |                                 |                              |                                 |                              |                                 |                                  |                                    |                                  |        |  |  |  |  |  |  |  |  |  |  |  |  |  |  |  |
| <b>Dixie Howell, R</b> (1, 2)<br>OBP: 0.385, SLG: 0.286    |   |                                 | 4-0<br>L7-4-6<br>SH1-4<br>BB |                                 | 0-0<br>6-3                   |                                 |                              |                                 |                              | 2 0 0 0 1 0 1                   |                              |                                 |                              |                                 |                              |                                 |                              |                                 |                                  |                                    |                                  |        |  |  |  |  |  |  |  |  |  |  |  |  |  |  |  |
| <b>Ewell Blackwell, R</b> (1, 1)<br>OBP: 0.231, SLG: 0.091 |   |                                 | 0-0<br>SH1-4                 |                                 | 0-0<br>1-3                   |                                 |                              |                                 | 0-0<br>F9                    | 1 0 0 0 0 0 0                   |                              |                                 |                              |                                 |                              |                                 |                              |                                 |                                  |                                    |                                  |        |  |  |  |  |  |  |  |  |  |  |  |  |  |  |  |
| <b>Sammy Meeks, R</b> (8, PH)                              |   |                                 |                              |                                 |                              |                                 |                              |                                 |                              | 1 0 0 0 0 0 0                   |                              |                                 |                              |                                 |                              |                                 |                              |                                 |                                  |                                    |                                  |        |  |  |  |  |  |  |  |  |  |  |  |  |  |  |  |
| <b>Eddie Erault, R</b> (8, 1)                              |   |                                 |                              |                                 |                              |                                 |                              |                                 |                              | 0 0 0 0 0 0 0                   |                              |                                 |                              |                                 |                              |                                 |                              |                                 |                                  |                                    |                                  |        |  |  |  |  |  |  |  |  |  |  |  |  |  |  |  |
| <b>Johnny Hetki, R</b> (8, 1)                              |   |                                 |                              |                                 |                              |                                 |                              |                                 |                              | 0 0 0 0 0 0 0                   |                              |                                 |                              |                                 |                              |                                 |                              |                                 |                                  |                                    |                                  |        |  |  |  |  |  |  |  |  |  |  |  |  |  |  |  |
| <b>Inning Stats</b>  | R: 0<br>E: 0<br>K: 1<br>S: 5                          | H: 0<br>LOB: 0<br>BB: 0<br>P: 5 | R: 0<br>E: 0<br>K: 0<br>S: 3 | H: 0<br>LOB: 1<br>BB: 1<br>P: 7 | R: 0<br>E: 0<br>K: 0<br>S: 2 | H: 0<br>LOB: 0<br>BB: 1<br>P: 6 | R: 0<br>E: 1<br>K: 0<br>S: 5 | H: 1<br>LOB: 2<br>BB: 0<br>P: 5 | R: 0<br>E: 0<br>K: 0<br>S: 3 | H: 0<br>LOB: 0<br>BB: 0<br>P: 3 | R: 0<br>E: 1<br>K: 0<br>S: 4 | H: 0<br>LOB: 1<br>BB: 0<br>P: 4 | R: 0<br>E: 0<br>K: 0<br>S: 3 | H: 1<br>LOB: 1<br>BB: 1<br>P: 7 | R: 0<br>E: 0<br>K: 1<br>S: 5 | H: 0<br>LOB: 0<br>BB: 0<br>P: 5 | R: 0<br>E: 0<br>K: 0<br>S: 3 | H: 0<br>LOB: 1<br>BB: 1<br>P: 7 | 1B: 2<br>2B: 2<br>3B: 0<br>HR: 0 | SF: 0<br>SAC: 1<br>DP: 2<br>HBP: 0 | WP: 0<br>PB: 0<br>SB: 0<br>CS: 0 | PA: 33 |  |  |  |  |  |  |  |  |  |  |  |  |  |  |  |
| <b>PITCHER</b>   | IP WLS BF H R ER SO BB IBB HBP BLK WP HR S P ERA WHIP |                                 |                              |                                 |                              |                                 |                              |                                 |                              |                                 |                              |                                 |                              |                                 |                              |                                 |                              |                                 |                                  |                                    |                                  |        |  |  |  |  |  |  |  |  |  |  |  |  |  |  |  |
| <b>Monty Kennedy, L</b> (1, 1)<br>ERA: 3.2                 | 0.1   | 1                               | 0                            | 0                               | 0                            | 0                               | 0                            | 0                               | 0                            | 0                               | 0                            | 0                               | 0                            | 1                               | 1                            | 0.00                            | 0.000                        |                                 |                                  |                                    |                                  |        |  |  |  |  |  |  |  |  |  |  |  |  |  |  |  |
| <b>Dave Koslo, L</b> (1, 1)<br>ERA: 3.48                   | 8.2   | W                               | 32                           | 2                               | 0                            | 0                               | 2                            | 4                               | 0                            | 0                               | 0                            | 0                               | 0                            | 32                              | 48                           | 0.00                            | 0.692                        |                                 |                                  |                                    |                                  |        |  |  |  |  |  |  |  |  |  |  |  |  |  |  |  |

Cincinnati Reds @ New York Giants  
Polo Grounds, New York, NY  
Sat May 20 1950, 3:33 AM EDT  
Cloudy - 55 F

livebaseballscorecards.com

|     |    |
|-----|----|
| AB  | 28 |
| R   | 0  |
| H   | 2  |
| RBI | 0  |
| BB  | 4  |
| SO  | 2  |
| LOB | 11 |



| Batter   | 1                 | 2                | 3                       | 4                 | 5                         | 6                | 7                             | 8                              | 9 |
|--|-------------------|------------------|-------------------------|-------------------|---------------------------|------------------|-------------------------------|--------------------------------|---|
| Eddie Stanky, R<br>OBP: 0.490, SLG: 0.421 (1, 4)   | 0-0<br>FC5<br>2B  |                  | 4-0<br>1B<br>HR<br>BB   | 0-0<br>F7         |                           | 4-0<br>1-2<br>BB |                               | 0-0<br>1B<br>1B                |   |
| Whitey Lockman, L<br>OBP: 0.347, SLG: 0.389 (1, 7) | 0-0<br>F6         |                  | 0-0<br>1-2<br>HR<br>1B  |                   | 0-0<br>G3                 | 0-0<br>1-3       |                               | 0-0<br>F5                      |   |
| Monte Irvin, R<br>OBP: 0.429, SLG: 0.846 (1, 9)    | 0-0<br>1-3        |                  | 0-0<br>1-H<br>2-H<br>HR |                   | 1-0<br>BB<br>HBP          |                  | 0-0<br>5-3                    | 0-0<br>1-3<br>1B<br>1B         |   |
| Bobby Thomson, R<br>OBP: 0.344, SLG: 0.430 (1, 8)  | 0-0<br>FC5<br>2-3 |                  | 0-0<br>F2               |                   | 0-0<br>F6                 |                  | 0-0<br>5-3                    | 4-0<br>1-2<br>1B<br>BB         |   |
| Hank Thompson, L<br>OBP: 0.444, SLG: 0.532 (1, 5)  |                   | 0-0<br>4-3       | 0-0<br>G6-4-3<br>1B     |                   | 4-0<br>1-2<br>FC4-6<br>BB |                  | 0-0<br>E<br>1B<br>1B          | 0-0<br>1-3<br>2-H<br>3-H<br>1B |   |
| Wes Westrum, R<br>OBP: 0.429, SLG: 0.421 (1, 2)    |                   | 0-3<br>K         | 0-0<br>G6-4-3           |                   | 0-0<br>FC4-6              |                  | 0-0<br>E2<br>1B<br>2B         | 0-0<br>F6                      |   |
| Alvin Dark, R<br>OBP: 0.315, SLG: 0.360 (1, 6)     |                   | 0-0<br>2B<br>1B  |                         | 0-0<br>4-3<br>2B  |                           | 0-0<br>BB<br>1B  | 0-0<br>1-2<br>3-H<br>2B<br>1B | 0-0<br>4-3                     |   |
| Tookie Gilbert, L<br>OBP: 0.308, SLG: 0.362 (1, 3) |                   | 0-0<br>1-3<br>2B |                         | 0-0<br>4-3<br>2-3 |                           | 0-0<br>F8        | 0-0<br>1-H<br>2-H<br>2B       |                                |   |
| Monty Kennedy, R<br>OBP: 0.100, SLG: 0.100 (1, 1)  |                   | 0-0<br>4-3       |                         | 0-3<br>K          |                           | 0-0<br>F7        | 0-3<br>K                      |                                |   |
| Dave Koslo, L<br>(1, 1)                            |                   |                  |                         |                   |                           |                  |                               |                                |   |

| Inning Stats | R: 0 | H: 1 | E: 0 | K: 0 | S: 4 | LOB: 1 | BB: 0 | P: 4  |
|--------------|------|------|------|------|------|--------|-------|-------|
|              | R: 0 | H: 2 | E: 0 | K: 1 | S: 7 | LOB: 2 | BB: 0 | P: 7  |
|              | R: 3 | H: 3 | E: 0 | K: 0 | S: 5 | LOB: 0 | BB: 1 | P: 9  |
|              | R: 0 | H: 1 | E: 0 | K: 1 | S: 6 | LOB: 1 | BB: 0 | P: 6  |
|              | R: 0 | H: 0 | E: 0 | K: 0 | S: 3 | LOB: 2 | BB: 1 | P: 8  |
|              | R: 0 | H: 1 | E: 0 | K: 0 | S: 4 | LOB: 2 | BB: 1 | P: 8  |
|              | R: 3 | H: 3 | E: 1 | K: 1 | S: 9 | LOB: 1 | BB: 0 | P: 9  |
|              | R: 2 | H: 3 | E: 0 | K: 0 | S: 6 | LOB: 2 | BB: 1 | P: 10 |

| PITCHER                                | IP  | WLS | BF | H  | R | ER | SO | BB | IBB | HBP | BLK | WP | HR | S  | P  | ERA   | WHIP   |
|--|-----|-----|----|----|---|----|----|----|-----|-----|-----|----|----|----|----|-------|--------|
| Ewell Blackwell, R<br>ERA: 1.91 (1, 1) | 7.0 | L   | 36 | 11 | 6 | 3  | 3  | 3  | 3   | 0   | 0   | 0  | 1  | 38 | 51 | 3.86  | 2.000  |
| Eddie Erault, R<br>ERA: 8.15 (8, 1)    | 0.1 |     | 5  | 3  | 2 | 2  | 0  | 1  | 0   | 0   | 0   | 0  | 0  | 4  | 8  | 54.00 | 12.000 |
| Johnny Hetki, R<br>ERA: 8.25 (8, 1)    | 0.2 |     | 2  | 0  | 0 | 0  | 0  | 0  | 0   | 0   | 0   | 0  | 0  | 2  | 2  | 0.00  | 0.000  |

**BOTTOM**

**Cincinnati Reds @ New York Giants**  
**Polo Grounds, New York, NY**  
 Sat May 20 1950, 3:33 AM EDT  
 Cloudy - 55 F

| AB | R | H | RBI | BB | SO | LOB |
|----|---|---|-----|----|----|-----|
| 3  | 2 | 2 | 0   | 2  | 0  | 1   |
| 5  | 1 | 1 | 0   | 0  | 0  | 4   |
| 4  | 2 | 2 | 3   | 0  | 0  | 1   |
| 4  | 0 | 0 | 0   | 1  | 0  | 2   |
| 4  | 1 | 3 | 2   | 1  | 0  | 0   |
| 5  | 1 | 0 | 0   | 0  | 1  | 6   |
| 5  | 1 | 4 | 1   | 0  | 0  | 2   |
| 4  | 0 | 2 | 2   | 0  | 0  | 2   |
| 0  | 0 | 0 | 0   | 0  | 0  | 0   |
| 4  | 0 | 0 | 0   | 0  | 2  | 5   |

| AB  | 38 |
|-----|----|
| R   | 8  |
| H   | 14 |
| RBI | 8  |
| BB  | 4  |
| SO  | 3  |
| LOB | 23 |



| WP | PA |
|----|----|
| 0  | 43 |

| 1B | SF  | WP | PA |
|----|-----|----|----|
| 9  | 0   | 0  | 43 |
| 2B | SAC | PB |    |
| 4  | 0   | 0  |    |
| 3B | DP  | SB |    |
| 0  | 1   | 0  |    |
| HR | HBP | CS |    |
| 1  | 1   | 0  |    |

[livebaseballscorecards.com](http://livebaseballscorecards.com)

| Batter  | 1  | 2   | 3   | 4   | 5   | 6   | 7   | 8   | 9   | AB R H RBI BB SO LOB   | TOP  |
|---|--|---|---|---|---|---|---|---|---|--|--|
| <b>Bobby Adams, R</b> (1, 4)<br>OBP: 0.313, SLG: 0.338  | 0-0<br>F3  |   | 0-0<br>F4   |   |   | 0-0<br>F3   |   |   | 0-0<br>HR   | 4 1 1 1 0 0 0  | <b>Cincinnati Reds @ New York Giants</b><br>Polo Grounds, New York, NY<br>Sat May 20 1950, 3:38 AM EDT<br>Att. 9,302 - Overcast - 66 F |
| <b>Peanuts Lowrey, R</b> (1, 7)<br>OBP: 0.368, SLG: 0.327   | 0-0<br>FC6-4<br>1B   |   |   | 0-0<br>6-3  |   |   | 0-0<br>HR<br>1B   | 0-0<br>F9   | 4 1 2 0 0 0 0   |  |  |
| <b>Bob Usher, R</b> (1, 8)<br>OBP: 0.320, SLG: 0.565  | 0-0<br>FC6-4<br>1-2f   |   |   | 0-0<br>6-3  |   |   | 0-0<br>1-H<br>HR  | 0-0<br>6-3  | 4 1 1 2 0 0 1   |  |  |
| <b>Ron Northey, L</b> (1, 9)<br>OBP: 0.400, SLG: 0.627  | 0-0<br>G3  |   |   | 0-0<br>G3   |   |   | 0-0<br>F9   | 0-0<br>F4   | 4 0 0 0 0 0 1   |  |  |
| <b>Johnny Pramesa, R</b> (1, 2)<br>OBP: 0.300, SLG: 0.667   |  | 4-0<br>BB<br>G6-4-3<br>BB                                       |   |   | 0-0<br>F3   |   | 0-0<br>6-3  |   | 2 0 0 0 1 0 0   |  |  |
| <b>Sammy Meeks, R</b> (1, 5)  |  | 0-0<br>G6-4-3<br>1-2f   |   |   | 0-0<br>1-3  |   | 0-0<br>F8   |   | 3 0 0 0 0 0 1   |  |  |
| <b>Virgil Stallcup, R</b> (1, 6)<br>OBP: 0.278, SLG: 0.356  |  | 0-0<br>F2   |   |   | 0-0<br>4-3  |   | 0-0<br>F8   |   | 3 0 0 0 0 0 0   |  |  |
| <b>Joe Adcock, R</b> (1, 3)<br>OBP: 0.175, SLG: 0.179   |  |   | 0-0<br>F7   |   |   | 0-0<br>F2   |   | 0-0<br>F8   | 3 0 0 0 0 0 0   |  |  |
| <b>Ken Raffensberger, R</b> (1, 1)<br>OBP: 0.077, SLG: 0.077<br><b>Danny Litwhiler, R</b> (8, PH)<br>OBP: 0.286, SLG: 0.290<br><b>Willie Ramsdell, R</b> (8, 1) |  |   | 0-0<br>F7   |   |   | 0-0<br>5-3  |   | 0-3<br>K  | 2 0 0 0 0 0 0<br>1 0 0 0 0 1 0<br>0 0 0 0 0 0 0   |  |  |
| <b>Inning Stats</b>   | R: 0<br>E: 0<br>K: 0<br>S: 4<br>H: 1<br>LOB: 1<br>BB: 0<br>P: 4  | R: 0<br>E: 0<br>K: 0<br>S: 2<br>H: 0<br>LOB: 0<br>BB: 1<br>P: 6 | R: 0<br>E: 0<br>K: 0<br>S: 3<br>H: 0<br>LOB: 0<br>BB: 0<br>P: 3 | R: 0<br>E: 0<br>K: 0<br>S: 3<br>H: 0<br>LOB: 0<br>BB: 0<br>P: 3 | R: 0<br>E: 0<br>K: 0<br>S: 3<br>H: 0<br>LOB: 0<br>BB: 0<br>P: 3 | R: 0<br>E: 0<br>K: 0<br>S: 3<br>H: 0<br>LOB: 0<br>BB: 0<br>P: 3 | R: 2<br>E: 0<br>K: 0<br>S: 5<br>H: 2<br>LOB: 0<br>BB: 0<br>P: 5 | R: 0<br>E: 0<br>K: 1<br>S: 5<br>H: 0<br>LOB: 0<br>BB: 0<br>P: 5 | R: 1<br>E: 0<br>K: 0<br>S: 4<br>H: 1<br>LOB: 0<br>BB: 0<br>P: 4   | 1B: 2<br>2B: 0<br>3B: 0<br>HR: 2<br>SF: 0<br>SAC: 0<br>DP: 1<br>HBP: 0 | WP: 0<br>PB: 0<br>SB: 0<br>CS: 0<br>PA: 31   |
| <b>PITCHER</b><br><b>Monty Kennedy, L</b> (1, 1)<br>ERA: 3.15   | IP: 9.0<br>WLS: W<br>BF: 31<br>H: 4<br>R: 3<br>ER: 3<br>SO: 1<br>BB: 1<br>IBB: 0<br>HBP: 0<br>BLK: 0<br>WP: 0<br>HR: 2<br>S: 32<br>P: 36<br>ERA: 3.00<br>WHIP: 0.556 |   |   |   |   |   |   | <b>PITCHER</b>  | IP: 0.0<br>WLS: 0<br>BF: 0<br>H: 0<br>R: 0<br>ER: 0<br>SO: 0<br>BB: 0<br>IBB: 0<br>HBP: 0<br>BLK: 0<br>WP: 0<br>HR: 0<br>S: 0<br>P: 0<br>ERA: 0.00<br>WHIP: 0.000 |  |  |

livebaseballscorecards.com

|            |    |
|------------|----|
| <b>AB</b>  | 30 |
| <b>R</b>   | 3  |
| <b>H</b>   | 4  |
| <b>RBI</b> | 3  |
| <b>BB</b>  | 1  |
| <b>SO</b>  | 1  |
| <b>LOB</b> | 3  |



| Batter   | 1                                | 2         | 3         | 4                      | 5         | 6          | 7         | 8         | 9                          | AB | R | H | RBI | BB | SO | LOB |
|--|----------------------------------|-----------|-----------|------------------------|-----------|------------|-----------|-----------|----------------------------|----|---|---|-----|----|----|-----|
| Eddie Stanky, R<br>OBP: 0.472, SLG: 0.400 (1, 4)   | 0-3<br>K                         |           | 0-0<br>F8 |                        | 0-0<br>F8 |            | 0-0<br>F9 |           |                            | 4  | 0 | 0 | 0   | 0  | 1  | 0   |
| Whitey Lockman, L<br>OBP: 0.343, SLG: 0.376 (1, 7)   | 4-0<br>BB<br>1B<br>BB            |           | 0-0<br>G3 |                        | 0-3<br>K  |            |           | 0-0<br>F4 |                            | 3  | 1 | 0 | 0   | 1  | 1  | 0   |
| Monte Irvin, R<br>OBP: 0.333, SLG: 0.647 (1, 9)  | 0-0<br>F9                        |           | 0-3<br>K  |                        |           | 0-0<br>5-3 |           | 0-3<br>K  |                            | 4  | 0 | 0 | 0   | 0  | 2  | 1   |
| Bobby Thomson, R<br>OBP: 0.360, SLG: 0.483 (1, 8)  | 4-0<br>1B<br>1-2<br>BB           |           |           | 0-0<br>6-3<br>1B<br>2B |           | 0-0<br>HR  |           | 0-0<br>F9 |                            | 3  | 2 | 2 | 1   | 1  | 0  | 0   |
| Bill Rigney, R<br>OBP: 0.429, SLG: 0.273 (1, 5)<br>Hank Thompson, L<br>OBP: 0.451, SLG: 0.532 (9, PH)      | 0-0<br>FC6-4<br>1-3<br>2-H<br>1B |           |           | 0-3<br>K               |           | 0-0<br>1B  |           |           | 4-0<br>FC3-6<br>BB         | 3  | 0 | 2 | 1   | 0  | 1  | 1   |
| Alvin Dark, R<br>OBP: 0.301, SLG: 0.344 (1, 6)   | 0-0<br>FC6-4<br>1-2f             |           |           | 0-0<br>6-3<br>2-3      |           | 0-0<br>F7  |           |           | 0-0<br>FC3-6<br>1B<br>1-2f | 4  | 1 | 0 | 0   | 0  | 0  | 5   |
| Sam Calderone, R<br>OBP: 0.200, SLG: 0.200 (1, 2)<br>Spider Jorgensen, L<br>OBP: 0.304, SLG: 0.353 (9, PH) |                                  | 0-0<br>F8 |           | 0-0<br>1B              |           | 0-0<br>F8  |           |           | 4-0<br>1B<br>1-2<br>BB     | 3  | 0 | 1 | 1   | 0  | 0  | 1   |
| Tookie Gilbert, L<br>OBP: 0.304, SLG: 0.353 (1, 3)   |                                  | 0-0<br>F7 |           | 0-0<br>4-3             |           |            | 0-0<br>L4 |           | 0-0<br>1B                  | 4  | 0 | 1 | 1   | 0  | 0  | 1   |
| Monty Kennedy, R<br>OBP: 0.077, SLG: 0.077 (1, 1)  |                                  | 0-0<br>F8 |           |                        | 0-0<br>F7 |            |           |           |                            | 3  | 0 | 0 | 0   | 0  | 0  | 0   |

| Inning Stats                             | R: 1 | H: 1 | E: 0 | K: 1 | S: 6 | LOB: 2 | BB: 2 | P: 14 | R: 0 | H: 0 | E: 0 | K: 0 | S: 3 | LOB: 0 | BB: 0 | P: 3 | R: 0  | H: 0 | E: 0 | K: 1 | S: 5 | LOB: 0 | BB: 0 | P: 5 | R: 1 | H: 2 | E: 0 | K: 1 | S: 7 | LOB: 1 | BB: 0 | P: 7 | R: 0 | H: 0 | E: 0 | K: 1 | S: 5 | LOB: 0 | BB: 0 | P: 5 | R: 1 | H: 2 | E: 0 | K: 0 | S: 5 | LOB: 1 | BB: 0 | P: 5 | R: 0 | H: 0 | E: 0 | K: 0 | S: 3 | LOB: 0 | BB: 0 | P: 3 | R: 0 | H: 0 | E: 0 | K: 1 | S: 5 | LOB: 0 | BB: 0 | P: 5 | R: 1 | H: 1 | E: 0 | K: 0 | S: 2 | LOB: 2 | BB: 2 | P: 10 | 1B: 4 | SF: 0 | 2B: 1 | SAC: 0 | 3B: 0 | DP: 0 | HR: 1 | HBP: 0 | WP: 0 | PA: 35 |
|--|------|------|------|------|------|--------|-------|-------|------|------|------|------|------|--------|-------|------|-------|------|------|------|------|--------|-------|------|------|------|------|------|------|--------|-------|------|------|------|------|------|------|--------|-------|------|------|------|------|------|------|--------|-------|------|------|------|------|------|------|--------|-------|------|------|------|------|------|------|--------|-------|------|------|------|------|------|------|--------|-------|-------|-------|-------|-------|--------|-------|-------|-------|--------|-------|--------|
| PITCHER                                  | IP   | WLS  | BF   | H    | R    | ER     | SO    | BB    | IBB  | HBP  | BLK  | WP   | HR   | S      | P     | ERA  | WHIP  |      |      |      |      |        |       |      |      |      |      |      |      |        |       |      |      |      |      |      |      |        |       |      |      |      |      |      |      |        |       |      |      |      |      |      |      |        |       |      |      |      |      |      |      |        |       |      |      |      |      |      |      |        |       |       |       |       |       |        |       |       |       |        |       |        |
| Ken Raffensberger, L<br>ERA: 4.65 (1, 1) | 7.0  |      | 28   | 5    | 3    | 3      | 4     | 2     | 0    | 0    | 0    | 0    | 1    | 34     | 42    | 3.86 | 1.000 |      |      |      |      |        |       |      |      |      |      |      |      |        |       |      |      |      |      |      |      |        |       |      |      |      |      |      |      |        |       |      |      |      |      |      |      |        |       |      |      |      |      |      |      |        |       |      |      |      |      |      |      |        |       |       |       |       |       |        |       |       |       |        |       |        |
| Willie Ramsdell, R<br>ERA: 3.12 (8, 1)   | 1.1  | L    | 7    | 1    | 1    | 1      | 1     | 2     | 0    | 0    | 0    | 0    | 0    | 7      | 15    | 6.75 | 2.250 |      |      |      |      |        |       |      |      |      |      |      |      |        |       |      |      |      |      |      |      |        |       |      |      |      |      |      |      |        |       |      |      |      |      |      |      |        |       |      |      |      |      |      |      |        |       |      |      |      |      |      |      |        |       |       |       |       |       |        |       |       |       |        |       |        |

**BOTTOM**

**Cincinnati Reds @ New York Giants**  
 Polo Grounds, New York, NY  
 Sat May 20 1950, 3:38 AM EDT  
 Att. 9,302 - Overcast - 66 F

|            |           |
|------------|-----------|
| <b>AB</b>  | <b>31</b> |
| <b>R</b>   | <b>4</b>  |
| <b>H</b>   | <b>6</b>  |
| <b>RBI</b> | <b>4</b>  |
| <b>BB</b>  | <b>4</b>  |
| <b>SO</b>  | <b>5</b>  |
| <b>LOB</b> | <b>9</b>  |



| WP | HR | S | P | ERA  | WHIP  |
|----|----|---|---|------|-------|
| 0  | 1  | 1 | 1 | 6.75 | 2.250 |

| Batter  | 1   | 2                                | 3                             | 4                                | 5                            | 6                                | 7                             | 8                                | 9                            | AB R H RBI BB SO LOB                            | TOP                          |                                  |                               |                                  |                               |                                  |                               |                                  |                                  |                                    |                                  |        |  |  |  |  |  |
|---|---|----------------------------------|-------------------------------|----------------------------------|------------------------------|----------------------------------|-------------------------------|----------------------------------|------------------------------|---|------------------------------|----------------------------------|-------------------------------|----------------------------------|-------------------------------|----------------------------------|-------------------------------|----------------------------------|----------------------------------|------------------------------------|----------------------------------|--------|--|--|--|--|--|
| <b>Bobby Adams, R</b><br>OBP: 0.318, SLG: 0.333<br>(1, 4)   | 1-1<br>F8   |                                  | 0-1<br>5-3                    | 2-0<br>FC6-4                     |                              |                                  | 4-2<br>1B BB                  | 1-0<br>1B                        |                              | 4 0 1 0 1 0 2                                   |                              |                                  |                               |                                  |                               |                                  |                               |                                  |                                  |                                    |                                  |        |  |  |  |  |  |
| <b>Peanuts Lowrey, R</b><br>OBP: 0.371, SLG: 0.321<br>(1, 7)  | 1-1<br>F7   |                                  | 0-0<br>F8                     |                                  | 4-1<br>BB                    |                                  | 1-2<br>1B                     | 1-1<br>1-3                       |                              | 4 0 1 0 1 0 1                                   |                              |                                  |                               |                                  |                               |                                  |                               |                                  |                                  |                                    |                                  |        |  |  |  |  |  |
| <b>Johnny Wyrostek, L</b><br>OBP: 0.376, SLG: 0.482<br>(1, 9)<br>(8, 3)   | 2-1<br>1B   |                                  | 0-0<br>HR                     |                                  | 0-0<br>G3-6-1-4              |                                  | 3-2<br>G4-6-3                 |                                  | 1-0<br>WP BB<br>F8<br>1B     | 5 2 3 1 0 0 3                                   |                              |                                  |                               |                                  |                               |                                  |                               |                                  |                                  |                                    |                                  |        |  |  |  |  |  |
| <b>Bob Usher, R</b><br>OBP: 0.302, SLG: 0.531<br><b>Lloyd Merriman, L</b><br>OBP: 0.410, SLG: 0.424<br>(1, 8)<br>(8, PH)<br>(8, 8)  | 1-3<br>K  |                                  | 3-3<br>K                      |                                  | 3-3<br>K                     |                                  |                               | 4-2<br>1B 1B<br>L7<br>BB         | 4-2<br>F8 WP<br>1B<br>BB     | 3 0 0 0 0 3 1<br>0 1 0 0 2 0 0                  |                              |                                  |                               |                                  |                               |                                  |                               |                                  |                                  |                                    |                                  |        |  |  |  |  |  |
| <b>Johnny Pramesa, R</b><br>OBP: 0.333, SLG: 0.538<br>(1, 2)  |   | 1-0<br>5-3                       |                               | 1-0<br>F9                        |                              | 1-1<br>F8                        |                               | 2-2<br>1B<br>HR<br>1B            | 4-0<br>BB<br>BB              | 4 1 1 0 1 0 0                                   |                              |                                  |                               |                                  |                               |                                  |                               |                                  |                                  |                                    |                                  |        |  |  |  |  |  |
| <b>Grady Hatton, L</b><br>OBP: 0.353, SLG: 0.456<br>(1, 5)  |   | 1-0<br>HR<br>HBP                 |                               | 2-1<br>CS<br>1B                  |                              | 2-2<br>HR                        |                               | 1-0<br>1B<br>HR<br>1B            | 2-1<br>F8                    | 4 3 3 2 0 0 2                                   |                              |                                  |                               |                                  |                               |                                  |                               |                                  |                                  |                                    |                                  |        |  |  |  |  |  |
| <b>Virgil Stallcup, R</b><br>OBP: 0.284, SLG: 0.413<br>(1, 6)   |   | 1-2<br>HR                        |                               | 1-2<br>1B<br>3B                  |                              | 0-0<br>6-3                       |                               | 0-1<br>L7                        | 0-3<br>K                     | 5 2 2 3 0 1 4                                   |                              |                                  |                               |                                  |                               |                                  |                               |                                  |                                  |                                    |                                  |        |  |  |  |  |  |
| <b>Joe Adcock, R</b><br>OBP: 0.186, SLG: 0.190<br><b>Ted Kluszewski, L</b><br>OBP: 0.261, SLG: 0.394<br><b>Danny Litwhiler, R</b><br>OBP: 0.324, SLG: 0.406<br>(1, 3)<br>(8, PH)<br>(8, PH)<br>(8, 9) |   | 1-3<br>K                         |                               | 3-2<br>E<br>1B                   |                              | 1-3<br>K                         |                               | 1-1<br>HR                        | 4-1<br>BB                    | 3 0 1 1 0 2 0<br>0 0 0 0 0 0 0<br>1 1 1 3 1 0 0 |                              |                                  |                               |                                  |                               |                                  |                               |                                  |                                  |                                    |                                  |        |  |  |  |  |  |
| <b>Herm Wehmeier, R</b><br>OBP: 0.250, SLG: 0.304<br>(1, 1)   |   | 3-2<br>F7                        |                               | 0-0<br>E5<br>FC6-4               |                              |                                  | 0-0<br>1B<br>2B               | 3-2<br>F9                        | 3-2<br>F4                    | 5 0 1 0 0 0 4                                   |                              |                                  |                               |                                  |                               |                                  |                               |                                  |                                  |                                    |                                  |        |  |  |  |  |  |
| <b>Inning Stats</b>   | R: 0<br>E: 0<br>K: 1<br>S: 9                          | H: 1<br>LOB: 1<br>BB: 0<br>P: 14 | R: 2<br>E: 0<br>K: 1<br>S: 11 | H: 1<br>LOB: 0<br>BB: 0<br>P: 18 | R: 1<br>E: 0<br>K: 1<br>S: 7 | H: 1<br>LOB: 0<br>BB: 0<br>P: 10 | R: 1<br>E: 1<br>K: 0<br>S: 11 | H: 3<br>LOB: 2<br>BB: 0<br>P: 20 | R: 0<br>E: 0<br>K: 1<br>S: 5 | H: 0<br>LOB: 0<br>BB: 1<br>P: 12                | R: 1<br>E: 0<br>K: 1<br>S: 9 | H: 1<br>LOB: 0<br>BB: 0<br>P: 13 | R: 0<br>E: 0<br>K: 0<br>S: 10 | H: 2<br>LOB: 1<br>BB: 1<br>P: 18 | R: 4<br>E: 0<br>K: 0<br>S: 19 | H: 4<br>LOB: 1<br>BB: 1<br>P: 32 | R: 1<br>E: 0<br>K: 1<br>S: 16 | H: 1<br>LOB: 3<br>BB: 3<br>P: 34 | 1B: 8<br>2B: 1<br>3B: 1<br>HR: 4 | SF: 0<br>SAC: 0<br>DP: 2<br>HBP: 1 | WP: 1<br>PB: 0<br>SB: 0<br>CS: 1 | PA: 45 |  |  |  |  |  |
| <b>PITCHER</b>  | IP WLS BF H R ER SO BB IBB HBP BLK WP HR S P ERA WHIP |                                  |                               |                                  |                              |                                  |                               |                                  |                              |   |                              |                                  |                               |                                  |                               |                                  |                               |                                  |                                  |                                    |                                  |        |  |  |  |  |  |
| <b>Preacher Roe, L</b><br>ERA: 3.66<br>(1, 1)   | 6.0   |                                  | 27                            | 8                                | 5                            | 5                                | 5                             | 1                                | 0                            | 1   | 0                            | 0                                | 3                             | 53                               | 88                            | 7.50                             | 1.500                         |                                  |                                  |                                    |                                  |        |  |  |  |  |  |
| <b>Jack Banta, R</b><br>ERA: 1.89<br>(7, 1)   | 1.1   | L                                | 7                             | 3                                | 3                            | 3                                | 0                             | 2                                | 0                            | 0   | 0                            | 0                                | 0                             | 17                               | 32                            | 20.25                            | 3.750                         |                                  |                                  |                                    |                                  |        |  |  |  |  |  |
| <b>Joe Hatten, L</b><br>ERA: 4.6<br>(8, 1)  | 0.2   |                                  | 4                             | 2                                | 1                            | 1                                | 0                             | 0                                | 0                            | 0   | 0                            | 0                                | 1                             | 11                               | 17                            | 13.50                            | 3.000                         |                                  |                                  |                                    |                                  |        |  |  |  |  |  |
| <b>Rex Barney, R</b><br>ERA: 1.53<br>(9, 1)   | 0.2   |                                  | 5                             | 1                                | 1                            | 1                                | 1                             | 2                                | 0                            | 0   | 0                            | 1                                | 0                             | 10                               | 21                            | 13.50                            | 4.500                         |                                  |                                  |                                    |                                  |        |  |  |  |  |  |
| <b>Erv Palica, R</b><br>ERA: 4.8<br>(9, 1)  | 0.1   |                                  | 2                             | 0                                | 0                            | 0                                | 0                             | 1                                | 0                            | 0   | 0                            | 0                                | 0                             | 6                                | 13                            | 0.00                             | 3.000                         |                                  |                                  |                                    |                                  |        |  |  |  |  |  |

**Cincinnati Reds @ Brooklyn Dodgers**  
 Ebbets Field, Brooklyn, NY  
 Sun May 21 1950, 3:33 AM EDT  
 Att. 21,366 - Unknown

|            |           |
|------------|-----------|
| <b>AB</b>  | <b>38</b> |
| <b>R</b>   | <b>10</b> |
| <b>H</b>   | <b>14</b> |
| <b>RBI</b> | <b>10</b> |
| <b>BB</b>  | <b>6</b>  |
| <b>SO</b>  | <b>6</b>  |
| <b>LOB</b> | <b>17</b> |



[livebaseballscorecards.com](http://livebaseballscorecards.com)



| Batter  | 1         | 2             | 3       | 4                | 5          | 6       | 7             | 8             | 9                | AB | R | H | RBI | BB | SO | LOB |
|---|-----------|---------------|---------|------------------|------------|---------|---------------|---------------|------------------|----|---|---|-----|----|----|-----|
| Eddie Miksis, R (1, 6)<br>Jim Russell, S (8, PH)<br>Bobby Morgan, R (9, 5)<br>OBP: 0.273, SLG: 0.273<br>OBP: 0.351, SLG: 0.633<br>OBP: 0.361, SLG: 0.275  | 0-0 F7    | 0-1 3B 1B     |         | 0-1 5-3          |            | 1-0 5-3 |               | 2-1 L7        |                  | 4  | 1 | 1 | 2   | 0  | 0  | 1   |
| George Shuba, L (1, 7)<br>OBP: 0.348, SLG: 0.424  | 1-3 K     | 2-0 3B        |         | 3-3 K            |            | 0-1 G3  |               |               | 4-0 BB 2B BB     | 4  | 1 | 1 | 2   | 1  | 2  | 1   |
| Duke Snider, L (1, 8)<br>OBP: 0.414, SLG: 0.455   | 4-1 WP BB | 2-3 K2-3      |         |                  | 1-1 BB 1B  | 2-1 4-3 |               |               | 4-0 1-2 2B BB    | 3  | 2 | 1 | 0   | 2  | 1  | 1   |
| Jackie Robinson, R (1, 4)<br>OBP: 0.450, SLG: 0.566   | 3-3 K 1-2 |               | 2-3 K   |                  | 0-1 L7     |         | 0-0 PO 1B     |               | 2-2 F5           | 5  | 0 | 1 | 0   | 0  | 2  | 4   |
| Carl Furillo, R (1, 9)<br>OBP: 0.298, SLG: 0.348  |           | 0-2 5-3       | 0-2 5-3 |                  | 2-1 5-3    |         | 2-3 K         |               | 1-3 K            | 5  | 0 | 0 | 0   | 0  | 2  | 4   |
| Gil Hodges, R (1, 3)<br>OBP: 0.397, SLG: 0.525  |           | 4-1 2B 1B BB  | 0-0 1B  |                  | 4-0 1B BB  |         | 0-0 L7        |               | 3-2 1B 2B        | 3  | 3 | 2 | 2   | 2  | 0  | 1   |
| Billy Cox, R (1, 5)<br>OBP: 0.342, SLG: 0.382   |           | 1-2 1B 2B     | 0-0 F3  |                  | 4-1 1B BB  |         | 1 SAFE 0-0 PO |               | 0-0 G5-4-3 BB 1B | 3  | 1 | 2 | 1   | 2  | 0  | 1   |
| Roy Campanella, R (1, 2)<br>OBP: 0.380, SLG: 0.532  |           | 4-0 1B 3B IBB |         | 2-2 5-3 SH3-4 1B | 0-0 FC6 1B |         |               | 1-2 G5-4-3 BB | 0-0 F4           | 4  | 1 | 2 | 2   | 1  | 0  | 2   |
| Preacher Roe, R (1, 1)<br>Jack Banja, L (7, 1)<br>Joe Hatten, R (8, 1)<br>Gene Hermanski, L (8, PH)<br>Rex Barney, R (9, 1)<br>Erv Palica, R (9, 1)<br>OBP: 0.234, SLG: 0.231<br>OBP: 0.111, SLG: 0.111<br>OBP: 0.500, SLG: 0.571 |           | 2-3 K         |         | 1-0 SH3-4        | 0-1 FC6    |         |               | 4-2 BB        |                  | 2  | 0 | 0 | 0   | 0  | 1  | 5   |

| Inning Stats                                    | R: 0 | H: 0 | E: 0 | K: 2 | S: 10 | LOB: 1 | BB: 1 | P: 18 | R: 4 | H: 3 | E: 0 | K: 2 | S: 16 | LOB: 1 | BB: 2 | P: 31 | R: 0 | H: 1 | E: 0 | K: 1 | S: 12 | LOB: 1 | BB: 0 | P: 14 | R: 0 | H: 1 | E: 0 | K: 1 | S: 12 | LOB: 1 | BB: 0 | P: 18 | R: 2 | H: 2 | E: 0 | K: 0 | S: 10 | LOB: 2 | BB: 2 | P: 21 | R: 0 | H: 0 | E: 0 | K: 1 | S: 5 | LOB: 0 | BB: 0 | P: 8 | R: 0 | H: 1 | E: 0 | K: 1 | S: 5 | LOB: 0 | BB: 0 | P: 7 | R: 0 | H: 0 | E: 0 | K: 0 | S: 10 | LOB: 1 | BB: 2 | P: 21 | R: 3 | H: 2 | E: 0 | K: 1 | S: 12 | LOB: 1 | BB: 2 | P: 26 | 1B: 7 | 2B: 2 | 3B: 1 | HR: 0 | SF: 0 | SAC: 1 | DP: 1 | HBP: 0 | WP: 1 | PB: 0 | SB: 1 | CS: 0 | PA: 45 |
|---|------|------|------|------|-------|--------|-------|-------|------|------|------|------|-------|--------|-------|-------|------|------|------|------|-------|--------|-------|-------|------|------|------|------|-------|--------|-------|-------|------|------|------|------|-------|--------|-------|-------|------|------|------|------|------|--------|-------|------|------|------|------|------|------|--------|-------|------|------|------|------|------|-------|--------|-------|-------|------|------|------|------|-------|--------|-------|-------|-------|-------|-------|-------|-------|--------|-------|--------|-------|-------|-------|-------|--------|
| PITCHER<br>Herm Wehmeier, R (1, 1)<br>ERA: 5.96 | IP   | WLS  | BF   | H    | R     | ER     | SO    | BB    | IBB  | HBP  | BLK  | WP   | HR    | S      | P     | ERA   | WHIP | IP   | WLS  | BF   | H     | R      | ER    | SO    | BB   | IBB  | HBP  | BLK  | WP    | HR     | S     | P     | ERA  | WHIP |      |      |       |        |       |       |      |      |      |      |      |        |       |      |      |      |      |      |      |        |       |      |      |      |      |      |       |        |       |       |      |      |      |      |       |        |       |       |       |       |       |       |       |        |       |        |       |       |       |       |        |

**BOTTOM**

**Cincinnati Reds @ Brooklyn Dodgers**  
Ebbets Field, Brooklyn, NY

Sun May 21 1950, 3:33 AM EDT  
Att. 21,366 - Unknown

|     |    |
|-----|----|
| AB  | 34 |
| R   | 9  |
| H   | 10 |
| RBI | 9  |
| BB  | 9  |
| SO  | 8  |
| LOB | 21 |



| Batter   | 1   | 2   | 3   | 4   | 5  | 6   | 7   | 8   | 9  | AB R H RBI BB SO LOB                                       | TOP                                     |  |
|--|---|---|---|---|--|---|---|---|--|--|---|--|
| Lloyd Merriman, L (1, 8)<br>OBP: 0.442, SLG: 0.444   | 1-0<br>G6-4-3<br>1B                                   |   | 1-2<br>1B<br>1B                                       |   | 4-0<br>1B<br>BB                                      |   | 0-0<br>L6   |   |  | 3 0 2 0 1 0 1  |   |  |
| Peanuts Lowrey, R (1, 7)<br>OBP: 0.379, SLG: 0.321   | 0-1<br>G6-4-3<br>1-2f                                 |   | 0-1<br>F4   |   | 1-2<br>1B  |   |   | 4-0<br>1B<br>BB                                       |  | 3 1 1 0 1 0 2  |   |  |
| Johnny Wyrostek, L (1, 3)<br>OBP: 0.381, SLG: 0.483  | 1-2<br>F7   |   | 2-2<br>1-3<br>1B                                      |   | 0-1<br>4-3   |   |   | 1-1<br>FC3-8<br>1-2<br>1B                             |  | 4 0 2 0 0 0 2  |   |  |
| Ron Northey, L (1, 9)<br>OBP: 0.375, SLG: 0.582  |   | 0-3<br>K  | 0-1<br>4-3  |   |  | 1-1<br>4-3  |   | 0-1<br>FC3-6<br>1-2f<br>2-H                           |  | 4 0 0 0 0 1 3  |   |  |
| Grady Hatton, L (1, 5)<br>OBP: 0.349, SLG: 0.447   |   | 2-2<br>1B<br>1B                                       |   | 0-0<br>F8   |  | 1-1<br>G3   |   | 1-3<br>K  |  | 4 0 1 0 0 1 1  |   |  |
| Johnny Pramesa, R (1, 2)<br>OBP: 0.316, SLG: 0.471   |   | 3-1<br>1-2<br>1B                                      |   | 0-1<br>5-3  |  | 0-1<br>4-3  |   | 1-3<br>K  |  | 4 0 1 0 0 1 1  |   |  |
| Virgil Stallcup, R (1, 6)<br>OBP: 0.273, SLG: 0.396  |   | 0-0<br>F7   |   | 1-1<br>F2   |  |   | 0-2<br>F2   |   | 1-2<br>4-3   | 4 0 0 0 0 0 2  |   |  |
| Bobby Adams, R (1, 4)<br>OBP: 0.308, SLG: 0.321<br>Ted Kluszewski, L (9, PH)<br>OBP: 0.257, SLG: 0.388       |   | 1-3<br>K  |   | 1-3<br>K  |  |   | 0-2<br>6-3  |   | 2-3<br>K   | 3 0 0 0 0 2 2<br>1 0 0 0 0 1 0                             |   |  |
| Howie Fox, R (1, 1)<br>OBP: 0.143, SLG: 0.143<br>Harry Perkowski, L (7, PH)<br>OBP: 0.667, SLG: 0.667 (7, 1) |   |   | 1-1<br>F7   |   | 0-0<br>L7  |   | 0-1<br>1B   |   | 0-3<br>K   | 2 0 0 0 0 0 0<br>2 0 1 0 0 1 0                             |   |  |
| <b>Inning Stats</b>  | R: 0 H: 1<br>E: 0 LOB: 0<br>K: 0 BB: 0<br>S: 7 P: 9   | R: 0 H: 2<br>E: 0 LOB: 2<br>K: 2 BB: 0<br>S: 14 P: 20 | R: 0 H: 2<br>E: 0 LOB: 2<br>K: 0 BB: 0<br>S: 13 P: 17 | R: 0 H: 0<br>E: 0 LOB: 0<br>K: 0 BB: 0<br>S: 5 P: 6 | R: 0 H: 1<br>E: 0 LOB: 2<br>K: 1 BB: 1<br>S: 9 P: 15 | R: 0 H: 0<br>E: 0 LOB: 0<br>K: 0 BB: 0<br>S: 6 P: 8 | R: 0 H: 1<br>E: 0 LOB: 1<br>K: 0 BB: 0<br>S: 9 P: 9 | R: 1 H: 1<br>E: 1 LOB: 1<br>K: 2 BB: 1<br>S: 10 P: 17 | R: 0 H: 0<br>E: 0 LOB: 0<br>K: 2 BB: 0<br>S: 9 P: 12 | 1B: 8 SF: 0<br>2B: 0 SAC: 0<br>3B: 0 DP: 1<br>HR: 0 HBP: 0 | WP: 0 PA: 36<br>PB: 0<br>SB: 0<br>CS: 0 |  |
| <b>PITCHER</b><br>Don Newcombe, R (1, 1)<br>ERA: 4.31  | IP WLS BF H R ER SO BB IBB HBP BLK WP HR S P ERA WHIP | 9.0 W 36 8 1 0 7 2 0 0 0 0 0 0 82 113 0.00 1.111      |   |   |  |   |   |   |  |  |   |  |

**Cincinnati Reds @ Brooklyn Dodgers**  
 Ebbets Field, Brooklyn, NY  
 Mon May 22 1950, 3:33 AM EDT  
 Att: 20,075 - Unknown

[livebaseballscorecards.com](http://livebaseballscorecards.com)

|     |    |
|-----|----|
| AB  | 34 |
| R   | 1  |
| H   | 8  |
| RBI | 0  |
| BB  | 2  |
| SO  | 7  |
| LOB | 14 |



| Batter  | 1                                     | 2          | 3          | 4                                      | 5                           | 6 | 7            | 8         | 9 | AB | R | H | RBI | BB | SO | LOB |
|---|---------------------------------------|------------|------------|--|-----------------------------|---|--------------|-----------|---|----|---|---|-----|----|----|-----|
| Eddie Miksis, R<br>OBP: 0.214, SLG: 0.214 (1, 6)    | 1-1<br>4-3                            |            | 1-1<br>1-3 |  | 2-2<br>6-3                  |   | 1-0<br>SH1-3 |           |   | 3  | 0 | 0 | 0   | 0  | 0  | 0   |
| George Shuba, L<br>OBP: 0.342, SLG: 0.403 (1, 7)    | 4-1<br>1B<br>1B<br>BB                 |            | 2-3<br>K   |  | 1-2<br>F3                   |   | 2-3<br>K     |           |   | 3  | 1 | 0 | 0   | 1  | 2  | 1   |
| Duke Snider, L<br>OBP: 0.417, SLG: 0.451 (1, 8)     | 0-0<br>FC5-4<br>1B<br>1-3<br>CS<br>1B |            |            | 4-2<br>1B<br>1B<br>BB                  | 1-0<br>L7                   |   |              | 0-0<br>F7 |   | 3  | 1 | 1 | 0   | 1  | 0  | 0   |
| Jackie Robinson, R<br>OBP: 0.452, SLG: 0.563 (1, 4) | 0-1<br>FC5-4<br>1-2<br>1B             |            |            | 1-1<br>1B<br>1-3<br>1B<br>1B           | 2-2<br>G3                   |   |              | 1-0<br>F9 |   | 4  | 1 | 2 | 1   | 0  | 0  | 0   |
| Carl Furillo, R<br>OBP: 0.304, SLG: 0.353 (1, 9)    | 2-2<br>FC5-4<br>1-2<br>2-3            |            |            | 3-2<br>1B<br>1-2<br>E<br>1B            | 3-2<br>1B                   |   |              | 0-0<br>L7 |   | 4  | 1 | 2 | 1   | 0  | 0  | 2   |
| Gil Hodges, R<br>OBP: 0.395, SLG: 0.519 (1, 3)      | 3-2<br>CS<br>3-H                      | 2-1<br>3-1 |            | 0-0<br>E<br>1-3<br>2-H<br>G6-4-3<br>1B | 0-3<br>K                    |   |              |           | 3 | 1  | 1 | 1 | 0   | 1  | 1  |     |
| Billy Cox, R<br>OBP: 0.317, SLG: 0.351 (1, 5)       |                                       | 0-1<br>5-3 |            | 2-1<br>E1<br>1-3<br>3-H<br>G6-4-3      | 1-0<br>4-3                  |   |              |           | 3 | 0  | 0 | 0 | 0   | 0  | 2  |     |
| Roy Campanella, R<br>OBP: 0.378, SLG: 0.523 (1, 2)  |                                       | 1-3<br>K   |            | 1-0<br>G6-4-3<br>1-2<br>3-H            | 2-1<br>SH1-3<br>SH1-4<br>1B |   |              |           | 3 | 0  | 1 | 0 | 0   | 1  | 1  |     |
| Don Newcombe, L<br>OBP: 0.455, SLG: 0.333 (1, 1)    |                                       |            | 2-1<br>1B  | 1-1<br>1-3                             | 1-0<br>SH1-4                |   |              |           | 2 | 0  | 1 | 0 | 0   | 0  | 0  |     |

| Inning Stats                           | R: 1 | H: 2 | E: 0 | K: 0 | S: 12 | LOB: 1 | BB: 1 | P: 22 | R: 0 | H: 0 | E: 0 | K: 1 | S: 7 | LOB: 0 | BB: 0 | P: 10 | R: 0  | H: 1 | E: 0 | K: 1 | S: 7 | LOB: 0 | BB: 0 | P: 12 | R: 4 | H: 3 | E: 1 | K: 0 | S: 14 | LOB: 0 | BB: 1 | P: 26 | R: 0 | H: 0 | E: 0 | K: 0 | S: 7 | LOB: 0 | BB: 0 | P: 11 | R: 0 | H: 1 | E: 0 | K: 1 | S: 11 | LOB: 1 | BB: 0 | P: 17 | R: 0 | H: 1 | E: 0 | K: 1 | S: 7 | LOB: 1 | BB: 0 | P: 13 | R: 0 | H: 0 | E: 0 | K: 0 | S: 3 | LOB: 0 | BB: 0 | P: 4 |
|--|------|------|------|------|-------|--------|-------|-------|------|------|------|------|------|--------|-------|-------|-------|------|------|------|------|--------|-------|-------|------|------|------|------|-------|--------|-------|-------|------|------|------|------|------|--------|-------|-------|------|------|------|------|-------|--------|-------|-------|------|------|------|------|------|--------|-------|-------|------|------|------|------|------|--------|-------|------|
| PITCHER                                | IP   | WLS  | BF   | H    | R     | ER     | SO    | BB    | IBB  | HBP  | BLK  | WP   | HR   | S      | P     | ERA   | WHIP  |      |      |      |      |        |       |       |      |      |      |      |       |        |       |       |      |      |      |      |      |        |       |       |      |      |      |      |       |        |       |       |      |      |      |      |      |        |       |       |      |      |      |      |      |        |       |      |
| Howie Fox, R<br>ERA: 6.2 (1, 1)        | 6.0  | L    | 25   | 7    | 5     | 3      | 3     | 2     | 0    | 0    | 0    | 0    | 0    | 58     | 98    | 4.50  | 1.500 |      |      |      |      |        |       |       |      |      |      |      |       |        |       |       |      |      |      |      |      |        |       |       |      |      |      |      |       |        |       |       |      |      |      |      |      |        |       |       |      |      |      |      |      |        |       |      |
| Harry Perkowski, L<br>ERA: 7.11 (7, 1) | 2.0  |      | 7    | 1    | 0     | 0      | 1     | 0     | 0    | 0    | 0    | 0    | 0    | 10     | 17    | 0.00  | 0.500 |      |      |      |      |        |       |       |      |      |      |      |       |        |       |       |      |      |      |      |      |        |       |       |      |      |      |      |       |        |       |       |      |      |      |      |      |        |       |       |      |      |      |      |      |        |       |      |

**BOTTOM**

**Cincinnati Reds @ Brooklyn Dodgers**  
Ebbets Field, Brooklyn, NY  
Mon May 22 1950, 3:33 AM EDT  
Att. 20,075 - Unknown

|     |    |
|-----|----|
| AB  | 28 |
| R   | 5  |
| H   | 8  |
| RBI | 3  |
| BB  | 2  |
| SO  | 4  |
| LOB | 7  |



|       |        |       |        |
|-------|--------|-------|--------|
| 1B: 8 | SF: 0  | WP: 0 | PA: 33 |
| 2B: 0 | SAC: 2 | PB: 0 |        |
| 3B: 0 | DP: 1  | SB: 0 |        |
| HR: 0 | HBP: 0 | CS: 1 |        |

livebaseballscorecards.com

| Batter  | 1   | 2   | 3   | 4   | 5   | 6  | 7  | 8   | 9   | AB R H RBI BB SO LOB                                       | TOP   |                |   |
|---|---|---|---|---|---|--|--|---|---|--|---|----------------|---|
| Lloyd Merriman, L (1, 8)<br>OBP: 0.417, SLG: 0.415  | 0-0 F7  |   | 0-0 F7  | 0-0 4-3   |   | 0-3 K  |  | 0-0 CS<br>1B  |   | 5 0 1 0 0 1 5  | <b>Cincinnati Reds @ Boston Braves</b><br>Braves Field, Boston, MA<br>Tue May 23 1950, 3:33 AM EDT<br>Att: 10,199 - Unknown |                |   |
| Peanuts Lowrey, R (1, 7)<br>OBP: 0.366, SLG: 0.328  | 0-0 5-3   |   | 0-0 6-3   |   | 0-0 5-3   |  | 0-0 E<br>G3 2B                                       | 0-0 F2  |   | 5 1 1 0 0 0 1  |   |                |   |
| Johnny Wyrostek, L (1, 3)<br>OBP: 0.402, SLG: 0.484<br>(7, 9)                                     | 0-0 F9  |   | 4-0 1B<br>BB  |   | 4-0 BB<br>G3-6-3                                    |  | 4-0 G3 E<br>3B BB                                    |   | 0-0 SH2-3<br>1B                                     | 2 1 1 0 3 0 0  |   |                |   |
| Ron Northey, L (1, 9)<br>OBP: 0.382, SLG: 0.627<br>Joe Adcock, R (7, 3)<br>OBP: 0.186, SLG: 0.190 |   | 0-0 HR  | 0-0 1B  |   | 0-0 G3-6-3  |  | 0-0 E4<br>G3 3B                                      |   | 0-0 SH2-3<br>1B                                     | 4 2 2 1 0 0 3<br>0 0 0 0 0 0 0                             |   |                |   |
| Grady Hatton, L (1, 5)<br>OBP: 0.351, SLG: 0.439  |   | 0-0 4-3<br>2B 1B                                    | 0-0 F9  |   | 0-0 4-3   |  | 0-0 G3   |   | 4-0 SH2-3<br>BB                                     | 4 1 1 1 1 0 4  |   |                |   |
| Johnny Pramesa, R (1, 2)<br>OBP: 0.375, SLG: 0.571  |   | 0-0 4-3   |   | 0-0 1B<br>1B  |   | 4-0 E<br>1B BB                                       |  | 0-0 1B<br>3B  | 0-0 G5-4-3<br>BB                                    | 4 1 2 2 1 0 3  |   |                |   |
| Virgil Stallcup, R (1, 6)<br>OBP: 0.282, SLG: 0.400   |   | 0-0 F5  |   | 0-0 F8  |   | 0-0 E<br>1B  |  | 0-0 G1-4-3<br>1B                                    |   | 4 0 2 1 0 0 2  |   |                |   |
| Bobby Adams, R (1, 4)<br>OBP: 0.316, SLG: 0.341   |   | 0-0 2B  |   | 0-0 1B  |   | 0-3 K  |  | 0-0 G1-4-3  |   | 4 0 2 1 0 1 3  |   |                |   |
| Willie Ramsdell, R (1, 1)<br>OBP: 0.316, SLG: 0.341   |   | 0-0 F9  |   | 0-0 F6  |   | 0-0 E5   |  | 0-0 4-3   |   | 4 0 0 0 0 0 5  |   |                |   |
| <b>Inning Stats</b>   | R: 0 H: 0<br>E: 0 LOB: 0<br>K: 0 BB: 0<br>S: 3 P: 3   | R: 2 H: 3<br>E: 0 LOB: 1<br>K: 0 BB: 0<br>S: 6 P: 6 | R: 0 H: 1<br>E: 0 LOB: 2<br>K: 0 BB: 1<br>S: 4 P: 8 | R: 0 H: 2<br>E: 0 LOB: 2<br>K: 0 BB: 0<br>S: 5 P: 5 | R: 0 H: 0<br>E: 0 LOB: 0<br>K: 0 BB: 1<br>S: 2 P: 6 | R: 0 H: 1<br>E: 1 LOB: 3<br>K: 2 BB: 1<br>S: 9 P: 13 | R: 4 H: 3<br>E: 1 LOB: 0<br>K: 0 BB: 1<br>S: 6 P: 10 | R: 0 H: 1<br>E: 0 LOB: 0<br>K: 0 BB: 0<br>S: 3 P: 3 | R: 0 H: 1<br>E: 0 LOB: 1<br>K: 0 BB: 1<br>S: 3 P: 7 | 1B: 8 SF: 0<br>2B: 2 SAC: 1<br>3B: 1 DP: 3<br>HR: 1 HBP: 0 | WP: 0 PA: 42<br>PB: 0<br>SB: 0<br>CS: 1   |                |   |
| <b>PITCHER</b>  | IP WLS BF H R ER SO BB IBB HBP BLK WP HR S P ERA WHIP |   |   |   |   |  |  |   |   |  |   | <b>PITCHER</b> | IP WLS BF H R ER SO BB IBB HBP BLK WP HR S P ERA WHIP |
| Normie Roy, R (1, 1)<br>ERA: 5.13   | 6.1 L 33 9 6 5 2 4 0 0 0 0 0 1 33 49 7.11 2.053       |   |   |   |   |  |  |   |   |  |   |                |   |
| Bobby Hogue, R (7, 1)<br>ERA: 1.74  | 0.2 2 1 0 0 0 0 0 0 0 0 0 0 2 2 0.00 1.500            |   |   |   |   |  |  |   |   |  |   |                |   |
| Bob Chipman, L (8, 1)<br>ERA: 3.86  | 2.0 7 2 0 0 0 0 1 0 0 0 0 0 6 10 0.00 1.500           |   |   |   |   |  |  |   |   |  |   |                |   |

livebaseballscorecards.com

|     |    |
|-----|----|
| AB  | 36 |
| R   | 6  |
| H   | 12 |
| RBI | 6  |
| BB  | 5  |
| SO  | 2  |
| LOB | 26 |



| Batter  | 1                       | 2          | 3                     | 4         | 5                    | 6                | 7                | 8          | 9                      | AB R H RBI BB SO LOB  |
|---|-------------------------|------------|-----------------------|-----------|----------------------|------------------|------------------|------------|------------------------|---|
| Sam Jethroe, S<br>OBP: 0.367, SLG: 0.531<br>(1, 8)                    | 0-3<br>K                |            | 0-3<br>K              |           | 0-0<br>G5-4-3-6      |                  | 0-0<br>F3        |            | 0-0<br>E 1B<br>1B      | 5 0 1 0 0 2 2   |
| Earl Torgeson, L<br>OBP: 0.412, SLG: 0.387<br>(1, 3)                  | 4-0<br>1B<br>1B<br>BB   |            | 0-0<br>PB<br>F8<br>2B |           | 0-0<br>F3            |                  | 4-0<br>1-2<br>BB |            | 0-0<br>1-2<br>E<br>1B  | 3 2 2 0 2 0 0   |
| Pete Reiser, L<br>OBP: 0.355, SLG: 0.370<br>(1, 7)                    | 0-0<br>1B<br>1-2<br>1B  |            | 0-0<br>F8<br>2-H      |           |                      | 0-0<br>1B<br>1B  | 0-0<br>3-1       |            | 0-3<br>1-2<br>2-3<br>K | 5 0 2 1 0 1 4   |
| Bob Elliott, R<br>OBP: 0.331, SLG: 0.451<br>(1, 5)                    | 0-3<br>K                |            | 0-0<br>F2             |           |                      | 0-3<br>K         |                  | 0-0<br>6-3 | 0-0<br>3-1             | 5 0 0 0 0 2 6   |
| Walker Cooper, R<br>OBP: 0.299, SLG: 0.474<br>(1, 2)                  | 0-0<br>1-3<br>2-H<br>1B |            |                       | 0-3<br>K  |                      | 0-0<br>1-2<br>1B |                  | 0-0<br>6-3 |                        | 4 0 2 1 0 1 0   |
| Willard Marshall, L<br>OBP: 0.308, SLG: 0.347<br>(1, 9)               | 0-0<br>F3               |            |                       | 0-0<br>1B |                      | 0-3<br>K         |                  | 0-0<br>1B  |                        | 4 0 2 0 0 1 4   |
| Gene Mauch, R<br>OBP: 0.167, SLG: 0.167<br>(1, 4)                     |                         | 0-0<br>1-3 |                       | 0-0<br>F2 |                      | 0-0<br>F7        |                  | 0-0<br>F6  |                        | 4 0 0 0 0 0 4   |
| Buddy Kerr, R<br>OBP: 0.246, SLG: 0.291<br>(1, 6)                     |                         | 0-3<br>K   |                       | 0-0<br>F7 |                      |                  | 0-0<br>F4        |            | 0-0<br>F9              | 4 0 0 0 0 1 1   |
| Normie Roy, R<br>OBP: 0.182, SLG: 0.182<br>Bobby Hogue, R<br>(7, 1)   |                         | 0-0<br>F8  |                       |           | 0-0<br>3-4-3-6<br>1B |                  | 4-0<br>BB<br>BB  |            | 0-0<br>F6              | 2 0 1 0 0 0 0<br>0 0 0 0 0 0 0<br>0 0 0 0 1 0 0<br>0 0 0 0 0 0 0<br>1 0 0 0 0 0 0 |
| Tommy Holmes, L<br>OBP: 0.500, SLG: 0.250<br>Bob Chipman, L<br>(8, 1) |                         |            |                       |           |                      |                  |                  |            |                        |   |
| Luis Olmo, R<br>OBP: 0.333, SLG: 0.400<br>(9, PH)                     |                         |            |                       |           |                      |                  |                  |            |                        |   |

|   |                              |                                  |                              |                                 |                              |                                 |                              |                                 |                              |                                 |                              |                                 |                              |                                  |                              |                                 |                              |                                 |                                  |                                    |                                  |          |         |         |         |         |             |               |  |  |  |  |  |
|---|------------------------------|----------------------------------|------------------------------|---------------------------------|------------------------------|---------------------------------|------------------------------|---------------------------------|------------------------------|---------------------------------|------------------------------|---------------------------------|------------------------------|----------------------------------|------------------------------|---------------------------------|------------------------------|---------------------------------|----------------------------------|------------------------------------|----------------------------------|----------|---------|---------|---------|---------|-------------|---------------|--|--|--|--|--|
| <b>Inning Stats</b>   | R: 1<br>E: 0<br>K: 2<br>S: 9 | H: 2<br>LOB: 2<br>BB: 1<br>P: 13 | R: 0<br>E: 0<br>K: 1<br>S: 5 | H: 0<br>LOB: 0<br>BB: 0<br>P: 5 | R: 1<br>E: 0<br>K: 1<br>S: 6 | H: 1<br>LOB: 0<br>BB: 0<br>P: 6 | R: 0<br>E: 0<br>K: 1<br>S: 6 | H: 1<br>LOB: 1<br>BB: 0<br>P: 6 | R: 0<br>E: 0<br>K: 0<br>S: 3 | H: 1<br>LOB: 0<br>BB: 0<br>P: 3 | R: 0<br>E: 0<br>K: 2<br>S: 9 | H: 2<br>LOB: 2<br>BB: 0<br>P: 9 | R: 0<br>E: 0<br>K: 0<br>S: 3 | H: 0<br>LOB: 2<br>BB: 2<br>P: 11 | R: 0<br>E: 0<br>K: 0<br>S: 4 | H: 1<br>LOB: 1<br>BB: 0<br>P: 4 | R: 0<br>E: 1<br>K: 1<br>S: 8 | H: 2<br>LOB: 3<br>BB: 0<br>P: 8 | 1B: 9<br>2B: 1<br>3B: 0<br>HR: 0 | SF: 0<br>SAC: 0<br>DP: 1<br>HBP: 0 | WP: 0<br>PB: 1<br>SB: 0<br>CS: 0 | PA: 40   |         |         |         |         |             |               |  |  |  |  |  |
| <b>PITCHER</b><br>Willie Ramsdell, R<br>ERA: 2.04<br>(1, 1) | IP<br>9.0                    | WLS<br>W                         | BF<br>40                     | H<br>10                         | R<br>2                       | ER<br>1                         | SO<br>8                      | BB<br>3                         | IBB<br>0                     | HBP<br>0                        | BLK<br>0                     | WP<br>0                         | HR<br>0                      | S<br>53                          | P<br>65                      | ERA<br>1.00                     | WHIP<br>1.444                |                                 |                                  |                                    |                                  |          |         |         |         |         |             |               |  |  |  |  |  |
|   |                              |                                  |                              |                                 |                              |                                 |                              |                                 |                              |                                 | <b>PITCHER</b>               | IP<br>9.0                       | WLS<br>W                     | BF<br>40                         | H<br>10                      | R<br>2                          | ER<br>1                      | SO<br>8                         | BB<br>3                          | IBB<br>0                           | HBP<br>0                         | BLK<br>0 | WP<br>0 | HR<br>0 | S<br>53 | P<br>65 | ERA<br>1.00 | WHIP<br>1.444 |  |  |  |  |  |

**BOTTOM**

**Cincinnati Reds @ Boston Braves**  
Braves Field, Boston, MA

Tue May 23 1950, 3:33 AM EDT  
Att. 10,199 - Unknown

|            |           |
|------------|-----------|
| <b>AB</b>  | <b>37</b> |
| <b>R</b>   | <b>2</b>  |
| <b>H</b>   | <b>10</b> |
| <b>RBI</b> | <b>2</b>  |
| <b>BB</b>  | <b>3</b>  |
| <b>SO</b>  | <b>8</b>  |
| <b>LOB</b> | <b>21</b> |



livebaseballscorecards.com

| Batter  | 1   | 2   | 3   | 4   | 5   | 6   | 7   | 8  | 9   | AB R H RBI BB SO LOB   | TOP  |  |
|---|---|---|---|---|---|---|---|--|---|--|--|--|
| <b>Peanuts Lowrey, R</b> (1, 7)<br>OBP: 0.360, SLG: 0.323   | 0-0<br>F6   |   |   | 0-0<br>1B   |   | 0-0<br>F8   |   | 0-0<br>F4  |   | 4 0 1 0 0 0 2  | <b>Cincinnati Reds @ Boston Braves</b><br>Braves Field, Boston, MA<br>Wed May 24 1950, 3:33 AM EDT<br>Att. 6,167 - Unknown |  |
| <b>Johnny Wyrostek, L</b> (1, 3)<br>OBP: 0.387, SLG: 0.463  | 0-3<br>K  |   |   | 0-0<br>F6   |   | 0-0<br>4-3  |   | 0-0<br>5-3   | 4 0 0 0 0 1 1   |  |  |  |
| <b>Bob Usher, R</b> (1, 8)<br>OBP: 0.298, SLG: 0.509  | 0-3<br>K  |   |   | 0-3<br>K  |   | 0-0<br>6-3  |   | 0-0<br>G4-6-3<br>1B  | 4 0 1 0 0 2 1   |  |  |  |
| <b>Ron Northey, L</b> (1, 9)<br>OBP: 0.361, SLG: 0.587  |   | 0-0<br>E4<br>G6-4-3   |   | 0-3<br>K  |   | 0-0<br>3-1  |   | 0-0<br>G4-6-3<br>1-2f  | 4 0 0 0 0 1 2   |  |  |  |
| <b>Johnny Pramesa, R</b> (1, 2)<br>OBP: 0.333, SLG: 0.500   |   | 0-0<br>G6-4-3<br>1-2f   |   |   | 0-0<br>F8   |   | 0-0<br>F8   |  | 3 0 0 0 0 0 1   |  |  |  |
| <b>Grady Hatton, L</b> (1, 5)<br>OBP: 0.342, SLG: 0.426   |   | 0-3<br>K  |   |   | 0-0<br>4-3  |   | 0-0<br>F9   |  | 3 0 0 0 0 1 0   |  |  |  |
| <b>Virgil Stallcup, R</b> (1, 6)<br>OBP: 0.283, SLG: 0.427  |   |   | 0-0<br>F7   |   | 0-0<br>HR   |   | 0-0<br>F8   |  | 3 1 1 1 0 0 0   |  |  |  |
| <b>Bobby Adams, R</b> (1, 4)<br>OBP: 0.327, SLG: 0.337  |   |   | 4-0<br>BB<br>G6-4-3   |   | 0-0<br>1-3  |   | 4-0<br>BB<br>BB   |  | 1 0 0 0 2 0 0   |  |  |  |
| <b>Ewell Blackwell, R</b> (1, 1)<br>OBP: 0.200, SLG: 0.077<br><b>Danny Litwhiler, R</b> (8, PH)<br>OBP: 0.342, SLG: 0.406<br><b>Frank Smith, R</b> (8, 1)<br>OBP: 0.250, SLG: 0.250 |   |   | 0-0<br>G6-4-3<br>1-2f   |   | 0-3<br>K  |   | 4-0<br>BB<br>1-2<br>BB  |  | 2 0 0 0 0 1 1<br>0 0 0 0 1 0 0<br>0 0 0 0 0 0 0                 |  |  |  |
| <b>Inning Stats</b>   | R: 0<br>E: 0<br>K: 2<br>S: 7<br>H: 0<br>LOB: 0<br>BB: 0<br>P: 7 | R: 0<br>E: 1<br>K: 1<br>S: 5<br>H: 0<br>LOB: 0<br>BB: 0<br>P: 5 | R: 0<br>E: 0<br>K: 0<br>S: 2<br>H: 0<br>LOB: 0<br>BB: 1<br>P: 6 | R: 0<br>E: 0<br>K: 2<br>S: 8<br>H: 1<br>LOB: 1<br>BB: 0<br>P: 8 | R: 1<br>E: 0<br>K: 0<br>S: 4<br>H: 1<br>LOB: 0<br>BB: 0<br>P: 4 | R: 0<br>E: 0<br>K: 1<br>S: 5<br>H: 0<br>LOB: 0<br>BB: 0<br>P: 5 | R: 0<br>E: 0<br>K: 0<br>S: 3<br>H: 0<br>LOB: 0<br>BB: 0<br>P: 3 | R: 0<br>E: 0<br>K: 0<br>S: 3<br>H: 0<br>LOB: 2<br>BB: 2<br>P: 11 | R: 0<br>E: 0<br>K: 0<br>S: 3<br>H: 1<br>LOB: 0<br>BB: 0<br>P: 3 | 1B: 2<br>2B: 0<br>3B: 0<br>HR: 1<br>SF: 0<br>SAC: 0<br>DP: 3<br>HBP: 0 | WP: 0<br>PB: 0<br>SB: 0<br>CS: 0<br>PA: 31   |  |
| <b>PITCHER</b><br><b>Warren Spahn, L</b> (1, 1)<br>ERA: 3.56  | IP WLS BF H R ER SO BB IBB HBP BLK WP HR S P ERA WHIP           | 9.0 W 31 3 1 1 6 3 0 0 0 0 1 40 52 1.00 0.667                   |   |   |   |   |   |  |   |  |  |  |

livebaseballscorecards.com

|            |    |
|------------|----|
| <b>AB</b>  | 28 |
| <b>R</b>   | 1  |
| <b>H</b>   | 3  |
| <b>RBI</b> | 1  |
| <b>BB</b>  | 3  |
| <b>SO</b>  | 6  |
| <b>LOB</b> | 8  |



| Batter  | 1        | 2           | 3       | 4              | 5            | 6          | 7               | 8      | 9 |
|---|----------|-------------|---------|----------------|--------------|------------|-----------------|--------|---|
| Sam Jethroe, S<br>OBP: 0.357, SLG: 0.515<br>(1, 8) X        | 0-0 F5   |             | 0-0 F7  |                | 0-0 L8       |            | 0-0 F7          |        |   |
| Earl Torgeson, L<br>OBP: 0.415, SLG: 0.380<br>(1, 3) BBB    | 4-0 S BB |             |         | 0-0 F5         | 0-0 4-3      |            | 4-0 2B BB       |        |   |
| Pete Reiser, L<br>OBP: 0.371, SLG: 0.419<br>(1, 7) SSS      | 0-3 K    |             |         | 0-0 FC5-4 1B   |              | 0-3 K      | 0-0 1-H 2-H 2B  |        |   |
| Bob Elliott, R<br>OBP: 0.321, SLG: 0.436<br>(1, 5) X        | 0-0 F8   |             |         | 0-0 FC5-4 1-2f |              | 0-3 K      | 0-0 F9          |        |   |
| Walker Cooper, R<br>OBP: 0.296, SLG: 0.463<br>(1, 2) SSS    |          | 0-3 K       |         | 0-3 K          |              | 0-0 BB 1B  |                 | 0-3 K  |   |
| Willard Marshall, L<br>OBP: 0.313, SLG: 0.341<br>(1, 9) BBB |          | 4-0 P3 BB   |         |                | 0-0 F9       | 4-0 1-2 BB |                 | 0-0 F7 |   |
| Gene Mauch, R<br>OBP: 0.200, SLG: 0.111<br>(1, 4) X         |          | 0-0 P3 1-2f |         |                | 1-0 2B HBP   | 0-0 6-3    |                 | 0-3 K  |   |
| Buddy Kerr, R<br>OBP: 0.256, SLG: 0.310<br>(1, 6) X         |          |             | 0-0 1-3 |                | 0-0 WP L8 2B |            | 0-0 SH2-4 2B 1B |        |   |
| Warren Spahn, L<br>OBP: 0.346, SLG: 0.320<br>(1, 1) X       |          |             | 0-0 1-3 |                | 0-0 2-3 1B   |            | 0-0 SH2-4       |        |   |

| Inning Stats | R: 0   | H: 0  | E: 0   | K: 1  | S: 5 | R: 0   | H: 0  | E: 0   | K: 1  | S: 4 | R: 0   | H: 0  | E: 0   | K: 0  | S: 3 | R: 0   | H: 1  | E: 0   | K: 1  | S: 6 | R: 2   | H: 2  | E: 0   | K: 0  | S: 5 | R: 0   | H: 1  | E: 0   | K: 2  | S: 8 | R: 2   | H: 2  | E: 0   | K: 0  | S: 5   | R: 0  | H: 0 | E: 0   | K: 2  | S: 7   |       |  |
|--------------|--------|-------|--------|-------|------|--------|-------|--------|-------|------|--------|-------|--------|-------|------|--------|-------|--------|-------|------|--------|-------|--------|-------|------|--------|-------|--------|-------|------|--------|-------|--------|-------|--------|-------|------|--------|-------|--------|-------|--|
|              | LOB: 1 | BB: 1 | LOB: 0 | BB: 1 |      | LOB: 0 | BB: 0 | LOB: 1 | BB: 0 |      | LOB: 1 | BB: 0 | LOB: 2 | BB: 1 |      | LOB: 0 | BB: 1 | LOB: 0 | BB: 0 |      | LOB: 1 | BB: 0 | LOB: 1 | BB: 1 |      | LOB: 0 | BB: 0 | LOB: 0 | BB: 0 |      | LOB: 2 | BB: 1 | LOB: 1 | BB: 0 | LOB: 0 | BB: 0 |      | LOB: 0 | BB: 0 | LOB: 0 | BB: 0 |  |

| PITCHER                                   |     |    |    |   |    |    |    |     |     | PITCHER |    |    |    |    |      |       |                                       |     |    |   |   |    |    |    |     |     |     |    |    |   |   |      |       |
|---|-----|----|----|---|----|----|----|-----|-----|---------|----|----|----|----|------|-------|---------------------------------------|-----|----|---|---|----|----|----|-----|-----|-----|----|----|---|---|------|-------|
| IP  | WLS | BF | H  | R | ER | SO | BB | IBB | HBP | BLK     | WP | HR | S  | P  | ERA  | WHIP  | IP                                    | WLS | BF | H | R | ER | SO | BB | IBB | HBP | BLK | WP | HR | S | P | ERA  | WHIP  |
| Ewell Blackwell, R<br>ERA: 2.37<br>(1, 1) | 7.0 | L  | 31 | 6 | 4  | 4  | 5  | 4   | 0   | 0       | 1  | 0  | 36 | 53 | 5.14 | 1.429 | Frank Smith, R<br>ERA: 3.92<br>(8, 1) | 1.0 |    | 3 | 0 | 0  | 0  | 2  | 0   | 0   | 0   | 0  | 0  | 7 | 7 | 0.00 | 0.000 |

**BOTTOM**

| AB | R | H | RBI | BB | SO | LOB |
|----|---|---|-----|----|----|-----|
| 4  | 0 | 0 | 1   | 0  | 0  | 2   |
| 2  | 1 | 0 | 0   | 2  | 0  | 1   |
| 4  | 0 | 2 | 2   | 0  | 2  | 1   |
| 4  | 0 | 0 | 0   | 0  | 1  | 3   |
| 4  | 0 | 1 | 0   | 0  | 3  | 1   |
| 2  | 0 | 0 | 0   | 2  | 0  | 0   |
| 3  | 1 | 0 | 0   | 0  | 1  | 3   |
| 3  | 2 | 2 | 1   | 0  | 0  | 0   |
| 2  | 0 | 1 | 0   | 0  | 0  | 0   |

|            |           |
|------------|-----------|
| <b>AB</b>  | <b>28</b> |
| <b>R</b>   | <b>4</b>  |
| <b>H</b>   | <b>6</b>  |
| <b>RBI</b> | <b>4</b>  |
| <b>BB</b>  | <b>4</b>  |
| <b>SO</b>  | <b>7</b>  |
| <b>LOB</b> | <b>11</b> |



|       |        |
|-------|--------|
| WP: 1 | PA: 34 |
| PB: 0 |        |
| SB: 1 |        |
| CS: 0 |        |

**Cincinnati Reds @ Boston Braves**  
**Braves Field, Boston, MA**  
 Wed May 24 1950, 3:33 AM EDT  
 Att. 6,167 - Unknown

[livebaseballscorecards.com](http://livebaseballscorecards.com)

| Batter   | 1  | 2                               | 3                            | 4                               | 5                            | 6                               | 7                            | 8                               | 9                            | AB R H RBI BB SO LOB            | TOP                          |                                 |                              |                                 |                              |                                 |                                  |                                    |                                  |        |
|--|--|---------------------------------|------------------------------|---------------------------------|------------------------------|---------------------------------|------------------------------|---------------------------------|------------------------------|---------------------------------|------------------------------|---------------------------------|------------------------------|---------------------------------|------------------------------|---------------------------------|----------------------------------|------------------------------------|----------------------------------|--------|
| Tommy Glaviano, R (1, 5)<br>OBP: 0.424, SLG: 0.435         | 0-0<br>E4<br>2B<br>F7  |                                 | 0-0<br>L9                    |                                 |                              | 0-0<br>5-3                      |                              | 4-0<br>HR<br>BB                 |                              | 3 2 0 0 1 0 0                   |                              |                                 |                              |                                 |                              |                                 |                                  |                                    |                                  |        |
| Red Schoendienst, S (1, 4)<br>OBP: 0.302, SLG: 0.338       | 0-0<br>1-3<br>2B   |                                 | 0-0<br>P4                    |                                 |                              | 0-0<br>F7                       |                              | 0-0<br>F8                       |                              | 4 0 1 0 0 0 2                   |                              |                                 |                              |                                 |                              |                                 |                                  |                                    |                                  |        |
| Stan Musial, L (1, 3)<br>OBP: 0.512, SLG: 0.716            | 0-0<br>F2  |                                 |                              | 0-0<br>E3<br>G6-4-3             |                              | 0-0<br>F8                       |                              | 0-0<br>HR                       |                              | 4 1 1 3 0 0 2                   |                              |                                 |                              |                                 |                              |                                 |                                  |                                    |                                  |        |
| Johnny Lindell, R (1, 7)<br>OBP: 0.281, SLG: 0.320         | 0-0<br>F7<br>3-H   |                                 |                              | 0-0<br>G6-4-3<br>1-2f           |                              | 0-0<br>F3                       |                              | 0-0<br>F3                       |                              | 4 0 0 1 0 0 2                   |                              |                                 |                              |                                 |                              |                                 |                                  |                                    |                                  |        |
| Enos Slaughter, L (1, 9)<br>OBP: 0.421, SLG: 0.432         | 0-0<br>F7  |                                 |                              | 0-0<br>1B                       |                              | 0-0<br>FC6-4<br>1B              |                              |                                 | 0-0<br>FC1-4<br>1B           | 4 0 3 0 0 0 1                   |                              |                                 |                              |                                 |                              |                                 |                                  |                                    |                                  |        |
| Marty Marion, R (1, 6)<br>OBP: 0.366, SLG: 0.300           |  | 0-0<br>F3                       |                              | 0-0<br>F6                       |                              | 0-0<br>F4                       |                              |                                 | 0-0<br>FC1-4                 | 4 0 0 0 0 0 3                   |                              |                                 |                              |                                 |                              |                                 |                                  |                                    |                                  |        |
| Chuck Diering, R (1, 8)<br>OBP: 0.299, SLG: 0.312          |  | 0-3<br>K                        |                              |                                 | 0-0<br>P3                    |                                 | 0-0<br>FC6-4                 |                                 | 0-0<br>L8                    | 4 0 0 0 0 1 2                   |                              |                                 |                              |                                 |                              |                                 |                                  |                                    |                                  |        |
| Joe Garagiola, L (1, 2)<br>OBP: 0.414, SLG: 0.426          |  | 0-0<br>F7                       |                              |                                 | 0-0<br>G3                    |                                 |                              | 0-0<br>HR<br>BB<br>1B           | 0-0<br>P4                    | 2 0 0 0 0 0 0                   |                              |                                 |                              |                                 |                              |                                 |                                  |                                    |                                  |        |
| Eddie Kazak, R (8, PH)<br>OBP: 0.391, SLG: 0.500           |  |                                 |                              |                                 |                              |                                 |                              |                                 |                              | 1 1 1 0 0 0 0                   |                              |                                 |                              |                                 |                              |                                 |                                  |                                    |                                  |        |
| Del Rice, R (8, 2)<br>OBP: 0.214, SLG: 0.264               |  |                                 |                              |                                 |                              |                                 |                              |                                 |                              | 1 0 0 0 0 0 1                   |                              |                                 |                              |                                 |                              |                                 |                                  |                                    |                                  |        |
| Red Munger, R (1, 1)<br>OBP: 0.250, SLG: 0.200             |  |                                 | 0-0<br>4-3                   |                                 | 0-0<br>5-3                   |                                 |                              |                                 |                              | 2 0 0 0 0 0 0                   |                              |                                 |                              |                                 |                              |                                 |                                  |                                    |                                  |        |
| Fred Martin, R (7, 1)<br>OBP: 0.500, SLG: 1.000            |  |                                 |                              |                                 |                              |                                 |                              |                                 |                              | 0 0 0 0 0 0 0                   |                              |                                 |                              |                                 |                              |                                 |                                  |                                    |                                  |        |
| Eddie Miller, R (8, PH)<br>OBP: 0.344, SLG: 0.351          |  |                                 |                              |                                 |                              |                                 |                              |                                 |                              | 1 0 0 0 0 0 1                   |                              |                                 |                              |                                 |                              |                                 |                                  |                                    |                                  |        |
| Jim Hearn, R (8, 1)<br>OBP: 0.281, SLG: 0.231              |  |                                 |                              |                                 |                              |                                 |                              |                                 |                              | 0 0 0 0 0 0 0                   |                              |                                 |                              |                                 |                              |                                 |                                  |                                    |                                  |        |
| Gerry Staley, R (8, 1)<br>OBP: 0.281, SLG: 0.231           |  |                                 |                              |                                 |                              |                                 |                              |                                 |                              | 0 0 0 0 0 0 0                   |                              |                                 |                              |                                 |                              |                                 |                                  |                                    |                                  |        |
| Erv Dusak, R (8, 1)<br>OBP: 0.281, SLG: 0.231              |  |                                 |                              |                                 |                              |                                 |                              |                                 |                              | 0 0 0 0 0 0 0                   |                              |                                 |                              |                                 |                              |                                 |                                  |                                    |                                  |        |
| <b>Inning Stats</b>  | R: 1<br>E: 1<br>K: 0<br>S: 5   | H: 1<br>LOB: 1<br>BB: 0<br>P: 5 | R: 0<br>E: 0<br>K: 1<br>S: 5 | H: 0<br>LOB: 0<br>BB: 0<br>P: 5 | R: 0<br>E: 0<br>K: 0<br>S: 3 | H: 0<br>LOB: 0<br>BB: 0<br>P: 3 | R: 0<br>E: 0<br>K: 0<br>S: 3 | H: 1<br>LOB: 1<br>BB: 0<br>P: 4 | R: 0<br>E: 0<br>K: 0<br>S: 3 | H: 0<br>LOB: 0<br>BB: 0<br>P: 3 | R: 0<br>E: 0<br>K: 0<br>S: 4 | H: 1<br>LOB: 1<br>BB: 0<br>P: 4 | R: 3<br>E: 0<br>K: 0<br>S: 5 | H: 2<br>LOB: 0<br>BB: 1<br>P: 9 | R: 0<br>E: 0<br>K: 0<br>S: 4 | H: 1<br>LOB: 1<br>BB: 0<br>P: 4 | 1B: 4<br>2B: 1<br>3B: 0<br>HR: 1 | SF: 0<br>SAC: 0<br>DP: 1<br>HBP: 0 | WP: 0<br>PB: 0<br>SB: 0<br>CS: 0 | PA: 35 |
| <b>PITCHER</b><br>Ken Raffensberger, L (1, 1)<br>ERA: 4.35 | IP: 9.0<br>WLS: W<br>BF: 35<br>H: 6<br>R: 4<br>ER: 3<br>SO: 1<br>BB: 1<br>IBB: 0<br>HBP: 0<br>BLK: 0<br>WP: 0<br>HR: 1<br>S: 36<br>P: 40<br>ERA: 3.00<br>WHIP: 0.778 |                                 |                              |                                 |                              |                                 |                              |                                 |                              |                                 |                              |                                 |                              |                                 |                              |                                 |                                  |                                    |                                  |        |

St. Louis Cardinals @ Cincinnati Reds  
 Crosley Field, Cincinnati, OH  
 Fri May 26 1950, 3:33 AM EDT  
 Att: 10,387 - Unknown

livebaseballscorecards.com

|     |    |
|-----|----|
| AB  | 34 |
| R   | 4  |
| H   | 6  |
| RBI | 4  |
| BB  | 1  |
| SO  | 1  |
| LOB | 14 |





| Batter  | 1                    | 2                     | 3          | 4         | 5          | 6          | 7                  | 8          | 9 |
|---|----------------------|-----------------------|------------|-----------|------------|------------|--------------------|------------|---|
| Lloyd Merriman, L<br>OBP: 0.415, SLG: 0.478<br>(1, 8)   | 0-0<br>4-3           |                       | 0-0<br>F8  |           | 0-0<br>G3  |            | 0-0<br>1B          | 0-0<br>HR  |   |
| Grady Hatton, L<br>OBP: 0.336, SLG: 0.410<br>(1, 5)   | 4-0<br>FC6-4<br>BB   |                       | 0-0<br>4-3 |           |            | 0-0<br>4-3 | 0-0<br>F7          | 0-0<br>4-3 |   |
| Johnny Wyrostek, L<br>OBP: 0.387, SLG: 0.455<br>(1, 7)<br>(9, 9)  | 0-0<br>FC6-4<br>1-2f |                       |            | 0-0<br>F7 |            | 0-0<br>4-3 | 0-0<br>1B          | 4-0<br>BB  |   |
| Ron Northey, L<br>OBP: 0.351, SLG: 0.559<br>Peanuts Lowrey, R<br>OBP: 0.360, SLG: 0.323<br>(1, 9)<br>(9, 7) | 0-0<br>G3            |                       |            | 0-0<br>1B |            | 0-0<br>F9  | 0-0<br>3-1         | 0-0<br>F2  |   |
| Ted Kluszewski, L<br>OBP: 0.288, SLG: 0.471<br>Joe Adcock, R<br>OBP: 0.205, SLG: 0.190<br>(1, 3)<br>(8, 3)  |                      | 0-0<br>1B             |            | 0-0<br>1B |            |            | 0-0<br>HR          | 4-0<br>1B  |   |
| Johnny Pramesa, R<br>OBP: 0.355, SLG: 0.500<br>(1, 2)   |                      | 0-0<br>G6-4-3<br>1B   |            | 0-0<br>P4 |            |            | 0-0<br>SH5-4<br>1B | 0-0<br>5-3 |   |
| Connie Ryan, R<br>OBP: 0.333, SLG: 0.330<br>(1, 4)  |                      | 0-0<br>F8             |            | 0-0<br>F7 |            |            | 0-0<br>SH<br>1B    | 4-0<br>1B  |   |
| Virgil Stallcup, R<br>OBP: 0.284, SLG: 0.425<br>(1, 6)  |                      | 0-0<br>G6-4-3<br>1-2f |            |           | 0-0<br>6-3 |            | 0-0<br>SH5-4<br>1B | 0-0<br>1B  |   |
| Ken Raffensberger, R<br>OBP: 0.176, SLG: 0.176<br>(1, 1)  |                      |                       | 0-3<br>K   |           | 0-0<br>6-3 |            | 0-0<br>1B          | 0-0<br>HR  |   |

| Inning Stats                     | R: 0<br>E: 0<br>K: 0<br>S: 3       | H: 0<br>LOB: 1<br>BB: 1<br>P: 7 | R: 1<br>E: 0<br>K: 0<br>S: 4 | H: 2<br>LOB: 0<br>BB: 0<br>P: 4 | R: 0<br>E: 0<br>K: 1<br>S: 5 | H: 0<br>LOB: 0<br>BB: 0<br>P: 5 | R: 0<br>E: 0<br>K: 0<br>S: 5 | H: 2<br>LOB: 2<br>BB: 0<br>P: 5 | R: 0<br>E: 0<br>K: 0<br>S: 3 | H: 0<br>LOB: 0<br>BB: 0<br>P: 3 | R: 0<br>E: 0<br>K: 0<br>S: 3 | H: 0<br>LOB: 0<br>BB: 0<br>P: 3 | R: 3<br>E: 0<br>K: 0<br>S: 9 | H: 5<br>LOB: 3<br>BB: 0<br>P: 9 | R: 5<br>E: 0<br>K: 0<br>S: 6 | H: 3<br>LOB: 1<br>BB: 3<br>P: 18 |
|----------------------------------|------------------------------------|---------------------------------|------------------------------|---------------------------------|------------------------------|---------------------------------|------------------------------|---------------------------------|------------------------------|---------------------------------|------------------------------|---------------------------------|------------------------------|---------------------------------|------------------------------|----------------------------------|
| 1B: 9<br>2B: 1<br>3B: 0<br>HR: 2 | SF: 0<br>SAC: 2<br>DP: 1<br>HBP: 0 | WP: 0<br>PA: 40                 |                              |                                 |                              |                                 |                              |                                 |                              |                                 |                              |                                 |                              |                                 |                              |                                  |

| PITCHER                                | IP  | WLS | BF | H | R | ER | SO | BB | IBB | HBP | BLK | WP | HR | S  | P  | ERA    | WHIP   |
|--|-----|-----|----|---|---|----|----|----|-----|-----|-----|----|----|----|----|--------|--------|
| Red Munger, R<br>ERA: 3.89<br>(1, 1)   | 6.1 |     | 28 | 8 | 4 | 4  | 1  | 1  | 0   | 0   | 0   | 0  | 1  | 29 | 33 | 5.68   | 1.421  |
| Fred Martin, R<br>ERA: 3.97<br>(7, 1)  | 0.2 |     | 3  | 1 | 0 | 0  | 0  | 0  | 0   | 0   | 0   | 0  | 0  | 3  | 3  | 0.00   | 1.500  |
| Jim Hearn, R<br>ERA: 9.0<br>(8, 1)     | 0.0 | L   | 1  | 0 | 1 | 1  | 0  | 1  | 0   | 0   | 0   | 0  | 0  | 4  |    | ∞      | ∞      |
| Gerry Staley, R<br>ERA: 6.53<br>(8, 1) | 0.1 |     | 5  | 3 | 4 | 4  | 0  | 1  | 0   | 0   | 0   | 0  | 1  | 4  | 8  | 108.00 | 12.000 |
| Erv Dusak, R<br>ERA:<br>(8, 1)         | 0.2 |     | 3  | 0 | 0 | 0  | 0  | 1  | 0   | 0   | 0   | 0  | 0  | 2  | 6  | 0.00   | 1.500  |

**BOTTOM**

**St. Louis Cardinals @ Cincinnati Reds**  
Crosley Field, Cincinnati, OH

Fri May 26 1950, 3:33 AM EDT  
Att. 10,387 - Unknown

AB R H RBI BB SO LOB

|   |   |   |   |   |   |   |
|---|---|---|---|---|---|---|
| 5 | 1 | 2 | 3 | 0 | 0 | 0 |
| 4 | 0 | 0 | 0 | 1 | 0 | 2 |
| 4 | 0 | 1 | 0 | 1 | 0 | 1 |
| 5 | 0 | 1 | 0 | 0 | 0 | 5 |
| 0 | 0 | 0 | 0 | 0 | 0 | 0 |
| 3 | 2 | 3 | 1 | 0 | 0 | 0 |
| 0 | 1 | 0 | 0 | 1 | 0 | 0 |
| 4 | 1 | 2 | 1 | 0 | 0 | 3 |
| 2 | 2 | 0 | 0 | 1 | 0 | 3 |
| 3 | 1 | 1 | 1 | 0 | 0 | 1 |
| 4 | 1 | 2 | 3 | 0 | 1 | 0 |

AB 34  
R 9  
H 12  
RBI 9  
BB 4  
SO 1  
LOB 15



| Batter  | 1  | 2   | 3  | 4   | 5  | 6   | 7   | 8   | 9   | AB R H RBI BB SO LOB   | TOP   |         |   |
|---|--|---|--|---|--|---|---|---|---|--|---|---------|---|
| Tommy Glaviano, R<br>OBP: 0.423, SLG: 0.438<br>(1, 5) X   | 0-0<br>6-3   | 0-0<br>E6<br>CS   |  | 0-0<br>4-3  |  | 4-0<br>BB   |   | 0-0<br>HR<br>1-3<br>2-H<br>2B                                   |   | 4 1 1 1 1 0 0  |   |         |   |
| Red Schoendienst, S<br>OBP: 0.299, SLG: 0.333<br>(1, 4) S S S   | 0-3<br>K   | 0-0<br>CS<br>1-2  | 0-0<br>HR<br>1B  | 0-0<br>L8   |  | 0-0<br>L7   |   | 0-0<br>F8<br>3-H  |   | 5 1 1 1 0 1 2  |   |         |   |
| Stan Musial, L<br>OBP: 0.515, SLG: 0.763<br>(1, 3) X  | 0-0<br>BB<br>2B<br>1B  |   | 0-0<br>HR<br>1-H   | 0-0<br>1-3  |  | 0-0<br>4-3  |   | 0-0<br>HR<br>2-H  |   | 5 3 3 4 0 0 1  |   |         |   |
| Enos Slaughter, L<br>OBP: 0.428, SLG: 0.434<br>(1, 9) B B B   | 4-0<br>1-2<br>2B<br>BB   |   | 0-0<br>4-3<br>BB<br>F8<br>1B                                     |   | 0-3<br>K   |   | 0-0<br>2B<br>1B   | 0-0<br>1-3  |   | 4 2 2 0 1 1 0  |   |         |   |
| Bill Howerton, L<br>OBP: 0.383, SLG: 0.400<br>Johnny Lindell, R<br>OBP: 0.295, SLG: 0.340<br>(1, 7) B B B<br>(3, PH)<br>(3, 7)  | 4-0<br>1-2<br>2-3<br>2B<br>BB                                    |   | 4-0<br>1-2<br>4-3<br>BB  |   | 0-0<br>F4  |   | 0-0<br>4-3<br>1-H<br>2B   | 0-0<br>6-3  |   | 0 0 0 0 1 0 0<br>3 0 1 0 1 0 0   |   |         |   |
| Joe Garagiola, L<br>OBP: 0.413, SLG: 0.439<br>(1, 2) X  | 0-0<br>1-3<br>2-H<br>3-H<br>2B                                   |   | 0-0<br>4-3   |   | 0-0<br>BB<br>1B  |   | 0-0<br>4-3<br>2-3   |   | 0-3<br>K  | 5 0 2 2 0 1 3  |   |         |   |
| Harry Walker, L<br>OBP: 0.250, SLG: 0.161<br>Eddie Kazak, R<br>OBP: 0.417, SLG: 0.500<br>Chuck Diering, R<br>OBP: 0.300, SLG: 0.304<br>(1, 8) X<br>(3, PH)<br>(3, PR)<br>(3, 8) | 0-0<br>4-3   |   | 4-0<br>1-2<br>IBB  |   | 4-0<br>1-2<br>FC5-4<br>BB  |   | 0-0<br>6-3  |   | 0-3<br>K  | 1 0 0 0 0 0 2<br>0 0 0 0 1 0 0<br>2 0 0 0 1 1 1                        | AB 38<br>R 9<br>H 12<br>RBI 9<br>BB 6<br>SO 6<br>LOB 15                               |         |   |
| Marty Marion, R<br>OBP: 0.355, SLG: 0.292<br>(1, 6)   |  | 0-0<br>F7   | 0-0<br>F8<br>3-H   |   | 0-0<br>FC5-4<br>1-2f   |   | 0-0<br>1B<br>2B<br>1B   |   | 0-3<br>K  | 5 1 1 1 0 1 4  |   |         |   |
| Harry Brecheen, L<br>OBP: 0.176, SLG: 0.125<br>(1, 1)   |  | 0-0<br>6-3  | 0-0<br>3-1   |   | 0-3<br>K   |   | 0-0<br>2B<br>F8<br>1B   |   |   | 4 1 1 0 0 1 2  |  |         |   |
| Inning Stats  | R: 2<br>E: 0<br>K: 1<br>S: 7<br>H: 2<br>LOB: 2<br>BB: 2<br>P: 15 | R: 0<br>E: 1<br>K: 0<br>S: 3<br>H: 0<br>LOB: 0<br>BB: 0<br>P: 3 | R: 3<br>E: 0<br>K: 0<br>S: 6<br>H: 3<br>LOB: 2<br>BB: 2<br>P: 14 | R: 0<br>E: 0<br>K: 0<br>S: 3<br>H: 0<br>LOB: 0<br>BB: 0<br>P: 3 | R: 0<br>E: 0<br>K: 1<br>S: 6<br>H: 1<br>LOB: 2<br>BB: 1<br>P: 10 | R: 0<br>E: 0<br>K: 1<br>S: 5<br>H: 0<br>LOB: 1<br>BB: 1<br>P: 9 | R: 0<br>E: 0<br>K: 0<br>S: 4<br>H: 2<br>LOB: 1<br>BB: 0<br>P: 4 | R: 4<br>E: 0<br>K: 0<br>S: 7<br>H: 4<br>LOB: 0<br>BB: 0<br>P: 7 | R: 0<br>E: 0<br>K: 3<br>S: 9<br>H: 0<br>LOB: 0<br>BB: 0<br>P: 9 | 1B: 7<br>2B: 3<br>3B: 0<br>HR: 2<br>SF: 0<br>SAC: 0<br>DP: 0<br>HBP: 0 | WP: 0<br>PB: 0<br>SB: 0<br>CS: 1<br>PA: 45  |         |   |
| PITCHER   | IP WLS BF H R ER SO BB IBB HBP BLK WP HR S P ERA WHIP            |   |  |   |  |   |   |   |   |  |   | PITCHER | IP WLS BF H R ER SO BB IBB HBP BLK WP HR S P ERA WHIP |
| Herm Wehmeier, R<br>ERA: 6.41<br>(1, 1)   | 2.0 L 12 4 4 4 1 2 0 0 0 0 0 1 12 20 18.00 3.000                 |   |  |   |  |   |   |   |   |  |   |         |   |
| Harry Perkowski, L<br>ERA: 4.76<br>(3, 1)   | 5.0 22 4 1 1 2 3 1 0 0 0 0 0 22 38 1.80 1.400                    |   |  |   |  |   |   |   |   |  |   |         |   |
| Eddie Erault, R<br>ERA: 10.0<br>(8, 1)  | 0.1 5 4 4 4 0 0 0 0 0 0 0 1 5 5 108.00 12.000                    |   |  |   |  |   |   |   |   |  |   |         |   |
| Johnny Hetki, R<br>ERA: 7.24<br>(8, 1)  | 1.2 5 0 0 0 0 3 0 0 0 0 0 0 0 11 11 0.00 0.000                   |   |  |   |  |   |   |   |   |  |   |         |   |

St. Louis Cardinals @ Cincinnati Reds  
Crosley Field, Cincinnati, OH  
Sat May 27 1950, 3:33 AM EDT  
Att. 4,876 - Overcast - 81 F

livebaseballscorecards.com

| Batter   | 1      | 2          | 3         | 4      | 5 | 6                | 7     | 8          | 9       | AB | R | H | RBI | BB | SO | LOB |
|--|--------|------------|-----------|--------|---|------------------|-------|------------|---------|----|---|---|-----|----|----|-----|
| Lloyd Merriman, L (1, 8)<br>OBP: 0.404, SLG: 0.449   | 0-0 F7 |            | 0-0 F5    |        |   | 4-0 1B BB        | 0-3 K |            |         | 3  | 1 | 0 | 0   | 1  | 1  | 2   |
| Peanuts Lowrey, R (1, 7)<br>OBP: 0.354, SLG: 0.319   | 0-0 F5 |            | 0-0 F5    |        |   | 0-3 K            |       | 0-0 1B     |         | 4  | 0 | 1 | 0   | 0  | 1  | 2   |
| Johnny Wyrostek, L (1, 9)<br>OBP: 0.383, SLG: 0.447  | 0-0 F7 |            | 0-0 FC5-4 |        |   | 0-0 1B 1-3       |       | 0-0 G4-3-6 |         | 4  | 0 | 1 | 0   | 0  | 0  | 2   |
| Ted Kluszewski, L (1, 3)<br>OBP: 0.299, SLG: 0.473   |        | 0-0 2B 1B  |           | 0-0 F7 |   | 0-0 1-3 FC5-4 1B |       | 0-0 6-3    |         | 4  | 0 | 2 | 1   | 0  | 0  | 0   |
| Johnny Pramesa, R (1, 2)<br>OBP: 0.314, SLG: 0.438   |        | 0-0 F8     |           | 0-0 F6 |   | 0-0 F6           |       |            | 0-0 6-3 | 4  | 0 | 0 | 0   | 0  | 0  | 3   |
| Connie Ryan, R (1, 4)<br>OBP: 0.321, SLG: 0.315      |        | 0-0 F7     |           | 0-3 K  |   | 0-0 1-2 FC5-4    |       |            | 0-0 5-3 | 4  | 0 | 0 | 0   | 0  | 1  | 3   |
| Grady Hatton, L (1, 5)<br>OBP: 0.344, SLG: 0.426     |        | 0-0 1-3 2B |           |        |   |                  |       |            | 0-0 1-3 | 3  | 0 | 2 | 0   | 0  | 0  | 0   |
| Bobby Adams, R (7, PR)<br>OBP: 0.323, SLG: 0.333     |        |            |           |        |   |                  |       |            |         | 1  | 0 | 0 | 0   | 0  | 0  | 0   |
| Virgil Stallcup, R (1, 6)<br>OBP: 0.277, SLG: 0.413  |        | 0-0 5-3    |           |        |   |                  |       |            |         | 3  | 0 | 0 | 0   | 0  | 0  | 3   |
| Herm Wehmeier, R (1, 1)<br>OBP: 0.250, SLG: 0.304    |        |            | 0-0 FC5-4 |        |   |                  |       |            |         | 0  | 0 | 0 | 0   | 0  | 0  | 0   |
| Harry Perkowski, L (3, 1)<br>OBP: 0.600, SLG: 0.600  |        |            |           |        |   |                  |       |            |         | 2  | 0 | 1 | 0   | 0  | 1  | 0   |
| Danny Litwhiler, R (7, PH)<br>OBP: 0.333, SLG: 0.394 |        |            |           |        |   |                  |       |            |         | 1  | 0 | 0 | 0   | 0  | 0  | 1   |
| Eddie Erautt, R (8, 1)                               |        |            |           |        |   |                  |       |            |         | 0  | 0 | 0 | 0   | 0  | 0  | 0   |
| Johnny Hetki, R (8, 1)                               |        |            |           |        |   |                  |       |            |         | 0  | 0 | 0 | 0   | 0  | 0  | 0   |

| BOTTOM  |   |
|---|---|
| <b>St. Louis Cardinals @ Cincinnati Reds</b><br>Crosley Field, Cincinnati, OH<br>Sat May 27 1950, 3:33 AM EDT<br>Att. 4,876 - Overcast - 81 F |   |
| <b>AB</b> 33<br><b>R</b> 1<br><b>H</b> 7<br><b>RBI</b> 1<br><b>BB</b> 1<br><b>SO</b> 4<br><b>LOB</b> 16                                       |  |

| Inning Stats  | R: 0 | H: 0 | E: 0 | K: 0 | S: 3 | P: 3 | R: 0 | H: 2 | E: 0 | K: 0 | S: 5 | R: 0 | H: 1 | E: 0 | K: 0 | S: 4 | R: 0 | H: 0 | E: 0 | K: 1                      | S: 5 | R: 0 | H: 0 | E: 0 | K: 1 | S: 5 | R: 1 | H: 2 | E: 0 | K: 1 | S: 7 | R: 0 | H: 1 | E: 0 | K: 1 | S: 6 | R: 0 | H: 1 | E: 0 | K: 0 | S: 3 | R: 0 | H: 0 | E: 0 | K: 0 | S: 3 | 1B: 6 | SF: 0 | 2B: 1 | SAC: 0 | 3B: 0 | DP: 1 | HR: 0 | HBP: 0 | WP: 0 | PA: 34 |
|---|------|------|------|------|------|------|------|------|------|------|------|------|------|------|------|------|------|------|------|---------------------------|------|------|------|------|------|------|------|------|------|------|------|------|------|------|------|------|------|------|------|------|------|------|------|------|------|------|-------|-------|-------|--------|-------|-------|-------|--------|-------|--------|
| <b>PITCHER</b><br>Harry Brecheen, L (1, 1)<br>ERA: 2.02 | IP   | WLS  | BF   | H    | R    | ER   | SO   | BB   | IBB  | HBP  | BLK  | WP   | HR   | S    | P    | ERA  | WHIP |      |      |                           |      |      |      |      |      |      |      |      |      |      |      |      |      |      |      |      |      |      |      |      |      |      |      |      |      |      |       |       |       |        |       |       |       |        |       |        |
|   |      |      |      |      |      |      |      |      |      |      |      |      |      |      |      |      |      |      |      | <b>PITCHER</b><br>(Empty) | IP   | WLS  | BF   | H    | R    | ER   | SO   | BB   | IBB  | HBP  | BLK  | WP   | HR   | S    | P    | ERA  | WHIP |      |      |      |      |      |      |      |      |      |       |       |       |        |       |       |       |        |       |        |

| Batter   | 1   | 2                                | 3                            | 4                               | 5                            | 6                               | 7                            | 8                               | 9                            | AB R H RBI BB SO LOB            | TOP                          |                                 |                              |                                  |                              |                                  |                              |                                 |                                  |   |                                  |        |
|--|---|----------------------------------|------------------------------|---------------------------------|------------------------------|---------------------------------|------------------------------|---------------------------------|------------------------------|---------------------------------|------------------------------|---------------------------------|------------------------------|----------------------------------|------------------------------|----------------------------------|------------------------------|---------------------------------|----------------------------------|---|----------------------------------|--------|
| Tommy Glaviano, R (1, 5)<br>OBP: 0.440, SLG: 0.474   | 4-0<br>PB<br>2B<br>BB   | 0-0<br>SH1-3                     |                              | 0-0<br>1B                       |                              |                                 | 0-0<br>HR                    | 4-0<br>B3-6-4<br>BB             |                              | 2 2 2 1 2 0 0                   |                              |                                 |                              |                                  |                              |                                  |                              |                                 |                                  |   |                                  |        |
| Red Schoendienst, S (1, 4)<br>OBP: 0.295, SLG: 0.336 | 0-0<br>FC4-6<br>1-H<br>F8<br>2B   | 0-3<br>K                         |                              | 0-0<br>FC1-5<br>2-3f            |                              |                                 | 0-3<br>K                     | 0-0<br>B3-6-4<br>1-2f           |                              | 5 1 1 1 0 2 4                   |                              |                                 |                              |                                  |                              |                                  |                              |                                 |                                  |   |                                  |        |
| Stan Musial, L (1, 3)<br>OBP: 0.526, SLG: 0.759      | 4-0<br>FC4-6<br>BB  |                                  | 0-3<br>K                     |                                 | 0-0<br>4-3<br>S<br>6-3<br>1B |                                 | 4-0<br>HR<br>BB              | 4-0<br>FC5-4<br>BB              |                              | 2 2 1 0 3 1 0                   |                              |                                 |                              |                                  |                              |                                  |                              |                                 |                                  |   |                                  |        |
| Enos Slaughter, L (1, 9)<br>OBP: 0.427, SLG: 0.457   | 0-0<br>FC4-6<br>1-2f<br>2-3<br>S  |                                  | 0-0<br>1B                    |                                 | 0-0<br>4-3<br>1-3            |                                 | 0-0<br>1-H<br>HR             | 0-0<br>FC5-4<br>1-2f            |                              | 5 1 2 2 0 0 4                   |                              |                                 |                              |                                  |                              |                                  |                              |                                 |                                  |   |                                  |        |
| Bill Howerton, L (1, 7)<br>OBP: 0.365, SLG: 0.364    | 4-0<br>1-2<br>BB  |                                  | 0-0<br>F5                    |                                 | 0-0<br>6-3<br>3-H            |                                 | 0-0<br>F9                    |                                 | 0-3<br>K                     | 4 0 0 1 1 1 1                   |                              |                                 |                              |                                  |                              |                                  |                              |                                 |                                  |   |                                  |        |
| Harry Walker, L (1, 8)<br>OBP: 0.261, SLG: 0.180     | 0-0<br>F8<br>3-H  |                                  | 0-0<br>F7                    |                                 | 0-0<br>2-4<br>1B             |                                 | 0-0<br>BB<br>1B<br>1B        |                                 | 0-0<br>3-1                   | 5 0 2 1 0 0 3                   |                              |                                 |                              |                                  |                              |                                  |                              |                                 |                                  |   |                                  |        |
| Marty Marion, R (1, 6)<br>OBP: 0.358, SLG: 0.300     | 0-0<br>4-3  |                                  |                              | 0-0<br>FC1-5<br>1B<br>1B        | 0-0<br>2-4                   | 0-0<br>6-3                      | 0-0<br>BB<br>1B              |                                 | 0-0<br>6-3                   | 5 0 2 0 0 0 2                   |                              |                                 |                              |                                  |                              |                                  |                              |                                 |                                  |   |                                  |        |
| Del Rice, R (1, 2)<br>OBP: 0.233, SLG: 0.268         |   | 0-0<br>SH1-3<br>1B               |                              | 0-0<br>F6                       |                              | 0-0<br>F9                       | 4-0<br>1-2<br>2-3<br>BB      |                                 |                              | 3 0 1 0 1 0 1                   |                              |                                 |                              |                                  |                              |                                  |                              |                                 |                                  |   |                                  |        |
| Al Brazle, L (1, 1)<br>OBP: 0.143, SLG: 0.143        |   | 0-3<br>K                         |                              | 0-0<br>F8                       |                              | 0-0<br>1-3                      | 0-0<br>2-3                   |                                 |                              | 4 0 0 0 0 1 5                   |                              |                                 |                              |                                  |                              |                                  |                              |                                 |                                  |   |                                  |        |
| Howie Pollet, L (7, 1)<br>OBP: 0.083, SLG: 0.083     |   |                                  |                              |                                 |                              |                                 |                              |                                 |                              | 0 0 0 0 0 0 0                   |                              |                                 |                              |                                  |                              |                                  |                              |                                 |                                  |   |                                  |        |
| <b>Inning Stats</b>                                  | R: 2<br>E: 0<br>K: 0<br>S: 4  | H: 1<br>LOB: 2<br>BB: 3<br>P: 16 | R: 0<br>E: 0<br>K: 2<br>S: 8 | H: 1<br>LOB: 1<br>BB: 0<br>P: 8 | R: 0<br>E: 0<br>K: 1<br>S: 6 | H: 1<br>LOB: 1<br>BB: 0<br>P: 6 | R: 0<br>E: 0<br>K: 0<br>S: 5 | H: 2<br>LOB: 2<br>BB: 0<br>P: 5 | R: 1<br>E: 0<br>K: 0<br>S: 4 | H: 2<br>LOB: 1<br>BB: 0<br>P: 4 | R: 0<br>E: 0<br>K: 0<br>S: 3 | H: 0<br>LOB: 0<br>BB: 0<br>P: 3 | R: 3<br>E: 0<br>K: 1<br>S: 9 | H: 4<br>LOB: 3<br>BB: 2<br>P: 17 | R: 0<br>E: 0<br>K: 0<br>S: 2 | H: 0<br>LOB: 1<br>BB: 2<br>P: 10 | R: 0<br>E: 0<br>K: 1<br>S: 5 | H: 0<br>LOB: 0<br>BB: 0<br>P: 5 | 1B: 8<br>2B: 1<br>3B: 0<br>HR: 2 | SF: 0<br>SAC: 1<br>DP: 1<br>HBP: 0  | WP: 0<br>PB: 1<br>SB: 2<br>CS: 0 | PA: 43 |
| <b>PITCHER</b>                                       | IP<br>WLS<br>BF<br>H<br>R<br>ER<br>SO<br>BB<br>IBB<br>HBP<br>BLK<br>WP<br>HR<br>S<br>P<br>ERA<br>WHIP |                                  |                              |                                 |                              |                                 |                              |                                 |                              |                                 |                              |                                 |                              |                                  |                              |                                  |                              |                                 |                                  | IP<br>WLS<br>BF<br>H<br>R<br>ER<br>SO<br>BB<br>IBB<br>HBP<br>BLK<br>WP<br>HR<br>S<br>P<br>ERA<br>WHIP |                                  |        |
| Willie Ramsdell, R (1, 1)<br>ERA: 3.75               | 6.1<br>L<br>32<br>9<br>6<br>6<br>4<br>4<br>0<br>0<br>0<br>0<br>2<br>35<br>51<br>8.53<br>2.053         |                                  |                              |                                 |                              |                                 |                              |                                 |                              |                                 |                              |                                 |                              |                                  |                              |                                  |                              |                                 |                                  |   |                                  |        |
| Harry Perkowski, L (7, 1)<br>ERA: 4.5                | 0.2<br>5<br>2<br>0<br>0<br>0<br>0<br>1<br>0<br>0<br>0<br>0<br>0<br>4<br>8<br>0.00<br>4.500            |                                  |                              |                                 |                              |                                 |                              |                                 |                              |                                 |                              |                                 |                              |                                  |                              |                                  |                              |                                 |                                  |   |                                  |        |
| Johnny Hetki, R (8, 1)<br>ERA: 6.32                  | 2.0<br>7<br>0<br>0<br>0<br>0<br>1<br>2<br>0<br>0<br>0<br>0<br>0<br>7<br>15<br>0.00<br>1.000           |                                  |                              |                                 |                              |                                 |                              |                                 |                              |                                 |                              |                                 |                              |                                  |                              |                                  |                              |                                 |                                  |   |                                  |        |

St. Louis Cardinals @ Cincinnati Reds  
Crosley Field, Cincinnati, OH  
Sun May 28 1950, 3:33 AM EDT  
Unknown

livebaseballscorecards.com

|     |    |
|-----|----|
| AB  | 35 |
| R   | 6  |
| H   | 11 |
| RBI | 6  |
| BB  | 7  |
| SO  | 5  |
| LOB | 20 |



**BOTTOM**

**St. Louis Cardinals @ Cincinnati Reds**  
 Crosley Field, Cincinnati, OH  
 Sun May 28 1950, 3:33 AM EDT  
 Unknown

[livebaseballscorecards.com](http://livebaseballscorecards.com)

|            |           |
|------------|-----------|
| <b>AB</b>  | <b>32</b> |
| <b>R</b>   | <b>1</b>  |
| <b>H</b>   | <b>9</b>  |
| <b>RBI</b> | <b>1</b>  |
| <b>BB</b>  | <b>6</b>  |
| <b>SO</b>  | <b>3</b>  |
| <b>LOB</b> | <b>20</b> |



|       |        |
|-------|--------|
| WP: 1 | PA: 38 |
| PB: 0 |        |
| SB: 0 |        |
| CS: 0 |        |

|   |   |   |   |   |   |   |
|---|---|---|---|---|---|---|
| 3 | 0 | 1 | 0 | 0 | 0 | 1 |
| 0 | 0 | 0 | 0 | 1 | 0 | 0 |
| 0 | 0 | 0 | 0 | 0 | 0 | 0 |
| 0 | 0 | 0 | 0 | 1 | 0 | 0 |

|   |   |   |   |   |   |   |
|---|---|---|---|---|---|---|
| 4 | 0 | 2 | 0 | 1 | 0 | 2 |
|---|---|---|---|---|---|---|

|   |   |   |   |   |   |   |
|---|---|---|---|---|---|---|
| 3 | 1 | 2 | 0 | 1 | 0 | 2 |
|---|---|---|---|---|---|---|

|   |   |   |   |   |   |   |
|---|---|---|---|---|---|---|
| 4 | 0 | 0 | 0 | 0 | 1 | 5 |
|---|---|---|---|---|---|---|

|   |   |   |   |   |   |   |
|---|---|---|---|---|---|---|
| 3 | 0 | 1 | 0 | 1 | 1 | 2 |
|---|---|---|---|---|---|---|

|   |   |   |   |   |   |   |
|---|---|---|---|---|---|---|
| 3 | 0 | 1 | 1 | 1 | 0 | 3 |
|---|---|---|---|---|---|---|

|   |   |   |   |   |   |   |
|---|---|---|---|---|---|---|
| 4 | 0 | 0 | 0 | 0 | 1 | 3 |
|---|---|---|---|---|---|---|

|   |   |   |   |   |   |   |
|---|---|---|---|---|---|---|
| 4 | 0 | 1 | 0 | 0 | 0 | 1 |
|---|---|---|---|---|---|---|

|   |   |   |   |   |   |   |
|---|---|---|---|---|---|---|
| 2 | 0 | 1 | 0 | 0 | 0 | 0 |
| 0 | 0 | 0 | 0 | 0 | 0 | 0 |
| 2 | 0 | 0 | 0 | 0 | 0 | 1 |

|       |        |
|-------|--------|
| 1B: 8 | SF: 0  |
| 2B: 1 | SAC: 0 |
| 3B: 0 | DP: 2  |
| HR: 0 | HBP: 0 |

| Batter   | 1                | 2                     | 3                     | 4                | 5          | 6                            | 7                     | 8         | 9               |
|--|------------------|-----------------------|-----------------------|------------------|------------|------------------------------|-----------------------|-----------|-----------------|
| Lloyd Merriman, L (1, 8)<br>OBP: 0.400, SLG: 0.442<br>Danny Litwhiler, R (7, PH)<br>OBP: 0.350, SLG: 0.394<br>Johnny Hetki, R (8, 1)<br>Bobby Adams, R (9, PH)<br>OBP: 0.330, SLG: 0.333 | 0-0<br>G3<br>1B  |                       | 0-0<br>G6-4-3<br>1B   |                  | 0-0<br>1-3 |                              | 4-0<br>1B<br>BB       |           | 4-0<br>BB<br>BB |
| Peanuts Lowrey, R (1, 7)<br>OBP: 0.369, SLG: 0.329   | 4-0<br>BB        |                       | 0-0<br>G6-4-3<br>1-2f |                  |            | 0-0<br>1B                    | 0-0<br>1B             | 0-0<br>1B | 0-0<br>F4       |
| Johnny Wyrostek, L (1, 9)<br>OBP: 0.395, SLG: 0.453  | 0-0<br>1-2<br>1B |                       |                       | 4-0<br>2B<br>BB  |            | 0-0<br>E8<br>6-3<br>WP<br>1B | 0-0<br>FC3-6<br>1-    |           |                 |
| Ted Kluszewski, L (1, 3)<br>OBP: 0.284, SLG: 0.449   | 0-0<br>F8        |                       |                       | 0-0<br>P2        |            | 0-0<br>F6                    |                       | 0-3<br>K  |                 |
| Johnny Pramesa, R (1, 2)<br>OBP: 0.333, SLG: 0.457   | 0-0<br>F8        |                       |                       | 0-0<br>1-H<br>2B |            | 4-0<br>WP<br>6-3<br>BB       |                       | 0-3<br>K  |                 |
| Connie Ryan, R (1, 4)<br>OBP: 0.327, SLG: 0.316  |                  | 0-0<br>G4-6-3<br>1B   |                       | 0-0<br>5-3       |            | 0-0<br>6-3                   |                       | 4-0<br>BB |                 |
| Grady Hatton, L (1, 5)<br>OBP: 0.333, SLG: 0.411   |                  | 0-0<br>F6             |                       |                  | 0-0<br>3-1 | 0-3<br>K                     |                       | 0-0<br>F8 |                 |
| Virgil Stallcup, R (1, 6)<br>OBP: 0.276, SLG: 0.407  |                  | 0-0<br>G4-6-3<br>1-2f |                       |                  | 0-0<br>4-3 |                              | 0-0<br>BB<br>1B<br>1B | 0-0<br>F6 |                 |
| Willie Ramsdell, R (1, 1)<br>OBP: 0.111, SLG: 0.111<br>Harry Perkowski, L (7, 1)<br>OBP: 0.600, SLG: 0.600<br>Bob Usher, R (7, PH)<br>OBP: 0.288, SLG: 0.491                             |                  |                       | 0-0<br>6-3            |                  | 0-0<br>1B  |                              | 0-0<br>F8             | 0-0<br>F9 |                 |

| Inning Stats | R: 0 | H: 1 | E: 0 | LOB: 2 | K: 0 | S: 4 | R: 0 | H: 1 | E: 0 | LOB: 0 | K: 0 | S: 3 | R: 0 | H: 1 | E: 0 | LOB: 0 | K: 0 | S: 3 | R: 0 | H: 1 | E: 0 | LOB: 1 | K: 0 | S: 3 | R: 0 | H: 1 | E: 0 | LOB: 1 | K: 0 | S: 4 | R: 2 | H: 2 | E: 1 | LOB: 1 | K: 1 | S: 7 | R: 0 | H: 2 | E: 0 | LOB: 2 | K: 0 | S: 4 | R: 0 | H: 0 | E: 0 | LOB: 1 | K: 2 | S: 7 | R: 0 | H: 0 | E: 0 | LOB: 1 | K: 0 | S: 3 | 1B: 8 | SF: 0 | 2B: 1 | SAC: 0 | 3B: 0 | DP: 2 | HR: 0 | HBP: 0 |
|--------------|------|------|------|--------|------|------|------|------|------|--------|------|------|------|------|------|--------|------|------|------|------|------|--------|------|------|------|------|------|--------|------|------|------|------|------|--------|------|------|------|------|------|--------|------|------|------|------|------|--------|------|------|------|------|------|--------|------|------|-------|-------|-------|--------|-------|-------|-------|--------|
|--------------|------|------|------|--------|------|------|------|------|------|--------|------|------|------|------|------|--------|------|------|------|------|------|--------|------|------|------|------|------|--------|------|------|------|------|------|--------|------|------|------|------|------|--------|------|------|------|------|------|--------|------|------|------|------|------|--------|------|------|-------|-------|-------|--------|-------|-------|-------|--------|

| PITCHER                             | IP  | WLS | BF | H | R | ER | SO | BB | IBB | HBP | BLK | WP | HR | S  | P  | ERA  | WHIP  |
|-------------------------------------|-----|-----|----|---|---|----|----|----|-----|-----|-----|----|----|----|----|------|-------|
| Al Brazle, L (1, 1)<br>ERA: 2.08    | 6.2 | W   | 29 | 9 | 2 | 2  | 1  | 4  | 0   | 0   | 0   | 1  | 0  | 27 | 43 | 2.70 | 1.950 |
| Howie Pollet, L (7, 1)<br>ERA: 2.95 | 2.1 | S   | 9  | 0 | 0 | 0  | 2  | 2  | 0   | 0   | 0   | 0  | 0  | 11 | 19 | 0.00 | 0.857 |

| Batter  | 1   | 2                                | 3                            | 4                               | 5                            | 6                               | 7                            | 8                                | 9                            | AB R H RBI BB SO LOB            | TOP                          |                                 |                              |                                 |                              |                                 |                              |                                 |                                  |                                    |                                  |   |
|---|---|----------------------------------|------------------------------|---------------------------------|------------------------------|---------------------------------|------------------------------|----------------------------------|------------------------------|---------------------------------|------------------------------|---------------------------------|------------------------------|---------------------------------|------------------------------|---------------------------------|------------------------------|---------------------------------|----------------------------------|------------------------------------|----------------------------------|---|
| Tommy Glaviano, R<br>OBP: 0.438, SLG: 0.466<br>(1, 5) X   | 0-0<br>E<br>2B<br>1B  | 0-0<br>1-3                       |                              | 4-0<br>HR<br>BB                 |                              | 0-0<br>1-3                      |                              | 0-0<br>1-3                       |                              | 4 2 1 0 1 0 0                   |                              |                                 |                              |                                 |                              |                                 |                              |                                 |                                  |                                    |                                  |   |
| Red Schoendienst, S<br>OBP: 0.299, SLG: 0.354<br>(1, 4) X | 0-0<br>E4<br>2B<br>1-2<br>HR  | 0-0<br>F8                        |                              | 0-0<br>1-H<br>HR                |                              | 4-0<br>FC3-6<br>1B<br>BB        |                              | 0-0<br>4-3                       |                              | 4 2 1 2 1 0 1                   |                              |                                 |                              |                                 |                              |                                 |                              |                                 |                                  |                                    |                                  |   |
| Stan Musial, L<br>OBP: 0.521, SLG: 0.742<br>(1, 3) X      | 0-0<br>F9   | 0-0<br>1-3                       |                              | 4-0<br>1B<br>BB                 |                              | 0-0<br>FC3-6<br>1B              |                              |                                  | 0-0<br>F3                    | 4 0 1 0 1 0 2                   |                              |                                 |                              |                                 |                              |                                 |                              |                                 |                                  |                                    |                                  |   |
| Enos Slaughter, L<br>OBP: 0.426, SLG: 0.462<br>(1, 9) X   | 0-0<br>1-3<br>2-H<br>HR<br>2B   |                                  | 0-0<br>1-3                   | 0-0<br>1-2<br>1B                |                              | 0-0<br>FC3-6<br>1-2f<br>2-3     |                              |                                  | 0-0<br>F4                    | 5 1 2 1 0 0 2                   |                              |                                 |                              |                                 |                              |                                 |                              |                                 |                                  |                                    |                                  |   |
| Bill Howerton, L<br>OBP: 0.351, SLG: 0.333<br>(1, 7) X    | 4-0<br>HR<br>IBB  |                                  | 0-0<br>1-3                   | 0-0<br>F7                       |                              | 0-0<br>G3                       |                              |                                  | 0-0<br>F5                    | 4 1 0 0 1 0 4                   |                              |                                 |                              |                                 |                              |                                 |                              |                                 |                                  |                                    |                                  |   |
| Joe Garagiola, L<br>OBP: 0.430, SLG: 0.514<br>(1, 2) X    | 0-0<br>1-H<br>2-H<br>3-H<br>HR  |                                  | 0-0<br>2B                    |                                 | 0-0<br>BLK<br>1B             |                                 | 0-0<br>F7                    |                                  |                              | 4 1 3 4 0 0 0                   |                              |                                 |                              |                                 |                              |                                 |                              |                                 |                                  |                                    |                                  |   |
| Harry Walker, L<br>OBP: 0.260, SLG: 0.185<br>(1, 8) X     | 0-0<br>1B   |                                  | 0-0<br>6-3                   |                                 | 0-0<br>F5                    |                                 | 0-0<br>F5                    |                                  |                              | 4 0 1 0 0 0 2                   |                              |                                 |                              |                                 |                              |                                 |                              |                                 |                                  |                                    |                                  |   |
| Eddie Miller, R<br>OBP: 0.324, SLG: 0.328<br>(1, 6) X     | 0-0<br>F6   |                                  |                              | 0-0<br>6-3                      | 0-3<br>K                     |                                 | 0-0<br>F2                    |                                  |                              | 4 0 0 0 0 1 2                   |                              |                                 |                              |                                 |                              |                                 |                              |                                 |                                  |                                    |                                  |   |
| Max Lanier, R<br>OBP: 0.313, SLG: 0.231<br>(1, 1) X       | 0-0<br>P3   |                                  |                              | 0-0<br>6-3                      | 0-3<br>K                     |                                 |                              | 0-0<br>5-3                       |                              | 4 0 0 0 0 1 2                   |                              |                                 |                              |                                 |                              |                                 |                              |                                 |                                  |                                    |                                  |   |
| <b>Inning Stats</b>                                       | R: 5<br>E: 1<br>K: 0<br>S: 8  | H: 4<br>LOB: 1<br>BB: 1<br>P: 12 | R: 0<br>E: 0<br>K: 0<br>S: 3 | H: 0<br>LOB: 0<br>BB: 0<br>P: 3 | R: 0<br>E: 0<br>K: 0<br>S: 4 | H: 1<br>LOB: 1<br>BB: 0<br>P: 4 | R: 2<br>E: 0<br>K: 0<br>S: 5 | H: 2<br>LOB: 2<br>BB: 2<br>P: 13 | R: 0<br>E: 0<br>K: 2<br>S: 8 | H: 1<br>LOB: 1<br>BB: 0<br>P: 8 | R: 0<br>E: 0<br>K: 0<br>S: 4 | H: 1<br>LOB: 2<br>BB: 1<br>P: 8 | R: 0<br>E: 0<br>K: 0<br>S: 3 | H: 0<br>LOB: 0<br>BB: 0<br>P: 3 | R: 0<br>E: 0<br>K: 0<br>S: 3 | H: 0<br>LOB: 0<br>BB: 0<br>P: 3 | R: 0<br>E: 0<br>K: 0<br>S: 3 | H: 0<br>LOB: 0<br>BB: 0<br>P: 3 | 1B: 5<br>2B: 2<br>3B: 0<br>HR: 2 | SF: 0<br>SAC: 0<br>DP: 0<br>HBP: 0 | WP: 0<br>PB: 0<br>SB: 1<br>CS: 0 | PA: 41  |
| <b>PITCHER</b>  | IP<br>WLS<br>BF<br>H<br>R<br>ER<br>SO<br>BB<br>IBB<br>HBP<br>BLK<br>WP<br>HR<br>S<br>P<br>ERA<br>WHIP |                                  |                              |                                 |                              |                                 |                              |                                  |                              |                                 |                              |                                 |                              |                                 |                              |                                 |                              |                                 |                                  |                                    | <b>PITCHER</b>                   | IP<br>WLS<br>BF<br>H<br>R<br>ER<br>SO<br>BB<br>IBB<br>HBP<br>BLK<br>WP<br>HR<br>S<br>P<br>ERA<br>WHIP |
| Ewell Blackwell, R<br>ERA: 3.08<br>(1, 1)                 | 0.1<br>L<br>7<br>4<br>5<br>4<br>0<br>0<br>0<br>0<br>0<br>0<br>1<br>6<br>10<br>108.00<br>12.000        |                                  |                              |                                 |                              |                                 |                              |                                  |                              |                                 |                              |                                 |                              |                                 |                              |                                 |                              |                                 |                                  |                                    |                                  |   |
| Howie Fox, R<br>ERA: 5.46<br>(1, 1)                       | 6.2<br>28<br>5<br>2<br>2<br>2<br>3<br>0<br>0<br>0<br>0<br>0<br>1<br>29<br>41<br>2.70<br>1.200         |                                  |                              |                                 |                              |                                 |                              |                                  |                              |                                 |                              |                                 |                              |                                 |                              |                                 |                              |                                 |                                  |                                    |                                  |   |
| Eddie Erault, R<br>ERA: 9.0<br>(8, 1)                     | 2.0<br>6<br>0<br>0<br>0<br>0<br>0<br>0<br>0<br>0<br>0<br>0<br>0<br>6<br>6<br>0.00<br>0.000            |                                  |                              |                                 |                              |                                 |                              |                                  |                              |                                 |                              |                                 |                              |                                 |                              |                                 |                              |                                 |                                  |                                    |                                  |   |

St. Louis Cardinals @ Cincinnati Reds  
Crosley Field, Cincinnati, OH  
Sun May 28 1950, 3:38 AM EDT  
Att. 14,008 - Unknown

livebaseballscorecards.com

|     |    |
|-----|----|
| AB  | 37 |
| R   | 7  |
| H   | 9  |
| RBI | 7  |
| BB  | 4  |
| SO  | 2  |
| LOB | 15 |





| Batter   | 1   | 2                               | 3                            | 4                               | 5                            | 6                               | 7                            | 8                               | 9                            | AB R H RBI BB SO LOB            | TOP                          |                                  |                              |                                 |                              |                                 |                                  |                                    |                                  |        |
|--|---|---------------------------------|------------------------------|---------------------------------|------------------------------|---------------------------------|------------------------------|---------------------------------|------------------------------|---------------------------------|------------------------------|----------------------------------|------------------------------|---------------------------------|------------------------------|---------------------------------|----------------------------------|------------------------------------|----------------------------------|--------|
| <b>Peanuts Lowrey, R</b> (1, 7)<br>OBP: 0.362, SLG: 0.309  | 0-0<br>6-3  |                                 |                              | 0-0<br>F7                       |                              | 4-0<br>WP SH1-4 HR BB           | 4-0<br>BB BB                 |                                 | 0-0<br>L5                    | 3 1 0 0 2 0 0                   |                              |                                  |                              |                                 |                              |                                 |                                  |                                    |                                  |        |
| <b>Johnny Wyrostek, L</b> (1, 9)<br>OBP: 0.386, SLG: 0.442   | 0-0<br>L3   |                                 |                              | 0-3<br>K                        |                              | 0-0<br>SH1-4                    | 4-0<br>1-2                   |                                 |                              | 2 0 0 0 1 1 0                   |                              |                                  |                              |                                 |                              |                                 |                                  |                                    |                                  |        |
| <b>Bob Usher, R</b> (1, 8)<br>OBP: 0.288, SLG: 0.468<br><b>Lloyd Merriman, L</b> (7, PH)<br>OBP: 0.393, SLG: 0.434 | 0-0<br>F8   |                                 |                              | 0-3<br>K                        |                              | 0-0<br>F8                       | 0-0<br>P4                    |                                 |                              | 3 0 0 0 0 1 1<br>1 0 0 0 0 0 3  |                              |                                  |                              |                                 |                              |                                 |                                  |                                    |                                  |        |
| <b>Ted Kluszewski, L</b> (1, 3)<br>OBP: 0.292, SLG: 0.512  |   | 0-0<br>F8                       |                              |                                 | 0-0<br>HR                    | 0-0<br>2-H HR                   |                              | 0-0<br>CS 1B                    |                              | 4 2 3 3 0 0 0                   |                              |                                  |                              |                                 |                              |                                 |                                  |                                    |                                  |        |
| <b>Sammy Meeks, R</b> (1, 6)<br>OBP: 0.167, SLG: 0.353   |   | 0-0<br>1-3                      |                              |                                 | 0-0<br>6-3                   | 0-0<br>F8                       |                              | 0-3<br>K 1-2                    |                              | 4 0 0 0 0 1 1                   |                              |                                  |                              |                                 |                              |                                 |                                  |                                    |                                  |        |
| <b>Johnny Pramesa, R</b> (1, 2)<br>OBP: 0.349, SLG: 0.462  |   | 0-0<br>5-3                      |                              |                                 | 0-0<br>BB 1B                 |                                 | 0-3<br>K                     | 0-0<br>1B                       |                              | 4 0 2 0 0 1 0                   |                              |                                  |                              |                                 |                              |                                 |                                  |                                    |                                  |        |
| <b>Grady Hatton, L</b> (1, 5)<br>OBP: 0.321, SLG: 0.387  |   |                                 | 0-0<br>F8                    |                                 | 4-0<br>1-2 BB                |                                 | 0-3<br>K                     | 0-0<br>F7                       |                              | 3 0 0 0 1 1 1                   |                              |                                  |                              |                                 |                              |                                 |                                  |                                    |                                  |        |
| <b>Connie Ryan, R</b> (1, 4)<br>OBP: 0.347, SLG: 0.350   |   |                                 | 0-0<br>5-3                   |                                 | 0-0<br>F7                    |                                 | 0-0<br>HR                    |                                 | 0-0<br>SH1-4-S 1B            | 4 1 2 1 0 0 2                   |                              |                                  |                              |                                 |                              |                                 |                                  |                                    |                                  |        |
| <b>Ken Raffensberger, R</b> (1, 1)<br>OBP: 0.200, SLG: 0.158   |   |                                 | 0-0<br>F7                    |                                 | 0-0<br>F7                    |                                 | 4-0<br>BB BB BB              |                                 | 0-0<br>SH1-4-5 1-3f          | 2 0 0 0 1 0 2                   |                              |                                  |                              |                                 |                              |                                 |                                  |                                    |                                  |        |
| <b>Inning Stats</b>  | R: 0<br>E: 0<br>K: 0<br>S: 3                          | H: 0<br>LOB: 0<br>BB: 0<br>P: 3 | R: 0<br>E: 0<br>K: 0<br>S: 3 | H: 0<br>LOB: 0<br>BB: 0<br>P: 3 | R: 0<br>E: 0<br>K: 2<br>S: 7 | H: 0<br>LOB: 0<br>BB: 0<br>P: 7 | R: 1<br>E: 0<br>K: 0<br>S: 5 | H: 2<br>LOB: 2<br>BB: 1<br>P: 9 | R: 2<br>E: 0<br>K: 0<br>S: 4 | H: 1<br>LOB: 0<br>BB: 1<br>P: 8 | R: 1<br>E: 0<br>K: 2<br>S: 8 | H: 1<br>LOB: 3<br>BB: 3<br>P: 20 | R: 0<br>E: 0<br>K: 1<br>S: 6 | H: 2<br>LOB: 1<br>BB: 0<br>P: 6 | R: 0<br>E: 0<br>K: 0<br>S: 3 | H: 1<br>LOB: 0<br>BB: 0<br>P: 3 | 1B: 4<br>2B: 2<br>3B: 0<br>HR: 3 | SF: 0<br>SAC: 2<br>DP: 2<br>HBP: 0 | WP: 1<br>PB: 0<br>SB: 0<br>CS: 1 | PA: 37 |
| <b>PITCHER</b>   | IP WLS BF H R ER SO BB IBB HBP BLK WP HR S P ERA WHIP |                                 |                              |                                 |                              |                                 |                              |                                 |                              |                                 |                              |                                  |                              |                                 |                              |                                 |                                  |                                    |                                  |        |
| <b>Johnny Vander Meer, L</b> (1, 1)<br>ERA: 4.8  | 6.2 L 29 4 4 4 4 5 0 0 0 1 3 32 52 5.40 1.350         |                                 |                              |                                 |                              |                                 |                              |                                 |                              |                                 |                              |                                  |                              |                                 |                              |                                 |                                  |                                    |                                  |        |
| <b>Doyle Lade, R</b> (7, 1)<br>ERA: 5.6  | 2.1 8 3 0 0 1 0 0 0 0 0 0 10 10 0.00 1.286            |                                 |                              |                                 |                              |                                 |                              |                                 |                              |                                 |                              |                                  |                              |                                 |                              |                                 |                                  |                                    |                                  |        |

Cincinnati Reds @ Chicago Cubs  
Wrigley Field, Chicago, IL  
Tue May 30 1950, 3:33 AM CDT  
Unknown

livebaseballscorecards.com

|     |    |
|-----|----|
| AB  | 30 |
| R   | 4  |
| H   | 7  |
| RBI | 4  |
| BB  | 5  |
| SO  | 5  |
| LOB | 10 |





| Batter   | 1         | 2                | 3           | 4          | 5             | 6                       | 7                       | 8          | 9          | AB R H RBI BB SO LOB                            |
|--|-----------|------------------|-------------|------------|---------------|-------------------------|-------------------------|------------|------------|---|
| Wayne Terwilliger, R<br>OBP: 0.364, SLG: 0.471<br>(1, 4) | 0-0<br>1B |                  | 0-0<br>F8   |            | 0-0<br>G5-4-3 |                         | 0-0<br>F7               |            | 0-0<br>6-3 | 5 0 1 0 0 0 3                                   |
| Mickey Owen, R<br>OBP: 0.225, SLG: 0.239<br>(1, 2)       | 0-3<br>K  |                  | 0-0<br>F7   |            |               | 0-0<br>1-3              | 0-0<br>PB<br>1B         |            |            | 4 0 1 0 0 1 1                                   |
| Phil Cavarretta, L<br>OBP: 0.362, SLG: 0.412<br>(1, 3)   | 0-0<br>P5 |                  | 0-0<br>B1-3 |            |               | 0-0<br>BB<br>1B         | 4-0<br>1-2<br>2-3<br>BB |            |            | 3 1 1 0 1 0 1                                   |
| Hank Sauer, R<br>OBP: 0.409, SLG: 0.540<br>(1, 7)        | 0-3<br>K  |                  |             | 0-0<br>1-3 |               | 4-0<br>1-2<br>BB<br>1B  | 0-0<br>P6               |            |            | 3 0 0 0 1 1 4                                   |
| Andy Pafko, R<br>OBP: 0.441, SLG: 0.584<br>(1, 8)        |           | 0-0<br>6-3       |             | 0-0<br>5-3 |               | 0-0<br>F8               |                         | 0-0<br>6-3 |            | 4 0 0 0 0 0 2                                   |
| Bill Serena, R<br>OBP: 0.316, SLG: 0.343<br>(1, 5)       |           | 0-0<br>5-3       |             | 0-0<br>L4  |               | 0-0<br>1-2<br>2-H<br>1B |                         | 0-0<br>F8  |            | 4 0 1 1 0 0 0                                   |
| Roy Smalley, R<br>OBP: 0.293, SLG: 0.410<br>(1, 6)       |           | 0-0<br>1B<br>1B  |             |            | 0-3<br>K      | 0-0<br>F8               |                         | 0-0<br>F7  |            | 4 0 1 0 0 1 2                                   |
| Bob Borkowski, R<br>OBP: 0.440, SLG: 0.550<br>(1, 9)     |           | 0-0<br>1-2<br>1B |             |            | 0-0<br>2B     |                         | 0-0<br>F9               |            | 0-0<br>F3  | 4 0 2 0 0 0 0                                   |
| Johnny Vander Meer, S<br>(1, 1)                          |           | 0-3<br>K         |             |            | 4-0<br>BB     |                         | 0-0<br>PB<br>1B<br>1B   |            | 0-3<br>K   | 1 0 0 0 1 1 2<br>1 0 1 0 0 0 0<br>1 0 0 0 0 1 0 |

| Inning Stats | R: 0<br>E: 0<br>K: 2<br>S: 8 | H: 1<br>LOB: 1<br>BB: 0<br>P: 8 | R: 0<br>E: 0<br>K: 1<br>S: 7 | H: 2<br>LOB: 2<br>BB: 0<br>P: 7 | R: 0<br>E: 0<br>K: 0<br>S: 3 | H: 0<br>LOB: 0<br>BB: 0<br>P: 3 | R: 0<br>E: 0<br>K: 0<br>S: 3 | H: 0<br>LOB: 0<br>BB: 0<br>P: 3 | R: 0<br>E: 0<br>K: 1<br>S: 5 | H: 1<br>LOB: 1<br>BB: 1<br>P: 9 | R: 1<br>E: 0<br>K: 0<br>S: 5 | H: 2<br>LOB: 2<br>BB: 1<br>P: 9 | R: 0<br>E: 0<br>K: 0<br>S: 5 | H: 2<br>LOB: 3<br>BB: 1<br>P: 9 | R: 0<br>E: 0<br>K: 0<br>S: 3 | H: 0<br>LOB: 0<br>BB: 0<br>P: 3 | R: 0<br>E: 0<br>K: 1<br>S: 5 | H: 0<br>LOB: 0<br>BB: 0<br>P: 5 | 1B: 7<br>2B: 1<br>3B: 0<br>HR: 0 | SF: 0<br>SAC: 0<br>DP: 1<br>HBP: 0 |
|--------------|------------------------------|---------------------------------|------------------------------|---------------------------------|------------------------------|---------------------------------|------------------------------|---------------------------------|------------------------------|---------------------------------|------------------------------|---------------------------------|------------------------------|---------------------------------|------------------------------|---------------------------------|------------------------------|---------------------------------|----------------------------------|------------------------------------|
|--------------|------------------------------|---------------------------------|------------------------------|---------------------------------|------------------------------|---------------------------------|------------------------------|---------------------------------|------------------------------|---------------------------------|------------------------------|---------------------------------|------------------------------|---------------------------------|------------------------------|---------------------------------|------------------------------|---------------------------------|----------------------------------|------------------------------------|

| PITCHER                                     | IP  | WLS | BF | H | R | ER | SO | BB | IBB | HBP | BLK | WP | HR | S  | P  | ERA  | WHIP  |
|---|-----|-----|----|---|---|----|----|----|-----|-----|-----|----|----|----|----|------|-------|
| Ken Raffensberger, L<br>ERA: 3.84<br>(1, 1) | 9.0 | W   | 37 | 8 | 1 | 1  | 5  | 3  | 0   | 0   | 0   | 0  | 0  | 44 | 56 | 1.00 | 1.222 |

**BOTTOM**

**Cincinnati Reds @ Chicago Cubs**  
Wrigley Field, Chicago, IL  
Tue May 30 1950, 3:33 AM CDT  
Unknown

[livebaseballscorecards.com](http://livebaseballscorecards.com)

|            |           |
|------------|-----------|
| <b>AB</b>  | <b>34</b> |
| <b>R</b>   | <b>1</b>  |
| <b>H</b>   | <b>8</b>  |
| <b>RBI</b> | <b>1</b>  |
| <b>BB</b>  | <b>3</b>  |
| <b>SO</b>  | <b>5</b>  |
| <b>LOB</b> | <b>15</b> |



| WP    | PA |
|-------|----|
| 0     | 37 |
| PB: 1 |    |
| SB: 0 |    |
| CS: 0 |    |

| Batter   | 1   | 2                               | 3                            | 4                               | 5                            | 6                                | 7                            | 8                                | 9                            | AB R H RBI BB SO LOB                            | TOP                          |                                 |                              |                                  |                              |                                 |                              |                                  |                                  |                                    |                                  |        |  |  |  |  |  |  |
|--|---|---------------------------------|------------------------------|---------------------------------|------------------------------|----------------------------------|------------------------------|----------------------------------|------------------------------|---|------------------------------|---------------------------------|------------------------------|----------------------------------|------------------------------|---------------------------------|------------------------------|----------------------------------|----------------------------------|------------------------------------|----------------------------------|--------|--|--|--|--|--|--|
| <b>Bobby Adams, R</b> (1, 5)<br>OBP: 0.333, SLG: 0.352   | 0-3<br>K  |                                 | 4-0<br>FC6-4<br>BB           |                                 | 0-0<br>4-3<br>3B             |                                  | 0-0<br>SH3-4                 | 0-0<br>4-3                       |                              | 3 1 1 0 1 1 0                                   |                              |                                 |                              |                                  |                              |                                 |                              |                                  |                                  |                                    |                                  |        |  |  |  |  |  |  |
| <b>Lloyd Merriman, L</b> (1, 8)<br>OBP: 0.394, SLG: 0.431  | 0-0<br>6-3  |                                 | 0-0<br>FC6-4                 |                                 | 0-0<br>4-3                   |                                  | 0-0<br>1B                    | 0-0<br>G4-6-3<br>WP<br>1B        |                              | 5 1 2 2 0 0 2                                   |                              |                                 |                              |                                  |                              |                                 |                              |                                  |                                  |                                    |                                  |        |  |  |  |  |  |  |
| <b>Johnny Wyrostek, L</b> (1, 7)<br>OBP: 0.386, SLG: 0.436   | 0-0<br>5-3  |                                 |                              | 0-0<br>G4-6-3<br>1B             | 0-3<br>K                     |                                  | 0-0<br>F8                    | 4-0<br>G4-6-3<br>BB              |                              | 4 0 1 0 1 1 1                                   |                              |                                 |                              |                                  |                              |                                 |                              |                                  |                                  |                                    |                                  |        |  |  |  |  |  |  |
| <b>Ted Kluszewski, L</b> (1, 3)<br>OBP: 0.298, SLG: 0.505  |   | 0-0<br>6-3                      |                              | 0-0<br>G4-6-3<br>1B             | 0-0<br>FC5-4<br>1B           |                                  | 0-0<br>BB<br>1B              | 0-0<br>G4-6-3                    |                              | 5 0 2 1 0 0 3                                   |                              |                                 |                              |                                  |                              |                                 |                              |                                  |                                  |                                    |                                  |        |  |  |  |  |  |  |
| <b>Ron Northey, L</b> (1, 9)<br>OBP: 0.366, SLG: 0.543<br><b>Peanuts Lowrey, R</b> (9, PR)<br>OBP: 0.362, SLG: 0.309                                     |   | 0-0<br>4-3                      |                              | 4-0<br>2B<br>BB                 | 0-0<br>FC5-4                 |                                  | 4-0<br>BB<br>BB              | 4-0<br>BB                        |                              | 2 1 0 0 3 0 1<br>0 0 0 0 0 0 0                  |                              |                                 |                              |                                  |                              |                                 |                              |                                  |                                  |                                    |                                  |        |  |  |  |  |  |  |
| <b>Connie Ryan, R</b> (1, 4)<br>OBP: 0.349, SLG: 0.356   |   | 0-0<br>5-3                      |                              | 0-0<br>BB<br>2B                 |                              | 0-3<br>K                         | 4-0<br>1-2<br>BB             | 0-0<br>F8                        |                              | 4 0 1 0 1 1 2                                   |                              |                                 |                              |                                  |                              |                                 |                              |                                  |                                  |                                    |                                  |        |  |  |  |  |  |  |
| <b>Sammy Meeks, R</b> (1, 6)<br>OBP: 0.227, SLG: 0.350   |   |                                 | 0-0<br>BB<br>1B              | 4-0<br>BB<br>BB                 |                              | 0-3<br>K                         | 0-3<br>K                     |                                  |                              | 3 0 1 0 1 2 3                                   |                              |                                 |                              |                                  |                              |                                 |                              |                                  |                                  |                                    |                                  |        |  |  |  |  |  |  |
| <b>Dixie Howell, R</b> (1, 2)<br>OBP: 0.373, SLG: 0.262  |   |                                 | 0-3<br>K                     | 4-0<br>FC6-4<br>BB              |                              | 0-0<br>6-3                       |                              | 0-0<br>1-3                       |                              | 3 0 0 1 1 1 1                                   |                              |                                 |                              |                                  |                              |                                 |                              |                                  |                                  |                                    |                                  |        |  |  |  |  |  |  |
| <b>Herm Wehmeier, R</b> (1, 1)<br>OBP: 0.259, SLG: 0.308<br><b>Harry Perkowski, L</b> (8, PH)<br>OBP: 0.500, SLG: 0.500<br><b>Eddie Erault, R</b> (8, 1) |   |                                 | 0-0<br>F9                    | 0-0<br>FC6-4                    |                              |                                  | 0-0<br>SH3-4<br>1B           | 0-0<br>F7                        |                              | 3 1 1 0 0 0 4<br>1 0 0 0 0 0 0<br>0 0 0 0 0 0 0 |                              |                                 |                              |                                  |                              |                                 |                              |                                  |                                  |                                    |                                  |        |  |  |  |  |  |  |
| <b>Inning Stats</b>  | R: 0<br>E: 0<br>K: 1<br>S: 5                          | H: 0<br>LOB: 0<br>BB: 0<br>P: 5 | R: 0<br>E: 0<br>K: 0<br>S: 3 | H: 0<br>LOB: 0<br>BB: 0<br>P: 3 | R: 0<br>E: 0<br>K: 1<br>S: 6 | H: 1<br>LOB: 2<br>BB: 1<br>P: 10 | R: 1<br>E: 0<br>K: 0<br>S: 4 | H: 2<br>LOB: 3<br>BB: 3<br>P: 16 | R: 1<br>E: 0<br>K: 1<br>S: 7 | H: 2<br>LOB: 1<br>BB: 0<br>P: 7                 | R: 0<br>E: 0<br>K: 2<br>S: 7 | H: 0<br>LOB: 0<br>BB: 0<br>P: 7 | R: 2<br>E: 0<br>K: 1<br>S: 8 | H: 3<br>LOB: 3<br>BB: 2<br>P: 16 | R: 0<br>E: 0<br>K: 0<br>S: 3 | H: 0<br>LOB: 0<br>BB: 0<br>P: 3 | R: 0<br>E: 0<br>K: 0<br>S: 3 | H: 1<br>LOB: 2<br>BB: 2<br>P: 11 | 1B: 7<br>2B: 1<br>3B: 1<br>HR: 0 | SF: 0<br>SAC: 1<br>DP: 2<br>HBP: 0 | WP: 1<br>PB: 0<br>SB: 0<br>CS: 0 | PA: 42 |  |  |  |  |  |  |
| <b>PITCHER</b>   | IP WLS BF H R ER SO BB IBB HBP BLK WP HR S P ERA WHIP |                                 |                              |                                 |                              |                                  |                              |                                  |                              |   |                              |                                 |                              |                                  |                              |                                 |                              |                                  |                                  |                                    |                                  |        |  |  |  |  |  |  |
| <b>Bill Voiselle, R</b> (1, 1)<br>ERA: 4.68  | 6.2   | WLS                             | 32                           | 8                               | 4                            | 4                                | 5                            | 5                                | 0                            | 0   | 0                            | 0                               | 0                            | 0                                | 37                           | 57                              | 5.40                         | 1.950                            |                                  |                                    |                                  |        |  |  |  |  |  |  |
| <b>Monk Dubiel, R</b> (7, 1)<br>ERA: 4.29  | 0.1   | W                               | 2                            | 0                               | 0                            | 0                                | 1                            | 1                                | 0                            | 0   | 0                            | 0                               | 0                            | 3                                | 7                            | 0.00                            | 3.000                        |                                  |                                  |                                    |                                  |        |  |  |  |  |  |  |
| <b>Doyle Lade, R</b> (8, 1)<br>ERA: 5.03   | 2.0   | S                               | 8                            | 1                               | 0                            | 0                                | 0                            | 2                                | 0                            | 0   | 0                            | 1                               | 0                            | 6                                | 14                           | 0.00                            | 1.500                        |                                  |                                  |                                    |                                  |        |  |  |  |  |  |  |

Cincinnati Reds @ Chicago Cubs  
 Wrigley Field, Chicago, IL  
 Tue May 30 1950, 3:38 AM CDT  
 Att: 39,090 - Unknown

livebaseballscores.com

|     |    |
|-----|----|
| AB  | 33 |
| R   | 4  |
| H   | 9  |
| RBI | 4  |
| BB  | 8  |
| SO  | 6  |
| LOB | 17 |



| Batter   | 1         | 2       | 3            | 4             | 5             | 6         | 7            | 8         | 9 |
|--|-----------|---------|--------------|---------------|---------------|-----------|--------------|-----------|---|
| Wayne Terwilliger, R (1, 4)<br>OBP: 0.372, SLG: 0.464  | 0-0 F8    |         | 4-0 G3 1B BB |               | 4-0 G3-6-3 BB |           | 4-0 1B 2B BB | 0-3 K     |   |
| Rube Walker, L (1, 2)<br>OBP: 0.192, SLG: 0.235<br>Bob Borkowski, R (7, PR)<br>OBP: 0.440, SLG: 0.550<br>Mickey Owen, R (8, 2)<br>OBP: 0.225, SLG: 0.239 | 0-0 4-3   |         | 0-0 G3       |               | 0-0 G3-6-3    |           | 0-0 2B 1B    |           |   |
| Phil Cavarretta, L (1, 3)<br>OBP: 0.355, SLG: 0.400  | 0-0 2B 1B |         | 0-0 F7       |               |               | 0-3 K     | 0-0 F7       |           |   |
| Hank Sauer, R (1, 7)<br>OBP: 0.419, SLG: 0.564   | 0-0 PO 2B |         | 0-0 FC6-4 1B |               |               | 0-3 K     | 0-0 2B       |           |   |
| Andy Pafko, R (1, 8)<br>OBP: 0.436, SLG: 0.573   | 0-0 PO    | 0-0 F7  | 0-0 FC6-4    |               |               | 0-0 WP 1B | 0-0 P4       |           |   |
| Hank Edwards, L (1, 9)<br>OBP: 0.415, SLG: 0.576   |           | 0-0 HR  |              | 0-0 G4-6-3 1B |               | 0-0 F7    |              | 0-0 F7    |   |
| Bill Serena, R (1, 5)<br>OBP: 0.317, SLG: 0.333<br>Bob Ramazzotti, R (7, PR)<br>OBP: 0.300, SLG: 0.316   |           | 0-0 6-3 |              | 0-0 G4-6-3    |               |           | 4-0 BB 1B BB | 0-0 1-3   |   |
| Roy Smalley, R (1, 6)<br>OBP: 0.296, SLG: 0.403  |           | 4-0 BB  |              | 0-3 K         |               |           | 0-0 F9       | 4-0 1B BB |   |
| Bill Voiselle, R (1, 1)<br>OBP: 0.125, SLG: 0.125<br>Monk Dubiel, R (7, 1)   |           | 0-0 G3  |              |               | 0-3 K         |           | 0-0 1B       | 0-0 1B    |   |
| Bob Scheffing, R (7, PH)<br>OBP: 0.200, SLG: 0.300<br>Emil Verban, R (7, PR)   |           |         |              |               |               |           |              |           |   |
| Doyle Lade, R (8, 1)<br>OBP: 0.667, SLG: 0.667   |           |         |              |               |               |           | 1-2 1B       | 1-2 1B    |   |

| Inning Stats | R: 1  | H: 2  | E: 0  | K: 0  | S: 4   | LOB: 0 | BB: 0  | P: 4  | R: 1   | H: 1 | E: 0 | K: 0 | S: 4 | LOB: 1 | BB: 1 | P: 8 | R: 1 | H: 1 | E: 0 | K: 0 | S: 4 | LOB: 1 | BB: 1 | P: 8 | R: 0 | H: 1 | E: 0 | K: 1 | S: 5 | LOB: 0 | BB: 0 | P: 5 | R: 0 | H: 0 | E: 0 | K: 1 | S: 4 | LOB: 0 | BB: 1 | P: 8 | R: 0 | H: 1 | E: 0 | K: 2 | S: 8 | LOB: 1 | BB: 0 | P: 8 | R: 4 | H: 3 | E: 0 | K: 0 | S: 6 | LOB: 2 | BB: 2 | P: 14 | R: 0 | H: 1 | E: 0 | K: 1 | S: 6 | LOB: 2 | BB: 1 | P: 10 |
|--------------|-------|-------|-------|-------|--------|--------|--------|-------|--------|------|------|------|------|--------|-------|------|------|------|------|------|------|--------|-------|------|------|------|------|------|------|--------|-------|------|------|------|------|------|------|--------|-------|------|------|------|------|------|------|--------|-------|------|------|------|------|------|------|--------|-------|-------|------|------|------|------|------|--------|-------|-------|
| 1B: 7        | 2B: 2 | 3B: 0 | HR: 1 | SF: 0 | SAC: 0 | DP: 2  | HBP: 0 | WP: 1 | PA: 38 |      |      |      |      |        |       |      |      |      |      |      |      |        |       |      |      |      |      |      |      |        |       |      |      |      |      |      |      |        |       |      |      |      |      |      |      |        |       |      |      |      |      |      |      |        |       |       |      |      |      |      |      |        |       |       |

| PITCHER                              | IP  | WLS | BF | H | R | ER | SO | BB | IBB | HBP | BLK | WP | HR | S  | P  | ERA  | WHIP  |
|--------------------------------------|-----|-----|----|---|---|----|----|----|-----|-----|-----|----|----|----|----|------|-------|
| Herm Wehmeier, R (1, 1)<br>ERA: 6.71 | 7.0 | L   | 32 | 9 | 7 | 7  | 4  | 5  | 0   | 0   | 0   | 1  | 1  | 35 | 55 | 9.00 | 2.000 |
| Eddie Erault, R (8, 1)<br>ERA: 8.57  | 1.0 |     | 5  | 1 | 0 | 0  | 1  | 1  | 0   | 0   | 0   | 0  | 0  | 6  | 10 | 0.00 | 2.000 |

**BOTTOM**

**Cincinnati Reds @ Chicago Cubs**  
Wrigley Field, Chicago, IL  
Tue May 30 1950, 3:38 AM CDT  
Att. 39,090 - Unknown

|     |    |
|-----|----|
| AB  | 31 |
| R   | 7  |
| H   | 10 |
| RBI | 7  |
| BB  | 6  |
| SO  | 5  |
| LOB | 14 |



**New York Giants @ Cincinnati Reds**  
 Crosley Field, Cincinnati, OH  
 Thu Jun 01 1950, 3:33 AM EDT  
 Sunny - 80 F

livebaseballscorecards.com

|            |           |
|------------|-----------|
| <b>AB</b>  | <b>34</b> |
| <b>R</b>   | <b>8</b>  |
| <b>H</b>   | <b>9</b>  |
| <b>RBI</b> | <b>8</b>  |
| <b>BB</b>  | <b>8</b>  |
| <b>SO</b>  | <b>1</b>  |
| <b>LOB</b> | <b>18</b> |



| Batter  | 1                  | 2               | 3                           | 4          | 5 | 6                  | 7                   | 8         | 9                      | AB R H RBI BB SO LOB   |
|---|--------------------|-----------------|-----------------------------|------------|---|--------------------|---------------------|-----------|------------------------|--|
| <b>Eddie Stanky, R</b><br>OBP: 0.474, SLG: 0.417<br>(1, 4) X  | 0-0<br>L5-4<br>1B  |                 | 4-0<br>BB<br>HR<br>1B<br>BB | 0-0<br>4-3 |   |                    | 0-0<br>SH2-4<br>1-2 |           | 4-0<br>1B<br>2B<br>BB  | 2 2 1 0 2 0 1  |
| <b>Whitey Lockman, L</b><br>OBP: 0.333, SLG: 0.366<br>(1, 8) X<br>(9, 7)  | 0-0<br>F7          |                 | 0-0<br>BB<br>HR<br>1B       |            |   | 0-0<br>3-1         | 0-0<br>F7           |           | 0-0<br>2B<br>1B        | 5 2 2 1 0 0 2  |
| <b>Don Mueller, L</b><br>OBP: 0.337, SLG: 0.417<br>(1, 9) X   | 0-0<br>1-2<br>1B   |                 | 0-0<br>F7                   |            |   | 0-0<br>F7          | 0-0<br>5-3          |           | 0-0<br>BB<br>2B        | 5 1 2 2 0 0 3  |
| <b>Roy Weatherly, L</b><br>OBP: 0.579, SLG: 0.643<br>(1, 7) X<br><b>Monte Irvin, R</b><br>OBP: 0.375, SLG: 0.410<br>(9, PH)<br><b>Kirby Higbe, R</b><br>OBP: 0.333, SLG: 0.333<br>(9, 1)<br><b>Larry Jansen, R</b><br>OBP: 0.143, SLG: 0.150<br>(9, 1)                              | 0-0<br>L5-4<br>2-3 |                 | 4-0<br>HR<br>BB             |            |   | 0-0<br>L7          |                     | 0-0<br>F8 | 4-0<br>BB<br>BB<br>IBB | 3 1 0 0 1 0 2<br>0 0 0 0 1 0 0<br>0 0 0 0 0 0 0<br>0 0 0 0 0 0 0   |
| <b>Hank Thompson, L</b><br>OBP: 0.432, SLG: 0.529<br>(1, 5) X   |                    | 0-0<br>G3<br>1B | 0-0<br>HR                   |            |   | 0-0<br>6-3         |                     | 0-0<br>F9 | 4-0<br>BB<br>BB        | 4 1 2 4 1 0 0  |
| <b>Wes Westrum, R</b><br>OBP: 0.382, SLG: 0.348<br>(1, 2) X   |                    | 0-0<br>F3       | 0-0<br>F6                   |            |   | 0-0<br>F8          |                     | 0-0<br>F5 | 4-0<br>BB              | 4 0 0 1 1 0 1  |
| <b>Tookie Gilbert, L</b><br>OBP: 0.311, SLG: 0.344<br>(1, 3) X  |                    | 0-0<br>G3       |                             | 0-0<br>G3  |   | 4-0<br>BB          |                     |           | 0-0<br>G3<br>2B        | 4 1 1 0 1 0 4  |
| <b>Alvin Dark, R</b><br>OBP: 0.286, SLG: 0.341<br>(1, 6) X  |                    | 0-0<br>G3       |                             | 0-0<br>1B  |   | 0-0<br>L6          |                     |           | 0-0<br>G3              | 4 0 1 0 0 0 3  |
| <b>Dave Koslo, L</b><br>(1, 1)<br><b>Andy Hansen, R</b><br>(6, 1)<br><b>Spider Jorgensen, L</b><br>(7, PH)<br><b>Jack Kramer, R</b><br>OBP: 0.590, SLG: 2.000<br>(7, 1)<br><b>Sal Maglie, R</b><br>(8, 1)<br><b>Bobby Thomson, R</b><br>OBP: 0.340, SLG: 0.421<br>(9, PH)<br>(9, 8) |                    |                 | 0-0<br>F4                   | 0-3<br>K   |   | 4-0<br>SH2-4<br>BB |                     |           | 0-0<br>1-3             | 2 0 0 0 0 0 1 1<br>0 0 0 0 0 0 0 0<br>0 0 0 0 0 1 0 0<br>0 0 0 0 0 0 0 0<br>0 0 0 0 0 0 0 0<br>1 0 0 0 0 0 0 1 |

| Inning Stats | R: 0<br>E: 0<br>K: 0<br>S: 4 | H: 2<br>LOB: 1<br>BB: 0<br>P: 4 | R: 0<br>E: 0<br>K: 0<br>S: 4 | H: 1<br>LOB: 1<br>BB: 0<br>P: 4 | R: 4<br>E: 0<br>K: 0<br>S: 5 | H: 2<br>LOB: 0<br>BB: 2<br>P: 13 | R: 0<br>E: 0<br>K: 1<br>S: 6 | H: 1<br>LOB: 1<br>BB: 0<br>P: 6 | R: 0<br>E: 0<br>K: 0<br>S: 3 | H: 0<br>LOB: 0<br>BB: 0<br>P: 3 | R: 0<br>E: 0<br>K: 0<br>S: 3 | H: 0<br>LOB: 1<br>BB: 1<br>P: 7 | R: 0<br>E: 0<br>K: 0<br>S: 3 | H: 0<br>LOB: 1<br>BB: 1<br>P: 7 | R: 0<br>E: 0<br>K: 0<br>S: 3 | H: 0<br>LOB: 0<br>BB: 0<br>P: 3 | R: 4<br>E: 0<br>K: 0<br>S: 6 | H: 3<br>LOB: 3<br>BB: 4<br>P: 22 | 1B: 6<br>2B: 3<br>3B: 0<br>HR: 1 | SF: 0<br>SAC: 1<br>DP: 1<br>HBP: 0 | WP: 0<br>PB: 0<br>SB: 0<br>CS: 0 | PA: 43 |
|--------------|------------------------------|---------------------------------|------------------------------|---------------------------------|------------------------------|----------------------------------|------------------------------|---------------------------------|------------------------------|---------------------------------|------------------------------|---------------------------------|------------------------------|---------------------------------|------------------------------|---------------------------------|------------------------------|----------------------------------|----------------------------------|------------------------------------|----------------------------------|--------|
|--------------|------------------------------|---------------------------------|------------------------------|---------------------------------|------------------------------|----------------------------------|------------------------------|---------------------------------|------------------------------|---------------------------------|------------------------------|---------------------------------|------------------------------|---------------------------------|------------------------------|---------------------------------|------------------------------|----------------------------------|----------------------------------|------------------------------------|----------------------------------|--------|

| PITCHER   | IP  | WLS | BF | H | R | ER | SO | BB | IBB | HBP | BLK | WP | HR | S  | P  | ERA  | WHIP  |
|---|-----|-----|----|---|---|----|----|----|-----|-----|-----|----|----|----|----|------|-------|
| <b>Howie Fox, R</b><br>ERA: 6.08<br>(1, 1)      | 8.2 | L   | 39 | 9 | 8 | 8  | 1  | 5  | 0   | 0   | 0   | 0  | 1  | 36 | 56 | 8.31 | 1.615 |
| <b>Harry Perkowski, L</b><br>ERA: 4.5<br>(9, 1) | 0.0 |     | 2  | 0 | 0 | 0  | 0  | 1  | 1   | 0   | 0   | 0  | 0  | 0  | 8  | ∞    | ∞     |
| <b>Eddie Erault, R</b><br>ERA: 8.44<br>(9, 1)   | 0.1 |     | 2  | 0 | 0 | 0  | 0  | 1  | 0   | 0   | 0   | 0  | 0  | 1  | 5  | 0.00 | 3.000 |

BOTTOM

New York Giants @ Cincinnati Reds  
Crosley Field, Cincinnati, OH  
Thu Jun 01 1950, 3:33 AM EDT  
Sunny - 80 F

livebaseballscores.com

AB 40  
R 7  
H 14  
RBI 6  
BB 5  
SO 0  
LOB 26



WP: 0 PA: 46  
PB: 0  
SB: 0  
CS: 0

AB R H RBI BB SO LOB

5 2 2 0 1 0 4

4 1 2 1 1 0 1

3 0 0 0 0 0 3

1 0 0 0 0 0 3

0 0 0 0 0 0 0

3 0 1 2 2 0 1

2 0 2 1 0 0 0

3 1 1 0 0 0 5

5 0 1 0 0 0 6

0 0 0 0 0 0 0

5 0 0 0 0 0 2

5 2 2 0 0 0 1

4 1 3 2 0 0 0

0 0 0 0 0 0 0

0 0 0 0 0 0 0

0 0 0 0 1 0 0

1B: 11 SF: 0  
2B: 3 SAC: 1  
3B: 0 DP: 1  
HR: 0 HBP: 0

| Batter  | 1                                  | 2          | 3                          | 4                    | 5          | 6                       | 7                    | 8  | 9                          | AB R H RBI BB SO LOB   |
|---|------------------------------------|------------|----------------------------|----------------------|------------|-------------------------|----------------------|--|----------------------------|--|
| <b>Peanuts Lowrey, R</b><br>OBP: 0.370, SLG: 0.326<br>(1, 7)<br>X   | 0-0<br>1B<br>G6-4-3<br>2B          |            | 0-0<br>F9<br>E<br>F8<br>1B | 0-0<br>FC6-4<br>1-2f |            | 0-0<br>4-3              |                      | 4-0<br>BB<br>BB<br>1-2<br>2-3<br>BB              | 0-0<br>FC6-4<br>1-2f       | 5 2 2 0 1 0 4  |
| <b>Johnny Wyrostek, L</b><br>OBP: 0.394, SLG: 0.438<br>(1, 9)<br>(9, 8)<br>X  | 0-0<br>2-3<br>1B                   |            | 0-0<br>E4<br>1-2<br>2B     |                      | 0-0<br>F5  |                         | 0-0<br>SH5-3<br>1B   | 4-0<br>BB<br>BB<br>1-2<br>2-3<br>3-H<br>BB<br>BB |                            | 4 1 2 1 1 0 1  |
| <b>Bob Usher, R</b><br>OBP: 0.275, SLG: 0.446<br>(1, 8)<br><b>Lloyd Merriman, L</b><br>OBP: 0.388, SLG: 0.424<br>(8, PH)<br>(9, 8)<br><b>Ron Northey, L</b><br>OBP: 0.366, SLG: 0.543<br>(9, 9)<br>X                                | 0-0<br>G6-4-3<br>1-2f<br>3-H<br>1B |            | 0-0<br>F9<br>2-3           |                      | 0-0<br>6-3 |                         | 0-0<br>SH5-3<br>1-2  | 0-0<br>F8  |                            | 3 0 0 0 0 0 3<br>1 0 0 0 0 0 3<br>0 0 0 0 0 0 0                  |
| <b>Ted Kluszewski, L</b><br>OBP: 0.313, SLG: 0.500<br>(1, 3)<br>X   | 0-0<br>1B<br>1B                    |            | 0-0<br>F8<br>3-H           |                      | 0-0<br>4-3 |                         | 4-0<br>FC6-4<br>IBB  | 4-0<br>BB<br>BB<br>1-2<br>2-3<br>3-H<br>BB       |                            | 3 0 1 2 2 0 1  |
| <b>Connie Ryan, R</b><br>OBP: 0.359, SLG: 0.377<br>(1, 4)<br><b>Bobby Adams, R</b><br>OBP: 0.333, SLG: 0.351<br>(4, 4)<br>X   | 0-0<br>1-2<br>1B                   |            | 0-0<br>1-H<br>2B           |                      |            | 0-0<br>1B<br>2B<br>1B   | 0-0<br>F8            | 0-0<br>F5  |                            | 2 0 2 1 0 0 0<br>3 1 1 0 0 0 5                                   |
| <b>Johnny Pramesa, R</b><br>OBP: 0.333, SLG: 0.432<br>(1, 2)<br><b>Herm Wehmeier, R</b><br>OBP: 0.259, SLG: 0.308<br>(9, PR)<br>X   | 0-0<br>F9                          |            | 0-0<br>F2                  |                      |            | 0-0<br>F9               | 0-0<br>FC6-4<br>1-2f |  | 0-0<br>FC1-6<br>1B         | 5 0 1 0 0 0 6<br>0 0 0 0 0 0 0                                   |
| <b>Grady Hatton, L</b><br>OBP: 0.309, SLG: 0.371<br>(1, 5)<br>X   |                                    | 0-0<br>F2  |                            | 0-0<br>F8            |            | 0-0<br>B5               |                      | 0-0<br>F7  | 0-0<br>FC1-6<br>BB<br>1-2f | 5 0 0 0 0 0 2  |
| <b>Virgil Stallcup, R</b><br>OBP: 0.281, SLG: 0.407<br>(1, 6)<br>X  |                                    | 0-0<br>F8  |                            | 0-0<br>F8            |            | 0-0<br>2B<br>1B         |                      | 0-0<br>BB<br>1B<br>1B                            | 0-0<br>F8                  | 5 2 2 0 0 0 1  |
| <b>Howie Fox, R</b><br>OBP: 0.308, SLG: 0.385<br>(1, 1)<br><b>Harry Perkowski, L</b><br>OBP: 0.500, SLG: 0.500<br>(9, 1)<br><b>Eddie Erautt, R</b><br>(9, 1)<br><b>Danny Litwhiler, R</b><br>OBP: 0.357, SLG: 0.382<br>(9, PH)<br>X |                                    | 0-0<br>1-3 |                            | 0-0<br>FC6-4<br>1B   |            | 0-0<br>1-H<br>2-H<br>2B |                      | 0-0<br>BB<br>BB<br>1-2<br>BB<br>1B               | 4-0<br>FC6-4<br>BB         | 4 1 3 2 0 0 0<br>0 0 0 0 0 0 0<br>0 0 0 0 0 0 0<br>0 0 0 0 1 0 0 |

| Inning Stats | R: 1 | H: 4 | E: 0 | LOB: 2 | K: 0 | P: 6 | R: 0 | H: 0 | E: 0 | LOB: 0 | K: 0 | P: 3 | R: 0 | H: 2 | E: 1 | LOB: 1 | K: 0 | P: 6 | R: 0 | H: 1 | E: 0 | LOB: 1 | K: 0 | P: 4 | R: 0 | H: 0 | E: 0 | LOB: 0 | K: 0 | P: 3 | R: 2 | H: 3 | E: 0 | LOB: 1 | K: 0 | P: 6 | R: 0 | H: 1 | E: 0 | LOB: 2 | K: 0 | P: 8 | R: 2 | H: 2 | E: 0 | LOB: 3 | K: 0 | P: 17 | R: 0 | H: 1 | E: 0 | LOB: 2 | K: 0 | P: 8 | 1B: 11 | SF: 0 | 2B: 3 | SAC: 1 | 3B: 0 | DP: 1 | HR: 0 | HBP: 0 | WP: 0 | PA: 46 |
|--------------|------|------|------|--------|------|------|------|------|------|--------|------|------|------|------|------|--------|------|------|------|------|------|--------|------|------|------|------|------|--------|------|------|------|------|------|--------|------|------|------|------|------|--------|------|------|------|------|------|--------|------|-------|------|------|------|--------|------|------|--------|-------|-------|--------|-------|-------|-------|--------|-------|--------|
|--------------|------|------|------|--------|------|------|------|------|------|--------|------|------|------|------|------|--------|------|------|------|------|------|--------|------|------|------|------|------|--------|------|------|------|------|------|--------|------|------|------|------|------|--------|------|------|------|------|------|--------|------|-------|------|------|------|--------|------|------|--------|-------|-------|--------|-------|-------|-------|--------|-------|--------|

| PITCHER                                      | IP  | WLS | BF | H  | R | ER | SO | BB | IBB | HBP | BLK | WP | HR | S  | P  | ERA   | WHIP  |
|--|-----|-----|----|----|---|----|----|----|-----|-----|-----|----|----|----|----|-------|-------|
| <b>Dave Koslo, L</b><br>ERA: 3.5<br>(1, 1)   | 5.2 |     | 27 | 10 | 5 | 3  | 0  | 0  | 0   | 0   | 0   | 0  | 0  | 27 | 27 | 4.76  | 1.765 |
| <b>Andy Hansen, R</b><br>ERA: 3.32<br>(6, 1) | 0.1 |     | 1  | 0  | 0 | 0  | 0  | 0  | 0   | 0   | 0   | 0  | 0  | 1  | 1  | 0.00  | 0.000 |
| <b>Jack Kramer, R</b><br>ERA: 3.8<br>(7, 1)  | 1.2 |     | 12 | 3  | 2 | 2  | 0  | 3  | 1   | 0   | 0   | 0  | 0  | 8  | 24 | 10.80 | 3.600 |
| <b>Sal Maglie, R</b><br>ERA: 5.12<br>(8, 1)  | 0.1 | W   | 1  | 0  | 0 | 0  | 0  | 0  | 0   | 0   | 0   | 0  | 0  | 1  | 1  | 0.00  | 0.000 |
| <b>Kirby Higbe, R</b><br>ERA: 3.86<br>(9, 1) | 0.2 |     | 4  | 1  | 0 | 0  | 0  | 1  | 0   | 0   | 0   | 0  | 0  | 3  | 7  | 0.00  | 3.000 |

| Batter   | 1   | 2   | 3   | 4   | 5   | 6   | 7   | 8   | 9   | AB R H RBI BB SO LOB   | TOP                                     |  |
|--|---|---|---|---|---|---|---|---|---|--|---|--|
| Eddie Stanky, R (1, 4)<br>OBP: 0.475, SLG: 0.415   | 4-0<br>3B BB  |   | 0-0<br>6-3  |   | 0-3<br>K  |   |   | 0-0<br>1B 1B  |   | 3 1 1 0 1 1 0  |   |  |
| Whitey Lockman, L (1, 8)<br>OBP: 0.331, SLG: 0.363   | 0-0<br>F8   |   | 0-0<br>3-1  |   |   | 0-0<br>4-3  |   | 0-0<br>1-2 1B                                       |   | 4 0 1 0 0 0 1  |   |  |
| Don Mueller, L (1, 9)<br>OBP: 0.343, SLG: 0.450  | 0-0<br>1-H FC5-2-5 3B                                 |   |   | 0-0<br>1B 2B  |   | 0-0<br>4-3  |   | 0-0<br>F8   |   | 4 1 2 1 0 0 2  |   |  |
| Roy Weatherly, L (1, 7)<br>OBP: 0.522, SLG: 0.556  | 0-0<br>FC5-2-5 PO                                     |   |   | 0-0<br>FC3 1B                                       |   | 0-0<br>L6   |   | 0-0<br>F6   |   | 4 0 1 1 0 0 3  |   |  |
| Hank Thompson, L (1, 5)<br>OBP: 0.435, SLG: 0.527  | 0-0<br>PO 1-2   | 0-0<br>4-3  |   | 0-0<br>L6   |   |   | 0-0<br>1B   |   | 0-0<br>1B 1B  | 4 0 2 0 0 0 1  |   |  |
| Wes Westrum, R (1, 2)<br>OBP: 0.386, SLG: 0.355  |   | 0-0<br>1B   |   | 0-0<br>FC3 G3-6-3 1-2                               |   |   | 0-0<br>F4   |   | 0-0<br>1-2 G5-4-3 1B                                | 4 0 2 0 0 0 2  |   |  |
| Tookie Gilbert, L (1, 3)<br>OBP: 0.300, SLG: 0.330   |   | 0-0<br>F8   |   | 0-0<br>G3-6-3 1-2f                                  |   | 0-3<br>K  |   | 0-0<br>F9   |   | 4 0 0 0 0 1 6  |   |  |
| Alvin Dark, R (1, 6)<br>OBP: 0.278, SLG: 0.331   |   | 0-0<br>F7   |   |   | 0-0<br>F9   |   | 0-0<br>1-3  |   | 0-0<br>1-2f G5-4-3                                  | 4 0 0 0 0 0 4  |   |  |
| Sheldon Jones, R (1, 1)<br>Kirby Higbe, R (1, 1)<br>Jack Lohrke, R (5, PH)<br>Andy Hansen, R (5, 1)<br>Spider Jorgensen, L (8, PH)<br>Sal Maglie, R (8, 1) |   |   | 0-0<br>3-1  |   | 0-0<br>F8   |   |   | 0-0<br>F5   |   | 0 0 0 0 0 0 0<br>1 0 0 0 0 0 0<br>1 0 0 0 0 0 0<br>0 0 0 0 0 0 0<br>1 0 0 0 0 0 0<br>0 0 0 0 0 0 0 |   |  |
| <b>Inning Stats</b>  | R: 1 H: 1<br>E: 0 LOB: 0<br>K: 0 BB: 1<br>S: 3 P: 7   | R: 0 H: 1<br>E: 0 LOB: 1<br>K: 0 BB: 0<br>S: 4 P: 4 | R: 0 H: 0<br>E: 0 LOB: 0<br>K: 0 BB: 0<br>S: 3 P: 3 | R: 1 H: 2<br>E: 0 LOB: 1<br>K: 0 BB: 0<br>S: 5 P: 5 | R: 0 H: 0<br>E: 0 LOB: 0<br>K: 1 BB: 0<br>S: 5 P: 5 | R: 0 H: 0<br>E: 0 LOB: 0<br>K: 0 BB: 0<br>S: 3 P: 3 | R: 0 H: 1<br>E: 0 LOB: 1<br>K: 1 BB: 0<br>S: 6 P: 6 | R: 0 H: 2<br>E: 0 LOB: 2<br>K: 0 BB: 0<br>S: 5 P: 5 | R: 0 H: 2<br>E: 0 LOB: 1<br>K: 0 BB: 0<br>S: 4 P: 4 | 1B: 7 SF: 0<br>2B: 1 SAC: 0<br>3B: 1 DP: 2<br>HR: 0 HBP: 0   | WP: 0 PA: 36<br>PB: 0<br>SB: 0<br>CS: 0 |  |
| <b>PITCHER</b><br>Ewell Blackwell, R (1, 1)<br>ERA: 2.91   | IP WLS BF H R ER SO BB IBB HBP BLK WP HR S P ERA WHIP | 9.0 W 35 9 2 2 2 1 0 0 0 0 0 0 38 42 2.00 1.111     |   |   |   |   |   |   |   |  |   |  |

**New York Giants @ Cincinnati Reds**  
 Crosley Field, Cincinnati, OH  
 Thu Jun 01 1950, 3:38 AM EDT  
 Att. 7,727 - Unknown

[livebaseballscorecards.com](http://livebaseballscorecards.com)

|     |    |
|-----|----|
| AB  | 34 |
| R   | 2  |
| H   | 9  |
| RBI | 2  |
| BB  | 1  |
| SO  | 2  |
| LOB | 19 |



BOTTOM

New York Giants @ Cincinnati Reds  
Crosley Field, Cincinnati, OH  
Thu Jun 01 1950, 3:38 AM EDT  
Att. 7,727 - Unknown

livebaseballscorecards.com

AB 34  
R 5  
H 11  
RBI 5  
BB 9  
SO 4  
LOB 21



WP: 1 PA: 43  
PB: 0  
SB: 1  
CS: 0

AB R H RBI BB SO LOB

4 1 1 0 1 1 1

4 1 1 0 1 0 2

4 0 1 1 1 0 1

5 1 3 1 0 0 2

3 1 1 0 2 1 3  
0 0 0 0 0 0 0

2 0 1 3 3 0 1

4 0 1 0 1 1 7

4 0 1 0 0 1 2

4 1 1 0 0 0 2

1B: 9 SF: 0  
2B: 2 SAC: 0  
3B: 0 DP: 0  
HR: 0 HBP: 0

| Batter  | 1                          | 2                    | 3                         | 4                              | 5          | 6                | 7                    | 8                    | 9 |
|---|----------------------------|----------------------|---------------------------|--------------------------------|------------|------------------|----------------------|----------------------|---|
| Bobby Adams, R<br>OBP: 0.336, SLG: 0.347<br>(1, 4)  | 0-3<br>K                   | 0-0<br>F7            |                           | 0-0<br>WP 1B<br>2B 1B          | 0-0<br>4-3 |                  | 4-0<br>FC5-4<br>BB   |                      |   |
| Peanuts Lowrey, R<br>OBP: 0.371, SLG: 0.322<br>(1, 7)   | 0-0<br>BB<br>1B            | 4-0<br>1B<br>BB      |                           | 0-0<br>F9                      | 0-0<br>4-3 |                  | 0-0<br>FC5-4<br>1-2f |                      |   |
| Johnny Wyrostek, L<br>OBP: 0.394, SLG: 0.432<br>(1, 8)<br>(9, 9)  | 4-0<br>BB 1B<br>1-2 BB     | 0-0<br>1-2<br>2-H 1B |                           | 0-0<br>F7                      |            | 0-0<br>G3        |                      | 0-0<br>4-3           |   |
| Ted Kluszewski, L<br>OBP: 0.327, SLG: 0.505<br>(1, 3)   | 0-0<br>BB<br>1B<br>1-2 2-H | 0-0<br>L4            |                           | 0-0<br>WP<br>2B 1B             |            | 0-0<br>BB<br>1B  |                      | 0-0<br>4-3           |   |
| Ron Northey, L<br>OBP: 0.379, SLG: 0.534<br>Bob Usher, R<br>OBP: 0.275, SLG: 0.446<br>(8, PR)<br>(9, 8) | 0-3<br>K                   |                      | 4-0<br>2B<br>FC5-2<br>BB  | 4-0<br>2B<br>IBB               |            | 0-0<br>F9        |                      | 0-0<br>S<br>1B       |   |
| Grady Hatton, L<br>OBP: 0.326, SLG: 0.381<br>(1, 5)   | 4-0<br>1-2 2-3<br>BB       |                      | 0-0<br>F8                 | 0-0<br>1B<br>2B<br>1-H 2-H 3-H |            | 4-0<br>1-2<br>BB |                      | 4-0<br>FC5-4<br>IBB  |   |
| Virgil Stallcup, R<br>OBP: 0.286, SLG: 0.410<br>(1, 6)  | 0-0<br>F7                  |                      | 0-0<br>FC5-2<br>1-3<br>2B | 4-0<br>1B<br>BB                |            | 0-3<br>K         |                      | 0-0<br>FC5-4<br>1-2f |   |
| Dixie Howell, R<br>OBP: 0.364, SLG: 0.261<br>(1, 2)   |                            | 0-0<br>1-3           | 0-0<br>FC5-2<br>2-3 3-H   | 0-0<br>1-2 2-H<br>1B           |            |                  | 0-3<br>K             |                      |   |
| Ewell Blackwell, R<br>OBP: 0.211, SLG: 0.118<br>(1, 1)  |                            | 0-0<br>BB<br>1B      | 0-0<br>5-3                |                                | 0-0<br>1-3 |                  | 0-0<br>1-3           |                      |   |

| Inning Stats | R: 1 | H: 2 | E: 0 | K: 2 | S: 9 | LOB: 3 | BB: 2 | P: 17 |
|--------------|------|------|------|------|------|--------|-------|-------|
|              | R: 1 | H: 2 | E: 0 | K: 0 | S: 5 | LOB: 2 | BB: 1 | P: 9  |
|              | R: 0 | H: 1 | E: 0 | K: 0 | S: 4 | LOB: 2 | BB: 1 | P: 8  |
|              | R: 3 | H: 4 | E: 0 | K: 0 | S: 6 | LOB: 2 | BB: 2 | P: 14 |
|              | R: 0 | H: 0 | E: 0 | K: 0 | S: 3 | LOB: 0 | BB: 0 | P: 3  |
|              | R: 0 | H: 1 | E: 0 | K: 1 | S: 6 | LOB: 2 | BB: 1 | P: 10 |
|              | R: 0 | H: 0 | E: 0 | K: 1 | S: 5 | LOB: 1 | BB: 1 | P: 9  |
|              | R: 0 | H: 1 | E: 0 | K: 0 | S: 4 | LOB: 2 | BB: 1 | P: 8  |

| PITCHER                                 | IP  | WLS | BF | H | R | ER | SO | BB | IBB | HBP | BLK | WP | HR | S  | P  | ERA   | WHIP  |
|---|-----|-----|----|---|---|----|----|----|-----|-----|-----|----|----|----|----|-------|-------|
| Sheldon Jones, R<br>ERA: 6.23<br>(1, 1) | 0.1 |     | 4  | 2 | 1 | 1  | 1  | 1  | 1   | 0   | 0   | 0  | 0  | 5  | 9  | 27.00 | 9.000 |
| Kirby Higbe, R<br>ERA: 4.95<br>(1, 1)   | 3.2 | L   | 22 | 7 | 4 | 4  | 1  | 4  | 1   | 0   | 0   | 1  | 0  | 19 | 39 | 9.82  | 3.000 |
| Andy Hansen, R<br>ERA: 2.92<br>(5, 1)   | 3.0 |     | 12 | 1 | 0 | 0  | 2  | 2  | 0   | 0   | 0   | 0  | 0  | 14 | 22 | 0.00  | 1.000 |
| Sal Maglie, R<br>ERA: 4.87<br>(8, 1)    | 1.0 |     | 5  | 1 | 0 | 0  | 0  | 0  | 1   | 0   | 0   | 0  | 0  | 4  | 8  | 0.00  | 1.000 |

1B: 9 SF: 0

2B: 2 SAC: 0

3B: 0 DP: 0

HR: 0 HBP: 0

WP: 1 PA: 43

PB: 0

SB: 1

CS: 0

ERA WHIP

| Batter  | 1   | 2                               | 3                            | 4                               | 5                            | 6                                | 7                            | 8                                | 9                              | AB R H RBI BB SO LOB            | TOP                          |                                 |                              |                                 |                              |                                 |                              |                                  |                                  |                                    |                                  |        |
|---|---|---------------------------------|------------------------------|---------------------------------|------------------------------|----------------------------------|------------------------------|----------------------------------|--------------------------------|---------------------------------|------------------------------|---------------------------------|------------------------------|---------------------------------|------------------------------|---------------------------------|------------------------------|----------------------------------|----------------------------------|------------------------------------|----------------------------------|--------|
| <b>Eddie Stanky, R</b> (1, 4)<br>OBP: 0.472, SLG: 0.418   | 0-0<br>2B   |                                 | 0-3<br>K                     | 4-0<br>1B<br>BB                 |                              | 0-0<br>4-3                       |                              |                                  | 0-0<br>E4<br>1B<br>G6-4-3      | 4 1 1 0 1 1 0                   |                              |                                 |                              |                                 |                              |                                 |                              |                                  |                                  |                                    |                                  |        |
| <b>Whitey Lockman, L</b> (1, 7)<br>OBP: 0.340, SLG: 0.367 | 0-0<br>F6   |                                 | 4-0<br>S<br>BB               | 0-0<br>1B                       |                              |                                  | 0-0<br>F7                    |                                  | 0-0<br>G6-4-3<br>1B            | 4 0 2 1 1 0 1                   |                              |                                 |                              |                                 |                              |                                 |                              |                                  |                                  |                                    |                                  |        |
| <b>Don Mueller, L</b> (1, 9)<br>OBP: 0.327, SLG: 0.429    | 0-3<br>K  |                                 | 0-3<br>K                     | 0-0<br>F9                       |                              |                                  | 0-0<br>E3<br>FC3-6           |                                  | 0-0<br>G6-4-3<br>1-2f<br>3-H   | 5 0 0 1 0 2 5                   |                              |                                 |                              |                                 |                              |                                 |                              |                                  |                                  |                                    |                                  |        |
| <b>Hank Thompson, L</b> (1, 5)<br>OBP: 0.433, SLG: 0.526  | 0-0<br>4-3  |                                 |                              |                                 |                              |                                  | 0-0<br>FC3-6<br>1-2f         |                                  | 4-0<br>E<br>S<br>BB            | 4 2 1 0 1 0 4                   |                              |                                 |                              |                                 |                              |                                 |                              |                                  |                                  |                                    |                                  |        |
| <b>Bobby Thomson, R</b> (1, 8)<br>OBP: 0.336, SLG: 0.408  |   | 0-0<br>L4                       |                              | 0-0<br>1-3                      | 0-0<br>F7                    |                                  | 0-3<br>K                     |                                  | 4-0<br>BB<br>S<br>BB           | 4 0 0 0 1 1 2                   |                              |                                 |                              |                                 |                              |                                 |                              |                                  |                                  |                                    |                                  |        |
| <b>Wes Westrum, R</b> (1, 2)<br>OBP: 0.387, SLG: 0.344    |   | 0-0<br>F4                       |                              | 4-0<br>E<br>1B<br>BB            | 0-0<br>F6                    |                                  |                              | 0-3<br>K                         | 4-0<br>BB<br>BB                | 3 1 0 0 2 1 0                   |                              |                                 |                              |                                 |                              |                                 |                              |                                  |                                  |                                    |                                  |        |
| <b>Tookie Gilbert, L</b> (1, 3)<br>OBP: 0.304, SLG: 0.320 |   | 4-0<br>PB<br>BB                 |                              | 0-0<br>E3<br>E<br>1B            | 0-0<br>6-3                   |                                  |                              | 0-0<br>6-3                       | 4-0<br>1-2<br>2-3<br>3-H<br>BB | 3 1 0 2 2 0 1                   |                              |                                 |                              |                                 |                              |                                 |                              |                                  |                                  |                                    |                                  |        |
| <b>Alvin Dark, R</b> (1, 6)<br>OBP: 0.282, SLG: 0.329     |   | 0-0<br>5-3                      |                              | 0-0<br>E<br>1B<br>1B            |                              | 0-3<br>K                         |                              | 4-0<br>S<br>BB                   | 0-0<br>F9                      | 4 1 1 1 1 1 4                   |                              |                                 |                              |                                 |                              |                                 |                              |                                  |                                  |                                    |                                  |        |
| <b>Monty Kennedy, R</b> (1, 1)<br>OBP: 0.056, SLG: 0.056  |   |                                 | 0-0<br>F7                    | 0-0<br>E1<br>1B<br>F9           |                              | 0-0<br>P3                        |                              | 0-0<br>F9                        |                                | 3 1 0 0 0 0 1                   |                              |                                 |                              |                                 |                              |                                 |                              |                                  |                                  |                                    |                                  |        |
| <b>Andy Hansen, R</b> (6, 1)                              |   |                                 |                              |                                 |                              |                                  |                              |                                  |                                | 0 0 0 0 0 0 0                   |                              |                                 |                              |                                 |                              |                                 |                              |                                  |                                  |                                    |                                  |        |
| <b>Sal Maglie, R</b> (6, 1)                               |   |                                 |                              |                                 |                              |                                  |                              |                                  |                                | 0 0 0 0 0 0 0                   |                              |                                 |                              |                                 |                              |                                 |                              |                                  |                                  |                                    |                                  |        |
| <b>Roy Weatherly, L</b> (8, PH)<br>OBP: 0.000, SLG: 0.000 |   |                                 |                              |                                 |                              |                                  |                              |                                  |                                | 1 0 0 0 0 0 1                   |                              |                                 |                              |                                 |                              |                                 |                              |                                  |                                  |                                    |                                  |        |
| <b>Sheldon Jones, R</b> (8, 1)                            |   |                                 |                              |                                 |                              |                                  |                              |                                  |                                | 0 0 0 0 0 0 0                   |                              |                                 |                              |                                 |                              |                                 |                              |                                  |                                  |                                    |                                  |        |
| <b>Dave Koslo, L</b> (9, 1)                               |   |                                 |                              |                                 |                              |                                  |                              |                                  |                                | 0 0 0 0 0 0 0                   |                              |                                 |                              |                                 |                              |                                 |                              |                                  |                                  |                                    |                                  |        |
| <b>Inning Stats</b>                                       | R: 0<br>E: 0<br>K: 1<br>S: 6                          | H: 1<br>LOB: 1<br>BB: 0<br>P: 6 | R: 0<br>E: 0<br>K: 2<br>S: 3 | H: 0<br>LOB: 1<br>BB: 1<br>P: 7 | R: 0<br>E: 0<br>K: 2<br>S: 7 | H: 0<br>LOB: 1<br>BB: 1<br>P: 11 | R: 5<br>E: 2<br>K: 0<br>S: 8 | H: 3<br>LOB: 2<br>BB: 2<br>P: 16 | R: 0<br>E: 0<br>K: 0<br>S: 3   | H: 0<br>LOB: 0<br>BB: 0<br>P: 3 | R: 0<br>E: 0<br>K: 1<br>S: 5 | H: 0<br>LOB: 0<br>BB: 0<br>P: 5 | R: 0<br>E: 1<br>K: 1<br>S: 6 | H: 0<br>LOB: 1<br>BB: 0<br>P: 6 | R: 0<br>E: 0<br>K: 1<br>S: 5 | H: 0<br>LOB: 1<br>BB: 1<br>P: 9 | R: 2<br>E: 1<br>K: 0<br>S: 4 | H: 1<br>LOB: 3<br>BB: 4<br>P: 20 | 1B: 3<br>2B: 2<br>3B: 0<br>HR: 0 | SF: 0<br>SAC: 0<br>DP: 1<br>HBP: 0 | WP: 0<br>PB: 2<br>SB: 4<br>CS: 0 | PA: 44 |
| <b>PITCHER</b>  | IP WLS BF H R ER SO BB IBB HBP BLK WP HR S P ERA WHIP |                                 |                              |                                 |                              |                                  |                              |                                  |                                |                                 |                              |                                 |                              |                                 |                              |                                 |                              |                                  |                                  |                                    |                                  |        |
| <b>Willie Ramsdell, R</b> (1, 1)<br>ERA: 3.03             | 8.2 L 43 5 7 1 6 9 0 0 0 0 0 0 46 82 1.04 1.615       |                                 |                              |                                 |                              |                                  |                              |                                  |                                |                                 |                              |                                 |                              |                                 |                              |                                 |                              |                                  |                                  |                                    |                                  |        |
| <b>Herm Wehmeier, R</b> (9, 1)<br>ERA: 6.68               | 0.1 1 0 0 0 0 0 0 0 0 0 0 0 1 1 0.00 0.000            |                                 |                              |                                 |                              |                                  |                              |                                  |                                |                                 |                              |                                 |                              |                                 |                              |                                 |                              |                                  |                                  |                                    |                                  |        |

**New York Giants @ Cincinnati Reds**  
Crosley Field, Cincinnati, OH

livebaseballscorecards.com

|     |    |
|-----|----|
| AB  | 35 |
| R   | 7  |
| H   | 5  |
| RBI | 5  |
| BB  | 9  |
| SO  | 6  |
| LOB | 19 |



Fri Jun 02 1950, 3:33 AM EDT  
Att. 5,152 - Unknown



BOTTOM

New York Giants @ Cincinnati Reds  
Crosley Field, Cincinnati, OH  
Fri Jun 02 1950, 3:33 AM EDT  
Att. 5,152 - Unknown

livebaseballscorecards.com

AB 33  
R 6  
H 9  
RBI 6  
BB 4  
SO 1  
LOB 17



WP: 0 PA: 40  
PB: 0  
SB: 0  
CS: 0

AB R H RBI BB SO LOB

3 0 0 1 2 0 4

2 0 0 0 1 0 0

3 1 1 0 0 0 1  
0 0 0 0 0 0 0  
1 0 0 0 0 0 1

4 0 0 0 1 0 3

4 3 3 1 0 0 2

4 1 1 1 0 0 3

4 1 1 0 0 1 1

4 0 2 2 0 0 0

4 0 1 1 0 0 2

0 0 0 0 0 0 0

1B: 8 SF: 0  
2B: 1 SAC: 3  
3B: 0 DP: 1  
HR: 1 HBP: 0

| Batter   | 1                   | 2                      | 3          | 4          | 5         | 6                     | 7                   | 8                 | 9                |
|--|---------------------|------------------------|------------|------------|-----------|-----------------------|---------------------|-------------------|------------------|
| Bobby Adams, R<br>OBP: 0.339, SLG: 0.337<br>(1, 4)   | 4-0<br>SH1-4<br>BB  | 0-0<br>F9              |            |            | 0-0<br>F7 | 0-0<br>FC6-4-3-2-5    |                     |                   | 4-0<br>SH3<br>BB |
| Peanuts Lowrey, R<br>OBP: 0.370, SLG: 0.315<br>(1, 7)  | 0-0<br>SH1-4<br>1-2 |                        | 0-0<br>5-3 |            | 0-0<br>F7 |                       | 4-0<br>SH5-4<br>BB  | 0-0<br>SH3<br>1-2 |                  |
| Bob Usher, R<br>OBP: 0.278, SLG: 0.441<br>Ron Northey, L<br>OBP: 0.379, SLG: 0.534<br>Danny Litwhiler, R<br>OBP: 0.349, SLG: 0.371<br>(1, 8) | 0-0<br>F9           |                        | 0-0<br>F2  |            |           | 0-0<br>1B<br>1B       | 0-0<br>SH5-4<br>1-2 | 0-0<br>F8         |                  |
| Ted Kluszewski, L<br>OBP: 0.321, SLG: 0.485<br>(1, 3)  | 0-0<br>1-3          |                        | 0-0<br>G3  |            |           | 0-0<br>L8             | 4-0<br>IBB          | 0-0<br>F7         |                  |
| Johnny Wyrostek, L<br>OBP: 0.404, SLG: 0.465<br>(1, 9)   |                     | 0-0<br>1B<br>1B        |            | 0-0<br>HR  |           | 0-0<br>1B<br>1B<br>1B | 0-0<br>F7           |                   |                  |
| Virgil Stallcup, R<br>OBP: 0.285, SLG: 0.405<br>(1, 6)   |                     | 0-0<br>F8              |            | 0-0<br>5-3 |           | 0-0<br>1B<br>1B<br>1B | 0-0<br>F8           |                   |                  |
| Grady Hatton, L<br>OBP: 0.324, SLG: 0.377<br>(1, 5)  |                     | 0-0<br>E6<br>1B<br>1-2 |            | 0-3<br>K   |           | 0-0<br>1B<br>1B<br>1B |                     | 0-0<br>F8         |                  |
| Dixie Howell, R<br>OBP: 0.373, SLG: 0.280<br>(1, 2)  |                     | 0-0<br>1B              |            | 0-0<br>F2  |           | 0-0<br>1B<br>1B       |                     | 0-0<br>L7         |                  |
| Willie Ramsdell, R<br>OBP: 0.154, SLG: 0.154<br>Herm Wehmeier, R<br>OBP: 0.259, SLG: 0.308<br>(1, 1)   |                     | 0-0<br>L3              |            |            | 0-0<br>F5 | 0-0<br>1B             |                     | 0-0<br>1-3        |                  |

| Inning Stats | R: 0 | H: 0 | E: 0 | K: 0 | S: 3 | H: 0 | LOB: 1 | BB: 1 | P: 7 | R: 1 | H: 2 | E: 1 | K: 0 | S: 6 | H: 0 | LOB: 0 | BB: 0 | P: 6 | R: 0 | H: 0 | E: 0 | K: 0 | S: 3 | R: 1 | H: 1 | E: 0 | K: 1 | S: 6 | R: 0 | H: 0 | E: 0 | K: 0 | S: 3 | R: 4 | H: 6 | E: 0 | K: 0 | S: 8 | R: 0 | H: 0 | E: 0 | K: 0 | S: 3 | R: 0 | H: 0 | E: 0 | K: 0 | S: 3 | R: 0 | H: 0 | E: 0 | K: 0 | S: 3 | R: 0 | H: 0 | E: 0 | K: 0 | S: 3 | R: 0 | H: 0 | E: 0 | K: 0 | S: 3 |
|--------------|------|------|------|------|------|------|--------|-------|------|------|------|------|------|------|------|--------|-------|------|------|------|------|------|------|------|------|------|------|------|------|------|------|------|------|------|------|------|------|------|------|------|------|------|------|------|------|------|------|------|------|------|------|------|------|------|------|------|------|------|------|------|------|------|------|
|--------------|------|------|------|------|------|------|--------|-------|------|------|------|------|------|------|------|--------|-------|------|------|------|------|------|------|------|------|------|------|------|------|------|------|------|------|------|------|------|------|------|------|------|------|------|------|------|------|------|------|------|------|------|------|------|------|------|------|------|------|------|------|------|------|------|------|

| PITCHER                                 | IP  | WLS | BF | H | R | ER | SO | BB | IBB | HBP | BLK | WP | HR | S  | P  | ERA  | WHIP  |
|---|-----|-----|----|---|---|----|----|----|-----|-----|-----|----|----|----|----|------|-------|
| Monty Kennedy, L<br>ERA: 4.01<br>(1, 1) | 5.1 |     | 25 | 7 | 6 | 5  | 1  | 1  | 0   | 0   | 0   | 0  | 1  | 26 | 30 | 8.44 | 1.500 |
| Andy Hansen, R<br>ERA: 2.92<br>(6, 1)   | 0.0 |     | 2  | 2 | 0 | 0  | 0  | 0  | 0   | 0   | 0   | 0  | 0  | 2  | 2  | ∞    | ∞     |
| Sal Maglie, R<br>ERA: 4.5<br>(6, 1)     | 1.2 |     | 6  | 0 | 0 | 0  | 0  | 1  | 1   | 0   | 0   | 0  | 0  | 4  | 12 | 0.00 | 0.600 |
| Sheldon Jones, R<br>ERA: 6.0<br>(8, 1)  | 1.1 | W   | 5  | 0 | 0 | 0  | 0  | 1  | 0   | 0   | 0   | 0  | 0  | 4  | 8  | 0.00 | 0.750 |
| Dave Koslo, L<br>ERA: 3.46<br>(9, 1)    | 0.2 | S   | 2  | 0 | 0 | 0  | 0  | 0  | 0   | 0   | 0   | 0  | 0  | 2  | 2  | 0.00 | 0.000 |

| Batter   | 1   | 2   | 3                        | 4                      | 5                        | 6                      | 7                        | 8                      | 9                        | AB R H RBI BB SO LOB   | TOP  |                        |   |                        |                          |                        |                          |                        |  |   |  |  |  |
|--|---|---|--------------------------|------------------------|--------------------------|------------------------|--------------------------|------------------------|--------------------------|------------------------|--|------------------------|---|------------------------|--------------------------|------------------------|--------------------------|------------------------|--|---|--|--|--|
| Sam Jethroe, S (1, 8) x<br>OBP: 0.364, SLG: 0.497          | 0-0 1-3 ①   |   | 4-0 FC6-4 BB             |                        | 0-3 K ②                  |                        |                          | 0-0 F7 ②               |                          | 3 0 0 0 1 1 1          | <b>Boston Braves @ Cincinnati Reds</b><br>Crosley Field, Cincinnati, OH<br>Sun Jun 04 1950, 3:33 AM EDT<br>Unknown |                        |   |                        |                          |                        |                          |                        |  |   |  |  |  |
| Earl Torgeson, L (1, 3) x<br>OBP: 0.415, SLG: 0.372        | 0-0 F3 ②  |   | 0-0 F3 ②                 |                        | 0-0 4-1 ③                |                        |                          | 0-0 1B                 |                          | 4 0 1 0 0 0 2          |  |                        |   |                        |                          |                        |                          |                        |  |   |  |  |  |
| Luis Olmo, R (1, 9) x<br>OBP: 0.314, SLG: 0.367            | 0-0 F4 ③  |   | 0-0 FC6-4 ③              |                        |                          |                        | 0-0 F7 ①                 | 0-0 F8 ③               |                          | 4 0 0 0 0 0 2          |  |                        |   |                        |                          |                        |                          |                        |  |   |  |  |  |
| Bob Elliott, R (1, 5)                                      |   | 0-0 1-3 FC1-2-5-2 2B                          |                          | 0-0 F4 ①               |                          | 0-0 F7 ②               |                          |                        | 0-0 6-3 ①                | 4 0 1 0 0 0 0          |  |                        |   |                        |                          |                        |                          |                        |  |   |  |  |  |
| Walker Cooper, R (1, 2)                                    |   | 0-0 1-3 ①                                     |                          | 0-0 F6 ②               |                          | 0-0 F7 ③               |                          |                        | 0-0 4-3 ②                | 4 0 0 0 0 0 1          |  |                        |   |                        |                          |                        |                          |                        |  |   |  |  |  |
| Sid Gordon, R (1, 7)                                       |   | 0-0 FC1-2-5-2 1B                              |                          | 0-0 E9                 |                          |                        | 0-0 6-3 ①                |                        | 0-0 6-3 ③                | 4 0 1 0 0 0 0          |  |                        |   |                        |                          |                        |                          |                        |  |   |  |  |  |
| Gene Mauch, R (1, 4)                                       |   | 0-0 FC1-2-5-2 FC6-4 1-2 3-H                   |                          | 0-0 F7 ③               |                          |                        | 0-0 F7 ②                 |                        |                          | 3 0 0 0 0 0 3          |  |                        |   |                        |                          |                        |                          |                        |  |   |  |  |  |
| Buddy Kerr, R (1, 6)                                       |   | 0-0 FC6-4 1-2f                                |                          |                        | 0-0 1B                   |                        | 0-0 6-3 ③                |                        |                          | 3 0 1 0 0 0 2          |  |                        |   |                        |                          |                        |                          |                        |  |   |  |  |  |
| Johnny Antonelli, L (1, 1)                                 |   |   | 0-0 G3 ①                 |                        | 0-3 K ①                  |                        |                          | 0-0 F4 ①               |                          | 1 0 0 0 0 0 0          |  |                        |   |                        |                          |                        |                          |                        |  |   |  |  |  |
| Dick Donovan, L (4, 1)                                     |   |   |                          |                        |                          |                        |                          |                        |                          | 1 0 0 0 0 1 1          |  |                        |   |                        |                          |                        |                          |                        |  |   |  |  |  |
| Roy Hartsfield, R (8, PH)                                  |   |   |                          |                        |                          |                        |                          |                        |                          | 1 0 0 0 0 0 0          |  |                        |   |                        |                          |                        |                          |                        |  |   |  |  |  |
| Ernie Johnson, R (8, 1)                                    |   |   |                          |                        |                          |                        |                          |                        |                          | 0 0 0 0 0 0 0          |  |                        |   |                        |                          |                        |                          |                        |  |   |  |  |  |
| <b>Inning Stats</b>  | R: 0 H: 0 E: 0 K: 0 S: 3                              | H: 0 LOB: 0 BB: 0 P: 3                        | R: 0 H: 2 E: 0 K: 0 S: 5 | H: 2 LOB: 2 BB: 0 P: 5 | R: 0 H: 0 E: 1 K: 0 S: 3 | H: 0 LOB: 1 BB: 1 P: 7 | R: 0 H: 0 E: 1 K: 0 S: 4 | H: 0 LOB: 1 BB: 0 P: 4 | R: 0 H: 1 E: 0 K: 2 S: 8 | H: 1 LOB: 1 BB: 0 P: 8 | R: 0 H: 0 E: 0 K: 0 S: 3   | H: 0 LOB: 0 BB: 0 P: 3 | R: 0 H: 0 E: 0 K: 0 S: 3  | H: 0 LOB: 0 BB: 0 P: 3 | R: 0 H: 1 E: 0 K: 0 S: 4 | H: 1 LOB: 1 BB: 0 P: 4 | R: 0 H: 0 E: 0 K: 0 S: 3 | H: 0 LOB: 0 BB: 0 P: 3 | 1B: 3 SF: 0<br>2B: 1 SAC: 0<br>3B: 0 DP: 0<br>HR: 0 HBP: 0 | WP: 0 PA: 33<br>PB: 0<br>SB: 0<br>CS: 0 |  |  |  |
| <b>PITCHER</b><br>Ken Raffensberger, L (1, 1)<br>ERA: 3.33 | IP WLS BF H R ER SO BB IBB HBP BLK WP HR S P ERA WHIP | 9.0 W 33 4 0 0 2 1 0 0 0 0 0 36 40 0.00 0.556 |                          |                        |                          |                        |                          |                        |                          |                        |  |                        | <b>PITCHER</b><br>IP WLS BF H R ER SO BB IBB HBP BLK WP HR S P ERA WHIP |                        |                          |                        |                          |                        |  |   |  |  |  |

livebaseballscorecards.com

|            |    |
|------------|----|
| <b>AB</b>  | 32 |
| <b>R</b>   | 0  |
| <b>H</b>   | 4  |
| <b>RBI</b> | 0  |
| <b>BB</b>  | 1  |
| <b>SO</b>  | 2  |
| <b>LOB</b> | 12 |



| Batter  | 1                          | 2                            | 3         | 4                             | 5                   | 6                   | 7         | 8         | 9 | AB | R | H | RBI | BB | SO | LOB |
|---|----------------------------|------------------------------|-----------|-------------------------------|---------------------|---------------------|-----------|-----------|---|----|---|---|-----|----|----|-----|
| <b>Bobby Adams, R</b><br>OBP: 0.344, SLG: 0.337<br>(1, 4)       | 0-0<br>F3                  | 4-0<br>FC6-4<br>BB           |           | 0-0<br>1-2<br>2-H<br>BB<br>1B |                     | 0-0<br>4-3          |           |           |   | 3  | 0 | 1 | 1   | 1  | 0  | 1   |
| <b>Peanuts Lowrey, R</b><br>OBP: 0.375, SLG: 0.316<br>(1, 7)    | 0-0<br>1B                  | 0-0<br>FC6-4<br>1-2f         |           | 4-0<br>1-2<br>2-3<br>BB       |                     | 0-0<br>F8           |           |           |   | 3  | 0 | 1 | 0   | 1  | 0  | 3   |
| <b>Bob Usher, R</b><br>OBP: 0.303, SLG: 0.451<br>(1, 8)         | 0-0<br>1-2<br>G6-4-3<br>1B |                              | 0-0<br>1B | 0-3<br>K                      |                     | 4-0<br>G4-3<br>BB   |           |           |   | 3  | 0 | 2 | 0   | 1  | 1  | 3   |
| <b>Ted Kluszewski, L</b><br>OBP: 0.310, SLG: 0.467<br>(1, 3)    | 0-0<br>G6-4-3<br>1-2f      |                              | 0-0<br>F7 | 0-0<br>F7                     |                     | 0-0<br>G4-3<br>1-2f |           |           |   | 4  | 0 | 0 | 0   | 0  | 0  | 7   |
| <b>Johnny Wyrostek, L</b><br>OBP: 0.393, SLG: 0.451<br>(1, 9)   |                            | 0-0<br>F7                    | 0-3<br>K  |                               | 0-0<br>4-3          |                     | 0-0<br>F2 |           |   | 4  | 0 | 0 | 0   | 0  | 1  | 1   |
| <b>Virgil Stallcup, R</b><br>OBP: 0.291, SLG: 0.408<br>(1, 6)   |                            | 0-0<br>1B                    | 0-0<br>F7 |                               | 0-0<br>G1-6-3<br>1B |                     | 0-0<br>F8 |           |   | 4  | 0 | 2 | 0   | 0  | 0  | 1   |
| <b>Grady Hatton, L</b><br>OBP: 0.322, SLG: 0.373<br>(1, 5)      |                            | 0-0<br>1B<br>1-3<br>2B<br>1B |           | 0-0<br>4-3                    | 0-0<br>G1-6-3       |                     | 0-0<br>F8 |           |   | 4  | 1 | 1 | 0   | 0  | 0  | 1   |
| <b>Dixie Howell, R</b><br>OBP: 0.397, SLG: 0.315<br>(1, 2)      |                            | 0-0<br>2B<br>2-3<br>1B       |           | 0-0<br>BB<br>1B<br>1B         |                     | 0-0<br>6-3          |           | 0-0<br>1B |   | 4  | 2 | 3 | 0   | 0  | 0  | 0   |
| <b>Ken Raffensberger, R</b><br>OBP: 0.292, SLG: 0.318<br>(1, 1) |                            | 0-0<br>1-H<br>3-H<br>2B      |           | 4-0<br>BB<br>1B<br>BB         |                     | 0-0<br>2B           |           | 0-0<br>F9 |   | 3  | 0 | 2 | 2   | 1  | 0  | 1   |

| Inning Stats | R: 0 | H: 2 | E: 0 | LOB: 1 | K: 0 | BB: 0 | S: 4 | R: 2 | H: 4 | E: 0 | LOB: 2 | K: 0 | BB: 1 | S: 6 | R: 0 | H: 1 | E: 0 | LOB: 1 | K: 1 | BB: 0 | S: 6 | R: 1 | H: 2 | E: 0 | LOB: 3 | K: 1 | BB: 2 | S: 7 | R: 0 | H: 1 | E: 0 | LOB: 0 | K: 0 | BB: 0 | S: 3 | R: 0 | H: 1 | E: 0 | LOB: 1 | K: 0 | BB: 0 | S: 4 | R: 0 | H: 0 | E: 0 | LOB: 0 | K: 0 | BB: 1 | S: 2 | R: 0 | H: 1 | E: 0 | LOB: 1 | K: 0 | BB: 0 | S: 4 | R: 0 | H: 1 | E: 0 | LOB: 1 | K: 0 | BB: 0 | S: 4 |
|--------------|------|------|------|--------|------|-------|------|------|------|------|--------|------|-------|------|------|------|------|--------|------|-------|------|------|------|------|--------|------|-------|------|------|------|------|--------|------|-------|------|------|------|------|--------|------|-------|------|------|------|------|--------|------|-------|------|------|------|------|--------|------|-------|------|------|------|------|--------|------|-------|------|
|--------------|------|------|------|--------|------|-------|------|------|------|------|--------|------|-------|------|------|------|------|--------|------|-------|------|------|------|------|--------|------|-------|------|------|------|------|--------|------|-------|------|------|------|------|--------|------|-------|------|------|------|------|--------|------|-------|------|------|------|------|--------|------|-------|------|------|------|------|--------|------|-------|------|

| PITCHER   | IP  | WLS | BF | H | R | ER | SO | BB | IBB | HBP | BLK | WP | HR | S  | P  | ERA  | WHIP  |
|---|-----|-----|----|---|---|----|----|----|-----|-----|-----|----|----|----|----|------|-------|
| <b>Johnny Antonelli, L</b><br>ERA: 12.0<br>(1, 1) | 3.1 | L   | 19 | 9 | 3 | 3  | 1  | 2  | 0   | 0   | 0   | 0  | 0  | 19 | 27 | 8.10 | 3.300 |
| <b>Dick Donovan, R</b><br>ERA: 5.85<br>(4, 1)     | 3.2 |     | 13 | 2 | 0 | 0  | 1  | 2  | 0   | 0   | 0   | 0  | 0  | 13 | 21 | 0.00 | 1.091 |
| <b>Ernie Johnson, R</b><br>ERA: 7.11<br>(8, 1)    | 1.0 |     | 4  | 1 | 0 | 0  | 0  | 0  | 0   | 0   | 0   | 0  | 0  | 4  | 4  | 0.00 | 1.000 |

**BOTTOM**

**Boston Braves @ Cincinnati Reds**  
Crosley Field, Cincinnati, OH

Sun Jun 04 1950, 3:33 AM EDT  
Unknown

livebaseballscorecards.com

|            |           |
|------------|-----------|
| <b>AB</b>  | <b>32</b> |
| <b>R</b>   | <b>3</b>  |
| <b>H</b>   | <b>12</b> |
| <b>RBI</b> | <b>3</b>  |
| <b>BB</b>  | <b>4</b>  |
| <b>SO</b>  | <b>2</b>  |
| <b>LOB</b> | <b>18</b> |



| WP | PA | ERA | WHIP |
|----|----|-----|------|
| 0  | 36 |     |      |

| Batter   | 1   | 2   | 3  | 4   | 5   | 6   | 7  | 8  | 9   | AB R H RBI BB SO LOB   | TOP  |  |                |   |
|--|---|---|--|---|---|---|--|--|---|--|--|--|----------------|---|
| Sam Jethroe, S<br>OBP: 0.360, SLG: 0.488<br>(1, 8) X   | 0-0<br>2-3<br>1B<br>1B  |   | 0-0<br>F8<br>2B<br>1B  | 0-0<br>4-3  |   |   | 0-0<br>G1<br>1B  | 0-0<br>F9<br>1-2   |   | 5 1 1 0 0 0 2  |  |  |                |   |
| Earl Torgeson, L<br>OBP: 0.414, SLG: 0.369<br>(1, 3) X   | 0-0<br>F8<br>1B   |   | 0-0<br>2B<br>1B  |   | 0-0<br>F7<br>1B   |   | 0-0<br>F8<br>1B  | 4-0<br>HBP<br>BB   |   | 4 1 1 0 1 0 1  |  |  |                |   |
| Tommy Holmes, L<br>OBP: 0.538, SLG: 0.619<br>(1, 9) X  | 0-0<br>2-3<br>1-2<br>1B   |   | 0-0<br>2B<br>2B  |   | 0-0<br>E4<br>1B   |   | 0-0<br>BB<br>BB<br>1B  | 1-0<br>HBP   |   | 4 2 2 2 0 0 1  |  |  |                |   |
| Bob Elliott, R<br>OBP: 0.341, SLG: 0.474<br>(1, 5) X   | 0-0<br>2-H<br>1B  |   | 0-0<br>WP<br>1B<br>2B  |   | 0-0<br>1-2<br>1B  |   | 4-0<br>BB<br>BB<br>BB  | 0-0<br>4-3<br>3  |   | 4 1 3 2 1 0 3  |  |  |                |   |
| Sid Gordon, R<br>OBP: 0.415, SLG: 0.638<br>Sibby Sisti, R<br>OBP: 0.235, SLG: 0.138<br>(1, 7)<br>(7, 4)            |   | BB<br>BB<br>BB  | 4-0<br>G1-6-3<br>BB<br>1B<br>IBB                                 | 4-0<br>WP<br>1B<br>IBB  |   | 0-0<br>F9<br>1B   | 4-0<br>BB<br>BB<br>BB  | 0-0<br>F6<br>1B  |   | 1 1 0 0 3 0 2<br>1 0 0 0 0 0 0   |  |  |                |   |
| Del Crandall, R<br>OBP: 0.259, SLG: 0.241<br>(1, 2) X  |   | 0-0<br>P3<br>1B   | 0-0<br>1-H<br>2-H<br>1B  |   | 0-0<br>F8<br>1B   |   | 4-0<br>BB<br>BB<br>BB  | 0-0<br>F6<br>1B  |   | 4 0 1 3 1 0 3  |  |  |                |   |
| Gene Mauch, R<br>OBP: 0.313, SLG: 0.326<br>Pete Reiser, L<br>OBP: 0.404, SLG: 0.341<br>(1, 4)<br>(7, PH)<br>(7, 7) |   | 0-0<br>G1-6-3<br>1-2f   | 0-0<br>F2<br>1B  |   |   | 0-0<br>6-3<br>1B  | 0-0<br>F4<br>1B  | 4-0<br>FC6-4<br>BB   |   | 3 0 0 0 0 0 2<br>1 0 0 0 1 0 3   | AB 35<br>R 7<br>H 9<br>RBI 7<br>BB 8<br>SO 1<br>LOB 18 |  |                |   |
| Buddy Kerr, R<br>OBP: 0.252, SLG: 0.293<br>(1, 6) X  |   |   | 0-0<br>F9<br>1B  | 0-0<br>5-3  |   | 0-0<br>5-3  |  | 0-0<br>F9<br>1-2f  | 0-0<br>FC6-4<br>1B  | 5 0 0 0 0 0 1  |  |  |                |   |
| Bob Chipman, L<br>OBP: 0.333, SLG: 0.200<br>Bobby Hogue, R<br>(8, 1)   |   |   | 0-0<br>1B<br>2B<br>1B  | 0-0<br>1-3  |   | 0-3<br>K<br>1B  |  | 4-0<br>HBP<br>BLK<br>BB  |   | 3 1 1 0 1 1 0<br>0 0 0 0 0 0 0   |  |  |                |   |
| <b>Inning Stats</b>  | R: 1<br>E: 0<br>K: 0<br>S: 4<br>H: 2<br>LOB: 1<br>BB: 0<br>P: 4 | R: 0<br>E: 0<br>K: 0<br>S: 2<br>H: 0<br>LOB: 0<br>BB: 1<br>P: 6 | R: 5<br>E: 0<br>K: 0<br>S: 8<br>H: 5<br>LOB: 1<br>BB: 1<br>P: 12 | R: 0<br>E: 0<br>K: 0<br>S: 3<br>H: 0<br>LOB: 0<br>BB: 0<br>P: 3 | R: 0<br>E: 1<br>K: 0<br>S: 5<br>H: 1<br>LOB: 2<br>BB: 0<br>P: 5 | R: 0<br>E: 0<br>K: 1<br>S: 5<br>H: 0<br>LOB: 0<br>BB: 0<br>P: 5 | R: 1<br>E: 0<br>K: 0<br>S: 4<br>H: 1<br>LOB: 3<br>BB: 3<br>P: 16 | R: 0<br>E: 0<br>K: 0<br>S: 3<br>H: 0<br>LOB: 3<br>BB: 2<br>P: 12 | R: 0<br>E: 0<br>K: 0<br>S: 3<br>H: 0<br>LOB: 1<br>BB: 1<br>P: 7 | 1B: 7<br>2B: 2<br>3B: 0<br>HR: 0<br>SF: 0<br>SAC: 0<br>DP: 1<br>HBP: 1 | WP: 1<br>PB: 0<br>SB: 0<br>CS: 0<br>PA: 44             |  |                |   |
| <b>PITCHER</b>   | IP WLS BF H R ER SO BB IBB HBP BLK WP HR S P ERA WHIP           |   |  |   |   |   |  |  |   |  |  |  | <b>PITCHER</b> | IP WLS BF H R ER SO BB IBB HBP BLK WP HR S P ERA WHIP |
| Herm Wehmeier, R<br>ERA: 7.25<br>(1, 1)  | 2.2 L 15 7 6 6 0 1 1 0 0 0 1 0 13 21 20.25 3.000                |   |  |   |   |   |  |  |   |  |  |  |                |   |
| Howie Fox, R<br>ERA: 5.73<br>(3, 1)  | 4.0 18 2 1 1 1 3 0 0 0 0 0 0 17 29 2.25 1.250                   |   |  |   |   |   |  |  |   |  |  |  |                |   |
| Johnny Hetki, R<br>ERA: 5.94<br>(7, 1)   | 1.0 6 0 0 0 0 2 0 0 1 1 0 0 3 12 0.00 2.000                     |   |  |   |   |   |  |  |   |  |  |  |                |   |
| Frank Smith, R<br>ERA: 3.86<br>(8, 1)  | 0.1 1 0 0 0 0 0 0 0 0 0 0 0 1 1 0.00 0.000                      |   |  |   |   |   |  |  |   |  |  |  |                |   |
| Harry Perkowski, L<br>ERA: 4.15<br>(9, 1)  | 1.0 4 0 0 0 0 1 0 0 0 0 0 0 3 7 0.00 1.000                      |   |  |   |   |   |  |  |   |  |  |  |                |   |

**Boston Braves @ Cincinnati Reds**  
Crosley Field, Cincinnati, OH  
Sun Jun 04 1950, 3:38 AM EDT  
Att: 11,043 - Unknown

livebaseballscorecards.com





| Batter   | 1  | 2   | 3   | 4   | 5   | 6   | 7   | 8   | 9  | AB R H RBI BB SO LOB   | TOP  |
|--|--|---|---|---|---|---|---|---|--|--|--|
| Sam Jethroe, S (1, 8)<br>OBP: 0.356, SLG: 0.486          | 0-0<br>G3<br>S<br>2B   |   | 0-0<br>F8   |   | 0-0<br>6-3  |   | 0-0<br>F7   |   | 0-0<br>E4<br>3B<br>1-2<br>2-3<br>3-H                             | 5 2 1 0 0 0 3  |  |
| Earl Torgeson, L (1, 3)<br>OBP: 0.414, SLG: 0.383        | 0-3<br>K   |   | 0-3<br>K  |   |   | 0-0<br>F9   |   | 0-0<br>SH1-4<br>1B  | 0-0<br>F7<br>3B<br>1-H<br>2-H<br>3-H                             | 5 1 2 3 0 2 1  |  |
| Tommy Holmes, L (1, 9)<br>OBP: 0.500, SLG: 0.560         | 0-0<br>G3<br>2-3   |   |   | 0-0<br>E<br>5-3<br>1B   |   | 0-0<br>F2   |   | 0-0<br>SH1-4<br>1-2   | 0-0<br>F7<br>3-H   | 4 0 1 1 0 0 1  |  |
| Bob Elliott, R (1, 5)<br>OBP: 0.337, SLG: 0.463          | 4-0<br>WP<br>BB<br>3-H   |   |   | 0-0<br>5-3<br>1-2   |   | 0-0<br>5-3  |   | 0-0<br>F8   | 0-0<br>6-3   | 4 0 0 0 1 0 2  |  |
| Sid Gordon, R (1, 7)<br>OBP: 0.413, SLG: 0.639           | 0-0<br>6-3<br>1-3  |   |   | 0-0<br>F8   |   |   | 0-0<br>HR<br>2B   | 0-0<br>4-3  |  | 3 0 1 0 0 0 2  |  |
| Pete Reiser, L (7, PR)<br>OBP: 0.396, SLG: 0.333         |  |   |   |   |   |   |   |   |  | 1 1 0 0 0 0 1  |  |
| Walker Cooper, R (1, 2)<br>OBP: 0.323, SLG: 0.436        |  | 0-0<br>6-3  |   | 0-0<br>E5<br>FC5-4<br>2-3                                       |   |   | 0-0<br>HR<br>2-H  |   | 4-0<br>BB<br>E<br>BB   | 3 2 1 2 1 0 1  |  |
| Gene Mauch, R (1, 4)<br>OBP: 0.308, SLG: 0.319           |  | 0-3<br>K  |   | 0-0<br>FC5-4<br>1-2f  |   |   | 0-0<br>5-3  |   | 0-0<br>E<br>BB<br>1-2<br>3B<br>1B                                | 4 1 1 0 0 1 3  |  |
| Buddy Kerr, R (1, 6)<br>OBP: 0.252, SLG: 0.292           |  | 0-0<br>6-3  |   |   | 0-3<br>K  |   | 0-0<br>SH2-4<br>1B  |   | 0-3<br>K   | 4 0 1 0 0 2 2  |  |
| Vern Bickford, R (1, 1)<br>OBP: 0.219, SLG: 0.138        |  |   | 0-0<br>F2   |   | 0-3<br>K  |   | 0-0<br>SH2-4<br>1-2   |   | 4-0<br>E<br>1-2<br>2-3<br>3B<br>BB                               | 2 1 0 0 1 1 0  |  |
| <b>Inning Stats</b>                                      | R: 1<br>E: 0<br>K: 1<br>S: 6<br>H: 1<br>LOB: 1<br>BB: 1<br>P: 10   | R: 0<br>E: 0<br>K: 1<br>S: 5<br>H: 0<br>LOB: 0<br>BB: 0<br>P: 5 | R: 0<br>E: 0<br>K: 1<br>S: 5<br>H: 0<br>LOB: 0<br>BB: 0<br>P: 5 | R: 0<br>E: 1<br>K: 0<br>S: 5<br>H: 1<br>LOB: 2<br>BB: 0<br>P: 5 | R: 0<br>E: 0<br>K: 2<br>S: 7<br>H: 0<br>LOB: 0<br>BB: 0<br>P: 7 | R: 0<br>E: 0<br>K: 0<br>S: 3<br>H: 0<br>LOB: 0<br>BB: 0<br>P: 3 | R: 2<br>E: 0<br>K: 0<br>S: 6<br>H: 3<br>LOB: 1<br>BB: 0<br>P: 6 | R: 0<br>E: 0<br>K: 0<br>S: 4<br>H: 1<br>LOB: 1<br>BB: 0<br>P: 4 | R: 5<br>E: 1<br>K: 1<br>S: 8<br>H: 2<br>LOB: 0<br>BB: 2<br>P: 16 | 1B: 4<br>2B: 2<br>3B: 1<br>HR: 1<br>SF: 0<br>SAC: 2<br>DP: 0<br>HBP: 0 | WP: 2<br>PB: 0<br>SB: 1<br>CS: 0<br>PA: 40 |
| <b>PITCHER</b><br>Ewell Blackwell, R (1, 1)<br>ERA: 3.36 | IP: 8.1<br>WLS: L<br>BF: 37<br>H: 7<br>R: 7<br>ER: 6<br>SO: 6<br>BB: 3<br>IBB: 0<br>HBP: 0<br>BLK: 0<br>WP: 1<br>HR: 1<br>S: 46<br>P: 58<br>ERA: 6.48<br>WHIP: 1.200 |   |   |   |   |   |   |   |  |  |  |
| Harry Perkowski, L (9, 1)<br>ERA: 3.95                   | IP: 0.2<br>WLS:<br>BF: 3<br>H: 1<br>R: 1<br>ER: 0<br>SO: 0<br>BB: 0<br>IBB: 0<br>HBP: 0<br>BLK: 0<br>WP: 0<br>HR: 0<br>S: 3<br>P: 3<br>ERA: 0.00<br>WHIP: 1.500      |   |   |   |   |   |   |   |  |  |  |

**Boston Braves @ Cincinnati Reds**  
Crosley Field, Cincinnati, OH  
Tue Jun 06 1950, 3:33 AM EDT  
Att. 2,152 - Unknown

[livebaseballscorecards.com](http://livebaseballscorecards.com)

|     |    |
|-----|----|
| AB  | 35 |
| R   | 8  |
| H   | 8  |
| RBI | 6  |
| BB  | 3  |
| SO  | 6  |
| LOB | 16 |



| Batter   | 1                               | 2         | 3               | 4          | 5 | 6                     | 7                                 | 8         | 9         | AB | R | H | RBI | BB | SO | LOB |
|--|---------------------------------|-----------|-----------------|------------|---|-----------------------|-----------------------------------|-----------|-----------|----|---|---|-----|----|----|-----|
| <b>Bobby Adams, R</b><br>OBP: 0.333, SLG: 0.319 (1, 4)     | 0-0<br>E6<br>2B                 |           | 0-0<br>F7       | 0-0<br>5-3 |   |                       | 4-0<br>1B<br>1B<br>BB             |           | 0-0<br>F5 | 4  | 2 | 0 | 0   | 1  | 0  | 1   |
| <b>Grady Hatton, L</b><br>OBP: 0.331, SLG: 0.418 (1, 5)    | 0-0<br>F8                       |           | 0-0<br>HR       |            |   | 0-0<br>4-3            | 0-0<br>1B<br>1-2<br>1B            |           |           | 4  | 1 | 2 | 1   | 0  | 0  | 1   |
| <b>Johnny Wyrostek, L</b><br>OBP: 0.415, SLG: 0.475 (1, 8) | 4-0<br>2B<br>BB                 |           | 0-0<br>1B<br>1B |            |   | 4-0<br>G4-6-3<br>BB   | 0-0<br>G4-6-3<br>1-2<br>2-H<br>1B |           |           | 2  | 0 | 2 | 1   | 2  | 0  | 0   |
| <b>Ted Kluszewski, L</b><br>OBP: 0.303, SLG: 0.466 (1, 3)  | 0-0<br>G5-3<br>1-3<br>2-H<br>2B |           | 0-0<br>F9       |            |   | 0-0<br>G4-6-3<br>1-2f | 0-0<br>G4-6-3<br>1-2f             |           |           | 4  | 0 | 1 | 1   | 0  | 0  | 4   |
| <b>Ron Northey, L</b><br>OBP: 0.380, SLG: 0.519 (1, 9)     | 4-0<br>BB                       |           | 0-0<br>1B       |            |   | 0-0<br>F8             |                                   | 0-0<br>G3 |           | 3  | 0 | 1 | 0   | 1  | 0  | 0   |
| <b>Danny Litwhiler, R</b><br>OBP: 0.319, SLG: 0.333 (1, 7) | 0-0<br>G5-3<br>2-3f             |           | 0-0<br>F7       |            |   | 0-0<br>F5             |                                   | 0-0<br>F7 |           | 4  | 0 | 0 | 0   | 0  | 0  | 5   |
| <b>Virgil Stallcup, R</b><br>OBP: 0.289, SLG: 0.406 (1, 6) |                                 | 0-0<br>F7 |                 | 0-0<br>4-3 |   | 0-0<br>1B             |                                   | 0-3<br>K  |           | 4  | 0 | 1 | 0   | 0  | 1  | 0   |
| <b>Dixie Howell, R</b><br>OBP: 0.366, SLG: 0.279 (1, 2)    |                                 | 0-0<br>F8 |                 | 4-0<br>BB  |   | 0-0<br>6-3            |                                   | 0-0<br>F3 |           | 3  | 0 | 0 | 0   | 1  | 0  | 1   |
| <b>Ewell Blackwell, R</b><br>OBP: 0.182, SLG: 0.100 (1, 1) |                                 | 0-0<br>F8 |                 | 0-0<br>F8  |   | 0-0<br>6-3            |                                   | 0-3<br>K  |           | 3  | 0 | 0 | 0   | 0  | 0  | 1   |
| <b>Harry Perkowski, L</b><br>OBP: 0.429, SLG: 0.429 (9, 1) |                                 |           |                 |            |   |                       |                                   |           |           | 0  | 0 | 0 | 0   | 0  | 0  | 0   |
| <b>Bob Usher, R</b><br>OBP: 0.305, SLG: 0.434 (9, PH)      |                                 |           |                 |            |   |                       |                                   |           |           | 1  | 0 | 0 | 0   | 0  | 1  | 0   |

| Inning Stats | R: 1 | H: 1 | E: 1 | K: 0 | S: 4 | H: 1 | LOB: 2 | BB: 2 | P: 12 | R: 0 | H: 0 | E: 0 | K: 0 | S: 3 | R: 0 | H: 3 | E: 0 | K: 0 | S: 6 | R: 0 | H: 0 | E: 0 | K: 0 | S: 3 | R: 0 | H: 0 | E: 0 | K: 0 | S: 2 | R: 0 | H: 1 | E: 0 | K: 0 | S: 4 | R: 1 | H: 2 | E: 0 | K: 0 | S: 4 | R: 0 | H: 0 | E: 0 | K: 1 | S: 5 | R: 0 | H: 0 | E: 0 | K: 1 | S: 5 | R: 0 | H: 0 | E: 0 | K: 1 | S: 5 | 1B: 5 | SF: 0 | 2B: 1 | SAC: 0 | 3B: 0 | DP: 3 | HR: 1 | HBP: 0 | WP: 0 | PA: 37 |
|--------------|------|------|------|------|------|------|--------|-------|-------|------|------|------|------|------|------|------|------|------|------|------|------|------|------|------|------|------|------|------|------|------|------|------|------|------|------|------|------|------|------|------|------|------|------|------|------|------|------|------|------|------|------|------|------|------|-------|-------|-------|--------|-------|-------|-------|--------|-------|--------|
|--------------|------|------|------|------|------|------|--------|-------|-------|------|------|------|------|------|------|------|------|------|------|------|------|------|------|------|------|------|------|------|------|------|------|------|------|------|------|------|------|------|------|------|------|------|------|------|------|------|------|------|------|------|------|------|------|------|-------|-------|-------|--------|-------|-------|-------|--------|-------|--------|

| PITCHER                                     | IP  | WLS | BF | H | R | ER | SO | BB | IBB | HBP | BLK | WP | HR | S  | P  | ERA  | WHIP  |
|---|-----|-----|----|---|---|----|----|----|-----|-----|-----|----|----|----|----|------|-------|
| <b>Vern Bickford, R</b><br>ERA: 2.84 (1, 1) | 9.0 | W   | 37 | 7 | 3 | 2  | 2  | 5  | 0   | 0   | 0   | 0  | 1  | 36 | 56 | 2.00 | 1.333 |

**BOTTOM**

**Boston Braves @ Cincinnati Reds**  
Crosley Field, Cincinnati, OH  
Tue Jun 06 1950, 3:33 AM EDT  
Att. 2,152 - Unknown

livebaseballscorecards.com

| AB  | 32 |
|-----|----|
| R   | 3  |
| H   | 7  |
| RBI | 3  |
| BB  | 5  |
| SO  | 2  |
| LOB | 13 |



| Batter   | 1                            | 2                               | 3                            | 4                               | 5                            | 6                               | 7                            | 8                               | 9                            | AB R H RBI BB SO LOB            | TOP  |                                 |                              |                                 |                              |                                 |                              |                                 |                                   |                                    |                                  |        |    |    |   |   |     |      |  |  |  |  |  |
|--|------------------------------|---------------------------------|------------------------------|---------------------------------|------------------------------|---------------------------------|------------------------------|---------------------------------|------------------------------|---------------------------------|--|---------------------------------|------------------------------|---------------------------------|------------------------------|---------------------------------|------------------------------|---------------------------------|-----------------------------------|------------------------------------|----------------------------------|--------|----|----|---|---|-----|------|--|--|--|--|--|
| Richie Ashburn, L (1, 8)<br>OBP: 0.404, SLG: 0.405       | 0-0<br>F2                    |                                 | 0-0<br>1B                    |                                 | 0-0<br>F5                    |                                 |                              | 0-0<br>CS<br>1B                 |                              | 4 0 2 1 0 0 1                   | <b>Philadelphia Phillies @ Cincinnati Reds</b><br>Crosley Field, Cincinnati, OH<br>Wed Jun 07 1950, 3:33 AM EDT<br>Att: 8,220 - Unknown - 84 F<br><a href="http://livebaseballscorecards.com">livebaseballscorecards.com</a> |                                 |                              |                                 |                              |                                 |                              |                                 |                                   |                                    |                                  |        |    |    |   |   |     |      |  |  |  |  |  |
| Eddie Waitkus, L (1, 3)<br>OBP: 0.360, SLG: 0.385        | 0-3<br>K                     |                                 | 0-0<br>F9                    |                                 | 0-0<br>FC4-6                 |                                 |                              | 4-0<br>1B<br>BB                 |                              | 3 1 0 0 1 1 3                   |  |                                 |                              |                                 |                              |                                 |                              |                                 |                                   |                                    |                                  |        |    |    |   |   |     |      |  |  |  |  |  |
| Willie Jones, R (1, 5)<br>OBP: 0.349, SLG: 0.509         | 0-0<br>F4                    |                                 | 0-0<br>CS                    |                                 | 0-0<br>F2                    |                                 |                              | 0-0<br>FC6-4<br>1B              |                              | 4 0 2 1 0 0 0                   |  |                                 |                              |                                 |                              |                                 |                              |                                 |                                   |                                    |                                  |        |    |    |   |   |     |      |  |  |  |  |  |
| Del Ennis, R (1, 9)<br>OBP: 0.341, SLG: 0.526            |                              | 0-0<br>6-3                      |                              | 0-0<br>G3-6<br>1B               |                              |                                 |                              | 0-0<br>FC6-4                    |                              | 4 0 1 0 0 0 2                   |  |                                 |                              |                                 |                              |                                 |                              |                                 |                                   |                                    |                                  |        |    |    |   |   |     |      |  |  |  |  |  |
| Dick Sisler, L (1, 7)<br>OBP: 0.435, SLG: 0.569          |                              | 0-0<br>F7                       |                              | 0-0<br>G3-6<br>1B               |                              |                                 |                              | 0-0<br>SH5-4<br>1B              |                              | 4 0 1 0 0 0 2                   |  |                                 |                              |                                 |                              |                                 |                              |                                 |                                   |                                    |                                  |        |    |    |   |   |     |      |  |  |  |  |  |
| Granny Hamner, R (1, 6)<br>OBP: 0.332, SLG: 0.358        |                              | 0-3<br>K                        |                              |                                 | 0-0<br>F9<br>BB<br>1B        |                                 |                              | 0-0<br>SH5-4<br>1B              |                              | 3 1 1 0 0 1 0                   |  |                                 |                              |                                 |                              |                                 |                              |                                 |                                   |                                    |                                  |        |    |    |   |   |     |      |  |  |  |  |  |
| Andy Seminick, R (1, 2)<br>OBP: 0.404, SLG: 0.437        |                              |                                 |                              |                                 | 4-0<br>1B<br>WP<br>BB        |                                 |                              | 0-0<br>1-3                      |                              | 3 2 1 0 1 0 1                   |  |                                 |                              |                                 |                              |                                 |                              |                                 |                                   |                                    |                                  |        |    |    |   |   |     |      |  |  |  |  |  |
| Jimmy Bloodworth, R (1, 4)<br>OBP: 0.245, SLG: 0.204     |                              |                                 |                              |                                 | 0-0<br>F9<br>1B              |                                 |                              | 4-0<br>IBB                      |                              | 0 0 0 0 0 0 0                   |  |                                 |                              |                                 |                              |                                 |                              |                                 |                                   |                                    |                                  |        |    |    |   |   |     |      |  |  |  |  |  |
| Bob Miller, R (1, 1)<br>OBP: 0.214, SLG: 0.214           |                              |                                 |                              |                                 | 0-0<br>FC4-6<br>1B           |                                 |                              | 0-0<br>F7                       |                              | 4 0 1 2 0 1 4                   |  |                                 |                              |                                 |                              |                                 |                              |                                 |                                   |                                    |                                  |        |    |    |   |   |     |      |  |  |  |  |  |
| <b>Inning Stats</b>                                      | R: 0<br>E: 0<br>K: 1<br>S: 5 | H: 0<br>LOB: 0<br>BB: 0<br>P: 5 | R: 0<br>E: 0<br>K: 1<br>S: 5 | H: 0<br>LOB: 0<br>BB: 0<br>P: 5 | R: 1<br>E: 0<br>K: 1<br>S: 7 | H: 3<br>LOB: 1<br>BB: 0<br>P: 7 | R: 0<br>E: 0<br>K: 0<br>S: 3 | H: 1<br>LOB: 0<br>BB: 0<br>P: 3 | R: 2<br>E: 0<br>K: 0<br>S: 5 | H: 2<br>LOB: 1<br>BB: 1<br>P: 9 | R: 0<br>E: 0<br>K: 0<br>S: 3   | H: 1<br>LOB: 0<br>BB: 0<br>P: 3 | R: 0<br>E: 0<br>K: 0<br>S: 3 | H: 0<br>LOB: 0<br>BB: 0<br>P: 3 | R: 1<br>E: 0<br>K: 0<br>S: 4 | H: 2<br>LOB: 1<br>BB: 1<br>P: 8 | R: 0<br>E: 0<br>K: 0<br>S: 4 | H: 1<br>LOB: 2<br>BB: 1<br>P: 8 | 1B: 10<br>2B: 1<br>3B: 0<br>HR: 0 | SF: 0<br>SAC: 1<br>DP: 2<br>HBP: 0 | WP: 1<br>PB: 0<br>SB: 1<br>CS: 2 | PA: 37 |    |    |   |   |     |      |  |  |  |  |  |
| <b>PITCHER</b><br>Willie Ramsdell, R (1, 1)<br>ERA: 3.24 | IP<br>9.0                    | WLS<br>L                        | BF<br>36                     | H<br>10                         | R<br>4                       | ER<br>4                         | SO<br>3                      | BB<br>2                         | IBB<br>1                     | HBP<br>0                        | BLK<br>0   | WP<br>1                         | HR<br>0                      | S<br>39                         | P<br>51                      | ERA<br>4.00                     | WHIP<br>1.333                |                                 |                                   |                                    |                                  |        |    |    |   |   |     |      |  |  |  |  |  |
|  |                              |                                 |                              |                                 |                              |                                 |                              |                                 |                              |                                 | <b>PITCHER</b>   | IP                              | WLS                          | BF                              | H                            | R                               | ER                           | SO                              | BB                                | IBB                                | HBP                              | BLK    | WP | HR | S | P | ERA | WHIP |  |  |  |  |  |





| Batter  | 1         | 2           | 3           | 4                            | 5           | 6           | 7            | 8                   | 9           | AB | R | H | RBI | BB | SO | LOB |
|---|-----------|-------------|-------------|------------------------------|-------------|-------------|--------------|---------------------|-------------|----|---|---|-----|----|----|-----|
| Grady Hatton, L<br>OBP: 0.323, SLG: 0.407 (1, 5) x    | 0-0 4-3 ① |             | x 0-0 F8 ③  |                              | x 0-0 G3 ③  |             | x 0-0 F8 ③   |                     |             | 4  | 0 | 0 | 0   | 0  | 0  | 4   |
| Peanuts Lowrey, R<br>OBP: 0.367, SLG: 0.333 (1, 7) x  | 0-0 6-3 ② |             |             | x 0-0 6-3 ①                  |             | x 0-0 F7 ①  |              | x 0-0 1-3 ①         |             | 4  | 0 | 0 | 0   | 0  | 0  | 0   |
| Johnny Wyrostek, L<br>OBP: 0.411, SLG: 0.469 (1, 8) x | 0-0 3-1 ③ |             |             | x 0-0 F8 ②                   |             | x 0-0 F5 ②  |              | x 0-0 1B 1B         |             | 4  | 0 | 1 | 0   | 0  | 0  | 0   |
| Ted Kluszewski, L<br>OBP: 0.317, SLG: 0.483 (1, 3) x  |           | x 0-0 4-3 ① |             | x 0-0 BB 1B                  |             | x 0-0 BB 2B |              | x 0-0 1-3 G5-4-3 1B |             | 4  | 0 | 3 | 0   | 0  | 0  | 0   |
| Danny Litwhiler, R<br>OBP: 0.314, SLG: 0.310 (1, 9) x |           | x 0-0 F8 ②  |             | BB BB BB BB 4-0 FC6-4 BB 1-2 |             | x 0-0 F4 ③  |              | x 0-0 G5-4-3 ② ③    |             | 3  | 0 | 0 | 0   | 1  | 0  | 3   |
| Virgil Stallcup, R<br>OBP: 0.281, SLG: 0.394 (1, 6) x |           | x 0-0 F8 ③  |             | x 0-0 FC6-4 ③                |             |             | x 0-0 6-3 ①  |                     | x 0-0 6-3 ① | 4  | 0 | 0 | 0   | 0  | 0  | 2   |
| Johnny Pramesa, R<br>OBP: 0.308, SLG: 0.396 (1, 2) x  |           |             | x 0-0 5-3 ① |                              | x 0-0 6-3 ① |             | x 0-0 6-3 ②  |                     | x 0-0 F5 ②  | 4  | 0 | 0 | 0   | 0  | 0  | 0   |
| Bobby Adams, R<br>OBP: 0.331, SLG: 0.325 (1, 4) x     |           |             | x 0-0 5-3 ② |                              | x 0-0 F3 ②  |             | x 0-0 E 2B   |                     | x 0-0 F5 ③  | 4  | 0 | 1 | 0   | 0  | 0  | 0   |
| Willie Ramsdell, R<br>OBP: 0.250, SLG: 0.250 (1, 1) x |           |             | x 0-0 1B    |                              | x 0-0 1B    |             | x 0-0 E6 2-3 |                     |             | 3  | 0 | 2 | 0   | 0  | 0  | 1   |

| Inning Stats | R: 0 | H: 0 | E: 0 | K: 0 | S: 3 | R: 0 | H: 0 | E: 0 | K: 0 | S: 3 | R: 0 | H: 1 | E: 0 | K: 0 | S: 4 | R: 0 | H: 1 | E: 0 | K: 0 | S: 4 | R: 0 | H: 1 | E: 0 | K: 0 | S: 4 | R: 0 | H: 1 | E: 0 | K: 0 | S: 5 | R: 0 | H: 2 | E: 0 | K: 0 | S: 4 | R: 0 | H: 0 | E: 0 | K: 0 | S: 3 | 1B: 5 | SF: 0 | 2B: 2 | SAC: 0 | 3B: 0 | DP: 1 | HR: 0 | HBP: 0 | WP: 0 | PA: 35 |
|--------------|------|------|------|------|------|------|------|------|------|------|------|------|------|------|------|------|------|------|------|------|------|------|------|------|------|------|------|------|------|------|------|------|------|------|------|------|------|------|------|------|-------|-------|-------|--------|-------|-------|-------|--------|-------|--------|
|              | 0    | 0    | 0    | 0    | 3    | 0    | 0    | 0    | 0    | 3    | 0    | 1    | 0    | 0    | 4    | 0    | 1    | 0    | 0    | 0    | 4    | 0    | 1    | 0    | 0    | 0    | 4    | 0    | 1    | 0    | 5    | 2    | 0    | 0    | 0    | 4    | 0    | 0    | 0    | 0    | 3     | 5     | 0     | 0      | 0     | 0     | 1     | 0      | 35    |        |

| PITCHER                           | IP  | WLS | BF | H | R | ER | SO | BB | IBB | HBP | BLK | WP | HR | S  | P  | ERA  | WHIP  |
|-----------------------------------|-----|-----|----|---|---|----|----|----|-----|-----|-----|----|----|----|----|------|-------|
| Bob Miller, R<br>ERA: 1.13 (1, 1) | 9.0 | W   | 35 | 7 | 0 | 0  | 0  | 1  | 0   | 0   | 0   | 0  | 0  | 34 | 38 | 0.00 | 0.889 |

**BOTTOM**

**Philadelphia Phillies @ Cincinnati Reds**  
 Crosley Field, Cincinnati, OH  
 Wed Jun 07 1950, 3:33 AM EDT  
 Att. 8,220 - Unknown - 84 F

livebaseballscorecards.com

|     |    |
|-----|----|
| AB  | 34 |
| R   | 0  |
| H   | 7  |
| RBI | 0  |
| BB  | 1  |
| SO  | 0  |
| LOB | 10 |



| Batter  | 1  | 2                               | 3                                 | 4                               | 5                            | 6                               | 7                            | 8                               | 9                            | AB R H RBI BB SO LOB            | TOP                          |                                 |  |                                 |                              |                                 |                              |                                 |                                  |                                    |                                  |        |
|---|--|---------------------------------|-----------------------------------|---------------------------------|------------------------------|---------------------------------|------------------------------|---------------------------------|------------------------------|---------------------------------|------------------------------|---------------------------------|--|---------------------------------|------------------------------|---------------------------------|------------------------------|---------------------------------|----------------------------------|------------------------------------|----------------------------------|--------|
| Richie Ashburn, L (1, 8)<br>OBP: 0.400, SLG: 0.400        | 0-3<br>K   |                                 | 0-0<br>G6-4-3 SH<br>1-2 2-H<br>1B |                                 | 0-0<br>F9                    |                                 |                              | 0-0<br>F9                       |                              | 4 0 1 1 0 1 0                   |                              |                                 |  |                                 |                              |                                 |                              |                                 |                                  |                                    |                                  |        |
| Eddie Waitkus, L (1, 3)<br>OBP: 0.354, SLG: 0.379         | 0-0<br>P2  |                                 | 0-0<br>SH<br>G6-4-3               |                                 |                              | 0-3<br>K                        |                              | 0-0<br>G3                       |                              | 3 0 0 0 0 1 0                   |                              |                                 |  |                                 |                              |                                 |                              |                                 |                                  |                                    |                                  |        |
| Willie Jones, R (1, 5)<br>OBP: 0.342, SLG: 0.497          | 0-0<br>1-3   |                                 | 0-0<br>G6-4-3<br>1-2 2-3<br>3-H   |                                 |                              | 0-0<br>F9                       |                              |                                 | 0-0<br>F6                    | 4 0 0 0 0 0 2                   |                              |                                 |  |                                 |                              |                                 |                              |                                 |                                  |                                    |                                  |        |
| Del Ennis, R (1, 9)<br>OBP: 0.339, SLG: 0.538             |  | 0-0<br>HR                       | 0-0<br>6-3                        |                                 |                              | 0-0<br>5-3                      |                              |                                 | 0-0<br>F7                    | 4 1 1 1 0 0 1                   |                              |                                 |  |                                 |                              |                                 |                              |                                 |                                  |                                    |                                  |        |
| Dick Sisler, L (1, 7)<br>OBP: 0.426, SLG: 0.555           |  | 0-0<br>P2                       |                                   | 0-0<br>G3                       |                              |                                 | 0-0<br>1-3                   |                                 | 0-0<br>F9                    | 4 0 0 0 0 0 0                   |                              |                                 |  |                                 |                              |                                 |                              |                                 |                                  |                                    |                                  |        |
| Granny Hamner, R (1, 6)<br>OBP: 0.327, SLG: 0.353         |  | 0-0<br>F9                       |                                   | 0-0<br>1-3                      |                              |                                 | 0-3<br>K                     |                                 |                              | 3 0 0 0 0 1 0                   |                              |                                 |  |                                 |                              |                                 |                              |                                 |                                  |                                    |                                  |        |
| Andy Seminick, R (1, 2)<br>OBP: 0.402, SLG: 0.473         |  | 0-0<br>6-3                      |                                   | 0-0<br>F5                       |                              |                                 | 0-0<br>HR                    |                                 |                              | 3 1 1 1 0 0 0                   |                              |                                 |  |                                 |                              |                                 |                              |                                 |                                  |                                    |                                  |        |
| Jimmy Bloodworth, R (1, 4)<br>OBP: 0.250, SLG: 0.212      |  |                                 | 0-0<br>1B                         |                                 | 0-0<br>F8                    |                                 | 0-0<br>5-3                   |                                 |                              | 0 1 0 0 0 0 0                   |                              |                                 |  |                                 |                              |                                 |                              |                                 |                                  |                                    |                                  |        |
| Ken Johnson, L (1, 1)<br>OBP: 0.154, SLG: 0.154           |  |                                 | 0-0<br>1B                         |                                 | 0-3<br>K                     |                                 |                              | 0-0<br>F7                       |                              | 1 1 1 0 0 0 0                   |                              |                                 |  |                                 |                              |                                 |                              |                                 |                                  |                                    |                                  |        |
| Russ Meyer, S (3, 1)<br>OBP: 0.333, SLG: 0.333            |  |                                 | 0-0<br>SH 1B<br>G6-4-3<br>1B      |                                 |                              |                                 |                              |                                 |                              | 0 0 0 0 0 0 0                   |                              |                                 |  |                                 |                              |                                 |                              |                                 |                                  |                                    |                                  |        |
| Blix Donnelly, R (4, 1)<br>OBP: 0.290, SLG: 0.500         |  |                                 |                                   |                                 |                              |                                 |                              |                                 |                              | 0 0 0 0 0 0 0                   |                              |                                 |  |                                 |                              |                                 |                              |                                 |                                  |                                    |                                  |        |
| Stan Holmig, R (5, PH)<br>OBP: 0.290, SLG: 0.500          |  |                                 |                                   |                                 |                              |                                 |                              |                                 |                              | 1 0 0 0 0 1 0                   |                              |                                 |  |                                 |                              |                                 |                              |                                 |                                  |                                    |                                  |        |
| Hank Borowy, R (5, 1)<br>OBP: 0.200, SLG: 0.111           |  |                                 |                                   |                                 |                              |                                 |                              |                                 |                              | 0 0 0 0 0 0 0                   |                              |                                 |  |                                 |                              |                                 |                              |                                 |                                  |                                    |                                  |        |
| Putsy Caballero, R (8, PH)<br>OBP: 0.125, SLG: 0.125      |  |                                 |                                   |                                 |                              |                                 |                              |                                 |                              | 1 0 0 0 0 0 0                   |                              |                                 |  |                                 |                              |                                 |                              |                                 |                                  |                                    |                                  |        |
| Jim Konstanty, R (8, 1)<br>OBP: 0.125, SLG: 0.125         |  |                                 |                                   |                                 |                              |                                 |                              |                                 |                              | 0 0 0 0 0 0 0                   |                              |                                 |  |                                 |                              |                                 |                              |                                 |                                  |                                    |                                  |        |
| <b>Inning Stats</b>                                       | R: 0<br>E: 0<br>K: 1<br>S: 5   | H: 0<br>LOB: 0<br>BB: 0<br>P: 5 | R: 1<br>E: 0<br>K: 0<br>S: 4      | H: 1<br>LOB: 0<br>BB: 0<br>P: 4 | R: 2<br>E: 0<br>K: 0<br>S: 6 | H: 3<br>LOB: 1<br>BB: 0<br>P: 6 | R: 0<br>E: 0<br>K: 0<br>S: 3 | H: 0<br>LOB: 0<br>BB: 0<br>P: 3 | R: 0<br>E: 0<br>K: 1<br>S: 5 | H: 0<br>LOB: 0<br>BB: 0<br>P: 5 | R: 0<br>E: 0<br>K: 1<br>S: 5 | H: 0<br>LOB: 0<br>BB: 0<br>P: 5 | R: 1<br>E: 0<br>K: 1<br>S: 6   | H: 1<br>LOB: 0<br>BB: 0<br>P: 6 | R: 0<br>E: 0<br>K: 0<br>S: 3 | H: 0<br>LOB: 0<br>BB: 0<br>P: 3 | R: 0<br>E: 0<br>K: 0<br>S: 3 | H: 0<br>LOB: 0<br>BB: 0<br>P: 3 | 1B: 3<br>2B: 0<br>3B: 0<br>HR: 2 | SF: 0<br>SAC: 1<br>DP: 1<br>HBP: 0 | WP: 0<br>PB: 0<br>SB: 0<br>CS: 0 | PA: 32 |
| <b>PITCHER</b><br>Ken Raffensberger, L (1, 1)<br>ERA: 3.4 | IP: 9.0<br>WLS: W<br>BF: 32<br>H: 5<br>R: 4<br>ER: 4<br>SO: 4<br>BB: 0<br>IBB: 0<br>HBP: 0<br>BLK: 0<br>WP: 0<br>HR: 2<br>S: 40<br>P: 40<br>ERA: 4.00<br>WHIP: 0.556 |                                 |                                   |                                 |                              |                                 |                              |                                 |                              |                                 |                              | <b>PITCHER</b>                  | IP: 9.0<br>WLS: W<br>BF: 32<br>H: 5<br>R: 4<br>ER: 4<br>SO: 4<br>BB: 0<br>IBB: 0<br>HBP: 0<br>BLK: 0<br>WP: 0<br>HR: 2<br>S: 40<br>P: 40<br>ERA: 4.00<br>WHIP: 0.556 |                                 |                              |                                 |                              |                                 |                                  |                                    |                                  |        |

Philadelphia Phillies @ Cincinnati Reds  
Crosley Field, Cincinnati, OH  
Thu Jun 08 1950, 3:33 AM EDT  
Att. 4,102 - Unknown

livebaseballscorecards.com

|     |    |
|-----|----|
| AB  | 28 |
| R   | 4  |
| H   | 4  |
| RBI | 3  |
| BB  | 0  |
| SO  | 4  |
| LOB | 3  |



| Batter  | 1          | 2         | 3                     | 4                     | 5         | 6                  | 7                | 8                  | 9 |
|---|------------|-----------|-----------------------|-----------------------|-----------|--------------------|------------------|--------------------|---|
| Grady Hatton, L (1, 5)<br>OBP: 0.331, SLG: 0.433      | 0-0<br>4-3 |           | 0-0<br>1B<br>2B<br>1B | 0-0<br>1B<br>2B<br>1B |           | 0-0<br>F7          |                  | 0-0<br>HR          |   |
| Bob Usher, R (1, 8)<br>OBP: 0.333, SLG: 0.443         | 4-0<br>BB  |           | 0-0<br>1B<br>2B<br>1B | 0-0<br>1B<br>2B<br>1B |           | 0-0<br>F4          |                  | 4-0<br>FC4-6<br>BB |   |
| Johnny Wyrostek, L (1, 9)<br>OBP: 0.417, SLG: 0.483   | 0-0<br>F8  |           | 0-0<br>1B<br>2B<br>2B | 0-0<br>1B<br>2B<br>2B |           | 4-0<br>BB          |                  | 0-0<br>FC4-6       |   |
| Danny Litwhiler, R (1, 7)<br>OBP: 0.304, SLG: 0.298   | 0-3<br>K   |           | 0-0<br>2B<br>1B       | 0-0<br>F7             |           | 0-0<br>F9          |                  | 0-3<br>K           |   |
| Ted Kluszewski, L (1, 3)<br>OBP: 0.328, SLG: 0.492    |            | 0-0<br>F9 | 0-0<br>1B<br>2B<br>BB | 4-0<br>BB             |           | 0-0<br>SH2-4<br>1B |                  | 0-0<br>3-1         |   |
| Virgil Stallcup, R (1, 6)<br>OBP: 0.282, SLG: 0.393   |            | 0-0<br>1B | 0-3<br>K              | 0-3<br>K              |           | 0-0<br>SH2-4       |                  |                    |   |
| Bobby Adams, R (1, 4)<br>OBP: 0.329, SLG: 0.322       |            | 0-0<br>P3 | 0-0<br>P4             |                       | 0-0<br>F9 |                    | 0-0<br>2-H<br>1B |                    |   |
| Dixie Howell, R (1, 2)<br>OBP: 0.347, SLG: 0.262      |            | 0-3<br>K  |                       | 0-0<br>F8             | 0-3<br>K  |                    | 0-3<br>K         |                    |   |
| Ken Raffensberger, R (1, 1)<br>OBP: 0.321, SLG: 0.320 |            |           | 4-0<br>1B<br>2B<br>BB | 0-0<br>1B<br>1B       | 0-0<br>P2 |                    | 0-3<br>K         |                    |   |

| AB | R | H | RBI | BB | SO | LOB |
|----|---|---|-----|----|----|-----|
| 5  | 3 | 3 | 1   | 0  | 0  | 0   |
| 3  | 1 | 2 | 1   | 2  | 0  | 0   |
| 4  | 1 | 2 | 4   | 1  | 0  | 2   |
| 5  | 0 | 1 | 0   | 0  | 2  | 4   |
| 4  | 1 | 2 | 1   | 1  | 0  | 1   |
| 3  | 0 | 1 | 0   | 0  | 2  | 4   |
| 4  | 0 | 1 | 1   | 0  | 0  | 3   |
| 4  | 0 | 0 | 0   | 0  | 3  | 2   |
| 3  | 2 | 1 | 0   | 1  | 1  | 1   |

**BOTTOM**

**Philadelphia Phillies @ Cincinnati Reds**  
Crosley Field, Cincinnati, OH

Thu Jun 08 1950, 3:33 AM EDT  
Att. 4,102 - Unknown

|     |    |
|-----|----|
| AB  | 35 |
| R   | 8  |
| H   | 13 |
| RBI | 8  |
| BB  | 5  |
| SO  | 8  |
| LOB | 17 |



| Inning Stats | R: 0 | H: 0 | E: 0 | K: 1 | S: 5 | H: 0 | LOB: 1 | BB: 1 | P: 9 | R: 0 | H: 1 | E: 0 | K: 1 | S: 6 | H: 1 | LOB: 1 | BB: 0 | P: 6 | R: 3 | H: 5 | E: 0 | K: 1 | S: 9 | H: 4 | LOB: 2 | BB: 1 | P: 13 | R: 3 | H: 0 | E: 0 | K: 1 | S: 5 | H: 0 | LOB: 0 | BB: 0 | P: 5 | R: 0 | H: 0 | E: 0 | K: 0 | S: 3 | H: 0 | LOB: 1 | BB: 1 | P: 7 | R: 1 | H: 2 | E: 0 | K: 2 | S: 9 | H: 1 | LOB: 1 | BB: 1 | P: 10 |
|--------------|------|------|------|------|------|------|--------|-------|------|------|------|------|------|------|------|--------|-------|------|------|------|------|------|------|------|--------|-------|-------|------|------|------|------|------|------|--------|-------|------|------|------|------|------|------|------|--------|-------|------|------|------|------|------|------|------|--------|-------|-------|
|--------------|------|------|------|------|------|------|--------|-------|------|------|------|------|------|------|------|--------|-------|------|------|------|------|------|------|------|--------|-------|-------|------|------|------|------|------|------|--------|-------|------|------|------|------|------|------|------|--------|-------|------|------|------|------|------|------|------|--------|-------|-------|

| PITCHER                              | IP  | WLS | BF | H | R | ER | SO | BB | IBB | HBP | BLK | WP | HR | S  | P  | ERA   | WHIP  |
|--------------------------------------|-----|-----|----|---|---|----|----|----|-----|-----|-----|----|----|----|----|-------|-------|
| Ken Johnson, L (1, 1)<br>ERA: 4.32   | 2.1 |     | 12 | 4 | 3 | 3  | 2  | 2  | 0   | 0   | 0   | 0  | 0  | 14 | 22 | 11.57 | 2.571 |
| Russ Meyer, R (3, 1)<br>ERA: 8.67    | 1.0 | L   | 8  | 5 | 3 | 3  | 1  | 0  | 0   | 0   | 0   | 0  | 0  | 10 | 10 | 27.00 | 5.000 |
| Blix Donnelly, R (4, 1)<br>ERA: 4.05 | 0.2 |     | 4  | 1 | 0 | 0  | 1  | 1  | 0   | 0   | 0   | 0  | 0  | 5  | 9  | 0.00  | 3.000 |
| Hank Borowy, R (5, 1)<br>ERA: 6.35   | 3.0 |     | 12 | 2 | 1 | 1  | 3  | 1  | 0   | 0   | 0   | 0  | 0  | 17 | 21 | 3.00  | 1.000 |
| Jim Konstanty, R (8, 1)<br>ERA: 2.25 | 1.0 |     | 5  | 1 | 1 | 1  | 1  | 1  | 0   | 0   | 0   | 0  | 1  | 6  | 10 | 9.00  | 2.000 |

| WP | HR | S | P  | ERA  | WHIP  |
|----|----|---|----|------|-------|
| 0  | 1  | 6 | 10 | 9.00 | 2.000 |



| Batter   | 1          | 2         | 3           | 4                  | 5                    | 6                   | 7           | 8                    | 9 | AB R H RBI BB SO LOB |
|--|------------|-----------|-------------|--------------------|----------------------|---------------------|-------------|----------------------|---|----------------------|
| Grady Hatton, L<br>OBP: 0.335, SLG: 0.451<br>(1, 5)    | 2-2<br>F4  |           | 2-2<br>HR   |                    | 1-2<br>E4<br>PB      |                     |             | 4-2<br>FC1-8<br>BB   |   | 3 2 1 1 1 0 0        |
| Bob Usher, R<br>OBP: 0.330, SLG: 0.434<br>(1, 8)       | 1-3<br>K   |           | 1-0<br>1B   |                    | 3-2<br>5-3           |                     |             | 2-0<br>FC1-6<br>1-2f |   | 4 0 1 0 0 1 1        |
| Johnny Wyrostek, L<br>OBP: 0.407, SLG: 0.470<br>(1, 9) | 0-0<br>4-3 |           | 2-3<br>K    |                    | 0-0<br>4-3           |                     |             | 1-0<br>F5            |   | 4 0 0 0 0 1 2        |
| Bob Scheffing, R<br>OBP: 0.150, SLG: 0.200<br>(1, 2)   |            | 0-0<br>F9 |             | 0-2<br>F8          |                      | 3-2<br>F9           |             | 1-2<br>F7            |   | 4 0 0 0 0 0 1        |
| Danny Litwhiler, R<br>OBP: 0.317, SLG: 0.373<br>(1, 7) |            | 3-1<br>F9 |             | 3-2<br>HR          |                      | 2-1<br>G4-3<br>1B   |             | 2-3<br>K             |   | 4 1 2 1 0 1 0        |
| Ted Kluszewski, L<br>OBP: 0.333, SLG: 0.516<br>(1, 3)  |            | 2-2<br>1B |             | 1-0<br>F6          |                      | 1-1<br>G4-3<br>1-2f |             | 1-2<br>HR            |   | 4 1 2 1 0 0 1        |
| Virgil Stallcup, R<br>OBP: 0.283, SLG: 0.392<br>(1, 6) |            | 0-0<br>F7 |             | 1-1<br>FC5-4<br>1B |                      | 3-3<br>K            |             |                      |   | 3 0 1 0 0 1 1        |
| Bobby Adams, R<br>OBP: 0.322, SLG: 0.315<br>(1, 4)     |            |           | 0-0<br>B5-3 |                    | 3-1<br>FC5-4<br>1-2f |                     | 0-0<br>F2   |                      |   | 3 0 0 0 0 0 1        |
| Herm Wehmeier, R<br>OBP: 0.258, SLG: 0.300<br>(1, 1)   |            |           | 2-3<br>K    |                    | 0-0<br>5-3           |                     | 1-3<br>K2-3 |                      |   | 3 0 0 0 0 2 0        |

| Inning Stats | R: 0 | H: 0 | E: 0 | K: 1 | S: 8 | LOB: 0 | BB: 0 | P: 11 | R: 0 | H: 1 | E: 0 | K: 0 | S: 8 | LOB: 1 | BB: 0 | P: 13 | R: 1 | H: 2 | E: 0 | K: 2 | S: 13 | LOB: 1 | BB: 0 | P: 20 | R: 1 | H: 2 | E: 0 | K: 0 | S: 11 | LOB: 0 | BB: 0 | P: 13 | R: 0 | H: 1 | E: 0 | K: 0 | S: 9 | LOB: 0 | BB: 0 | P: 15 | R: 0 | H: 0 | E: 0 | K: 2 | S: 7 | LOB: 0 | BB: 0 | P: 11 | R: 0 | H: 0 | E: 0 | K: 0 | S: 7 | LOB: 1 | BB: 1 | P: 15 | R: 1 | H: 1 | E: 0 | K: 1 | S: 8 | LOB: 0 | BB: 0 | P: 11 | 1B: 4 | 2B: 0 | 3B: 0 | HR: 3 | SF: 0 | SAC: 0 | DP: 1 | HBP: 0 | WP: 0 | PB: 1 | SB: 0 | CS: 0 | PA: 33 |
|--------------|------|------|------|------|------|--------|-------|-------|------|------|------|------|------|--------|-------|-------|------|------|------|------|-------|--------|-------|-------|------|------|------|------|-------|--------|-------|-------|------|------|------|------|------|--------|-------|-------|------|------|------|------|------|--------|-------|-------|------|------|------|------|------|--------|-------|-------|------|------|------|------|------|--------|-------|-------|-------|-------|-------|-------|-------|--------|-------|--------|-------|-------|-------|-------|--------|
|--------------|------|------|------|------|------|--------|-------|-------|------|------|------|------|------|--------|-------|-------|------|------|------|------|-------|--------|-------|-------|------|------|------|------|-------|--------|-------|-------|------|------|------|------|------|--------|-------|-------|------|------|------|------|------|--------|-------|-------|------|------|------|------|------|--------|-------|-------|------|------|------|------|------|--------|-------|-------|-------|-------|-------|-------|-------|--------|-------|--------|-------|-------|-------|-------|--------|

| PITCHER                                | IP  | WLS | BF | H | R | ER | SO | BB | IBB | HBP | BLK | WP | HR | S  | P  | ERA   | WHIP  |
|--|-----|-----|----|---|---|----|----|----|-----|-----|-----|----|----|----|----|-------|-------|
| Preacher Roe, L<br>ERA: 3.48<br>(1, 1) | 6.0 |     | 24 | 6 | 3 | 2  | 3  | 0  | 0   | 0   | 0   | 0  | 2  | 58 | 91 | 3.00  | 1.000 |
| Ralph Branca, R<br>ERA: 5.6<br>(7, 1)  | 2.0 |     | 7  | 0 | 0 | 0  | 2  | 1  | 0   | 0   | 0   | 0  | 0  | 14 | 26 | 0.00  | 0.500 |
| Rex Barney, R<br>ERA: 3.86<br>(9, 1)   | 0.1 | L   | 2  | 1 | 1 | 1  | 1  | 0  | 0   | 0   | 0   | 0  | 1  | 8  | 11 | 27.00 | 3.000 |

**BOTTOM**

**Brooklyn Dodgers @ Cincinnati Reds**  
Crosley Field, Cincinnati, OH

Sat Jun 10 1950, 3:33 AM EDT  
Att. 6,258 - Unknown

livebaseballscorecards.com

|     |    |
|-----|----|
| AB  | 32 |
| R   | 4  |
| H   | 7  |
| RBI | 3  |
| BB  | 1  |
| SO  | 6  |
| LOB | 7  |



| Batter  | 1   | 2   | 3   | 4   | 5  | 6   | 7   | 8  | 9  | AB R H RBI BB SO LOB   | TOP  |
|---|---|---|---|---|--|---|---|--|--|--|--|
| <b>Pee Wee Reese, R</b> (1, 5)<br>OBP: 0.322, SLG: 0.328          | 0-1<br>E6<br>G5-4-3   | 1-3<br>K  |   |   | 2-1<br>L7  |   | 0-1<br>F8   |  | 0-2<br>F7  | 5 0 0 0 0 1 3  |  |
| <b>Bobby Morgan, R</b> (1, 6)<br>OBP: 0.354, SLG: 0.389           | 0-0<br>G5-4-3   |   |   |   | 0-0<br>5-3   |   | 2-3<br>K  |  | 0-0<br>FC1-4   | 4 0 0 0 0 1 1<br>1 0 0 0 0 0 1   |  |
| <b>Eddie Miksis, R</b> (7, 6)<br>OBP: 0.163, SLG: 0.146           | 1-2f  |   |   |   |  |   |   |  | 1-2f   |  |  |
| <b>Jim Russell, S</b> (1, 7)<br>OBP: 0.329, SLG: 0.560            | 1-3<br>K  |   |   |   | 0-0<br>L6  |   | 2-2<br>F8   |  | 0-0<br>F6  | 5 0 0 0 0 1 1  |  |
| <b>Jackie Robinson, R</b> (1, 4)<br>OBP: 0.448, SLG: 0.547        |   | 3-2<br>1B<br>1B   |   |   | 0-0<br>F4  |   | 0-0<br>FC4-6<br>1B  |  | 1-0<br>1B<br>1B  | 4 2 3 0 0 0 0  |  |
| <b>Carl Furillo, R</b> (1, 9)<br>OBP: 0.299, SLG: 0.372           |   | 0-0<br>F9<br>E<br>1B  |   |   | 1-3<br>K   |   | 0-2<br>F9   |  | 0-0<br>1-3   | 4 1 1 0 0 1 2  |  |
| <b>Gil Hodges, R</b> (1, 3)<br>OBP: 0.397, SLG: 0.455             |   | 2-1<br>E<br>1-2<br>3-H<br>1B                                      |   |   | 4-2<br>FC6-4<br>BB   |   | 0-1<br>FC4-6<br>1B  |  | 4-0<br>1B<br>IBB   | 2 0 2 1 2 0 0  |  |
| <b>Duke Snider, L</b> (1, 8)<br>OBP: 0.398, SLG: 0.541            |   | 0-0<br>B2   |   |   | 1-2<br>FC6-4<br>HR   |   | 2-2<br>FC4-6  |  | 2-2<br>1-2<br>2-H<br>1B  | 4 1 1 1 0 0 5  |  |
| <b>Roy Campanella, R</b> (1, 2)<br>OBP: 0.385, SLG: 0.611         |   | 0-0<br>F9   |   |   | 1-1<br>HR  |   | 2-0<br>F5   |  | 1-0<br>L5  | 4 1 1 2 0 0 6  |  |
| <b>Don Newcombe, L</b> (1, 1)<br>OBP: 0.417, SLG: 0.381           |   | 0-0<br>E6   |   |   | 1-3<br>K   |   | 0-0<br>4-3  |  | 4-1<br>FC1-4<br>BB   | 3 0 0 0 1 1 1  |  |
| <b>Inning Stats</b>   | R: 0<br>E: 1<br>K: 1<br>S: 6<br>H: 0<br>LOB: 0<br>BB: 0<br>P: 7   | R: 2<br>E: 1<br>K: 1<br>S: 14<br>H: 3<br>LOB: 2<br>BB: 0<br>P: 20 | R: 0<br>E: 0<br>K: 0<br>S: 5<br>H: 0<br>LOB: 0<br>BB: 0<br>P: 7 | R: 2<br>E: 0<br>K: 2<br>S: 16<br>H: 1<br>LOB: 0<br>BB: 1<br>P: 24 | R: 0<br>E: 0<br>K: 0<br>S: 8<br>H: 0<br>LOB: 0<br>BB: 0<br>P: 12 | R: 0<br>E: 0<br>K: 0<br>S: 10<br>H: 2<br>LOB: 2<br>BB: 0<br>P: 14 | R: 0<br>E: 0<br>K: 1<br>S: 7<br>H: 0<br>LOB: 0<br>BB: 0<br>P: 9 | R: 1<br>E: 0<br>K: 0<br>S: 8<br>H: 2<br>LOB: 2<br>BB: 1<br>P: 16 | R: 0<br>E: 0<br>K: 0<br>S: 6<br>H: 0<br>LOB: 1<br>BB: 1<br>P: 11 | 1B: 7<br>2B: 0<br>3B: 0<br>HR: 1<br>SF: 0<br>SAC: 0<br>DP: 1<br>HBP: 0 | WP: 0<br>PB: 0<br>SB: 0<br>CS: 0<br>PA: 39 |
| <b>PITCHER</b><br><b>Ken Raffensberger, L</b> (1, 1)<br>ERA: 3.47 | IP: 9.0<br>WLS: L<br>BF: 39<br>H: 8<br>R: 5<br>ER: 4<br>SO: 5<br>BB: 2<br>IBB: 1<br>HBP: 0<br>BLK: 0<br>WP: 0<br>HR: 1<br>S: 80<br>P: 120<br>ERA: 4.00<br>WHIP: 1.111 |   |   |   |  |   |   |  |  |  |  |

**Brooklyn Dodgers @ Cincinnati Reds**  
Crosley Field, Cincinnati, OH

|     |    |
|-----|----|
| AB  | 36 |
| R   | 5  |
| H   | 8  |
| RBI | 4  |
| BB  | 3  |
| SO  | 5  |
| LOB | 20 |



Sun Jun 11 1950, 3:33 AM EDT  
Unknown

[livebaseballscorecards.com](http://livebaseballscorecards.com)

| Batter   | 1  | 2      | 3      | 4 | 5   | 6 | 7  | 8  | 9     | AB | R | H | RBI | BB | SO | LOB |
|--|----|--------|--------|---|-----|---|----|----|-------|----|---|---|-----|----|----|-----|
| Grady Hatton, L<br>OBP: 0.326, SLG: 0.437<br>(1, 5)  | F8 |        | F7     |   | L3  |   | G3 |    | F7    | 5  | 0 | 0 | 0   | 0  | 0  | 0   |
| Bob Usher, R<br>OBP: 0.337, SLG: 0.430<br>(1, 8)   | K  |        | 1B     |   | 6-3 |   |    | 1B | FC6-4 | 3  | 1 | 1 | 0   | 1  | 1  | 0   |
| Johnny Wyrostek, L<br>OBP: 0.409, SLG: 0.471<br>(1, 9)   | F8 |        | 1B     |   |     |   | L9 | 1B | FC6-4 | 4  | 0 | 2 | 0   | 0  | 0  | 0   |
| Ted Kluszewski, L<br>OBP: 0.338, SLG: 0.511<br>(1, 3)  |    | 1B     | G4-6-3 |   |     |   |    | 1B | FC6-4 | 3  | 1 | 1 | 1   | 1  | 0  | 3   |
| Bob Scheffing, R<br>OBP: 0.250, SLG: 0.261<br>(1, 2)   |    | 1B     |        |   | K   |   | 1B | BB | 3-H   | 3  | 1 | 2 | 0   | 1  | 1  | 0   |
| Danny Litwhiler, R<br>OBP: 0.328, SLG: 0.418<br>(1, 7)   |    | 1B     |        |   | 2B  |   | K  | BB | K     | 4  | 1 | 2 | 1   | 0  | 2  | 4   |
| Connie Ryan, R<br>OBP: 0.356, SLG: 0.373<br>(1, 4)   |    | 1B     |        |   | F7  |   | K  |    | F7    | 4  | 0 | 1 | 2   | 0  | 1  | 5   |
| Virgil Stallcup, R<br>OBP: 0.277, SLG: 0.384<br>Peanuts Lowrey, R<br>OBP: 0.364, SLG: 0.330<br>(1, 6)    |    | G4-6-3 |        |   | F6  |   | L1 |    | 5-3   | 3  | 0 | 0 | 0   | 0  | 0  | 2   |
| Ken Raffensberger, R<br>OBP: 0.290, SLG: 0.286<br>Harry Perkowski, L<br>OBP: 0.375, SLG: 0.375<br>(1, 1) |    | 5-3    |        |   | K   |   | K  |    | K     | 1  | 0 | 0 | 0   | 0  | 0  | 0   |

| Inning Stats                                      | R: 0 | H: 0 | E: 0 | K: 1 | S: 8 | R: 3 | H: 4 | E: 0 | K: 0 | S: 8 | R: 0 | H: 2 | E: 0 | K: 0 | S: 5 | R: 0 | H: 1 | E: 0 | K: 1 | S: 10 | R: 0 | H: 0 | E: 0 | K: 1 | S: 8 | R: 0 | H: 1 | E: 0 | K: 2 | S: 11 | R: 0 | H: 0 | E: 0 | K: 1 | S: 6 | R: 1 | H: 1 | E: 0 | K: 1 | S: 11 | R: 0 | H: 0 | E: 0 | K: 1 | S: 8 | 1B: 7 | 2B: 2 | 3B: 0 | HR: 0 | SF: 0 | SAC: 0 | DP: 2 | HBP: 0 | WP: 0 | PB: 0 | SB: 0 | CS: 0 | PA: 37 |
|---|------|------|------|------|------|------|------|------|------|------|------|------|------|------|------|------|------|------|------|-------|------|------|------|------|------|------|------|------|------|-------|------|------|------|------|------|------|------|------|------|-------|------|------|------|------|------|-------|-------|-------|-------|-------|--------|-------|--------|-------|-------|-------|-------|--------|
| PITCHER<br>Don Newcombe, R<br>ERA: 3.58<br>(1, 1) | IP   | WLS  | BF   | H    | R    | ER   | SO   | BB   | IBB  | HBP  | BLK  | WP   | HR   | S    | P    | ERA  | WHIP | IP   | WLS  | BF    | H    | R    | ER   | SO   | BB   | IBB  | HBP  | BLK  | WP   | HR    | S    | P    | ERA  | WHIP | IP   | WLS  | BF   | H    | R    | ER    | SO   | BB   | IBB  | HBP  | BLK  | WP    | HR    | S     | P     | ERA   | WHIP   |       |        |       |       |       |       |        |

**BOTTOM**

**Brooklyn Dodgers @ Cincinnati Reds**  
Crosley Field, Cincinnati, OH

Sun Jun 11 1950, 3:33 AM EDT  
Unknown

livebaseballscorecards.com

**AB 34**  
**R 4**  
**H 9**  
**RBI 4**  
**BB 3**  
**SO 8**  
**LOB 14**



| Batter   | 1   | 2                                | 3                            | 4                                | 5                             | 6                                | 7                             | 8                                | 9                            | AB R H RBI BB SO LOB   | TOP                          |                                 |                              |                                  |                               |                                  |                              |                                  |                                  |                                    |                                  |   |
|--|---|----------------------------------|------------------------------|----------------------------------|-------------------------------|----------------------------------|-------------------------------|----------------------------------|------------------------------|--|------------------------------|---------------------------------|------------------------------|----------------------------------|-------------------------------|----------------------------------|------------------------------|----------------------------------|----------------------------------|------------------------------------|----------------------------------|---|
| <b>Pee Wee Reese, R</b> (1, 5)<br><small>OBP: 0.315, SLG: 0.320</small><br><b>Gene Hermanski, L</b> (7, PH)<br><small>OBP: 0.343, SLG: 0.375</small><br><b>Eddie Miksis, R</b> (7, 5)<br><small>OBP: 0.159, SLG: 0.143</small>   | 2-2<br>6-3  |                                  | 0-0<br>FC3-6<br>1B<br>1-2f   |                                  | 1-2<br>4-3                    |                                  | 1-1<br>F4                     |                                  | 1-3<br>K                     | 3 0 0 0 0 0 1<br>1 0 0 0 0 0 1<br>1 0 0 0 0 1 0                  |                              |                                 |                              |                                  |                               |                                  |                              |                                  |                                  |                                    |                                  |   |
| <b>George Shuba, L</b> (1, 7)<br><small>OBP: 0.308, SLG: 0.392</small>   | 4-1<br>BB   |                                  | 0-3<br>K                     |                                  | 1-1<br>3-1                    |                                  | 2-2<br>F2                     |                                  | 0-3<br>K                     | 4 0 0 0 1 2 2  |                              |                                 |                              |                                  |                               |                                  |                              |                                  |                                  |                                    |                                  |   |
| <b>Duke Snider, L</b> (1, 8)<br><small>OBP: 0.408, SLG: 0.570</small>  | 0-1<br>HR   |                                  | 1-2<br>FC5-4<br>1B<br>1-2    |                                  | 2-2<br>1-3                    |                                  |                               | 3-2<br>2B<br>HR<br>1B            | 0-0<br>2B                    | 5 2 4 1 0 0 0  |                              |                                 |                              |                                  |                               |                                  |                              |                                  |                                  |                                    |                                  |   |
| <b>Jackie Robinson, R</b> (1, 4)<br><small>OBP: 0.447, SLG: 0.560</small>  | 1-1<br>3B   |                                  | 2-2<br>FC5-4<br>1-2f         |                                  |                               | 2-0<br>5-3                       |                               | 0-2<br>1-3<br>HR<br>2B           | 0-1<br>F6                    | 5 1 2 0 0 0 3  |                              |                                 |                              |                                  |                               |                                  |                              |                                  |                                  |                                    |                                  |   |
| <b>Carl Furillo, R</b> (1, 9)<br><small>OBP: 0.303, SLG: 0.375</small>   | 0-3<br>K  |                                  |                              | 1-1<br>S<br>1B                   |                               | 0-1<br>E9<br>1B                  |                               | 0-3<br>K                         |                              | 4 0 2 0 0 2 3  |                              |                                 |                              |                                  |                               |                                  |                              |                                  |                                  |                                    |                                  |   |
| <b>Gil Hodges, R</b> (1, 3)<br><small>OBP: 0.394, SLG: 0.450</small>   |   | 3-2<br>G5-4-3<br>1B              |                              | 1-3<br>K                         |                               | 0-0<br>E6<br>2-3<br>G5-4-3       |                               | 0-3<br>K                         |                              | 4 0 1 0 0 2 4  |                              |                                 |                              |                                  |                               |                                  |                              |                                  |                                  |                                    |                                  |   |
| <b>Bobby Morgan, R</b> (1, 6)<br><small>OBP: 0.358, SLG: 0.382</small>   |   | 1-3<br>K                         |                              | 4-2<br>FC6-4<br>1-2<br>BB        |                               | 1-1<br>G5-4-3<br>1-2f            |                               | 2-2<br>HR<br>HBP                 |                              | 2 1 0 0 1 1 3  |                              |                                 |                              |                                  |                               |                                  |                              |                                  |                                  |                                    |                                  |   |
| <b>Roy Campanella, R</b> (1, 2)<br><small>OBP: 0.391, SLG: 0.623</small>   |   | 0-0<br>G5-4-3<br>1-2f            |                              | 3-2<br>F9                        |                               |                                  | 2-1<br>F5                     | 1-0<br>HR                        |                              | 4 1 1 4 0 0 3  |                              |                                 |                              |                                  |                               |                                  |                              |                                  |                                  |                                    |                                  |   |
| <b>Dan Bankhead, R</b> (1, 1)<br><small>OBP: 0.261, SLG: 0.273</small><br><b>Erv Palica, R</b> (7, 1)<br><small>OBP: 0.250, SLG: 0.250</small><br><b>Tommy Brown, R</b> (8, PH)<br><small>OBP: 0.286, SLG: 0.538</small><br><b>Joe Hatten, R</b> (8, 1)<br><small>OBP: 0.100, SLG: 0.100</small> |   |                                  | 0-1<br>FC3-6<br>1B           |                                  | 2-2<br>FC6-4<br>1-2f          |                                  | 2-1<br>1B                     | 0-1<br>F7                        |                              | 3 0 2 0 0 0 2<br>0 0 0 0 0 0 0<br>1 0 0 0 0 0 0<br>0 0 0 0 0 0 0 |                              |                                 |                              |                                  |                               |                                  |                              |                                  |                                  |                                    |                                  |   |
| <b>Inning Stats</b>  | R: 1<br>E: 0<br>K: 1<br>S: 11   | H: 2<br>LOB: 1<br>BB: 1<br>P: 18 | R: 0<br>E: 0<br>K: 1<br>S: 8 | H: 1<br>LOB: 0<br>BB: 0<br>P: 12 | R: 0<br>E: 0<br>K: 1<br>S: 15 | H: 2<br>LOB: 2<br>BB: 0<br>P: 18 | R: 0<br>E: 0<br>K: 1<br>S: 14 | H: 1<br>LOB: 2<br>BB: 1<br>P: 25 | R: 0<br>E: 0<br>K: 0<br>S: 9 | H: 0<br>LOB: 0<br>BB: 0<br>P: 13                                 | R: 0<br>E: 2<br>K: 0<br>S: 6 | H: 1<br>LOB: 1<br>BB: 0<br>P: 9 | R: 0<br>E: 0<br>K: 0<br>S: 9 | H: 1<br>LOB: 1<br>BB: 0<br>P: 16 | R: 4<br>E: 0<br>K: 2<br>S: 18 | H: 3<br>LOB: 0<br>BB: 0<br>P: 24 | R: 0<br>E: 0<br>K: 2<br>S: 9 | H: 1<br>LOB: 1<br>BB: 0<br>P: 10 | 1B: 7<br>2B: 2<br>3B: 1<br>HR: 2 | SF: 0<br>SAC: 0<br>DP: 2<br>HBP: 1 | WP: 0<br>PB: 0<br>SB: 1<br>CS: 0 | PA: 40  |
| <b>PITCHER</b>   | IP<br>WLS<br>BF<br>H<br>R<br>ER<br>SO<br>BB<br>IBB<br>HBP<br>BLK<br>WP<br>HR<br>S<br>P<br>ERA<br>WHIP |                                  |                              |                                  |                               |                                  |                               |                                  |                              |  |                              |                                 |                              |                                  |                               |                                  |                              |                                  |                                  |                                    | <b>PITCHER</b>                   | IP<br>WLS<br>BF<br>H<br>R<br>ER<br>SO<br>BB<br>IBB<br>HBP<br>BLK<br>WP<br>HR<br>S<br>P<br>ERA<br>WHIP |
| <b>Ewell Blackwell, R</b> (1, 1)<br><small>ERA: 3.16</small><br><b>Willie Ramsdell, R</b> (8, 1)<br><small>ERA: 4.04</small><br><b>Frank Smith, R</b> (8, 1)<br><small>ERA: 3.63</small>   | 7.0<br>W<br>29<br>8<br>1<br>1<br>4<br>2<br>0<br>0<br>0<br>0<br>1<br>72<br>111<br>1.29<br>1.429        |                                  |                              |                                  |                               |                                  |                               |                                  |                              |  |                              |                                 |                              |                                  |                               |                                  |                              |                                  |                                  |                                    |                                  |   |

**Brooklyn Dodgers @ Cincinnati Reds**  
 Crosley Field, Cincinnati, OH  
 Sun Jun 11 1950, 3:38 AM EDT  
 Att. 30,665 - Unknown

[livebaseballscorecards.com](http://livebaseballscorecards.com)

|            |    |
|------------|----|
| <b>AB</b>  | 37 |
| <b>R</b>   | 5  |
| <b>H</b>   | 12 |
| <b>RBI</b> | 5  |
| <b>BB</b>  | 2  |
| <b>SO</b>  | 8  |
| <b>LOB</b> | 22 |





| Batter  | 1  | 2 | 3              | 4 | 5 | 6 | 7               | 8     | 9 | AB | R | H | RBI | BB | SO | LOB |
|---|----|---|----------------|---|---|---|-----------------|-------|---|----|---|---|-----|----|----|-----|
| Grady Hatton, L<br>OBP: 0.328, SLG: 0.432 (1, 5)    | F8 |   | E 1B<br>1B     |   | K |   | 4-3<br>1B<br>BB | F4    |   | 4  | 2 | 1 | 0   | 1  | 1  | 1   |
| Bob Usher, R<br>OBP: 0.360, SLG: 0.451 (1, 8)       | K  |   | E7<br>1B<br>1B |   |   |   | 4-3<br>1B<br>1B |       |   | 5  | 2 | 4 | 0   | 0  | 1  | 0   |
| Johnny Wyrostek, L<br>OBP: 0.409, SLG: 0.465 (1, 9) |    |   |                |   |   |   | 4-3             | 4-3   |   | 4  | 0 | 1 | 3   | 1  | 0  | 5   |
| Ted Kluszewski, L<br>OBP: 0.336, SLG: 0.504 (1, 3)  | F6 |   | F7             |   |   |   | 4-3             | 4-3   |   | 4  | 1 | 1 | 2   | 0  | 0  | 2   |
| Danny Litwhiler, R<br>OBP: 0.338, SLG: 0.404 (1, 7) |    |   |                |   |   |   | 4-3             | 5-3   |   | 2  | 1 | 0 | 0   | 2  | 1  | 0   |
| Connie Ryan, R<br>OBP: 0.360, SLG: 0.386 (1, 4)     |    |   | L5             |   |   |   | F7              | F7    |   | 4  | 0 | 2 | 2   | 0  | 0  | 0   |
| Dixie Howell, R<br>OBP: 0.346, SLG: 0.265 (1, 2)    |    |   |                |   |   |   |                 |       |   | 3  | 0 | 1 | 0   | 0  | 2  | 2   |
| Herm Wehmeier, R<br>OBP: 0.258, SLG: 0.300 (7, PR)  |    |   |                |   |   |   |                 |       |   | 0  | 1 | 0 | 0   | 0  | 0  | 0   |
| Johnny Pramesa, R<br>OBP: 0.302, SLG: 0.388 (7, PH) |    |   |                |   |   |   |                 |       |   | 1  | 0 | 0 | 0   | 0  | 1  | 2   |
| Virgil Stallcup, R<br>OBP: 0.278, SLG: 0.379 (1, 6) |    |   | F2             |   |   |   | F7              | SH5-4 |   | 2  | 0 | 0 | 0   | 1  | 0  | 1   |
| Ewell Blackwell, R<br>OBP: 0.167, SLG: 0.091 (1, 1) |    |   |                |   |   |   |                 |       |   | 2  | 1 | 0 | 1   | 0  | 0  | 0   |
| Willie Ramsdell, R<br>OBP: 0.250, SLG: 0.250 (8, 1) |    |   | F9             |   |   |   |                 | SH    |   | 0  | 0 | 0 | 0   | 0  | 0  | 0   |
| Frank Smith, R<br>OBP: 0.200, SLG: 0.200 (8, 1)     |    |   |                |   |   |   |                 | SH    |   | 1  | 0 | 0 | 0   | 0  | 1  | 1   |

| Inning Stats | R: 0 | H: 0 | E: 0 | K: 1 | S: 12 | R: 0 | H: 0 | E: 0 | K: 2 | S: 10 | R: 2 | H: 3 | E: 1 | K: 0 | S: 11 | R: 0 | H: 1 | E: 0 | K: 1 | S: 10 | R: 0 | H: 1 | E: 0 | K: 1 | S: 8 | R: 0 | H: 0 | E: 0 | K: 0 | S: 6 | R: 6 | H: 4 | E: 0 | K: 1 | S: 16 | R: 0 | H: 1 | E: 0 | K: 1 | S: 10 | 1B: 9 | 2B: 2 | 3B: 0 | HR: 0 | SF: 0 | SAC: 2 | DP: 1 | HBP: 0 | WP: 0 | PB: 1 | SB: 0 | CS: 2 | PA: 39 |
|--------------|------|------|------|------|-------|------|------|------|------|-------|------|------|------|------|-------|------|------|------|------|-------|------|------|------|------|------|------|------|------|------|------|------|------|------|------|-------|------|------|------|------|-------|-------|-------|-------|-------|-------|--------|-------|--------|-------|-------|-------|-------|--------|
|--------------|------|------|------|------|-------|------|------|------|------|-------|------|------|------|------|-------|------|------|------|------|-------|------|------|------|------|------|------|------|------|------|------|------|------|------|------|-------|------|------|------|------|-------|-------|-------|-------|-------|-------|--------|-------|--------|-------|-------|-------|-------|--------|

| PITCHER                             | IP  | WLS | BF | H | R | ER | SO | BB | IBB | HBP | BLK | WP | HR | S  | P   | ERA   | WHIP  |
|-------------------------------------|-----|-----|----|---|---|----|----|----|-----|-----|-----|----|----|----|-----|-------|-------|
| Dan Bankhead, R<br>ERA: 4.17 (1, 1) | 6.1 | L   | 28 | 6 | 5 | 4  | 5  | 3  | 0   | 0   | 0   | 0  | 0  | 64 | 101 | 5.68  | 1.421 |
| Erv Palica, R<br>ERA: 5.96 (7, 1)   | 0.2 |     | 6  | 3 | 3 | 3  | 1  | 1  | 0   | 0   | 0   | 0  | 0  | 9  | 19  | 40.50 | 6.000 |
| Joe Hatten, L<br>ERA: 4.14 (8, 1)   | 1.0 |     | 5  | 1 | 0 | 0  | 1  | 1  | 0   | 0   | 0   | 0  | 0  | 10 | 20  | 0.00  | 2.000 |

**BOTTOM**

**Brooklyn Dodgers @ Cincinnati Reds**  
Crosley Field, Cincinnati, OH

Sun Jun 11 1950, 3:38 AM EDT  
Att. 30,665 - Unknown

|     |    |
|-----|----|
| AB  | 32 |
| R   | 8  |
| H   | 10 |
| RBI | 8  |
| BB  | 5  |
| SO  | 7  |
| LOB | 14 |



| Batter   | 1   | 2  | 3   | 4   | 5   | 6   | 7   | 8   | 9   | AB R H RBI BB SO LOB   | TOP  |
|--|---|--|---|---|---|---|---|---|---|--|--|
| <b>Peanuts Lowrey, R</b><br>OBP: 0.360, SLG: 0.327<br>(1, 7) X   | 0-0<br>4-3<br>1B  | 0-0<br>1B  |   | X<br>0-0<br>F8  |   |   | X<br>0-0<br>SH5-3<br>1-2  |   | X<br>0-0<br>F5  | 4 0 1 0 0 0 1  |  |
| <b>Bob Usher, R</b><br>OBP: 0.352, SLG: 0.448<br>(1, 8) X  | 0-0<br>1B<br>2B   | 0-0<br>F9  |   |   | X<br>0-0<br>5-3   |   | X<br>0-0<br>4-3<br>2-3  |   | X<br>0-0<br>F8  | 5 1 1 0 0 0 3  |  |
| <b>Johnny Wyrostek, L</b><br>OBP: 0.411, SLG: 0.460<br>(1, 9) B B B B  | 4-0<br>BB<br>1B<br>1B<br>BB   | 0-0<br>F9  |   |   | B B B B<br>4-0<br>BB  |   | X<br>0-0<br>F2  |   |   | 2 1 0 0 2 0 2  |  |
| <b>Ted Kluszewski, L</b><br>OBP: 0.340, SLG: 0.511<br>(1, 3) X   | 0-0<br>1B<br>1-2<br>2-H<br>FC4-6<br>1B  | 0-0<br>F7  |   |   | X<br>0-0<br>F4  |   |   | X<br>0-0<br>4-3<br>2B   |   | 4 1 2 1 0 0 2  |  |
| <b>Grady Hatton, L</b><br>OBP: 0.326, SLG: 0.424<br>(1, 5) B B B B   | 4-0<br>FC4-6<br>1-2<br>2-3<br>1B<br>BB  |  | X<br>0-0<br>F9  |   | X<br>0-0<br>F4  |   |   | X<br>0-0<br>4-3   |   | 3 0 0 0 1 0 2  |  |
| <b>Connie Ryan, R</b><br>OBP: 0.357, SLG: 0.381<br>(1, 4) X  | 0-0<br>FC4-6<br>1-2<br>2-3<br>3-H<br>1B   |  | X<br>0-0<br>F7  |   |   | X<br>0-0<br>F8  |   | X<br>0-0<br>4-3   |   | 4 0 1 1 0 0 1  |  |
| <b>Johnny Pramesa, R</b><br>OBP: 0.281, SLG: 0.358<br>(1, 2) X   | 0-0<br>FC4-6<br>BB<br>1-2r<br>2-3<br>3-H  |  | X<br>0-0<br>F6  |   |   | X<br>0-0<br>5-3   |   | X<br>0-0<br>F2  |   | 4 0 0 1 0 0 3  |  |
| <b>Virgil Stallcup, R</b><br>OBP: 0.280, SLG: 0.374<br><b>Bobby Adams, R</b><br>OBP: 0.326, SLG: 0.320<br>(1, 6) B B B B<br>(9, PH)  | 4-0<br>1-2<br>BB  |  |   | X<br>0-0<br>F2  |   | X<br>0-0<br>6-3   |   | X<br>0-0<br>1B  |   | 2 0 0 0 1 0 0<br>1 0 1 0 0 0 0   |  |
| <b>Willie Ramsdell, R</b><br>OBP: 0.211, SLG: 0.211<br><b>Howie Fox, R</b><br>OBP: 0.267, SLG: 0.333<br><b>Bob Scheffing, R</b><br>OBP: 0.240, SLG: 0.250<br>(1, 1) S S S S<br>(7, 1)<br>(9, PH) | 0-3<br>K  |  |   | X<br>0-0<br>F8  |   |   | X<br>0-0<br>E4<br>4-3 SH5-3                                     |   | X<br>0-0<br>F8  | 3 0 0 0 0 1 3<br>0 0 0 0 0 0 0<br>1 0 0 0 0 0 1                        |  |
| <b>Inning Stats</b>  | R: 3<br>E: 0<br>K: 1<br>S: 8<br>H: 3<br>LOB: 3<br>BB: 3<br>P: 20  | R: 0<br>E: 0<br>K: 0<br>S: 4<br>H: 1<br>LOB: 1<br>BB: 0<br>P: 4  | R: 0<br>E: 0<br>K: 0<br>S: 3<br>H: 0<br>LOB: 0<br>BB: 0<br>P: 3         | R: 0<br>E: 0<br>K: 0<br>S: 3<br>H: 0<br>LOB: 0<br>BB: 0<br>P: 3 | R: 0<br>E: 0<br>K: 0<br>S: 3<br>H: 0<br>LOB: 1<br>BB: 1<br>P: 7 | R: 0<br>E: 0<br>K: 0<br>S: 3<br>H: 0<br>LOB: 0<br>BB: 0<br>P: 3 | R: 0<br>E: 1<br>K: 0<br>S: 4<br>H: 0<br>LOB: 1<br>BB: 0<br>P: 4 | R: 0<br>E: 0<br>K: 0<br>S: 4<br>H: 1<br>LOB: 1<br>BB: 0<br>P: 4 | R: 0<br>E: 0<br>K: 0<br>S: 4<br>H: 1<br>LOB: 1<br>BB: 0<br>P: 4 | 1B: 4<br>2B: 2<br>3B: 0<br>HR: 0<br>SF: 0<br>SAC: 1<br>DP: 0<br>HBP: 0 | WP: 0<br>PB: 0<br>SB: 0<br>CS: 0<br>PA: 38 |
| <b>PITCHER</b><br><b>Bobby Hogue, R</b><br>ERA: 3.38<br>(1, 1)<br><b>Bob Chipman, L</b><br>ERA: 4.63<br>(1, 1)   | IP<br>0.2<br>WLS<br>W<br>BF<br>8<br>H<br>3<br>R<br>3<br>ER<br>3<br>SO<br>0<br>BB<br>3<br>IBB<br>0<br>HBP<br>0<br>BLK<br>0<br>WP<br>0<br>HR<br>0<br>S<br>5<br>P<br>17<br>ERA<br>40.50<br>WHIP<br>9.000 | IP<br>8.1<br>WLS<br>W<br>BF<br>30<br>H<br>3<br>R<br>0<br>ER<br>0<br>SO<br>1<br>BB<br>1<br>IBB<br>0<br>HBP<br>0<br>BLK<br>0<br>WP<br>0<br>HR<br>0<br>S<br>31<br>P<br>35<br>ERA<br>0.00<br>WHIP<br>0.480 | <b>PITCHER</b><br>IP WLS BF H R ER SO BB IBB HBP BLK WP HR S P ERA WHIP |   |   |   |   |   |   |  |  |

**Cincinnati Reds @ Boston Braves**  
 Braves Field, Boston, MA  
 Tue Jun 13 1950, 3:33 AM EDT  
 Att. 9,446 - Unknown

[livebaseballscorecards.com](http://livebaseballscorecards.com)

|            |           |
|------------|-----------|
| <b>AB</b>  | <b>33</b> |
| <b>R</b>   | <b>3</b>  |
| <b>H</b>   | <b>6</b>  |
| <b>RBI</b> | <b>3</b>  |
| <b>BB</b>  | <b>4</b>  |
| <b>SO</b>  | <b>1</b>  |
| <b>LOB</b> | <b>18</b> |



| Batter   | 1                            | 2                               | 3              | 4               | 5               | 6                               | 7                                 | 8                     | 9 |
|--|------------------------------|---------------------------------|----------------|-----------------|-----------------|---------------------------------|-----------------------------------|-----------------------|---|
| Roy Hartsfield, R<br>OBP: 0.438, SLG: 0.467<br>(1, 4) X          | 0-0<br>4-3<br>①              |                                 | 0-0<br>F7<br>② |                 |                 | 0-0<br>1B<br>2B<br>1B           | 0-0<br>FC4-6<br>②<br>1-2f         |                       |   |
| Sam Jethroe, S<br>OBP: 0.349, SLG: 0.486<br>(1, 8) X             | 0-0<br>PB<br>S<br>1B         |                                 | 0-0<br>F8<br>③ |                 |                 | 0-0<br>1-3<br>2B<br>1B          | 0-0<br>FC6-4<br>③<br>1-2f         |                       |   |
| Earl Torgeson, L<br>OBP: 0.409, SLG: 0.429<br>(1, 3) B<br>B<br>B | 4-0<br>1-2<br>PB<br>BB       |                                 |                | 0-0<br>F9<br>①  |                 | 0-0<br>1-H<br>3-H<br>1B<br>2B   |                                   | 0-0<br>HR             |   |
| Walker Cooper, R<br>OBP: 0.358, SLG: 0.521<br>(1, 2) X           | 0-0<br>F5<br>②               |                                 |                | 0-0<br>F4<br>②  |                 | 0-0<br>F5<br>①                  |                                   | 0-0<br>F3<br>①        |   |
| Sid Gordon, R<br>OBP: 0.429, SLG: 0.635<br>(1, 5) X              | 0-0<br>F9<br>③<br>1-2<br>2-3 |                                 |                | 0-0<br>2B       |                 | 0-0<br>G4-6-3<br>2-H<br>1B      |                                   | 0-0<br>G3<br>WP<br>1B |   |
| Tommy Holmes, L<br>OBP: 0.438, SLG: 0.544<br>(1, 9) X            |                              | 0-0<br>1-3<br>①                 |                | 0-0<br>4-3<br>③ |                 | 0-0<br>G4-6-3<br>②<br>③<br>1-2f |                                   | 0-0<br>G3<br>②<br>1-3 |   |
| Willard Marshall, L<br>OBP: 0.297, SLG: 0.329<br>(1, 7) X        |                              | 0-0<br>G6-4-3<br>1B             |                |                 | 0-0<br>4-3<br>① |                                 | 0-0<br>HR                         | 4-0<br>IBB            |   |
| Buddy Kerr, R<br>OBP: 0.264, SLG: 0.275<br>(1, 6) X              |                              | 0-0<br>G6-4-3<br>②<br>③<br>1-2f |                |                 | 0-0<br>F8<br>②  |                                 | 0-3<br>K<br>①<br>S: 6             | 0-0<br>5-3<br>③       |   |
| Bobby Hogue, R<br>OBP: 0.333, SLG: 0.667<br>(1, 1) X             |                              |                                 | 0-0<br>F7<br>① |                 |                 |                                 | 4-0<br>FC4-6<br>BB<br>B<br>B<br>B |                       |   |
| Bob Chipman, L<br>OBP: 0.333, SLG: 0.143<br>(1, 1) X             |                              |                                 |                |                 | 0-0<br>L8<br>③  |                                 |                                   |                       |   |

| Inning Stats | R: 0 | H: 1 | E: 0 | LOB: 2 | K: 0 | BB: 1 | S: 4 | P: 8  |
|--------------|------|------|------|--------|------|-------|------|-------|
|              | R: 0 | H: 1 | E: 0 | LOB: 0 | K: 0 | BB: 0 | S: 3 | P: 3  |
|              | R: 0 | H: 0 | E: 0 | LOB: 0 | K: 0 | BB: 0 | S: 3 | P: 3  |
|              | R: 0 | H: 1 | E: 0 | LOB: 1 | K: 0 | BB: 0 | S: 4 | P: 4  |
|              | R: 0 | H: 0 | E: 0 | LOB: 0 | K: 0 | BB: 0 | S: 3 | P: 3  |
|              | R: 3 | H: 4 | E: 0 | LOB: 0 | K: 0 | BB: 0 | S: 6 | P: 6  |
|              | R: 1 | H: 1 | E: 0 | LOB: 1 | K: 1 | BB: 1 | S: 6 | P: 10 |
|              | R: 1 | H: 2 | E: 0 | LOB: 2 | K: 0 | BB: 1 | S: 5 | P: 9  |

| AB | R | H | RBI | BB | SO | LOB |
|----|---|---|-----|----|----|-----|
| 4  | 1 | 1 | 0   | 0  | 0  | 1   |
| 4  | 1 | 2 | 0   | 0  | 0  | 1   |
| 3  | 2 | 2 | 3   | 1  | 0  | 0   |
| 4  | 0 | 0 | 0   | 0  | 0  | 3   |
| 4  | 0 | 3 | 1   | 0  | 0  | 2   |
| 4  | 0 | 0 | 0   | 0  | 0  | 3   |
| 3  | 1 | 2 | 1   | 1  | 0  | 0   |
| 4  | 0 | 0 | 0   | 0  | 1  | 3   |
| 0  | 0 | 0 | 0   | 0  | 0  | 0   |
| 2  | 0 | 0 | 0   | 1  | 0  | 0   |

| PITCHER                                   | IP  | WLS | BF | H | R | ER | SO | BB | IBB | HBP | BLK | WP | HR | S  | P  | ERA  | WHIP  |
|---|-----|-----|----|---|---|----|----|----|-----|-----|-----|----|----|----|----|------|-------|
| Willie Ramsdell, R<br>ERA: 4.28<br>(1, 1) | 6.0 | L   | 25 | 8 | 4 | 4  | 0  | 1  | 0   | 0   | 0   | 0  | 1  | 24 | 28 | 6.00 | 1.500 |
| Howie Fox, R<br>ERA: 5.67<br>(7, 1)       | 2.0 |     | 10 | 2 | 1 | 1  | 1  | 1  | 1   | 0   | 0   | 1  | 1  | 10 | 18 | 4.50 | 1.500 |

**BOTTOM**

**Cincinnati Reds @ Boston Braves**  
 Braves Field, Boston, MA  
 Tue Jun 13 1950, 3:33 AM EDT  
 Att. 9,446 - Unknown

|     |    |
|-----|----|
| AB  | 32 |
| R   | 5  |
| H   | 10 |
| RBI | 5  |
| BB  | 3  |
| SO  | 1  |
| LOB | 13 |

livebaseballscorecards.com

WP: 1 PA: 35  
 PB: 1  
 SB: 2  
 CS: 0



| Batter   | 1                            | 2                               | 3                            | 4                               | 5                            | 6                               | 7                            | 8                               | 9                            | AB R H RBI BB SO LOB            | TOP   |                                  |                              |                                 |                              |                                 |                              |                                 |                                  |                                    |                                  |        |         |           |          |          |        |        |         |         |         |          |          |          |         |         |         |         |             |               |
|--|------------------------------|---------------------------------|------------------------------|---------------------------------|------------------------------|---------------------------------|------------------------------|---------------------------------|------------------------------|---------------------------------|---|----------------------------------|------------------------------|---------------------------------|------------------------------|---------------------------------|------------------------------|---------------------------------|----------------------------------|------------------------------------|----------------------------------|--------|---------|-----------|----------|----------|--------|--------|---------|---------|---------|----------|----------|----------|---------|---------|---------|---------|-------------|---------------|
| <b>Peanuts Lowrey, R</b> (1, 7)<br>OBP: 0.372, SLG: 0.342    | 0-0<br>G3<br>1B              |                                 | 0-0<br>L6                    |                                 |                              | 0-0<br>1B<br>2B                 | 0-0<br>FC5-4<br>1B           |                                 |                              | 4 2 3 0 0 0 0                   | <b>Cincinnati Reds @ Boston Braves</b><br>Braves Field, Boston, MA<br>Thu Jun 15 1950, 3:33 AM EDT<br>Unknown<br><a href="http://livebaseballscorecards.com">livebaseballscorecards.com</a> |                                  |                              |                                 |                              |                                 |                              |                                 |                                  |                                    |                                  |        |         |           |          |          |        |        |         |         |         |          |          |          |         |         |         |         |             |               |
| <b>Bob Usher, R</b> (1, 8)<br>OBP: 0.339, SLG: 0.430         | 0-0<br>G3<br>1-2             |                                 | 0-0<br>F8                    |                                 |                              | 0-0<br>F7                       | 0-0<br>FC5-4<br>1-2f         |                                 |                              | 4 0 0 0 0 0 3                   |   |                                  |                              |                                 |                              |                                 |                              |                                 |                                  |                                    |                                  |        |         |           |          |          |        |        |         |         |         |          |          |          |         |         |         |         |             |               |
| <b>Johnny Wyrostek, L</b> (1, 9)<br>OBP: 0.407, SLG: 0.455   | 0-0<br>1-3                   |                                 |                              | 0-3<br>K                        |                              | 0-0<br>2B<br>1B                 |                              | 0-0<br>F8                       |                              | 4 1 1 0 0 1 1                   |   |                                  |                              |                                 |                              |                                 |                              |                                 |                                  |                                    |                                  |        |         |           |          |          |        |        |         |         |         |          |          |          |         |         |         |         |             |               |
| <b>Bob Scheffing, R</b> (1, 2)<br>OBP: 0.276, SLG: 0.259     | 0-0<br>FC4-6<br>2-H<br>1B    |                                 |                              | 0-0<br>F8                       |                              | 4-0<br>2B<br>IBB                |                              | 0-0<br>F9                       |                              | 3 0 1 1 1 0 0                   |   |                                  |                              |                                 |                              |                                 |                              |                                 |                                  |                                    |                                  |        |         |           |          |          |        |        |         |         |         |          |          |          |         |         |         |         |             |               |
| <b>Ted Kluszewski, L</b> (1, 3)<br>OBP: 0.338, SLG: 0.500    | 0-0<br>FC4-6<br>1-2f         |                                 |                              | 0-0<br>G3                       |                              | 0-3<br>K                        |                              | 4-0<br>BB                       |                              | 3 0 0 0 1 1 4                   |   |                                  |                              |                                 |                              |                                 |                              |                                 |                                  |                                    |                                  |        |         |           |          |          |        |        |         |         |         |          |          |          |         |         |         |         |             |               |
| <b>Connie Ryan, R</b> (1, 4)<br>OBP: 0.354, SLG: 0.385       |                              | 0-3<br>K                        |                              | 0-0<br>F2                       |                              | 0-0<br>2B                       |                              | 0-0<br>F9                       |                              | 4 0 1 2 0 1 1                   |   |                                  |                              |                                 |                              |                                 |                              |                                 |                                  |                                    |                                  |        |         |           |          |          |        |        |         |         |         |          |          |          |         |         |         |         |             |               |
| <b>Grady Hatton, L</b> (1, 5)<br>OBP: 0.326, SLG: 0.419      |                              | 0-3<br>K                        |                              | 4-0<br>BB                       |                              | 0-3<br>K                        |                              | 0-0<br>4-3                      |                              | 2 0 0 0 1 2 2                   |   |                                  |                              |                                 |                              |                                 |                              |                                 |                                  |                                    |                                  |        |         |           |          |          |        |        |         |         |         |          |          |          |         |         |         |         |             |               |
| <b>Bobby Adams, R</b> (9, PH)<br>OBP: 0.324, SLG: 0.317      |                              | 0-3<br>K                        |                              |                                 |                              |                                 |                              |                                 |                              | 1 0 0 0 0 0 0                   |   |                                  |                              |                                 |                              |                                 |                              |                                 |                                  |                                    |                                  |        |         |           |          |          |        |        |         |         |         |          |          |          |         |         |         |         |             |               |
| <b>Virgil Stallcup, R</b> (1, 6)<br>OBP: 0.273, SLG: 0.365   |                              | 0-3<br>K                        |                              | 0-0<br>F6                       |                              |                                 | 0-0<br>1-3                   |                                 | 0-0<br>5-3                   | 4 0 0 0 0 1 1                   |   |                                  |                              |                                 |                              |                                 |                              |                                 |                                  |                                    |                                  |        |         |           |          |          |        |        |         |         |         |          |          |          |         |         |         |         |             |               |
| <b>Ken Raffensberger, R</b> (1, 1)<br>OBP: 0.265, SLG: 0.258 |                              |                                 | 0-0<br>F8                    |                                 | 0-3<br>K                     |                                 | 0-0<br>F7                    |                                 | 0-0<br>F9                    | 3 0 0 0 0 1 1                   |   |                                  |                              |                                 |                              |                                 |                              |                                 |                                  |                                    |                                  |        |         |           |          |          |        |        |         |         |         |          |          |          |         |         |         |         |             |               |
| <b>Joe Adcock, R</b> (9, PH)<br>OBP: 0.200, SLG: 0.186       |                              |                                 |                              |                                 |                              |                                 |                              |                                 |                              | 1 0 0 0 0 0 0                   |   |                                  |                              |                                 |                              |                                 |                              |                                 |                                  |                                    |                                  |        |         |           |          |          |        |        |         |         |         |          |          |          |         |         |         |         |             |               |
| <b>Inning Stats</b>  | R: 1<br>E: 0<br>K: 0<br>S: 5 | H: 2<br>LOB: 1<br>BB: 0<br>P: 5 | R: 0<br>E: 0<br>K: 3<br>S: 9 | H: 0<br>LOB: 0<br>BB: 0<br>P: 9 | R: 0<br>E: 0<br>K: 0<br>S: 3 | H: 0<br>LOB: 0<br>BB: 0<br>P: 3 | R: 0<br>E: 0<br>K: 1<br>S: 5 | H: 0<br>LOB: 0<br>BB: 0<br>P: 5 | R: 0<br>E: 0<br>K: 1<br>S: 5 | H: 0<br>LOB: 1<br>BB: 1<br>P: 9 | R: 2<br>E: 0<br>K: 2<br>S: 10   | H: 3<br>LOB: 2<br>BB: 1<br>P: 14 | R: 0<br>E: 0<br>K: 0<br>S: 4 | H: 1<br>LOB: 1<br>BB: 0<br>P: 4 | R: 0<br>E: 0<br>K: 0<br>S: 3 | H: 0<br>LOB: 1<br>BB: 1<br>P: 7 | R: 0<br>E: 0<br>K: 0<br>S: 3 | H: 0<br>LOB: 0<br>BB: 0<br>P: 3 | 1B: 5<br>2B: 1<br>3B: 0<br>HR: 0 | SF: 0<br>SAC: 0<br>DP: 0<br>HBP: 0 | WP: 0<br>PB: 0<br>SB: 0<br>CS: 0 | PA: 36 |         |           |          |          |        |        |         |         |         |          |          |          |         |         |         |         |             |               |
| <b>PITCHER</b><br><b>Warren Spahn, L</b> (1, 1)<br>ERA: 3.23 | IP<br>9.0                    | WLS<br>W                        | BF<br>36                     | H<br>6                          | R<br>3                       | ER<br>3                         | SO<br>7                      | BB<br>2                         | IBB<br>1                     | HBP<br>0                        | BLK<br>0  | WP<br>0                          | HR<br>0                      | S<br>47                         | P<br>59                      | ERA<br>3.00                     | WHIP<br>0.889                |                                 |                                  |                                    |                                  |        | PITCHER | IP<br>9.0 | WLS<br>W | BF<br>36 | H<br>6 | R<br>3 | ER<br>3 | SO<br>7 | BB<br>2 | IBB<br>1 | HBP<br>0 | BLK<br>0 | WP<br>0 | HR<br>0 | S<br>47 | P<br>59 | ERA<br>3.00 | WHIP<br>0.889 |





| Batter   | 1   | 2   | 3                            | 4                               | 5                            | 6                               | 7                            | 8                               | 9                            | 10                              | AB R H RBI BB SO LOB         | TOP  |   |                                  |                              |                                 |                              |                                 |                                  |                                    |                                  |        |   |   |
|--|---|---|------------------------------|---------------------------------|------------------------------|---------------------------------|------------------------------|---------------------------------|------------------------------|---------------------------------|------------------------------|--|---|----------------------------------|------------------------------|---------------------------------|------------------------------|---------------------------------|----------------------------------|------------------------------------|----------------------------------|--------|---|---|
| <b>Peanuts Lowrey, R</b> (1, 7)<br>OBP: 0.366, SLG: 0.330  | 0-0<br>6-3  |   | 0-0<br>5-3                   |                                 | 0-0<br>F6                    |                                 | 4-0<br>1B<br>1-2<br>BB       |                                 | 0-0<br>F7                    |                                 | 4 0 0 0 1 0 0                | <b>Cincinnati Reds @ Boston Braves</b><br>Braves Field, Boston, MA<br>Thu Jun 15 1950, 3:38 AM EDT<br>Att: 6,932 - Unknown |   |                                  |                              |                                 |                              |                                 |                                  |                                    |                                  |        |   |   |
| <b>Bob Usher, R</b> (1, 8)<br>OBP: 0.333, SLG: 0.413       | 4-0<br>1B<br>BB   |   | 0-0<br>6-3                   |                                 | 0-0<br>6-3                   |                                 | 0-0<br>F7                    |                                 | 0-0<br>4-3                   |                                 | 4 1 0 0 1 0 2                |  |   |                                  |                              |                                 |                              |                                 |                                  |                                    |                                  |        |   |   |
| <b>Johnny Wyrostek, L</b> (1, 9)<br>OBP: 0.412, SLG: 0.462 | 4-0<br>1B<br>1-2<br>BB  |   | 0-0<br>2B                    |                                 | 0-0<br>F9                    |                                 | 0-0<br>1-2<br>2-H<br>1B      |                                 | 0-0<br>4-3                   |                                 | 4 1 2 1 1 0 0                |  |   |                                  |                              |                                 |                              |                                 |                                  |                                    |                                  |        |   |   |
| <b>Ted Kluszewski, L</b> (1, 3)<br>OBP: 0.346, SLG: 0.531  | 0-0<br>1-2<br>2-H<br>1B   |   | 0-0<br>1B<br>2B              |                                 | 0-0<br>HR                    |                                 | 0-0<br>4-3                   |                                 | 0-0<br>F9                    |                                 | 5 2 3 3 0 0 2                |  |   |                                  |                              |                                 |                              |                                 |                                  |                                    |                                  |        |   |   |
| <b>Grady Hatton, L</b> (1, 5)<br>OBP: 0.328, SLG: 0.415    | 0-0<br>F7   |   | 0-0<br>2-H<br>1B             |                                 | 0-0<br>4-3                   |                                 | 4-0<br>2B<br>G1-2-3<br>BB    |                                 | 0-0<br>F5                    |                                 | 4 0 1 1 1 0 2                |  |   |                                  |                              |                                 |                              |                                 |                                  |                                    |                                  |        |   |   |
| <b>Connie Ryan, R</b> (1, 4)<br>OBP: 0.356, SLG: 0.389     | 0-3<br>K  |   | 0-0<br>F6                    |                                 | 0-0<br>F9                    |                                 | 0-0<br>1-3<br>2B             |                                 | 4-0<br>CS<br>BB              |                                 | 4 0 1 0 1 1 3                |  |   |                                  |                              |                                 |                              |                                 |                                  |                                    |                                  |        |   |   |
| <b>Virgil Stallcup, R</b> (1, 6)<br>OBP: 0.266, SLG: 0.356 |   | 0-0<br>F2   |                              | 0-0<br>5-3                      |                              | 0-0<br>6-3                      |                              | 0-0<br>1-3                      |                              | 0-0<br>CS                       | 4 0 0 0 0 0 2                |  |   |                                  |                              |                                 |                              |                                 |                                  |                                    |                                  |        |   |   |
| <b>Dixie Howell, R</b> (1, 2)<br>OBP: 0.346, SLG: 0.268    |   | 0-0<br>F4   |                              | 0-0<br>F5                       |                              | 0-0<br>FC3-6<br>1B              |                              | 4-0<br>BB                       |                              |                                 | 3 0 1 0 0 0 0                |  |   |                                  |                              |                                 |                              |                                 |                                  |                                    |                                  |        |   |   |
| <b>Lloyd Merriman, L</b> (7, PR)<br>OBP: 0.388, SLG: 0.424 |   |   |                              |                                 |                              |                                 |                              |                                 |                              |                                 | 0 0 0 0 0 0 0                |  |   |                                  |                              |                                 |                              |                                 |                                  |                                    |                                  |        |   |   |
| <b>Bob Scheffing, R</b> (7, 2)<br>OBP: 0.300, SLG: 0.259   |   |   |                              |                                 |                              |                                 |                              |                                 |                              |                                 | 0 0 0 0 1 0 0                |  |   |                                  |                              |                                 |                              |                                 |                                  |                                    |                                  |        |   |   |
| <b>Herm Wehmeier, R</b> (1, 1)<br>OBP: 0.258, SLG: 0.300   |   | 0-0<br>4-3  |                              | 0-3<br>K                        |                              | 0-0<br>FC3-6<br>1B              |                              | 0-0<br>G1-2-3                   |                              |                                 | 0 0 0 0 0 0 0                |  |   |                                  |                              |                                 |                              |                                 |                                  |                                    |                                  |        |   |   |
| <b>Frank Smith, R</b> (1, 1)<br>OBP: 0.111, SLG: 0.111     |   |   |                              |                                 |                              |                                 |                              |                                 |                              |                                 | 4 1 0 0 0 1 4                |  |   |                                  |                              |                                 |                              |                                 |                                  |                                    |                                  |        |   |   |
| <b>Inning Stats</b>  | R: 1<br>E: 0<br>K: 1<br>S: 6  | H: 1<br>LOB: 2<br>BB: 2<br>P: 14  | R: 0<br>E: 0<br>K: 0<br>S: 3 | H: 0<br>LOB: 0<br>BB: 0<br>P: 3 | R: 2<br>E: 0<br>K: 0<br>S: 6 | H: 3<br>LOB: 1<br>BB: 0<br>P: 6 | R: 0<br>E: 0<br>K: 1<br>S: 5 | H: 0<br>LOB: 0<br>BB: 0<br>P: 5 | R: 0<br>E: 0<br>K: 0<br>S: 3 | H: 1<br>LOB: 0<br>BB: 0<br>P: 4 | R: 1<br>E: 0<br>K: 0<br>S: 5 | H: 2<br>LOB: 2<br>BB: 1<br>P: 9  | R: 0<br>E: 0<br>K: 0<br>S: 3  | H: 1<br>LOB: 2<br>BB: 2<br>P: 11 | R: 0<br>E: 0<br>K: 0<br>S: 3 | H: 0<br>LOB: 0<br>BB: 0<br>P: 3 | R: 0<br>E: 0<br>K: 0<br>S: 2 | H: 0<br>LOB: 0<br>BB: 1<br>P: 6 | 1B: 4<br>2B: 3<br>3B: 0<br>HR: 1 | SF: 0<br>SAC: 0<br>DP: 1<br>HBP: 0 | WP: 0<br>PB: 0<br>SB: 0<br>CS: 1 | PA: 43 |   |   |
| <b>PITCHER</b>   | IP<br>WLS<br>BF<br>H<br>R<br>ER<br>SO<br>BB<br>IBB<br>HBP<br>BLK<br>WP<br>HR<br>S<br>P<br>ERA<br>WHIP | IP<br>WLS<br>BF<br>H<br>R<br>ER<br>SO<br>BB<br>IBB<br>HBP<br>BLK<br>WP<br>HR<br>S<br>P<br>ERA<br>WHIP |                              |                                 |                              |                                 |                              |                                 |                              |                                 |                              |  | IP<br>WLS<br>BF<br>H<br>R<br>ER<br>SO<br>BB<br>IBB<br>HBP<br>BLK<br>WP<br>HR<br>S<br>P<br>ERA<br>WHIP |                                  |                              |                                 |                              |                                 |                                  |                                    |                                  |        |   |   |
| <b>Vern Bickford, R</b> (1, 1)<br>ERA: 3.53                | 7.0   |   |                              |                                 |                              |                                 |                              |                                 |                              |                                 |                              |  |   |                                  |                              |                                 |                              |                                 |                                  |                                    |                                  |        |   |   |
| <b>Bobby Hogue, R</b> (8, 1)<br>ERA: 2.96                  | 3.0   | W   | 10                           | 1                               | 0                            | 0                               | 0                            | 2                               | 0                            | 0                               | 0                            | 0  | 0   | 0                                | 0                            | 0                               | 0                            | 0                               | 0                                | 0                                  | 0                                | 0      | 0 | 0 |

livebaseballscorecards.com

AB 36  
R 5  
H 8  
RBI 5  
BB 6  
SO 2  
LOB 15



| Batter  | 1                                     | 2                   | 3                     | 4               | 5                | 6          | 7                  | 8                   | 9             | 10                               | AB R H RBI BB SO LOB           |
|---|---------------------------------------|---------------------|-----------------------|-----------------|------------------|------------|--------------------|---------------------|---------------|----------------------------------|--------------------------------|
| Roy Hartsfeld, R<br>OBP: 0.346, SLG: 0.333 (1, 4)       | 0-0<br>F4                             | 0-0<br>HBP<br>1B    |                       | 0-3<br>K        |                  |            | 0-0<br>F3          |                     | 0-0<br>F5     |                                  | 5 0 1 0 0 1 0                  |
| Sam Jethroe, S<br>OBP: 0.353, SLG: 0.482 (1, 8)         | 1-0<br>BB<br>1B<br>HBP                | 0-0<br>F8           |                       | 0-0<br>F5       |                  |            | 0-0<br>S<br>1B     |                     | 0-0<br>F3     |                                  | 4 1 1 0 0 0 1                  |
| Earl Torgeson, L<br>OBP: 0.415, SLG: 0.429 (1, 3)       | 4-0<br>1B<br>1-2<br>BLK<br>BB         | 0-0<br>F8           |                       |                 | 0-0<br>BLK<br>1B |            | 0-0<br>F8<br>1-2   |                     |               | 4-0<br>FC3-6<br>BB               | 3 1 1 0 2 0 2                  |
| Walker Cooper, R<br>OBP: 0.350, SLG: 0.500 (1, 2)       | 0-0<br>F8                             | 1-0<br>FC6-3<br>HBP |                       | 0-3<br>K<br>1-2 |                  |            | 0-0<br>F6          |                     |               | 0-0<br>FC3-6<br>BB<br>1-2f<br>1B | 4 1 0 0 0 1 5                  |
| Sid Gordon, R<br>OBP: 0.438, SLG: 0.664 (1, 5)          | 0-0<br>BB<br>1B<br>1-3<br>2-H         | 0-0<br>FC6-3        |                       | 0-0<br>F7       |                  |            | 0-0<br>E6<br>SH3-4 |                     |               | 4-0<br>1B<br>1-2<br>BB           | 4 1 1 1 0 0 3<br>0 0 0 0 1 0 0 |
| Sibby Sisti, R<br>OBP: 0.263, SLG: 0.129 (8, PR) (9, 5) |                                       |                     |                       |                 |                  |            |                    |                     |               |                                  |                                |
| Tommy Holmes, L<br>OBP: 0.431, SLG: 0.516 (1, 9)        | 4-0<br>BB<br>1B<br>1-2<br>3-H         |                     | 0-0<br>F9             |                 | 0-0<br>F8        |            | 0-0<br>SH3-4       |                     | 0-0<br>SH3-4  | 0-0<br>1B<br>1-2<br>2-H          | 3 1 1 1 1 0 1                  |
| Willard Marshall, L<br>OBP: 0.304, SLG: 0.323 (1, 7)    | 4-0<br>1B<br>1-2<br>2-3<br>BLK<br>BB  |                     | 4-0<br>G6-4-3<br>BB   |                 |                  | 0-0<br>F4  |                    | 4-0<br>G6-4-3<br>BB |               |                                  | 1 1 0 0 3 0 0                  |
| Buddy Kerr, R<br>OBP: 0.269, SLG: 0.285 (1, 6)          | 0-0<br>BLK<br>1B<br>1-3<br>2-H<br>3-H |                     | 0-0<br>G6-4-3<br>1-2f |                 | 0-3<br>K         |            | 0-3<br>G6-4-3      |                     | 0-0<br>G6-4-3 |                                  | 4 0 1 2 0 1 3                  |
| Vern Bickford, R<br>OBP: 0.171, SLG: 0.105 (1, 1)       | 0-0<br>F7                             |                     |                       | 0-0<br>F2       |                  |            |                    |                     | 0-0<br>6-3    |                                  | 3 0 0 0 0 0 1                  |
| Bobby Hogue, R<br>OBP: 0.250, SLG: 0.500 (8, 1)         | 1-2<br>3-H                            |                     |                       |                 |                  | 0-0<br>6-3 |                    |                     |               |                                  | 1 0 0 0 0 0 0                  |

**BOTTOM**

**Cincinnati Reds @ Boston Braves**  
 Braves Field, Boston, MA  
 Thu Jun 15 1950, 3:38 AM EDT  
 Att. 6,932 - Unknown

|     |    |
|-----|----|
| AB  | 32 |
| R   | 6  |
| H   | 6  |
| RBI | 4  |
| BB  | 7  |
| SO  | 3  |
| LOB | 16 |



| Inning Stats                         | R: 5 | H: 2 | E: 0 | K: 0 | S: 5 | P: 18 | R: 0 | H: 1 | E: 0 | K: 0 | S: 4 | P: 5 | R: 0 | H: 0 | E: 0 | K: 1  | S: 5  | R: 0 | H: 1 | E: 0 | K: 1 | S: 6 | P: 6 | R: 0 | H: 0 | E: 0 | K: 1 | S: 5 | R: 0 | H: 1 | E: 0 | K: 0 | S: 4 | P: 4 | R: 0 | H: 0 | E: 1 | K: 0 | S: 3 | P: 7 | R: 0 | H: 0 | E: 0 | K: 0 | S: 3 | P: 3 | R: 1 | H: 1 | E: 0 | K: 0 | S: 2 | P: 10 | 1B: 6 | SF: 0 | 2B: 0 | SAC: 1 | 3B: 0 | DP: 2 | HR: 0 | HBP: 2 | WP: 0 | PA: 42 |
|--------------------------------------|------|------|------|------|------|-------|------|------|------|------|------|------|------|------|------|-------|-------|------|------|------|------|------|------|------|------|------|------|------|------|------|------|------|------|------|------|------|------|------|------|------|------|------|------|------|------|------|------|------|------|------|------|-------|-------|-------|-------|--------|-------|-------|-------|--------|-------|--------|
| PITCHER                              | IP   | WLS  | BF   | H    | R    | ER    | SO   | BB   | IBB  | HBP  | BLK  | WP   | HR   | S    | P    | ERA   | WHIP  |      |      |      |      |      |      |      |      |      |      |      |      |      |      |      |      |      |      |      |      |      |      |      |      |      |      |      |      |      |      |      |      |      |      |       |       |       |       |        |       |       |       |        |       |        |
| Herm Wehmeier, R<br>ERA: 7.27 (1, 1) | 0.2  |      | 8    | 2    | 5    | 5     | 0    | 3    | 0    | 1    | 1    | 0    | 0    | 4    | 17   | 67.50 | 7.500 |      |      |      |      |      |      |      |      |      |      |      |      |      |      |      |      |      |      |      |      |      |      |      |      |      |      |      |      |      |      |      |      |      |      |       |       |       |       |        |       |       |       |        |       |        |
| Frank Smith, R<br>ERA: 2.9 (1, 1)    | 8.2  | L    | 34   | 4    | 1    | 1     | 3    | 4    | 0    | 1    | 2    | 0    | 0    | 35   | 52   | 1.04  | 0.923 |      |      |      |      |      |      |      |      |      |      |      |      |      |      |      |      |      |      |      |      |      |      |      |      |      |      |      |      |      |      |      |      |      |      |       |       |       |       |        |       |       |       |        |       |        |

| Batter   | 1  | 2   | 3   | 4   | 5   | 6   | 7   | 8   | 9   | AB R H RBI BB SO LOB   | TOP  |
|--|--|---|---|---|---|---|---|---|---|--|--|
| Grady Hatton, L (1, 5)<br>OBP: 0.332, SLG: 0.417   | 0-0<br>F8  |   | 0-0<br>L6-3<br>1B   |   | 0-0<br>FC6-4<br>1B  |   |   | 0-3<br>K  |   | 4 0 2 0 0 1 1  | <b>Cincinnati Reds @ Philadelphia Phillies</b><br>Shibe Park, Philadelphia, PA<br>Sat Jun 17 1950, 3:33 AM EDT<br>Att. 7,669 - Unknown<br><a href="http://livebaseballscorecards.com">livebaseballscorecards.com</a> |
| Peanuts Lowrey, R (1, 7)<br>OBP: 0.370, SLG: 0.336   | 0-0<br>HR<br>1B  |   | 0-0<br>L6-3<br>1-2  |   | 0-0<br>FC6-4<br>1-2f  |   |   | 0-0<br>FC4-6<br>1-2<br>1B                                       |   | 4 1 2 0 0 0 2  |  |
| Johnny Wyrostek, L (1, 9)<br>OBP: 0.414, SLG: 0.480  | 0-0<br>1-H<br>HR   |   | 0-0<br>1B   |   | 0-0<br>F5   |   |   | 0-0<br>FC4-6<br>1-2f<br>2-3                                     |   | 4 1 2 2 0 0 2  |  |
| Ted Kluszewski, L (1, 3)<br>OBP: 0.338, SLG: 0.517   | 0-0<br>4-3   |   | 0-3<br>K  |   | 0-3<br>K  |   |   | 0-3<br>K  |   | 4 0 0 0 0 3 3  |  |
| Bob Scheffing, R (1, 2)<br>OBP: 0.294, SLG: 0.258  | 0-0<br>1B<br>1B  |   |   | 0-0<br>4-3  |   | 0-0<br>P6   |   |   | 0-0<br>6-3  | 4 0 1 0 0 0 0  |  |
| Connie Ryan, R (1, 4)<br>OBP: 0.359, SLG: 0.388  | 0-0<br>1-3<br>1B   |   |   | 0-0<br>6-3  |   |   | 0-3<br>K  | B<br>B<br>B<br>B<br>4-0<br>G6-4-3<br>BB                         |   | 3 0 1 0 1 1 0  |  |
| Bob Usher, R (1, 8)<br>OBP: 0.322, SLG: 0.398  |  | 0-0<br>5-3  |   | 0-0<br>F9   |   |   | 0-0<br>F4   | X<br>0-0<br>G6-4-3<br>1-2f                                      |   | 4 0 0 0 0 0 1  |  |
| Virgil Stallcup, R (1, 6)<br>OBP: 0.262, SLG: 0.349  |  | 0-0<br>1-3  |   |   | 0-0<br>5-3  |   | 0-0<br>F8   |   |   | 3 0 0 0 0 0 0  |  |
| Ewell Blackwell, R (1, 1)<br>OBP: 0.154, SLG: 0.083<br>Harry Perkowski, L (8, PH)<br>OBP: 0.444, SLG: 0.444 (8, 1) |  | 0-0<br>F4   |   |   | 0-3<br>K  |   |   | 0-0<br>FC4-6<br>1B<br>1B  |   | 2 0 0 0 0 1 0<br>1 0 1 0 0 0 0   |  |
| <b>Inning Stats</b>  | R: 2<br>E: 0<br>K: 0<br>S: 6<br>H: 4<br>LOB: 2<br>BB: 0<br>P: 6  | R: 0<br>E: 0<br>K: 0<br>S: 3<br>H: 0<br>LOB: 0<br>BB: 0<br>P: 3 | R: 0<br>E: 0<br>K: 1<br>S: 6<br>H: 2<br>LOB: 1<br>BB: 0<br>P: 6 | R: 0<br>E: 0<br>K: 0<br>S: 3<br>H: 0<br>LOB: 0<br>BB: 0<br>P: 3 | R: 0<br>E: 0<br>K: 1<br>S: 6<br>H: 1<br>LOB: 1<br>BB: 0<br>P: 6 | R: 0<br>E: 0<br>K: 1<br>S: 5<br>H: 0<br>LOB: 0<br>BB: 0<br>P: 5 | R: 0<br>E: 0<br>K: 1<br>S: 5<br>H: 0<br>LOB: 0<br>BB: 0<br>P: 5 | R: 0<br>E: 0<br>K: 2<br>S: 9<br>H: 2<br>LOB: 2<br>BB: 0<br>P: 9 | R: 0<br>E: 0<br>K: 0<br>S: 2<br>H: 0<br>LOB: 0<br>BB: 1<br>P: 6   | 1B: 8<br>2B: 1<br>3B: 0<br>HR: 1<br>SF: 0<br>SAC: 0<br>DP: 2<br>HBP: 0 | WP: 0<br>PB: 0<br>SB: 0<br>CS: 0<br>PA: 34   |
| <b>PITCHER</b><br>Robin Roberts, R (1, 1)<br>ERA: 3.22   | IP: 9.0<br>WLS: W<br>BF: 34<br>H: 9<br>R: 2<br>ER: 2<br>SO: 6<br>BB: 1<br>IBB: 0<br>HBP: 0<br>BLK: 0<br>WP: 0<br>HR: 1<br>S: 45<br>P: 49<br>ERA: 2.00<br>WHIP: 1.111 |   |   |   |   |   |   | <b>PITCHER</b>  | IP: 0.0<br>WLS: 0<br>BF: 0<br>H: 0<br>R: 0<br>ER: 0<br>SO: 0<br>BB: 0<br>IBB: 0<br>HBP: 0<br>BLK: 0<br>WP: 0<br>HR: 0<br>S: 0<br>P: 0<br>ERA: 0.00<br>WHIP: 0.000 |  |  |





| Batter  | 1                  | 2                  | 3               | 4                       | 5          | 6          | 7                  | 8                   | 9 | AB | R | H | RBI | BB | SO | LOB |
|---|--------------------|--------------------|-----------------|-------------------------|------------|------------|--------------------|---------------------|---|----|---|---|-----|----|----|-----|
| <b>Richie Ashburn, L</b><br>OBP: 0.391, SLG: 0.391 (1, 8)   | 0-0<br>BB PB<br>1B | 1-0<br>HBP         |                 | 0-0<br>1B S<br>1-3 1B   |            | 0-0<br>4-3 |                    | 4-0<br>SH1-3<br>BB  |   | 3  | 1 | 2 | 0   | 1  | 0  | 0   |
| <b>Granny Hamner, R</b><br>OBP: 0.319, SLG: 0.335 (1, 6)    | 0-0<br>F5<br>1-2   | 0-0<br>1-3         |                 | 0-0<br>1B<br>1-3 3-H 1B |            | 0-0<br>F6  |                    | 0-0<br>SH1-3<br>1-2 |   | 4  | 0 | 1 | 1   | 0  | 0  | 3   |
| <b>Eddie Waitkus, L</b><br>OBP: 0.347, SLG: 0.377 (1, 3)    | 0-0<br>F7          |                    | 0-0<br>L7<br>3B | 0-0<br>1B<br>1-2 3-H 1B |            |            | 0-0<br>4-3         | 0-3<br>K            |   | 5  | 1 | 2 | 1   | 0  | 1  | 2   |
| <b>Del Ennis, R</b><br>OBP: 0.352, SLG: 0.575 (1, 9)        | 4-0<br>BB<br>BB    |                    | 0-0<br>L7       | 0-0<br>P2               |            |            | 0-0<br>1B<br>F7 1B | 4-0<br>IBB          |   | 3  | 1 | 1 | 1   | 2  | 0  | 2   |
| <b>Willie Jones, R</b><br>OBP: 0.347, SLG: 0.497 (1, 5)     | 4-0<br>BB          |                    | 0-0<br>F8       | 0-0<br>1-3              |            |            | 0-0<br>2B<br>1B    | 0-0<br>L8           |   | 3  | 1 | 1 | 0   | 1  | 0  | 2   |
| <b>Jimmy Bloodworth, R</b><br>OBP: 0.257, SLG: 0.242 (8, 5) | 1-2<br>2-3<br>BB   |                    |                 |                         |            |            |                    |                     |   | 1  | 0 | 0 | 0   | 0  | 0  | 2   |
| <b>Dick Sisler, L</b><br>OBP: 0.424, SLG: 0.541 (1, 7)      | 0-0<br>4-3         |                    | 0-0<br>1B       |                         | 0-0<br>4-3 |            | 0-0<br>F7          |                     |   | 4  | 0 | 1 | 1   | 0  | 0  | 4   |
| <b>Andy Seminick, R</b><br>OBP: 0.407, SLG: 0.460 (1, 2)    |                    | 0-0<br>FC1-6<br>1B | 0-0<br>F2       |                         | 0-0<br>F2  |            | 0-0<br>E<br>2B     |                     |   | 4  | 0 | 2 | 1   | 0  | 0  | 1   |
| <b>Mike Goliat, R</b><br>OBP: 0.273, SLG: 0.365 (1, 4)      |                    | 0-0<br>FC1-6<br>S  |                 | 0-0<br>5-3              | 0-0<br>F3  |            | 0-0<br>E5          |                     |   | 4  | 0 | 0 | 0   | 0  | 0  | 2   |
| <b>Robin Roberts, S</b><br>OBP: 0.186, SLG: 0.079 (1, 1)    |                    | 0-3<br>K           |                 | 4-0<br>1B<br>1B<br>BB   |            | 0-3<br>K   | 0-0<br>L7          |                     |   | 3  | 1 | 0 | 0   | 1  | 2  | 3   |

| Inning Stats | R: 0 | H: 1   | R: 0 | H: 1   | R: 1 | H: 2   | R: 2 | H: 3   | R: 0 | H: 0   | R: 0 | H: 0   | R: 2 | H: 3   | R: 0 | H: 0   |
|--------------|------|--------|------|--------|------|--------|------|--------|------|--------|------|--------|------|--------|------|--------|
|              | E: 0 | LOB: 3 | E: 0 | LOB: 2 | E: 0 | LOB: 1 | E: 0 | LOB: 2 | E: 0 | LOB: 0 | E: 0 | LOB: 0 | E: 1 | LOB: 2 | E: 0 | LOB: 2 |
|              | K: 0 | BB: 2  | K: 1 | BB: 0  | K: 0 | BB: 0  | K: 0 | BB: 1  | K: 0 | BB: 0  | K: 1 | BB: 0  | K: 0 | BB: 0  | K: 1 | BB: 2  |
|              | S: 4 | P: 12  | S: 6 | P: 7   | S: 5 | P: 5   | S: 6 | P: 10  | S: 3 | P: 3   | S: 5 | P: 5   | S: 7 | P: 7   | S: 5 | P: 13  |

| PITCHER                                       | IP  | WLS | BF | H  | R | ER | SO | BB | IBB | HBP | BLK | WP | HR | S  | P  | ERA  | WHIP  |
|---|-----|-----|----|----|---|----|----|----|-----|-----|-----|----|----|----|----|------|-------|
| <b>Ewell Blackwell, R</b><br>ERA: 3.44 (1, 1) | 7.0 | L   | 36 | 10 | 5 | 5  | 2  | 3  | 0   | 1   | 0   | 0  | 0  | 36 | 49 | 6.43 | 1.857 |
| <b>Harry Perkowski, L</b><br>ERA: 3.68 (8, 1) | 1.0 |     | 5  | 0  | 0 | 0  | 1  | 1  | 1   | 0   | 0   | 0  | 0  | 5  | 13 | 0.00 | 1.000 |

**BOTTOM**

**Cincinnati Reds @ Philadelphia Phillies**

Shibe Park, Philadelphia, PA

Sat Jun 17 1950, 3:33 AM EDT  
Att. 7,669 - Unknown

|     |    |
|-----|----|
| AB  | 34 |
| R   | 5  |
| H   | 10 |
| RBI | 5  |
| BB  | 5  |
| SO  | 3  |
| LOB | 21 |



| WP | PA | 1B | SF | 2B | SAC | 3B | DP | HR | HBP |
|----|----|----|----|----|-----|----|----|----|-----|
| 0  | 41 | 8  | 0  | 1  | 1   | 1  | 0  | 0  | 1   |

| Batter   | 1  | 2  | 3   | 4   | 5   | 6   | 7   | 8   | 9   | AB R H RBI BB SO LOB   | TOP  |  |
|--|--|--|---|---|---|---|---|---|---|--|--|--|
| <b>Bobby Adams, R</b><br>OBP: 0.320, SLG: 0.313 (1, 5) X         | 0-0<br>BB BB<br>F8<br>1B   | 0-0<br>L8  |   |   | 0-0<br>F6   |   | 0-0<br>F5   |   | 0-0<br>FC4-6<br>1-2f  | 5 1 1 0 0 0 3  |  |  |
| <b>Peanuts Lowrey, R</b><br>OBP: 0.366, SLG: 0.328 (1, 7) B B B  | 4-0<br>F8 BB<br>1-2 BB   | 0-0<br>6-3   |   |   | 0-0<br>F7   |   | 0-0<br>F3   |   |   | 3 0 0 0 1 0 2  |  |  |
| <b>Johnny Wyrostek, L</b><br>OBP: 0.416, SLG: 0.477 (1, 9) B B B | 4-0<br>F8 BB<br>1-2 2-3  |  | 0-0<br>6-3  |   | 0-3<br>K  |   |   | 0-0<br>G5-4-3<br>1B   |   | 3 0 1 0 1 1 0  |  |  |
| <b>Bob Scheffing, R</b><br>OBP: 0.289, SLG: 0.343 (1, 2) X       | 0-0<br>F8<br>1-2 2-3 3-H   |  | 0-0<br>6-3  |   | 0-0<br>HR   |   |   | 0-0<br>G5-4-3<br>1-2f   |   | 4 1 1 2 0 0 3  |  |  |
| <b>Connie Ryan, R</b><br>OBP: 0.357, SLG: 0.391 (1, 4) S S S     | 0-3<br>K   |  | 0-0<br>2B   |   | 0-0<br>F9   |   |   | 0-0<br>F9   |   | 4 0 1 0 0 1 2  |  |  |
| <b>Ted Kluszewski, L</b><br>OBP: 0.341, SLG: 0.535 (1, 3) X      | 0-0<br>6-3   |  | 0-0<br>L7   |   | 0-0<br>FC5-4<br>1B  |   |   |   | 0-0<br>HR   | 4 1 2 1 0 0 3  |  |  |
| <b>Bob Usher, R</b><br>OBP: 0.320, SLG: 0.387 (1, 8)             |  | 4-0<br>1B BB   |   | 0-0<br>6-3  |   | 0-0<br>FC5-4<br>1-2f  |   |   | 0-0<br>F3   | 3 0 0 0 1 0 1  |  |  |
| <b>Sammy Meeks, R</b><br>OBP: 0.231, SLG: 0.333 (1, 6) S S S     |  | 0-3<br>K   |   | 0-0<br>6-3  |   | 0-0<br>F2   |   |   | 0-0<br>FC4-6<br>1B  | 4 0 1 0 0 1 2<br>0 0 0 0 0 0 0<br>0 0 0 0 0 0 0                        |  |  |
| <b>Lloyd Merriman, L</b><br>OBP: 0.388, SLG: 0.424 (9, PR)       |  |  |   |   |   |   |   |   |   |  |  |  |
| <b>Virgil Stallcup, R</b><br>OBP: 0.262, SLG: 0.349 (9, 6)       |  |  |   |   |   |   |   |   |   |  |  |  |
| <b>Herm Wehmeier, R</b><br>OBP: 0.257, SLG: 0.294 (1, 1) X       |  | 0-0<br>1B  |   | 0-3<br>K  |   |   | 0-0<br>4-3  |   | 0-3<br>K  | 4 0 1 0 0 2 1  |  |  |
| <b>Inning Stats</b>  | R: 1<br>E: 0<br>K: 1<br>S: 6<br>H: 1<br>LOB: 2<br>BB: 2<br>P: 14 | R: 0<br>E: 0<br>K: 1<br>S: 6<br>H: 1<br>LOB: 2<br>BB: 1<br>P: 10 | R: 0<br>E: 0<br>K: 0<br>S: 4<br>H: 1<br>LOB: 1<br>BB: 0<br>P: 4 | R: 0<br>E: 0<br>K: 1<br>S: 5<br>H: 0<br>LOB: 0<br>BB: 0<br>P: 5 | R: 0<br>E: 0<br>K: 1<br>S: 5<br>H: 0<br>LOB: 0<br>BB: 0<br>P: 5 | R: 1<br>E: 0<br>K: 0<br>S: 5<br>H: 2<br>LOB: 1<br>BB: 0<br>P: 5 | R: 0<br>E: 0<br>K: 0<br>S: 3<br>H: 0<br>LOB: 0<br>BB: 0<br>P: 3 | R: 0<br>E: 0<br>K: 0<br>S: 3<br>H: 1<br>LOB: 0<br>BB: 0<br>P: 3 | R: 1<br>E: 0<br>K: 1<br>S: 7<br>H: 2<br>LOB: 1<br>BB: 0<br>P: 7 | 1B: 5<br>2B: 1<br>3B: 0<br>HR: 2<br>SF: 0<br>SAC: 0<br>DP: 1<br>HBP: 0 | WP: 0<br>PB: 0<br>SB: 0<br>CS: 0<br>PA: 37 |  |
| <b>PITCHER</b><br><b>Curt Simmons, L</b><br>ERA: 3.97 (1, 1)     | IP WLS BF H R ER SO BB IBB HBP BLK WP HR S P ERA WHIP            | 9.0 W 37 8 3 3 5 3 0 0 0 0 0 2 44 56 3.00 1.222                  |   |   |   |   |   |   |   |  |  |  |

Cincinnati Reds @ Philadelphia Phillies  
 Shibe Park, Philadelphia, PA  
 Sun Jun 18 1950, 3:33 AM EDT  
 Unknown

livebaseballscorecards.com

|     |    |
|-----|----|
| AB  | 34 |
| R   | 3  |
| H   | 8  |
| RBI | 3  |
| BB  | 3  |
| SO  | 5  |
| LOB | 17 |



| Batter  | 1                 | 2          | 3          | 4                    | 5                        | 6          | 7                    | 8                | 9                          | AB R H RBI BB SO LOB           |
|---|-------------------|------------|------------|----------------------|--------------------------|------------|----------------------|------------------|----------------------------|--------------------------------|
| <b>Richie Ashburn, L</b><br>OBP: 0.390, SLG: 0.390 (1, 8) X   | 0-0<br>1-3<br>1B  |            | 0-0<br>6-3 |                      | 0-0<br>SH3-4<br>1-2      |            | 0-0<br>F9            |                  |                            | 3 0 1 0 0 0 1                  |
| <b>Granny Hamner, R</b><br>OBP: 0.313, SLG: 0.329 (1, 6) X    | 0-0<br>1-3<br>1-2 |            |            | 0-0<br>L7            | 0-0<br>6-3               |            | 0-0<br>FC6-4<br>1-2f |                  |                            | 4 0 0 0 0 0 3                  |
| <b>Eddie Waitkus, L</b><br>OBP: 0.345, SLG: 0.379 (1, 3) X    | 0-0<br>F7         |            |            | 0-0<br>F8            | 0-0<br>2B                |            |                      | 0-0<br>F6        |                            | 4 0 1 1 0 0 1                  |
| <b>Del Ennis, R</b><br>OBP: 0.350, SLG: 0.585 (1, 9) X        | 0-0<br>1-3        |            |            | 0-0<br>HR            | 0-0<br>F6                |            |                      | 0-0<br>6-3       |                            | 4 1 1 1 0 0 2                  |
| <b>Willie Jones, R</b><br>OBP: 0.350, SLG: 0.510 (1, 5) X     |                   | 0-0<br>6-3 |            | 0-0<br>HR            |                          | 0-0<br>L7  |                      | 4-0<br>BB        |                            | 3 1 1 1 1 0 0                  |
| <b>Dick Sisler, L</b><br>OBP: 0.421, SLG: 0.533 (1, 7) X      |                   | 0-0<br>L8  |            | 4-0<br>1B<br>BB      |                          | 0-0<br>F7  |                      | 0-0<br>G3        |                            | 3 0 0 0 1 0 1                  |
| <b>Andy Seminick, R</b><br>OBP: 0.411, SLG: 0.456 (1, 2) X    |                   | 0-3<br>K   |            | 0-0<br>FC5-4<br>1B   |                          | 0-0<br>4-3 |                      |                  | 4-0<br>WP<br>S<br>1B<br>BB | 3 0 1 0 1 1 0<br>0 1 0 0 0 0 0 |
| <b>Putsy Caballero, R</b><br>OBP: 0.200, SLG: 0.111 (9, PR) X |                   |            |            | 1-3                  |                          |            |                      |                  |                            |                                |
| <b>Mike Goliat, R</b><br>OBP: 0.267, SLG: 0.356 (1, 4) X      |                   |            | 0-0<br>F3  | 0-0<br>FC5-4<br>1-2f |                          | 0-0<br>F5  |                      | 0-0<br>F7<br>1-2 |                            | 4 0 0 0 0 0 3                  |
| <b>Curt Simmons, L</b><br>OBP: 0.235, SLG: 0.212 (1, 1) X     |                   |            | 0-3<br>K   |                      | 0-0<br>SH3-4<br>2B<br>1B |            | 0-0<br>FC6-4<br>1B   |                  | 0-0<br>2-H<br>1B           | 3 1 2 0 0 1 0<br>1 0 1 1 0 0 0 |
| <b>Bill Nicholson, L</b><br>OBP: 0.250, SLG: 0.250 (9, PH) X  |                   |            |            |                      |                          |            |                      |                  |                            |                                |

| Inning Stats  | R: 0<br>E: 0<br>K: 0<br>S: 4  | H: 1<br>LOB: 1<br>BB: 0<br>P: 4 | R: 0<br>E: 0<br>K: 1<br>S: 5 | H: 0<br>LOB: 0<br>BB: 0<br>P: 5 | R: 0<br>E: 0<br>K: 1<br>S: 5 | H: 0<br>LOB: 0<br>BB: 0<br>P: 5 | R: 2<br>E: 0<br>K: 0<br>S: 6 | H: 3<br>LOB: 2<br>BB: 1<br>P: 10 | R: 1<br>E: 0<br>K: 0<br>S: 5 | H: 2<br>LOB: 1<br>BB: 0<br>P: 5 | R: 0<br>E: 0<br>K: 0<br>S: 3 | H: 0<br>LOB: 0<br>BB: 0<br>P: 3 | R: 0<br>E: 0<br>K: 0<br>S: 4 | H: 1<br>LOB: 1<br>BB: 0<br>P: 4 | R: 0<br>E: 0<br>K: 0<br>S: 3 | H: 0<br>LOB: 1<br>BB: 1<br>P: 7 | R: 1<br>E: 0<br>K: 0<br>S: 2 | H: 1<br>LOB: 1<br>BB: 1<br>P: 6 | 1B: 5<br>2B: 1<br>3B: 0<br>HR: 2 | SF: 0<br>SAC: 1<br>DP: 0<br>HBP: 0 |
|---|---|---------------------------------|------------------------------|---------------------------------|------------------------------|---------------------------------|------------------------------|----------------------------------|------------------------------|---------------------------------|------------------------------|---------------------------------|------------------------------|---------------------------------|------------------------------|---------------------------------|------------------------------|---------------------------------|----------------------------------|------------------------------------|
| <b>PITCHER</b><br><b>Herm Wehmeier, R</b><br>ERA: 6.97 (1, 1) | IP 8.1<br>WLS L<br>BF 36<br>H 8<br>R 4<br>ER 4<br>SO 2<br>BB 3<br>IBB 0<br>HBP 0<br>BLK 0<br>WP 1<br>HR 2<br>S 37<br>P 49<br>ERA 4.32<br>WHIP 1.320 |                                 |                              |                                 |                              |                                 |                              |                                  |                              |                                 |                              |                                 |                              |                                 |                              |                                 |                              |                                 | WP: 1<br>PB: 0<br>SB: 1<br>CS: 0 | PA: 36                             |

**BOTTOM**

**Cincinnati Reds @ Philadelphia Phillies**

Shibe Park, Philadelphia, PA

Sun Jun 18 1950, 3:33 AM EDT  
Unknown

[livebaseballscorecards.com](http://livebaseballscorecards.com)

|            |           |
|------------|-----------|
| <b>AB</b>  | <b>32</b> |
| <b>R</b>   | <b>4</b>  |
| <b>H</b>   | <b>8</b>  |
| <b>RBI</b> | <b>4</b>  |
| <b>BB</b>  | <b>3</b>  |
| <b>SO</b>  | <b>2</b>  |
| <b>LOB</b> | <b>11</b> |



| Batter   | 1   | 2   | 3   | 4   | 5   | 6   | 7   | 8   | 9   | AB R H RBI BB SO LOB                                       | TOP   |   |
|--|---|---|---|---|---|---|---|---|---|--|---|---|
| Lloyd Merriman, L (1, 8)<br>OBP: 0.380, SLG: 0.413   | 0-0<br>E8<br>1B                                       |   | 0-0<br>4-3  |   | 0-0<br>F5   |   |   | 0-0<br>1-3  |   | 4 1 1 0 0 0 1  | <b>Cincinnati Reds @ Philadelphia Phillies</b><br>Shibe Park, Philadelphia, PA<br>Sun Jun 18 1950, 3:38 AM EDT<br>Att. 20,495 - Unknown<br><a href="http://livebaseballscorecards.com">livebaseballscorecards.com</a> |   |
| Peanuts Lowrey, R (1, 7)<br>OBP: 0.370, SLG: 0.333   | 0-0<br>G3-6-3<br>2-H<br>1B                            |   | 0-0<br>F7   |   |   | 0-0<br>F8   |   | 0-0<br>WP<br>BLK<br>1B                              |   | 4 0 2 1 0 0 0  |   |   |
| Johnny Wyrostek, L (1, 9)<br>OBP: 0.408, SLG: 0.467  | 0-0<br>G3-6-3<br>1-2f                                 |   | 0-0<br>4-3  |   |   | 0-0<br>4-3  |   | 0-0<br>F4<br>1-2                                    |   | 4 0 0 0 0 0 2  |   |   |
| Ted Kluszewski, L (1, 3)<br>OBP: 0.345, SLG: 0.538   | 0-0<br>3B<br>2B                                       |   |   | 0-0<br>F8   |   | 0-0<br>P4   |   | 4-0<br>WP<br>IBB                                    |   | 3 1 1 0 1 0 0  |   |   |
| Connie Ryan, R (1, 4)<br>OBP: 0.360, SLG: 0.409  | 0-0<br>2-H<br>3B                                      |   |   | 0-0<br>F3   |   |   | 0-0<br>SH1-4<br>1B                                  | 0-0<br>F9<br>1-2<br>2-3                             |   | 4 0 2 1 0 0 2  |   |   |
| Bobby Adams, R (1, 5)<br>OBP: 0.320, SLG: 0.313  | 0-0<br>6-3  |   |   | 0-0<br>5-3  |   |   | 0-0<br>SH1-4<br>1-2                                 |   | 0-0<br>FC4-6<br>1B                                  | 3 0 1 0 0 0 1  |   |   |
| Dixie Howell, R (1, 2)<br>OBP: 0.333, SLG: 0.257<br>Harry Perkowski, L (9, PH)<br>OBP: 0.400, SLG: 0.400 |   | 0-0<br>F5   |   |   | 0-0<br>6-3  |   | 0-0<br>F5   | 0-0<br>FC4-6<br>L4-3<br>1-2f                        | 0-0<br>FC4-6<br>L4-3                                | 3 0 0 0 0 0 1<br>1 0 0 0 0 0 1                             |   |   |
| Sammy Meeks, R (1, 6)<br>OBP: 0.233, SLG: 0.296  |   | 0-3<br>K  |   |   | 0-0<br>E5<br>3-1                                    |   | 4-0<br>BB   |   | 0-0<br>L4-3<br>1-2                                  | 3 0 0 0 1 1 1  |   |   |
| Howie Fox, R (1, 1)<br>OBP: 0.222, SLG: 0.278  |   | 0-0<br>5-3  |   |   | 0-0<br>3-1<br>2-3                                   |   | 0-0<br>4-3  |   |   | 3 0 0 0 0 0 3  |   |   |
| <b>Inning Stats</b>  | R: 2 H: 4<br>E: 1 LOB: 1<br>K: 0 BB: 0<br>S: 6 P: 6   | R: 0 H: 0<br>E: 0 LOB: 0<br>K: 1 BB: 0<br>S: 5 P: 5 | R: 0 H: 0<br>E: 0 LOB: 0<br>K: 0 BB: 0<br>S: 3 P: 3 | R: 0 H: 0<br>E: 0 LOB: 0<br>K: 0 BB: 0<br>S: 3 P: 3 | R: 0 H: 0<br>E: 1 LOB: 1<br>K: 0 BB: 0<br>S: 4 P: 4 | R: 0 H: 0<br>E: 0 LOB: 0<br>K: 0 BB: 0<br>S: 3 P: 3 | R: 0 H: 1<br>E: 0 LOB: 2<br>K: 0 BB: 1<br>S: 4 P: 8 | R: 0 H: 1<br>E: 0 LOB: 2<br>K: 0 BB: 1<br>S: 4 P: 8 | R: 0 H: 1<br>E: 0 LOB: 0<br>K: 0 BB: 0<br>S: 3 P: 3 | 1B: 5 SF: 0<br>2B: 2 SAC: 1<br>3B: 1 DP: 2<br>HR: 0 HBP: 0 | WP: 1 PA: 35<br>PB: 0<br>SB: 0<br>CS: 0   |   |
| <b>PITCHER</b><br>Bob Miller, R (1, 1)<br>ERA: 1.71  | IP WLS BF H R ER SO BB IBB HBP BLK WP HR S P ERA WHIP |   |   |   |   |   |   |   |   |  |   | <b>PITCHER</b><br>IP WLS BF H R ER SO BB IBB HBP BLK WP HR S P ERA WHIP |



| Batter  | 1                            | 2                               | 3                                   | 4                                | 5                            | 6                               | 7                            | 8                               | 9                            | AB                              | R                            | H                               | RBI                          | BB                              | SO                           | LOB                              | BOTTOM  |                                    |                                  |        |    |   |     |    |   |
|---|------------------------------|---------------------------------|-------------------------------------|----------------------------------|------------------------------|---------------------------------|------------------------------|---------------------------------|------------------------------|---------------------------------|------------------------------|---------------------------------|------------------------------|---------------------------------|------------------------------|----------------------------------|---|------------------------------------|----------------------------------|--------|----|---|-----|----|---|
| Richie Ashburn, L (1, 8)<br>OBP: 0.385, SLG: 0.384  | 0-0<br>4-3                   |                                 | 0-0<br>F8                           |                                  | 0-0<br>G6-4-3                |                                 | 0-0<br>E9                    | 0-0<br>F8                       |                              | 5                               | 0                            | 1                               | 0                            | 0                               | 0                            | 3                                | <b>Cincinnati Reds @ Philadelphia Phillies</b><br>Shibe Park, Philadelphia, PA<br>Sun Jun 18 1950, 3:38 AM EDT<br>Att. 20,495 - Unknown |                                    |                                  |        |    |   |     |    |   |
| Granny Hamner, R (1, 6)<br>OBP: 0.312, SLG: 0.327   | 0-0<br>F5                    |                                 |                                     | 0-0<br>F2                        |                              | 0-0<br>1B                       | 0-0<br>F9                    |                                 | 4                            | 1                               | 1                            | 1                               | 0                            | 0                               | 1                            |                                  |   |                                    |                                  |        |    |   |     |    |   |
| Eddie Waitkus, L (1, 3)<br>OBP: 0.348, SLG: 0.382   | 0-3<br>K                     |                                 |                                     | 0-0<br>PB 1B<br>1B               |                              | 0-0<br>1B                       | 0-0<br>1-3                   |                                 | 4                            | 0                               | 2                            | 0                               | 0                            | 1                               | 1                            |                                  |   |                                    |                                  |        |    |   |     |    |   |
| Del Ennis, R (1, 9)<br>OBP: 0.348, SLG: 0.578       |                              | 0-0<br>F7                       |                                     | 0-0<br>F7                        |                              | 0-0<br>1B                       |                              | 0-0<br>F3                       | 4                            | 0                               | 1                            | 1                               | 0                            | 0                               | 1                            |                                  |   |                                    |                                  |        |    |   |     |    |   |
| Willie Jones, R (1, 5)<br>OBP: 0.357, SLG: 0.522    |                              | 0-0<br>3B                       |                                     | 0-0<br>PB 1B                     |                              | 0-0<br>L4                       |                              | 4-0<br>1B BB                    | 3                            | 1                               | 2                            | 0                               | 1                            | 0                               | 2                            |                                  |   |                                    |                                  |        |    |   |     |    |   |
| Dick Sisler, L (1, 7)<br>OBP: 0.427, SLG: 0.532     |                              | 0-0<br>L5                       |                                     | 4-0<br>1-2<br>2-3<br>BB          |                              | 4-0<br>IBB                      |                              | 0-0<br>1B L8<br>1B              | 2                            | 1                               | 1                            | 0                               | 2                            | 0                               | 1                            |                                  |   |                                    |                                  |        |    |   |     |    |   |
| Stan Lopata, R (1, 2)<br>OBP: 0.325, SLG: 0.243     |                              | 0-0<br>4-3                      |                                     | 0-0<br>6-3                       |                              | 0-0<br>G6-4-3                   |                              | 0-0<br>BB                       | 2                            | 0                               | 0                            | 0                               | 0                            | 0                               | 4                            |                                  |   |                                    |                                  |        |    |   |     |    |   |
| Bill Nicholson, L (6, PH)<br>OBP: 0.200, SLG: 0.200 |                              |                                 |                                     |                                  |                              | 0-0<br>1-2f                     |                              | 1-3<br>3-H<br>1B                | 1                            | 0                               | 0                            | 0                               | 0                            | 0                               | 3                            |                                  |   |                                    |                                  |        |    |   |     |    |   |
| Andy Seminick, R (7, 2)<br>OBP: 0.416, SLG: 0.462   |                              |                                 |                                     |                                  |                              |                                 |                              | 1-3<br>3-H<br>1B                | 1                            | 0                               | 1                            | 1                               | 0                            | 0                               | 0                            |                                  |   |                                    |                                  |        |    |   |     |    |   |
| Mike Goliat, R (1, 4)<br>OBP: 0.272, SLG: 0.355     |                              |                                 | 0-0<br>L8                           |                                  | 0-0<br>FC1-6<br>1B           |                                 | 0-0<br>L8                    | 4-0<br>1-2<br>BB                | 3                            | 0                               | 1                            | 0                               | 1                            | 0                               | 0                            |                                  |   |                                    |                                  |        |    |   |     |    |   |
| Bob Miller, R (1, 1)<br>OBP: 0.200, SLG: 0.200      |                              |                                 | 0-0<br>5-3                          |                                  | 0-0<br>FC1-6<br>G6-4-3       |                                 | 0-0<br>E 1B<br>F9 1B         | 0-0<br>L8                       | 4                            | 1                               | 1                            | 1                               | 0                            | 0                               | 3                            |                                  |   |                                    |                                  |        |    |   |     |    |   |
| <b>Inning Stats</b>                                 | R: 0<br>E: 0<br>K: 1<br>S: 5 | H: 0<br>LOB: 0<br>BB: 0<br>P: 5 | R: 0<br>E: 0<br>K: 0<br>S: 4        | H: 1<br>LOB: 1<br>BB: 0<br>P: 4  | R: 0<br>E: 0<br>K: 0<br>S: 3 | H: 0<br>LOB: 0<br>BB: 0<br>P: 3 | R: 0<br>E: 0<br>K: 0<br>S: 5 | H: 2<br>LOB: 3<br>BB: 1<br>P: 9 | R: 0<br>E: 0<br>K: 0<br>S: 3 | H: 1<br>LOB: 0<br>BB: 0<br>P: 3 | R: 1<br>E: 0<br>K: 0<br>S: 5 | H: 3<br>LOB: 2<br>BB: 1<br>P: 9 | R: 1<br>E: 1<br>K: 0<br>S: 5 | H: 2<br>LOB: 1<br>BB: 0<br>P: 5 | R: 2<br>E: 0<br>K: 0<br>S: 5 | H: 2<br>LOB: 2<br>BB: 2<br>P: 13 | 1B: 10<br>2B: 0<br>3B: 1<br>HR: 0   | SF: 0<br>SAC: 0<br>DP: 2<br>HBP: 0 | WP: 0<br>PB: 1<br>SB: 0<br>CS: 0 | PA: 37 |    |   |     |    |   |
| <b>PITCHER</b><br>Howie Fox, R (1, 1)<br>ERA: 5.33  | IP: 8.0<br>WLS: L<br>BF: 37  | H: 11<br>R: 4<br>ER: 3<br>SO: 1 | BB: 3<br>IBB: 1<br>HBP: 0<br>BLK: 0 | WP: 0<br>HR: 0<br>S: 35<br>P: 51 | ERA: 3.38<br>WHIP: 1.750     |                                 |                              |                                 |                              |                                 |                              |                                 |                              |                                 |                              |                                  |   |                                    |                                  |        |    |   |     |    |   |
|   |                              |                                 |                                     |                                  |                              |                                 |                              |                                 |                              |                                 | AB                           | 33                              | R                            | 4                               | H                            | 11                               | RBI   | 4                                  | BB                               | 4      | SO | 1 | LOB | 19 |  |

livebaseballscorecards.com

| Batter  | 1   | 2                                | 3                             | 4                                | 5                             | 6                               | 7                            | 8                               | 9                            | AB R H RBI BB SO LOB             | TOP  |                                  |                              |                                 |                              |                                 |                                   |                                    |                                  |        |
|---|---|----------------------------------|-------------------------------|----------------------------------|-------------------------------|---------------------------------|------------------------------|---------------------------------|------------------------------|----------------------------------|--|----------------------------------|------------------------------|---------------------------------|------------------------------|---------------------------------|-----------------------------------|------------------------------------|----------------------------------|--------|
| Grady Hatton, L (1, 5)<br>OBP: 0.330, SLG: 0.413      | 2-2<br>L6   |                                  | 1-0<br>4-3                    |                                  | 1-1<br>G6-4-3<br>1B           |                                 | 1-0<br>F9                    |                                 |                              | 4 0 1 0 0 0 0                    | <p>Cincinnati Reds @ Brooklyn Dodgers</p> <p>Ebbets Field, Brooklyn, NY</p> <p>Tue Jun 20 1950, 3:33 AM EDT</p> <p>Att. 16,180 - Unknown</p> |                                  |                              |                                 |                              |                                 |                                   |                                    |                                  |        |
| Peanuts Lowrey, R (1, 7)<br>OBP: 0.367, SLG: 0.331    | 1-3<br>K  |                                  | 1-1<br>5-3<br>1B              |                                  | 0-0<br>G6-4-3<br>1-2f         |                                 | 0-0<br>F7                    |                                 |                              | 4 0 1 0 0 1 1                    |  |                                  |                              |                                 |                              |                                 |                                   |                                    |                                  |        |
| Johnny Wyrostek, L (1, 9)<br>OBP: 0.410, SLG: 0.467   | 2-1<br>F8   |                                  | 0-0<br>5-3<br>1B              |                                  | 2-1<br>F8                     |                                 | 1-1<br>G5-4-3<br>1B          |                                 |                              | 4 0 2 0 0 0 0                    |  |                                  |                              |                                 |                              |                                 |                                   |                                    |                                  |        |
| Bob Scheffing, R (1, 2)<br>OBP: 0.310, SLG: 0.359     |   | 1-2<br>E<br>1B                   | 3-2<br>5-3                    |                                  | 1-2<br>1B                     |                                 | 0-0<br>G5-4-3<br>1-2f        |                                 |                              | 4 1 2 0 0 0 3                    |  |                                  |                              |                                 |                              |                                 |                                   |                                    |                                  |        |
| Connie Ryan, R (1, 4)<br>OBP: 0.358, SLG: 0.404       |   | 0-1<br>4-3<br>E<br>1B            | 0-2<br>F6                     |                                  | 1-2<br>F7                     |                                 | 1-1<br>F7                    |                                 |                              | 4 0 1 0 0 0 2                    |  |                                  |                              |                                 |                              |                                 |                                   |                                    |                                  |        |
| Ted Kluszewski, L (1, 3)<br>OBP: 0.343, SLG: 0.531    |   | 2-2<br>E5<br>4-3                 |                               | 0-1<br>G5-4-3<br>1B              |                               | 2-2<br>6-3                      |                              | 0-0<br>F7                       |                              | 4 0 1 0 0 0 1                    |  |                                  |                              |                                 |                              |                                 |                                   |                                    |                                  |        |
| Bob Usher, R (1, 8)<br>OBP: 0.317, SLG: 0.383         |   | 0-0<br>4-3                       |                               | 1-1<br>G5-4-3<br>1-2f            |                               | 1-2<br>1B<br>G5-4-3             |                              | 2-1<br>F6                       |                              | 4 1 1 0 0 0 3                    |  |                                  |                              |                                 |                              |                                 |                                   |                                    |                                  |        |
| Sammy Meeks, R (1, 6)<br>OBP: 0.273, SLG: 0.367       |   | 1-3<br>K                         |                               | 0-0<br>2B                        |                               | 0-0<br>1B<br>G5-4-3             |                              |                                 |                              | 3 0 2 0 0 1 2                    |  |                                  |                              |                                 |                              |                                 |                                   |                                    |                                  |        |
| Ken Raffensberger, R (1, 1)<br>OBP: 0.257, SLG: 0.250 |   | 0-1<br>6-3                       |                               | 0-3<br>K                         |                               | 0-1<br>G5-4-3<br>1-2f<br>3-H    |                              |                                 |                              | 1 0 0 0 0 0 2                    |  |                                  |                              |                                 |                              |                                 |                                   |                                    |                                  |        |
| Frank Smith, R (3, 1)<br>OBP: 0.100, SLG: 0.100       |   |                                  |                               |                                  |                               |                                 |                              |                                 |                              | 1 0 0 0 0 1 1                    |  |                                  |                              |                                 |                              |                                 |                                   |                                    |                                  |        |
| Joe Adcock, R (7, PH)<br>OBP: 0.196, SLG: 0.182       |   |                                  |                               |                                  |                               |                                 |                              |                                 |                              | 1 0 0 0 0 0 1                    |  |                                  |                              |                                 |                              |                                 |                                   |                                    |                                  |        |
| Eddie Erault, R (7, 1)                                |   |                                  |                               |                                  |                               |                                 |                              |                                 |                              | 0 0 0 0 0 0 0                    |  |                                  |                              |                                 |                              |                                 |                                   |                                    |                                  |        |
| <b>Inning Stats</b>                                   | R: 0<br>E: 0<br>K: 1<br>S: 8  | H: 0<br>LOB: 0<br>BB: 0<br>P: 13 | R: 1<br>E: 1<br>K: 1<br>S: 15 | H: 2<br>LOB: 2<br>BB: 0<br>P: 19 | R: 0<br>E: 0<br>K: 1<br>S: 12 | H: 2<br>LOB: 1<br>BB: 0<br>P: 9 | R: 0<br>E: 0<br>K: 1<br>S: 5 | H: 1<br>LOB: 0<br>BB: 0<br>P: 8 | R: 0<br>E: 0<br>K: 0<br>S: 9 | H: 1<br>LOB: 0<br>BB: 0<br>P: 13 | R: 1<br>E: 0<br>K: 0<br>S: 8   | H: 2<br>LOB: 0<br>BB: 0<br>P: 10 | R: 0<br>E: 0<br>K: 0<br>S: 4 | H: 1<br>LOB: 0<br>BB: 0<br>P: 5 | R: 0<br>E: 0<br>K: 0<br>S: 5 | H: 0<br>LOB: 0<br>BB: 0<br>P: 8 | 1B: 10<br>2B: 1<br>3B: 0<br>HR: 0 | SF: 0<br>SAC: 0<br>DP: 4<br>HBP: 0 | WP: 0<br>PB: 0<br>SB: 0<br>CS: 0 | PA: 34 |
| <b>PITCHER</b><br>Preacher Roe, L (1, 1)<br>ERA: 3.19 | IP 9.0<br>WLS W<br>BF 34<br>H 11<br>R 2<br>ER 1<br>SO 3<br>BB 0<br>IBB 0<br>HBP 0<br>BLK 0<br>WP 0<br>HR 0<br>S 74<br>P 102<br>ERA 1.00<br>WHIP 1.222 |                                  |                               |                                  |                               |                                 |                              |                                 |                              |                                  |  |                                  |                              |                                 |                              |                                 |                                   |                                    |                                  |        |

livebaseballscorecards.com

|     |    |
|-----|----|
| AB  | 34 |
| R   | 2  |
| H   | 11 |
| RBI | 0  |
| BB  | 0  |
| SO  | 3  |
| LOB | 16 |



| Batter  | 1              | 2                      | 3                                 | 4               | 5               | 6              | 7               | 8 | 9 |
|---|----------------|------------------------|-----------------------------------|-----------------|-----------------|----------------|-----------------|---|---|
| <b>Billy Cox, R</b><br>OBP: 0.298, SLG: 0.372<br>(1, 5)<br>C<br>F<br>B<br>X   | 1-2<br>L7<br>① |                        | 0-1<br>HR<br>F4                   |                 |                 | 1-2<br>L6<br>② |                 |   |   |
| <b>Jim Russell, S</b><br>OBP: 0.337, SLG: 0.583<br>(1, 7)<br>(5, 8)<br>X  | 0-0<br>F6<br>② |                        | 0-1<br>E<br>2B                    | 1-1<br>4-3<br>① |                 | 1-0<br>L7<br>③ |                 |   |   |
| <b>Duke Snider, L</b><br>OBP: 0.391, SLG: 0.549<br><b>Gene Hermanski, L</b><br>OBP: 0.360, SLG: 0.422<br>(1, 8)<br>(5, 7)<br>F<br>B<br>S<br>X | 1-2<br>L6<br>③ |                        | 0-1<br>E4<br>S<br>BB<br>HR<br>2-H | 1-3<br>K<br>②   |                 | 1-0<br>F9<br>① |                 |   |   |
| <b>Jackie Robinson, R</b><br>OBP: 0.451, SLG: 0.580<br><b>Eddie Miksis, R</b><br>OBP: 0.156, SLG: 0.140<br>(1, 4)<br>(7, 4)                   |                | 0-2<br>E<br>2B         | 4-2<br>S<br>HR<br>BB              | 3-2<br>F6<br>③  |                 | 1-2<br>F4<br>② |                 |   |   |
| <b>Carl Furillo, R</b><br>OBP: 0.329, SLG: 0.422<br>(1, 9)<br>X   |                | 0-0<br>E7<br>2-H<br>1B | 0-2<br>E6<br>HR<br>1-2<br>2-3     |                 | 0-0<br>5-3<br>① | 0-1<br>IHR     |                 |   |   |
| <b>Gil Hodges, R</b><br>OBP: 0.380, SLG: 0.438<br>(1, 3)<br>B<br>B<br>S<br>X  |                | 1-1<br>5-3<br>①        | 2-1<br>HR<br>1-H<br>2-H<br>3-H    |                 | 1-3<br>K<br>②   | 1-2<br>F6<br>③ |                 |   |   |
| <b>Roy Campanella, R</b><br>OBP: 0.420, SLG: 0.660<br>(1, 2)<br>B<br>B<br>S<br>B<br>B   |                | 4-1<br>FC5-4<br>BB     | 0-1<br>F2                         |                 | 4-0<br>BB       |                | 0-3<br>K<br>①   |   |   |
| <b>Pee Wee Reese, R</b><br>OBP: 0.320, SLG: 0.318<br>(1, 6)<br>C<br>F<br>B<br>S<br>X  |                | 1-2<br>F5<br>②         | 2-2<br>HBP                        |                 | 0-0<br>F9<br>③  |                | 0-2<br>4-3<br>② |   |   |
| <b>Preacher Roe, R</b><br>OBP: 0.171, SLG: 0.176<br>(1, 1)<br>X   |                | 0-0<br>FC5-4<br>1-2f   | 0-3<br>K<br>②                     |                 | 0-3<br>K<br>①   |                | 0-0<br>F9<br>③  |   |   |

| AB | R | H | RBI | BB | SO | LOB |
|----|---|---|-----|----|----|-----|
| 4  | 1 | 1 | 1   | 0  | 0  | 1   |
| 4  | 1 | 1 | 0   | 0  | 0  | 0   |
| 3  | 1 | 0 | 0   | 0  | 1  | 0   |
| 1  | 0 | 0 | 0   | 0  | 0  | 0   |
| 2  | 2 | 1 | 0   | 1  | 0  | 0   |
| 1  | 0 | 0 | 0   | 0  | 0  | 0   |
| 4  | 2 | 2 | 2   | 0  | 0  | 2   |
| 4  | 1 | 1 | 4   | 0  | 1  | 1   |
| 2  | 0 | 0 | 0   | 2  | 1  | 0   |
| 3  | 0 | 0 | 0   | 0  | 0  | 3   |
| 4  | 0 | 0 | 0   | 0  | 2  | 3   |

| AB | R | H | RBI | BB | SO | LOB |
|----|---|---|-----|----|----|-----|
| 32 | 8 | 6 | 7   | 3  | 5  | 10  |

| Inning Stats | R: 0         | H: 0         | E: 0          | K: 0         | S: 8         | LOB: 0       | BB: 0         | P: 10 |
|--------------|--------------|--------------|---------------|--------------|--------------|--------------|---------------|-------|
| <b>1B: 1</b> | <b>SF: 0</b> | <b>2B: 2</b> | <b>SAC: 0</b> | <b>3B: 0</b> | <b>DP: 0</b> | <b>HR: 3</b> | <b>HBP: 1</b> |       |

| WP | HR | S  | P  | ERA   | WHIP  |
|----|----|----|----|-------|-------|
| 0  | 0  | 0  | 0  | 22.50 | 3.000 |
| 0  | 1  | 36 | 52 | 0.00  | 0.500 |
| 0  | 0  | 18 | 21 | 4.50  | 0.500 |

**BOTTOM**

**Cincinnati Reds @ Brooklyn Dodgers**  
Ebbets Field, Brooklyn, NY  
Tue Jun 20 1950, 3:33 AM EDT  
Att. 16,180 - Unknown

livebaseballscorecards.com



**Cincinnati Reds @ Brooklyn Dodgers**  
 Ebbets Field, Brooklyn, NY  
 Wed Jun 21 1950, 3:33 AM EDT  
 Att. 8,580 - Unknown

[livebaseballscorecards.com](http://livebaseballscorecards.com)

|            |           |
|------------|-----------|
| <b>AB</b>  | <b>32</b> |
| <b>R</b>   | <b>6</b>  |
| <b>H</b>   | <b>8</b>  |
| <b>RBI</b> | <b>6</b>  |
| <b>BB</b>  | <b>8</b>  |
| <b>SO</b>  | <b>1</b>  |
| <b>LOB</b> | <b>20</b> |



| Batter   | 1                     | 2                   | 3               | 4          | 5                | 6          | 7               | 8                         | 9                                  | AB R H RBI BB SO LOB |
|--|-----------------------|---------------------|-----------------|------------|------------------|------------|-----------------|---------------------------|------------------------------------|----------------------|
| Lloyd Merriman, L (1, 8)<br>OBP: 0.368, SLG: 0.397   | 1-2<br>E6<br>G4-6-3   |                     | 1-0<br>L9       |            |                  | 3-2<br>4-3 |                 | 1-2<br>2B<br>1B           | 2-2<br>FC3-2<br>2B<br>1-2 2-3 3-H  | 5 2 1 0 0 0 3        |
| Peanuts Lowrey, R (1, 7)<br>OBP: 0.368, SLG: 0.336   | 0-0<br>G4-6-3<br>1-2f |                     |                 | 2-1<br>4-3 |                  | 0-0<br>5-3 |                 | 4-1<br>2B<br>BB           | 1-1<br>1B<br>2B<br>1-H 2-H 3-H     | 4 1 1 3 1 0 1        |
| Johnny Wyrostek, L (1, 9)<br>OBP: 0.405, SLG: 0.460  | 2-1<br>4-3            |                     |                 | 1-1<br>F7  |                  | 0-0<br>F9  |                 | 0-1<br>F2                 | 1-2<br>1B<br>2-H                   | 5 0 1 0 0 0 2        |
| Ted Kluszewski, L (1, 3)<br>OBP: 0.345, SLG: 0.539   |                       | 0-2<br>1B<br>2B     |                 | 0-0<br>3-1 |                  |            | 0-2<br>4-3      | 1-1<br>E<br>2B<br>1-H 2-H | 1-0<br>4-3                         | 5 1 2 2 0 0 2        |
| Grady Hatton, L (1, 5)<br>OBP: 0.333, SLG: 0.412     |                       | 0-1<br>1B<br>2-H    |                 |            | 4-1<br>2-3<br>BB |            | 1-1<br>6-3      | 1-0<br>E4<br>2-3          |                                    | 3 0 1 1 1 0 1        |
| Connie Ryan, R (1, 4)<br>OBP: 0.361, SLG: 0.399      |                       | 4-2<br>BB<br>G6-4-3 |                 |            | 0-0<br>2-3       |            | 4-1<br>1B<br>BB | 2-0<br>5-3                |                                    | 2 0 0 0 2 0 3        |
| Bob Scheffing, R (1, 2)<br>OBP: 0.333, SLG: 0.366    |                       | 0-1<br>G6-4-3       |                 |            | 4-0<br>FC6<br>BB |            | 0-1<br>1B       |                           | 4-2<br>BB<br>FC3-2<br>BB           | 2 0 1 0 1 0 1        |
| Willie Ramsdell, R (8, 1)<br>OBP: 0.211, SLG: 0.211  |                       |                     |                 |            |                  |            | 1-3             |                           |                                    | 0 0 0 0 0 0 0        |
| Bobby Adams, R (9, PH)<br>OBP: 0.325, SLG: 0.313     |                       |                     |                 |            |                  |            |                 |                           |                                    | 0 0 0 0 1 0 0        |
| Dixie Howell, R (9, 2)<br>OBP: 0.333, SLG: 0.257     |                       |                     |                 |            |                  |            |                 |                           |                                    | 0 0 0 0 0 0 0        |
| Virgil Stallcup, R (1, 6)<br>OBP: 0.267, SLG: 0.349  |                       |                     | 0-0<br>CS<br>1B |            | 0-1<br>F8        |            | 0-2<br>1-3      |                           | 4-0<br>FC3-2<br>BB<br>1-2 2B<br>BB | 3 1 1 0 1 0 4        |
| Ewell Blackwell, R (1, 1)<br>OBP: 0.143, SLG: 0.077  |                       |                     | 2-3<br>K        |            | 1-1<br>FC6       |            |                 | 0-0<br>1-3                | 4-0<br>FC3-2<br>BB                 | 2 0 0 0 0 0 1 3      |
| Harry Parkowski, L (8, PH)<br>OBP: 0.364, SLG: 0.364 |                       |                     |                 |            |                  |            |                 |                           |                                    | 1 0 0 0 0 0 0 0      |
| Johnny Pramesa, R (8, 2)<br>OBP: 0.293, SLG: 0.358   |                       |                     |                 |            |                  |            |                 |                           |                                    | 0 0 0 0 0 1 0 0      |
| Herm Wehmeier, R (9, PR)<br>OBP: 0.287, SLG: 0.294   |                       |                     |                 |            |                  |            |                 |                           |                                    | 0 1 0 0 0 0 0 0      |
| Frank Smith, R (9, 1)<br>OBP: 0.100, SLG: 0.100      |                       |                     |                 |            |                  |            |                 |                           |                                    | 0 0 0 0 0 0 0 0      |
| Howie Fox, R (9, 1)<br>OBP: 0.222, SLG: 0.278        |                       |                     |                 |            |                  |            |                 |                           |                                    | 0 0 0 0 0 0 0 0      |

| Inning Stats | R: 0 | H: 0   | R: 1  | H: 2   | R: 0 | H: 1   | R: 0 | H: 0   | R: 0 | H: 0   | R: 0 | H: 1   | R: 2  | H: 2   | R: 3  | H: 2   | 1B: 5 | SF: 0  | WP: 0 | PA: 40 |
|--------------|------|--------|-------|--------|------|--------|------|--------|------|--------|------|--------|-------|--------|-------|--------|-------|--------|-------|--------|
|              | E: 1 | LOB: 0 | E: 0  | LOB: 0 | E: 0 | LOB: 0 | E: 0 | LOB: 2 | E: 0 | LOB: 2 | E: 0 | LOB: 2 | E: 1  | LOB: 2 | E: 0  | LOB: 2 | 2B: 3 | SAC: 0 | PB: 0 |        |
|              | K: 0 | BB: 0  | K: 0  | BB: 1  | K: 0 | BB: 0  | K: 0 | BB: 2  | K: 0 | BB: 1  | K: 0 | BB: 1  | K: 0  | BB: 1  | K: 0  | BB: 3  | 3B: 0 | DP: 2  | SB: 0 |        |
|              | S: 6 | P: 9   | S: 11 | P: 15  | S: 5 | P: 8   | S: 5 | P: 8   | S: 6 | P: 15  | S: 5 | P: 8   | S: 13 | P: 18  | S: 12 | P: 21  | HR: 0 | HBP: 0 | CS: 1 |        |

| PITCHER                             | IP  | WLS | BF | H | R | ER | SO | BB | IBB | HBP | BLK | WP | HR | S  | P   | ERA   | WHIP  |
|-------------------------------------|-----|-----|----|---|---|----|----|----|-----|-----|-----|----|----|----|-----|-------|-------|
| Don Newcombe, R (1, 1)<br>ERA: 3.49 | 8.0 |     | 34 | 6 | 4 | 4  | 1  | 6  | 0   | 0   | 0   | 0  | 0  | 66 | 109 | 4.50  | 1.500 |
| Jack Banta, R (9, 1)<br>ERA: 4.35   | 0.0 | L   | 1  | 0 | 0 | 0  | 0  | 1  | 0   | 0   | 0   | 0  | 0  | 4  | ∞   | ∞     |       |
| Bud Podbielan, R (9, 1)<br>ERA: 4.8 | 1.0 |     | 5  | 2 | 2 | 2  | 0  | 1  | 0   | 0   | 0   | 0  | 0  | 9  | 18  | 18.00 | 3.000 |



BOTTOM

Cincinnati Reds @ Brooklyn Dodgers  
Ebbets Field, Brooklyn, NY  
Wed Jun 21 1950, 3:33 AM EDT  
Att. 8,580 - Unknown

livebaseballscorecards.com

AB 33  
R 5  
H 9  
RBI 4  
BB 2  
SO 8  
LOB 12



WP: 0 PA: 39  
PB: 0  
SB: 2  
CS: 1

AB R H RBI BB SO LOB

4 0 1 0 0 1 1  
0 0 0 0 1 0 0

5 2 3 1 0 0 3

2 1 1 1 1 1 1

4 0 2 2 0 0 1

4 0 1 0 0 0 1

4 0 0 0 0 2 1

3 0 0 0 0 1 1  
0 0 0 0 0 0 0

3 1 1 0 0 1 0

3 1 0 0 0 1 1  
0 0 0 0 0 0 0  
0 0 0 0 0 0 0  
1 0 0 0 0 1 2

1B: 7 SF: 0  
2B: 2 SAC: 2  
3B: 0 DP: 1  
HR: 0 HBP: 1

| Batter   | 1          | 2          | 3                          | 4         | 5                                  | 6         | 7                   | 8                   | 9          |
|--|------------|------------|----------------------------|-----------|------------------------------------|-----------|---------------------|---------------------|------------|
| Billy Cox, R (1, 5)<br>OBP: 0.296, SLG: 0.368<br>Jim Russell, S (9, PH)<br>OBP: 0.344, SLG: 0.583  | 1-0<br>6-3 |            | 0-2<br>F8                  |           | 0-0<br>G4-6-3<br>1B                |           | 1-3<br>K            |                     | 4-1<br>BB  |
| Gene Hermanski, L (1, 7)<br>OBP: 0.382, SLG: 0.460   | 0-1<br>2B  |            | 3-1<br>2B<br>1B            |           | 2-0<br>G4-6-3<br>1-2f<br>3-H<br>1B |           | 2-1<br>SH1-4<br>1B  |                     | 0-0<br>4-3 |
| Duke Snider, L (1, 8)<br>OBP: 0.394, SLG: 0.553  | 1-3<br>K   |            | 0-0<br>1B<br>2B            |           | 0-0<br>CS<br>BB                    |           | 1-0<br>SH1-4<br>1-2 |                     |            |
| Jackie Robinson, R (1, 4)<br>OBP: 0.451, SLG: 0.578  | 0-0<br>1-3 |            | 0-1<br>S<br>1B             |           | 1-0<br>CS<br>1-2                   | 1-1<br>F9 | 1-0<br>1B<br>2-H    |                     |            |
| Carl Furillo, R (1, 9)<br>OBP: 0.328, SLG: 0.419   |            | 1-0<br>4-3 | 1-1<br>5-3                 |           | 0-0<br>L4                          |           | 2-2<br>1B           |                     |            |
| Gil Hodges, R (1, 3)<br>OBP: 0.373, SLG: 0.429   |            | 2-2<br>5-3 |                            | 3-3<br>K  |                                    | 2-0<br>E6 | 2-3<br>K            |                     |            |
| Roy Campanella, R (1, 2)<br>OBP: 0.417, SLG: 0.647<br>Eddie Miksis, R (9, PR)<br>OBP: 0.156, SLG: 0.140  |            | 1-3<br>K   |                            | 0-0<br>L9 |                                    | 2-0<br>F7 |                     | 1-1<br>SH3-4<br>HBP |            |
| Pee Wee Reese, R (1, 6)<br>OBP: 0.320, SLG: 0.318  |            |            | 1-1<br>F8<br>S<br>1B<br>1B |           | 1-3<br>K                           |           | 0-0<br>6-3          | 1-0<br>SH3-4<br>1-2 |            |
| Don Newcombe, L (1, 1)<br>OBP: 0.323, SLG: 0.286<br>Jack Banta, L (9, 1)<br>OBP: 0.231, SLG: 0.167<br>Bud Podbielan, R (9, 1)<br>OBP: 0.200, SLG: 0.211<br>George Shuba, L (9, PH)<br>OBP: 0.301, SLG: 0.389 |            |            | 0-1<br>F7                  |           | 0-1<br>E1<br>1B<br>G4-6-3          |           | 2-3<br>K            | 2-3<br>K            |            |

| Inning Stats | R: 0 | H: 1 | E: 0 | LOB: 1 | K: 1 | S: 8 | R: 0 | H: 0 | E: 0 | LOB: 0 | K: 1 | S: 7 | R: 3 | H: 4 | E: 0 | LOB: 1 | K: 0 | S: 15 | R: 0 | H: 0 | E: 0 | LOB: 0 | K: 2 | S: 7 | R: 1 | H: 1 | E: 1 | LOB: 0 | K: 0 | S: 6 | R: 0 | H: 0 | E: 1 | LOB: 1 | K: 0 | S: 5 | R: 0 | H: 0 | E: 0 | LOB: 0 | K: 2 | S: 7 | R: 1 | H: 3 | E: 0 | LOB: 1 | K: 1 | S: 10 | R: 0 | H: 0 | E: 0 | LOB: 2 | K: 1 | S: 7 | 1B: 7 | SF: 0 | 2B: 2 | SAC: 2 | 3B: 0 | DP: 1 | HR: 0 | HBP: 1 | WP: 0 | PA: 39 |
|--------------|------|------|------|--------|------|------|------|------|------|--------|------|------|------|------|------|--------|------|-------|------|------|------|--------|------|------|------|------|------|--------|------|------|------|------|------|--------|------|------|------|------|------|--------|------|------|------|------|------|--------|------|-------|------|------|------|--------|------|------|-------|-------|-------|--------|-------|-------|-------|--------|-------|--------|
|--------------|------|------|------|--------|------|------|------|------|------|--------|------|------|------|------|------|--------|------|-------|------|------|------|--------|------|------|------|------|------|--------|------|------|------|------|------|--------|------|------|------|------|------|--------|------|------|------|------|------|--------|------|-------|------|------|------|--------|------|------|-------|-------|-------|--------|-------|-------|-------|--------|-------|--------|

| PITCHER                                | IP  | WLS | BF | H | R | ER | SO | BB | IBB | HBP | BLK | WP | HR | S  | P  | ERA   | WHIP  |
|--|-----|-----|----|---|---|----|----|----|-----|-----|-----|----|----|----|----|-------|-------|
| Ewell Blackwell, R (1, 1)<br>ERA: 3.48 | 7.0 |     | 28 | 6 | 4 | 3  | 6  | 1  | 0   | 0   | 0   | 0  | 0  | 55 | 85 | 3.86  | 1.000 |
| Harry Perkowski, L (8, 1)<br>ERA: 4.2  | 0.1 |     | 3  | 2 | 1 | 1  | 0  | 0  | 0   | 0   | 0   | 0  | 0  | 4  | 8  | 27.00 | 6.000 |
| Willie Ramsdell, R (8, 1)<br>ERA: 4.22 | 0.2 | W   | 2  | 1 | 0 | 0  | 1  | 0  | 0   | 0   | 0   | 0  | 0  | 6  | 10 | 0.00  | 1.500 |
| Frank Smith, R (9, 1)<br>ERA: 2.8      | 0.1 |     | 2  | 0 | 0 | 0  | 0  | 0  | 0   | 1   | 0   | 0  | 0  | 2  | 4  | 0.00  | 0.000 |
| Howie Fox, R (9, 1)<br>ERA: 5.27       | 0.2 | S   | 3  | 0 | 0 | 0  | 1  | 1  | 0   | 0   | 0   | 0  | 0  | 5  | 11 | 0.00  | 1.500 |

| Batter  | 1   | 2                                | 3                            | 4                                | 5                            | 6                                | 7                            | 8                               | 9                             | AB R H RBI BB SO LOB             | TOP                           |                                  |                               |                                  |                               |                                  |                              |                                  |                                  |                                    |                                  |        |
|---|---|----------------------------------|------------------------------|----------------------------------|------------------------------|----------------------------------|------------------------------|---------------------------------|-------------------------------|----------------------------------|-------------------------------|----------------------------------|-------------------------------|----------------------------------|-------------------------------|----------------------------------|------------------------------|----------------------------------|----------------------------------|------------------------------------|----------------------------------|--------|
| Lloyd Merriman, L (1, 8)<br>OBP: 0.370, SLG: 0.380  | 4-2<br>FC4-6 S<br>BB                                  |                                  | 0-0<br>B1-3                  |                                  | 4-1<br>1B<br>BB              |                                  | 0-2<br>6-3                   | 2-2<br>F7                       |                               | 3 1 0 0 2 0 1                    |                               |                                  |                               |                                  |                               |                                  |                              |                                  |                                  |                                    |                                  |        |
| Peanuts Lowrey, R (1, 7)<br>OBP: 0.381, SLG: 0.338  | 4-1<br>FC4-6<br>BB                                    |                                  | 1-2<br>BB<br>HR<br>1B        |                                  | 4-2<br>1B<br>BB              |                                  | 4-2<br>2B<br>1B<br>BB        | 1-3<br>K                        |                               | 2 2 1 0 3 1 1                    |                               |                                  |                               |                                  |                               |                                  |                              |                                  |                                  |                                    |                                  |        |
| Johnny Wyrostek, L (1, 9)<br>OBP: 0.405, SLG: 0.461 | 2-2<br>F7   |                                  | 4-1<br>HR<br>BB              |                                  | 1-2<br>F6                    |                                  | 2-2<br>1B<br>2B              |                                 | 1-1<br>F7                     | 4 2 1 0 1 0 4                    |                               |                                  |                               |                                  |                               |                                  |                              |                                  |                                  |                                    |                                  |        |
| Ted Kluszewski, L (1, 3)<br>OBP: 0.346, SLG: 0.552  | 1-0<br>FC4-6<br>1-2f<br>2-3                           |                                  | 0-0<br>HR                    |                                  | 1-3<br>K                     |                                  | 1-0<br>1B<br>1B              |                                 | 0-0<br>5-3                    | 5 1 2 5 0 1 4                    |                               |                                  |                               |                                  |                               |                                  |                              |                                  |                                  |                                    |                                  |        |
| Grady Hatton, L (1, 5)<br>OBP: 0.344, SLG: 0.416    | 1-3<br>K  |                                  | 4-0<br>CS<br>BB              |                                  | 0-0<br>1B                    |                                  | 0-0<br>1B                    |                                 | 4-1<br>HR<br>BB               | 3 1 2 1 2 1 2                    |                               |                                  |                               |                                  |                               |                                  |                              |                                  |                                  |                                    |                                  |        |
| Connie Ryan, R (1, 4)<br>OBP: 0.356, SLG: 0.399     |   | 0-0<br>E<br>2B                   | 3-3<br>K<br>1-2              |                                  | 1-3<br>K                     |                                  | 2-3<br>K                     |                                 | 1-0<br>E6<br>HR               | 5 1 1 0 0 3 6                    |                               |                                  |                               |                                  |                               |                                  |                              |                                  |                                  |                                    |                                  |        |
| Bob Scheffing, R (1, 2)<br>OBP: 0.320, SLG: 0.413   |   | 1-0<br>F4                        |                              | 1-0<br>6-3                       |                              | 2-2<br>4-3                       | 1-0<br>F2                    |                                 | 3-0<br>HR                     | 5 1 1 3 0 0 3                    |                               |                                  |                               |                                  |                               |                                  |                              |                                  |                                  |                                    |                                  |        |
| Virgil Stallcup, R (1, 6)<br>OBP: 0.265, SLG: 0.345 |   | 0-3<br>SAFE<br>K                 |                              | 0-0<br>F7                        |                              | 1-3<br>K                         |                              | 1-2<br>S<br>1B                  | 1-0<br>5-3                    | 5 0 1 0 0 2 1                    |                               |                                  |                               |                                  |                               |                                  |                              |                                  |                                  |                                    |                                  |        |
| Herm Wehmeier, R (1, 1)<br>OBP: 0.231, SLG: 0.263   |   | 1-1<br>5-3                       |                              | 0-0<br>F8                        |                              | 1-3<br>K                         |                              | 0-0<br>B3                       |                               | 4 0 0 0 0 1 2                    |                               |                                  |                               |                                  |                               |                                  |                              |                                  |                                  |                                    |                                  |        |
| <b>Inning Stats</b>                                 | R: 0<br>E: 0<br>K: 1<br>S: 11                         | H: 0<br>LOB: 2<br>BB: 2<br>P: 23 | R: 0<br>E: 1<br>K: 1<br>S: 8 | H: 1<br>LOB: 1<br>BB: 0<br>P: 10 | R: 3<br>E: 0<br>K: 1<br>S: 9 | H: 2<br>LOB: 0<br>BB: 2<br>P: 21 | R: 0<br>E: 0<br>K: 0<br>S: 3 | H: 0<br>LOB: 0<br>BB: 0<br>P: 4 | R: 1<br>E: 0<br>K: 2<br>S: 16 | H: 1<br>LOB: 2<br>BB: 2<br>P: 27 | R: 0<br>E: 0<br>K: 2<br>S: 11 | H: 0<br>LOB: 0<br>BB: 0<br>P: 15 | R: 2<br>E: 0<br>K: 1<br>S: 15 | H: 3<br>LOB: 2<br>BB: 1<br>P: 25 | R: 0<br>E: 0<br>K: 1<br>S: 11 | H: 1<br>LOB: 1<br>BB: 0<br>P: 15 | R: 3<br>E: 1<br>K: 0<br>S: 7 | H: 1<br>LOB: 0<br>BB: 1<br>P: 17 | 1B: 5<br>2B: 2<br>3B: 0<br>HR: 2 | SF: 0<br>SAC: 0<br>DP: 0<br>HBP: 0 | WP: 0<br>PB: 0<br>SB: 3<br>CS: 1 | PA: 44 |
| <b>PITCHER</b>                                      | IP WLS BF H R ER SO BB IBB HBP BLK WP HR S P ERA WHIP |                                  |                              |                                  |                              |                                  |                              |                                 |                               |                                  |                               |                                  |                               |                                  |                               |                                  |                              |                                  |                                  |                                    |                                  |        |
| Dan Bankhead, R (1, 1)<br>ERA: 3.86                 | 5.0 L 24 4 4 4 5 6 0 0 0 0 1 47 85 7.20 2.000         |                                  |                              |                                  |                              |                                  |                              |                                 |                               |                                  |                               |                                  |                               |                                  |                               |                                  |                              |                                  |                                  |                                    |                                  |        |
| Erv Palica, R (6, 1)<br>ERA: 5.97                   | 3.0 14 4 2 2 4 1 0 0 0 0 0 37 55 6.00 1.667           |                                  |                              |                                  |                              |                                  |                              |                                 |                               |                                  |                               |                                  |                               |                                  |                               |                                  |                              |                                  |                                  |                                    |                                  |        |
| Joe Hatten, L (9, 1)<br>ERA: 4.03                   | 1.0 6 1 3 0 0 1 0 0 0 0 0 1 7 17 0.00 2.000           |                                  |                              |                                  |                              |                                  |                              |                                 |                               |                                  |                               |                                  |                               |                                  |                               |                                  |                              |                                  |                                  |                                    |                                  |        |

Cincinnati Reds @ Brooklyn Dodgers  
 Ebbets Field, Brooklyn, NY  
 Thu Jun 22 1950, 3:33 AM EDT  
 Att. 19,152 - Unknown

|     |    |
|-----|----|
| AB  | 36 |
| R   | 9  |
| H   | 9  |
| RBI | 9  |
| BB  | 8  |
| SO  | 9  |
| LOB | 24 |



| Batter  | 1  | 2                                   | 3               | 4                                  | 5                       | 6   | 7                              | 8                                       | 9                                   | AB R H RBI BB SO LOB   |
|---|--|-------------------------------------|-----------------|------------------------------------|-------------------------|---|--------------------------------|---|-------------------------------------|--|
| <b>Billy Cox, R</b><br>OBP: 0.292, SLG: 0.361<br>(1, 5)<br>C<br>B<br>B<br>X   | 2-1<br>F8<br>1B<br>BB<br>1B              |                                     | 1-0<br>6-3<br>① |                                    | 1-0<br>L7<br>②          |   |                                | 0-0<br>F5<br>②<br>B<br>B<br>C<br>C<br>X | 3-2<br>F8<br>③                      | 5 1 1 0 0 0 1  |
| <b>Gene Hermanski, L</b><br>OBP: 0.390, SLG: 0.481<br>(1, 7)<br>C<br>X  | 0-1<br>BB<br>1B<br>1-2<br>1B             |                                     | 3-2<br>6-3<br>② |                                    | 1-1<br>L9<br>③          |   |                                | 1-0<br>HR<br>2B                         |                                     | 4 1 2 0 0 0 0  |
| <b>Duke Snider, L</b><br>OBP: 0.392, SLG: 0.562<br>(1, 8)<br>X  | 0-0<br>F8<br>①<br>2-3                    |                                     | 0-0<br>4-3<br>③ |                                    |                         | 2-2<br>4-3<br>①<br>S<br>S<br>F<br>F<br>B<br>X |                                | 0-0<br>HR<br>2-H                        |                                     | 4 1 1 2 0 0 2  |
| <b>Jackie Robinson, R</b><br>OBP: 0.448, SLG: 0.572<br>(1, 4)<br>X  | 0-0<br>BB<br>1-2<br>1B                   |                                     |                 | 0-3<br>K<br>①<br>C<br>C<br>C       |                         | 0-2<br>F6<br>②<br>C<br>F<br>X                 |                                | 2-2<br>6-3<br>③<br>C<br>B<br>B<br>X     |                                     | 4 0 1 0 0 1 0  |
| <b>Carl Furillo, R</b><br>OBP: 0.331, SLG: 0.416<br>(1, 9)<br>B<br>B<br>B<br>B  | 4-0<br>G5-4-3<br>1-2<br>2-3<br>3-H<br>BB |                                     |                 | 1-2<br>L5<br>②<br>F<br>F<br>B<br>X |                         | 2-2<br>F9<br>③<br>S<br>F<br>B<br>X            |                                | 4-1<br>HR<br>BB                         |                                     | 2 1 0 1 2 0 0  |
| <b>Gil Hodges, R</b><br>OBP: 0.376, SLG: 0.442<br>(1, 3)<br>F<br>X  | 0-1<br>G5-4-3<br>②<br>③<br>1-2f          |                                     |                 | 4-2<br>BB<br>BB<br>BB              |                         |   | 0-1<br>L7<br>①<br>C<br>X       |   | 2-1<br>HR<br>1-H                    | 3 1 1 2 1 0 3  |
| <b>Roy Campanella, R</b><br>OBP: 0.413, SLG: 0.634<br>(1, 2)<br>C<br>B<br>B<br>X  |  | 2-2<br>4-3<br>①<br>C<br>B<br>B<br>X |                 | 4-2<br>BB<br>BB                    |                         |   | 2-0<br>L7<br>②<br>B<br>B<br>X  |   | 1-2<br>6-3<br>①<br>C<br>B<br>B<br>X | 3 0 0 0 1 0 0  |
| <b>Pee Wee Reese, R</b><br>OBP: 0.313, SLG: 0.310<br>(1, 6)<br>C<br>B<br>B<br>X   |  | 2-2<br>F8<br>②<br>C<br>B<br>B<br>X  |                 | 2-2<br>F7<br>③<br>B<br>B<br>X      |                         |   | 2-0<br>6-3<br>③<br>B<br>B<br>X |   | 0-1<br>5-3<br>②<br>C<br>X           | 4 0 0 0 0 0 2  |
| <b>Dan Bankhead, R</b><br>OBP: 0.321, SLG: 0.333<br>(5, PH)<br><b>Wayne Bejard, L</b><br>(6, 1)<br><b>Erv Palica, R</b><br>OBP: 0.250, SLG: 0.250<br>(8, PH)<br><b>Tommy Brown, R</b><br>OBP: 0.267, SLG: 0.500<br>(9, 1)<br><b>Joe Hatten, R</b><br>OBP: 0.100, SLG: 0.100<br>(9, PH)<br><b>Jim Russell, S</b><br>OBP: 0.351, SLG: 0.600 |  | 0-1<br>6-3<br>③<br>S<br>X           |                 |                                    | 0-3<br>K<br>①<br>S<br>C |   |                                | 2-3<br>K<br>①<br>B<br>F<br>S<br>B<br>S  | 3-2<br>2B                           | 1 0 0 0 0 0 0<br>1 0 0 0 0 0 1<br>0 0 0 0 0 0 0<br>1 0 0 0 0 0 1<br>0 0 0 0 0 0 0<br>1 0 1 0 0 0 0 |

| Inning Stats   | R: 1 | H: 3 | E: 0 | K: 0 | S: 8 | H: 3 | LOB: 2 | BB: 1 | P: 14 | R: 0 | H: 0 | E: 0 | K: 0 | S: 8 | H: 0 | LOB: 0 | BB: 0 | P: 12 | R: 0 | H: 0 | E: 0 | K: 0 | S: 6 | H: 0 | LOB: 2 | BB: 2 | P: 24 | R: 0 | H: 0 | E: 0 | K: 1 | S: 13 | R: 0 | H: 0  | E: 0 | K: 1 | S: 6 | H: 0 | LOB: 0 | BB: 0 | P: 8 | R: 0 | H: 0 | E: 0 | K: 0 | S: 12 | H: 0 | LOB: 0 | BB: 0 | P: 16 | R: 0 | H: 0 | E: 0 | K: 0 | S: 4 | H: 0 | LOB: 0 | BB: 0 | P: 8 | R: 2 | H: 2 | E: 0 | K: 1 | S: 9 | H: 2 | LOB: 0 | BB: 0 | P: 14 | R: 2  | H: 2 | E: 0 | K: 0 | S: 14 | H: 2 | LOB: 1 | BB: 1 | P: 27 | 1B: 3 | 2B: 2 | 3B: 0 | HR: 2 | SF: 0 | SAC: 0 | DP: 1 | HBP: 0 | WP: 0 | PA: 37 |
|--|------|------|------|------|------|------|--------|-------|-------|------|------|------|------|------|------|--------|-------|-------|------|------|------|------|------|------|--------|-------|-------|------|------|------|------|-------|------|-------|------|------|------|------|--------|-------|------|------|------|------|------|-------|------|--------|-------|-------|------|------|------|------|------|------|--------|-------|------|------|------|------|------|------|------|--------|-------|-------|-------|------|------|------|-------|------|--------|-------|-------|-------|-------|-------|-------|-------|--------|-------|--------|-------|--------|
| <b>PITCHER</b><br><b>Herm Wehmeier, R</b><br>ERA: 6.77<br>(1, 1) | IP   | WLS  | BF   | H    | R    | ER   | SO     | BB    | IBB   | HBP  | BLK  | WP   | HR   | S    | P    | ERA    | WHIP  |       |      |      |      |      |      |      |        |       |       |      |      |      |      |       |      |       |      | IP   | WLS  | BF   | H      | R     | ER   | SO   | BB   | IBB  | HBP  | BLK   | WP   | HR     | S     | P     | ERA  | WHIP |      |      |      |      |        |       |      |      |      |      |      |      |      |        |       |       |       |      |      |      |       |      |        |       |       |       |       |       |       |       |        |       |        |       |        |
|  |      |      |      |      |      |      |        |       |       |      |      |      |      |      |      |        |       | 9.0   | W    | 37   | 7    | 5    | 5    | 3    | 4      | 0     | 0     | 0    | 0    | 2    | 80   | 133   | 5.00 | 1.222 |      |      |      |      |        |       |      |      |      |      |      |       |      |        |       |       |      |      | 9.0  | W    | 37   | 7    | 5      | 5     | 3    | 4    | 0    | 0    | 0    | 0    | 2    | 80     | 133   | 5.00  | 1.222 |      |      |      |       |      |        |       |       |       |       |       |       |       |        |       |        |       |        |

**BOTTOM**

**Cincinnati Reds @ Brooklyn Dodgers**  
Ebbets Field, Brooklyn, NY

Thu Jun 22 1950, 3:33 AM EDT  
Att. 19,152 - Unknown

|            |           |
|------------|-----------|
| <b>AB</b>  | <b>33</b> |
| <b>R</b>   | <b>5</b>  |
| <b>H</b>   | <b>7</b>  |
| <b>RBI</b> | <b>5</b>  |
| <b>BB</b>  | <b>4</b>  |
| <b>SO</b>  | <b>3</b>  |
| <b>LOB</b> | <b>8</b>  |

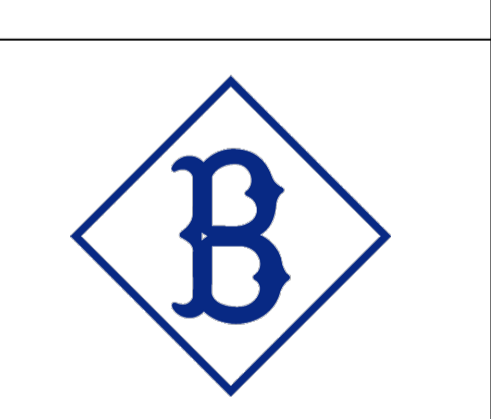

| Batter   | 1   | 2   | 3   | 4   | 5   | 6   | 7   | 8   | 9   | AB R H RBI BB SO LOB  | TOP   |   |    |   |   |   |    |     |   |    |   |    |   |     |    |
|--|---|---|---|---|---|---|---|---|---|---|---|---|----|---|---|---|----|-----|---|----|---|----|---|-----|----|
| Lloyd Merriman, L (1, 8)<br>OBP: 0.357, SLG: 0.365<br>Bob Usher, R (9, PH)<br>OBP: 0.315, SLG: 0.379   | 0-0<br>G3   |   | 0-0<br>5-3  |   | 0-3<br>K  |   | 0-0<br>SH3-4  |   | 0-0<br>P6   | 3 0 0 0 0 1 0<br>1 0 0 0 0 0 1                              | <p><b>Cincinnati Reds @ New York Giants</b><br/>Polo Grounds, New York, NY<br/>Fri Jun 23 1950, 3:33 AM EDT<br/>Att. 16,957 - Unknown</p> <p>livebaseballscorecards.com</p> <table border="1"> <tr><td>AB</td><td>36</td></tr> <tr><td>R</td><td>2</td></tr> <tr><td>H</td><td>11</td></tr> <tr><td>RBI</td><td>2</td></tr> <tr><td>BB</td><td>1</td></tr> <tr><td>SO</td><td>5</td></tr> <tr><td>LOB</td><td>19</td></tr> </table>  | AB  | 36 | R | 2 | H | 11 | RBI | 2 | BB | 1 | SO | 5 | LOB | 19 |
| AB   | 36  |   |   |   |   |   |   |   |   |   |   |   |    |   |   |   |    |     |   |    |   |    |   |     |    |
| R  | 2   |   |   |   |   |   |   |   |   |   |   |   |    |   |   |   |    |     |   |    |   |    |   |     |    |
| H  | 11  |   |   |   |   |   |   |   |   |   |   |   |    |   |   |   |    |     |   |    |   |    |   |     |    |
| RBI  | 2   |   |   |   |   |   |   |   |   |   |   |   |    |   |   |   |    |     |   |    |   |    |   |     |    |
| BB   | 1   |   |   |   |   |   |   |   |   |   |   |   |    |   |   |   |    |     |   |    |   |    |   |     |    |
| SO   | 5   |   |   |   |   |   |   |   |   |   |   |   |    |   |   |   |    |     |   |    |   |    |   |     |    |
| LOB  | 19  |   |   |   |   |   |   |   |   |   |   |   |    |   |   |   |    |     |   |    |   |    |   |     |    |
| Peanuts Lowrey, R (1, 7)<br>OBP: 0.376, SLG: 0.333   | 0-0<br>1B   |   | 0-0<br>5-3  |   | 0-0<br>F9   |   | 0-0<br>F7   |   | 0-0<br>F7   | 5 0 1 0 0 0 2   |   |   |    |   |   |   |    |     |   |    |   |    |   |     |    |
| Johnny Wyrostek, L (1, 9)<br>OBP: 0.406, SLG: 0.462  | 0-3<br>K  |   | 0-0<br>1B   |   | 0-0<br>1B   |   | 0-0<br>F8   |   |   | 4 0 2 0 0 1 2   |   |   |    |   |   |   |    |     |   |    |   |    |   |     |    |
| Bob Scheffing, R (1, 2)<br>OBP: 0.315, SLG: 0.400  |   | 0-0<br>P3   | 0-0<br>F9   |   | 0-3<br>K  |   |   | 0-0<br>1B   |   | 4 0 1 0 0 1 2   |   |   |    |   |   |   |    |     |   |    |   |    |   |     |    |
| Ted Kluszewski, L (1, 3)<br>OBP: 0.349, SLG: 0.568   |   | 0-0<br>1B   |   | 0-0<br>HR   |   | 0-0<br>4-3  |   | 0-0<br>P4   |   | 4 2 2 1 0 0 1   |   |   |    |   |   |   |    |     |   |    |   |    |   |     |    |
| Connie Ryan, R (1, 4)<br>OBP: 0.360, SLG: 0.401  |   | 0-0<br>1B   |   | 0-0<br>E6   |   | 0-0<br>F5   |   | 0-0<br>F8   |   | 4 0 2 0 0 0 1   |   |   |    |   |   |   |    |     |   |    |   |    |   |     |    |
| Grady Hatton, L (1, 5)<br>OBP: 0.347, SLG: 0.418   |   | 0-0<br>1B   |   | 0-3<br>K  |   | 0-0<br>1B   |   | 0-0<br>F2   |   | 4 0 2 0 0 1 2   |   |   |    |   |   |   |    |     |   |    |   |    |   |     |    |
| Virgil Stallcup, R (1, 6)<br>OBP: 0.265, SLG: 0.339  |   | 0-0<br>F8   |   | 0-0<br>E6   |   | 0-0<br>F8   |   | 4-0<br>BB   |   | 3 0 0 1 1 0 4   |   |   |    |   |   |   |    |     |   |    |   |    |   |     |    |
| Howie Fox, R (1, 1)<br>OBP: 0.238, SLG: 0.286<br>Frank Smith, R (7, 1)<br>OBP: 0.100, SLG: 0.100<br>Bobby Adams, R (9, PH)<br>OBP: 0.323, SLG: 0.311 |   | 0-3<br>K  |   | 0-0<br>FC4-6  |   | 0-0<br>SH3-4  |   | 0-0<br>F8   |   | 3 0 1 0 0 1 3<br>0 0 0 0 0 0 0<br>1 0 0 0 0 0 1             |   |   |    |   |   |   |    |     |   |    |   |    |   |     |    |
| <b>Inning Stats</b>  | R: 0 H: 1<br>E: 0 LOB: 1<br>K: 1 BB: 0<br>S: 5 P: 5   | R: 1 H: 3<br>E: 0 LOB: 2<br>K: 1 BB: 0<br>S: 8 P: 8 | R: 0 H: 1<br>E: 0 LOB: 1<br>K: 0 BB: 0<br>S: 4 P: 4 | R: 1 H: 2<br>E: 1 LOB: 1<br>K: 1 BB: 0<br>S: 7 P: 7 | R: 0 H: 1<br>E: 0 LOB: 1<br>K: 2 BB: 0<br>S: 8 P: 8 | R: 0 H: 1<br>E: 0 LOB: 1<br>K: 0 BB: 0<br>S: 4 P: 4 | R: 0 H: 1<br>E: 0 LOB: 1<br>K: 0 BB: 0<br>S: 4 P: 4 | R: 0 H: 1<br>E: 0 LOB: 1<br>K: 0 BB: 0<br>S: 4 P: 4 | R: 0 H: 0<br>E: 0 LOB: 1<br>K: 0 BB: 1<br>S: 3 P: 7 | 1B: 10 SF: 0<br>2B: 1 SAC: 1<br>3B: 0 DP: 1<br>HR: 1 HBP: 0 | WP: 0 PA: 38<br>PB: 0<br>SB: 1<br>CS: 1   |   |    |   |   |   |    |     |   |    |   |    |   |     |    |
| <b>PITCHER</b><br>Monty Kennedy, L (1, 1)<br>ERA: 4.48   | IP WLS BF H R ER SO BB IBB HBP BLK WP HR S P ERA WHIP |   |   |   |   |   |   |   |   |   |   | <b>PITCHER</b><br>IP WLS BF H R ER SO BB IBB HBP BLK WP HR S P ERA WHIP |    |   |   |   |    |     |   |    |   |    |   |     |    |

| Batter   | 1                               | 2                         | 3                    | 4                | 5                | 6                | 7                        | 8         | 9 |
|--|---------------------------------|---------------------------|----------------------|------------------|------------------|------------------|--------------------------|-----------|---|
| Eddie Stanky, R<br>OBP: 0.473, SLG: 0.436 (1, 4)   | 0-0<br>FC4-6<br>1B              |                           | 0-0<br>6-3           | 0-0<br>F9        |                  |                  | 0-0<br>E5<br>SH1-4<br>HR | 0-0<br>F8 |   |
| Whitey Lockman, L<br>OBP: 0.389, SLG: 0.453 (1, 7) | 0-0<br>FC4-6<br>E<br>F8<br>1-2f |                           | 0-0<br>F7            |                  | 0-0<br>F9        |                  | 0-0<br>SH1-4<br>1-2      |           |   |
| Don Mueller, L<br>OBP: 0.321, SLG: 0.423 (1, 9)    | 0-0<br>E1<br>1-3                |                           | 0-0<br>1B<br>1B      |                  | 0-0<br>3-1       |                  | 0-0<br>2-H<br>HR         |           |   |
| Hank Thompson, L<br>OBP: 0.411, SLG: 0.509 (1, 5)  | 0-0<br>F8<br>3-H                |                           | 0-0<br>FC6-4<br>1B   |                  | 4-0<br>CS<br>BB  |                  | 0-0<br>HR                |           |   |
| Wes Westrum, R<br>OBP: 0.391, SLG: 0.476 (1, 2)    | 0-0<br>F7<br>1-2f               |                           | 0-0<br>FC6-4<br>1-2f |                  | 0-0<br>CS<br>1-2 | 0-0<br>5-3       | 0-0<br>F8                |           |   |
| Bobby Thomson, R<br>OBP: 0.333, SLG: 0.431 (1, 8)  |                                 | 0-0<br>3-1<br>SH1-3<br>2B |                      | 0-0<br>6-3       |                  | 0-0<br>6-3       | 0-0<br>1B                |           |   |
| Tookie Gilbert, L<br>OBP: 0.321, SLG: 0.349 (1, 3) |                                 | 0-0<br>3-1<br>2-3         |                      | 4-0<br>1B<br>BB  |                  | 4-0<br>1B<br>BB  | 0-0<br>F7                |           |   |
| Alvin Dark, R<br>OBP: 0.322, SLG: 0.408 (1, 6)     |                                 | 0-0<br>SH1-3<br>3-H       |                      | 0-0<br>1-2<br>1B |                  | 0-0<br>1-3<br>1B | 0-0<br>6-3               |           |   |
| Monty Kennedy, R<br>OBP: 0.077, SLG: 0.077 (1, 1)  |                                 | 0-0<br>P6                 |                      | 0-3<br>K         |                  | 0-0<br>4-3       | 0-0<br>1-3               |           |   |

| Inning Stats | R: 1   | H: 1  | E: 1 | K: 0   | S: 5  | R: 1 | H: 1   | E: 0  | K: 0 | S: 4   | R: 0  | H: 2  | E: 0   | K: 0  | S: 5 | R: 0   | H: 1  | E: 0 | K: 1   | S: 6  | R: 0 | H: 0   | E: 0  | K: 0 | S: 2   | R: 0  | H: 1   | E: 0  | K: 0 | S: 4  | R: 3   | H: 3  | E: 1   | K: 0  | S: 7  | R: 0   | H: 0  | E: 0   | K: 0  | S: 3  |       |
|--------------|--------|-------|------|--------|-------|------|--------|-------|------|--------|-------|-------|--------|-------|------|--------|-------|------|--------|-------|------|--------|-------|------|--------|-------|--------|-------|------|-------|--------|-------|--------|-------|-------|--------|-------|--------|-------|-------|-------|
|              | LOB: 1 | BB: 0 | P: 5 | LOB: 0 | BB: 0 | P: 4 | LOB: 2 | BB: 0 | P: 5 | LOB: 2 | BB: 1 | P: 10 | LOB: 0 | BB: 1 | P: 6 | LOB: 2 | BB: 1 | P: 8 | LOB: 1 | BB: 0 | P: 7 | LOB: 0 | BB: 0 | P: 3 | LOB: 0 | BB: 0 | LOB: 0 | BB: 0 | P: 3 | SF: 0 | SAC: 2 | DP: 0 | HBP: 0 | 1B: 6 | SF: 0 | SAC: 2 | DP: 0 | HBP: 0 | 2B: 1 | 3B: 0 | HR: 2 |

| PITCHER                            | IP  | WLS | BF | H | R | ER | SO | BB | IBB | HBP | BLK | WP | HR | S  | P  | ERA  | WHIP  |
|------------------------------------|-----|-----|----|---|---|----|----|----|-----|-----|-----|----|----|----|----|------|-------|
| Howie Fox, R<br>ERA: 5.16 (1, 1)   | 6.1 | L   | 31 | 8 | 5 | 3  | 1  | 3  | 0   | 0   | 0   | 0  | 2  | 30 | 42 | 4.26 | 1.737 |
| Frank Smith, R<br>ERA: 2.68 (7, 1) | 1.2 |     | 6  | 1 | 0 | 0  | 0  | 0  | 0   | 0   | 0   | 0  | 0  | 6  | 6  | 0.00 | 0.600 |

AB R H RBI BB SO LOB

|   |   |   |   |   |   |   |
|---|---|---|---|---|---|---|
| 5 | 1 | 1 | 0 | 0 | 0 | 2 |
| 3 | 1 | 0 | 0 | 0 | 0 | 1 |
| 4 | 1 | 2 | 2 | 0 | 0 | 1 |
| 3 | 1 | 2 | 2 | 1 | 0 | 1 |
| 4 | 0 | 0 | 0 | 0 | 0 | 3 |
| 4 | 1 | 2 | 0 | 0 | 0 | 0 |
| 2 | 0 | 0 | 0 | 2 | 0 | 2 |
| 3 | 0 | 2 | 1 | 0 | 0 | 0 |
| 4 | 0 | 0 | 0 | 0 | 1 | 4 |

| AB | R | H | RBI | BB | SO | LOB |
|----|---|---|-----|----|----|-----|
| 32 | 5 | 9 | 5   | 3  | 1  | 14  |



**Cincinnati Reds @ New York Giants**  
 Polo Grounds, New York, NY  
 Fri Jun 23 1950, 3:33 AM EDT  
 Att. 16,957 - Unknown

livebaseballscorecards.com

| WP | PA |
|----|----|
| 0  | 38 |

| WP | HR | S | P | ERA  | WHIP  |
|----|----|---|---|------|-------|
| 0  | 0  | 0 | 0 | 0.00 | 0.600 |

| Batter  | 1  | 2                               | 3                            | 4                               | 5                            | 6                               | 7                            | 8                               | 9                            | AB R H RBI BB SO LOB  | TOP                          |                                 |                              |                                 |                              |                                 |                                  |                                    |                                  |                |  |
|---|--|---------------------------------|------------------------------|---------------------------------|------------------------------|---------------------------------|------------------------------|---------------------------------|------------------------------|---|------------------------------|---------------------------------|------------------------------|---------------------------------|------------------------------|---------------------------------|----------------------------------|------------------------------------|----------------------------------|----------------|--|
| Lloyd Merriman, L (1, 8)<br>OBP: 0.352, SLG: 0.359  | 0-3<br>K   |                                 | 0-0<br>4-3                   |                                 |                              | 0-0<br>1B                       |                              | 0-0<br>F7                       |                              | 4 0 1 0 0 1 1   |                              |                                 |                              |                                 |                              |                                 |                                  |                                    |                                  |                |  |
| Peanuts Lowrey, R (1, 7)<br>OBP: 0.379, SLG: 0.345<br>Jim Bolger, R (8, 7)  | 0-0<br>1B  |                                 | 0-0<br>5-3                   |                                 |                              | 0-0<br>F9                       |                              | 0-0<br>WP<br>4-3<br>2B          |                              | 4 1 2 0 0 0 1<br>0 0 0 0 0 0 0  |                              |                                 |                              |                                 |                              |                                 |                                  |                                    |                                  |                |  |
| Johnny Wyrostek, L (1, 9)<br>OBP: 0.412, SLG: 0.465<br>Bob Usher, R (8, 9)  | 0-0<br>1B  |                                 |                              | 0-0<br>F4                       |                              | 0-0<br>1B                       |                              | 4-0<br>2-3<br>3-H<br>4-3<br>BB  |                              | 3 0 2 0 1 0 0<br>0 0 0 0 0 0 0  |                              |                                 |                              |                                 |                              |                                 |                                  |                                    |                                  |                |  |
| Ted Kluszewski, L (1, 3)<br>OBP: 0.342, SLG: 0.556  | 0-0<br>P3  |                                 |                              | 0-0<br>F6                       |                              | 0-0<br>F5                       |                              | 0-0<br>4-3                      |                              | 4 0 0 1 0 0 4   |                              |                                 |                              |                                 |                              |                                 |                                  |                                    |                                  |                |  |
| Grady Hatton, L (1, 5)<br>OBP: 0.345, SLG: 0.415  | 0-0<br>F8  |                                 |                              | 0-0<br>F8                       |                              |                                 | 0-0<br>G5-4-3<br>1B          | 0-0<br>F9                       |                              | 4 0 1 0 0 0 3   |                              |                                 |                              |                                 |                              |                                 |                                  |                                    |                                  |                |  |
| Connie Ryan, R (1, 4)<br>OBP: 0.354, SLG: 0.394<br>Sammy Meeks, R (7, 6)<br>OBP: 0.265, SLG: 0.355  |  | 0-0<br>F6                       |                              | 0-3<br>K                        |                              | 0-0<br>G5-4-3                   |                              | 0-0<br>F3                       |                              | 3 0 0 0 0 1 1<br>1 0 0 0 0 0 0  |                              |                                 |                              |                                 |                              |                                 |                                  |                                    |                                  |                |  |
| Dixie Howell, R (1, 2)<br>OBP: 0.330, SLG: 0.282  |  | 0-3<br>K                        |                              | 0-3<br>K                        |                              | 0-0<br>1-2f                     |                              | 0-0<br>5-3                      |                              | 4 0 1 0 0 2 0   |                              |                                 |                              |                                 |                              |                                 |                                  |                                    |                                  |                |  |
| Virgil Stallcup, R (1, 6)<br>OBP: 0.261, SLG: 0.333<br>Bobby Adams, R (7, 4)<br>OBP: 0.321, SLG: 0.309  |  | 0-0<br>F7                       |                              | 0-0<br>E5                       |                              | 0-0<br>F8                       |                              | 0-0<br>F9                       |                              | 3 0 0 0 0 0 1<br>1 0 0 0 0 0 0  |                              |                                 |                              |                                 |                              |                                 |                                  |                                    |                                  |                |  |
| Ken Raffensberger, R (1, 1)<br>OBP: 0.250, SLG: 0.242<br>Eddie Erault, R (3, 1)<br>Joe Adcock, R (5, PH)<br>OBP: 0.191, SLG: 0.178<br>Johnny Hetki, R (5, 1)<br>Harry Perkowski, L (8, PH)<br>OBP: 0.417, SLG: 0.417 (8, 1) |  |                                 | 0-0<br>6-3                   |                                 | 0-0<br>4-3                   |                                 |                              | 0-0<br>2B<br>WP<br>1B           |                              | 1 0 0 0 0 0 0 0<br>0 0 0 0 0 0 0 0<br>1 0 0 0 0 0 0 1<br>0 0 0 0 0 0 0 0<br>1 1 1 0 0 0 0 0 |                              |                                 |                              |                                 |                              |                                 |                                  |                                    |                                  |                |  |
| <b>Inning Stats</b>   | R: 0<br>E: 0<br>K: 1<br>S: 7   | H: 2<br>LOB: 2<br>BB: 0<br>P: 7 | R: 0<br>E: 0<br>K: 1<br>S: 5 | H: 0<br>LOB: 0<br>BB: 0<br>P: 5 | R: 0<br>E: 0<br>K: 0<br>S: 3 | H: 0<br>LOB: 0<br>BB: 0<br>P: 3 | R: 0<br>E: 1<br>K: 2<br>S: 8 | H: 0<br>LOB: 1<br>BB: 0<br>P: 8 | R: 0<br>E: 0<br>K: 0<br>S: 4 | H: 2<br>LOB: 1<br>BB: 0<br>P: 4   | R: 0<br>E: 0<br>K: 0<br>S: 4 | H: 2<br>LOB: 1<br>BB: 0<br>P: 4 | R: 2<br>E: 0<br>K: 0<br>S: 5 | H: 2<br>LOB: 1<br>BB: 1<br>P: 9 | R: 0<br>E: 0<br>K: 0<br>S: 3 | H: 0<br>LOB: 0<br>BB: 0<br>P: 3 | 1B: 6<br>2B: 1<br>3B: 1<br>HR: 0 | SF: 0<br>SAC: 0<br>DP: 1<br>HBP: 0 | WP: 1<br>PB: 0<br>SB: 0<br>CS: 0 | PA: 35         |  |
| <b>PITCHER</b><br>Sheldon Jones, R (1, 1)<br>ERA: 4.09  | IP: 9.0<br>WLS: W<br>BF: 35<br>H: 8<br>R: 2<br>ER: 2<br>SO: 4<br>BB: 1<br>IBB: 0<br>HBP: 0<br>BLK: 0<br>WP: 1<br>HR: 0<br>S: 42<br>P: 46<br>ERA: 2.00<br>WHIP: 1.000 |                                 |                              |                                 |                              |                                 |                              |                                 |                              |   |                              |                                 |                              |                                 |                              |                                 |                                  |                                    |                                  | <b>PITCHER</b> | IP: 9.0<br>WLS: W<br>BF: 35<br>H: 8<br>R: 2<br>ER: 2<br>SO: 4<br>BB: 1<br>IBB: 0<br>HBP: 0<br>BLK: 0<br>WP: 1<br>HR: 0<br>S: 42<br>P: 46<br>ERA: 2.00<br>WHIP: 1.000 |

Cincinnati Reds @ New York Giants  
Polo Grounds, New York, NY  
Sat Jun 24 1950, 3:33 AM EDT  
Att: 10,434 - Unknown

livebaseballscorecards.com

AB 34  
R 2  
H 8  
RBI 1  
BB 1  
SO 4  
LOB 12



| Batter   | 1          | 2                  | 3                     | 4                     | 5                              | 6                | 7                | 8                   | 9 | AB | R | H | RBI | BB | SO | LOB |
|--|------------|--------------------|-----------------------|-----------------------|--------------------------------|------------------|------------------|---------------------|---|----|---|---|-----|----|----|-----|
| Eddie Stanky, R<br>OBP: 0.473, SLG: 0.434<br>Bill Rigney, R<br>OBP: 0.314, SLG: 0.233<br>(1, 4)<br>(7, PH)<br>(8, 4) | 0-0<br>1-3 | 0-0<br>2-H<br>1B   |                       | 4-0<br>BB<br>G3-6-3   | 0-0<br>F7                      |                  | 0-0<br>F8        |                     |   | 3  | 0 | 1 | 1   | 1  | 0  | 3   |
| Whitey Lockman, L<br>OBP: 0.385, SLG: 0.461<br>(1, 7)  | 0-0<br>6-3 | 0-0<br>L3          |                       | 0-0<br>G3-6-3<br>1-2f |                                | 0-0<br>G3        | 0-0<br>HR        |                     |   | 5  | 1 | 1 | 1   | 0  | 0  | 2   |
| Monte Irvin, R<br>OBP: 0.365, SLG: 0.405<br>(1, 9)   | 0-0<br>F8  |                    | 0-0<br>6-3            | 0-0<br>P2             |                                | 0-0<br>HR        | 1-0<br>HR<br>HBP |                     |   | 4  | 2 | 1 | 1   | 0  | 0  | 0   |
| Wes Westrum, R<br>OBP: 0.406, SLG: 0.552<br>(1, 2)   |            | 0-0<br>HR          | 0-0<br>HR             |                       | 4-0<br>BB<br>BB                | 0-0<br>2B<br>3B  | 0-0<br>1-H<br>HR |                     |   | 4  | 5 | 4 | 4   | 1  | 0  | 0   |
| Bobby Thomson, R<br>OBP: 0.335, SLG: 0.428<br>(1, 8)   |            | 0-3<br>K           | 0-0<br>2B<br>F8<br>1B |                       | 4-0<br>BB<br>BB<br>1-2         | 0-0<br>F4        | 0-0<br>F2        |                     |   | 4  | 1 | 1 | 0   | 1  | 1  | 1   |
| Alvin Dark, R<br>OBP: 0.329, SLG: 0.430<br>Rudy Rufer, R<br>(7, PH)<br>(8, 6)  |            | 0-0<br>HR          | 0-0<br>1-3<br>2B      |                       | 0-0<br>F8                      | 4-0<br>2B<br>BB  | 0-0<br>1-3<br>3  |                     |   | 3  | 1 | 2 | 1   | 1  | 0  | 2   |
| Hank Thompson, L<br>OBP: 0.425, SLG: 0.537<br>(1, 5)   |            | 0-0<br>HR          | 4-0<br>IBB            |                       | 4-0<br>BB<br>1-2<br>2-3        | 0-0<br>1-3<br>2B |                  | 4-0<br>BB<br>G4-6-3 |   | 2  | 1 | 2 | 2   | 3  | 0  | 0   |
| Tookie Gilbert, L<br>OBP: 0.328, SLG: 0.349<br>(1, 3)  |            | 0-0<br>SH2-4<br>1B | 0-0<br>F8             |                       | 4-0<br>BB<br>1-2<br>2-3<br>3-H | 4-0<br>IBB       | 0-0<br>F9        |                     |   | 3  | 1 | 1 | 2   | 2  | 0  | 3   |
| Sheldon Jones, R<br>OBP: 0.136, SLG: 0.050<br>(1, 1)   |            | 0-0<br>SH2-4       | 0-0<br>4-3            |                       | 0-0<br>P2                      | 0-0<br>6-3       | 0-0<br>G4-6-3    |                     |   | 4  | 0 | 0 | 0   | 0  | 0  | 9   |

| Inning Stats                                |     | R: 0 | H: 0 | E: 0 | K: 0 | S: 3 | R: 4 | H: 5 | E: 0 | K: 1 | S: 10 | R: 2 | H: 3 | E: 0 | K: 0 | S: 6 | R: 0  | H: 0  | E: 0 | K: 0 | S: 2 | R: 1 | H: 0 | E: 0 | K: 0 | S: 3 | R: 2 | H: 3 | E: 0 | K: 0 | S: 6 | R: 3 | H: 2 | E: 0 | K: 0 | S: 5 | R: 0 | H: 0 | E: 0 | K: 0 | S: 2 |
|---|-----|------|------|------|------|------|------|------|------|------|-------|------|------|------|------|------|-------|-------|------|------|------|------|------|------|------|------|------|------|------|------|------|------|------|------|------|------|------|------|------|------|------|
| PITCHER                                     |     | IP   | WLS  | BF   | H    | R    | ER   | SO   | BB   | IBB  | HBP   | BLK  | WP   | HR   | S    | P    | ERA   | WHIP  |      |      |      |      |      |      |      |      |      |      |      |      |      |      |      |      |      |      |      |      |      |      |      |
| Ken Raffensberger, L<br>ERA: 4.32<br>(1, 1) | 2.1 | L    | 13   | 6    | 5    | 5    | 1    | 1    | 0    | 0    | 0     | 0    | 0    | 4    | 15   | 15   | 19.29 | 2.571 |      |      |      |      |      |      |      |      |      |      |      |      |      |      |      |      |      |      |      |      |      |      |      |
| Eddie Erault, R<br>ERA: 7.92<br>(3, 1)      | 1.2 |      | 8    | 2    | 1    | 1    | 0    | 1    | 1    | 0    | 0     | 0    | 0    | 0    | 6    | 14   | 5.40  | 1.800 |      |      |      |      |      |      |      |      |      |      |      |      |      |      |      |      |      |      |      |      |      |      |      |
| Johnny Hetki, R<br>ERA: 7.78<br>(5, 1)      | 3.0 |      | 21   | 5    | 6    | 6    | 0    | 5    | 1    | 1    | 0     | 0    | 0    | 3    | 14   | 39   | 18.00 | 3.333 |      |      |      |      |      |      |      |      |      |      |      |      |      |      |      |      |      |      |      |      |      |      |      |
| Harry Perkowski, L<br>ERA: 3.94<br>(8, 1)   | 1.0 |      | 3    | 0    | 0    | 0    | 0    | 1    | 0    | 0    | 0     | 0    | 0    | 0    | 2    | 6    | 0.00  | 1.000 |      |      |      |      |      |      |      |      |      |      |      |      |      |      |      |      |      |      |      |      |      |      |      |

**BOTTOM**

**Cincinnati Reds @ New York Giants**  
Polo Grounds, New York, NY  
Sat Jun 24 1950, 3:33 AM EDT  
Att. 10,434 - Unknown

|     |    |
|-----|----|
| AB  | 34 |
| R   | 12 |
| H   | 13 |
| RBI | 12 |
| BB  | 9  |
| SO  | 1  |
| LOB | 20 |

livebaseballscorecards.com



|       |        |
|-------|--------|
| WP: 0 | PA: 45 |
| PB: 0 |        |
| SB: 0 |        |
| CS: 0 |        |

| Batter   | 1   | 2   | 3   | 4   | 5   | 6   | 7   | 8  | 9  | AB R H RBI BB SO LOB                                       | TOP                                     |                |   |
|--|---|---|---|---|---|---|---|--|--|--|---|----------------|---|
| Lloyd Merriman, L (1, 8)<br>OBP: 0.348, SLG: 0.354   | 0-0<br>3-1  |   | 0-3<br>K  |   | 0-0<br>3B 1B  |   | 0-0<br>4-3  |  | 0-0<br>SH3-4   | 4 1 1 1 0 1 0  |   |                |   |
| Peanuts Lowrey, R (1, 7)<br>OBP: 0.374, SLG: 0.340   | 0-0<br>6-3  |   |   | 0-0<br>6-3  | 0-0<br>F7   |   |   | 0-0<br>F8  | 0-0<br>1B 1B   | 5 0 1 0 0 0 2  |   |                |   |
| Johnny Wyrostek, L (1, 9)<br>OBP: 0.421, SLG: 0.488  | 0-0<br>2B   |   |   | 0-0<br>3-1  | 0-0<br>3B   |   |   | 0-0<br>FC1-6 1B                                      | 0-0<br>1B  | 5 0 4 3 0 0 0  |   |                |   |
| Ted Kluszewski, L (1, 3)<br>OBP: 0.338, SLG: 0.551<br>Joe Adcock, R (9, 3)<br>OBP: 0.191, SLG: 0.178   | 0-0<br>F8   |   |   | 0-0<br>2B   | 0-0<br>F7   |   |   | 0-0<br>FC1-6 1B                                      | 0-0<br>F7  | 5 1 1 0 0 0 5<br>0 0 0 0 0 0 0                             |   |                |   |
| Grady Hatton, L (1, 5)<br>OBP: 0.342, SLG: 0.406   |   | 0-0<br>4-3  |   | 0-0<br>G3   |   | 0-0<br>3-1  |   | 4-0<br>1B 1B BB                                      | 0-3<br>K   | 4 0 0 0 1 1 3  |   |                |   |
| Connie Ryan, R (1, 4)<br>OBP: 0.357, SLG: 0.396  |   | 0-0<br>F8   |   |   | 0-0<br>F5   | 0-0<br>G1-6-3 1B                                    |   | 0-0<br>FC5 1B  |  | 4 0 2 1 0 0 0  |   |                |   |
| Dixie Howell, R (1, 2)<br>OBP: 0.326, SLG: 0.280   |   | 0-0<br>6-3  |   |   | 0-0<br>E5 1B  | 0-0<br>G1-6-3                                       |   | 0-0<br>1B  |  | 4 1 1 0 0 0 1  |   |                |   |
| Virgil Stallcup, R (1, 6)<br>OBP: 0.255, SLG: 0.326  |   |   | 0-0<br>6-3  |   | 0-0<br>E5 1B  |   | 0-0<br>F8   | 0-0<br>FC5   |  | 4 1 0 0 0 0 4  |   |                |   |
| Ewell Blackwell, R (1, 1)<br>OBP: 0.161, SLG: 0.103<br>Bobby Adams, R (9, PH)<br>OBP: 0.325, SLG: 0.309<br>Herm Wehmeier, R (9, 1)<br>OBP: 0.231, SLG: 0.263 |   |   | 0-0<br>F8   |   | 0-0<br>3B 1B  |   | 0-0<br>6-3  |  | 4-0<br>1B SH3-4 BB                                   | 3 1 1 1 0 0 0<br>0 1 0 0 1 0 0<br>0 0 0 0 0 0 0            |   |                |   |
| <b>Inning Stats</b>  | R: 0 H: 1<br>E: 0 LOB: 1<br>K: 0 BB: 0<br>S: 4 P: 4   | R: 0 H: 0<br>E: 0 LOB: 0<br>K: 0 BB: 0<br>S: 3 P: 3 | R: 0 H: 0<br>E: 0 LOB: 0<br>K: 1 BB: 0<br>S: 5 P: 5 | R: 0 H: 1<br>E: 0 LOB: 1<br>K: 0 BB: 0<br>S: 4 P: 4 | R: 4 H: 3<br>E: 2 LOB: 1<br>K: 0 BB: 0<br>S: 8 P: 8 | R: 0 H: 1<br>E: 0 LOB: 0<br>K: 0 BB: 0<br>S: 3 P: 3 | R: 0 H: 0<br>E: 0 LOB: 0<br>K: 0 BB: 0<br>S: 3 P: 3 | R: 1 H: 3<br>E: 0 LOB: 3<br>K: 0 BB: 1<br>S: 6 P: 10 | R: 1 H: 2<br>E: 0 LOB: 2<br>K: 1 BB: 1<br>S: 7 P: 11 | 1B: 8 SF: 0<br>2B: 2 SAC: 1<br>3B: 1 DP: 1<br>HR: 0 HBP: 0 | WP: 0 PA: 41<br>PB: 0<br>SB: 0<br>CS: 0 |                |   |
| <b>PITCHER</b>   | IP WLS BF H R ER SO BB IBB HBP BLK WP HR S P ERA WHIP |   |   |   |   |   |   |  |  |  |   | <b>PITCHER</b> | IP WLS BF H R ER SO BB IBB HBP BLK WP HR S P ERA WHIP |
| Jack Kramer, R (1, 1)<br>ERA: 4.36   | 7.0 L 28 6 4 0 1 0 0 0 0 0 0 0 0 30 30 0.00 0.857     |   |   |   |   |   |   |  |  |  |   |                |   |
| Andy Hansen, R (8, 1)<br>ERA: 3.97   | 1.0 7 3 1 1 0 1 0 0 0 0 0 0 0 6 10 9.00 4.000         |   |   |   |   |   |   |  |  |  |   |                |   |
| Kirby Higbe, R (9, 1)<br>ERA: 4.91   | 0.1 4 2 1 1 0 1 0 0 0 0 0 0 0 3 7 27.00 9.000         |   |   |   |   |   |   |  |  |  |   |                |   |
| Dave Koslo, L (9, 1)<br>ERA: 3.56  | 0.2 2 0 0 0 0 1 0 0 0 0 0 0 0 4 4 0.00 0.000          |   |   |   |   |   |   |  |  |  |   |                |   |

Cincinnati Reds @ New York Giants  
Polo Grounds, New York, NY  
Sun Jun 25 1950, 3:33 AM EDT  
Unknown

livebaseballscorecards.com

|     |    |
|-----|----|
| AB  | 38 |
| R   | 6  |
| H   | 11 |
| RBI | 6  |
| BB  | 2  |
| SO  | 2  |
| LOB | 15 |





| Batter   | 1                                     | 2         | 3                | 4                                | 5         | 6                         | 7  | 8                       | 9          | AB | R | H | RBI | BB | SO | LOB |
|--|---------------------------------------|-----------|------------------|----------------------------------|-----------|---------------------------|--|-------------------------|------------|----|---|---|-----|----|----|-----|
| <b>Eddie Stanky, R</b> (1, 4)<br>OBP: 0.476, SLG: 0.430      | 4-0<br>E<br>FC1-5<br>1B<br>BB         |           | 4-0<br>4-3<br>BB |                                  | 0-0<br>F7 |                           | 4-0<br>FC3-6<br>1-2<br>BB                | 0-0<br>E5<br>WP<br>1B   |            | 2  | 0 | 0 | 0   | 3  | 0  | 1   |
| <b>Whitey Lockman, L</b> (1, 7)<br>OBP: 0.386, SLG: 0.459    | 0-0<br>E1<br>BB<br>FC1-5<br>1-3<br>1B |           | 0-0<br>4-3       |                                  | 0-0<br>P4 |                           | 0-0<br>P4                                | 0-0<br>WP<br>1-2<br>1B  |            | 5  | 0 | 2 | 0   | 0  | 0  | 4   |
| <b>Don Mueller, L</b> (1, 9)<br>OBP: 0.311, SLG: 0.410       | 0-0<br>FC1-5<br>1-2<br>3-H<br>BB      |           | 0-0<br>5-3       |                                  | 0-0<br>F5 |                           | 0-0<br>FC3-6<br>FC5<br>1-2f<br>2-3<br>1B | 0-0<br>G3<br>1-2<br>2-3 |            | 5  | 0 | 0 | 0   | 0  | 0  | 8   |
| <b>Hank Thompson, L</b> (1, 5)<br>OBP: 0.429, SLG: 0.536     | 4-0<br>G4-6-3<br>1-2<br>2-3<br>BB     |           |                  | 0-0<br>FC3-6<br>HBP<br>1B        |           | 0-0<br>F7                 | 0-0<br>1-2<br>3-H<br>1B                  |                         | 0-0<br>4-3 | 4  | 0 | 2 | 1   | 1  | 0  | 0   |
| <b>Wes Westrum, R</b> (1, 2)<br>OBP: 0.396, SLG: 0.537       | 0-0<br>G4-6-3<br>1-2f                 |           |                  | 0-0<br>P4                        |           | 0-3<br>K                  | 0-0<br>FC5<br>2-3f                       |                         | 0-0<br>F8  | 5  | 0 | 0 | 0   | 0  | 1  | 6   |
| <b>Bobby Thomson, R</b> (1, 8)<br>OBP: 0.336, SLG: 0.424     |                                       | 0-0<br>F8 |                  | 1-0<br>FC3-6<br>HBP<br>1B        |           | 0-0<br>BB<br>1B           |  | 0-0<br>6-3              | 0-0<br>F8  | 4  | 0 | 1 | 0   | 0  | 0  | 0   |
| <b>Tookie Gilbert, L</b> (1, 3)<br>OBP: 0.327, SLG: 0.343    |                                       | 0-3<br>K  |                  | 0-0<br>FC3-6<br>S<br>1-2f<br>2-3 |           | 4-0<br>FC5-4<br>1-2<br>BB |  | 0-3<br>K                |            | 3  | 0 | 0 | 0   | 1  | 2  | 2   |
| <b>Alvin Dark, R</b> (1, 6)<br>OBP: 0.328, SLG: 0.424        |                                       | 0-3<br>K  |                  | 0-0<br>6-3<br>1-2                |           | 0-0<br>FC5-4<br>1-2f      |  | 4-0<br>3B<br>BB         |            | 3  | 1 | 0 | 0   | 1  | 1  | 4   |
| <b>Jack Kramer, R</b> (1, 1)<br>OBP: 0.350, SLG: 0.596       |                                       |           | 0-0<br>6-3       |                                  | 4-0<br>BB |                           | 0-0<br>FC3-6<br>BB<br>1B<br>1B           | 0-0<br>1-H<br>E<br>3B   |            | 1  | 0 | 0 | 0   | 1  | 0  | 0   |
| <b>Spider Jorgensen, L</b> (7, PH)<br>OBP: 0.252, SLG: 0.067 |                                       |           |                  |                                  |           |                           |  |                         |            | 1  | 1 | 1 | 0   | 0  | 0  | 0   |
| <b>Andy Hansson, R</b> (8, 1)<br>OBP: 0.282, SLG: 0.067      |                                       |           |                  |                                  |           |                           |  |                         |            | 0  | 0 | 0 | 0   | 0  | 0  | 0   |
| <b>Roy Weatherly, L</b> (8, PH)<br>OBP: 0.488, SLG: 0.567    |                                       |           |                  |                                  |           |                           |  |                         |            | 1  | 1 | 1 | 1   | 0  | 0  | 0   |
| <b>Kirby Higbe, R</b> (9, 1)<br>OBP: 0.250, SLG: 0.250       |                                       |           |                  |                                  |           |                           |  |                         |            | 0  | 0 | 0 | 0   | 0  | 0  | 0   |
| <b>Dave Koslo, L</b> (9, 1)<br>OBP: 0.091, SLG: 0.032        |                                       |           |                  |                                  |           |                           |  |                         |            | 0  | 0 | 0 | 0   | 0  | 0  | 0   |

| Inning Stats                                  | R: 0 | H: 1 | E: 1 | K: 0 | S: 3 | R: 0 | H: 0 | E: 0 | K: 2 | S: 7 | R: 0 | H: 0 | E: 0 | K: 0 | S: 3 | R: 0 | H: 1  | E: 0 | K: 0 | S: 4 | R: 0 | H: 0 | E: 0 | K: 0 | S: 3 | R: 0 | H: 1 | E: 0 | K: 1 | S: 6 | R: 1 | H: 2 | E: 0 | K: 0 | S: 5 | R: 2 | H: 2 | E: 1 | K: 1 | S: 8 | R: 0 | H: 0 | E: 0 | K: 0 | S: 3 | 1B: 6 | 2B: 0 | 3B: 1 | HR: 0 | SF: 0 | SAC: 0 | DP: 1 | HBP: 1 | WP: 1 | PB: 0 | SB: 1 | CS: 0 | PA: 42 |
|---|------|------|------|------|------|------|------|------|------|------|------|------|------|------|------|------|-------|------|------|------|------|------|------|------|------|------|------|------|------|------|------|------|------|------|------|------|------|------|------|------|------|------|------|------|------|-------|-------|-------|-------|-------|--------|-------|--------|-------|-------|-------|-------|--------|
| <b>PITCHER</b>                                | IP   | WLS  | BF   | H    | R    | ER   | SO   | BB   | IBB  | HBP  | BLK  | WP   | HR   | S    | P    | ERA  | WHIP  |      |      |      |      |      |      |      |      |      |      |      |      | IP   | WLS  | BF   | H    | R    | ER   | SO   | BB   | IBB  | HBP  | BLK  | WP   | HR   | S    | P    | ERA  | WHIP  |       |       |       |       |        |       |        |       |       |       |       |        |
| <b>Ewell Blackwell, R</b> (1, 1)<br>ERA: 3.38 | 8.0  | W    | 39   | 7    | 3    | 2    | 4    | 7    | 0    | 1    | 0    | 1    | 0    | 39   | 68   | 2.25 | 1.750 |      |      |      |      |      |      |      |      |      |      |      |      |      |      |      |      |      |      |      |      |      |      |      |      |      |      |      |      |       |       |       |       |       |        |       |        |       |       |       |       |        |
| <b>Herm Wehmeier, R</b> (9, 1)<br>ERA: 6.7    | 1.0  | S    | 3    | 0    | 0    | 0    | 0    | 0    | 0    | 0    | 0    | 0    | 0    | 3    | 3    | 0.00 | 0.000 |      |      |      |      |      |      |      |      |      |      |      |      |      |      |      |      |      |      |      |      |      |      |      |      |      |      |      |      |       |       |       |       |       |        |       |        |       |       |       |       |        |

**BOTTOM**

**Cincinnati Reds @ New York Giants**  
Polo Grounds, New York, NY  
Sun Jun 25 1950, 3:33 AM EDT  
Unknown

|            |           |
|------------|-----------|
| <b>AB</b>  | <b>34</b> |
| <b>R</b>   | <b>3</b>  |
| <b>H</b>   | <b>7</b>  |
| <b>RBI</b> | <b>2</b>  |
| <b>BB</b>  | <b>7</b>  |
| <b>SO</b>  | <b>4</b>  |
| <b>LOB</b> | <b>25</b> |



|       |        |
|-------|--------|
| WP: 1 | PA: 42 |
| PB: 0 |        |
| SB: 1 |        |
| CS: 0 |        |

| Batter   | 1   | 2   | 3   | 4   | 5   | 6   | 7   | 8   | 9   | AB R H RBI BB SO LOB                                       | TOP                                     |                |   |
|--|---|---|---|---|---|---|---|---|---|--|---|----------------|---|
| Lloyd Merriman, L (1, 8)<br>OBP: 0.354, SLG: 0.360<br>Bob Usher, R (8, 8)<br>OBP: 0.313, SLG: 0.376    | 0-0<br>G1-6-3<br>1B                                   |   | 0-0<br>6-3<br>1B                                    |   | 0-0<br>F5   |   | 0-0<br>E2   |   | 0-0<br>F8   | 4 0 2 1 0 0 0<br>1 0 0 0 0 0 0                             |   |                |   |
| Peanuts Lowrey, R (1, 7)<br>OBP: 0.363, SLG: 0.329   | 0-0<br>G1-6-3<br>1-2f                                 |   | 0-0<br>6-3  |   | 0-0<br>F7   |   | 0-0<br>F2   |   | 0-0<br>6-3  | 5 0 0 0 0 0 3  |   |                |   |
| Johnny Wyrostek, L (1, 9)<br>OBP: 0.416, SLG: 0.495  | 0-0<br>F8   |   | 0-0<br>3-1  |   |   | 0-0<br>HR   | 0-0<br>E6<br>G4-3                                   |   | 0-0<br>F9   | 5 1 1 1 0 0 2  |   |                |   |
| Ted Kluszewski, L (1, 3)<br>OBP: 0.342, SLG: 0.566   |   | 0-0<br>HR   |   | 0-0<br>1B<br>S                                      |   | 0-0<br>L3   | 0-0<br>G4-3   |   |   | 4 2 2 1 0 0 2  |   |                |   |
| Grady Hatton, L (1, 5)<br>OBP: 0.341, SLG: 0.403   |   | 0-0<br>4-3  |   | 0-3<br>K<br>1-2                                     |   | 0-0<br>IHR<br>S                                     |   | 0-0<br>E4<br>1B                                     |   | 4 1 1 0 0 1 1  |   |                |   |
| Connie Ryan, R (1, 4)<br>OBP: 0.349, SLG: 0.387  |   | 0-0<br>F9   |   | 0-3<br>K<br>1-2                                     |   | 0-0<br>P5   |   | 0-0<br>F7   |   | 4 0 0 0 0 1 3  |   |                |   |
| Johnny Pramesa, R (1, 2)<br>OBP: 0.323, SLG: 0.439   |   | 0-3<br>K  |   | 0-0<br>1B<br>2-H                                    |   | 0-0<br>IHR  |   | 0-0<br>1B<br>1-2                                    |   | 4 1 3 3 0 1 0  |   |                |   |
| Virgil Stallcup, R (1, 6)<br>OBP: 0.260, SLG: 0.340  |   |   | 0-0<br>4-3<br>1B<br>2B                              |   | 0-0<br>4-3  |   | 0-0<br>2B   |   | 0-0<br>P3   | 4 1 2 0 0 0 3  |   |                |   |
| Willie Ramsdell, R (1, 1)<br>OBP: 0.200, SLG: 0.200<br>Frank Smith, R (4, 1)<br>OBP: 0.077, SLG: 0.077 |   |   | 0-0<br>4-3  |   | 0-0<br>F8   |   | 0-0<br>6-3  |   | 0-3<br>K  | 1 0 0 0 0 0 1<br>3 0 0 0 0 1 3                             |   |                |   |
| <b>Inning Stats</b>  | R: 0 H: 1<br>E: 0 LOB: 0<br>K: 0 BB: 0<br>S: 3 P: 3   | R: 1 H: 1<br>E: 0 LOB: 0<br>K: 1 BB: 0<br>S: 6 P: 6 | R: 1 H: 2<br>E: 0 LOB: 1<br>K: 0 BB: 0<br>S: 5 P: 5 | R: 1 H: 2<br>E: 0 LOB: 1<br>K: 2 BB: 0<br>S: 9 P: 9 | R: 0 H: 0<br>E: 0 LOB: 0<br>K: 0 BB: 0<br>S: 3 P: 3 | R: 3 H: 4<br>E: 0 LOB: 1<br>K: 0 BB: 0<br>S: 7 P: 7 | R: 0 H: 0<br>E: 2 LOB: 1<br>K: 0 BB: 0<br>S: 4 P: 4 | R: 0 H: 1<br>E: 1 LOB: 2<br>K: 1 BB: 0<br>S: 7 P: 7 | R: 0 H: 0<br>E: 0 LOB: 0<br>K: 0 BB: 0<br>S: 3 P: 3 | 1B: 6 SF: 0<br>2B: 2 SAC: 0<br>3B: 0 DP: 2<br>HR: 3 HBP: 0 | WP: 0 PA: 39<br>PB: 0<br>SB: 2<br>CS: 0 |                |   |
| <b>PITCHER</b>   | IP WLS BF H R ER SO BB IBB HBP BLK WP HR S P ERA WHIP |   |   |   |   |   |   |   |   |  |   | <b>PITCHER</b> | IP WLS BF H R ER SO BB IBB HBP BLK WP HR S P ERA WHIP |
| Sal Maglie, R (1, 1)<br>ERA: 4.15<br>Dave Koslo, L (7, 1)<br>ERA: 3.44                                 | 6.0 L 27 10 6 6 3 0 0 0 0 0 0 2 33 33 9.00 1.667      |   |   |   |   |   |   |   |   |  |   |                |   |

Cincinnati Reds @ New York Giants  
Polo Grounds, New York, NY  
Sun Jun 25 1950, 3:38 AM EDT  
Att. 22,464 - Unknown

livebaseballscorecards.com

AB 39  
R 6  
H 11  
RBI 6  
BB 0  
SO 4  
LOB 18



| Batter  | 1        | 2            | 3               | 4                   | 5        | 6         | 7        | 8        | 9             | AB R H RBI BB SO LOB   |
|---|----------|--------------|-----------------|---------------------|----------|-----------|----------|----------|---------------|--|
| Alvin Dark, R (1, 6)<br>OBP: 0.326, SLG: 0.425<br>Spider Jorgensen, L (9, PH)<br>OBP: 0.211, SLG: 0.063   | 0-3 K ①  |              | 0-0 FC3-6 1B 2B | 0-0 FC1-5-2 ②       |          | 0-3 K ③   |          |          | 0-0 FC4-6 ①   | 4 1 1 0 0 2 3<br>1 0 0 0 0 0 1   |
| Whitey Lockman, L (1, 7)<br>OBP: 0.382, SLG: 0.452  | 0-3 K ②  |              | 4-0 FC3-6 BB    | 0-0 F5 ③            |          |           | 0-0 F7 ① |          | 0-0 F7 ②      | 4 0 0 0 0 1 1 3  |
| Don Mueller, L (1, 9)<br>OBP: 0.308, SLG: 0.404   | 0-0 G3 ③ |              | 0-0 FC3-6 1B ①  |                     | 0-0 F9 ① |           | 0-0 F7 ① |          | 0-0 F7 ③      | 5 0 1 0 0 0 0 3  |
| Hank Thompson, L (1, 5)<br>OBP: 0.426, SLG: 0.546   |          | 0-0 IHR      | 0-0 F2 ②        |                     | 0-0 F7 ② |           | 0-0 F8 ② |          |               | 4 1 1 1 0 0 0 3  |
| Bobby Thomson, R (1, 8)<br>OBP: 0.335, SLG: 0.421   |          | 0-0 F2 ①     | 0-0 F3 ③        |                     | 0-0 F3 ③ |           | 0-0 F8 ③ |          |               | 4 0 1 1 0 0 0 1  |
| Tookie Gilbert, L (1, 3)<br>OBP: 0.325, SLG: 0.337  |          | 4-0 2B F8 BB | 0-3 K ③         |                     |          | 0-0 E3 F9 |          | 0-0 F9 ① |               | 3 2 0 0 0 1 1 2  |
| Bill Rigney, R (1, 4)<br>OBP: 0.333, SLG: 0.294   |          | 0-0 F8 ②     |                 | 0-0 E 1B FC1-5-2 1B |          | 0-0 F9 ①  |          | 0-0 L5 ② |               | 4 0 2 1 0 0 0 0  |
| Sam Calderone, R (1, 2)<br>OBP: 0.350, SLG: 0.400   |          | 0-0 F8 ②     |                 | 0-0 E7 FC1-5-2 1B   |          | 0-0 E6    |          | 0-0 F9 ③ |               | 4 0 1 1 0 0 0 1  |
| Sal Maglie, R (1, 1)<br>OBP: 0.111, SLG: 0.222<br>Roy Weatherly, L (6, PH)<br>OBP: 0.472, SLG: 0.548<br>Dave Koslo, L (7, 1)<br>OBP: 0.091, SLG: 0.032<br>Eddie Stanky, R (9, PH)<br>OBP: 0.478, SLG: 0.430 |          | 0-3 K ③      |                 | 0-0 P4 ①            |          | 0-0 F2 ②  |          |          | 1-0 FC4-6 HBP | 2 0 0 0 0 0 1 3<br>1 0 0 0 0 0 0 1<br>0 0 0 0 0 0 0 0<br>0 0 0 0 0 0 0 0 |

| Inning Stats | R: 0<br>E: 0<br>K: 2<br>S: 7 | H: 0<br>LOB: 0<br>BB: 0<br>P: 7 | R: 2<br>E: 0<br>K: 1<br>S: 7 | H: 2<br>LOB: 1<br>BB: 1<br>P: 11 | R: 1<br>E: 0<br>K: 1<br>S: 7 | H: 2<br>LOB: 2<br>BB: 1<br>P: 11 | R: 0<br>E: 1<br>K: 0<br>S: 5 | H: 2<br>LOB: 2<br>BB: 0<br>P: 5 | R: 0<br>E: 0<br>K: 0<br>S: 3 | H: 0<br>LOB: 0<br>BB: 0<br>P: 3 | R: 1<br>E: 2<br>K: 1<br>S: 7 | H: 0<br>LOB: 1<br>BB: 0<br>P: 7 | R: 0<br>E: 0<br>K: 0<br>S: 4 | H: 1<br>LOB: 1<br>BB: 0<br>P: 4 | R: 0<br>E: 0<br>K: 0<br>S: 3 | H: 0<br>LOB: 0<br>BB: 0<br>P: 3 | R: 0<br>E: 0<br>K: 0<br>S: 3 | H: 0<br>LOB: 1<br>BB: 0<br>P: 4 | 1B: 4<br>2B: 2<br>3B: 0<br>HR: 1 | SF: 0<br>SAC: 0<br>DP: 0<br>HBP: 1 | WP: 0<br>PB: 0<br>SB: 0<br>CS: 0 | PA: 39 |
|--------------|------------------------------|---------------------------------|------------------------------|----------------------------------|------------------------------|----------------------------------|------------------------------|---------------------------------|------------------------------|---------------------------------|------------------------------|---------------------------------|------------------------------|---------------------------------|------------------------------|---------------------------------|------------------------------|---------------------------------|----------------------------------|------------------------------------|----------------------------------|--------|
|--------------|------------------------------|---------------------------------|------------------------------|----------------------------------|------------------------------|----------------------------------|------------------------------|---------------------------------|------------------------------|---------------------------------|------------------------------|---------------------------------|------------------------------|---------------------------------|------------------------------|---------------------------------|------------------------------|---------------------------------|----------------------------------|------------------------------------|----------------------------------|--------|

| PITCHER                               | IP  | WLS | BF | H | R | ER | SO | BB | IBB | HBP | BLK | WP | HR | S  | P  | ERA  | WHIP  |
|---------------------------------------|-----|-----|----|---|---|----|----|----|-----|-----|-----|----|----|----|----|------|-------|
| Willie Ramsdell, R (1, 1)<br>ERA: 4.5 | 3.0 |     | 17 | 6 | 3 | 3  | 4  | 2  | 0   | 0   | 0   | 0  | 0  | 23 | 31 | 9.00 | 2.667 |
| Frank Smith, R (4, 1)<br>ERA: 2.3     | 6.0 | W   | 22 | 1 | 1 | 0  | 1  | 0  | 0   | 1   | 0   | 0  | 0  | 23 | 24 | 0.00 | 0.167 |

**BOTTOM**

**Cincinnati Reds @ New York Giants**  
 Polo Grounds, New York, NY  
 Sun Jun 25 1950, 3:38 AM EDT  
 Att. 22,464 - Unknown

livebaseballscorecards.com

|            |           |
|------------|-----------|
| <b>AB</b>  | <b>36</b> |
| <b>R</b>   | <b>4</b>  |
| <b>H</b>   | <b>7</b>  |
| <b>RBI</b> | <b>4</b>  |
| <b>BB</b>  | <b>2</b>  |
| <b>SO</b>  | <b>5</b>  |
| <b>LOB</b> | <b>21</b> |



| Batter  | 1   | 2                               | 3                            | 4                               | 5                            | 6                                | 7                            | 8                               | 9                            | AB R H RBI BB SO LOB            | TOP   |                                 |                              |                                 |                              |                                 |                              |                                 |                                   |                                    |                                  |        |
|---|---|---------------------------------|------------------------------|---------------------------------|------------------------------|----------------------------------|------------------------------|---------------------------------|------------------------------|---------------------------------|---|---------------------------------|------------------------------|---------------------------------|------------------------------|---------------------------------|------------------------------|---------------------------------|-----------------------------------|------------------------------------|----------------------------------|--------|
| Lloyd Merriman, L (1, 8)<br>OBP: 0.347, SLG: 0.352  | 0-0<br>1-3  | 0-0<br>FC6                      |                              | 0-0<br>E<br>1B                  | 0-0<br>F5                    |                                  | 0-0<br>F8                    |                                 |                              | 5 1 1 0 0 0 4                   |   |                                 |                              |                                 |                              |                                 |                              |                                 |                                   |                                    |                                  |        |
| Peanuts Lowrey, R (1, 7)<br>OBP: 0.353, SLG: 0.319  | 0-3<br>K  |                                 | 0-0<br>6-3                   | 0-0<br>F8                       | 0-0<br>F9                    |                                  |                              | 0-0<br>5-3                      |                              | 5 0 0 0 0 1 3                   |   |                                 |                              |                                 |                              |                                 |                              |                                 |                                   |                                    |                                  |        |
| Johnny Wyrostek, L (1, 9)<br>OBP: 0.416, SLG: 0.491 | 4-0<br>BB   |                                 | 0-0<br>F9                    | 0-0<br>E9<br>1B                 | 0-0<br>FC5-4                 |                                  |                              | 0-0<br>F9                       |                              | 4 0 1 0 1 0 2                   |   |                                 |                              |                                 |                              |                                 |                              |                                 |                                   |                                    |                                  |        |
| Ted Kluszewski, L (1, 3)<br>OBP: 0.348, SLG: 0.565  | 0-0<br>F4   |                                 | 4-0<br>BB<br>1B              | 0-0<br>HR<br>1B                 |                              | 0-0<br>1B                        |                              | 0-0<br>F8                       |                              | 4 2 2 1 1 0 1                   |   |                                 |                              |                                 |                              |                                 |                              |                                 |                                   |                                    |                                  |        |
| Grady Hatton, L (1, 5)<br>OBP: 0.342, SLG: 0.417    |   | 0-0<br>F8                       | 0-0<br>BB<br>1B              | 0-0<br>HR<br>1B                 |                              | 0-0<br>F9                        |                              | 0-0<br>F2                       |                              | 5 2 2 2 0 0 1                   |   |                                 |                              |                                 |                              |                                 |                              |                                 |                                   |                                    |                                  |        |
| Connie Ryan, R (1, 4)<br>OBP: 0.356, SLG: 0.389     |   | 0-0<br>1B                       | 4-0<br>BB<br>1B              | 0-0<br>6-3                      |                              | 0-0<br>F9                        |                              | 0-0<br>S<br>1B                  |                              | 4 2 2 0 1 0 1                   |   |                                 |                              |                                 |                              |                                 |                              |                                 |                                   |                                    |                                  |        |
| Dixie Howell, R (1, 2)<br>OBP: 0.340, SLG: 0.282    |   | 0-0<br>F8<br>1B                 | 4-0<br>BB<br>1B              |                                 | 4-0<br>1B<br>BB              |                                  | 0-0<br>1-3                   |                                 | 0-0<br>F9                    | 3 1 1 1 2 0 2                   | AB 39<br>R 8<br>H 13<br>RBI 8<br>BB 6<br>SO 1<br>LOB 20 |                                 |                              |                                 |                              |                                 |                              |                                 |                                   |                                    |                                  |        |
| Virgil Stallcup, R (1, 6)<br>OBP: 0.274, SLG: 0.349 |   | 0-0<br>FC6<br>1B                | 0-0<br>FC6-4<br>1B           |                                 | 0-0<br>1B<br>1B              |                                  | 0-0<br>F7                    |                                 | 4-0<br>FC4-6<br>IBB          | 4 0 3 3 1 0 0                   |   |                                 |                              |                                 |                              |                                 |                              |                                 |                                   |                                    |                                  |        |
| Herm Wehmeier, R (1, 1)<br>OBP: 0.233, SLG: 0.262   |   | 0-0<br>F8                       | 0-0<br>FC6-4                 |                                 | 0-0<br>FC5-4<br>1B           |                                  | 0-0<br>1-4-3                 |                                 | 0-0<br>FC4-6                 | 4 0 1 1 0 0 4                   |   |                                 |                              |                                 |                              |                                 |                              |                                 |                                   |                                    |                                  |        |
| Ewell Blackwell, R (7, 1)<br>OBP: 0.156, SLG: 0.100 |   |                                 |                              |                                 |                              |                                  |                              |                                 | 1-2f                         | 1 0 0 0 0 0 2                   |   |                                 |                              |                                 |                              |                                 |                              |                                 |                                   |                                    |                                  |        |
| Inning Stats  | R: 0<br>E: 0<br>K: 1<br>S: 5                          | H: 0<br>LOB: 1<br>BB: 1<br>P: 9 | R: 1<br>E: 0<br>K: 0<br>S: 6 | H: 3<br>LOB: 2<br>BB: 0<br>P: 6 | R: 3<br>E: 0<br>K: 0<br>S: 5 | H: 2<br>LOB: 2<br>BB: 3<br>P: 17 | R: 3<br>E: 1<br>K: 0<br>S: 6 | H: 4<br>LOB: 0<br>BB: 0<br>P: 6 | R: 1<br>E: 0<br>K: 0<br>S: 5 | H: 2<br>LOB: 2<br>BB: 1<br>P: 9 | R: 0<br>E: 0<br>K: 0<br>S: 4                            | H: 1<br>LOB: 1<br>BB: 0<br>P: 4 | R: 0<br>E: 0<br>K: 0<br>S: 3 | H: 0<br>LOB: 0<br>BB: 0<br>P: 3 | R: 0<br>E: 0<br>K: 0<br>S: 3 | H: 0<br>LOB: 0<br>BB: 0<br>P: 3 | R: 0<br>E: 0<br>K: 0<br>S: 4 | H: 1<br>LOB: 2<br>BB: 1<br>P: 8 | 1B: 12<br>2B: 0<br>3B: 0<br>HR: 1 | SF: 0<br>SAC: 0<br>DP: 0<br>HBP: 0 | WP: 0<br>PB: 0<br>SB: 1<br>CS: 0 | PA: 45 |
| PITCHER   | IP WLS BF H R ER SO BB IBB HBP BLK WP HR S P ERA WHIP |                                 |                              |                                 |                              |                                  |                              |                                 |                              |                                 |   |                                 |                              |                                 |                              |                                 |                              |                                 |                                   |                                    |                                  |        |
| Bill MacDonald, R (1, 1)<br>ERA: 4.92               | 4.0 L 24 9 7 7 1 4 0 0 0 0 0 1 22 38 15.75 3.250      |                                 |                              |                                 |                              |                                  |                              |                                 |                              |                                 |   |                                 |                              |                                 |                              |                                 |                              |                                 |                                   |                                    |                                  |        |
| Frank Papish, L (5, 1)<br>ERA: 27.0                 | 0.0 2 1 1 1 0 1 0 0 0 0 0 0 1 5 ∞ ∞                   |                                 |                              |                                 |                              |                                  |                              |                                 |                              |                                 |   |                                 |                              |                                 |                              |                                 |                              |                                 |                                   |                                    |                                  |        |
| Junior Walsh, R (5, 1)<br>ERA: 6.14                 | 1.0 4 1 0 0 0 0 0 0 0 0 0 0 4 4 0.00 1.000            |                                 |                              |                                 |                              |                                  |                              |                                 |                              |                                 |   |                                 |                              |                                 |                              |                                 |                              |                                 |                                   |                                    |                                  |        |
| Vic Lombardi, L (6, 1)<br>ERA: 8.41                 | 4.0 15 2 0 0 0 0 0 1 0 0 0 0 14 18 0.00 0.500         |                                 |                              |                                 |                              |                                  |                              |                                 |                              |                                 |   |                                 |                              |                                 |                              |                                 |                              |                                 |                                   |                                    |                                  |        |

Cincinnati Reds @ Pittsburgh Pirates  
 Forbes Field, Pittsburgh, PA  
 Tue Jun 27 1950, 3:33 AM EDT  
 Att. 13,500 - Unknown - 65 F

livebaseballscorecards.com



| Batter  | 1                        | 2                        | 3                        | 4                        | 5                        | 6                        | 7                        | 8                        | 9                        | AB                       | R                         | H                       | RBI    | BB | SO | LOB |
|---|--------------------------|--------------------------|--------------------------|--------------------------|--------------------------|--------------------------|--------------------------|--------------------------|--------------------------|--------------------------|---------------------------|-------------------------|--------|----|----|-----|
| Stan Rojek, R (1, 6)<br>OBP: 0.281, SLG: 0.286<br>George Strickland, R (7, 6)<br>OBP: 0.250, SLG: 0.125   | 0-3 K ①                  |                          | 0-0 BB 1B                |                          | 0-0 FC4-6 1B             | 0-3 K ②                  |                          | 0-0 FC6 1B               |                          | 4                        | 0                         | 2                       | 0      | 0  | 2  | 1   |
| Ted Beard, L (1, 8)<br>OBP: 0.374, SLG: 0.386   | 0-3 K ②                  |                          | 4-0 BB 1-2               |                          | 0-0 FC4-6 BB 1B 1-2f     | 0-0 FC6 1-2f             |                          | 0-0 FC6 WP 1-2f          |                          | 4                        | 1                         | 0                       | 0      | 1  | 1  | 3   |
| Ralph Kiner, R (1, 7)<br>OBP: 0.428, SLG: 0.602   | 0-3 K ③                  |                          | 0-0 F7 ③                 |                          | 4-0 BB 1-2 1B 1B         |                          | 4-0 FC3-2 BB 1B 1B       | 0-0 F6 1-2               |                          | 3                        | 1                         | 0                       | 0      | 2  | 1  | 3   |
| Gus Bell, L (1, 9)<br>OBP: 0.367, SLG: 0.477  |                          | 0-0 1B                   |                          | 0-0 F7 ①                 | 0-0 BB 1-3 2-H 1B 1B     |                          | 0-0 FC3-2 BB 1B 1-2      |                          | 0-3 K ①                  | 5                        | 1                         | 3                       | 1      | 0  | 1  | 0   |
| Danny Murtaugh, R (1, 4)<br>OBP: 0.409, SLG: 0.429  |                          | 0-3 K ①                  |                          | 0-0 FC5 BB 1B            | 0-0 BB 1-2 3-H 1B 1B     |                          | 0-0 FC3-2 BB 1B 1-2 2-3  |                          | 0-0 F2 ②                 | 5                        | 0                         | 3                       | 1      | 0  | 1  | 1   |
| Dale Coogan, L (1, 3)<br>OBP: 0.323, SLG: 0.333   |                          | 0-0 F4 ②                 |                          | 4-0 BB 1-2 FC5 BB        | 0-0 BB 1-3 2-H 1B        |                          | 0-3 K ①                  |                          | 0-0 5-3 ③                | 4                        | 0                         | 1                       | 1      | 1  | 1  | 4   |
| Pete Castiglione, R (1, 5)<br>OBP: 0.302, SLG: 0.301<br>Johnny Hopp, L (7, PH)<br>OBP: 0.400, SLG: 0.487<br>Nanny Fernandez, R (8, 5)<br>OBP: 0.324, SLG: 0.413 |                          | 0-0 L6 ③                 |                          | 0-0 FC5 ②                | 0-0 F5 ③                 |                          | 0-0 FC3-2 ②              |                          |                          | 3                        | 0                         | 0                       | 0      | 0  | 0  | 5   |
| Ray Mueller, R (1, 2)<br>OBP: 0.318, SLG: 0.475   |                          |                          | 0-0 F8 ①                 | 0-0 F7 ③                 |                          | 0-0 F8 ①                 | 0-0 1-3 ③                |                          |                          | 4                        | 0                         | 0                       | 0      | 0  | 0  | 5   |
| Bill MacDonald, R (1, 1)<br>OBP: 0.190, SLG: 0.190<br>Frank Papish, R (5, 1)  |                          |                          | 0-3 K ②                  |                          | 0-0 F8 ①                 | 4-0 FC6 BB               |                          | 0-0 4-3 ①                |                          | 1                        | 0                         | 0                       | 0      | 0  | 1  | 0   |
| Junior Walsh, R (5, 1)<br>OBP: 0.800, SLG: 1.000<br>Hank Schenz, R (5, PH)<br>OBP: 0.300, SLG: 0.408<br>Vic Lombardi, L (6, 1)<br>OBP: 0.400, SLG: 0.333        |                          |                          |                          |                          |                          |                          |                          |                          |                          | 0                        | 0                         | 0                       | 0      | 0  | 0  | 0   |
|   |                          |                          |                          |                          |                          |                          |                          |                          |                          | 0                        | 0                         | 0                       | 0      | 0  | 0  | 0   |
|   |                          |                          |                          |                          |                          |                          |                          |                          |                          | 1                        | 0                         | 0                       | 0      | 0  | 0  | 0   |
|   |                          |                          |                          |                          |                          |                          |                          |                          |                          | 1                        | 0                         | 0                       | 0      | 1  | 0  | 0   |
| <b>Inning Stats</b>   | R: 0 H: 0 E: 0 K: 3 S: 9 | R: 0 H: 1 E: 0 K: 1 S: 6 | R: 0 H: 1 E: 0 K: 1 S: 6 | R: 0 H: 1 E: 0 K: 0 S: 4 | R: 3 H: 4 E: 0 K: 0 S: 7 | R: 0 H: 0 E: 0 K: 1 S: 5 | R: 0 H: 2 E: 0 K: 1 S: 7 | R: 0 H: 1 E: 0 K: 0 S: 4 | R: 0 H: 0 E: 0 K: 1 S: 5 | 1B: 10 2B: 0 3B: 0 HR: 0 | SF: 0 SAC: 0 DP: 0 HBP: 0 | WP: 1 PB: 0 SB: 0 CS: 0 | PA: 42 |    |    |     |

**BOTTOM**

**Cincinnati Reds @ Pittsburgh Pirates**  
 Forbes Field, Pittsburgh, PA  
 Tue Jun 27 1950, 3:33 AM EDT  
 Att: 13,500 - Unknown - 65 F

livebaseballscorecards.com

|            |           |
|------------|-----------|
| <b>AB</b>  | <b>37</b> |
| <b>R</b>   | <b>3</b>  |
| <b>H</b>   | <b>10</b> |
| <b>RBI</b> | <b>3</b>  |
| <b>BB</b>  | <b>5</b>  |
| <b>SO</b>  | <b>8</b>  |
| <b>LOB</b> | <b>25</b> |



| PITCHER                                | IP  | WLS | BF | H | R | ER | SO | BB | IBB | HBP | BLK | WP | HR | S  | P  | ERA  | WHIP  |
|--|-----|-----|----|---|---|----|----|----|-----|-----|-----|----|----|----|----|------|-------|
| Herm Wehmeier, R (1, 1)<br>ERA: 6.57   | 6.0 | W   | 31 | 8 | 3 | 3  | 6  | 5  | 0   | 0   | 0   | 0  | 0  | 38 | 58 | 4.50 | 2.167 |
| Ewell Blackwell, R (7, 1)<br>ERA: 3.27 | 3.0 | S   | 11 | 2 | 0 | 0  | 2  | 0  | 0   | 0   | 0   | 1  | 0  | 15 | 15 | 0.00 | 0.667 |

| Batter  | 1   | 2   | 3   | 4   | 5   | 6   | 7   | 8   | 9   | AB R H RBI BB SO LOB                                       | TOP                                     |   |
|---|---|---|---|---|---|---|---|---|---|--|---|---|
| <b>Bobby Adams, R</b> (1, 5)<br>OBP: 0.329, SLG: 0.329<br><b>Harry Perkowski, L</b> (9, PH)<br>OBP: 0.462, SLG: 0.462   | 0-0<br>5-3<br>1B                                      | 0-0<br>F8   |   | 0-0<br>FC6-2-5<br>3B                                |   |   | 0-3<br>K  |   | 0-0<br>1B   | 4 1 2 0 0 1 1<br>1 0 1 0 0 0 0                             |   |   |
| <b>Peanuts Lowrey, R</b> (1, 7)<br>OBP: 0.344, SLG: 0.309   | 0-0<br>5-3<br>1-2                                     |   | 0-0<br>6-3  | 0-0<br>FC6-2-5                                      |   |   | 0-0<br>6-3  |   | 0-0<br>F5   | 5 0 0 0 0 0 3  |   |   |
| <b>Johnny Wyrostek, L</b> (1, 9)<br>OBP: 0.417, SLG: 0.486  | 4-0<br>1B<br>BB                                       |   | 0-3<br>K  | 0-0<br>G3   |   |   | 4-0<br>BB   |   |   | 2 0 0 0 2 1 1  |   |   |
| <b>Ted Kluszewski, L</b> (1, 3)<br>OBP: 0.346, SLG: 0.558   | 0-0<br>FC5-4<br>1-3<br>2-H<br>1B                      |   | 0-3<br>K  |   | 0-0<br>4-3  |   | 0-0<br>F7   |   |   | 4 0 1 1 0 1 1  |   |   |
| <b>Connie Ryan, R</b> (1, 4)<br>OBP: 0.359, SLG: 0.388  | 0-3<br>K  |   |   | 0-0<br>E6<br>1B<br>1B                               | 0-0<br>FC4-6<br>1B                                  |   |   | 4-0<br>FC4<br>BB                                    |   | 3 1 1 0 1 1 2  |   |   |
| <b>Bob Usher, R</b> (1, 8)<br>OBP: 0.308, SLG: 0.370<br><b>Lloyd Merriman, L</b> (5, PH)<br>OBP: 0.340, SLG: 0.344 (5, 8)   | 0-0<br>FC5-4<br>1-2f                                  |   | 0-0<br>L6   | 0-0<br>L6   | 0-0<br>FC4-6<br>CS                                  |   | 0-0<br>FC4  | 0-0<br>FC4<br>G1-4-3                                |   | 2 0 0 0 0 0 3<br>2 0 0 0 0 0 2                             |   |   |
| <b>Dixie Howell, R</b> (1, 2)<br>OBP: 0.347, SLG: 0.284   |   | 0-0<br>5-3  |   | 0-0<br>1B<br>HR<br>1B                               | 0-0<br>CS   | 4-0<br>SH2-3<br>BB                                  |   | 0-0<br>G1-4-3                                       |   | 3 1 1 0 1 0 1  |   |   |
| <b>Virgil Stallcup, R</b> (1, 6)<br>OBP: 0.281, SLG: 0.356<br><b>Grady Hatton, L</b> (9, PH)<br>OBP: 0.340, SLG: 0.415  |   | 0-0<br>E<br>S<br>1B                                 |   | 0-0<br>HR<br>1B                                     |   |   | 0-0<br>SH2-3  |   | 0-0<br>F8   | 2 1 2 1 0 0 0<br>1 0 0 0 0 0 0                             |   |   |
| <b>Howie Fox, R</b> (1, 1)<br>OBP: 0.250, SLG: 0.417<br><b>Frank Smith, R</b> (8, 1)<br>OBP: 0.077, SLG: 0.077<br><b>Bob Scheffing, R</b> (9, PH)<br>OBP: 0.309, SLG: 0.392 |   | 0-0<br>F2   |   | 0-0<br>HR   |   |   | 0-0<br>5-3-1  |   | 0-0<br>F6   | 3 1 1 3 0 0 2<br>0 0 0 0 0 0 0<br>1 0 0 0 0 0 0            |   |   |
| <b>Inning Stats</b>   | R: 1 H: 2<br>E: 0 LOB: 2<br>K: 1 BB: 1<br>S: 7 P: 11  | R: 0 H: 1<br>E: 0 LOB: 1<br>K: 0 BB: 0<br>S: 4 P: 4 | R: 0 H: 0<br>E: 0 LOB: 0<br>K: 2 BB: 0<br>S: 7 P: 7 | R: 4 H: 4<br>E: 1 LOB: 1<br>K: 0 BB: 0<br>S: 8 P: 8 | R: 0 H: 1<br>E: 0 LOB: 0<br>K: 0 BB: 0<br>S: 3 P: 3 | R: 0 H: 0<br>E: 0 LOB: 0<br>K: 0 BB: 1<br>S: 2 P: 6 | R: 0 H: 0<br>E: 0 LOB: 1<br>K: 1 BB: 1<br>S: 5 P: 9 | R: 0 H: 0<br>E: 0 LOB: 0<br>K: 0 BB: 1<br>S: 2 P: 6 | R: 0 H: 1<br>E: 0 LOB: 1<br>K: 0 BB: 0<br>S: 4 P: 4 | 1B: 7 SF: 0<br>2B: 1 SAC: 1<br>3B: 1 DP: 2<br>HR: 1 HBP: 0 | WP: 0 PA: 39<br>PB: 0<br>SB: 1<br>CS: 1 |   |
| <b>PITCHER</b><br><b>Bill Werle, L</b> (1, 1)<br>ERA: 5.87<br><b>Murry Dickson, R</b> (4, 1)<br>ERA: 4.67   | IP WLS BF H R ER SO BB IBB HBP BLK WP HR S P ERA WHIP |   |   |   |   |   |   |   |   |  |   | <b>PITCHER</b><br>IP WLS BF H R ER SO BB IBB HBP BLK WP HR S P ERA WHIP |

**Cincinnati Reds @ Pittsburgh Pirates**  
**Forbes Field, Pittsburgh, PA**  
 Wed Jun 28 1950, 3:33 AM EDT  
 Att. 12,040 - Unknown - 70 F

[livebaseballscorecards.com](http://livebaseballscorecards.com)

|            |           |
|------------|-----------|
| <b>AB</b>  | <b>33</b> |
| <b>R</b>   | <b>5</b>  |
| <b>H</b>   | <b>9</b>  |
| <b>RBI</b> | <b>5</b>  |
| <b>BB</b>  | <b>4</b>  |
| <b>SO</b>  | <b>4</b>  |
| <b>LOB</b> | <b>16</b> |



| Batter   | 1                                  | 2          | 3          | 4                      | 5                  | 6          | 7                           | 8                  | 9 | AB | R | H | RBI | BB | SO | LOB |
|--|------------------------------------|------------|------------|------------------------|--------------------|------------|-----------------------------|--------------------|---|----|---|---|-----|----|----|-----|
| Stan Rojek, R<br>OBP: 0.278, SLG: 0.290 (1, 6)     | 0-0<br>F4                          |            | 0-0<br>6-3 | 0-0<br>F2              |                    | 0-0<br>5-3 |                             | 0-0<br>2B          |   | 5  | 0 | 1 | 1   | 0  | 0  | 1   |
| Dale Coogan, L<br>OBP: 0.341, SLG: 0.342 (1, 3)    | 0-0<br>BB BB<br>FC4-6<br>1B        |            | 0-0<br>1-3 |                        | 0-0<br>BB G3<br>1B |            | 4-0<br>BB BB<br>FC4-6<br>BB | 4-0<br>BB BB<br>BB |   | 3  | 1 | 2 | 0   | 2  | 0  | 0   |
| Ralph Kiner, R<br>OBP: 0.424, SLG: 0.591 (1, 7)    | 4-0<br>FC4-6 BB<br>1-2<br>BB       |            | 0-0<br>6-3 |                        | 0-0<br>F9          |            | 0-0<br>F2                   | 0-3<br>K           |   | 4  | 0 | 0 | 0   | 1  | 1  | 4   |
| Gus Bell, L<br>OBP: 0.363, SLG: 0.465 (1, 9)       | 4-0<br>FC4-6<br>1-2<br>2-3<br>BB   |            |            | 0-0<br>F2              | 0-0<br>G3          |            | 0-0<br>FC4-6                |                    |   | 3  | 0 | 0 | 0   | 1  | 0  | 2   |
| Wally Westlake, R<br>OBP: 0.348, SLG: 0.512 (1, 8) | 0-0<br>FC4-6<br>1-2f<br>2-3<br>3-H |            |            | 0-0<br>2B<br>1B        | 4-0<br>BB<br>BB    |            | 0-0<br>F8                   |                    |   | 3  | 1 | 1 | 1   | 1  | 0  | 3   |
| Danny Murtaugh, R<br>OBP: 0.414, SLG: 0.447 (1, 4) | 0-0<br>F9                          |            |            | 0-0<br>2B<br>2B        | 4-0<br>BB<br>BB    |            |                             | 0-0<br>3B<br>3B    |   | 3  | 2 | 2 | 0   | 1  | 0  | 2   |
| Jack Phillips, R<br>OBP: 0.297, SLG: 0.371 (1, 5)  |                                    | 0-0<br>F6  |            | 0-0<br>6-3<br>1B<br>2B | 0-0<br>4-3         |            |                             | 0-0<br>L4          |   | 4  | 1 | 1 | 2   | 0  | 0  | 4   |
| Ray Mueller, R<br>OBP: 0.304, SLG: 0.453 (1, 2)    |                                    | 0-3<br>K   |            | 0-0<br>6-3<br>2B       |                    | 0-3<br>K   |                             | 0-0<br>2B<br>3B    |   | 3  | 0 | 0 | 0   | 0  | 2  | 1   |
| Johnny Hopp, L<br>OBP: 0.403, SLG: 0.503 (8, PH)   |                                    |            |            | 2-3<br>K               |                    |            |                             | 0-0<br>2B<br>3B    |   | 1  | 1 | 1 | 1   | 0  | 0  | 0   |
| Earl Turner, R<br>OBP: 0.265, SLG: 0.283 (9, 2)    |                                    |            |            |                        |                    |            |                             | 0-0<br>2B<br>3B    |   | 0  | 0 | 0 | 0   | 0  | 0  | 0   |
| Bill Werte, L<br>OBP: 0.375, SLG: 0.250 (1, 1)     |                                    | 0-0<br>4-3 |            | 0-0<br>4-3<br>1B       |                    | 0-0<br>4-3 |                             | 0-0<br>1-3         |   | 1  | 0 | 0 | 0   | 0  | 0  | 0   |
| Murry Dickson, R<br>OBP: 0.250, SLG: 0.229 (4, 1)  |                                    |            |            |                        |                    |            |                             |                    |   | 3  | 0 | 1 | 1   | 0  | 0  | 1   |

| Inning Stats                       | R: 1 | H: 1 | E: 0 | LOB: 2 | K: 0 | S: 4 | P: 12 | R: 0 | H: 0 | E: 0 | LOB: 0 | K: 1 | S: 5 | P: 5 | R: 0 | H: 0  | E: 0  | LOB: 0 | K: 0 | S: 3 | P: 3 | R: 3 | H: 4 | E: 0 | LOB: 1 | K: 0 | S: 7 | P: 7 | R: 0 | H: 1 | E: 0 | LOB: 3 | K: 0 | S: 4 | P: 12 | R: 0 | H: 0 | E: 0 | LOB: 0 | K: 1 | S: 5 | P: 5 | R: 0 | H: 0 | E: 0 | LOB: 1 | K: 0 | S: 3 | P: 7 | R: 2 | H: 3 | E: 0 | LOB: 2 | K: 1 | S: 8 | P: 12 |
|------------------------------------|------|------|------|--------|------|------|-------|------|------|------|--------|------|------|------|------|-------|-------|--------|------|------|------|------|------|------|--------|------|------|------|------|------|------|--------|------|------|-------|------|------|------|--------|------|------|------|------|------|------|--------|------|------|------|------|------|------|--------|------|------|-------|
| PITCHER                            | IP   | WLS  | BF   | H      | R    | ER   | SO    | BB   | IBB  | HBP  | BLK    | WP   | HR   | S    | P    | ERA   | WHIP  |        |      |      |      |      |      |      |        |      |      |      |      |      |      |        |      |      |       |      |      |      |        |      |      |      |      |      |      |        |      |      |      |      |      |      |        |      |      |       |
| Howie Fox, R<br>ERA: 5.16 (1, 1)   | 7.0  |      | 32   | 6      | 4    | 4    | 2     | 5    | 0    | 0    | 0      | 0    | 0    | 31   | 51   | 5.14  | 1.571 |        |      |      |      |      |      |      |        |      |      |      |      |      |      |        |      |      |       |      |      |      |        |      |      |      |      |      |      |        |      |      |      |      |      |      |        |      |      |       |
| Frank Smith, R<br>ERA: 2.66 (8, 1) | 1.0  | L    | 7    | 3      | 2    | 2    | 1     | 1    | 0    | 0    | 0      | 0    | 0    | 8    | 12   | 18.00 | 4.000 |        |      |      |      |      |      |      |        |      |      |      |      |      |      |        |      |      |       |      |      |      |        |      |      |      |      |      |      |        |      |      |      |      |      |      |        |      |      |       |

**BOTTOM**

**Cincinnati Reds @ Pittsburgh Pirates**  
 Forbes Field, Pittsburgh, PA  
 Wed Jun 28 1950, 3:33 AM EDT  
 Att: 12,040 - Unknown - 70 F

|     |    |
|-----|----|
| AB  | 33 |
| R   | 6  |
| H   | 9  |
| RBI | 6  |
| BB  | 6  |
| SO  | 3  |
| LOB | 18 |



|       |        |
|-------|--------|
| WP: 0 | PA: 39 |
| PB: 0 | SB: 0  |
| CS: 0 |        |

| Batter  | 1   | 2   | 3   | 4   | 5   | 6   | 7   | 8  | 9   | AB R H RBI BB SO LOB                                       | TOP                                     |                |   |
|---|---|---|---|---|---|---|---|--|---|--|---|----------------|---|
| Bob Ramazzotti, R (1, 4)<br>OBP: 0.313, SLG: 0.370  | 0-0<br>F9   |   | 0-0<br>F8   |   |   | 0-0<br>6-3  |   | 0-0<br>1B  | 0-0<br>FC6-4  | 5 0 1 0 0 0 2  |   |                |   |
| Mickey Owen, R (1, 2)<br>OBP: 0.229, SLG: 0.239<br>Rube Walker, L (8, PH)<br>OBP: 0.278, SLG: 0.372 (8, 2)  | 0-0<br>1B   |   |   | 0-0<br>P4   |   | 0-0<br>P2   |   | 0-0<br>F9  |   | 3 0 1 0 0 0 0<br>1 0 0 0 0 0 2                             |   |                |   |
| Phil Cavarretta, L (1, 3)<br>OBP: 0.378, SLG: 0.468<br>Dutch Leonard, R (8, 1)<br>OBP: 0.200, SLG: 0.200  | 0-0<br>F7   |   |   | 0-0<br>HR   |   | 0-0<br>F8   |   | 0-3<br>K   |   | 4 1 1 1 0 1 3<br>0 0 0 0 0 0 0                             |   |                |   |
| Hank Sauer, R (1, 7)<br>OBP: 0.404, SLG: 0.589  | 0-0<br>F7   |   |   | 0-0<br>HR   |   |   | 0-3<br>K  | 0-0<br>F7  |   | 4 1 1 1 0 1 3  |   |                |   |
| Andy Pafo, R (1, 8)<br>OBP: 0.428, SLG: 0.536   |   | 0-3<br>K  |   | 0-0<br>1-3  |   | 0-0<br>P5   |   |  | 0-0<br>1B<br>1B                                     | 4 1 1 0 0 1 0  |   |                |   |
| Hank Edwards, L (1, 9)<br>OBP: 0.421, SLG: 0.541  |   | 0-3<br>K  |   | 0-3<br>K  |   | 0-0<br>1-3  |   |  | 0-0<br>1B<br>1-2<br>1B                              | 4 0 1 0 0 2 0  |   |                |   |
| Roy Smalley, R (1, 6)<br>OBP: 0.343, SLG: 0.523   |   |   | 0-0<br>F3   |   | 0-0<br>5-3  |   |   | 4-0<br>3B<br>BB                                      | 0-3<br>K  | 3 1 0 0 1 1 2  |   |                |   |
| Bill Serena, R (1, 5)<br>OBP: 0.346, SLG: 0.419   |   |   |   | 0-3<br>K  |   | 0-3<br>K  |   | 0-0<br>1B<br>3B                                      | 0-0<br>FC6-4<br>1B                                  | 4 1 2 2 0 2 0  |   |                |   |
| Johnny Schmitz, R (1, 1)<br>OBP: 0.143, SLG: 0.146<br>Johnny Vander Meer, S (1, 1)<br>Wayne Terwilliger, R (8, PH)<br>OBP: 0.323, SLG: 0.379 (8, 3) |   |   |   | 0-3<br>K  |   | 0-0<br>F8   |   | 0-0<br>1B<br>3B                                      | 0-0<br>P3   | 0 0 0 0 0 0 0<br>2 0 0 0 0 1 0<br>2 0 1 1 0 0 2            |   |                |   |
| <b>Inning Stats</b>   | R: 0 H: 1<br>E: 0 LOB: 1<br>K: 0 BB: 0<br>S: 4 P: 4   | R: 0 H: 0<br>E: 0 LOB: 0<br>K: 2 BB: 0<br>S: 7 P: 7 | R: 0 H: 0<br>E: 0 LOB: 0<br>K: 2 BB: 0<br>S: 7 P: 7 | R: 2 H: 2<br>E: 0 LOB: 0<br>K: 1 BB: 0<br>S: 7 P: 7 | R: 0 H: 0<br>E: 0 LOB: 0<br>K: 1 BB: 0<br>S: 5 P: 5 | R: 0 H: 0<br>E: 0 LOB: 0<br>K: 0 BB: 0<br>S: 3 P: 3 | R: 0 H: 0<br>E: 0 LOB: 0<br>K: 1 BB: 0<br>S: 5 P: 5 | R: 2 H: 3<br>E: 0 LOB: 2<br>K: 1 BB: 1<br>S: 8 P: 12 | R: 1 H: 3<br>E: 0 LOB: 2<br>K: 1 BB: 0<br>S: 8 P: 8 | 1B: 6 SF: 0<br>2B: 0 SAC: 0<br>3B: 1 DP: 0<br>HR: 2 HBP: 0 | WP: 0 PA: 37<br>PB: 0<br>SB: 0<br>CS: 0 |                |   |
| <b>PITCHER</b>  | IP WLS BF H R ER SO BB IBB HBP BLK WP HR S P ERA WHIP |   |   |   |   |   |   |  |   |  |   | <b>PITCHER</b> | IP WLS BF H R ER SO BB IBB HBP BLK WP HR S P ERA WHIP |
| Ken Raffensberger, L (1, 1)<br>ERA: 4.37  | 7.0 W 28 6 4 4 7 1 0 0 0 0 2 41 45 5.14 1.000         |   |   |   |   |   |   |  |   |  |   |                |   |
| Herm Wehmeier, R (8, 1)<br>ERA: 6.52  | 2.0 S 9 3 1 1 2 0 0 0 0 0 0 0 13 13 4.50 1.500        |   |   |   |   |   |   |  |   |  |   |                |   |

Chicago Cubs @ Cincinnati Reds  
Crosley Field, Cincinnati, OH  
Fri Jun 30 1950, 3:33 AM EDT  
Att. 10,736 - Unknown

livebaseballscorecards.com

|     |    |
|-----|----|
| AB  | 36 |
| R   | 5  |
| H   | 9  |
| RBI | 5  |
| BB  | 1  |
| SO  | 9  |
| LOB | 14 |





| Batter   | 1                      | 2          | 3                  | 4                | 5                     | 6         | 7                     | 8                | 9 |
|--|------------------------|------------|--------------------|------------------|-----------------------|-----------|-----------------------|------------------|---|
| <b>Bobby Adams, R</b> (1, 5)<br>OBP: 0.333, SLG: 0.336<br><b>Grady Hatton, L</b> (8, 5)<br>OBP: 0.343, SLG: 0.415        | 0-0<br>E<br>2B         | 0-0<br>F7  |                    | 4-0<br>S<br>BB   |                       | 0-0<br>P4 |                       | 4-0<br>S<br>BB   |   |
| <b>Peanuts Lowrey, R</b> (1, 7)<br>OBP: 0.340, SLG: 0.312  | 0-0<br>E6<br>HBP<br>2B | 0-0<br>2B  |                    | 0-0<br>F2<br>1-2 |                       | 0-0<br>P5 |                       | 0-0<br>F9<br>1-2 |   |
| <b>Johnny Wyrostek, L</b> (1, 9)<br>OBP: 0.417, SLG: 0.482   | 1-0<br>2B<br>HBP       | 0-0<br>3-1 |                    | 0-3<br>K         |                       |           | 0-0<br>WP<br>2B<br>1B | 0-0<br>F7        |   |
| <b>Ted Kluszewski, L</b> (1, 3)<br>OBP: 0.344, SLG: 0.557  | 0-0<br>1B<br>2B        |            | 0-0<br>F8          |                  | 0-0<br>F8             |           | 0-0<br>F5             |                  |   |
| <b>Connie Ryan, R</b> (1, 4)<br>OBP: 0.371, SLG: 0.395   | 0-0<br>G6-4-3<br>1B    |            | 4-0<br>BB<br>BB    |                  | 0-0<br>E<br>1B        |           | 4-0<br>WP<br>2B<br>BB |                  |   |
| <b>Bob Usher, R</b> (1, 8)<br>OBP: 0.313, SLG: 0.382   | 0-0<br>G6-4-3<br>1-2f  |            | 0-0<br>F7          |                  | 0-0<br>E7<br>F8<br>1B |           | 0-0<br>1B<br>2B       |                  |   |
| <b>Dixie Howell, R</b> (1, 2)<br>OBP: 0.362, SLG: 0.289  | 4-0<br>BB              |            | 4-0<br>FC6-4<br>BB |                  | 0-0<br>F8             |           | 0-0<br>FC5-4<br>1B    |                  |   |
| <b>Virgil Stallcup, R</b> (1, 6)<br>OBP: 0.275, SLG: 0.348   | 0-0<br>F8              |            | 0-0<br>FC6-4       |                  | 0-0<br>F8             |           | 0-0<br>FC5-4          |                  |   |
| <b>Ken Raffensberger, R</b> (1, 1)<br>OBP: 0.231, SLG: 0.222<br><b>Herm Wehmeier, R</b> (8, 1)<br>OBP: 0.227, SLG: 0.256 |                        | 0-3<br>K   |                    | 0-0<br>F8        |                       | 0-3<br>K  |                       | 0-3<br>K         |   |

| Inning Stats                                     | R: 4 | H: 3 | E: 1 | K: 0 | S: 6 | LOB: 1 | BB: 1 | P: 11 | R: 0 | H: 1 | E: 0 | K: 1 | S: 6 | LOB: 1 | BB: 0 | P: 6 | R: 0  | H: 0 | E: 0 | K: 0 | S: 3 | LOB: 2 | BB: 2 | P: 11 | R: 2 | H: 2 | E: 1 | K: 0 | S: 5 | LOB: 0 | BB: 0 | P: 5 | R: 0 | H: 0 | E: 0 | K: 1 | S: 5 | LOB: 0 | BB: 0 | P: 5 | R: 2 | H: 3 | E: 0 | K: 0 | S: 5 | LOB: 1 | BB: 1 | P: 9 | R: 0 | H: 0 | E: 0 | K: 1 | S: 5 | LOB: 1 | BB: 1 | P: 9 |
|--|------|------|------|------|------|--------|-------|-------|------|------|------|------|------|--------|-------|------|-------|------|------|------|------|--------|-------|-------|------|------|------|------|------|--------|-------|------|------|------|------|------|------|--------|-------|------|------|------|------|------|------|--------|-------|------|------|------|------|------|------|--------|-------|------|
| <b>PITCHER</b>                                   | IP   | WLS  | BF   | H    | R    | ER     | SO    | BB    | IBB  | HBP  | BLK  | WP   | HR   | S      | P     | ERA  | WHIP  |      |      |      |      |        |       |       |      |      |      |      |      |        |       |      |      |      |      |      |      |        |       |      |      |      |      |      |      |        |       |      |      |      |      |      |      |        |       |      |
| <b>Johnny Schmitz, L</b> (1, 1)<br>ERA: 4.16     | 0.0  | L    | 5    | 3    | 4    | 3      | 0     | 0     | 0    | 1    | 0    | 0    | 0    | 4      | 5     | ∞    | ∞     |      |      |      |      |        |       |       |      |      |      |      |      |        |       |      |      |      |      |      |      |        |       |      |      |      |      |      |      |        |       |      |      |      |      |      |      |        |       |      |
| <b>Johnny Vander Meer, L</b> (1, 1)<br>ERA: 5.12 | 7.0  |      | 30   | 6    | 4    | 2      | 3     | 5     | 0    | 0    | 0    | 1    | 0    | 31     | 51    | 2.57 | 1.571 |      |      |      |      |        |       |       |      |      |      |      |      |        |       |      |      |      |      |      |      |        |       |      |      |      |      |      |      |        |       |      |      |      |      |      |      |        |       |      |
| <b>Dutch Leonard, R</b> (8, 1)<br>ERA: 4.88      | 1.0  |      | 4    | 0    | 0    | 0      | 1     | 1     | 0    | 0    | 0    | 0    | 0    | 5      | 9     | 0.00 | 1.000 |      |      |      |      |        |       |       |      |      |      |      |      |        |       |      |      |      |      |      |      |        |       |      |      |      |      |      |      |        |       |      |      |      |      |      |      |        |       |      |

**BOTTOM**

|    |   |   |     |    |    |     |
|----|---|---|-----|----|----|-----|
| AB | R | H | RBI | BB | SO | LOB |
| 3  | 1 | 1 | 0   | 1  | 0  | 0   |
| 0  | 0 | 0 | 0   | 1  | 0  | 0   |
| 5  | 1 | 1 | 0   | 0  | 0  | 3   |
| 4  | 2 | 1 | 0   | 0  | 1  | 3   |
| 4  | 1 | 1 | 3   | 0  | 0  | 1   |
| 2  | 2 | 2 | 1   | 2  | 0  | 0   |
| 4  | 1 | 2 | 2   | 0  | 0  | 2   |
| 2  | 0 | 1 | 1   | 2  | 0  | 0   |
| 4  | 0 | 0 | 0   | 0  | 0  | 4   |
| 3  | 0 | 0 | 0   | 0  | 2  | 0   |
| 1  | 0 | 0 | 0   | 0  | 1  | 0   |

**AB 32**  
**R 8**  
**H 9**  
**RBI 7**  
**BB 6**  
**SO 4**  
**LOB 13**

**WP: 1** **PA: 39**  
**PB: 0**  
**SB: 2**  
**CS: 0**

**REDS**

**Chicago Cubs @ Cincinnati Reds**  
Crosley Field, Cincinnati, OH  
Fri Jun 30 1950, 3:33 AM EDT  
Att. 10,736 - Unknown

[livebaseballscorecards.com](http://livebaseballscorecards.com)

| Batter  | 1   | 2   | 3   | 4   | 5  | 6   | 7   | 8  | 9  | 10  | AB R H RBI BB SO LOB                                       | TOP   |
|---|---|---|---|---|--|---|---|--|--|---|--|---|
| <b>Bob Ramazzotti, R</b> (1, 4)<br><small>OBP: 0.299, SLG: 0.354</small><br>(8, 5)  | 0-0<br><b>F9</b>  |   | 0-0<br><b>G5-4-3</b>                                |   |  | 0-0<br><b>4-3</b>                                   |   | 0-0<br><b>FC6-4</b>                                  |  | 0-3<br><b>K</b>                                     | 5 0 0 0 0 1 2  | <b>Chicago Cubs @ Cincinnati Reds</b><br>Crosley Field, Cincinnati, OH<br>Sat Jul 01 1950, 3:33 AM EDT<br>Att. 10,370 - Unknown |
| <b>Rube Walker, L</b> (1, 2)<br><small>OBP: 0.269, SLG: 0.360</small>   | 0-0<br><b>1-3</b>   |   |   | 0-3<br><b>K</b>                                     |  | 0-0<br><b>4-3</b>                                   |   |  | 0-0<br><b>F4</b>   |   | 4 0 0 0 0 1 0  |   |
| <b>Phil Cavarretta, L</b> (1, 3)<br><small>OBP: 0.375, SLG: 0.459</small>   | 0-3<br><b>K</b>   |   |   | 0-0<br><b>3-1</b>                                   |  | 0-3<br><b>K</b>                                     |   |  | 4-0<br><b>HBP</b><br><b>HR</b><br><b>BB</b>              | 3 1 0 0 1 2 0                                       |  |   |
| <b>Hank Sauer, R</b> (1, 7)<br><small>OBP: 0.409, SLG: 0.588</small><br><b>Emil Verban, R</b> (9, PR)<br><small>OBP: 0.133, SLG: 0.071</small><br><b>Bob Borkowski, R</b> (9, 7)<br><small>OBP: 0.353, SLG: 0.481</small> |   | 0-0<br><b>G4-6-3</b><br><b>HBP</b><br><b>1B</b>     |   | 4-0<br><b>FC4-6</b><br><b>BB</b>                    |  | 0-3<br><b>K</b>                                     |   |  | 1-0<br><b>H</b><br><b>1-2</b><br><b>HR</b><br><b>HBP</b> | 2 0 1 0 1 1 0<br>0 1 0 0 0 0 0<br>0 0 0 0 0 0 0     |  |   |
| <b>Andy Pafko, R</b> (1, 8)<br><small>OBP: 0.429, SLG: 0.548</small>  | 1-0<br><b>G4-6-3</b><br><b>HBP</b>  |   |   | 0-0<br><b>FC4-6</b>                                 |  | 0-0<br><b>5-3</b>                                   |   |  | 0-0<br><b>1-H</b><br><b>2-H</b><br><b>HR</b>             | 3 1 1 3 0 0 1                                       |  |   |
| <b>Hank Edwards, L</b> (1, 9)<br><small>OBP: 0.409, SLG: 0.525</small><br><b>Ron Northey, L</b> (7, 9)<br><small>OBP: 0.362, SLG: 0.513</small>   | 0-0<br><b>G4-6-3</b>  |   |   | 0-3<br><b>K</b>                                     |  | 0-3<br><b>K</b>                                     |   |  | 0-0<br><b>1-3</b>  | 3 0 0 0 0 2 2<br>1 0 0 0 0 0 1                      |  |   |
| <b>Roy Smalley, R</b> (1, 6)<br><small>OBP: 0.337, SLG: 0.513</small>   | 0-3<br><b>K</b>   |   |   | 0-3<br><b>K</b>                                     |  | 0-3<br><b>K</b>                                     |   |  | 0-3<br><b>K</b>  | 4 0 0 0 0 4 2                                       |  |   |
| <b>Bill Serena, R</b> (1, 5)<br><small>OBP: 0.351, SLG: 0.417</small><br><b>Wayne Terwilliger, R</b> (8, 5)<br><small>OBP: 0.321, SLG: 0.377</small><br>(8, 4)  |   |   | 4-0<br><b>FC5-6</b><br><b>BB</b>                    |   | 4-0<br><b>BB</b>                                     |   | 0-3<br><b>K</b>                                     |  |  | 0-0<br><b>5-3</b>                                   | 1 0 0 0 2 1 0<br>1 0 0 0 0 0 0                             |   |
| <b>Paul Minner, L</b> (1, 1)<br><small>OBP: 0.280, SLG: 0.238</small>   |   |   | 0-0<br><b>FC5-6</b><br><b>G5-4-3</b>                |   | 0-3<br><b>K</b>                                      |   | 4-0<br><b>FC6-4</b><br><b>BB</b>                    |  |  | 0-3<br><b>K</b>                                     | 3 0 0 0 1 2 2  |   |
| <b>Inning Stats</b>   | R: 0 H: 0<br>E: 0 LOB: 0<br>K: 1 BB: 0<br>S: 5 P: 5   | R: 0 H: 1<br>E: 0 LOB: 1<br>K: 1 BB: 0<br>S: 5 P: 6 | R: 0 H: 0<br>E: 0 LOB: 0<br>K: 0 BB: 1<br>S: 2 P: 6 | R: 0 H: 0<br>E: 0 LOB: 1<br>K: 1 BB: 1<br>S: 5 P: 9 | R: 0 H: 0<br>E: 0 LOB: 1<br>K: 3 BB: 1<br>S: 9 P: 13 | R: 0 H: 0<br>E: 0 LOB: 0<br>K: 1 BB: 0<br>S: 5 P: 5 | R: 0 H: 0<br>E: 0 LOB: 0<br>K: 2 BB: 0<br>S: 7 P: 7 | R: 0 H: 0<br>E: 0 LOB: 1<br>K: 2 BB: 1<br>S: 7 P: 11 | R: 3 H: 1<br>E: 0 LOB: 1<br>K: 1 BB: 1<br>S: 6 P: 11     | R: 0 H: 0<br>E: 0 LOB: 0<br>K: 2 BB: 0<br>S: 7 P: 7 | 1B: 1 SF: 0<br>2B: 0 SAC: 0<br>3B: 0 DP: 2<br>HR: 1 HBP: 2 |   |
| <b>PITCHER</b><br><b>Ewell Blackwell, R</b> (1, 1)<br><small>ERA: 3.22</small>  | IP 10.0<br>WLS W<br>BF 37<br>H 2<br>R 3<br>ER 3<br>SO 14<br>BB 5<br>IBB 0<br>HBP 2<br>BLK 0<br>WP 0<br>HR 1<br>S 58<br>P 80<br>ERA 2.70<br>WHIP 0.700 |   |   |   |  |   |   |  |  |   |  |   |

livebaseballscorecards.com

|     |    |
|-----|----|
| AB  | 30 |
| R   | 3  |
| H   | 2  |
| RBI | 3  |
| BB  | 5  |
| SO  | 14 |
| LOB | 10 |



BOTTOM

Chicago Cubs @ Cincinnati Reds  
Crosley Field, Cincinnati, OH  
Sat Jul 01 1950, 3:33 AM EDT  
Att: 10,370 - Unknown

livebaseballscorecards.com

AB 36  
R 5  
H 8  
RBI 5  
BB 5  
SO 7  
LOB 18



WP: 0 PA: 43  
PB: 0  
SB: 0  
CS: 0

AB R H RBI BB SO LOB

4 0 1 0 1 1 1

4 0 1 0 0 0 1

5 0 0 1 0 1 4

4 1 1 1 1 1 2

4 1 1 0 1 2 3

4 1 1 0 1 0 1

5 1 1 2 0 2 3

4 0 2 1 0 0 1

2 1 0 0 1 0 2

1B: 6 SF: 0  
2B: 0 SAC: 2  
3B: 0 DP: 0  
HR: 2 HBP: 0

| Batter   | 1          | 2       | 3            | 4            | 5               | 6       | 7            | 8            | 9       | 10        |
|--|------------|---------|--------------|--------------|-----------------|---------|--------------|--------------|---------|-----------|
| <b>Bobby Adams, R</b><br>OBP: 0.335, SLG: 0.333 (1, 5) X     | 0-0 F7     |         | 0-0 P3       |              | 0-0 BB 1B       |         | 4-0 SH3-4 BB |              | 0-3 K   |           |
| <b>Peanuts Lowrey, R</b><br>OBP: 0.338, SLG: 0.310 (1, 7) X  | 0-0 E5 BLK |         | 0-0 4-3      |              | 0-0 BB 1B       |         | 0-0 SH3-4    |              | 0-0 1-3 |           |
| <b>Johnny Wyrostek, L</b><br>OBP: 0.409, SLG: 0.471 (1, 9) X | 0-0 F8     |         |              | 0-0 4-3      | 0-0 F8          |         | 0-3 K        |              | 0-0 3-1 |           |
| <b>Ted Kluszewski, L</b><br>OBP: 0.346, SLG: 0.566 (1, 3) X  | 0-0 6-3    |         |              | 0-0 HR       | 0-0 BB          |         | 0-3 K        |              |         | 0-0 1-3   |
| <b>Connie Ryan, R</b><br>OBP: 0.372, SLG: 0.392 (1, 4) X     |            | 0-0 5-3 |              | 4-0 FC6-4 BB | 0-3 K           |         |              | 0-0 1B F9 1B |         | 0-3 K     |
| <b>Bob Usher, R</b><br>OBP: 0.317, SLG: 0.378 (1, 8) X       |            | 0-0 1-3 |              | 0-0 FC6-4    |                 | 0-0 4-3 |              | 0-0 E 1B     |         | 4-0 HR BB |
| <b>Dixie Howell, R</b><br>OBP: 0.355, SLG: 0.316 (1, 2) X    |            | 0-3 K   |              | 0-0 4-3      |                 | 0-3 K   |              | 0-0 F7       |         | 0-0 HR    |
| <b>Virgil Stallcup, R</b><br>OBP: 0.280, SLG: 0.351 (1, 6) X |            |         | 0-0 SH3-4 1B |              | 0-0 F3          |         |              | 0-0 F9       |         |           |
| <b>Ewell Blackwell, R</b><br>OBP: 0.171, SLG: 0.094 (1, 1) X |            |         | 0-0 SH3-4    |              | 4-0 1B F8 1B BB |         | 0-0 4-3      |              | 0-0 4-3 |           |

| Inning Stats | R: 0 | H: 0   | R: 0 | H: 0   | R: 0 | H: 1   | R: 1 | H: 2   | R: 0 | H: 1   | R: 0 | H: 0   | R: 1 | H: 2   | R: 0 | H: 0   | R: 0 | H: 0   | R: 2 | H: 1   | 1B: 6 | SF: 0  |
|--------------|------|--------|------|--------|------|--------|------|--------|------|--------|------|--------|------|--------|------|--------|------|--------|------|--------|-------|--------|
|              | E: 1 | LOB: 1 | E: 0 | LOB: 0 | E: 0 | LOB: 1 | E: 0 | LOB: 3 | E: 0 | LOB: 1 | E: 0 | LOB: 0 | E: 1 | LOB: 1 | E: 0 | LOB: 0 | E: 0 | LOB: 0 | E: 0 | LOB: 0 | 2B: 0 | SAC: 2 |
|              | K: 0 | BB: 0  | K: 1 | BB: 0  | K: 0 | BB: 0  | K: 1 | BB: 2  | K: 1 | BB: 0  | K: 2 | BB: 1  | K: 0 | BB: 0  | K: 1 | BB: 1  | K: 1 | BB: 0  | K: 1 | BB: 1  | 3B: 0 | DP: 0  |
|              | S: 4 | P: 4   | S: 5 | P: 5   | S: 4 | P: 4   | S: 7 | P: 15  | S: 6 | P: 6   | S: 7 | P: 11  | S: 5 | P: 5   | S: 5 | P: 5   | S: 5 | P: 5   | S: 5 | P: 9   | HR: 2 | HBP: 0 |

| PITCHER                                   | IP  | WLS | BF | H | R | ER | SO | BB | IBB | HBP | BLK | WP | HR | S  | P  | ERA  | WHIP  |
|---|-----|-----|----|---|---|----|----|----|-----|-----|-----|----|----|----|----|------|-------|
| <b>Paul Minner, L</b><br>ERA: 4.13 (1, 1) | 9.2 | L   | 43 | 8 | 5 | 5  | 7  | 5  | 0   | 0   | 1   | 0  | 2  | 52 | 72 | 4.66 | 1.345 |

Chicago Cubs @ Cincinnati Reds  
 Crosley Field, Cincinnati, OH  
 Sun Jul 02 1950, 3:33 AM EDT  
 Att. 7,006 - Unknown

|     |    |
|-----|----|
| AB  | 46 |
| R   | 16 |
| H   | 17 |
| RBI | 16 |
| BB  | 7  |
| SO  | 7  |
| LOB | 26 |



|    |   |    |    |
|----|---|----|----|
| WP | 0 | PA | 55 |
| PB | 0 |    |    |
| SB | 0 |    |    |
| CS | 0 |    |    |

AB R H RBI BB SO LOB

|   |   |   |   |   |   |   |
|---|---|---|---|---|---|---|
| 4 | 0 | 0 | 0 | 0 | 0 | 3 |
| 3 | 1 | 1 | 0 | 0 | 1 | 1 |
| 4 | 3 | 2 | 2 | 2 | 0 | 0 |
| 5 | 3 | 3 | 1 | 0 | 0 | 3 |
| 5 | 1 | 2 | 2 | 1 | 1 | 3 |
| 6 | 3 | 3 | 5 | 0 | 1 | 3 |
| 5 | 1 | 4 | 3 | 1 | 0 | 2 |
| 3 | 2 | 1 | 0 | 1 | 0 | 1 |
| 1 | 0 | 0 | 0 | 0 | 0 | 1 |
| 4 | 2 | 1 | 3 | 2 | 0 | 2 |
| 6 | 0 | 0 | 0 | 0 | 4 | 7 |

| Batter  | 1               | 2            | 3                      | 4 | 5                | 6               | 7     | 8             | 9       |
|---|-----------------|--------------|------------------------|---|------------------|-----------------|-------|---------------|---------|
| Bob Ramazzotti, R (1,4)<br>OBP: 0.289, SLG: 0.342<br>Wayne Terwilliger, R (5,4)<br>OBP: 0.322, SLG: 0.376 | 0-0 F2          | 0-0 5-3      | 0-0 FC3-2<br>1B        |   | 0-0 4-3          | 0-0 BB<br>1B    | 0-3 K |               | 0-0 F9  |
| Rube Walker, L (1,2)<br>OBP: 0.287, SLG: 0.372  | 4-0 2B<br>3B BB | 0-0 1B<br>2B | 0-0 1B                 |   | 0-0 4-3          | 4-0 1B<br>1B BB |       | 0-0 F7        |         |
| Phil Cavarretta, L (1,3)<br>OBP: 0.384, SLG: 0.470  | 0-0 3B<br>2B    | 0-0 F7       | 0-0 5-3                |   | 1-0 BB<br>2B HBP | 0-0 1B<br>1B    |       | 0-0 HR<br>1B  |         |
| Hank Sauer, R (1,7)<br>OBP: 0.411, SLG: 0.584   | 0-0 P4          | 0-0 1B       |                        |   | 0-0 F7           | 4-0 2B<br>1B BB |       | 0-3 K         |         |
| Andy Pafo, R (1,8)<br>OBP: 0.431, SLG: 0.576  | 0-0 1B<br>3B    | 0-0 F7       |                        |   | 0-0 F6           | 0-0 1B<br>2B    |       | 0-0 HR        |         |
| Hank Edwards, L (1,9)<br>OBP: 0.431, SLG: 0.557   | 0-0 HR<br>1B    |              | 4-0 BB<br>FC3-2 BB     |   | 0-0 BB<br>2B     | 0-0 1B<br>1B    |       | 0-0 1-3<br>2B |         |
| Roy Smalley, R (1,6)<br>OBP: 0.343, SLG: 0.511<br>Emil Verban, R (8,PH)<br>OBP: 0.125, SLG: 0.067         | 0-0 E4<br>HR    |              | 1-0 FC3-2 BB<br>1B HBP |   | 4-0 BB<br>BB     | 0-0 FC6-4<br>1B |       | 0-0 4-3       | 0-0 5-3 |
| Bill Serena, R (1,5)<br>OBP: 0.355, SLG: 0.430  | 0-0 HR          |              | 4-0 FC3-2<br>1B BB     |   | 4-0 BB           | 0-0 FC6-4       |       | 0-0 E6        | 0-0 6-3 |
| Monk Dubiel, R (1,1)<br>OBP: 0.118, SLG: 0.063  | 0-0 5-3         |              | 0-3 K                  |   | 0-3 K            |                 |       | 0-3 F7        | 0-3 K   |

| Inning Stats | R: 6 | H: 4 | E: 1 | K: 0 | S: 8 | LOB: 0 | BB: 1 | P: 12 | R: 1 | H: 2 | E: 0 | K: 0 | S: 5 | LOB: 1 | BB: 0 | P: 5 | R: 2 | H: 1 | E: 0 | K: 1 | S: 6 | LOB: 2 | BB: 2 | P: 15 | R: 0 | H: 1 | E: 0 | K: 1 | S: 6 | LOB: 3 | BB: 2 | P: 14 | R: 3 | H: 3 | E: 0 | K: 0 | S: 6 | LOB: 2 | BB: 1 | P: 11 | R: 2 | H: 3 | E: 0 | K: 1 | S: 8 | LOB: 1 | BB: 0 | P: 12 | R: 0 | H: 0 | E: 1 | K: 2 | S: 8 | LOB: 1 | BB: 0 | P: 8 | R: 2 | H: 3 | E: 0 | K: 1 | S: 8 | LOB: 1 | BB: 0 | P: 8 | R: 0 | H: 0 | E: 0 | K: 1 | S: 5 | LOB: 0 | BB: 0 | P: 5 |
|--------------|------|------|------|------|------|--------|-------|-------|------|------|------|------|------|--------|-------|------|------|------|------|------|------|--------|-------|-------|------|------|------|------|------|--------|-------|-------|------|------|------|------|------|--------|-------|-------|------|------|------|------|------|--------|-------|-------|------|------|------|------|------|--------|-------|------|------|------|------|------|------|--------|-------|------|------|------|------|------|------|--------|-------|------|
|--------------|------|------|------|------|------|--------|-------|-------|------|------|------|------|------|--------|-------|------|------|------|------|------|------|--------|-------|-------|------|------|------|------|------|--------|-------|-------|------|------|------|------|------|--------|-------|-------|------|------|------|------|------|--------|-------|-------|------|------|------|------|------|--------|-------|------|------|------|------|------|------|--------|-------|------|------|------|------|------|------|--------|-------|------|

| PITCHER                               | IP  | WLS | BF | H | R | ER | SO | BB | IBB | HBP | BLK | WP | HR | S  | P  | ERA   | WHIP  |
|---------------------------------------|-----|-----|----|---|---|----|----|----|-----|-----|-----|----|----|----|----|-------|-------|
| Herm Wehmeier, R (1,1)<br>ERA: 6.75   | 0.2 | L   | 8  | 4 | 6 | 3  | 0  | 1  | 0   | 0   | 0   | 0  | 1  | 7  | 11 | 40.50 | 7.500 |
| Frank Smith, R (1,1)<br>ERA: 3.18     | 1.1 |     | 9  | 2 | 3 | 3  | 0  | 2  | 0   | 1   | 0   | 0  | 0  | 6  | 15 | 20.25 | 3.000 |
| Harry Perkowski, L (3,1)<br>ERA: 4.82 | 2.2 |     | 17 | 5 | 3 | 3  | 2  | 3  | 0   | 1   | 0   | 0  | 0  | 17 | 30 | 10.12 | 3.000 |
| Eddie Erault, R (5,1)<br>ERA: 8.26    | 3.1 |     | 18 | 6 | 4 | 4  | 4  | 1  | 0   | 0   | 0   | 0  | 1  | 25 | 29 | 10.80 | 2.100 |
| Johnny Hetki, R (9,1)<br>ERA: 7.4     | 1.0 |     | 3  | 0 | 0 | 0  | 1  | 0  | 0   | 0   | 0   | 0  | 0  | 5  | 5  | 0.00  | 0.000 |

WP: 0 PA: 55

| Batter  | 1   | 2                                   | 3                                | 4                               | 5                            | 6                               | 7                            | 8                               | 9                            | AB                              | R                            | H                               | RBI                          | BB                              | SO                           | LOB                             |
|---|---|-------------------------------------|----------------------------------|---------------------------------|------------------------------|---------------------------------|------------------------------|---------------------------------|------------------------------|---------------------------------|------------------------------|---------------------------------|------------------------------|---------------------------------|------------------------------|---------------------------------|
| Lloyd Merriman, L<br>OBP: 0.336, SLG: 0.340<br>(1, 8)   | 0-0<br>FC3-6<br>1B  |                                     | 0-3<br>K                         |                                 | 0-0<br>4-3                   |                                 |                              | 0-0<br>4-3<br>1-2               |                              | 4                               | 0                            | 1                               | 0                            | 0                               | 1                            | 2                               |
| Peanuts Lowrey, R<br>OBP: 0.337, SLG: 0.309<br>Joe Adcock, R<br>OBP: 0.180, SLG: 0.167<br>(1, 7)<br>(3, 7)<br>(8, 9)  | 0-0<br>F7   |                                     |                                  | 0-0<br>E5<br>FC4-6              |                              | 0-0<br>F8                       |                              | 0-0<br>1-3                      |                              | 1                               | 0                            | 0                               | 0                            | 0                               | 0                            | 1                               |
| Johnny Wyrostek, L<br>OBP: 0.404, SLG: 0.465<br>Jim Bolger, R<br>(1, 9)<br>(8, 7)   | 0-0<br>FC3-6<br>1-2f  |                                     |                                  | 0-0<br>FC4-6<br>BB<br>1-2f      |                              | 0-0<br>P6                       |                              |                                 | 0-0<br>G3                    | 3                               | 0                            | 0                               | 0                            | 0                               | 0                            | 2                               |
| Ted Kluszewski, L<br>OBP: 0.344, SLG: 0.558<br>(1, 3)   | 0-0<br>4-3  |                                     |                                  | 4-0<br>BB<br>1-2                |                              | 0-0<br>F7                       |                              |                                 | 0-0<br>1-3                   | 3                               | 0                            | 0                               | 0                            | 1                               | 0                            | 1                               |
| Grady Hatton, L<br>OBP: 0.338, SLG: 0.408<br>(1, 5)   |   | 0-0<br>F8                           |                                  | 0-0<br>F8                       |                              |                                 | 0-0<br>4-3                   |                                 | 0-0<br>F8                    | 4                               | 0                            | 0                               | 0                            | 0                               | 0                            | 2                               |
| Connie Ryan, R<br>OBP: 0.371, SLG: 0.391<br>(1, 4)  |   | 0-0<br>F8                           |                                  | 0-0<br>F9                       |                              |                                 | 0-0<br>G6-4-3<br>1B          |                                 |                              | 3                               | 0                            | 1                               | 0                            | 0                               | 0                            | 2                               |
| Dixie Howell, R<br>OBP: 0.348, SLG: 0.309<br>Johnny Pramesa, R<br>OBP: 0.317, SLG: 0.431<br>(1, 2)<br>(6, 2)  |   | 0-0<br>F7                           |                                  |                                 | 0-0<br>F7                    |                                 | 0-0<br>G6-4-3<br>1-2f        |                                 |                              | 2                               | 0                            | 0                               | 0                            | 0                               | 0                            | 0                               |
| Virgil Stallcup, R<br>OBP: 0.277, SLG: 0.348<br>Sammy Meeks, R<br>OBP: 0.286, SLG: 0.375<br>(1, 6)<br>(6, 6)  |   |                                     | 0-3<br>K                         |                                 | 0-0<br>P6                    |                                 |                              | 0-0<br>FC6-4<br>1B              |                              | 2                               | 0                            | 0                               | 0                            | 0                               | 1                            | 0                               |
| Herm Wehmeier, R<br>OBP: 0.227, SLG: 0.256<br>Frank Smith, R<br>OBP: 0.077, SLG: 0.077<br>Harry Perkowski, L<br>OBP: 0.429, SLG: 0.429<br>Eddie Erault, R<br>OBP: 0.167, SLG: 0.333<br>Danny Litwhiler, R<br>OBP: 0.333, SLG: 0.397<br>Johnny Hetki, R<br>(1, 1)<br>(1, 1)<br>(3, 1)<br>(5, 1)<br>(8, PH)<br>(9, 1) |   |                                     | 0-0<br>4-3                       |                                 | 0-0<br>2B                    |                                 |                              | 0-0<br>FC6-4<br>1-2f            |                              | 0                               | 0                            | 0                               | 0                            | 0                               | 0                            | 0                               |
| <b>Inning Stats</b>   | R: 0<br>E: 0<br>K: 0<br>S: 4                                  | H: 1<br>LOB: 1<br>BB: 0<br>P: 4     | R: 0<br>E: 0<br>K: 0<br>S: 3     | H: 0<br>LOB: 0<br>BB: 0<br>P: 3 | R: 0<br>E: 0<br>K: 2<br>S: 7 | H: 0<br>LOB: 0<br>BB: 0<br>P: 7 | R: 0<br>E: 1<br>K: 0<br>S: 4 | H: 0<br>LOB: 2<br>BB: 1<br>P: 8 | R: 0<br>E: 0<br>K: 0<br>S: 4 | H: 1<br>LOB: 1<br>BB: 0<br>P: 4 | R: 0<br>E: 0<br>K: 0<br>S: 3 | H: 0<br>LOB: 0<br>BB: 0<br>P: 3 | R: 0<br>E: 0<br>K: 0<br>S: 4 | H: 1<br>LOB: 1<br>BB: 0<br>P: 4 | R: 0<br>E: 0<br>K: 0<br>S: 3 | H: 0<br>LOB: 0<br>BB: 0<br>P: 3 |
| <b>PITCHER</b><br>Monk Dubiel, R<br>ERA: 3.35<br>(1, 1)   | IP: 9.0<br>WLS: W<br>BF: 32<br>H: 4<br>R: 0<br>ER: 0<br>SO: 2 | BB: 1<br>IBB: 0<br>HBP: 0<br>BLK: 0 | WP: 0<br>HR: 0<br>S: 35<br>P: 39 | ERA: 0.00<br>WHIP: 0.556        |                              |                                 |                              |                                 |                              |                                 |                              |                                 |                              |                                 |                              |                                 |

**BOTTOM**

**Chicago Cubs @ Cincinnati Reds**  
Crosley Field, Cincinnati, OH  
Sun Jul 02 1950, 3:33 AM EDT  
Att. 7,006 - Unknown

livebaseballscorecards.com

|            |           |
|------------|-----------|
| <b>AB</b>  | <b>31</b> |
| <b>R</b>   | <b>0</b>  |
| <b>H</b>   | <b>4</b>  |
| <b>RBI</b> | <b>0</b>  |
| <b>BB</b>  | <b>1</b>  |
| <b>SO</b>  | <b>2</b>  |
| <b>LOB</b> | <b>13</b> |



|       |        |
|-------|--------|
| WP: 0 | PA: 32 |
| PB: 0 |        |
| SB: 0 |        |
| CS: 0 |        |

| Batter   | 1   | 2                               | 3                            | 4                               | 5                              | 6                                | 7                            | 8                               | 9                            | AB R H RBI BB SO LOB            | TOP                          |                                 |                              |                                 |                              |                                  |                              |                                  |                                  |                                    |                                  |        |
|--|---|---------------------------------|------------------------------|---------------------------------|--------------------------------|----------------------------------|------------------------------|---------------------------------|------------------------------|---------------------------------|------------------------------|---------------------------------|------------------------------|---------------------------------|------------------------------|----------------------------------|------------------------------|----------------------------------|----------------------------------|------------------------------------|----------------------------------|--------|
| Stan Rojek, R (1, 6)<br>OBP: 0.297, SLG: 0.307       | 0-0<br>1B   |                                 | 0-3<br>K                     |                                 | 0-0<br>SH5-4                   |                                  | 0-0<br>F7                    |                                 | 0-0<br>BB<br>1B              | 4 0 2 0 0 1 1                   |                              |                                 |                              |                                 |                              |                                  |                              |                                  |                                  |                                    |                                  |        |
| Ted Beard, L (1, 8)<br>OBP: 0.364, SLG: 0.376        | 0-3<br>K  |                                 | 0-3<br>K                     |                                 | 0-0<br>F8                      |                                  | 0-0<br>F5                    |                                 | 4-0<br>BB<br>1B              | 4 0 0 1 1 2 2                   |                              |                                 |                              |                                 |                              |                                  |                              |                                  |                                  |                                    |                                  |        |
| Johnny Hopp, L (1, 3)<br>OBP: 0.411, SLG: 0.515      | 0-3<br>K  |                                 | 4-0<br>HR<br>BB              |                                 | 0-0<br>1-3                     |                                  |                              | 4-0<br>FC<br>BB<br>1B           | 0-0<br>F9                    | 3 1 0 0 2 1 2                   |                              |                                 |                              |                                 |                              |                                  |                              |                                  |                                  |                                    |                                  |        |
| Ralph Kiner, R (1, 7)<br>OBP: 0.416, SLG: 0.606      |   | 0-0<br>HR                       | 0-0<br>HR                    |                                 | 4-0<br>5-3<br>BB               |                                  |                              | 0-0<br>F8                       | 0-3<br>K                     | 4 2 2 3 1 1 3                   |                              |                                 |                              |                                 |                              |                                  |                              |                                  |                                  |                                    |                                  |        |
| Gus Bell, L (1, 9)<br>OBP: 0.350, SLG: 0.450         |   | 4-0<br>E<br>1B<br>BB            | 0-0<br>2-4<br>1B             |                                 | 0-0<br>F4                      |                                  |                              | 0-0<br>FC<br>BB<br>1B<br>1B     | 0-3<br>K                     | 4 1 1 0 1 1 4                   |                              |                                 |                              |                                 |                              |                                  |                              |                                  |                                  |                                    |                                  |        |
| Danny Murtaugh, R (1, 4)<br>OBP: 0.416, SLG: 0.443   |   | 0-0<br>F7                       | 0-0<br>2-4                   | 0-0<br>F9                       |                                | 0-0<br>5-3                       |                              | 0-0<br>1B<br>BB<br>1B           |                              | 4 0 1 0 0 0 2                   |                              |                                 |                              |                                 |                              |                                  |                              |                                  |                                  |                                    |                                  |        |
| Pete Castiglione, R (1, 5)<br>OBP: 0.281, SLG: 0.289 |   | 0-0<br>F4                       |                              | 0-0<br>K<br>1B                  |                                | 0-0<br>5-3                       |                              | 4-0<br>1B<br>BB                 |                              | 3 0 1 0 0 0 2                   |                              |                                 |                              |                                 |                              |                                  |                              |                                  |                                  |                                    |                                  |        |
| Wally Westlake, R (8, PH)<br>OBP: 0.353, SLG: 0.512  |   |                                 |                              |                                 |                                |                                  |                              | 1-2<br>2-3<br>BB                |                              | 0 0 0 0 1 0 0                   |                              |                                 |                              |                                 |                              |                                  |                              |                                  |                                  |                                    |                                  |        |
| Hank Schenz, R (8, 5)<br>OBP: 0.296, SLG: 0.403      |   |                                 |                              |                                 |                                |                                  |                              | 1-2<br>2-3<br>BB                |                              | 0 0 0 0 0 0 0                   |                              |                                 |                              |                                 |                              |                                  |                              |                                  |                                  |                                    |                                  |        |
| Ray Mueller, R (1, 2)<br>OBP: 0.303, SLG: 0.437      |   | 0-0<br>E8                       |                              | 0-3<br>K                        |                                | 0-0<br>5-3                       |                              | 0-0<br>1B<br>BB                 |                              | 3 0 1 0 0 1 1                   |                              |                                 |                              |                                 |                              |                                  |                              |                                  |                                  |                                    |                                  |        |
| Nanny Fernandez, R (8, PH)<br>OBP: 0.325, SLG: 0.409 |   | 1-3<br>1B                       |                              | 1-2<br>K                        |                                |                                  |                              | 1-2<br>2-3<br>3-H<br>1B         |                              | 1 0 1 1 0 0 0                   |                              |                                 |                              |                                 |                              |                                  |                              |                                  |                                  |                                    |                                  |        |
| Earl Turner, R (8, 2)<br>OBP: 0.255, SLG: 0.269      |   |                                 |                              |                                 |                                |                                  |                              |                                 |                              | 0 0 0 0 0 0 0                   |                              |                                 |                              |                                 |                              |                                  |                              |                                  |                                  |                                    |                                  |        |
| Bill MacDonald, R (1, 1)<br>OBP: 0.182, SLG: 0.182   |   | 0-0<br>F4                       |                              |                                 | 0-0<br>PB<br>SH5-4<br>F8<br>1B |                                  |                              | 0-0<br>1B                       |                              | 1 0 0 0 0 0 2                   |                              |                                 |                              |                                 |                              |                                  |                              |                                  |                                  |                                    |                                  |        |
| Murry Dickson, R (2, 1)<br>OBP: 0.289, SLG: 0.270    |   |                                 |                              |                                 |                                |                                  |                              |                                 |                              | 2 1 2 0 0 0 0                   |                              |                                 |                              |                                 |                              |                                  |                              |                                  |                                  |                                    |                                  |        |
| Vic Lombardi, L (7, 1)<br>OBP: 0.400, SLG: 0.333     |   |                                 |                              |                                 |                                |                                  |                              |                                 |                              | 0 0 0 0 0 0 0                   |                              |                                 |                              |                                 |                              |                                  |                              |                                  |                                  |                                    |                                  |        |
| Dale Coogan, L (8, PH)<br>OBP: 0.319, SLG: 0.317     |   |                                 |                              |                                 |                                |                                  |                              |                                 |                              | 1 0 0 0 0 0 3                   |                              |                                 |                              |                                 |                              |                                  |                              |                                  |                                  |                                    |                                  |        |
| Junior Walsh, R (8, 1)<br>OBP: 0.800, SLG: 1.000     |   |                                 |                              |                                 |                                |                                  |                              |                                 |                              | 0 0 0 0 0 0 0                   |                              |                                 |                              |                                 |                              |                                  |                              |                                  |                                  |                                    |                                  |        |
| <b>Inning Stats</b>                                  | R: 0<br>E: 0<br>K: 2<br>S: 7                          | H: 1<br>LOB: 0<br>BB: 0<br>P: 7 | R: 1<br>E: 1<br>K: 0<br>S: 5 | H: 2<br>LOB: 2<br>BB: 1<br>P: 9 | R: 2<br>E: 0<br>K: 2<br>S: 8   | H: 2<br>LOB: 1<br>BB: 1<br>P: 12 | R: 0<br>E: 0<br>K: 1<br>S: 5 | H: 1<br>LOB: 1<br>BB: 0<br>P: 5 | R: 1<br>E: 0<br>K: 0<br>S: 4 | H: 1<br>LOB: 0<br>BB: 0<br>P: 4 | R: 0<br>E: 0<br>K: 0<br>S: 3 | H: 0<br>LOB: 1<br>BB: 1<br>P: 7 | R: 0<br>E: 0<br>K: 0<br>S: 4 | H: 1<br>LOB: 1<br>BB: 0<br>P: 4 | R: 1<br>E: 0<br>K: 0<br>S: 5 | H: 2<br>LOB: 3<br>BB: 2<br>P: 13 | R: 0<br>E: 0<br>K: 2<br>S: 8 | H: 1<br>LOB: 2<br>BB: 1<br>P: 12 | 1B: 9<br>2B: 0<br>3B: 0<br>HR: 2 | SF: 0<br>SAC: 1<br>DP: 0<br>HBP: 0 | WP: 0<br>PB: 1<br>SB: 1<br>CS: 0 | PA: 41 |
| <b>PITCHER</b>                                       | IP WLS BF H R ER SO BB IBB HBP BLK WP HR S P ERA WHIP |                                 |                              |                                 |                                |                                  |                              |                                 |                              |                                 |                              |                                 |                              |                                 |                              |                                  |                              |                                  |                                  |                                    |                                  |        |
| Willie Ramsdell, R (1, 1)<br>ERA: 4.42               | 7.0 W 31 8 5 4 5 4 0 0 0 0 0 2 36 52 5.14 1.714       |                                 |                              |                                 |                                |                                  |                              |                                 |                              |                                 |                              |                                 |                              |                                 |                              |                                  |                              |                                  |                                  |                                    |                                  |        |
| Ewell Blackwell, R (8, 1)<br>ERA: 3.24               | 2.0 S 11 3 0 0 2 2 0 0 0 0 0 0 13 21 0.00 2.500       |                                 |                              |                                 |                                |                                  |                              |                                 |                              |                                 |                              |                                 |                              |                                 |                              |                                  |                              |                                  |                                  |                                    |                                  |        |

Pittsburgh Pirates @ Cincinnati Reds  
 Crosley Field, Cincinnati, OH  
 Mon Jul 03 1950, 3:33 AM EDT  
 Att. 3,405 - Unknown

livebaseballscorecards.com

|     |    |
|-----|----|
| AB  | 34 |
| R   | 5  |
| H   | 11 |
| RBI | 5  |
| BB  | 6  |
| SO  | 7  |
| LOB | 22 |



| Batter  | 1      | 2        | 3      | 4      | 5      | 6         | 7         | 8         | 9 | AB | R | H | RBI | BB | SO | LOB |
|---|--------|----------|--------|--------|--------|-----------|-----------|-----------|---|----|---|---|-----|----|----|-----|
| Lloyd Merriman, L (1, 8)<br>OBP: 0.330, SLG: 0.343  | 0-0 F8 | 0-0 L4-6 |        | 0-0 F5 |        |           | 0-0 E4    | 0-0 2B    |   | 5  | 1 | 1 | 1   | 0  | 0  | 3   |
| Peanuts Lowrey, R (1, 7)<br>OBP: 0.333, SLG: 0.311  | 0-0 F7 |          | 0-0 P3 |        | 0-0 F8 |           | 0-0 FC3-6 | 0-0 2B    |   | 5  | 1 | 1 | 1   | 0  | 0  | 1   |
| Johnny Wyrostek, L (1, 9)<br>OBP: 0.404, SLG: 0.461 | 0-0 1B |          | 0-0 F2 |        | 0-0 F7 |           | 4-0 2B    | 0-0 F9    |   | 4  | 1 | 1 | 0   | 1  | 0  | 2   |
| Ted Kluszewski, L (1, 3)<br>OBP: 0.347, SLG: 0.561  | 0-0 F9 |          | 0-0 F9 |        | 0-0 1B |           | 0-0 2B    |           |   | 4  | 0 | 2 | 2   | 0  | 0  | 1   |
| Grady Hatton, L (1, 5)<br>OBP: 0.336, SLG: 0.405    |        | 0-0 3B   |        | 0-3 K  |        | 0-0 F7    | 0-0 G3    |           |   | 4  | 1 | 1 | 0   | 0  | 1  | 2   |
| Connie Ryan, R (1, 4)<br>OBP: 0.374, SLG: 0.410     |        | 0-0 1B   |        | 0-0 2B |        | 0-0 F6    | 0-0 5-3   |           |   | 4  | 2 | 2 | 1   | 0  | 0  | 1   |
| Johnny Pramesa, R (1, 2)<br>OBP: 0.343, SLG: 0.468  |        | 0-0 1B   |        | 0-0 2B |        | 0-0 F8    |           | 0-0 FC3-6 |   | 4  | 1 | 3 | 2   | 0  | 0  | 0   |
| Herm Wehmeier, R (8, PR)<br>OBP: 0.227, SLG: 0.256  |        | 0-0 WP   |        | 0-0 2B |        |           |           |           |   | 0  | 0 | 0 | 0   | 0  | 0  | 0   |
| Dixie Howell, R (9, 2)<br>OBP: 0.348, SLG: 0.309    |        | 0-0 1B   |        | 0-0 2B |        |           |           |           |   | 0  | 0 | 0 | 0   | 0  | 0  | 0   |
| Virgil Stallcup, R (1, 6)<br>OBP: 0.281, SLG: 0.351 |        | 0-0 L4-6 |        | 0-0 F8 |        | 0-0 FC5-4 | 0-0 FC3-6 | 0-0 SH3-4 |   | 4  | 1 | 2 | 0   | 0  | 0  | 2   |
| Willie Ramsdell, R (1, 1)<br>OBP: 0.217, SLG: 0.182 |        | 0-3 K    |        | 4-0 1B |        | 0-0 FC5-4 | 0-0 SH3-4 |           |   | 2  | 0 | 0 | 0   | 1  | 1  | 2   |
| Ewell Blackwell, R (8, 1)<br>OBP: 0.171, SLG: 0.094 |        | 0-0 K    |        | 0-0 BB |        | 1-2f      |           | 1-2       |   | 0  | 0 | 0 | 0   | 0  | 0  | 0   |

| Inning Stats | R: 0 | H: 1 | E: 0 | LOB: 1 | K: 0 | P: 4 | R: 3 | H: 4 | E: 0 | LOB: 0 | K: 1 | P: 8 | R: 0 | H: 0 | E: 0 | LOB: 0 | K: 0 | P: 3 | R: 1 | H: 2 | E: 0 | LOB: 2 | K: 1 | P: 11 | R: 0 | H: 1 | E: 0 | LOB: 1 | K: 0 | P: 4 | R: 2 | H: 1 | E: 1 | LOB: 1 | K: 0 | P: 9 | R: 2 | H: 3 | E: 0 | LOB: 2 | K: 0 | P: 6 |      |  |      |  |      |
|--------------|------|------|------|--------|------|------|------|------|------|--------|------|------|------|------|------|--------|------|------|------|------|------|--------|------|-------|------|------|------|--------|------|------|------|------|------|--------|------|------|------|------|------|--------|------|------|------|--|------|--|------|
|              | S: 4 |      | S: 8 |        | S: 3 |      | S: 7 |      | S: 4 |        | S: 4 |      | S: 5 |      | S: 6 |        | S: 6 |      | S: 6 |      | S: 6 |        | S: 6 |       | S: 6 |      | S: 6 |        | S: 6 |      | S: 6 |      | S: 6 |        | S: 6 |      | S: 6 |      | S: 6 |        | S: 6 |      | S: 6 |  | S: 6 |  | S: 6 |

| PITCHER                               | IP  | WLS | BF | H | R | ER | SO | BB | IBB | HBP | BLK | WP | HR | S  | P  | ERA   | WHIP  |
|---------------------------------------|-----|-----|----|---|---|----|----|----|-----|-----|-----|----|----|----|----|-------|-------|
| Bill MacDonald, R (1, 1)<br>ERA: 5.33 | 1.0 |     | 8  | 5 | 3 | 3  | 0  | 0  | 0   | 0   | 0   | 0  | 0  | 8  | 8  | 27.00 | 5.000 |
| Murry Dickson, R (2, 1)<br>ERA: 4.57  | 5.1 | L   | 23 | 5 | 3 | 2  | 2  | 2  | 0   | 0   | 0   | 1  | 0  | 25 | 33 | 3.38  | 1.312 |
| Vic Lombardi, L (7, 1)<br>ERA: 8.27   | 0.2 |     | 2  | 0 | 0 | 0  | 0  | 0  | 0   | 0   | 0   | 0  | 0  | 2  | 2  | 0.00  | 0.000 |
| Junior Walsh, R (8, 1)<br>ERA: 6.39   | 1.0 |     | 6  | 3 | 2 | 2  | 0  | 0  | 0   | 0   | 0   | 0  | 0  | 6  | 6  | 18.00 | 3.000 |

**BOTTOM**

**Pittsburgh Pirates @ Cincinnati Reds**  
Crosley Field, Cincinnati, OH

Mon Jul 03 1950, 3:33 AM EDT  
Att. 3,405 - Unknown

|     |    |
|-----|----|
| AB  | 36 |
| R   | 8  |
| H   | 13 |
| RBI | 7  |
| BB  | 2  |
| SO  | 2  |
| LOB | 14 |



| WP | HR | S | P  | ERA | WHIP |
|----|----|---|----|-----|------|
| 1  | 0  | 0 | 39 |     |      |

| Batter  | 1                            | 2                               | 3                            | 4                               | 5                            | 6                                | 7                            | 8                               | 9                            | AB R H RBI BB SO LOB   | TOP                          |                                 |                              |                                  |                              |                                 |                              |                                 |                                  |                                    |                                  |        |
|---|------------------------------|---------------------------------|------------------------------|---------------------------------|------------------------------|----------------------------------|------------------------------|---------------------------------|------------------------------|--|------------------------------|---------------------------------|------------------------------|----------------------------------|------------------------------|---------------------------------|------------------------------|---------------------------------|----------------------------------|------------------------------------|----------------------------------|--------|
| <b>Stan Rojek, R</b> (1, 6)<br><small>OBP: 0.298, SLG: 0.302</small><br><b>Ted Beard, L</b> (7, PH)<br><small>OBP: 0.361, SLG: 0.373</small><br><b>George Strickland, R</b> (7, 6)<br><small>OBP: 0.250, SLG: 0.125</small><br><b>Dale Coogan, L</b> (9, PH)<br><small>OBP: 0.324, SLG: 0.317</small> | 0-0<br>4-3                   |                                 | 4-0<br>2B<br>BB              |                                 | 0-3<br>K                     |                                  | 0-3<br>K                     |                                 | 4-0<br>L6-3<br>BB            | 2 1 0 0 1 1 1<br>1 0 0 0 0 1 1<br>0 0 0 0 0 0 0<br>0 0 0 0 0 1 0 0 |                              |                                 |                              |                                  |                              |                                 |                              |                                 |                                  |                                    |                                  |        |
| <b>Johnny Hopp, L</b> (1, 3)<br><small>OBP: 0.416, SLG: 0.520</small>   | 0-0<br>G6-4-3<br>1B          |                                 | 0-0<br>1-H<br>2-H<br>2B      |                                 | 4-0<br>6-3<br>BB             |                                  | 0-0<br>E4<br>BB              |                                 | 0-0<br>L6-3<br>1-2           | 4 0 2 2 1 0 1  |                              |                                 |                              |                                  |                              |                                 |                              |                                 |                                  |                                    |                                  |        |
| <b>Ralph Kiner, R</b> (1, 7)<br><small>OBP: 0.417, SLG: 0.601</small>   | 0-0<br>G6-4-3<br>1-2f        |                                 | 4-0<br>FC4-6<br>BB           |                                 | 0-0<br>6-3                   |                                  | 4-0<br>1-2<br>BB             |                                 |                              | 2 0 0 0 2 0 3  |                              |                                 |                              |                                  |                              |                                 |                              |                                 |                                  |                                    |                                  |        |
| <b>Gus Bell, L</b> (1, 9)<br><small>OBP: 0.340, SLG: 0.436</small>  |                              | 0-0<br>4-1                      | 0-0<br>FC4-6<br>1-2f         |                                 | 0-0<br>F7                    |                                  | 0-0<br>4-3                   |                                 |                              | 4 0 0 0 0 0 6  |                              |                                 |                              |                                  |                              |                                 |                              |                                 |                                  |                                    |                                  |        |
| <b>Wally Westlake, R</b> (1, 8)<br><small>OBP: 0.351, SLG: 0.507</small>  |                              | 0-0<br>F7                       |                              | 0-3<br>K                        |                              | 0-0<br>CS<br>1B                  |                              | 0-0<br>F8                       |                              | 4 0 1 0 0 1 0  |                              |                                 |                              |                                  |                              |                                 |                              |                                 |                                  |                                    |                                  |        |
| <b>Danny Murtaugh, R</b> (1, 4)<br><small>OBP: 0.413, SLG: 0.444</small>  |                              | 0-0<br>F8                       |                              | 0-0<br>1B<br>2B                 |                              | 0-0<br>P4<br>1-2                 |                              | 0-0<br>L6                       |                              | 4 1 1 0 0 0 1  |                              |                                 |                              |                                  |                              |                                 |                              |                                 |                                  |                                    |                                  |        |
| <b>Pete Castiglione, R</b> (1, 5)<br><small>OBP: 0.297, SLG: 0.296</small>  |                              |                                 | 0-0<br>F8                    | 0-0<br>2-3-4-2<br>1B            |                              | 0-0<br>1-3                       |                              | 0-0<br>1B                       |                              | 4 0 2 1 0 0 0  |                              |                                 |                              |                                  |                              |                                 |                              |                                 |                                  |                                    |                                  |        |
| <b>Earl Turner, R</b> (1, 2)<br><small>OBP: 0.241, SLG: 0.255</small><br><b>Nanny Fernandez, R</b> (8, PH)<br><small>OBP: 0.324, SLG: 0.407</small><br><b>Ray Mueller, R</b> (8, 2)<br><small>OBP: 0.303, SLG: 0.437</small>  |                              |                                 | 0-0<br>P4                    | 0-3<br>K2-3-4-2<br>1-1          |                              | 0-3<br>K                         |                              | 0-3<br>K                        |                              | 3 0 0 0 0 2 1<br>1 0 0 0 0 1 1<br>0 0 0 0 0 0 0                    |                              |                                 |                              |                                  |                              |                                 |                              |                                 |                                  |                                    |                                  |        |
| <b>Cliff Chambers, L</b> (1, 1)<br><small>OBP: 0.340, SLG: 0.396</small><br><b>Vern Law, R</b> (7, 1)<br><b>Jack Phillips, R</b> (9, PH)<br><small>OBP: 0.277, SLG: 0.318</small>   |                              |                                 | 0-0<br>BB<br>2B<br>1B        |                                 | 0-0<br>6-3<br>BB<br>1B       |                                  | 0-0<br>E<br>2B               |                                 | 0-0<br>P4                    | 3 2 3 0 0 0 0<br>0 0 0 0 0 0 0<br>1 0 0 0 0 0 0                    |                              |                                 |                              |                                  |                              |                                 |                              |                                 |                                  |                                    |                                  |        |
| <b>Inning Stats</b>   | R: 0<br>E: 0<br>K: 0<br>S: 3 | H: 1<br>LOB: 0<br>BB: 0<br>P: 3 | R: 0<br>E: 0<br>K: 0<br>S: 3 | H: 0<br>LOB: 0<br>BB: 0<br>P: 3 | R: 2<br>E: 0<br>K: 0<br>S: 5 | H: 2<br>LOB: 2<br>BB: 2<br>P: 13 | R: 1<br>E: 0<br>K: 2<br>S: 8 | H: 2<br>LOB: 1<br>BB: 0<br>P: 8 | R: 0<br>E: 0<br>K: 1<br>S: 6 | H: 1<br>LOB: 2<br>BB: 1<br>P: 10                                   | R: 0<br>E: 0<br>K: 0<br>S: 3 | H: 1<br>LOB: 0<br>BB: 0<br>P: 3 | R: 1<br>E: 1<br>K: 2<br>S: 9 | H: 1<br>LOB: 2<br>BB: 1<br>P: 13 | R: 0<br>E: 0<br>K: 1<br>S: 6 | H: 1<br>LOB: 1<br>BB: 0<br>P: 6 | R: 0<br>E: 0<br>K: 0<br>S: 2 | H: 0<br>LOB: 0<br>BB: 1<br>P: 6 | 1B: 6<br>2B: 5<br>3B: 0<br>HR: 0 | SF: 0<br>SAC: 0<br>DP: 3<br>HBP: 0 | WP: 0<br>PB: 0<br>SB: 0<br>CS: 1 | PA: 38 |
| <b>PITCHER</b><br><b>Herm Wehmeier, R</b> (1, 1)<br><small>ERA: 6.44</small>  | IP<br>9.0                    | WLS<br>W                        | BF<br>38                     | H<br>9                          | R<br>4                       | ER<br>3                          | SO<br>6                      | BB<br>5                         | IBB<br>0                     | HBP<br>0   | BLK<br>0                     | WP<br>0                         | HR<br>0                      | S<br>45                          | P<br>65                      | ERA<br>3.00                     | WHIP<br>1.556                |                                 |                                  |                                    |                                  |        |
|   |                              |                                 |                              |                                 | <b>PITCHER</b><br>           | IP                               | WLS                          | BF                              | H                            | R  | ER                           | SO                              | BB                           | IBB                              | HBP                          | BLK                             | WP                           | HR                              | S                                | P                                  | ERA                              | WHIP   |

**Pittsburgh Pirates @ Cincinnati Reds**  
 Crosley Field, Cincinnati, OH  
 Tue Jul 04 1950, 3:33 AM EDT  
 Unknown

[livebaseballscorecards.com](http://livebaseballscorecards.com)

|            |           |
|------------|-----------|
| <b>AB</b>  | <b>33</b> |
| <b>R</b>   | <b>4</b>  |
| <b>H</b>   | <b>9</b>  |
| <b>RBI</b> | <b>3</b>  |
| <b>BB</b>  | <b>5</b>  |
| <b>SO</b>  | <b>6</b>  |
| <b>LOB</b> | <b>15</b> |





| Batter  | 1                        | 2         | 3                    | 4                          | 5         | 6                     | 7                            | 8                    | 9 |
|---|--------------------------|-----------|----------------------|----------------------------|-----------|-----------------------|------------------------------|----------------------|---|
| <b>Bobby Adams, R</b> (1, 5)<br>OBP: 0.333, SLG: 0.327<br><b>Grady Hatton, L</b> (7, 5)<br>OBP: 0.339, SLG: 0.417 | 0-0<br>F8                |           | 4-0<br>FC5-4<br>BB   | 0-3<br>K                   |           | 0-0<br>F3             |                              | 0-0<br>F8<br>3B      |   |
| <b>Peanuts Lowrey, R</b> (1, 7)<br>OBP: 0.340, SLG: 0.311   | 4-0<br>1B<br>1-4<br>BB   |           | 0-0<br>FC5-4<br>1-2f |                            | 0-0<br>F7 |                       | 0-0<br>FC2-6<br>1B           | 4-0<br>FC4-6<br>BB   |   |
| <b>Johnny Wyrostek, L</b> (1, 9)<br>OBP: 0.404, SLG: 0.460  | 0-0<br>1-3<br>1B         |           | 0-0<br>P4            |                            | 0-0<br>1B |                       | 0-0<br>FC2-6<br>2B<br>1-2f   | 0-0<br>F8<br>3-H     |   |
| <b>Ted Kluszewski, L</b> (1, 3)<br>OBP: 0.339, SLG: 0.548   | 0-0<br>1-4<br>1-2<br>3-H |           |                      | 0-0<br>F8                  | 0-0<br>P6 |                       | 0-0<br>F6<br>1-2f            | 0-0<br>FC4-6<br>1-2f |   |
| <b>Connie Ryan, R</b> (1, 4)<br>OBP: 0.376, SLG: 0.409  | 0-3<br>K                 |           |                      | 0-0<br>S<br>1B<br>2B<br>1B | 0-0<br>F7 |                       | 4-0<br>1-2<br>2B<br>BB       |                      |   |
| <b>Bob Usher, R</b> (1, 8)<br>OBP: 0.329, SLG: 0.397  |                          | 0-0<br>G3 |                      | 0-0<br>S<br>2B<br>1B       |           | 0-0<br>G5-4-3<br>1B   | 0-0<br>1-H<br>2-H<br>2B      |                      |   |
| <b>Dixie Howell, R</b> (1, 2)<br>OBP: 0.336, SLG: 0.297   |                          | 0-0<br>F7 |                      | 0-3<br>K<br>1-2<br>2-3     |           | 0-0<br>G5-4-3<br>1-2f | 0-0<br>P6                    |                      |   |
| <b>Virgil Stallcup, R</b> (1, 6)<br>OBP: 0.290, SLG: 0.360  |                          | 0-3<br>K  |                      | 0-0<br>2B<br>2B            |           | 4-0<br>1B<br>BB       | 0-0<br>E1<br>1-3<br>3B<br>1B |                      |   |
| <b>Herm Wehmeier, R</b> (1, 1)<br>OBP: 0.250, SLG: 0.298  |                          |           | 0-0<br>6-3           | 0-0<br>2B                  |           | 0-0<br>1B             | 0-0<br>1-3                   |                      |   |

| Inning Stats | R: 1   | H: 1  | E: 0  | K: 1  | S: 6   | R: 0   | H: 0  | E: 0   | K: 1  | S: 5  | R: 0   | H: 0  | E: 0   | K: 0  | S: 3  | R: 3   | H: 4  | E: 0   | K: 2  | S: 11  | R: 0   | H: 1  | E: 0   | K: 0  | S: 4  | R: 0   | H: 2  | E: 0   | K: 0  | S: 4   | R: 2  | H: 2   | E: 0  | K: 0   | S: 5  | R: 2   | H: 2  | E: 1   | K: 0  | S: 5   |
|--------------|--------|-------|-------|-------|--------|--------|-------|--------|-------|-------|--------|-------|--------|-------|-------|--------|-------|--------|-------|--------|--------|-------|--------|-------|-------|--------|-------|--------|-------|--------|-------|--------|-------|--------|-------|--------|-------|--------|-------|--------|
|              | LOB: 1 | BB: 1 | BB: 1 | BB: 0 | BB: 10 | LOB: 0 | BB: 0 | LOB: 0 | BB: 1 | BB: 5 | LOB: 1 | BB: 0 | LOB: 1 | BB: 0 | BB: 7 | LOB: 1 | BB: 0 | LOB: 1 | BB: 0 | BB: 11 | LOB: 2 | BB: 1 | LOB: 2 | BB: 1 | BB: 8 | LOB: 1 | BB: 1 | LOB: 1 | BB: 1 | LOB: 1 | BB: 1 | LOB: 1 | BB: 1 | LOB: 1 | BB: 1 | LOB: 1 | BB: 1 | LOB: 1 | BB: 1 | LOB: 1 |

| PITCHER                                      | IP  | WLS | BF | H  | R | ER | SO | BB | IBB | HBP | BLK | WP | HR | S  | P  | ERA   | WHIP  |
|--|-----|-----|----|----|---|----|----|----|-----|-----|-----|----|----|----|----|-------|-------|
| <b>Cliff Chambers, L</b> (1, 1)<br>ERA: 4.23 | 6.2 | L   | 33 | 10 | 6 | 6  | 4  | 4  | 0   | 0   | 0   | 0  | 0  | 37 | 53 | 8.10  | 2.100 |
| <b>Vern Law, R</b> (7, 1)<br>ERA: 6.82       | 1.1 |     | 7  | 2  | 2 | 2  | 0  | 1  | 0   | 0   | 0   | 0  | 0  | 6  | 10 | 13.50 | 2.250 |

**BOTTOM**

**Pittsburgh Pirates @ Cincinnati Reds**  
Crosley Field, Cincinnati, OH  
Tue Jul 04 1950, 3:33 AM EDT  
Unknown

|     |    |
|-----|----|
| AB  | 35 |
| R   | 8  |
| H   | 12 |
| RBI | 8  |
| BB  | 5  |
| SO  | 4  |
| LOB | 18 |



|    |   |     |   |    |   |    |    |
|----|---|-----|---|----|---|----|----|
| 1B | 8 | SF  | 0 | WP | 0 | PA | 40 |
| 2B | 3 | SAC | 0 | PB | 0 |    |    |
| 3B | 1 | DP  | 1 | SB | 2 |    |    |
| HR | 0 | HBP | 0 | CS | 0 |    |    |

| Batter   | 1  | 2                               | 3                            | 4                               | 5                            | 6                                | 7                               | 8                                | 9                            | AB R H RBI BB SO LOB             | TOP                          |                                 |  |                                 |                              |                                 |                                  |                                    |                                  |        |
|--|--|---------------------------------|------------------------------|---------------------------------|------------------------------|----------------------------------|---------------------------------|----------------------------------|------------------------------|----------------------------------|------------------------------|---------------------------------|--|---------------------------------|------------------------------|---------------------------------|----------------------------------|------------------------------------|----------------------------------|--------|
| Stan Rojek, R (1, 6)<br>OBP: 0.301, SLG: 0.301       | 0-0<br>5-3   |                                 | 0-0<br>5-3                   |                                 | 4-0<br>FC6-4<br>BB           |                                  | 0-0<br>4-3<br>SH1-4<br>2B<br>1B |                                  | 0-0<br>1-3                   | 4 1 1 0 1 0 0                    |                              |                                 |  |                                 |                              |                                 |                                  |                                    |                                  |        |
| Ted Beard, L (1, 8)<br>OBP: 0.365, SLG: 0.377        | 0-0<br>FC5<br>HBP<br>1B  |                                 | 0-0<br>F8                    |                                 | 0-0<br>FC6-4<br>1-2f         |                                  | 0-0<br>SH1-4<br>1-2             |                                  | 0-0<br>BB<br>1B              | 4 0 2 0 0 0 2                    |                              |                                 |  |                                 |                              |                                 |                                  |                                    |                                  |        |
| Dale Coogan, L (1, 3)<br>OBP: 0.333, SLG: 0.312      | 1-0<br>1-2<br>HBP  |                                 |                              | 0-3<br>K                        |                              | 4-0<br>G4-6-3<br>1B<br>BB        |                                 | 0-0<br>4-3<br>2-3                | 4-0<br>G6-4-3<br>BB          | 2 1 0 0 2 1 1                    |                              |                                 |  |                                 |                              |                                 |                                  |                                    |                                  |        |
| Ralph Kiner, R (1, 7)<br>OBP: 0.420, SLG: 0.598      | 0-3<br>K   |                                 |                              | 4-0<br>FC4-6<br>BB              |                              | 0-0<br>G4-6-3<br>1-2<br>1B       |                                 | 4-0<br>2B<br>BB                  | 0-0<br>G6-4-3<br>1-2f        | 3 0 1 0 2 1 4                    |                              |                                 |  |                                 |                              |                                 |                                  |                                    |                                  |        |
| Gus Bell, L (1, 9)<br>OBP: 0.338, SLG: 0.438         | 0-0<br>FC5<br>2-3f   |                                 |                              | 0-0<br>FC4-6<br>1-2f            |                              | 0-0<br>G4-6-3<br>1-2f<br>2-3     |                                 | 0-0<br>1-3<br>2B                 |                              | 4 0 1 1 0 0 5                    |                              |                                 |  |                                 |                              |                                 |                                  |                                    |                                  |        |
| Danny Murtaugh, R (1, 4)<br>OBP: 0.411, SLG: 0.439   |  | 0-0<br>F8                       |                              | 0-3<br>K                        |                              | 4-0<br>1B<br>BB                  |                                 | 0-0<br>F9                        |                              | 3 1 0 0 1 1 3                    |                              |                                 |  |                                 |                              |                                 |                                  |                                    |                                  |        |
| Pete Castiglione, R (1, 5)<br>OBP: 0.283, SLG: 0.291 |  | 0-0<br>F8                       |                              | 0-3<br>K                        |                              | 0-0<br>1-2<br>2B<br>1B           |                                 | 0-3<br>K                         |                              | 2 0 0 0 0 1 0                    |                              |                                 |  |                                 |                              |                                 |                                  |                                    |                                  |        |
| Wally Westlake, R (6, PH)<br>OBP: 0.354, SLG: 0.509  |  |                                 |                              |                                 |                              |                                  |                                 |                                  |                              | 1 1 1 1 0 0 0                    |                              |                                 |  |                                 |                              |                                 |                                  |                                    |                                  |        |
| Bill MacDonald, R (6, 1)<br>OBP: 0.174, SLG: 0.174   |  |                                 |                              |                                 |                              |                                  |                                 |                                  |                              | 1 0 0 0 0 1 0                    |                              |                                 |  |                                 |                              |                                 |                                  |                                    |                                  |        |
| Vic Lombardi, L (9, 1)<br>OBP: 0.400, SLG: 0.333     |  |                                 |                              |                                 |                              |                                  |                                 |                                  |                              | 0 0 0 0 0 0 0                    |                              |                                 |  |                                 |                              |                                 |                                  |                                    |                                  |        |
| Ray Mueller, R (1, 2)<br>OBP: 0.313, SLG: 0.467      |  | 0-0<br>5-3                      |                              |                                 |                              | 0-0<br>2B                        |                                 | 0-0<br>1-3<br>2B                 |                              | 4 0 2 2 0 0 0                    |                              |                                 |  |                                 |                              |                                 |                                  |                                    |                                  |        |
| Hank Borowy, R (1, 1)<br>OBP: 0.167, SLG: 0.167      |  |                                 | 0-0<br>F9                    |                                 | 0-0<br>P3                    |                                  | 0-0<br>P4                       |                                  | 0-0<br>P5                    | 2 0 0 0 0 0 1                    |                              |                                 |  |                                 |                              |                                 |                                  |                                    |                                  |        |
| Nanny Fernandez, R (6, PH)<br>OBP: 0.321, SLG: 0.403 |  |                                 |                              |                                 |                              |                                  |                                 |                                  |                              | 2 0 0 0 0 0 1                    |                              |                                 |  |                                 |                              |                                 |                                  |                                    |                                  |        |
| <b>Inning Stats</b>                                  | R: 0<br>E: 0<br>K: 1<br>S: 6   | H: 1<br>LOB: 2<br>BB: 0<br>P: 7 | R: 0<br>E: 0<br>K: 0<br>S: 3 | H: 0<br>LOB: 0<br>BB: 0<br>P: 3 | R: 0<br>E: 0<br>K: 2<br>S: 7 | H: 0<br>LOB: 1<br>BB: 1<br>P: 11 | R: 0<br>E: 0<br>K: 1<br>S: 6    | H: 1<br>LOB: 2<br>BB: 1<br>P: 10 | R: 3<br>E: 0<br>K: 0<br>S: 5 | H: 3<br>LOB: 1<br>BB: 2<br>P: 13 | R: 1<br>E: 0<br>K: 0<br>S: 5 | H: 2<br>LOB: 2<br>BB: 1<br>P: 9 | R: 0<br>E: 0<br>K: 1<br>S: 5   | H: 0<br>LOB: 0<br>BB: 0<br>P: 5 | R: 0<br>E: 0<br>K: 0<br>S: 3 | H: 1<br>LOB: 1<br>BB: 1<br>P: 7 | 1B: 5<br>2B: 3<br>3B: 0<br>HR: 0 | SF: 0<br>SAC: 1<br>DP: 2<br>HBP: 1 | WP: 0<br>PB: 0<br>SB: 0<br>CS: 0 | PA: 40 |
| <b>PITCHER</b><br>Howie Fox, R (1, 1)<br>ERA: 5.03   | IP: 9.0<br>WLS: W<br>BF: 40<br>H: 8<br>R: 4<br>ER: 4<br>SO: 5<br>BB: 6<br>IBB: 0<br>HBP: 1<br>BLK: 0<br>WP: 0<br>HR: 0<br>S: 43<br>P: 68<br>ERA: 4.00<br>WHIP: 1.556 |                                 |                              |                                 |                              |                                  |                                 |                                  |                              |                                  |                              | <b>PITCHER</b>                  | IP: 9.0<br>WLS: W<br>BF: 40<br>H: 8<br>R: 4<br>ER: 4<br>SO: 5<br>BB: 6<br>IBB: 0<br>HBP: 1<br>BLK: 0<br>WP: 0<br>HR: 0<br>S: 43<br>P: 68<br>ERA: 4.00<br>WHIP: 1.556 |                                 |                              |                                 |                                  |                                    |                                  |        |

**Pittsburgh Pirates @ Cincinnati Reds**  
 Crosley Field, Cincinnati, OH  
 Tue Jul 04 1950, 3:38 AM EDT  
 Att: 10,728 - Unknown

livebaseballscorecards.com

|     |    |
|-----|----|
| AB  | 32 |
| R   | 4  |
| H   | 8  |
| RBI | 4  |
| BB  | 6  |
| SO  | 5  |
| LOB | 17 |



| Batter   | 1             | 2                | 3             | 4             | 5              | 6 | 7                | 8                        | 9                       | AB R H RBI BB SO LOB   |
|--|---------------|------------------|---------------|---------------|----------------|---|------------------|--------------------------|-------------------------|--|
| Lloyd Merriman, L (1, 8)<br>OBP: 0.333, SLG: 0.349   | 0-0 1-3<br>1B | 0-0 P6<br>1B     |               |               | 0-0 4-3<br>2B  |   | 0-0 4-3<br>1B    |                          | 4-0 1B BB<br>1-2 BB     | 4 1 1 0 1 0 2  |
| Peanuts Lowrey, R (1, 7)<br>OBP: 0.343, SLG: 0.312<br>Harry Perkowski, L (9, PH)<br>OBP: 0.429, SLG: 0.429<br>Danny Litwhiler, R (9, PH)<br>OBP: 0.343, SLG: 0.397<br>Bob Usher, R (9, PR)<br>OBP: 0.329, SLG: 0.397 | 0-0 HR<br>1B  | 0-0 L6<br>1B     |               |               | 0-0 4-3<br>2-3 |   | 4-0 1B BB<br>1B  |                          | 4-0 1B BB<br>1-2 2-3 BB | 3 1 1 0 1 0 3<br>0 0 0 0 0 0 0<br>0 0 0 0 1 0 0<br>0 0 0 0 0 0 0 |
| Johnny Wyrostek, L (1, 9)<br>OBP: 0.407, SLG: 0.475  | 0-0 1-H<br>HR |                  | 0-0 3-1<br>1B |               | 0-0 4-3<br>3-H |   | 0-0 1-2<br>1B    |                          | 0-0 1-2<br>3-H 1B       | 5 1 3 4 0 0 0  |
| Ted Kluszewski, L (1, 3)<br>OBP: 0.342, SLG: 0.557   | 0-0 F7<br>1B  |                  | 0-0 2B        |               | 0-0 2B         |   | 0-0 G3           |                          |                         | 4 0 2 0 0 0 2  |
| Grady Hatton, L (1, 5)<br>OBP: 0.337, SLG: 0.411   | 0-0 4-3<br>1B |                  | 0-0 3-1<br>1B |               | 0-0 4-3<br>1B  |   |                  | 4-0 WP SH1-4<br>FC5-2 BB |                         | 3 0 0 0 1 0 2  |
| Connie Ryan, R (1, 4)<br>OBP: 0.376, SLG: 0.407  |               | 0-0 1B F7<br>1B  | 0-0 F8<br>1B  |               | 0-0 5-3<br>1B  |   | 0-0 SH1-4<br>1-2 |                          | 0-0 SH1-4<br>1-2        | 3 1 1 0 0 0 1  |
| Johnny Pramesa, R (1, 2)<br>OBP: 0.338, SLG: 0.455   |               | 0-0 1-3<br>SH 1B |               | 0-0 6-3<br>1B | 0-0 6-3<br>1B  |   | 0-0 FC5-2<br>2-H |                          | 0-0 FC5-2<br>2-H        | 4 0 1 0 0 0 1  |
| Virgil Stallcup, R (1, 6)<br>OBP: 0.284, SLG: 0.353  |               | 0-0 3-H<br>F7    |               | 0-3 K<br>1B   | 0-0 F8<br>1B   |   | 0-0 F7<br>1B     |                          | 0-0 F7<br>1B            | 4 0 0 1 0 1 2  |
| Howie Fox, R (1, 1)<br>OBP: 0.231, SLG: 0.385<br>Bobby Adams, R (9, PH)<br>OBP: 0.331, SLG: 0.325  |               | 0-0 SH<br>1-2    |               | 0-0 P6<br>1B  | 0-0 K<br>1B    |   | 0-3 K<br>1B      |                          | 0-0 E1<br>BB 1B BB      | 2 0 0 0 0 1 0<br>1 1 0 0 0 0 0                                   |

| Inning Stats | R: 2<br>E: 0<br>K: 0<br>S: 5 | H: 2<br>LOB: 0<br>BB: 0<br>P: 5 | R: 1<br>E: 1<br>K: 0<br>S: 6 | H: 2<br>LOB: 2<br>BB: 0<br>P: 6 | R: 0<br>E: 0<br>K: 0<br>S: 4 | H: 1<br>LOB: 1<br>BB: 0<br>P: 4 | R: 0<br>E: 0<br>K: 1<br>S: 5 | H: 0<br>LOB: 0<br>BB: 0<br>P: 5 | R: 1<br>E: 0<br>K: 0<br>S: 5 | H: 2<br>LOB: 1<br>BB: 0<br>P: 5 | R: 0<br>E: 0<br>K: 0<br>S: 3 | H: 0<br>LOB: 0<br>BB: 0<br>P: 3 | R: 0<br>E: 0<br>K: 1<br>S: 6 | H: 1<br>LOB: 2<br>BB: 1<br>P: 10 | R: 0<br>E: 0<br>K: 0<br>S: 3 | H: 0<br>LOB: 1<br>BB: 1<br>P: 7 | R: 1<br>E: 1<br>K: 0<br>S: 2 | H: 1<br>LOB: 3<br>BB: 2<br>P: 10 | 1B: 5<br>2B: 3<br>3B: 0<br>HR: 1 | SF: 0<br>SAC: 2<br>DP: 0<br>HBP: 0 | WP: 1<br>PB: 0<br>SB: 0<br>CS: 0 | PA: 39 |
|--------------|------------------------------|---------------------------------|------------------------------|---------------------------------|------------------------------|---------------------------------|------------------------------|---------------------------------|------------------------------|---------------------------------|------------------------------|---------------------------------|------------------------------|----------------------------------|------------------------------|---------------------------------|------------------------------|----------------------------------|----------------------------------|------------------------------------|----------------------------------|--------|
|--------------|------------------------------|---------------------------------|------------------------------|---------------------------------|------------------------------|---------------------------------|------------------------------|---------------------------------|------------------------------|---------------------------------|------------------------------|---------------------------------|------------------------------|----------------------------------|------------------------------|---------------------------------|------------------------------|----------------------------------|----------------------------------|------------------------------------|----------------------------------|--------|

| PITCHER                               | IP  | WLS | BF | H | R | ER | SO | BB | IBB | HBP | BLK | WP | HR | S  | P  | ERA  | WHIP  |
|---------------------------------------|-----|-----|----|---|---|----|----|----|-----|-----|-----|----|----|----|----|------|-------|
| Hank Borowy, R (1, 1)<br>ERA: 7.66    | 5.0 |     | 23 | 7 | 4 | 4  | 1  | 0  | 0   | 0   | 0   | 0  | 1  | 25 | 25 | 7.20 | 1.400 |
| Bill MacDonald, R (6, 1)<br>ERA: 5.05 | 3.0 | L   | 14 | 1 | 1 | 0  | 1  | 3  | 0   | 0   | 0   | 1  | 0  | 13 | 25 | 0.00 | 1.333 |
| Vic Lombardi, L (9, 1)<br>ERA: 8.27   | 0.0 |     | 2  | 1 | 0 | 0  | 0  | 1  | 0   | 0   | 0   | 0  | 0  | 1  | 5  | ∞    | ∞     |

BOTTOM

Pittsburgh Pirates @ Cincinnati Reds  
Crosley Field, Cincinnati, OH  
Tue Jul 04 1950, 3:38 AM EDT  
Att. 10,728 - Unknown

livebaseballscores.com

|     |    |
|-----|----|
| AB  | 33 |
| R   | 5  |
| H   | 9  |
| RBI | 5  |
| BB  | 4  |
| SO  | 2  |
| LOB | 13 |



| Batter   | 1                            | 2                               | 3                            | 4                                | 5                            | 6                               | 7                            | 8                               | 9                            | 10                              | 11                           | AB                               | R                            | H                               | RBI                          | BB                              | SO                           | LOB                              | TOP                              |                                    |                                  |        |
|--|------------------------------|---------------------------------|------------------------------|----------------------------------|------------------------------|---------------------------------|------------------------------|---------------------------------|------------------------------|---------------------------------|------------------------------|----------------------------------|------------------------------|---------------------------------|------------------------------|---------------------------------|------------------------------|----------------------------------|----------------------------------|------------------------------------|----------------------------------|--------|
| Lloyd Merriman, L (1, 8)<br>OBP: 0.328, SLG: 0.342<br>Bob Usher, R (11, PH)<br>OBP: 0.329, SLG: 0.400 (11, 8)  | F8                           |                                 | G6-3                         |                                  | 4-3                          |                                 |                              |                                 | G3                           |                                 | F7                           | 5                                | 0                            | 1                               | 0                            | 0                               | 0                            | 2                                |                                  |                                    |                                  |        |
| Peanuts Lowrey, R (1, 7)<br>OBP: 0.336, SLG: 0.305   | F8                           |                                 | 6-3                          |                                  |                              | G4-3<br>1B                      |                              |                                 |                              | FC1-6<br>BB                     |                              | 3                                | 2                            | 1                               | 0                            | 2                               | 0                            | 0                                |                                  |                                    |                                  |        |
| Johnny Wyrostek, L (1, 9)<br>OBP: 0.399, SLG: 0.461  | 5-3                          |                                 |                              | L3                               |                              | P5                              |                              |                                 | FC4-6<br>1B                  | FC1-6<br>CS                     |                              | 5                                | 0                            | 1                               | 0                            | 0                               | 0                            | 2                                |                                  |                                    |                                  |        |
| Grady Hatton, L (1, 5)<br>OBP: 0.331, SLG: 0.402   |                              | 3-1                             |                              | F7                               |                              | G4-3                            |                              |                                 | FC4-6<br>2B                  |                                 |                              | 5                                | 1                            | 0                               | 1                            | 0                               | 1                            | 3                                |                                  |                                    |                                  |        |
| Connie Ryan, R (1, 4)<br>OBP: 0.380, SLG: 0.399  |                              | BB<br>BB                        |                              | F7                               |                              |                                 |                              |                                 | L9                           |                                 |                              | 3                                | 1                            | 1                               | 1                            | 2                               | 0                            | 1                                |                                  |                                    |                                  |        |
| Joe Adcock, R (1, 3)<br>OBP: 0.254, SLG: 0.333   |                              | BB<br>BB                        |                              |                                  |                              | G6-4-3<br>1B                    |                              |                                 |                              |                                 |                              | 4                                | 1                            | 2                               | 1                            | 1                               | 0                            | 2                                |                                  |                                    |                                  |        |
| Johnny Pramesa, R (1, 2)<br>OBP: 0.321, SLG: 0.418   |                              | F7                              |                              |                                  |                              |                                 |                              |                                 |                              |                                 |                              | 5                                | 0                            | 1                               | 0                            | 0                               | 2                            | 4                                |                                  |                                    |                                  |        |
| Virgil Stallcup, R (1, 6)<br>OBP: 0.277, SLG: 0.339  |                              | F8                              |                              |                                  |                              | G6-4-3<br>1B                    |                              |                                 |                              |                                 |                              | 4                                | 0                            | 1                               | 0                            | 1                               | 0                            | 4                                |                                  |                                    |                                  |        |
| Willie Ramsdell, R (1, 1)<br>OBP: 0.222, SLG: 0.160<br>Ken Raffensberger, R (9, 1)<br>OBP: 0.231, SLG: 0.222<br>Ewell Blackwell, R (10, 1)<br>OBP: 0.194, SLG: 0.094 |                              |                                 | G6-3<br>BB                   |                                  |                              | E5                              |                              |                                 |                              |                                 |                              | 3                                | 0                            | 0                               | 0                            | 1                               | 1                            | 1                                |                                  |                                    |                                  |        |
| <b>Inning Stats</b>  | R: 0<br>E: 0<br>K: 0<br>S: 3 | H: 0<br>LOB: 0<br>BB: 0<br>P: 3 | R: 0<br>E: 0<br>K: 0<br>S: 3 | H: 0<br>LOB: 2<br>BB: 2<br>P: 11 | R: 0<br>E: 0<br>K: 0<br>S: 2 | H: 0<br>LOB: 0<br>BB: 1<br>P: 6 | R: 0<br>E: 0<br>K: 0<br>S: 3 | H: 0<br>LOB: 0<br>BB: 0<br>P: 3 | R: 1<br>E: 1<br>K: 0<br>S: 5 | H: 2<br>LOB: 1<br>BB: 0<br>P: 5 | R: 0<br>E: 0<br>K: 1<br>S: 7 | H: 2<br>LOB: 1<br>BB: 1<br>P: 11 | R: 0<br>E: 0<br>K: 1<br>S: 4 | H: 0<br>LOB: 0<br>BB: 0<br>P: 5 | R: 0<br>E: 0<br>K: 1<br>S: 4 | H: 0<br>LOB: 0<br>BB: 1<br>P: 8 | R: 1<br>E: 1<br>K: 1<br>S: 5 | H: 0<br>LOB: 2<br>BB: 3<br>P: 17 | 1B: 6<br>2B: 2<br>3B: 0<br>HR: 0 | SF: 0<br>SAC: 0<br>DP: 2<br>HBP: 0 | WP: 1<br>PB: 0<br>SB: 2<br>CS: 1 | PA: 46 |
| <b>PITCHER</b>   | IP                           | WLS                             | BF                           | H                                | R                            | ER                              | SO                           | BB                              | IBB                          | HBP                             | BLK                          | WP                               | HR                           | S                               | P                            | ERA                             | WHIP                         |                                  |                                  |                                    |                                  |        |
| Monk Dubiel, R (1, 1)<br>ERA: 3.3  | 9.0                          |                                 | 37                           | 8                                | 4                            | 3                               | 2                            | 4                               | 0                            | 0                               | 0                            | 0                                | 0                            | 37                              | 53                           | 3.00                            | 1.333                        |                                  |                                  |                                    |                                  |        |
| Johnny Vander Meer, L (10, 1)<br>ERA: 4.91   | 1.2                          | L                               | 8                            | 0                                | 1                            | 0                               | 2                            | 3                               | 1                            | 0                               | 0                            | 1                                | 0                            | 8                               | 24                           | 0.00                            | 1.800                        |                                  |                                  |                                    |                                  |        |
| Frank Hiller, R (11, 1)<br>ERA: 5.23   | 0.1                          |                                 | 1                            | 0                                | 0                            | 0                               | 0                            | 0                               | 0                            | 0                               | 0                            | 0                                | 0                            | 1                               | 1                            | 0.00                            | 0.000                        |                                  |                                  |                                    |                                  |        |

Cincinnati Reds @ Chicago Cubs  
Wrigley Field, Chicago, IL  
Fri Jul 07 1950, 3:33 AM CDT  
Att: 9,991 - Unknown

livebaseballscores.com

|     |    |
|-----|----|
| AB  | 38 |
| R   | 5  |
| H   | 8  |
| RBI | 3  |
| BB  | 8  |
| SO  | 4  |
| LOB | 21 |



| Batter  | 1   | 2   | 3   | 4   | 5   | 6  | 7   | 8   | 9  | 10  | 11  | AB R H RBI BB SO LOB  | BOTTOM  |   |   |      |       |  |  |  |  |  |  |  |  |  |  |  |  |
|---|---|---|---|---|---|--|---|---|--|---|---|---|---|---|---|------|-------|--|--|--|--|--|--|--|--|--|--|--|--|
| Wayne Terwilliger, R (1, 4)<br>OBP: 0.309, SLG: 0.387   | 0-0 L6  |   | 0-3 K   |   | 0-3 K2-3  |  | 0-0 F7  |   | 0-0 HR   |   |   | 5 1 1 1 0 2 0   | <b>Cincinnati Reds @ Chicago Cubs</b><br>Wrigley Field, Chicago, IL<br>Fri Jul 07 1950, 3:33 AM CDT<br>Att: 9,991 - Unknown |   |   |      |       |  |  |  |  |  |  |  |  |  |  |  |  |
| Rube Walker, L (1, 2)<br>OBP: 0.284, SLG: 0.353<br>Emil Verban, R (9, PR)<br>OBP: 0.118, SLG: 0.063<br>Mickey Owen, R (10, 2)<br>OBP: 0.240, SLG: 0.250   | 0-0 F9  |   | 0-0 F8  |   | 0-0 1B<br>1B  |  | 0-0 P5  |   | 4-0 BB   |   |   | 4 0 1 0 1 0 0<br>0 0 0 0 0 0 0<br>0 0 0 0 0 0 0                                   |   |   |   |      |       |  |  |  |  |  |  |  |  |  |  |  |  |
| Phil Cavarretta, L (1, 3)<br>OBP: 0.381, SLG: 0.489   | 4-0 1B<br>BB  |   |   | 0-0 HR  | 0-0 1-2<br>1B                                       |  | 0-3 K   |   | 0-0 4-3  |   |   | 4 1 2 0 1 1 1   |   |   |   |      |       |  |  |  |  |  |  |  |  |  |  |  |  |
| Hank Sauer, R (1, 7)<br>OBP: 0.396, SLG: 0.576  | 0-0 1-2<br>1B   |   | 0-0 3-H<br>HR                                       | 0-0 HR  | 0-0 P3  |  | 0-0 F6  |   | 0-0 5-3  |   |   | 5 1 2 2 0 0 2   |   |   |   |      |       |  |  |  |  |  |  |  |  |  |  |  |  |
| Andy Paiko, R (1, 8)<br>OBP: 0.413, SLG: 0.556  | 0-0 2-3   |   | 0-3 K   |   | 0-0 6-3   |  | 0-0 HR  |   | 0-0 F7   |   |   | 5 1 1 1 0 1 2   |   |   |   |      |       |  |  |  |  |  |  |  |  |  |  |  |  |
| Ron Northey, L (1, 9)<br>OBP: 0.348, SLG: 0.496   |   | 0-3 K   |   | 0-0 3-1   | 0-0 E3<br>WP  |  | 0-0 L3  |   | 0-3 K  |   |   | 5 0 0 0 0 2 0   |   |   |   |      |       |  |  |  |  |  |  |  |  |  |  |  |  |
| Roy Smalley, R (1, 6)<br>OBP: 0.337, SLG: 0.504   |   | 0-0 5-3   |   | 0-0 2B  | 0-0 F8  |  | 0-3 K   |   |  |   |   | 5 0 1 0 0 1 1   |   |   |   |      |       |  |  |  |  |  |  |  |  |  |  |  |  |
| Bill Serena, R (1, 5)<br>OBP: 0.365, SLG: 0.430   |   | 0-0 5-3   |   | 0-0 F8  | 0-0 1-2<br>BB                                       |  | 4-0 BB  |   | 0-0 F4   |   |   | 3 0 0 0 2 0 1   |   |   |   |      |       |  |  |  |  |  |  |  |  |  |  |  |  |
| Monk Dubiel, R (1, 1)<br>OBP: 0.100, SLG: 0.053<br>Hank Edwards, L (9, PH)<br>OBP: 0.420, SLG: 0.541<br>Johnny Vander Meer, S (10, 1)<br>Frank Hiller, R (11, 1)<br>Bob Borkowski, R (11, PH)<br>OBP: 0.327, SLG: 0.429 |   |   | 0-3 K   |   | 0-3 K   |  | 0-3 K   |   | 0-3 K  |   |   | 3 0 0 0 0 3 2<br>1 0 0 0 0 1 0<br>0 0 0 0 0 0 0<br>0 0 0 0 0 0 0<br>1 0 0 0 0 0 1 |   |   |   |      |       |  |  |  |  |  |  |  |  |  |  |  |  |
| <b>Inning Stats</b>   | R: 0 H: 1<br>E: 0 LOB: 2<br>K: 0 BB: 1<br>S: 4 P: 8   | R: 0 H: 0<br>E: 0 LOB: 0<br>K: 1 BB: 0<br>S: 5 P: 5 | R: 0 H: 0<br>E: 0 LOB: 0<br>K: 2 BB: 0<br>S: 7 P: 7 | R: 2 H: 3<br>E: 0 LOB: 1<br>K: 1 BB: 0<br>S: 8 P: 8 | R: 0 H: 2<br>E: 0 LOB: 2<br>K: 2 BB: 0<br>S: 9 P: 9 | R: 0 H: 0<br>E: 1 LOB: 2<br>K: 1 BB: 1<br>S: 6 P: 10 | R: 0 H: 0<br>E: 0 LOB: 0<br>K: 1 BB: 0<br>S: 5 P: 5 | R: 1 H: 1<br>E: 0 LOB: 0<br>K: 1 BB: 0<br>S: 6 P: 6 | R: 1 H: 1<br>E: 0 LOB: 1<br>K: 1 BB: 1<br>S: 6 P: 10 | R: 0 H: 0<br>E: 0 LOB: 0<br>K: 1 BB: 0<br>S: 5 P: 5 | R: 0 H: 0<br>E: 0 LOB: 0<br>K: 0 BB: 1<br>S: 2 P: 6 | 1B: 3 SF: 0<br>2B: 1 SAC: 0<br>3B: 1 DP: 1<br>HR: 3 HBP: 0                        |   | WP: 1 PA: 45<br>PB: 0<br>SB: 0<br>CS: 0 |   |      |       |  |  |  |  |  |  |  |  |  |  |  |  |
| <b>PITCHER</b>  | IP WLS BF H R ER SO BB IBB HBP BLK WP HR S P ERA WHIP |   |   |   |   |  |   |   |  |   |   |   |   | <b>PITCHER</b>                          | IP WLS BF H R ER SO BB IBB HBP BLK WP HR S P ERA WHIP |      |       |  |  |  |  |  |  |  |  |  |  |  |  |
| Willie Ramsdell, R (1, 1)<br>ERA: 4.39  | 8.2   |   | 38  | 8   | 4   | 4  | 10  | 3   | 0  | 0   | 0   | 1   | 3   | 55                                      | 67  | 4.15 | 1.269 |  |  |  |  |  |  |  |  |  |  |  |  |
| Ken Raffensberger, L (9, 1)<br>ERA: 4.63  | 0.1   |   | 1   | 0   | 0   | 0  | 0   | 0   | 0  | 0   | 0   | 0   | 0   | 1                                       | 1   | 0.00 | 0.000 |  |  |  |  |  |  |  |  |  |  |  |  |
| Ewell Blackwell, R (10, 1)<br>ERA: 3.65   | 2.0   | W   | 6   | 0   | 0   | 0  | 1   | 1   | 0  | 0   | 0   | 0   | 0   | 7                                       | 11  | 0.00 | 0.500 |  |  |  |  |  |  |  |  |  |  |  |  |

livebaseballscorecards.com

AB 41  
R 4  
H 8  
RBI 4  
BB 4  
SO 11  
LOB 10



| Batter   | 1   | 2                                | 3                            | 4                               | 5                            | 6                               | 7                            | 8                               | 9                            | AB R H RBI BB SO LOB             | TOP  |                                 |                              |                                 |                              |                                 |                                  |                                    |                                  |        |
|--|---|----------------------------------|------------------------------|---------------------------------|------------------------------|---------------------------------|------------------------------|---------------------------------|------------------------------|----------------------------------|--|---------------------------------|------------------------------|---------------------------------|------------------------------|---------------------------------|----------------------------------|------------------------------------|----------------------------------|--------|
| <b>Bobby Adams, R</b> (1, 5)<br>OBP: 0.333, SLG: 0.325<br><b>Grady Hatton, L</b> (6, PH)<br>OBP: 0.328, SLG: 0.398<br>(6, 5) | 4-0<br>2B<br>BB                                       | 0-0                              |                              | 0-0<br>P6                       |                              | 0-3<br>K                        |                              |                                 | 0-3<br>K                     | 2 1 1 0 1 0 0<br>2 0 0 0 0 2 2   |  |                                 |                              |                                 |                              |                                 |                                  |                                    |                                  |        |
| <b>Peanuts Lowrey, R</b> (1, 7)<br>OBP: 0.329, SLG: 0.297  | 0-0<br>F9   | 0-0<br>5-3                       |                              | 0-0<br>3-1                      |                              | 0-0<br>F3                       |                              |                                 | 0-0<br>F8                    | 5 0 0 0 0 0 4                    |  |                                 |                              |                                 |                              |                                 |                                  |                                    |                                  |        |
| <b>Johnny Wyrostek, L</b> (1, 9)<br>OBP: 0.403, SLG: 0.471   | 0-0<br>BB<br>1-3<br>2B                                |                                  | 0-0<br>2B<br>2B              | 0-0<br>P6                       |                              |                                 | 0-0<br>4-3                   |                                 | 0-0<br>1B<br>2B<br>1B        | 5 2 3 0 0 0 0                    |  |                                 |                              |                                 |                              |                                 |                                  |                                    |                                  |        |
| <b>Bob Usher, R</b> (1, 8)<br>OBP: 0.338, SLG: 0.410   | 4-0<br>BB<br>IBB                                      |                                  | 0-0<br>2B<br>2B              |                                 | 0-0<br>P3                    |                                 | 0-0<br>6-3                   |                                 | 0-0<br>2B<br>1B              | 4 1 2 1 1 0 0                    |  |                                 |                              |                                 |                              |                                 |                                  |                                    |                                  |        |
| <b>Connie Ryan, R</b> (1, 4)<br>OBP: 0.385, SLG: 0.411   | 4-0<br>1-2<br>2-3<br>3-H<br>BB                        |                                  | 0-0<br>4-3<br>1B<br>2B       |                                 | 0-0<br>P3                    |                                 | 0-0<br>P6                    |                                 | 0-0<br>2B                    | 4 1 2 3 1 0 0                    |  |                                 |                              |                                 |                              |                                 |                                  |                                    |                                  |        |
| <b>Joe Adcock, R</b> (1, 3)<br>OBP: 0.269, SLG: 0.344  | 0-3<br>K  |                                  | 0-0<br>4-3<br>1B             |                                 | 0-0<br>CS<br>1B              |                                 |                              |                                 | 0-0<br>1B                    | 4 0 2 0 0 1 4                    |  |                                 |                              |                                 |                              |                                 |                                  |                                    |                                  |        |
| <b>Johnny Pramesa, R</b> (1, 2)<br>OBP: 0.330, SLG: 0.415  | 0-0<br>F2   |                                  | 0-0<br>1B                    |                                 | 0-0<br>CS                    | 4-0<br>FC5-6<br>1B<br>BB        |                              |                                 | 0-0<br>F9                    | 3 0 1 1 1 0 3                    | <b>AB 36</b><br><b>R 5</b><br><b>H 12</b><br><b>RBI 5</b><br><b>BB 5</b><br><b>SO 4</b><br><b>LOB 18</b> |                                 |                              |                                 |                              |                                 |                                  |                                    |                                  |        |
| <b>Virgil Stallcup, R</b> (1, 6)<br>OBP: 0.281, SLG: 0.339   |   | 0-0<br>5-3                       | 0-0<br>F8                    |                                 |                              | 0-0<br>FC5-6<br>1B              |                              |                                 | 4-0<br>BB                    | 3 0 1 0 1 0 1                    |  |                                 |                              |                                 |                              |                                 |                                  |                                    |                                  |        |
| <b>Herm Wehmeier, R</b> (1, 1)<br>OBP: 0.231, SLG: 0.275   |   | 0-0<br>4-1                       | 0-3<br>K                     |                                 |                              | 0-0<br>FC5-6                    |                              |                                 | 0-0<br>4-3                   | 4 0 0 0 0 1 4                    |                     |                                 |                              |                                 |                              |                                 |                                  |                                    |                                  |        |
| <b>Inning Stats</b>  | R: 1<br>E: 0<br>K: 1<br>S: 6                          | H: 1<br>LOB: 3<br>BB: 3<br>P: 18 | R: 0<br>E: 0<br>K: 0<br>S: 4 | H: 1<br>LOB: 1<br>BB: 0<br>P: 4 | R: 3<br>E: 0<br>K: 1<br>S: 9 | H: 4<br>LOB: 1<br>BB: 0<br>P: 9 | R: 0<br>E: 0<br>K: 0<br>S: 3 | H: 0<br>LOB: 0<br>BB: 0<br>P: 3 | R: 0<br>E: 0<br>K: 1<br>S: 6 | H: 1<br>LOB: 2<br>BB: 1<br>P: 10 | R: 0<br>E: 0<br>K: 0<br>S: 3   | H: 0<br>LOB: 0<br>BB: 0<br>P: 3 | R: 0<br>E: 0<br>K: 0<br>S: 3 | H: 1<br>LOB: 1<br>BB: 1<br>P: 7 | R: 1<br>E: 0<br>K: 1<br>S: 7 | H: 3<br>LOB: 2<br>BB: 0<br>P: 7 | 1B: 6<br>2B: 6<br>3B: 0<br>HR: 0 | SF: 0<br>SAC: 0<br>DP: 0<br>HBP: 0 | WP: 0<br>PB: 0<br>SB: 0<br>CS: 1 | PA: 42 |
| <b>PITCHER</b>   | IP WLS BF H R ER SO BB IBB HBP BLK WP HR S P ERA WHIP |                                  |                              |                                 |                              |                                 |                              |                                 |                              |                                  |  |                                 |                              |                                 |                              |                                 |                                  |                                    |                                  |        |
| <b>Johnny Schmitz, L</b> (1, 1)<br>ERA: 4.29   | 0.1 L 5 1 1 1 0 2 1 0 0 0 0 0 2 14 27.00 9.000        |                                  |                              |                                 |                              |                                 |                              |                                 |                              |                                  |  |                                 |                              |                                 |                              |                                 |                                  |                                    |                                  |        |
| <b>Bill Voiselle, R</b> (1, 1)<br>ERA: 5.44  | 1.2 9 4 3 3 1 0 0 0 0 0 0 0 11 11 16.20 2.400         |                                  |                              |                                 |                              |                                 |                              |                                 |                              |                                  |  |                                 |                              |                                 |                              |                                 |                                  |                                    |                                  |        |
| <b>Johnny Klippstein, R</b> (3, 1)<br>ERA: 4.28  | 7.0 27 7 1 1 3 2 0 0 0 0 0 0 31 39 1.29 1.286         |                                  |                              |                                 |                              |                                 |                              |                                 |                              |                                  |  |                                 |                              |                                 |                              |                                 |                                  |                                    |                                  |        |

**Cincinnati Reds @ Chicago Cubs**  
 Wrigley Field, Chicago, IL  
 Sat Jul 08 1950, 3:33 AM CDT  
 Att. 14,709 - Unknown

[livebaseballscorecards.com](http://livebaseballscorecards.com)

| Batter  | 1          | 2         | 3        | 4                | 5            | 6            | 7          | 8         | 9         | AB R H RBI BB SO LOB |
|---|------------|-----------|----------|------------------|--------------|--------------|------------|-----------|-----------|----------------------|
| Wayne Terwilliger, R (1, 4)<br>OBP: 0.311, SLG: 0.384 | 0-0 1-3 ①  |           | 4-0 BB   |                  | 0-3 K ①      |              | 0-0 1-2 1B |           | 0-0 F8 ②  | 4 0 1 0 1 1 2        |
| Rube Walker, L (1, 2)<br>OBP: 0.281, SLG: 0.343       | 4-0 2B BB  |           | 0-3 K ①  |                  | 0-0 FC4-6 ②  |              | 0-3 K ②    |           | 0-0 G3 ③  | 4 0 0 0 1 2 5        |
| Phil Cavarretta, L (1, 3)<br>OBP: 0.374, SLG: 0.478   | 0-0 F8 ②   |           | 0-0 F9 ② |                  | 0-0 4-3 ③    |              | 0-0 F4 ③   |           |           | 4 0 0 0 0 0 5        |
| Hank Sauer, R (1, 7)<br>OBP: 0.394, SLG: 0.574        | 0-0 1-3 2B |           | 0-3 K ③  |                  | 0-0 P4 ①     |              | 0-0 5-3 ①  |           |           | 4 0 1 0 0 1 1        |
| Andy Pafko, R (1, 8)<br>OBP: 0.414, SLG: 0.555        | 0-0 5-3 ③  |           |          | 0-0 E5 L9 5-3 1B |              | 0-0 FC4-6 1B |            | 0-0 5-3 ② |           | 4 1 2 0 0 0 2        |
| Ron Northey, L (1, 9)<br>OBP: 0.353, SLG: 0.504       |            | 0-0 2B    |          | 0-0 L9 ①         |              | 0-0 FC4-6 ②  |            | 0-0 1B    |           | 4 0 2 0 0 0 2        |
| Roy Smalley, R (1, 6)<br>OBP: 0.332, SLG: 0.496       |            | 0-0 F8 ①  |          | 0-0 5-3 ②        |              | 0-0 P5 ③     |            | 0-0 P3 ③  |           | 4 0 0 1 0 0 3        |
| Bill Serena, R (1, 5)<br>OBP: 0.359, SLG: 0.421       |            | 0-3 K ②   |          | 0-0 5-3 ③        |              | 0-0 1-6-3 ①  |            | 0-0 F7 ①  |           | 4 0 0 0 0 0 1 1      |
| Johnny Schmitz, R (1, 1)<br>OBP: 0.140, SLG: 0.143    |            | 0-0 6-3 ③ |          |                  | 0-0 FC4-6 1B |              | 0-0 1B     |           | 0-0 WP 1B | 0 0 0 0 0 0 0 0      |
| Bill Voiselle, R (1, 1)<br>OBP: 0.077, SLG: 0.077     |            |           |          |                  |              |              |            |           |           | 1 0 0 0 0 0 0 1      |
| Johnny Klippstein, R (3, 1)<br>OBP: 0.444, SLG: 0.444 |            |           |          |                  |              |              |            |           |           | 2 0 2 0 0 0 0 0      |
| Bob Borkowski, R (9, PH)<br>OBP: 0.333, SLG: 0.435    |            |           |          |                  |              |              |            |           |           | 1 0 1 0 0 0 0 0      |

|  |   |                        |                          |                        |                          |                         |                          |                        |                          |                        |                          |                        |                          |                        |                          |                        |                          |                        |                         |                           |                         |        |
|--|---|------------------------|--------------------------|------------------------|--------------------------|-------------------------|--------------------------|------------------------|--------------------------|------------------------|--------------------------|------------------------|--------------------------|------------------------|--------------------------|------------------------|--------------------------|------------------------|-------------------------|---------------------------|-------------------------|--------|
| <b>Inning Stats</b>                                    | R: 0 H: 1 E: 0 K: 0 S: 4  | H: 1 LOB: 2 BB: 1 P: 8 | R: 0 H: 1 E: 0 K: 1 S: 6 | H: 1 LOB: 1 BB: 0 P: 6 | R: 0 H: 0 E: 0 K: 2 S: 7 | H: 0 LOB: 1 BB: 1 P: 11 | R: 1 H: 1 E: 1 K: 0 S: 4 | H: 1 LOB: 0 BB: 0 P: 4 | R: 0 H: 1 E: 0 K: 1 S: 6 | H: 1 LOB: 1 BB: 0 P: 6 | R: 0 H: 1 E: 0 K: 1 S: 4 | H: 1 LOB: 1 BB: 0 P: 4 | R: 0 H: 2 E: 0 K: 1 S: 7 | H: 2 LOB: 2 BB: 0 P: 7 | R: 0 H: 1 E: 0 K: 0 S: 4 | H: 1 LOB: 1 BB: 0 P: 4 | R: 0 H: 1 E: 0 K: 0 S: 4 | H: 1 LOB: 1 BB: 0 P: 4 | 1B: 7 2B: 2 3B: 0 HR: 0 | SF: 0 SAC: 0 DP: 0 HBP: 0 | WP: 1 PB: 0 SB: 0 CS: 0 | PA: 38 |
| <b>PITCHER</b><br>Herm Wehmeier, R (1, 1)<br>ERA: 5.95 | IP 9.0 WLS W BF 38 H 9 R 1 ER 0 SO 5 BB 2 IBB 0 HBP 0 BLK 0 WP 1 HR 0 S 46 P 54 ERA 0.00 WHIP 1.222 |                        |                          |                        |                          |                         |                          |                        |                          |                        |                          |                        |                          |                        |                          |                        |                          |                        |                         |                           |                         |        |

**BOTTOM**

**Cincinnati Reds @ Chicago Cubs**  
 Wrigley Field, Chicago, IL  
 Sat Jul 08 1950, 3:33 AM CDT  
 Att. 14,709 - Unknown

livebaseballscorecards.com

|            |           |
|------------|-----------|
| <b>AB</b>  | <b>36</b> |
| <b>R</b>   | <b>1</b>  |
| <b>H</b>   | <b>9</b>  |
| <b>RBI</b> | <b>1</b>  |
| <b>BB</b>  | <b>2</b>  |
| <b>SO</b>  | <b>5</b>  |
| <b>LOB</b> | <b>22</b> |



| Batter  | 1   | 2   | 3   | 4   | 5   | 6   | 7   | 8   | 9   | AB R H RBI BB SO LOB                                       | TOP                                     |
|---|---|---|---|---|---|---|---|---|---|--|---|
| Lloyd Merriman, L (1, 8)<br>OBP: 0.331, SLG: 0.362    | 0-0<br>4-3<br>2B                                      |   | 0-0<br>FC<br>1B<br>2B                               | 0-0<br>F8   |   | 0-0<br>E4   |   | 0-0<br>F9   |   | 5 1 2 0 0 0 1  |   |
| Peanuts Lowrey, R (1, 7)<br>OBP: 0.322, SLG: 0.290    | 0-0<br>P3   |   | 0-0<br>F8   | 0-0<br>P2   |   | 0-3<br>K  |   | 0-0<br>L3   |   | 5 0 0 0 0 1 4  |   |
| Johnny Wyrostek, L (1, 9)<br>OBP: 0.396, SLG: 0.462   | 0-0<br>4-3  |   | 0-0<br>FC<br>1B<br>1B                               |   | 0-0<br>F7   | 0-0<br>F9   |   | 0-0<br>3-1  |   | 5 1 0 0 0 0 4  |   |
| Grady Hatton, L (1, 5)<br>OBP: 0.337, SLG: 0.404      | 4-0<br>BB   |   | 0-0<br>1B<br>F7<br>1B                               |   | 0-0<br>F5   |   | 0-0<br>HBP<br>2B<br>1B                              |   | 0-0<br>SH1-3<br>1B                                  | 4 2 3 1 1 0 0  |   |
| Connie Ryan, R (1, 4)<br>OBP: 0.387, SLG: 0.410       | 0-0<br>6-3  |   | 0-0<br>1B<br>1B                                     |   | 0-0<br>1-3  |   | 1-0<br>2B<br>HBP                                    |   | 0-0<br>SH1-3  | 3 0 1 1 0 0 2  |   |
| Joe Adcock, R (1, 3)<br>OBP: 0.264, SLG: 0.348        |   | 0-0<br>F8   | 0-0<br>F7   |   |   | 0-0<br>HR<br>2B                                     |   | 0-0<br>F8   |   | 5 1 1 1 0 0 4  |   |
| Johnny Pramesa, R (1, 2)<br>OBP: 0.333, SLG: 0.448    |   | 0-0<br>1-3  | 0-0<br>1B   |   |   | 0-0<br>HR   |   | 0-3<br>K  |   | 5 1 2 2 0 1 3  |   |
| Virgil Stallcup, R (1, 6)<br>OBP: 0.289, SLG: 0.355   |   | 0-0<br>2B   | 0-0<br>F7   |   |   | 0-0<br>FC1-6<br>1B                                  |   | 0-0<br>2B   |   | 4 0 3 1 0 0 2  |   |
| Ken Raffensberger, R (1, 1)<br>OBP: 0.209, SLG: 0.200 |   | 0-3<br>K  |   | 0-3<br>K  |   | 0-0<br>FC1-6<br>E                                   |   | 0-0<br>F4   |   | 4 0 0 0 0 2 4  |   |
| <b>Inning Stats</b>                                   | R: 0 H: 1<br>E: 0 LOB: 2<br>K: 0 BB: 1<br>S: 4 P: 8   | R: 0 H: 1<br>E: 0 LOB: 1<br>K: 1 BB: 0<br>S: 6 P: 6 | R: 3 H: 4<br>E: 0 LOB: 2<br>K: 0 BB: 0<br>S: 8 P: 8 | R: 0 H: 0<br>E: 0 LOB: 0<br>K: 1 BB: 0<br>S: 5 P: 5 | R: 0 H: 0<br>E: 0 LOB: 0<br>K: 0 BB: 0<br>S: 3 P: 3 | R: 2 H: 3<br>E: 1 LOB: 2<br>K: 1 BB: 0<br>S: 9 P: 9 | R: 1 H: 2<br>E: 0 LOB: 2<br>K: 1 BB: 0<br>S: 7 P: 8 | R: 0 H: 0<br>E: 0 LOB: 0<br>K: 0 BB: 0<br>S: 3 P: 3 | R: 0 H: 1<br>E: 0 LOB: 1<br>K: 0 BB: 0<br>S: 4 P: 4 | 1B: 6 SF: 0<br>2B: 5 SAC: 1<br>3B: 0 DP: 0<br>HR: 1 HBP: 1 | WP: 0 PA: 43<br>PB: 0<br>SB: 0<br>CS: 0 |
| <b>PITCHER</b>  | IP WLS BF H R ER SO BB IBB HBP BLK WP HR S P ERA WHIP |   |   |   |   |   |   |   |   |  |   |
| Doyle Lade, R (1, 1)<br>ERA: 3.99                     | 3.0 L 17 6 3 3 1 1 0 0 0 0 0 0 18 22 9.00 2.333       |   |   |   |   |   |   |   |   |  |   |
| Dutch Leonard, R (4, 1)<br>ERA: 4.66                  | 3.0 13 3 2 2 2 0 0 0 0 0 0 1 17 17 6.00 1.000         |   |   |   |   |   |   |   |   |  |   |
| Frank Hiller, R (7, 1)<br>ERA: 5.08                   | 3.0 13 3 1 1 1 0 0 0 1 0 0 0 14 15 3.00 1.000         |   |   |   |   |   |   |   |   |  |   |

Cincinnati Reds @ Chicago Cubs  
Wrigley Field, Chicago, IL  
Sun Jul 09 1950, 3:33 AM CDT  
Unknown

livebaseballscorecards.com

AB 40  
R 6  
H 12  
RBI 6  
BB 1  
SO 4  
LOB 24





| Batter   | 1   | 2   | 3   | 4   | 5   | 6   | 7   | 8   | 9   | AB  | R  | H                                       | RBI | BB | SO | LOB | BOTTOM   |
|--|---|---|---|---|---|---|---|---|---|---|--|---|-----|----|----|-----|--|
| Wayne Terwilliger, R (1, 4)<br>OBP: 0.306, SLG: 0.377      | F9 ①  |   | F9 ②  |   |   | F5 ①  |   |   | F5 ①  | 4   | 0  | 0                                       | 0   | 0  | 0  | 2   | <b>Cincinnati Reds @ Chicago Cubs</b><br>Wrigley Field, Chicago, IL<br>Sun Jul 09 1950, 3:33 AM CDT<br>Unknown |
| Mickey Owen, R (1, 2)<br>OBP: 0.240, SLG: 0.250            | F7 ②  |   | F9 ③  |   |   | F8 ②  |   |   | 1B  | 4   | 0  | 1                                       | 0   | 0  | 0  | 2   |  |
| Phil Cavarretta, L (1, 3)<br>OBP: 0.367, SLG: 0.468        | K ③   |   |   |   | F8 ①  | 1-3 ③   |   |   | F4 ②  | 4   | 0  | 0                                       | 0   | 0  | 1  | 2   |  |
| Hank Sauer, R (1, 7)<br>OBP: 0.392, SLG: 0.569             |   | F9 ①  |   | F9 ②  |   |   | G6-4-3 ① ②  |   | F6 ③  | 4   | 0  | 1                                       | 0   | 0  | 0  | 1   |  |
| Andy Pafko, R (1, 8)<br>OBP: 0.410, SLG: 0.548             |   | F3 ②  |   | F7 ③  |   | G6-4-3 ① ②  |   |   | 1-2f ① ②  | 3   | 0  | 0                                       | 0   | 0  | 0  | 1   |  |
| Bob Borkowski, R (1, 9)<br>OBP: 0.343, SLG: 0.442          |   | 1B  |   |   | F5 ①  |   | F5 ③  |   |   | 3   | 0  | 2                                       | 0   | 0  | 0  | 0   |  |
| Roy Smalley, R (1, 6)<br>OBP: 0.329, SLG: 0.490            |   | P3 ③  |   |   | F7 ②  |   |   | F7 ①  |   | 3   | 0  | 0                                       | 0   | 0  | 0  | 1   |  |
| Bill Serena, R (1, 5)<br>OBP: 0.354, SLG: 0.415            |   |   | F8 ①  |   | F8 ③  |   |   | F9 ②  |   | 3   | 0  | 0                                       | 0   | 0  | 0  | 0   |  |
| Doyle Lade, R (1, 1)<br>OBP: 0.278, SLG: 0.278             |   |   |   |   |   |   |   |   | F8 ③  | 0   | 0  | 0                                       | 0   | 0  | 0  | 0   |  |
| Emil Verban, R (3, PH)<br>OBP: 0.167, SLG: 0.118           |   |   |   |   |   |   |   |   |   | 1   | 0  | 1                                       | 0   | 0  | 0  | 0   |  |
| Dutch Leonard, R (4, 1)<br>OBP: 0.200, SLG: 0.200          |   |   |   |   |   |   |   |   |   | 0   | 0  | 0                                       | 0   | 0  | 0  | 0   |  |
| Johnny Klippstein, R (6, PH)<br>OBP: 0.500, SLG: 0.600     |   |   |   |   |   |   |   |   |   | 1   | 0  | 1                                       | 0   | 0  | 0  | 0   |  |
| Frank Hiller, R (7, 1)                                     |   |   | 1B  |   |   | 2B  |   |   |   | 1   | 0  | 0                                       | 0   | 0  | 0  | 0   |  |
| <b>Inning Stats</b>  | R: 0 H: 0<br>E: 0 LOB: 0<br>K: 1 BB: 0<br>S: 5 P: 5   | R: 0 H: 1<br>E: 0 LOB: 1<br>K: 0 BB: 0<br>S: 4 P: 4 | R: 0 H: 1<br>E: 0 LOB: 1<br>K: 0 BB: 0<br>S: 4 P: 4 | R: 0 H: 0<br>E: 0 LOB: 0<br>K: 0 BB: 0<br>S: 3 P: 3 | R: 0 H: 1<br>E: 0 LOB: 0<br>K: 0 BB: 0<br>S: 3 P: 3 | R: 0 H: 1<br>E: 0 LOB: 1<br>K: 0 BB: 0<br>S: 4 P: 4 | R: 0 H: 1<br>E: 0 LOB: 0<br>K: 0 BB: 0<br>S: 3 P: 3 | R: 0 H: 0<br>E: 0 LOB: 0<br>K: 0 BB: 0<br>S: 3 P: 3 | R: 0 H: 1<br>E: 0 LOB: 1<br>K: 0 BB: 0<br>S: 4 P: 4 | R: 0 H: 1<br>E: 0 LOB: 0<br>K: 0 BB: 0<br>S: 4 P: 4 | 1B: 5 SF: 0<br>2B: 1 SAC: 0<br>3B: 0 DP: 1<br>HR: 0 HBP: 0 | WP: 0 PA: 31<br>PB: 0<br>SB: 0<br>CS: 0 |     |    |    |     |  |
| <b>PITCHER</b><br>Ken Raffensberger, L (1, 1)<br>ERA: 4.27 | IP 9.0 WLS W BF 31 H 6 R 0 ER 0 SO 1 BB 0 IBB 0 HBP 0 BLK 0 WP 0 HR 0 S 33 P 33 ERA 0.00 WHIP 0.667 |   |   |   |   |   |   |   |   |   |  |   |     |    |    |     |  |

|     |    |
|-----|----|
| AB  | 31 |
| R   | 0  |
| H   | 6  |
| RBI | 0  |
| BB  | 0  |
| SO  | 1  |
| LOB | 9  |



Batter 1 2 3 4 5 6 7 8 9 AB R H RBI BB SO LOB TOP

|  |            |                          |                                 |                               |                                   |                                  |                  |                             |             |                                |
|--|------------|--------------------------|---------------------------------|-------------------------------|-----------------------------------|----------------------------------|------------------|-----------------------------|-------------|--------------------------------|
| Lloyd Merriman, L<br>OBP: 0.328, SLG: 0.375<br>(1, 8) X  | 0-0<br>6-3 |                          | X 0-0<br>F7<br>2-H 3B           | X 0-0<br>FC6<br>1-2f          |                                   | X 0-0<br>SH4<br>1-2              |                  | X 0-0<br>F8                 |             | 4 1 1 1 0 0 1                  |
| Peanuts Lowrey, R<br>OBP: 0.324, SLG: 0.294<br>(1, 7) X  | 0-0<br>5-3 |                          | X 0-0<br>F7<br>3-H              |                               | X 0-0<br>E<br>2B                  | X 0-0<br>F8                      |                  | B B B B<br>4-0<br>BB<br>2-6 |             | 4 1 1 1 1 0 1                  |
| Johnny Wyrostek, L<br>OBP: 0.396, SLG: 0.461<br>(1, 9) X   | 0-0<br>4-3 |                          | X 0-0<br>WP<br>1B<br>1B         |                               | X 0-0<br>E2<br>F7<br>2-H 1B       | X 0-0<br>F6                      |                  | 0-0<br>2-6<br>1-2           | 0-0<br>1-3  | 5 1 2 1 0 0 1                  |
| Grady Hatton, L<br>OBP: 0.342, SLG: 0.406<br>(1, 5)  |            | X 0-0<br>S<br>1B         | X 0-0<br>WP<br>1B<br>1-2        |                               | B B B B<br>4-0<br>BB<br>1B<br>BB  |                                  | X 0-0<br>F8      |                             | X 0-0<br>F8 | 4 1 2 0 1 0 0                  |
| Connie Ryan, R<br>OBP: 0.383, SLG: 0.402<br>(1, 4)   |            | S S S<br>0-3<br>K<br>1-2 | B B B B<br>4-0<br>BB<br>1-2 2-3 |                               | X 0-0<br>F7                       |                                  | X 0-0<br>6-3     |                             | X 0-0<br>F7 | 4 0 0 1 1 1 2                  |
| Joe Adcock, R<br>OBP: 0.276, SLG: 0.347<br>(1, 3)  |            | X 0-0<br>6-3             | X 0-0<br>F7<br>BB               |                               | B B B B<br>4-0<br>1B<br>1-2<br>BB |                                  | X 0-0<br>S<br>1B |                             |             | 3 1 1 0 1 0 4                  |
| Johnny Pramesa, R<br>OBP: 0.340, SLG: 0.451<br>(1, 2)  |            | X 0-0<br>4-3             |                                 | X 0-0<br>5-3                  |                                   | X 0-0<br>G5-4-3<br>1B<br>1-2 2-H |                  | X 0-0<br>1B                 |             | 4 0 2 2 0 0 1                  |
| Virgil Stallcup, R<br>OBP: 0.292, SLG: 0.361<br>(1, 6)   |            |                          | X 0-0<br>3B<br>2B               | X 0-0<br>FC5-6<br>1B          |                                   | B B B B<br>4-0<br>G5-4-3<br>1-2f |                  | S S S<br>0-3<br>K           |             | 4 1 2 0 0 1 3                  |
| Howie Fox, R<br>OBP: 0.241, SLG: 0.379<br>Ewell Blackwell, R<br>OBP: 0.189, SLG: 0.091<br>(1, 1)<br>(7, 1) |            | S S S<br>0-3<br>K        | S S S<br>0-3<br>K               | X 0-0<br>FC5-6<br>FC6<br>1-2f |                                   | X 0-0<br>SH4<br>1B               |                  | X 0-0<br>4-3                |             | 3 0 1 0 0 1 2<br>1 0 0 0 0 0 0 |

|                     |   |   |  |   |  |   |   |   |   |  |   |
|---------------------|---|---|--|---|--|---|---|---|---|--|---|
| <b>Inning Stats</b> | R: 0 H: 0<br>E: 0 LOB: 0<br>K: 0 BB: 0<br>S: 3 P: 3 | R: 0 H: 1<br>E: 0 LOB: 1<br>K: 1 BB: 0<br>S: 6 P: 6 | R: 2 H: 4<br>E: 0 LOB: 3<br>K: 1 BB: 1<br>S: 9 P: 13 | R: 0 H: 1<br>E: 0 LOB: 1<br>K: 0 BB: 0<br>S: 4 P: 4 | R: 3 H: 3<br>E: 1 LOB: 1<br>K: 0 BB: 2<br>S: 5 P: 13 | R: 0 H: 1<br>E: 0 LOB: 1<br>K: 0 BB: 0<br>S: 4 P: 4 | R: 1 H: 2<br>E: 0 LOB: 1<br>K: 1 BB: 0<br>S: 7 P: 7 | R: 0 H: 0<br>E: 0 LOB: 1<br>K: 0 BB: 1<br>S: 2 P: 6 | R: 0 H: 0<br>E: 0 LOB: 0<br>K: 0 BB: 0<br>S: 3 P: 3 | 1B: 9 SF: 0<br>2B: 2 SAC: 1<br>3B: 1 DP: 1<br>HR: 0 HBP: 0 | WP: 1 PA: 41<br>PB: 0<br>SB: 2<br>CS: 0 |
|---------------------|---|---|--|---|--|---|---|---|---|--|---|

|  |   |                |   |
|--|---|----------------|---|
| <b>PITCHER</b>                               | IP WLS BF H R ER SO BB IBB HBP BLK WP HR S P ERA WHIP | <b>PITCHER</b> | IP WLS BF H R ER SO BB IBB HBP BLK WP HR S P ERA WHIP |
| Bob Rush, R<br>ERA: 3.55<br>(1, 1)           | 4.1 L 24 8 5 5 2 3 0 0 0 1 0 25 37 10.38 2.538        |                |   |
| Johnny Schmitz, L<br>ERA: 4.22<br>(5, 1)     | 1.2 6 2 0 0 0 0 0 0 0 0 0 6 6 0.00 1.200              |                |   |
| Monk Dubiel, R<br>ERA: 3.34<br>(7, 1)        | 2.0 9 2 1 1 1 1 0 0 0 0 0 9 13 4.50 1.500             |                |   |
| Johnny Vander Meer, L<br>ERA: 4.79<br>(9, 1) | 1.0 3 0 0 0 0 0 0 0 0 0 0 3 3 0.00 0.000              |                |   |

Cincinnati Reds @ Chicago Cubs  
Wrigley Field, Chicago, IL  
Sun Jul 09 1950, 3:38 AM CDT  
Att: 27,580 - Unknown

livebaseballscorecards.com

|            |    |
|------------|----|
| <b>AB</b>  | 36 |
| <b>R</b>   | 6  |
| <b>H</b>   | 12 |
| <b>RBI</b> | 6  |
| <b>BB</b>  | 4  |
| <b>SO</b>  | 3  |
| <b>LOB</b> | 15 |





| Batter   | 1  | 2   | 3   | 4   | 5   | 6  | 7   | 8   | 9   | AB R H RBI BB SO LOB   | TOP  |
|--|--|---|---|---|---|--|---|---|---|--|--|
| Roy Hartsfield, R (1, 4)<br>OBP: 0.350, SLG: 0.377     | 0-3<br>K   |   | 0-0<br>6-3  |   |   | 0-3<br>K   |   | 0-0<br>1-3  |   | 4 0 0 0 0 2 1  |  |
| Pete Reiser, L (1, 8)<br>OBP: 0.387, SLG: 0.306        | 4-0<br>BB  |   |   | 0-0<br>F7   |   | 4-0<br>HR BB   |   | 0-3<br>K  |   | 2 1 0 0 2 1 1  |  |
| Earl Torgeson, L (1, 3)<br>OBP: 0.404, SLG: 0.455      | 0-0<br>F8  |   |   | 0-0<br>G4-6-3<br>1B   |   | 0-0<br>HR  |   |   | 4-0<br>G6-4-3<br>BB   | 3 1 2 2 1 0 1  |  |
| Bob Elliott, R (1, 5)<br>OBP: 0.345, SLG: 0.496        | 0-3<br>K   |   |   | 0-0<br>G4-6-3<br>1-2f   |   | 0-3<br>K   |   |   | 0-0<br>F7   | 4 0 0 0 0 2 3  |  |
| Sid Gordon, R (1, 7)<br>OBP: 0.411, SLG: 0.624         |  | 0-3<br>K  |   |   | 0-0<br>F9   |  | 0-0<br>L4   |   | 0-0<br>G6-4-3<br>1-2f   | 4 0 0 0 0 1 1  |  |
| Tommy Holmes, L (1, 9)<br>OBP: 0.389, SLG: 0.500       |  | 0-0<br>F9   |   |   | 0-0<br>HR   |  | 0-0<br>F8   |   |   | 3 1 1 1 0 0 0  |  |
| Del Crandall, R (1, 2)<br>OBP: 0.264, SLG: 0.314       |  | 0-0<br>6-3  |   |   | 0-0<br>F8   |  | 0-0<br>F6   |   |   | 3 0 0 0 0 0 0  |  |
| Buddy Kerr, R (1, 6)<br>OBP: 0.273, SLG: 0.293         |  |   | 0-0<br>F3   |   | 0-0<br>6-3  |  |   | 0-0<br>E<br>1B  |   | 3 0 1 0 0 0 0  |  |
| Johnny Sain, R (1, 1)<br>OBP: 0.255, SLG: 0.250        |  |   | 0-0<br>F8   |   |   | 0-0<br>5-3   |   | 0-0<br>6-3<br>1-3   |   | 3 0 0 0 0 0 1  |  |
| <b>Inning Stats</b>                                    | R: 0<br>E: 0<br>K: 2<br>S: 7<br>H: 0<br>LOB: 1<br>BB: 1<br>P: 11   | R: 0<br>E: 0<br>K: 1<br>S: 5<br>H: 0<br>LOB: 0<br>BB: 0<br>P: 5 | R: 0<br>E: 0<br>K: 0<br>S: 3<br>H: 0<br>LOB: 0<br>BB: 0<br>P: 3 | R: 0<br>E: 0<br>K: 0<br>S: 3<br>H: 1<br>LOB: 0<br>BB: 0<br>P: 3 | R: 1<br>E: 0<br>K: 0<br>S: 4<br>H: 1<br>LOB: 0<br>BB: 0<br>P: 4 | R: 2<br>E: 0<br>K: 2<br>S: 8<br>H: 1<br>LOB: 0<br>BB: 1<br>P: 12 | R: 0<br>E: 0<br>K: 0<br>S: 3<br>H: 0<br>LOB: 0<br>BB: 0<br>P: 3 | R: 0<br>E: 1<br>K: 1<br>S: 6<br>H: 1<br>LOB: 1<br>BB: 0<br>P: 6 | R: 0<br>E: 0<br>K: 0<br>S: 2<br>H: 0<br>LOB: 0<br>BB: 1<br>P: 6 | 1B: 2<br>2B: 0<br>3B: 0<br>HR: 2<br>SF: 0<br>SAC: 0<br>DP: 2<br>HBP: 0 | WP: 0<br>PB: 0<br>SB: 0<br>CS: 0<br>PA: 32 |
| <b>PITCHER</b><br>Herm Wehmeier, R (1, 1)<br>ERA: 5.74 | IP: 9.0<br>WLS: W<br>BF: 32<br>H: 4<br>R: 3<br>ER: 3<br>SO: 6<br>BB: 3<br>IBB: 0<br>HBP: 0<br>BLK: 0<br>WP: 0<br>HR: 2<br>S: 41<br>P: 53<br>ERA: 3.00<br>WHIP: 0.778 |   |   |   |   |  |   |   |   |  |  |

**Boston Braves @ Cincinnati Reds**  
Crosley Field, Cincinnati, OH  
Thu Jul 13 1950, 3:33 AM EDT  
Att. 14,198 - Unknown - 76 F

[livebaseballscorecards.com](http://livebaseballscorecards.com)

|            |    |
|------------|----|
| <b>AB</b>  | 29 |
| <b>R</b>   | 3  |
| <b>H</b>   | 4  |
| <b>RBI</b> | 3  |
| <b>BB</b>  | 3  |
| <b>SO</b>  | 6  |
| <b>LOB</b> | 8  |



| Batter   | 1  | 2                                   | 3                                | 4                               | 5                            | 6                               | 7                            | 8                                  | 9                            | AB                              | R                            | H                               | RBI                              | BB                                 | SO                               | LOB    |
|--|--|-------------------------------------|----------------------------------|---------------------------------|------------------------------|---------------------------------|------------------------------|------------------------------------|------------------------------|---------------------------------|------------------------------|---------------------------------|----------------------------------|------------------------------------|----------------------------------|--------|
| Lloyd Merriman, L (1, 8)<br>OBP: 0.319, SLG: 0.363   | F6   |                                     | F7                               |                                 | F6                           |                                 |                              | F7                                 |                              | 4                               | 0                            | 0                               | 0                                | 0                                  | 0                                | 0      |
| Grady Hatton, L (1, 5)<br>OBP: 0.344, SLG: 0.420     | G3   |                                     | 4-3                              |                                 |                              | HR                              |                              | E<br>1B<br>1B                      |                              | 4                               | 2                            | 2                               | 1                                | 0                                  | 0                                | 0      |
| Johnny Wyrostek, L (1, 9)<br>OBP: 0.397, SLG: 0.460  | 2B<br>BB   |                                     | F3                               |                                 |                              | CS<br>1B                        |                              | E6<br>1B<br>1-2<br>1B              |                              | 3                               | 2                            | 1                               | 0                                | 1                                  | 0                                | 1      |
| Ted Kluszewski, L (1, 3)<br>OBP: 0.349, SLG: 0.578   | 2B<br>1-H  |                                     |                                  | HR                              |                              | F7                              |                              | 1B<br>1B<br>1-3<br>2-H             |                              | 4                               | 2                            | 3                               | 3                                | 0                                  | 0                                | 1      |
| Connie Ryan, R (1, 4)<br>OBP: 0.381, SLG: 0.399      | F7   |                                     |                                  | F7                              |                              | F8<br>1-2                       |                              | 1B<br>1B<br>1-2<br>3-H<br>F9<br>1B |                              | 4                               | 1                            | 1                               | 1                                | 0                                  | 0                                | 2      |
| Joe Adcock, R (1, 7)<br>OBP: 0.275, SLG: 0.342       |  | E5<br>1B                            |                                  | 6-3                             |                              |                                 | K                            | 1B<br>CS<br>1-3<br>2-H<br>1B       |                              | 4                               | 0                            | 1                               | 1                                | 0                                  | 1                                | 0      |
| Johnny Pramesa, R (1, 2)<br>OBP: 0.340, SLG: 0.447   |  | F3                                  |                                  | F4                              |                              |                                 | E<br>1B                      | F9                                 |                              | 3                               | 0                            | 1                               | 0                                | 0                                  | 0                                | 1      |
| Bobby Adams, R (7, PR)<br>OBP: 0.333, SLG: 0.325     |  |                                     |                                  |                                 |                              |                                 |                              |                                    |                              | 0                               | 0                            | 0                               | 0                                | 0                                  | 0                                | 0      |
| Dixie Howell, R (8, 2)<br>OBP: 0.333, SLG: 0.294     |  |                                     |                                  |                                 |                              |                                 |                              |                                    |                              | 1                               | 0                            | 0                               | 1                                | 0                                  | 0                                | 1      |
| Virgil Stallcup, R (1, 6)<br>OBP: 0.292, SLG: 0.361  |  | G6-4-3<br>1B<br>1-3                 |                                  |                                 | 4-3                          |                                 | L5                           | CS                                 |                              | 3                               | 0                            | 1                               | 0                                | 0                                  | 0                                | 1      |
| Herm Wehmeier, R (1, 1)<br>OBP: 0.218, SLG: 0.259    |  | G6-4-3<br>1-2f                      |                                  |                                 | 6-3                          |                                 | F2                           |                                    |                              | 3                               | 0                            | 0                               | 0                                | 0                                  | 0                                | 4      |
| <b>Inning Stats</b>                                  | R: 1<br>E: 0<br>K: 0<br>S: 4                                   | H: 1<br>LOB: 1<br>BB: 1<br>P: 8     | R: 0<br>E: 1<br>K: 0<br>S: 4     | H: 1<br>LOB: 1<br>BB: 0<br>P: 4 | R: 0<br>E: 0<br>K: 0<br>S: 3 | H: 0<br>LOB: 0<br>BB: 0<br>P: 3 | R: 1<br>E: 0<br>K: 0<br>S: 4 | H: 2<br>LOB: 0<br>BB: 0<br>P: 4    | R: 0<br>E: 1<br>K: 1<br>S: 6 | H: 1<br>LOB: 2<br>BB: 0<br>P: 6 | R: 4<br>E: 1<br>K: 0<br>S: 7 | H: 4<br>LOB: 0<br>BB: 0<br>P: 7 | 1B: 7<br>2B: 1<br>3B: 0<br>HR: 2 | SF: 0<br>SAC: 0<br>DP: 1<br>HBP: 0 | WP: 0<br>PB: 0<br>SB: 0<br>CS: 2 | PA: 35 |
| <b>PITCHER</b><br>Johnny Sain, R (1, 1)<br>ERA: 4.58 | IP: 8.0<br>WLS: L<br>BF: 34<br>H: 10<br>R: 7<br>ER: 5<br>SO: 1 | BB: 1<br>IBB: 0<br>HBP: 0<br>BLK: 0 | WP: 0<br>HR: 2<br>S: 35<br>P: 39 | ERA: 5.62<br>WHIP: 1.375        |                              |                                 |                              |                                    |                              |                                 |                              |                                 |                                  |                                    |                                  |        |

**BOTTOM**

**Boston Braves @ Cincinnati Reds**  
Crosley Field, Cincinnati, OH  
Thu Jul 13 1950, 3:33 AM EDT  
Att: 14,198 - Unknown - 76 F

[livebaseballscorecards.com](http://livebaseballscorecards.com)

|            |           |
|------------|-----------|
| <b>AB</b>  | <b>33</b> |
| <b>R</b>   | <b>7</b>  |
| <b>H</b>   | <b>10</b> |
| <b>RBI</b> | <b>7</b>  |
| <b>BB</b>  | <b>1</b>  |
| <b>SO</b>  | <b>1</b>  |
| <b>LOB</b> | <b>11</b> |



| Batter   | 1   | 2   | 3  | 4   | 5   | 6  | 7   | 8   | 9  | AB R H RBI BB SO LOB                                       | TOP                                     |  |
|--|---|---|--|---|---|--|---|---|--|--|---|--|
| Roy Hartsfield, R (1, 4)<br>OBP: 0.345, SLG: 0.370   | 0-0<br>F6   |   | 0-3<br>K   |   | 0-0<br>4-3  |  | 0-0<br>5-3  |   | 0-0<br>BB<br>1B                                      | 5 0 1 0 0 1 1  |   |  |
| Pete Reiser, L (1, 8)<br>Willard Marshall, L (3, PR)<br>OBP: 0.391, SLG: 0.314<br>OBP: 0.317, SLG: 0.341 | 0-0<br>5-3  |   | 0-0<br>1B<br>2-H<br>1B                               |   | 0-0<br>4-3  |  | 0-0<br>L7   |   | 4-0<br>BB<br>1-2<br>BB                               | 2 0 1 1 0 0 0<br>2 0 0 0 1 0 0                             |   |  |
| Earl Torgeson, L (1, 3)<br>OBP: 0.404, SLG: 0.458  | 0-0<br>2B   |   | 0-0<br>1B  |   |   |  |   |   | 0-0<br>F4  | 5 0 2 0 0 2 2  |   |  |
| Bob Elliott, R (1, 5)<br>OBP: 0.344, SLG: 0.496  | 0-0<br>F5   |   | 0-0<br>L9  |   |   |  |   |   | 0-0<br>L5  | 4 1 1 0 0 0 3  |   |  |
| Sid Gordon, R (1, 7)<br>OBP: 0.404, SLG: 0.611   |   |   |  |   |   |  |   |   | 0-0<br>F4  | 4 0 0 0 0 0 1  |   |  |
| Tommy Holmes, L (1, 9)<br>OBP: 0.397, SLG: 0.497   |   |   |  |   |   |  |   |   | 0-0<br>1-3   | 4 0 0 0 0 0 1  |   |  |
| Del Crandall, R (1, 2)<br>OBP: 0.271, SLG: 0.352   |   |   |  |   |   |  |   |   | 4-0<br>2B<br>IBB                                     | 1 2 0 0 1 1 0  |   |  |
| Buddy Kerr, R (1, 6)<br>OBP: 0.273, SLG: 0.290   |   |   |  |   |   |  |   |   | 0-0<br>WP<br>2B                                      | 4 2 2 4 0 2 1  |   |  |
| Warren Spahn, L (1, 1)<br>Bobby Hogue, R (8, 1)<br>OBP: 0.279, SLG: 0.254<br>OBP: 0.222, SLG: 0.333      |   |   |  |   |   |  |   |   | 0-0<br>1B<br>1-6-3<br>BB                             | 3 1 0 0 1 0 1  |   |  |
|  |   |   |  |   |   |  |   |   | 0-0<br>6-3   | 3 0 0 0 0 1 1<br>1 0 0 0 0 0 0                             |   |  |
|  |   |   |  |   |   |  |   |   | 0-0<br>G3  |  |   |  |
|  |   |   |  |   |   |  |   |   | 0-0<br>1-3   |  |   |  |
| Inning Stats   | R: 0 H: 1<br>E: 0 LOB: 1<br>K: 0 BB: 0<br>S: 4 P: 4   | R: 0 H: 0<br>E: 0 LOB: 0<br>K: 2 BB: 0<br>S: 7 P: 7 | R: 1 H: 2<br>E: 0 LOB: 2<br>K: 1 BB: 1<br>S: 7 P: 11 | R: 0 H: 0<br>E: 0 LOB: 1<br>K: 1 BB: 0<br>S: 5 P: 6 | R: 0 H: 0<br>E: 0 LOB: 0<br>K: 1 BB: 0<br>S: 5 P: 5 | R: 3 H: 2<br>E: 0 LOB: 0<br>K: 1 BB: 1<br>S: 7 P: 11 | R: 0 H: 0<br>E: 0 LOB: 0<br>K: 0 BB: 0<br>S: 3 P: 3 | R: 0 H: 0<br>E: 0 LOB: 0<br>K: 1 BB: 0<br>S: 5 P: 5 | R: 2 H: 2<br>E: 0 LOB: 2<br>K: 0 BB: 1<br>S: 5 P: 10 | 1B: 3 SF: 0<br>2B: 3 SAC: 0<br>3B: 0 DP: 0<br>HR: 1 HBP: 2 | WP: 1 PA: 39<br>PB: 0<br>SB: 0<br>CS: 0 |  |
| PITCHER<br>Ewell Blackwell, R (1, 1)<br>ERA: 3.74<br>Frank Smith, R (8, 1)<br>ERA: 3.42                  | IP WLS BF H R ER SO BB IBB HBP BLK WP HR S P ERA WHIP |   |  |   |   |  |   |   |  |  |   | PITCHER<br>IP WLS BF H R ER SO BB IBB HBP BLK WP HR S P ERA WHIP |

**Boston Braves @ Cincinnati Reds**  
Crosley Field, Cincinnati, OH  
Fri Jul 14 1950, 3:33 AM EDT  
Att: 3,032 - Sunny - 84 F

|   |    |
|---|----|
| AB  | 34 |
| R   | 6  |
| H   | 7  |
| RBI   | 5  |
| BB  | 3  |
| SO  | 7  |
| LOB   | 10 |
|  |    |

livebaseballscorecards.com

| Batter | 1 | 2 | 3 | 4 | 5 | 6 | 7 | 8 | 9 | AB | R | H | RBI | BB | SO | LOB | BOTTOM |
|--------|---|---|---|---|---|---|---|---|---|----|---|---|-----|----|----|-----|--------|
|--------|---|---|---|---|---|---|---|---|---|----|---|---|-----|----|----|-----|--------|

|   |  |  |  |  |  |  |  |  |  |   |   |   |   |   |   |   |  |
|---|--|--|--|--|--|--|--|--|--|---|---|---|---|---|---|---|--|
| <b>Bobby Adams, R</b><br><small>(1, 5)</small><br><small>OBP: 0.340, SLG: 0.335</small>   |  |  |  |  |  |  |  |  |  | 4 | 1 | 2 | 0 | 1 | 1 | 0 |  |
| <b>Connie Ryan, R</b><br><small>(1, 4)</small><br><small>OBP: 0.381, SLG: 0.399</small>   |  |  |  |  |  |  |  |  |  | 5 | 2 | 2 | 0 | 0 | 2 | 2 |  |
| <b>Johnny Wyrostek, L</b><br><small>(1, 9)</small><br><small>OBP: 0.397, SLG: 0.460</small>   |  |  |  |  |  |  |  |  |  | 4 | 1 | 1 | 1 | 1 | 0 | 2 |  |
| <b>Ted Kluszewski, L</b><br><small>(1, 3)</small><br><small>OBP: 0.358, SLG: 0.587</small>  |  |  |  |  |  |  |  |  |  | 5 | 0 | 4 | 2 | 0 | 0 | 1 |  |
| <b>Bob Usher, R</b><br><small>(1, 8)</small><br><small>OBP: 0.342, SLG: 0.412</small><br><b>Lloyd Merriman, L</b><br><small>(9, PH)</small><br><small>OBP: 0.316, SLG: 0.360</small>  |  |  |  |  |  |  |  |  |  | 4 | 0 | 2 | 1 | 0 | 0 | 3 |  |
|   |  |  |  |  |  |  |  |  |  | 1 | 0 | 0 | 0 | 0 | 0 | 1 |  |
| <b>Joe Adcock, R</b><br><small>(1, 7)</small><br><small>OBP: 0.274, SLG: 0.338</small>  |  |  |  |  |  |  |  |  |  | 4 | 0 | 1 | 0 | 0 | 0 | 3 |  |
| <b>Johnny Pramesa, R</b><br><small>(1, 2)</small><br><small>OBP: 0.330, SLG: 0.433</small><br><b>Grady Hatton, L</b><br><small>(8, PH)</small><br><small>OBP: 0.343, SLG: 0.418</small><br><b>Dixie Howell, R</b><br><small>(9, 2)</small><br><small>OBP: 0.333, SLG: 0.294</small>   |  |  |  |  |  |  |  |  |  | 3 | 0 | 0 | 0 | 0 | 1 | 3 |  |
|   |  |  |  |  |  |  |  |  |  | 1 | 0 | 0 | 0 | 0 | 0 | 2 |  |
|   |  |  |  |  |  |  |  |  |  | 0 | 0 | 0 | 0 | 0 | 0 | 0 |  |
| <b>Virgil Stallcup, R</b><br><small>(1, 6)</small><br><small>OBP: 0.292, SLG: 0.359</small>   |  |  |  |  |  |  |  |  |  | 4 | 0 | 1 | 0 | 0 | 1 | 2 |  |
| <b>Ewell Blackwell, R</b><br><small>(1, 1)</small><br><small>OBP: 0.179, SLG: 0.086</small><br><b>Peanuts Lowrey, R</b><br><small>(7, PH)</small><br><small>OBP: 0.322, SLG: 0.292</small><br><b>Frank Smith, R</b><br><small>(8, 1)</small><br><small>OBP: 0.077, SLG: 0.077</small><br><b>Harry Perkowski, L</b><br><small>(9, PH)</small><br><small>OBP: 0.412, SLG: 0.375</small> |  |  |  |  |  |  |  |  |  | 2 | 0 | 0 | 0 | 0 | 0 | 1 |  |
|   |  |  |  |  |  |  |  |  |  | 1 | 0 | 0 | 0 | 0 | 0 | 0 |  |
|   |  |  |  |  |  |  |  |  |  | 0 | 0 | 0 | 0 | 0 | 0 | 0 |  |
|   |  |  |  |  |  |  |  |  |  | 1 | 0 | 0 | 0 | 0 | 0 | 0 |  |

|                     |   |   |   |   |   |   |   |   |   |   |   |   |   |   |   |   |   |   |   |   |   |   |   |
|---------------------|---|---|---|---|---|---|---|---|---|---|---|---|---|---|---|---|---|---|---|---|---|---|---|
| <b>Inning Stats</b> | R: 0 H: 1 E: 0 K: 0 S: 3                              | H: 1 LOB: 2 BB: 2 P: 11                               | R: 0 H: 1 E: 0 K: 0 S: 4                              | H: 1 LOB: 1 BB: 0 P: 4                                | R: 0 H: 0 E: 0 K: 2 S: 7                              | H: 0 LOB: 0 BB: 0 P: 7                                | R: 0 H: 1 E: 1 K: 0 S: 4                              | H: 1 LOB: 1 BB: 0 P: 4                                | R: 0 H: 1 E: 0 K: 2 S: 8                              | H: 1 LOB: 1 BB: 0 P: 8                                | R: 0 H: 2 E: 0 K: 1 S: 7                              | H: 2 LOB: 2 BB: 0 P: 7                                | R: 0 H: 0 E: 0 K: 0 S: 3                              | H: 0 LOB: 0 BB: 0 P: 3                                | R: 2 H: 4 E: 0 K: 0 S: 7                              | H: 4 LOB: 2 BB: 0 P: 7                                | R: 2 H: 3 E: 0 K: 0 S: 6                              | H: 3 LOB: 1 BB: 0 P: 6                                | 1B: 10 2B: 3 3B: 0 HR: 0                              | SF: 0 SAC: 0 DP: 1 HBP: 0                             | WP: 0 PB: 0 SB: 0 CS: 2                               | PA: 41  |   |
| <b>PITCHER</b>      | IP WLS BF H R ER SO BB IBB HBP BLK WP HR S P ERA WHIP | IP WLS BF H R ER SO BB IBB HBP BLK WP HR S P ERA WHIP | IP WLS BF H R ER SO BB IBB HBP BLK WP HR S P ERA WHIP | IP WLS BF H R ER SO BB IBB HBP BLK WP HR S P ERA WHIP | IP WLS BF H R ER SO BB IBB HBP BLK WP HR S P ERA WHIP | IP WLS BF H R ER SO BB IBB HBP BLK WP HR S P ERA WHIP | IP WLS BF H R ER SO BB IBB HBP BLK WP HR S P ERA WHIP | IP WLS BF H R ER SO BB IBB HBP BLK WP HR S P ERA WHIP | IP WLS BF H R ER SO BB IBB HBP BLK WP HR S P ERA WHIP | IP WLS BF H R ER SO BB IBB HBP BLK WP HR S P ERA WHIP | IP WLS BF H R ER SO BB IBB HBP BLK WP HR S P ERA WHIP | IP WLS BF H R ER SO BB IBB HBP BLK WP HR S P ERA WHIP | IP WLS BF H R ER SO BB IBB HBP BLK WP HR S P ERA WHIP | IP WLS BF H R ER SO BB IBB HBP BLK WP HR S P ERA WHIP | IP WLS BF H R ER SO BB IBB HBP BLK WP HR S P ERA WHIP | IP WLS BF H R ER SO BB IBB HBP BLK WP HR S P ERA WHIP | IP WLS BF H R ER SO BB IBB HBP BLK WP HR S P ERA WHIP | IP WLS BF H R ER SO BB IBB HBP BLK WP HR S P ERA WHIP | IP WLS BF H R ER SO BB IBB HBP BLK WP HR S P ERA WHIP | IP WLS BF H R ER SO BB IBB HBP BLK WP HR S P ERA WHIP | IP WLS BF H R ER SO BB IBB HBP BLK WP HR S P ERA WHIP | IP WLS BF H R ER SO BB IBB HBP BLK WP HR S P ERA WHIP | IP WLS BF H R ER SO BB IBB HBP BLK WP HR S P ERA WHIP |

**Boston Braves @ Cincinnati Reds**  
Crosley Field, Cincinnati, OH

Fri Jul 14 1950, 3:33 AM EDT  
Att. 3,032 - Sunny - 84 F

**AB 39**  
**R 4**  
**H 13**  
**RBI 4**  
**BB 2**  
**SO 5**  
**LOB 20**

[livebaseballscorecards.com](http://livebaseballscorecards.com)

| Batter   | 1   | 2                               | 3                            | 4                               | 5                            | 6  | 7                            | 8                               | 9                            | AB R H RBI BB SO LOB             | TOP   |                                 |                              |                                 |                              |                                 |                                  |                                    |                                  |        |
|--|---|---------------------------------|------------------------------|---------------------------------|------------------------------|--|------------------------------|---------------------------------|------------------------------|----------------------------------|---|---------------------------------|------------------------------|---------------------------------|------------------------------|---------------------------------|----------------------------------|------------------------------------|----------------------------------|--------|
| Roy Hartsfield, R (1, 4)<br>OBP: 0.340, SLG: 0.364   | 0-0<br>F9   |                                 | 0-0<br>1-3                   |                                 |                              | 0-0<br>FC3-6<br>BB 1B<br>1-2f 2B         |                              | 0-0<br>FC4-6<br>1B              | 0-0<br>FC5-4<br>1-2f         | 5 1 1 0 0 0 3                    | <p><b>Boston Braves @ Cincinnati Reds</b><br/>Crosley Field, Cincinnati, OH</p> <p>Sat Jul 15 1950, 3:33 AM EDT<br/>Att: 4,218 - Sunny - 86 F</p> |                                 |                              |                                 |                              |                                 |                                  |                                    |                                  |        |
| Willard Marshall, L (1, 8)<br>OBP: 0.321, SLG: 0.344 | 0-0<br>2B<br>F7-3-5<br>1B                             |                                 |                              | 0-0<br>4-3                      |                              | 0-0<br>1-2<br>2B<br>1B                   |                              | 0-0<br>F6                       |                              | 4 2 2 0 0 0 1                    |   |                                 |                              |                                 |                              |                                 |                                  |                                    |                                  |        |
| Earl Torgeson, L (1, 3)<br>OBP: 0.405, SLG: 0.460    | 0-0<br>F7-3-5<br>1-3<br>2B                            |                                 |                              | 0-0<br>4-3                      |                              | B B B B<br>4-0<br>1-2<br>2-3<br>2B<br>BB |                              | 0-0<br>FC4-6<br>1-2f<br>PB      |                              | 3 0 1 0 1 0 1                    |   |                                 |                              |                                 |                              |                                 |                                  |                                    |                                  |        |
| Bob Elliott, R (1, 5)<br>OBP: 0.342, SLG: 0.496      | 0-0<br>F7-3-5<br>2-3<br>3-H                           |                                 |                              | 0-0<br>F2                       |                              | 0-0<br>1-3<br>2-H<br>3-H<br>2B           |                              | 0-0<br>1-3<br>1-2               |                              | 4 0 1 3 0 0 2                    |   |                                 |                              |                                 |                              |                                 |                                  |                                    |                                  |        |
| Sid Gordon, R (1, 7)<br>OBP: 0.401, SLG: 0.604       |   | 0-0<br>1-3                      |                              |                                 | 0-0<br>6-3                   | 0-0<br>F2                                |                              |                                 | 0-0<br>1B<br>WP<br>1B        | 4 1 1 0 0 0 2                    |   |                                 |                              |                                 |                              |                                 |                                  |                                    |                                  |        |
| Tommy Holmes, L (1, 9)<br>OBP: 0.399, SLG: 0.494     |   | B B B B<br>4-0<br>G6-4-3<br>BB  |                              |                                 | 0-0<br>F7                    |  | 0-0<br>F6                    |                                 | 0-0<br>1B<br>WP<br>1-3<br>1B | 3 0 1 0 1 0 0                    |   |                                 |                              |                                 |                              |                                 |                                  |                                    |                                  |        |
| Del Crandall, R (1, 2)<br>OBP: 0.263, SLG: 0.341     |   | 0-0<br>G6-4-3<br>1-2f           |                              |                                 | 0-0<br>F7                    |  | 0-0<br>6-3                   |                                 | 0-0<br>F6<br>1-2<br>3-H      | 4 0 0 0 0 0 2                    |   |                                 |                              |                                 |                              |                                 |                                  |                                    |                                  |        |
| Buddy Kerr, R (1, 6)<br>OBP: 0.276, SLG: 0.293       |   |                                 | 0-0<br>F7                    |                                 |                              | 0-0<br>F9                                |                              |                                 | 0-0<br>FC5-4<br>1B           | 4 0 2 0 0 0 0                    |   |                                 |                              |                                 |                              |                                 |                                  |                                    |                                  |        |
| Sibby Sisti, R (9, PR)<br>OBP: 0.369, SLG: 0.358     |   |                                 |                              |                                 |                              |  |                              |                                 | 0-0<br>2-3<br>1B             | 0 0 0 0 0 0 0                    |   |                                 |                              |                                 |                              |                                 |                                  |                                    |                                  |        |
| Bob Chipman, L (1, 1)<br>OBP: 0.263, SLG: 0.176      |   |                                 | 0-0<br>F7                    |                                 |                              | 0-0<br>FC3-6<br>1B                       |                              |                                 | 0-3<br>K                     | 1 0 0 0 0 0 0                    |   |                                 |                              |                                 |                              |                                 |                                  |                                    |                                  |        |
| Normie Roy, R (3, 1)<br>OBP: 0.267, SLG: 0.214       |   |                                 |                              |                                 |                              |  |                              |                                 |                              | 0 0 0 0 0 0 0                    |   |                                 |                              |                                 |                              |                                 |                                  |                                    |                                  |        |
| Walker Cooper, R (6, PH)<br>OBP: 0.339, SLG: 0.478   |   |                                 |                              |                                 |                              |  |                              |                                 |                              | 1 0 1 0 0 0 0                    |   |                                 |                              |                                 |                              |                                 |                                  |                                    |                                  |        |
| Johnny Antonelli, L (6, 1)                           |   |                                 |                              |                                 |                              |  |                              |                                 |                              | 0 0 0 0 0 0 0                    |   |                                 |                              |                                 |                              |                                 |                                  |                                    |                                  |        |
| Pete Reiser, L (7, PH)<br>OBP: 0.385, SLG: 0.308     |   |                                 |                              |                                 |                              |  |                              |                                 |                              | 1 0 0 0 0 0 1                    |   |                                 |                              |                                 |                              |                                 |                                  |                                    |                                  |        |
| Ernie Johnson, R (7, 1)<br>OBP: 0.509, SLG: 0.500    |   |                                 |                              |                                 |                              |  |                              |                                 |                              | 0 0 0 0 0 0 0                    |   |                                 |                              |                                 |                              |                                 |                                  |                                    |                                  |        |
| Luis Olmo, R (9, PH)<br>OBP: 0.306, SLG: 0.339       |   |                                 |                              |                                 |                              |  |                              |                                 |                              | 1 0 0 0 0 1 2                    |   |                                 |                              |                                 |                              |                                 |                                  |                                    |                                  |        |
| <b>Inning Stats</b>                                  | R: 1<br>E: 0<br>K: 0<br>S: 4                          | H: 2<br>LOB: 0<br>BB: 0<br>P: 4 | R: 0<br>E: 0<br>K: 0<br>S: 2 | H: 0<br>LOB: 0<br>BB: 1<br>P: 6 | R: 0<br>E: 0<br>K: 0<br>S: 3 | H: 0<br>LOB: 0<br>BB: 0<br>P: 3          | R: 0<br>E: 0<br>K: 0<br>S: 3 | H: 0<br>LOB: 0<br>BB: 0<br>P: 3 | R: 2<br>E: 0<br>K: 0<br>S: 6 | H: 3<br>LOB: 2<br>BB: 1<br>P: 10 | R: 0<br>E: 0<br>K: 0<br>S: 4  | H: 1<br>LOB: 1<br>BB: 0<br>P: 4 | R: 0<br>E: 0<br>K: 0<br>S: 4 | H: 1<br>LOB: 1<br>BB: 0<br>P: 4 | R: 1<br>E: 0<br>K: 1<br>S: 8 | H: 3<br>LOB: 2<br>BB: 0<br>P: 8 | 1B: 8<br>2B: 3<br>3B: 0<br>HR: 0 | SF: 0<br>SAC: 0<br>DP: 2<br>HBP: 0 | WP: 1<br>PB: 1<br>SB: 0<br>CS: 0 | PA: 37 |
| <b>PITCHER</b>                                       | IP WLS BF H R ER SO BB IBB HBP BLK WP HR S P ERA WHIP |                                 |                              |                                 |                              |  |                              |                                 |                              |                                  |   |                                 |                              |                                 |                              |                                 |                                  |                                    |                                  |        |
| Willie Ramsdell, R (1, 1)<br>ERA: 4.4                | 8.0 W 33 9 4 4 0 2 0 0 0 0 0 0 31 39 4.50 1.375       |                                 |                              |                                 |                              |  |                              |                                 |                              |                                  |   |                                 |                              |                                 |                              |                                 |                                  |                                    |                                  |        |
| Herm Wehmeier, R (9, 1)<br>ERA: 5.7                  | 1.0 S 4 1 0 0 1 0 0 0 0 0 1 0 6 6 0.00 1.000          |                                 |                              |                                 |                              |  |                              |                                 |                              |                                  |   |                                 |                              |                                 |                              |                                 |                                  |                                    |                                  |        |

livebaseballscores.com

|     |    |
|-----|----|
| AB  | 35 |
| R   | 4  |
| H   | 10 |
| RBI | 3  |
| BB  | 2  |
| SO  | 1  |
| LOB | 14 |





| Batter   | 1                         | 2         | 3                     | 4               | 5                     | 6               | 7                  | 8               | 9 |
|--|---------------------------|-----------|-----------------------|-----------------|-----------------------|-----------------|--------------------|-----------------|---|
| <b>Bobby Adams, R</b><br>OBP: 0.337, SLG: 0.331<br><b>Grady Hatton, L</b><br>OBP: 0.339, SLG: 0.413      | 0-0<br>F7                 | 0-0<br>F9 | 0-0<br>L1-3           |                 |                       | 0-3<br>K        | 0-3<br>K           |                 |   |
| <b>Connie Ryan, R</b><br>OBP: 0.385, SLG: 0.401  | 0-0<br>E FC1<br>1B        | 0-3<br>K  |                       | 0-0<br>CS<br>1B |                       | 4-0<br>1B<br>BB |                    | 0-0<br>2-3      |   |
| <b>Johnny Wyrostek, L</b><br>OBP: 0.401, SLG: 0.466  | 0-0<br>FC1<br>FC6-4<br>1B |           | 0-0<br>5-3            | 0-0<br>2B       |                       | 0-0<br>1B       |                    | 0-0<br>1B<br>F8 |   |
| <b>Ted Kluszewski, L</b><br>OBP: 0.363, SLG: 0.587   | 0-0<br>FC6-4<br>1B        |           | 0-0<br>1B<br>BB<br>1B | 0-0<br>5-3      |                       | 0-3<br>K        |                    | 0-0<br>1B<br>F8 |   |
| <b>Bob Usher, R</b><br>OBP: 0.337, SLG: 0.401  | 0-0<br>FC6-4<br>1B        |           | 4-0<br>1B<br>2B<br>BB | 0-0<br>5-3      |                       | 0-0<br>5-3      |                    | 0-0<br>F8       |   |
| <b>Joe Adcock, R</b><br>OBP: 0.292, SLG: 0.353   | 0-0<br>1B<br>1B           |           | 0-0<br>2B<br>1B       |                 | 0-0<br>F8             |                 | 0-0<br>SH1-3<br>1B | 0-0<br>4-3      |   |
| <b>Johnny Pramesa, R</b><br>OBP: 0.349, SLG: 0.450   | 0-0<br>FC6-4<br>1B        |           | 0-0<br>2B<br>1B       |                 | 0-0<br>FC3-6<br>1B    |                 | 0-0<br>SH1-3       |                 |   |
| <b>Virgil Stallcup, R</b><br>OBP: 0.295, SLG: 0.365  | 0-0<br>FC6-4              |           | 0-0<br>1B<br>2B       |                 | 0-0<br>FC3-6<br>FC6-4 |                 | 0-0<br>1B          |                 |   |
| <b>Willie Ramsdell, R</b><br>OBP: 0.258, SLG: 0.179<br><b>Herm Wehmeier, R</b><br>OBP: 0.218, SLG: 0.259 |                           | 0-0<br>F8 | 0-0<br>L1-3<br>1B     |                 | 0-0<br>FC6-4          |                 | 4-0<br>BB          |                 |   |

|    |   |   |     |    |    |     |
|----|---|---|-----|----|----|-----|
| AB | R | H | RBI | BB | SO | LOB |
| 2  | 0 | 0 | 0   | 0  | 0  | 0   |
| 3  | 0 | 0 | 0   | 0  | 2  | 3   |

|   |   |   |   |   |   |   |
|---|---|---|---|---|---|---|
| 4 | 1 | 2 | 0 | 1 | 1 | 0 |
|---|---|---|---|---|---|---|

|   |   |   |   |   |   |   |
|---|---|---|---|---|---|---|
| 5 | 2 | 3 | 0 | 0 | 0 | 1 |
|---|---|---|---|---|---|---|

|   |   |   |   |   |   |   |
|---|---|---|---|---|---|---|
| 5 | 1 | 3 | 1 | 0 | 1 | 3 |
|---|---|---|---|---|---|---|

|   |   |   |   |   |   |   |
|---|---|---|---|---|---|---|
| 4 | 2 | 0 | 1 | 1 | 0 | 6 |
|---|---|---|---|---|---|---|

|   |   |   |   |   |   |   |
|---|---|---|---|---|---|---|
| 5 | 2 | 3 | 1 | 0 | 0 | 1 |
|---|---|---|---|---|---|---|

|   |   |   |   |   |   |   |
|---|---|---|---|---|---|---|
| 3 | 1 | 3 | 2 | 0 | 0 | 0 |
|---|---|---|---|---|---|---|

|   |   |   |   |   |   |   |
|---|---|---|---|---|---|---|
| 4 | 0 | 2 | 3 | 0 | 0 | 3 |
|---|---|---|---|---|---|---|

|   |   |   |   |   |   |   |
|---|---|---|---|---|---|---|
| 3 | 0 | 1 | 1 | 1 | 0 | 1 |
| 0 | 0 | 0 | 0 | 0 | 0 | 0 |

### BOTTOM

**Boston Braves @ Cincinnati Reds**  
Crosley Field, Cincinnati, OH  
Sat Jul 15 1950, 3:33 AM EDT  
Att. 4,218 - Sunny - 86 F

|     |    |
|-----|----|
| AB  | 38 |
| R   | 9  |
| H   | 17 |
| RBI | 9  |
| BB  | 3  |
| SO  | 4  |
| LOB | 18 |



### Inning Stats

|      |        |      |        |      |        |      |        |
|------|--------|------|--------|------|--------|------|--------|
| R: 3 | H: 4   | R: 0 | H: 0   | R: 4 | H: 5   | R: 0 | H: 1   |
| E: 1 | LOB: 2 | E: 0 | LOB: 0 | E: 0 | LOB: 1 | E: 0 | LOB: 1 |
| K: 0 | BB: 0  | K: 1 | BB: 0  | K: 0 | BB: 1  | K: 2 | BB: 1  |
| S: 8 | P: 8   | S: 5 | P: 5   | S: 7 | P: 11  | S: 4 | P: 4   |

|      |        |      |        |      |        |
|------|--------|------|--------|------|--------|
| R: 1 | H: 2   | R: 1 | H: 2   | R: 0 | H: 1   |
| E: 0 | LOB: 1 | E: 0 | LOB: 1 | E: 0 | LOB: 2 |
| K: 1 | BB: 1  | K: 0 | BB: 0  | K: 1 | BB: 1  |
| S: 6 | P: 10  | S: 5 | P: 5   | S: 8 | P: 12  |

|        |        |       |        |
|--------|--------|-------|--------|
| 1B: 15 | SF: 0  | WP: 0 | PA: 42 |
| 2B: 3  | SAC: 1 | PB: 0 |        |
| 3B: 0  | DP: 1  | SB: 0 |        |
| HR: 0  | HBP: 0 | CS: 1 |        |

| PITCHER                                 | IP     | WLS | BF | H | R | ER | SO | BB | IBB | HBP | BLK | WP | HR | S  | P  | ERA   | WHIP  |
|---|--------|-----|----|---|---|----|----|----|-----|-----|-----|----|----|----|----|-------|-------|
| <b>Bob Chipman, L</b><br>ERA: 4.12      | (1, 1) | 2.1 | 16 | 7 | 7 | 4  | 1  | 1  | 0   | 0   | 0   | 0  | 0  | 17 | 21 | 15.43 | 3.429 |
| <b>Normie Roy, R</b><br>ERA: 5.62       | (3, 1) | 2.2 | 11 | 5 | 0 | 0  | 0  | 0  | 0   | 0   | 0   | 0  | 0  | 11 | 11 | 0.00  | 1.875 |
| <b>Johnny Antonelli, L</b><br>ERA: 9.56 | (6, 1) | 1.0 | 5  | 1 | 0 | 0  | 2  | 1  | 0   | 0   | 0   | 0  | 0  | 8  | 12 | 0.00  | 2.000 |
| <b>Ernie Johnson, R</b><br>ERA: 8.44    | (7, 1) | 2.0 | 10 | 4 | 2 | 2  | 1  | 1  | 0   | 0   | 0   | 0  | 0  | 11 | 15 | 9.00  | 2.500 |

| Batter  | 1                            |                                 | 2                            |                                 | 3                            |                                 | 4                            |                                 | 5                            |                                 | 6                            |                                 | 7                            |                                 | 8                            |                                 | 9                            |                                 | AB R H RBI BB SO LOB  | TOP                                     |          |
|---|------------------------------|---------------------------------|------------------------------|---------------------------------|------------------------------|---------------------------------|------------------------------|---------------------------------|------------------------------|---------------------------------|------------------------------|---------------------------------|------------------------------|---------------------------------|------------------------------|---------------------------------|------------------------------|---------------------------------|---|---|----------|
| <b>Eddie Stanky, R</b> (1, 4)<br><small>OBP: 0.466, SLG: 0.433</small><br><b>Bill Rigney, R</b> (6, 4)<br><small>OBP: 0.241, SLG: 0.208</small>   | 0-0<br>F4                    | 1-3<br>1B                       | 0-0<br>1-3<br>1B             |                                 |                              |                                 |                              | 0-0<br>F4                       |                              |                                 |                              | 0-0<br>F8                       |                              |                                 |                              |                                 |                              | 3 0 1 0 0 0 0                   | <p><b>New York Giants @ Cincinnati Reds</b><br/>           Crosley Field, Cincinnati, OH</p> <p>Sun Jul 16 1950, 3:33 AM EDT<br/>           Unknown</p> |   |          |
| <b>Don Mueller, L</b> (1, 9)<br><small>OBP: 0.315, SLG: 0.386</small>   | 0-0<br>FC5-4<br>1B           | 0-0<br>F6                       |                              |                                 |                              |                                 | 0-0<br>1-3                   |                                 |                              |                                 | 0-0<br>F1                    |                                 |                              |                                 |                              |                                 | 4 0 1 0 0 0 2                |                                 |   |   |          |
| <b>Monte Irvin, R</b> (1, 7)<br><small>OBP: 0.323, SLG: 0.385</small>   | 0-0<br>F9                    |                                 |                              | 0-0<br>F8                       |                              |                                 |                              | 0-3<br>K                        |                              |                                 |                              | 0-0<br>F7                       |                              |                                 |                              | 4 0 0 0 0 1 1                   |                              |                                 |   |   |          |
| <b>Bobby Thomson, R</b> (1, 8)<br><small>OBP: 0.322, SLG: 0.427</small>   | 0-0<br>FC5-4<br>1-2f         |                                 |                              | 0-0<br>F9                       |                              |                                 |                              | 0-0<br>F2                       |                              |                                 |                              | 0-0<br>F8                       |                              |                                 |                              | 4 0 0 0 0 0 1                   |                              |                                 |   |   |          |
| <b>Wes Westrum, R</b> (1, 2)<br><small>OBP: 0.394, SLG: 0.518</small><br><b>Sam Calderone, R</b> (6, 2)<br><small>OBP: 0.387, SLG: 0.419</small>  |                              |                                 | 0-0<br>E<br>2B               | 0-0<br>HR                       |                              |                                 | 0-0<br>F7                    |                                 |                              |                                 | 0-0<br>5-3                   |                                 |                              |                                 | 3 2 2 1 0 0 0                |                                 |                              |                                 |   |   |          |
| <b>Hank Thompson, L</b> (1, 5)<br><small>OBP: 0.405, SLG: 0.500</small><br><b>Jack Lohrke, R</b> (6, 5)<br><small>OBP: 0.182, SLG: 0.100</small>  |                              |                                 | 0-0<br>FC<br>G3<br>E<br>2-H  | 0-0<br>F4                       |                              |                                 | 0-0<br>1B                    |                                 |                              |                                 | 0-0<br>5-3                   |                                 |                              |                                 | 3 1 1 0 0 0 0                |                                 |                              |                                 |   |   |          |
| <b>Alvin Dark, R</b> (1, 6)<br><small>OBP: 0.329, SLG: 0.465</small><br><b>Rudy Rufer, R</b> (6, 6)   |                              |                                 | 0-3<br>K                     | 0-0<br>6-3                      |                              |                                 |                              | 0-0<br>5-3                      |                              |                                 |                              | 0-0<br>F7                       |                              |                                 |                              | 3 0 0 0 0 1 2                   |                              |                                 |   |   |          |
| <b>Tookie Gilbert, L</b> (1, 3)<br><small>OBP: 0.323, SLG: 0.332</small>  |                              |                                 | 0-0<br>G3<br>2-3             | 0-0<br>G3                       |                              |                                 |                              | 0-0<br>F5                       |                              |                                 |                              | 0-0<br>G3                       |                              |                                 |                              | 4 0 0 0 0 0 1                   |                              |                                 |   |   |          |
| <b>Jack Kramer, R</b> (1, 1)<br><small>OBP: 0.286, SLG: 0.417</small><br><b>Sheldon Jones, R</b> (4, 1)<br><small>OBP: 0.233, SLG: 0.148</small><br><b>Clint Hartung, R</b> (5, 1)<br><small>OBP: 0.320, SLG: 0.720</small> |                              |                                 | 0-0<br>E1<br>1B<br>3-H       | 0-3<br>K                        |                              |                                 |                              | 0-0<br>HR                       |                              |                                 |                              |                                 |                              |                                 |                              | 2 0 0 0 0 1 0                   |                              |                                 |   |   |          |
| <b>Inning Stats</b>   | R: 0<br>E: 0<br>K: 0<br>S: 4 | H: 1<br>LOB: 1<br>BB: 0<br>P: 4 | R: 2<br>E: 2<br>K: 1<br>S: 9 | H: 2<br>LOB: 2<br>BB: 0<br>P: 9 | R: 1<br>E: 0<br>K: 0<br>S: 4 | H: 1<br>LOB: 0<br>BB: 0<br>P: 4 | R: 0<br>E: 0<br>K: 1<br>S: 5 | H: 0<br>LOB: 0<br>BB: 0<br>P: 5 | R: 0<br>E: 0<br>K: 1<br>S: 5 | H: 0<br>LOB: 0<br>BB: 0<br>P: 5 | R: 0<br>E: 0<br>K: 0<br>S: 4 | H: 1<br>LOB: 1<br>BB: 0<br>P: 4 | R: 1<br>E: 0<br>K: 0<br>S: 4 | H: 1<br>LOB: 0<br>BB: 0<br>P: 4 | R: 0<br>E: 0<br>K: 0<br>S: 3 | H: 0<br>LOB: 0<br>BB: 0<br>P: 3 | R: 0<br>E: 0<br>K: 0<br>S: 3 | H: 0<br>LOB: 0<br>BB: 0<br>P: 3 | 1B: 3 SF: 0<br>2B: 1 SAC: 0<br>3B: 0 DP: 0<br>HR: 2 HBP: 0  | WP: 0 PA: 35<br>PB: 0<br>SB: 0<br>CS: 0 |          |
| <b>PITCHER</b><br><b>Ken Raffensberger, L</b> (1, 1)<br><small>ERA: 4.1</small>   | IP 9.0                       | WLS W                           | BF 35                        | H 6                             | R 4                          | ER 2                            | SO 3                         | BB 0                            | IBB 0                        | HBP 0                           | BLK 0                        | WP 0                            | HR 2                         | S 41                            | P 41                         | ERA 2.00                        | WHIP 0.667                   |                                 |   |   | ERA WHIP |

livebaseballscorecards.com

|            |           |
|------------|-----------|
| <b>AB</b>  | <b>35</b> |
| <b>R</b>   | <b>4</b>  |
| <b>H</b>   | <b>6</b>  |
| <b>RBI</b> | <b>2</b>  |
| <b>BB</b>  | <b>0</b>  |
| <b>SO</b>  | <b>3</b>  |
| <b>LOB</b> | <b>7</b>  |



| Batter  | 1             | 2                          | 3                      | 4                                      | 5                           | 6               | 7                                    | 8             | 9 |
|---|---------------|----------------------------|------------------------|--|-----------------------------|-----------------|--------------------------------------|---------------|---|
| Lloyd Merriman, L<br>OBP: 0.317, SLG: 0.377 (1, 8) X  | 0-0 F9<br>① X | 0-0 F7<br>③                |                        | 0-0<br>HR<br>3-H                       | 0-0 F7<br>②                 |                 | 4-0<br>2B<br>1-2<br>1B<br>BB         | 0-0 4-3<br>③  |   |
| Grady Hatton, L<br>OBP: 0.348, SLG: 0.435 (1, 5) X  | 0-0<br>1B     |                            | 0-0 F8<br>①            | 4-0<br>HR<br>BB                        | 0-0<br>HR<br>1-H            |                 | 0-0<br>1B<br>1-3<br>2-H<br>2B        |               |   |
| Johnny Wyrostek, L<br>OBP: 0.401, SLG: 0.465<br>Danny Litwhiler, R<br>OBP: 0.356, SLG: 0.400 (1, 9) X<br>(4, 9) | 0-0 F8<br>②   |                            | 4-0<br>1B<br>4-3<br>BB | 4-0<br>HR<br>1-2<br>BB                 | 0-3<br>K<br>③               |                 | 0-0<br>1B<br>2-3<br>3-H<br>1B        |               |   |
| Ted Kluszewski, L<br>OBP: 0.364, SLG: 0.608 (1, 3) X  | 0-0 F8<br>③   |                            | 0-0 4-3<br>② X         | 0-0<br>HR<br>1-H<br>2-H                |                             | 0-0<br>HR       | 0-0 F4<br>②                          |               |   |
| Connie Ryan, R<br>OBP: 0.387, SLG: 0.400<br>Sammy Meeks, R<br>OBP: 0.306, SLG: 0.394 (1, 4) X<br>(7, 6)         |               | 4-0<br>1B<br>1B<br>BB      | 0-0<br>1B<br>2-H       | 0-0 F8<br>②                            |                             | 0-0 F4<br>① X   | 0-0<br>E<br>1-2<br>3-H<br>1B         |               |   |
| Joe Adcock, R<br>OBP: 0.309, SLG: 0.367 (1, 7) X  |               | 0-0<br>E<br>1-2<br>1B      |                        | 0-0<br>1B<br>F7<br>③                   |                             | 0-3<br>K<br>② X | 0-0<br>E8<br>FC5<br>1-3<br>2-H<br>1B |               |   |
| Johnny Pramesa, R<br>OBP: 0.355, SLG: 0.481<br>Dixie Howell, R<br>OBP: 0.331, SLG: 0.291 (1, 2) X<br>(7, 2)     |               | 0-0 F7<br>①                |                        | 0-0<br>2B<br>1-2<br>1B                 | 0-0<br>HR                   | 0-0 F8<br>③ X   | 0-0<br>FC5<br>2-3                    |               |   |
| Virgil Stallcup, R<br>OBP: 0.303, SLG: 0.381<br>Bobby Adams, R<br>OBP: 0.333, SLG: 0.327 (1, 6) X<br>(7, 4)     |               | 0-0 E8<br>1-3<br>2-H<br>1B |                        | 0-0<br>SH1-3<br>1-H<br>2-H<br>HR<br>2B | 0-0<br>FC1-5-6<br>2B        |                 | 0-0 5-3<br>① X                       | 0-0 F8<br>①   |   |
| Ken Raffensberger, R<br>OBP: 0.213, SLG: 0.186 (1, 1) X   |               | 0-3<br>K<br>②              |                        | 0-0<br>SH1-3<br>2-3                    | 0-0<br>FC1-5-6<br>HR<br>2-3 |                 | 4-0<br>BB<br>2B<br>BB                | 0-3<br>K<br>② |   |

| AB    | R      | H     | RBI    | BB    | SO    | LOB   |
|-------|--------|-------|--------|-------|-------|-------|
| 5     | 2      | 1     | 2      | 1     | 0     | 3     |
| 4     | 3      | 3     | 3      | 1     | 0     | 0     |
| 1     | 0      | 0     | 0      | 1     | 0     | 1     |
| 2     | 2      | 1     | 1      | 1     | 1     | 0     |
| 5     | 2      | 2     | 4      | 0     | 0     | 4     |
| 3     | 1      | 1     | 0      | 1     | 0     | 0     |
| 1     | 0      | 1     | 1      | 0     | 0     | 0     |
| 5     | 1      | 3     | 1      | 0     | 1     | 0     |
| 4     | 2      | 2     | 1      | 0     | 0     | 2     |
| 1     | 0      | 0     | 0      | 0     | 0     | 2     |
| 3     | 1      | 3     | 3      | 0     | 0     | 0     |
| 2     | 0      | 0     | 0      | 0     | 0     | 0     |
| 3     | 2      | 0     | 0      | 1     | 2     | 3     |
| 1B: 9 | SF: 0  | 2B: 3 | SAC: 1 | 3B: 0 | DP: 0 | HR: 5 |
| BB: 6 | HBP: 0 |       |        |       |       | CS: 0 |

**BOTTOM**

**New York Giants @ Cincinnati Reds**  
**Crosley Field, Cincinnati, OH**  
 Sun Jul 16 1950, 3:33 AM EDT  
 Unknown

[livebaseballscores.com](http://livebaseballscores.com)

|            |           |
|------------|-----------|
| <b>AB</b>  | <b>39</b> |
| <b>R</b>   | <b>16</b> |
| <b>H</b>   | <b>17</b> |
| <b>RBI</b> | <b>16</b> |
| <b>BB</b>  | <b>6</b>  |
| <b>SO</b>  | <b>4</b>  |
| <b>LOB</b> | <b>15</b> |



| Inning Stats                                | R: 0 | H: 1   | E: 0   | LOB: 1 | K: 0 | BB: 0 | S: 4  | R: 1  | H: 2   | E: 1           | LOB: 2 | K: 1  | BB: 1 | S: 7  | R: 0  | H: 1       | E: 0        | LOB: 2 | K: 0 | BB: 1 | S: 3 | R: 7 | H: 5 | E: 0 | LOB: 0 | K: 0 | BB: 2 | S: 8 | R: 3 | H: 3 | E: 0 | LOB: 0 | K: 1 | BB: 0 | S: 8 | R: 1 | H: 1 | E: 0 | LOB: 0 | K: 1 | BB: 0 | S: 6 | R: 4 | H: 4 | E: 1 | LOB: 2 | K: 0 | BB: 2 | S: 7 | R: 0 | H: 0 | E: 0 | LOB: 0 | K: 1 | BB: 0 | S: 5 | 1B: 9 <th>SF: 0 <th>2B: 3 <th>SAC: 1 <th>3B: 0 <th>DP: 0 <th>HR: 5 <th>HBP: 0 <th>WP: 0 <th>PA: 46 <th>PB: 0 <th>SB: 0 <th>CS: 0 <th>ERA</th> <th>WHIP</th> </th></th></th></th></th></th></th></th></th></th></th></th> | SF: 0 <th>2B: 3 <th>SAC: 1 <th>3B: 0 <th>DP: 0 <th>HR: 5 <th>HBP: 0 <th>WP: 0 <th>PA: 46 <th>PB: 0 <th>SB: 0 <th>CS: 0 <th>ERA</th> <th>WHIP</th> </th></th></th></th></th></th></th></th></th></th></th> | 2B: 3 <th>SAC: 1 <th>3B: 0 <th>DP: 0 <th>HR: 5 <th>HBP: 0 <th>WP: 0 <th>PA: 46 <th>PB: 0 <th>SB: 0 <th>CS: 0 <th>ERA</th> <th>WHIP</th> </th></th></th></th></th></th></th></th></th></th> | SAC: 1 <th>3B: 0 <th>DP: 0 <th>HR: 5 <th>HBP: 0 <th>WP: 0 <th>PA: 46 <th>PB: 0 <th>SB: 0 <th>CS: 0 <th>ERA</th> <th>WHIP</th> </th></th></th></th></th></th></th></th></th> | 3B: 0 <th>DP: 0 <th>HR: 5 <th>HBP: 0 <th>WP: 0 <th>PA: 46 <th>PB: 0 <th>SB: 0 <th>CS: 0 <th>ERA</th> <th>WHIP</th> </th></th></th></th></th></th></th></th> | DP: 0 <th>HR: 5 <th>HBP: 0 <th>WP: 0 <th>PA: 46 <th>PB: 0 <th>SB: 0 <th>CS: 0 <th>ERA</th> <th>WHIP</th> </th></th></th></th></th></th></th> | HR: 5 <th>HBP: 0 <th>WP: 0 <th>PA: 46 <th>PB: 0 <th>SB: 0 <th>CS: 0 <th>ERA</th> <th>WHIP</th> </th></th></th></th></th></th> | HBP: 0 <th>WP: 0 <th>PA: 46 <th>PB: 0 <th>SB: 0 <th>CS: 0 <th>ERA</th> <th>WHIP</th> </th></th></th></th></th> | WP: 0 <th>PA: 46 <th>PB: 0 <th>SB: 0 <th>CS: 0 <th>ERA</th> <th>WHIP</th> </th></th></th></th> | PA: 46 <th>PB: 0 <th>SB: 0 <th>CS: 0 <th>ERA</th> <th>WHIP</th> </th></th></th> | PB: 0 <th>SB: 0 <th>CS: 0 <th>ERA</th> <th>WHIP</th> </th></th> | SB: 0 <th>CS: 0 <th>ERA</th> <th>WHIP</th> </th> | CS: 0 <th>ERA</th> <th>WHIP</th> | ERA | WHIP |
|---|------|--------|--------|--------|------|-------|-------|-------|--------|----------------|--------|-------|-------|-------|-------|------------|-------------|--------|------|-------|------|------|------|------|--------|------|-------|------|------|------|------|--------|------|-------|------|------|------|------|--------|------|-------|------|------|------|------|--------|------|-------|------|------|------|------|--------|------|-------|------|--|---|--|---|---|--|---|--|--|---|---|--|----------------------------------|-----|------|
| <b>Jack Kramer, R</b> (1, 1)<br>ERA: 4.7    | 3.1  | WLS: L | BF: 19 | H: 8   | R: 5 | ER: 5 | SO: 1 | BB: 2 | IBB: 0 | HBP: 0         | BLK: 0 | WP: 0 | HR: 1 | S: 19 | P: 27 | ERA: 13.50 | WHIP: 3.000 |        |      |       |      |      |      |      |        |      |       |      |      |      |      |        |      |       |      |      |      |      |        |      |       |      |      |      |      |        |      |       |      |      |      |      |        |      |       |      |  |   |  |   |   |  |   |  |  |   |   |  |                                  |     |      |
| <b>Sheldon Jones, R</b> (4, 1)<br>ERA: 5.68 | 1.1  |        | 10     | 4      | 6    | 6     | 0     | 2     | 0      | 0              | 0      | 0     | 3     | 8     | 16    | 40.50      | 4.500       |        |      |       |      |      |      |      |        |      |       |      |      |      |      |        |      |       |      |      |      |      |        |      |       |      |      |      |      |        |      |       |      |      |      |      |        |      |       |      |  |   |  |   |   |  |   |  |  |   |   |  |                                  |     |      |
| <b>Clint Hartung, R</b> (5, 1)<br>ERA: 5.97 | 3.1  |        | 17     | 5      | 5    | 5     | 3     | 2     | 0      | 0              | 0      | 0     | 1     | 21    | 29    | 13.50      | 2.100       |        |      |       |      |      |      |      |        |      |       |      |      |      |      |        |      |       |      |      |      |      |        |      |       |      |      |      |      |        |      |       |      |      |      |      |        |      |       |      |  |   |  |   |   |  |   |  |  |   |   |  |                                  |     |      |
|   |      |        |        |        |      |       |       |       |        | <b>PITCHER</b> |        |       |       |       |       |            |             |        |      | IP    | WLS  | BF   | H    | R    | ER     | SO   | BB    | IBB  | HBP  | BLK  | WP   | HR     | S    | P     | ERA  | WHIP |      |      |        |      |       |      |      |      |      |        |      |       |      |      |      |      |        |      |       |      |  |   |  |   |   |  |   |  |  |   |   |  |                                  |     |      |

| Batter   | 1   | 2                               | 3                            | 4                               | 5                            | 6                               | 7                            | 8                               | 9                            | 10                              | 11                           | 12                               | AB R H RBI BB SO LOB                            | TOP   |   |                              |                                 |                              |                                 |                                   |                                    |                                  |        |
|--|---|---------------------------------|------------------------------|---------------------------------|------------------------------|---------------------------------|------------------------------|---------------------------------|------------------------------|---------------------------------|------------------------------|----------------------------------|---|---|---|------------------------------|---------------------------------|------------------------------|---------------------------------|-----------------------------------|------------------------------------|----------------------------------|--------|
| <b>Eddie Stanky, R</b><br>OBP: 0.466, SLG: 0.435<br><b>Bill Rigney, R</b><br>OBP: 0.262, SLG: 0.232                                    | 4-0<br>1B<br>F8<br>BB                                 | 0-0<br>G6-4-3                   |                              | 0-0<br>1-3                      |                              | 0-0<br>1B<br>2B                 |                              | 0-0<br>BB<br>BB<br>1B           |                              | 0-3<br>K                        |                              | 0-0<br>1B                        | 3 2 1 0 1 0 2<br>3 0 2 0 0 1 0                  | <b>New York Giants @ Cincinnati Reds</b><br>Crosley Field, Cincinnati, OH<br>Sun Jul 16 1950, 3:38 AM EDT<br>Att. 15,872 - Sunny - 91 F |   |                              |                                 |                              |                                 |                                   |                                    |                                  |        |
| <b>Don Mueller, L</b><br>OBP: 0.318, SLG: 0.388  | 0-0<br>1-3<br>HR<br>1B                                |                                 | 0-0<br>4-3                   |                                 | 0-0<br>4-3                   | 0-0<br>2B<br>1B                 |                              | 0-0<br>F3                       |                              | 0-0<br>1B<br>1B                 |                              | 0-0<br>F8                        | 7 2 3 1 0 0 2                                   |   |   |                              |                                 |                              |                                 |                                   |                                    |                                  |        |
| <b>Monte Irvin, R</b><br>OBP: 0.335, SLG: 0.399  | 0-0<br>F8   |                                 | 0-0<br>FC6-4<br>1B           |                                 | 0-3<br>K                     | 0-0<br>1B<br>2B                 |                              | 4-0<br>BB<br>BB                 |                              | 0-0<br>1-2<br>1B                |                              |                                  | 5 0 3 2 1 1 1                                   |   |   |                              |                                 |                              |                                 |                                   |                                    |                                  |        |
| <b>Hank Thompson, L</b><br>OBP: 0.403, SLG: 0.494  | 0-0<br>F6   |                                 | 0-0<br>F7                    |                                 | 0-0<br>1B<br>HR<br>1B        | 0-3<br>K                        |                              | 4-0<br>1-2<br>2-3<br>BB         |                              | 0-0<br>F9                       |                              |                                  | 5 1 1 0 1 1 5                                   |   |   |                              |                                 |                              |                                 |                                   |                                    |                                  |        |
| <b>Bobby Thomson, R</b><br>OBP: 0.325, SLG: 0.439  | 0-0<br>1-H<br>HR                                      |                                 | 0-0<br>FC6-4<br>1-2f         |                                 | 0-0<br>1-2<br>HR<br>1B       |                                 | 0-0<br>S<br>1B               | 0-0<br>F8                       |                              | 0-3<br>K                        |                              |                                  | 6 2 3 2 0 1 4                                   |   |   |                              |                                 |                              |                                 |                                   |                                    |                                  |        |
| <b>Wes Westrum, R</b><br>OBP: 0.393, SLG: 0.524  | 0-0<br>F9   |                                 |                              | 0-0<br>6-3                      |                              | 0-0<br>1-H<br>2-H<br>HR         | 0-0<br>F3                    |                                 | 0-0<br>5-3                   |                                 | 4-0<br>G6-4-3<br>BB          |                                  | 5 1 1 3 1 0 1                                   |   |   |                              |                                 |                              |                                 |                                   |                                    |                                  |        |
| <b>Tookie Gilbert, L</b><br>OBP: 0.326, SLG: 0.337   |   | 0-0<br>1B<br>2B                 |                              | 0-0<br>HR<br>1B                 |                              | 0-3<br>K                        | 4-0<br>G6-4-3<br>BB          |                                 | 0-0<br>F6                    |                                 | 0-0<br>G6-4-3                |                                  | 5 1 2 0 1 1 1                                   |   |   |                              |                                 |                              |                                 |                                   |                                    |                                  |        |
| <b>Alvin Dark, R</b><br>OBP: 0.323, SLG: 0.455   |   | 0-0<br>F4                       |                              | 0-0<br>F5                       |                              | 0-0<br>F5                       | 0-0<br>G6-4-3                |                                 | 0-0<br>L5                    |                                 |                              | 0-0<br>6-3                       | 6 0 0 0 0 0 4                                   |   |   |                              |                                 |                              |                                 |                                   |                                    |                                  |        |
| <b>Dave Koslo, L</b><br>OBP: 0.119, SLG: 0.150<br><b>Andy Hansen, R</b><br>ERA: 3.72<br><b>Sal Maglie, R</b><br>OBP: 0.045, SLG: 0.091 |   | 0-0<br>2-3<br>1B                |                              | 0-0<br>1-H<br>HR                |                              | 0-0<br>4-3                      |                              | 0-3<br>K                        |                              | 0-0<br>5-3                      |                              | 0-3<br>K                         | 3 1 2 2 0 0 0<br>0 0 0 0 0 0 0<br>3 0 0 0 0 2 0 |   |  |                              |                                 |                              |                                 |                                   |                                    |                                  |        |
| <b>Inning Stats</b>  | R: 3<br>E: 0<br>K: 0<br>S: 5                          | H: 2<br>LOB: 0<br>BB: 1<br>P: 9 | R: 0<br>E: 0<br>K: 0<br>S: 4 | H: 2<br>LOB: 1<br>BB: 0<br>P: 4 | R: 0<br>E: 0<br>K: 0<br>S: 4 | H: 1<br>LOB: 1<br>BB: 0<br>P: 4 | R: 2<br>E: 0<br>K: 1<br>S: 5 | H: 3<br>LOB: 1<br>BB: 0<br>P: 8 | R: 0<br>E: 0<br>K: 1<br>S: 3 | H: 1<br>LOB: 3<br>BB: 1<br>P: 7 | R: 0<br>E: 0<br>K: 1<br>S: 6 | H: 1<br>LOB: 3<br>BB: 2<br>P: 14 | R: 0<br>E: 0<br>K: 0<br>S: 3                    | H: 0<br>LOB: 0<br>BB: 0<br>P: 3   |   | R: 0<br>E: 0<br>K: 1<br>S: 4 | H: 0<br>LOB: 0<br>BB: 1<br>P: 8 | R: 0<br>E: 0<br>K: 1<br>S: 6 | H: 1<br>LOB: 1<br>BB: 0<br>P: 6 | 1B: 12<br>2B: 3<br>3B: 0<br>HR: 3 | SF: 0<br>SAC: 0<br>DP: 3<br>HBP: 0 | WP: 0<br>PB: 0<br>SB: 1<br>CS: 0 | PA: 56 |
| <b>PITCHER</b>   | IP WLS BF H R ER SO BB IBB HBP BLK WP HR S P ERA WHIP |                                 |                              |                                 |                              |                                 |                              |                                 |                              |                                 |                              |                                  |   |   |   |                              |                                 |                              |                                 |                                   |                                    |                                  |        |
| <b>Howie Fox, R</b><br>ERA: 5.58   | (1, 1) 5.0  |                                 |                              |                                 |                              |                                 |                              |                                 |                              |                                 |                              |                                  |   |   |   |                              |                                 |                              |                                 |                                   |                                    |                                  |        |
| <b>Frank Smith, R</b><br>ERA: 3.72   | (6, 1) 1.0  | 6                               | 3                            | 2                               | 2                            | 1                               | 0                            | 0                               | 0                            | 0                               | 0                            | 0                                | 0   | 0   | 0   | 0                            | 0                               | 0                            | 0                               | 0                                 | 0                                  | 0                                | 0      |
| <b>Johnny Hetki, R</b><br>ERA: 5.03  | (7, 1) 6.0  | W 25                            | 5                            | 0                               | 0                            | 4                               | 4                            | 0                               | 0                            | 0                               | 0                            | 0                                | 0   | 0   | 0   | 0                            | 0                               | 0                            | 0                               | 0                                 | 0                                  | 0                                | 0      |

|     |    |
|-----|----|
| AB  | 51 |
| R   | 10 |
| H   | 18 |
| RBI | 10 |
| BB  | 5  |
| SO  | 7  |
| LOB | 20 |

| Batter   | 1          | 2     | 3   | 4  | 5               | 6        | 7           | 8          | 9        | 10              | 11  | 12               | AB | R | H | RBI | BB | SO | LOB |
|--|------------|-------|-----|----|-----------------|----------|-------------|------------|----------|-----------------|-----|------------------|----|---|---|-----|----|----|-----|
| <b>Bobby Adams, R</b><br><small>OBP: 0.337, SLG: 0.331</small><br><b>Johnny Hetki, R</b><br><small>OBP: 0.250, SLG: 0.143</small>  | F7         | CS 1B |     |    | G6-4-3 1B       | F8       |             | 6-3        |          | SH1-4           |     | SH1-4            | 4  | 0 | 2 | 0   | 0  | 0  | 1   |
| <b>Connie Ryan, R</b><br><small>OBP: 0.392, SLG: 0.406</small>   | 2B 3B      | 4-3   |     |    | G6-4-3 1-2f 3-H |          | 4-3         | 1B BB      |          | G6-4-3 IBB      |     | FC3-6 IBB        | 4  | 1 | 1 | 0   | 3  | 0  | 2   |
| <b>Danny Litwhiler, R</b><br><small>OBP: 0.380, SLG: 0.455</small><br><b>Lloyd Merriman, L</b><br><small>OBP: 0.315, SLG: 0.374</small>  | HR 2B      |       | 4-3 |    | 1B              |          | 1B FC6-4 2B | 1-2 FC6-4  |          | G6-4-3 1-2f 2-3 |     | FC3-6 E IBB      | 6  | 2 | 4 | 1   | 0  | 0  | 2   |
| <b>Ted Kluszewski, L</b><br><small>OBP: 0.362, SLG: 0.598</small>  | F7         |       | K   |    | F7              |          | FC6-4 1B    | 1-2f FC6-4 |          |                 | F7  | E IBB            | 6  | 0 | 1 | 0   | 1  | 1  | 4   |
| <b>Bob Usher, R</b><br><small>OBP: 0.341, SLG: 0.405</small>   | HR BB      |       | 5-3 |    |                 | 1B 1B    | 1-2f HR 3-H |            | K        |                 | 2B  | E 1-2 2-3 3-H    | 6  | 3 | 2 | 1   | 1  | 1  | 3   |
| <b>Joe Adcock, R</b><br><small>OBP: 0.340, SLG: 0.447</small>  | 1-H 2-H HR |       |     | G3 |                 | 1B PB 1B | 1-H HR      |            | FC1-6 BB |                 | IBB |                  | 4  | 3 | 3 | 5   | 2  | 0  | 0   |
| <b>Johnny Pramesa, R</b><br><small>OBP: 0.388, SLG: 0.481</small><br><b>Herm Wehmeier, R</b><br><small>OBP: 0.218, SLG: 0.259</small><br><b>Dixie Howell, R</b><br><small>OBP: 0.325, SLG: 0.286</small>   | HBP        |       | 4-3 |    | 1-H 3-H 1B      | 1B BB    |             | FC1-6 1-2f |          |                 | K   |                  | 2  | 0 | 1 | 2   | 1  | 0  | 0   |
| <b>Virgil Stallcup, R</b><br><small>OBP: 0.296, SLG: 0.372</small>   | F9         |       |     | F4 |                 | F8       | 1-4-3       |            | F7       |                 | K   |                  | 6  | 0 | 0 | 0   | 0  | 1  | 5   |
| <b>Howie Fox, R</b><br><small>OBP: 0.233, SLG: 0.367</small><br><b>Peanuts Lowrey, R</b><br><small>OBP: 0.325, SLG: 0.300</small><br><b>Frank Smith, R</b><br><small>OBP: 0.077, SLG: 0.077</small><br><b>Grady Hatton, L</b><br><small>OBP: 0.353, SLG: 0.442</small> |            | 5-3   |     |    | 1B G6-4-3 2B    | 2B       |             | K          |          | SH1-4 BB        |     | FC3-6 E SH1-4 1B | 1  | 0 | 0 | 0   | 0  | 0  | 0   |

| BOTTOM       |               |
|--------------|---------------|
| <b>AB</b>    | 47            |
| <b>R</b>     | 11            |
| <b>H</b>     | 17            |
| <b>RBI</b>   | 9             |
| <b>BB</b>    | 9             |
| <b>SO</b>    | 5             |
| <b>LOB</b>   | 22            |
|              |               |
| <b>WP: 0</b> | <b>PA: 59</b> |
| <b>PB: 1</b> |               |
| <b>SB: 0</b> |               |
| <b>CS: 1</b> |               |

| New York Giants @ Cincinnati Reds          |                            |
|--|----------------------------|
| Crosley Field, Cincinnati, OH              |                            |
| Sun Jul 16 1950, 3:38 AM EDT               | Att: 15,872 - Sunny - 91 F |
| <a href="#">livebaseballscorecards.com</a> |                            |

| Batter   | 1   | 2   | 3   | 4   | 5   | 6   | 7  | 8   | 9   | AB   | R                                       | H | RBI | BB | SO | LOB | TOP |
|--|---|---|---|---|---|---|--|---|---|--|---|---|-----|----|----|-----|-----|
| <b>Bill Rigney, R</b> (1, 4)<br><small>OBP: 0.242, SLG: 0.213</small>  | <br><small>0-3</small>  | <br><small>0-0</small>  |   |   | <br><small>0-0</small>                              | <br><small>0-3</small>                                | <br><small>0-0</small>                               |   |   | 5 0 0 0 0 2 7  |   |   |     |    |    |     |     |
| <b>Don Mueller, L</b> (1, 9)<br><small>OBP: 0.316, SLG: 0.384</small>  | <br><small>0-0</small>  |   | <br><small>0-0</small>                              |   | <br><small>0-0</small>                              | <br><small>1-3 2-H 3-H</small>                        |  | <br><small>0-0</small>                              |   | 5 1 1 2 0 0 0  |   |   |     |    |    |     |     |
| <b>Monte Irvin, R</b> (1, 7)<br><small>OBP: 0.343, SLG: 0.397</small>  | <br><small>0-0</small>  |   | <br><small>0-0</small>                              |   | <br><small>4-0</small>                              | <br><small>1-0</small>                                |  | <br><small>0-0</small>                              |   | 3 2 1 0 1 0 0  |   |   |     |    |    |     |     |
| <b>Hank Thompson, L</b> (1, 5)<br><small>OBP: 0.403, SLG: 0.500</small>  | <br><small>0-3</small>  |   | <br><small>0-0</small>                              |   | <br><small>0-0</small>                              | <br><small>0-0</small>                                |  | <br><small>0-0</small>                              |   | 5 0 2 4 0 1 1  |   |   |     |    |    |     |     |
| <b>Bobby Thomson, R</b> (1, 8)<br><small>OBP: 0.323, SLG: 0.445</small>  |   | <br><small>0-0</small>  |   | <br><small>0-0</small>                              |   | <br><small>0-0</small>                                |  | <br><small>0-0</small>                              |   | 5 1 1 1 0 1 1  |   |   |     |    |    |     |     |
| <b>Wes Westrum, R</b> (1, 2)<br><small>OBP: 0.396, SLG: 0.534</small>  |   | <br><small>0-0</small>  |   | <br><small>0-0</small>                              |   | <br><small>4-0</small>                                | <br><small>0-3</small>                               | <br><small>4-0</small>                              |   | 3 2 1 1 2 1 0  |   |   |     |    |    |     |     |
| <b>Tookie Gilbert, L</b> (1, 3)<br><small>OBP: 0.328, SLG: 0.336</small>   |   | <br><small>4-0</small>  |   | <br><small>0-0</small>                              |   | <br><small>0-0</small>                                | <br><small>0-0</small>                               | <br><small>0-0</small>                              |   | 4 1 1 0 1 0 1  |   |   |     |    |    |     |     |
| <b>Alvin Dark, R</b> (1, 6)<br><small>OBP: 0.327, SLG: 0.468</small>   |   | <br><small>0-0</small>  |   | <br><small>0-0</small>                              |   | <br><small>0-0</small>                                | <br><small>0-0</small>                               | <br><small>0-0</small>                              |   | 5 2 3 2 0 0 2  |   |   |     |    |    |     |     |
| <b>Jim Hearn, R</b> (1, 1)<br><small>OBP: 0.600, SLG: 0.333</small>  |   | <br><small>0-0</small>  |   | <br><small>0-0</small>                              |   | <br><small>4-0</small>                                | <br><small>4-0</small>                               |   |   | 2 1 0 0 2 0 2  |   |   |     |    |    |     |     |
| <b>Inning Stats</b>  | R: 0 H: 1<br>E: 0 LOB: 1<br>K: 2 BB: 0<br>S: 8 P: 8   | R: 1 H: 1<br>E: 1 LOB: 2<br>K: 0 BB: 1<br>S: 5 P: 9                     | R: 0 H: 0<br>E: 0 LOB: 0<br>K: 0 BB: 0<br>S: 3 P: 3 | R: 2 H: 2<br>E: 0 LOB: 0<br>K: 0 BB: 0<br>S: 5 P: 5 | R: 1 H: 1<br>E: 0 LOB: 1<br>K: 0 BB: 1<br>S: 3 P: 7 | R: 6 H: 4<br>E: 1 LOB: 1<br>K: 2 BB: 2<br>S: 11 P: 20 | R: 0 H: 1<br>E: 0 LOB: 2<br>K: 1 BB: 1<br>S: 6 P: 10 | R: 0 H: 0<br>E: 0 LOB: 0<br>K: 0 BB: 0<br>S: 3 P: 3 | R: 0 H: 0<br>E: 0 LOB: 1<br>K: 0 BB: 1<br>S: 3 P: 7 | 1B: 5 SF: 0<br>2B: 2 SAC: 0<br>3B: 0 DP: 0<br>HR: 3 HBP: 1 | WP: 0 PA: 44<br>PB: 0<br>SB: 0<br>CS: 0 |   |     |    |    |     |     |
| <b>PITCHER</b><br><b>Herm Wehmeier, R</b> (1, 1)<br><small>ERA: 6.01</small><br><b>Eddie Erault, R</b> (6, 1)<br><small>ERA: 8.7</small><br><b>Frank Smith, R</b> (6, 1)<br><small>ERA: 3.48</small> | IP WLS BF H R ER SO BB IBB HBP BLK WP HR S P ERA WHIP<br>5.1 L 27 7 8 8 3 4 0 0 0 0 3 29 45 13.50 2.062<br>0.1 4 2 2 2 1 0 0 0 1 0 0 0 5 6 54.00 6.000<br>3.1 13 1 0 0 1 2 0 0 0 0 0 0 13 21 0.00 0.900 | <b>PITCHER</b><br>IP WLS BF H R ER SO BB IBB HBP BLK WP HR S P ERA WHIP |   |   |   |   |  |   |   |  |   |   |     |    |    |     |     |

**New York Giants @ Cincinnati Reds**  
 Crosley Field, Cincinnati, OH  
Mon Jul 17 1950, 3:33 AM EDT  
 Att. 8,364 - Unknown

[livebaseballscorecards.com](http://livebaseballscorecards.com)

|     |    |
|-----|----|
| AB  | 37 |
| R   | 10 |
| H   | 10 |
| RBI | 10 |
| BB  | 6  |
| SO  | 5  |
| LOB | 14 |



| Batter | 1 | 2 | 3 | 4 | 5 | 6 | 7 | 8 | 9 | AB | R | H | RBI | BB | SO | LOB |
|--------|---|---|---|---|---|---|---|---|---|----|---|---|-----|----|----|-----|
|--------|---|---|---|---|---|---|---|---|---|----|---|---|-----|----|----|-----|

|   |    |     |       |  |    |      |  |     |  |   |   |   |   |   |   |   |
|---|----|-----|-------|--|----|------|--|-----|--|---|---|---|---|---|---|---|
| Lloyd Merriman, L<br>OBP: 0.313, SLG: 0.370<br>(1, 8)   | F8 |     | F8    |  | F8 |      |  | 1-3 |  | 4 | 0 | 1 | 1 | 0 | 0 | 0 |
| Connie Ryan, R<br>OBP: 0.388, SLG: 0.401<br>Bobby Adams, R<br>OBP: 0.335, SLG: 0.329<br>(1, 4)<br>(7, 4)  | K  |     | F8    |  |    | 6-3  |  | F5  |  | 3 | 0 | 0 | 0 | 0 | 1 | 1 |
| Grady Hatton, L<br>OBP: 0.355, SLG: 0.440<br>(1, 5)   | F8 |     |       |  |    | F8   |  | F8  |  | 3 | 1 | 1 | 0 | 1 | 0 | 0 |
| Ted Kluszewski, L<br>OBP: 0.360, SLG: 0.590<br>(1, 3)   |    | F5  |       |  |    | G4-3 |  | L8  |  | 3 | 0 | 0 | 0 | 1 | 0 | 1 |
| Bob Usher, R<br>OBP: 0.333, SLG: 0.395<br>(1, 9)  |    | F9  |       |  |    | E6   |  | 5-3 |  | 4 | 1 | 0 | 0 | 0 | 0 | 1 |
| Joe Adcock, R<br>OBP: 0.337, SLG: 0.439<br>(1, 7)   |    | 1-3 |       |  |    | FC4  |  | 5-3 |  | 4 | 0 | 1 | 1 | 0 | 0 | 1 |
| Johnny Pramesa, R<br>OBP: 0.359, SLG: 0.468<br>(1, 2)   |    |     | F6    |  |    | FC4  |  | F7  |  | 3 | 0 | 0 | 0 | 0 | 0 | 1 |
| Virgil Stallcup, R<br>OBP: 0.298, SLG: 0.373<br>Sammy Meeks, R<br>OBP: 0.297, SLG: 0.382<br>(1, 6)<br>(7, 6)  |    |     | SH1-3 |  |    | K    |  | F2  |  | 2 | 1 | 1 | 0 | 0 | 1 | 0 |
| Herm Wehmeier, R<br>OBP: 0.214, SLG: 0.255<br>Eddie Erault, R<br>OBP: 0.167, SLG: 0.333<br>Frank Smith, R<br>OBP: 0.071, SLG: 0.071<br>(6, 1)<br>(6, 1) |    |     | SH1-3 |  |    | 1-3  |  | 5-3 |  | 1 | 0 | 0 | 0 | 0 | 0 | 0 |
|   |    |     |       |  |    |      |  |     |  | 1 | 0 | 0 | 0 | 0 | 0 | 0 |

| Inning Stats | R: 0 | H: 0 | E: 0 | LOB: 0 | K: 1 | S: 5 | P: 5 | R: 0 | H: 0 | E: 0 | LOB: 0 | K: 0 | BB: 0 | S: 3 | R: 1 | H: 2 | E: 0 | LOB: 1 | K: 0 | BB: 0 | S: 5 | P: 5 | R: 1 | H: 2 | E: 1 | LOB: 1 | K: 0 | BB: 0 | S: 5 | P: 5 | R: 0 | H: 0 | E: 0 | LOB: 0 | K: 1 | BB: 0 | S: 5 | P: 5 | R: 0 | H: 0 | E: 0 | LOB: 0 | K: 0 | BB: 0 | S: 3 | P: 3 | R: 0 | H: 0 | E: 0 | LOB: 0 | K: 0 | BB: 0 | S: 3 | P: 3 | R: 0 | H: 0 | E: 0 | LOB: 0 | K: 0 | BB: 0 | S: 3 | P: 3 | R: 1 | H: 0 | E: 1 | LOB: 1 | K: 0 | BB: 2 | S: 3 | P: 11 | 1B: 4 | SF: 0 | 2B: 0 | SAC: 1 | 3B: 0 | DP: 1 | HR: 0 | HBP: 0 | WP: 2 | PA: 33 | PB: 0 | SB: 0 | CS: 0 |
|--------------|------|------|------|--------|------|------|------|------|------|------|--------|------|-------|------|------|------|------|--------|------|-------|------|------|------|------|------|--------|------|-------|------|------|------|------|------|--------|------|-------|------|------|------|------|------|--------|------|-------|------|------|------|------|------|--------|------|-------|------|------|------|------|------|--------|------|-------|------|------|------|------|------|--------|------|-------|------|-------|-------|-------|-------|--------|-------|-------|-------|--------|-------|--------|-------|-------|-------|
|--------------|------|------|------|--------|------|------|------|------|------|------|--------|------|-------|------|------|------|------|--------|------|-------|------|------|------|------|------|--------|------|-------|------|------|------|------|------|--------|------|-------|------|------|------|------|------|--------|------|-------|------|------|------|------|------|--------|------|-------|------|------|------|------|------|--------|------|-------|------|------|------|------|------|--------|------|-------|------|-------|-------|-------|-------|--------|-------|-------|-------|--------|-------|--------|-------|-------|-------|

**BOTTOM**

**New York Giants @ Cincinnati Reds**  
 Crosley Field, Cincinnati, OH  
 Mon Jul 17 1950, 3:33 AM EDT  
 Att. 8,364 - Unknown

|            |           |
|------------|-----------|
| <b>AB</b>  | <b>30</b> |
| <b>R</b>   | <b>3</b>  |
| <b>H</b>   | <b>4</b>  |
| <b>RBI</b> | <b>2</b>  |
| <b>BB</b>  | <b>2</b>  |
| <b>SO</b>  | <b>2</b>  |
| <b>LOB</b> | <b>5</b>  |



| PITCHER                            | IP  | WLS | BF | H | R | ER | SO | BB | IBB | HBP | BLK | WP | HR | S  | P  | ERA  | WHIP  |
|------------------------------------|-----|-----|----|---|---|----|----|----|-----|-----|-----|----|----|----|----|------|-------|
| Jim Hearn, R<br>ERA: 5.5<br>(1, 1) | 9.0 |     | 33 | 4 | 3 | 1  | 2  | 2  | 0   | 0   | 0   | 1  | 0  | 35 | 43 | 1.00 | 0.667 |

| Batter   | 1                 | 2                | 3          | 4               | 5         | 6                              | 7            | 8                              | 9 | AB R H RBI BB SO LOB |
|--|-------------------|------------------|------------|-----------------|-----------|--------------------------------|--------------|--------------------------------|---|----------------------|
| <b>Bill Rigney, R</b> (1, 4)<br>OBP: 0.246, SLG: 0.206<br>BB | 4-0<br>1-3<br>BB  |                  | 0-0<br>6-3 |                 | 0-0<br>F8 |                                | 0-0<br>SH1-4 |                                |   | 2 0 0 0 1 0 0        |
| <b>Don Mueller, L</b> (1, 9)<br>OBP: 0.310, SLG: 0.377       | 0-0<br>1-3<br>1-2 |                  | 0-0<br>1-3 |                 | 0-3<br>K  |                                | 0-0<br>2-3   |                                |   | 4 0 0 0 0 1 3        |
| <b>Monte Irvin, R</b> (1, 7)<br>OBP: 0.346, SLG: 0.400       | 0-0<br>F3         |                  | 0-0<br>F3  |                 |           | 0-0<br>BB<br>FC5-2<br>1B       |              | 0-0<br>FC1-6<br>1B             |   | 4 0 2 0 0 0 1        |
| <b>Hank Thompson, L</b> (1, 5)<br>OBP: 0.401, SLG: 0.494     | 0-0<br>F8         |                  |            | 0-0<br>F4       |           | 4-0<br>BB<br>FC5-2<br>L5<br>BB |              | 0-0<br>FC1-6<br>G6-4-3<br>1-2f |   | 3 0 0 0 1 0 2        |
| <b>Bobby Thomson, R</b> (1, 8)<br>OBP: 0.325, SLG: 0.444     |                   | 0-0<br>F9        |            | 0-0<br>1B<br>1B |           | 4-0<br>BB<br>FC5-2<br>BB       |              | 0-0<br>G6-4-3<br>1-2f          |   | 3 0 1 0 1 0 1        |
| <b>Wes Westrum, R</b> (1, 2)<br>OBP: 0.398, SLG: 0.533       |                   | 0-0<br>1B<br>1B  |            | 0-0<br>1B<br>1B |           | 0-0<br>FC5-2                   |              | 0-0<br>6-3                     |   | 4 0 2 0 0 0 3        |
| <b>Alvin Dark, R</b> (1, 6)<br>OBP: 0.326, SLG: 0.465        |                   | 0-0<br>1-2<br>1B |            | 0-0<br>F4       |           | 0-0<br>L5                      |              | 0-0<br>6-3                     |   | 4 0 1 0 0 0 5        |
| <b>Tookie Gilbert, L</b> (1, 3)<br>OBP: 0.327, SLG: 0.335    |                   | 0-3<br>K         |            | 0-0<br>F8       |           | 0-0<br>SH1-4<br>SH<br>1B       |              | 0-0<br>F9                      |   | 4 0 1 0 0 1 4        |
| <b>Monty Kennedy, R</b> (1, 1)<br>OBP: 0.069, SLG: 0.069     |                   | 0-0<br>F3        |            | 0-0<br>F9       |           | 0-0<br>SH<br>2-3<br>SH1-4      |              |                                |   | 2 0 0 0 0 0 2        |

| TOP   |                                   |
|---|-----------------------------------|
| <b>New York Giants @ Cincinnati Reds</b><br>Crosley Field, Cincinnati, OH             | <b>livebaseballscorecards.com</b> |
| <b>AB 30</b>  |                                   |
| <b>R 0</b>  |                                   |
| <b>H 7</b>  |                                   |
| <b>RBI 0</b>  |                                   |
| <b>BB 3</b>   |                                   |
| <b>SO 2</b>   |                                   |
| <b>LOB 21</b>   |                                   |
|  |                                   |
| <b>WP: 0 PA: 35</b>   |                                   |

Tue Jul 18 1950, 3:33 AM EDT  
Att. 2,967 - Unknown

| Inning Stats  | R: 0<br>E: 0<br>K: 0<br>S: 3 | H: 0<br>LOB: 1<br>BB: 1<br>P: 7 | R: 0<br>E: 0<br>K: 1<br>S: 7 | H: 2<br>LOB: 2<br>BB: 0<br>P: 7 | R: 0<br>E: 0<br>K: 0<br>S: 3 | H: 0<br>LOB: 0<br>BB: 0<br>P: 3 | R: 0<br>E: 0<br>K: 0<br>S: 5 | H: 2<br>LOB: 2<br>BB: 0<br>P: 5 | R: 0<br>E: 0<br>K: 1<br>S: 5 | H: 0<br>LOB: 0<br>BB: 0<br>P: 5 | R: 0<br>E: 0<br>K: 0<br>S: 3 | H: 1<br>LOB: 2<br>BB: 2<br>P: 11 | R: 0<br>E: 0<br>K: 0<br>S: 4 | H: 1<br>LOB: 1<br>BB: 0<br>P: 4 | R: 0<br>E: 0<br>K: 0<br>S: 3 | H: 1<br>LOB: 0<br>BB: 0<br>P: 3 | R: 0<br>E: 0<br>K: 0<br>S: 3 | H: 0<br>LOB: 0<br>BB: 0<br>P: 3 | 1B: 7<br>2B: 1<br>3B: 0<br>HR: 0 | SF: 0<br>SAC: 2<br>DP: 2<br>HBP: 0 | WP: 0<br>PB: 0<br>SB: 0<br>CS: 0 | PA: 35 |  |
|---|------------------------------|---------------------------------|------------------------------|---------------------------------|------------------------------|---------------------------------|------------------------------|---------------------------------|------------------------------|---------------------------------|------------------------------|----------------------------------|------------------------------|---------------------------------|------------------------------|---------------------------------|------------------------------|---------------------------------|----------------------------------|------------------------------------|----------------------------------|--------|--|
| <b>PITCHER</b><br><b>Howie Fox, R</b> (1, 1)<br>ERA: 5.07 | IP 9.0                       | WLS W                           | BF 35                        | H 7                             | R 0                          | ER 0                            | SO 2                         | BB 3                            | IBB 0                        | HBP 0                           | BLK 0                        | WP 0                             | HR 0                         | S 36                            | P 48                         | ERA 0.00                        | WHIP 1.111                   |                                 |                                  |                                    |                                  |        |  |
| <b>PITCHER</b>  | IP                           | WLS                             | BF                           | H                               | R                            | ER                              | SO                           | BB                              | IBB                          | HBP                             | BLK                          | WP                               | HR                           | S                               | P                            | ERA                             | WHIP                         |                                 |                                  |                                    |                                  |        |  |



| Batter  | 1          | 2           | 3          | 4          | 5          | 6          | 7          | 8         | 9 | AB | R | H | RBI | BB | SO | LOB |
|---|------------|-------------|------------|------------|------------|------------|------------|-----------|---|----|---|---|-----|----|----|-----|
| Bobby Adams, R (1, 5)<br>OBP: 0.328, SLG: 0.322<br>Grady Hatton, L (9, 5)<br>OBP: 0.355, SLG: 0.440       | 0-3<br>K   |             | 0-0<br>F7  |            | 0-0<br>F8  |            | 0-0<br>5-3 |           |   | 4  | 0 | 0 | 0   | 0  | 1  | 0   |
| Connie Ryan, R (1, 4)<br>OBP: 0.389, SLG: 0.397   | 0-0<br>5-3 |             | 4-0<br>BB  |            | 4-0<br>BB  |            |            | 0-0<br>F7 |   | 2  | 0 | 0 | 0   | 2  | 0  | 0   |
| Danny Litwhiler, R (1, 9)<br>OBP: 0.386, SLG: 0.441<br>Lloyd Merriman, L (9, 8)<br>OBP: 0.313, SLG: 0.370 | 4-0<br>BB  |             | 4-0<br>BB  |            | 0-0<br>F8  |            |            | 0-0<br>G3 |   | 2  | 0 | 0 | 0   | 2  | 0  | 1   |
| Ted Kluszewski, L (1, 3)<br>OBP: 0.358, SLG: 0.585  | 0-3<br>K   |             | 0-0<br>F5  |            | 0-0<br>3-1 |            |            | 0-0<br>1B |   | 4  | 0 | 1 | 0   | 0  | 1  | 4   |
| Bob Usher, R (1, 8)<br>OBP: 0.331, SLG: 0.388 (9, 9)  |            | 0-0<br>F7   |            | 4-0<br>BB  |            | 0-0<br>F7  |            | 0-3<br>K  |   | 3  | 0 | 0 | 0   | 1  | 1  | 1   |
| Joe Adcock, R (1, 7)<br>OBP: 0.327, SLG: 0.426<br>Peanuts Lowrey, R (9, 7)<br>OBP: 0.325, SLG: 0.300      |            | 0-0<br>6-3  |            | 0-0<br>2-3 |            | 0-0<br>5-3 |            |           |   | 3  | 0 | 0 | 0   | 0  | 0  | 1   |
| Dixie Howell, R (1, 2)<br>OBP: 0.317, SLG: 0.278  |            | 0-3<br>K2-3 |            | 0-0<br>F6  |            | 0-0<br>5-3 |            |           |   | 3  | 0 | 0 | 0   | 0  | 1  | 1   |
| Virgil Stallcup, R (1, 6)<br>OBP: 0.302, SLG: 0.385   |            |             | 0-0<br>HR  |            | 4-0<br>IBB |            | 0-0<br>F8  |           |   | 2  | 1 | 1 | 1   | 1  | 0  | 0   |
| Howie Fox, R (1, 1)<br>OBP: 0.212, SLG: 0.333   |            |             | 0-0<br>1-3 |            | 0-0<br>F8  |            | 0-0<br>5-3 |           |   | 3  | 0 | 0 | 0   | 0  | 0  | 2   |

| Inning Stats                                    | R: 0 | H: 0 | E: 0 | LOB: 1 | K: 2 | BB: 1 | S: 7 | P: 11 | R: 0 | H: 0 | E: 0 | LOB: 0 | K: 1 | BB: 0 | S: 5 | P: 5 | R: 1  | H: 1 | E: 0    | LOB: 2 | K: 0 | BB: 2 | S: 4 | P: 12 | R: 0 | H: 0 | E: 0 | LOB: 2 | K: 0 | BB: 2 | S: 3 | P: 11 | R: 0 | H: 0 | E: 0 | LOB: 1 | K: 0 | BB: 1 | S: 3 | P: 7 | R: 0 | H: 0 | E: 0 | LOB: 0 | K: 0 | BB: 0 | S: 3 | P: 3 | R: 0 | H: 0 | E: 0 | LOB: 0 | K: 0 | BB: 0 | S: 3 | P: 3 | R: 0 | H: 1 | E: 0 | LOB: 1 | K: 1 | BB: 0 | S: 6 | P: 6 |
|---|------|------|------|--------|------|-------|------|-------|------|------|------|--------|------|-------|------|------|-------|------|---------|--------|------|-------|------|-------|------|------|------|--------|------|-------|------|-------|------|------|------|--------|------|-------|------|------|------|------|------|--------|------|-------|------|------|------|------|------|--------|------|-------|------|------|------|------|------|--------|------|-------|------|------|
| PITCHER<br>Monty Kennedy, L (1, 1)<br>ERA: 4.64 | IP   | WLS  | BF   | H      | R    | ER    | SO   | BB    | IBB  | HBP  | BLK  | WP     | HR   | S     | P    | ERA  | WHIP  |      |         |        |      |       |      |       |      |      |      |        |      |       |      |       |      |      |      |        |      |       |      |      |      |      |      |        |      |       |      |      |      |      |      |        |      |       |      |      |      |      |      |        |      |       |      |      |
|   | 8.0  | L    | 32   | 2      | 1    | 1     | 4    | 5     | 1    | 0    | 0    | 0      | 1    | 34    | 58   | 1.12 | 0.875 |      |         |        |      |       |      |       |      |      |      |        |      |       |      |       |      |      |      |        |      |       |      |      |      |      |      |        |      |       |      |      |      |      |      |        |      |       |      |      |      |      |      |        |      |       |      |      |
|   |      |      |      |        |      |       |      |       |      |      |      |        |      |       |      |      |       |      | PITCHER | IP     | WLS  | BF    | H    | R     | ER   | SO   | BB   | IBB    | HBP  | BLK   | WP   | HR    | S    | P    | ERA  | WHIP   |      |       |      |      |      |      |      |        |      |       |      |      |      |      |      |        |      |       |      |      |      |      |      |        |      |       |      |      |

**BOTTOM**

**New York Giants @ Cincinnati Reds**  
Crosley Field, Cincinnati, OH

Tue Jul 18 1950, 3:33 AM EDT  
Att. 2,967 - Unknown

livebaseballscorecards.com

|            |           |
|------------|-----------|
| <b>AB</b>  | <b>26</b> |
| <b>R</b>   | <b>1</b>  |
| <b>H</b>   | <b>2</b>  |
| <b>RBI</b> | <b>1</b>  |
| <b>BB</b>  | <b>6</b>  |
| <b>SO</b>  | <b>4</b>  |
| <b>LOB</b> | <b>10</b> |



|       |        |       |        |
|-------|--------|-------|--------|
| 1B: 1 | SF: 0  | WP: 0 | PA: 32 |
| 2B: 0 | SAC: 0 | PB: 0 |        |
| 3B: 0 | DP: 0  | SB: 0 |        |
| HR: 1 | HBP: 0 | CS: 0 |        |

| Batter  | 1  | 2                               | 3                            | 4                               | 5                            | 6                               | 7                             | 8                                | 9                             | AB R H RBI BB SO LOB             | TOP                          |  |                              |                                  |                              |                                 |                              |                                 |                                  |                                    |                                  |        |
|---|--|---------------------------------|------------------------------|---------------------------------|------------------------------|---------------------------------|-------------------------------|----------------------------------|-------------------------------|----------------------------------|------------------------------|--|------------------------------|----------------------------------|------------------------------|---------------------------------|------------------------------|---------------------------------|----------------------------------|------------------------------------|----------------------------------|--------|
| <b>Bobby Morgan, R</b> (1, 5)<br>OBP: 0.346, SLG: 0.394                                   | 0-0<br>2B  |                                 | 0-2<br>F9                    |                                 | 0-0<br>F4                    |                                 | 1-0<br>5-3                    |                                  |                               | 4 0 1 0 0 0 3                    |                              |  |                              |                                  |                              |                                 |                              |                                 |                                  |                                    |                                  |        |
| <b>Jim Russell, S</b> (1, 7)<br>OBP: 0.349, SLG: 0.481                                    | 0-1<br>F8  |                                 | 0-1<br>F3                    |                                 | 1-1<br>1B<br>1-2 2-H         |                                 |                               | 0-1<br>F2                        |                               | 4 0 1 1 0 0 2                    |                              |  |                              |                                  |                              |                                 |                              |                                 |                                  |                                    |                                  |        |
| <b>Duke Snider, L</b> (1, 8)<br>OBP: 0.367, SLG: 0.547                                    | 0-3<br>K   |                                 | 0-0<br>FC6-4<br>1-2f         |                                 | 0-2<br>F7                    |                                 |                               | 0-1<br>F6                        |                               | 4 0 0 0 0 1 4                    |                              |  |                              |                                  |                              |                                 |                              |                                 |                                  |                                    |                                  |        |
| <b>Jackie Robinson, R</b> (1, 4)<br>OBP: 0.444, SLG: 0.555                                | 0-2<br>F5  |                                 |                              | 1-2<br>L4                       | 0-0<br>F7                    |                                 |                               | 1-1<br>F7                        |                               | 4 0 0 0 0 0 3                    |                              |  |                              |                                  |                              |                                 |                              |                                 |                                  |                                    |                                  |        |
| <b>Carl Furillo, R</b> (1, 9)<br>OBP: 0.357, SLG: 0.486                                   |  | 0-0<br>2B                       |                              | 1-2<br>F5                       |                              | 0-0<br>F5                       |                               |                                  | 0-0<br>5-3                    | 4 0 1 0 0 0 0                    |                              |  |                              |                                  |                              |                                 |                              |                                 |                                  |                                    |                                  |        |
| <b>Gil Hodges, R</b> (1, 3)<br><b>Erv Palica, R</b> (9, PR)<br>OBP: 0.278, SLG: 0.389     |  | 0-3<br>K                        |                              | 0-2<br>FC6-4<br>1B              |                              | 2-0<br>F7                       |                               |                                  | 1-1<br>1B                     | 4 0 2 0 0 1 1<br>0 0 0 0 0 0 0   |                              |  |                              |                                  |                              |                                 |                              |                                 |                                  |                                    |                                  |        |
| <b>Roy Campanella, R</b> (1, 2)<br>OBP: 0.384, SLG: 0.585                                 |  | 0-0<br>F5                       |                              | 1-2<br>FC6-4<br>1-2f            |                              | 2-3<br>K                        |                               |                                  | 0-0<br>F5                     | 4 0 0 0 0 1 3                    |                              |  |                              |                                  |                              |                                 |                              |                                 |                                  |                                    |                                  |        |
| <b>Pee Wee Reese, R</b> (1, 6)<br><b>Tommy Brown, R</b> (9, PH)<br>OBP: 0.286, SLG: 0.550 |  | 0-1<br>F7                       |                              |                                 | 0-2<br>1B<br>1B              |                                 |                               |                                  | 0-0<br>F6                     | 3 1 1 0 0 1 1<br>1 0 0 0 0 0 1   |                              |  |                              |                                  |                              |                                 |                              |                                 |                                  |                                    |                                  |        |
| <b>Don Newcombe, L</b> (1, 1)<br>OBP: 0.354, SLG: 0.386                                   |  |                                 | 0-0<br>FC6-4<br>1B           |                                 | 0-1<br>1B<br>1B              |                                 |                               |                                  | 2-1<br>L6                     | 3 0 2 0 0 0 0                    |                              |  |                              |                                  |                              |                                 |                              |                                 |                                  |                                    |                                  |        |
| <b>Inning Stats</b>   | R: 0<br>E: 0<br>K: 1<br>S: 9   | H: 1<br>LOB: 1<br>BB: 0<br>P: 9 | R: 0<br>E: 0<br>K: 1<br>S: 8 | H: 1<br>LOB: 1<br>BB: 0<br>P: 8 | R: 0<br>E: 0<br>K: 0<br>S: 7 | H: 1<br>LOB: 1<br>BB: 0<br>P: 7 | R: 0<br>E: 0<br>K: 0<br>S: 13 | H: 1<br>LOB: 1<br>BB: 0<br>P: 16 | R: 1<br>E: 0<br>K: 0<br>S: 12 | H: 3<br>LOB: 2<br>BB: 0<br>P: 13 | R: 0<br>E: 0<br>K: 1<br>S: 5 | H: 0<br>LOB: 0<br>BB: 0<br>P: 9  | R: 0<br>E: 0<br>K: 1<br>S: 7 | H: 0<br>LOB: 0<br>BB: 0<br>P: 11 | R: 0<br>E: 0<br>K: 0<br>S: 6 | H: 0<br>LOB: 0<br>BB: 0<br>P: 7 | R: 0<br>E: 0<br>K: 0<br>S: 5 | H: 1<br>LOB: 1<br>BB: 0<br>P: 6 | 1B: 6<br>2B: 2<br>3B: 0<br>HR: 0 | SF: 0<br>SAC: 0<br>DP: 0<br>HBP: 0 | WP: 0<br>PB: 0<br>SB: 0<br>CS: 0 | PA: 35 |
| <b>PITCHER</b><br><b>Ken Raffensberger, L</b> (1, 1)<br>ERA: 3.9                          | IP: 9.0<br>WLS: W<br>BF: 35<br>H: 8<br>R: 1<br>ER: 1<br>SO: 4<br>BB: 0<br>IBB: 0<br>HBP: 0<br>BLK: 0<br>WP: 0<br>HR: 0<br>S: 72<br>P: 86<br>ERA: 1.00<br>WHIP: 0.889 |                                 |                              |                                 |                              |                                 |                               |                                  |                               |                                  |                              | <b>PITCHER</b><br>IP: WLS: BF: H: R: ER: SO: BB: IBB: HBP: BLK: WP: HR: S: P: ERA: WHIP: |                              |                                  |                              |                                 |                              |                                 |                                  |                                    |                                  |        |

**Brooklyn Dodgers @ Cincinnati Reds**  
Crosley Field, Cincinnati, OH  
Thu Jul 20 1950, 3:33 AM EDT  
Unknown

livebaseballscorecards.com

|     |    |
|-----|----|
| AB  | 35 |
| R   | 1  |
| H   | 8  |
| RBI | 1  |
| BB  | 0  |
| SO  | 4  |
| LOB | 18 |





| Batter   | 1   | 2                                | 3                             | 4                                | 5                             | 6                                | 7                            | 8                               | 9                            | AB R H RBI BB SO LOB                            | TOP   |                                 |                              |                                  |                               |                                  |                                  |                                    |                                  |        |
|--|---|----------------------------------|-------------------------------|----------------------------------|-------------------------------|----------------------------------|------------------------------|---------------------------------|------------------------------|---|---|---------------------------------|------------------------------|----------------------------------|-------------------------------|----------------------------------|----------------------------------|------------------------------------|----------------------------------|--------|
| <b>Bobby Morgan, R</b> (1, 5)<br>OBP: 0.346, SLG: 0.392<br><b>Cal Abrams, L</b> (8, PH)<br><b>Eddie Miksis, R</b> (8, 5)<br>OBP: 0.224, SLG: 0.255 | 3-2<br>5-3<br>①   |                                  | 3-2<br>1B<br>1B               |                                  | 2-3<br>K                      |                                  |                              | 0-3<br>K                        |                              | 3 1 1 0 0 1 0<br>1 0 0 0 0 1 0<br>0 0 0 0 0 0 0 | <b>Brooklyn Dodgers @ Cincinnati Reds</b><br>Crosley Field, Cincinnati, OH<br>Thu Jul 20 1950, 3:38 AM EDT<br>Att. 18,334 - Unknown |                                 |                              |                                  |                               |                                  |                                  |                                    |                                  |        |
| <b>Gene Hermanski, L</b> (1, 7)<br>OBP: 0.396, SLG: 0.504  | 0-0<br>F7<br>②  |                                  | 1-2<br>1B<br>1B               |                                  | 3-1<br>4-3<br>②               |                                  |                              | 1-0<br>F8<br>②                  |                              | 4 1 1 0 0 0 0                                   |   |                                 |                              |                                  |                               |                                  |                                  |                                    |                                  |        |
| <b>Duke Snider, L</b> (1, 8)<br>OBP: 0.368, SLG: 0.547   | 2-3<br>K  |                                  | 1-2<br>1B<br>1-2<br>2-H<br>1B |                                  | 2-3<br>K                      |                                  |                              | 0-1<br>1B                       |                              | 4 0 2 1 0 2 0                                   |   |                                 |                              |                                  |                               |                                  |                                  |                                    |                                  |        |
| <b>Jackie Robinson, R</b> (1, 4)<br>OBP: 0.444, SLG: 0.554   |   | 0-0<br>1B                        | 3-2<br>1B<br>1-3<br>2-H<br>1B |                                  | 1-0<br>1-3                    |                                  |                              | 1-3<br>K                        |                              | 4 0 2 1 0 1 1                                   |   |                                 |                              |                                  |                               |                                  |                                  |                                    |                                  |        |
| <b>Carl Furillo, R</b> (1, 9)<br>OBP: 0.352, SLG: 0.480  |   | 2-3<br>K                         | 0-0<br>6-3<br>③               |                                  | 3-1<br>F8<br>②                |                                  |                              | 0-0<br>1-3                      |                              | 4 0 0 0 0 1 3                                   |   |                                 |                              |                                  |                               |                                  |                                  |                                    |                                  |        |
| <b>Gil Hodges, R</b> (1, 3)<br><b>Erv Palica, R</b> (9, PR)<br>OBP: 0.278, SLG: 0.389  |   | 0-0<br>F7<br>②                   |                               | 0-3<br>K                         |                               | 2-3<br>K                         |                              | 0-2<br>E5                       |                              | 4 0 0 0 0 2 1<br>0 0 0 0 0 0 0                  |   |                                 |                              |                                  |                               |                                  |                                  |                                    |                                  |        |
| <b>Bruce Edwards, R</b> (1, 2)<br>OBP: 0.169, SLG: 0.338   |   | 1-1<br>F7<br>③                   |                               | 0-0<br>F9<br>②                   |                               | 0-0<br>F5<br>①                   |                              | 2-2<br>F4<br>②                  |                              | 4 0 0 0 0 0 2                                   |   |                                 |                              |                                  |                               |                                  |                                  |                                    |                                  |        |
| <b>Pee Wee Reese, R</b> (1, 6)<br>OBP: 0.346, SLG: 0.313   |   |                                  | 0-0<br>4-3<br>①               | 2-0<br>1B                        |                               | 1-1<br>5-3<br>②                  |                              | 1-3<br>K                        |                              | 4 0 1 0 0 1 1                                   |   |                                 |                              |                                  |                               |                                  |                                  |                                    |                                  |        |
| <b>Chris Van Cuyk, L</b> (1, 1)<br><b>Joe Landrum, R</b> (7, 1)<br><b>Ralph Branca, R</b> (7, 1)<br>OBP: 0.158, SLG: 0.235                         |   |                                  | 1-1<br>6-3<br>②               | 0-0<br>G1<br>③                   |                               | 0-1<br>1-3<br>③                  |                              |                                 |                              | 3 0 0 0 0 0 1<br>0 0 0 0 0 0 0<br>0 0 0 0 0 0 0 |   |                                 |                              |                                  |                               |                                  |                                  |                                    |                                  |        |
| <b>Inning Stats</b>  | R: 0<br>E: 0<br>K: 1<br>S: 9  | H: 0<br>LOB: 0<br>BB: 0<br>P: 14 | R: 0<br>E: 0<br>K: 1<br>S: 7  | H: 1<br>LOB: 1<br>BB: 0<br>P: 10 | R: 2<br>E: 0<br>K: 0<br>S: 18 | H: 4<br>LOB: 2<br>BB: 0<br>P: 27 | R: 0<br>E: 0<br>K: 1<br>S: 6 | H: 1<br>LOB: 1<br>BB: 0<br>P: 8 | R: 0<br>E: 0<br>K: 2<br>S: 8 | H: 0<br>LOB: 0<br>BB: 0<br>P: 15                | R: 0<br>E: 0<br>K: 0<br>S: 5  | H: 0<br>LOB: 0<br>BB: 0<br>P: 6 | R: 0<br>E: 0<br>K: 2<br>S: 9 | H: 1<br>LOB: 1<br>BB: 0<br>P: 11 | R: 0<br>E: 1<br>K: 1<br>S: 11 | H: 0<br>LOB: 1<br>BB: 0<br>P: 14 | 1B: 7<br>2B: 0<br>3B: 0<br>HR: 0 | SF: 0<br>SAC: 0<br>DP: 0<br>HBP: 0 | WP: 0<br>PB: 0<br>SB: 0<br>CS: 0 | PA: 35 |
| <b>PITCHER</b><br><b>Ewell Blackwell, R</b> (1, 1)<br>ERA: 3.62  | IP: 9.0<br>WLS: W<br>BF: 35<br>H: 7<br>R: 2<br>ER: 2<br>SO: 9<br>BB: 0<br>IBB: 0<br>HBP: 0<br>BLK: 0<br>WP: 0<br>HR: 0<br>S: 79<br>P: 117<br>ERA: 2.00<br>WHIP: 0.778 |                                  |                               |                                  |                               |                                  |                              |                                 |                              |   |   |                                 |                              |                                  |                               |                                  |                                  |                                    |                                  |        |

livebaseballscorecards.com

|            |           |
|------------|-----------|
| <b>AB</b>  | <b>35</b> |
| <b>R</b>   | <b>2</b>  |
| <b>H</b>   | <b>7</b>  |
| <b>RBI</b> | <b>2</b>  |
| <b>BB</b>  | <b>0</b>  |
| <b>SO</b>  | <b>9</b>  |
| <b>LOB</b> | <b>9</b>  |





| Batter   | 1   | 2                                | 3                            | 4                                | 5                            | 6                                | 7                            | 8                                | 9                             | AB R H RBI BB SO LOB             | TOP                          |                                 |                               |                                  |                              |                                  |                               |                                  |                                  |                                    |                                  |        |
|--|---|----------------------------------|------------------------------|----------------------------------|------------------------------|----------------------------------|------------------------------|----------------------------------|-------------------------------|----------------------------------|------------------------------|---------------------------------|-------------------------------|----------------------------------|------------------------------|----------------------------------|-------------------------------|----------------------------------|----------------------------------|------------------------------------|----------------------------------|--------|
| <b>Bobby Morgan, R</b> (1, 5)<br>OBP: 0.360, SLG: 0.425    | 1-3<br>   |                                  | 1-1<br>                      |                                  | 0-0<br>                      |                                  | 4-2<br>                      |                                  | 0-0<br>                       | 4 3 3 1 1 1 0                    |                              |                                 |                               |                                  |                              |                                  |                               |                                  |                                  |                                    |                                  |        |
| <b>Gene Hermanski, L</b> (1, 7)<br>OBP: 0.391, SLG: 0.492  | 2-2<br>   |                                  | 0-0<br>                      |                                  | 3-2<br>                      |                                  | 1-0<br>                      |                                  | 4-1<br>                       | 3 1 0 0 1 0 3                    |                              |                                 |                               |                                  |                              |                                  |                               |                                  |                                  |                                    |                                  |        |
| <b>Duke Snider, L</b> (1, 8)<br>OBP: 0.367, SLG: 0.542     | 0-0<br>   |                                  |                              |                                  | 4-0<br>                      |                                  | 1-1<br>                      |                                  | 0-0<br>                       | 3 0 0 0 1 0 1                    |                              |                                 |                               |                                  |                              |                                  |                               |                                  |                                  |                                    |                                  |        |
| <b>Jackie Robinson, R</b> (1, 4)<br>OBP: 0.447, SLG: 0.557 |   | 2-0<br>                          |                              | 4-2<br>                          | 1-1<br>                      |                                  | 2-2<br>                      |                                  | 1-0<br>                       | 4 2 2 2 1 0 2                    |                              |                                 |                               |                                  |                              |                                  |                               |                                  |                                  |                                    |                                  |        |
| <b>Carl Furillo, R</b> (1, 9)<br>OBP: 0.353, SLG: 0.479    |   | 2-2<br>                          |                              | 0-0<br>                          | 0-1<br>                      |                                  | 2-1<br>                      |                                  | 3-2<br>                       | 5 0 2 2 0 0 2                    |                              |                                 |                               |                                  |                              |                                  |                               |                                  |                                  |                                    |                                  |        |
| <b>Gil Hodges, R</b> (1, 3)<br>OBP: 0.388, SLG: 0.486      |   | 1-0<br>                          |                              | 4-0<br>                          | 2-1<br>                      |                                  |                              | 2-2<br>                          | 3-2<br>                       | 4 1 0 0 1 0 3                    |                              |                                 |                               |                                  |                              |                                  |                               |                                  |                                  |                                    |                                  |        |
| <b>Roy Campanella, R</b> (1, 2)<br>OBP: 0.382, SLG: 0.580  |   |                                  | 0-0<br>                      | 1-0<br>                          |                              | 1-3<br>                          |                              | 0-0<br>                          |                               | 4 0 1 1 0 1 0                    |                              |                                 |                               |                                  |                              |                                  |                               |                                  |                                  |                                    |                                  |        |
| <b>Pee Wee Reese, R</b> (1, 6)<br>OBP: 0.348, SLG: 0.316   |   |                                  | 0-1<br>                      | 3-1<br>                          |                              | 0-3<br>                          |                              | 2-1<br>                          |                               | 4 0 2 1 0 1 0                    |                              |                                 |                               |                                  |                              |                                  |                               |                                  |                                  |                                    |                                  |        |
| <b>Preacher Roe, R</b> (1, 1)<br>OBP: 0.164, SLG: 0.167    |   |                                  | 1-3<br>                      | 2-1<br>                          |                              | 1-0<br>                          |                              |                                  | 0-3<br>                       | 4 0 0 0 0 2 3                    |                              |                                 |                               |                                  |                              |                                  |                               |                                  |                                  |                                    |                                  |        |
| <b>Inning Stats</b>  | R: 0<br>E: 0<br>K: 1<br>S: 9                          | H: 0<br>LOB: 0<br>BB: 0<br>P: 12 | R: 0<br>E: 0<br>K: 0<br>S: 5 | H: 0<br>LOB: 0<br>BB: 0<br>P: 10 | R: 0<br>E: 0<br>K: 1<br>S: 9 | H: 2<br>LOB: 2<br>BB: 0<br>P: 11 | R: 2<br>E: 0<br>K: 0<br>S: 9 | H: 2<br>LOB: 2<br>BB: 2<br>P: 23 | R: 1<br>E: 0<br>K: 0<br>S: 10 | H: 2<br>LOB: 2<br>BB: 1<br>P: 20 | R: 0<br>E: 0<br>K: 2<br>S: 7 | H: 0<br>LOB: 0<br>BB: 0<br>P: 9 | R: 1<br>E: 0<br>K: 0<br>S: 12 | H: 1<br>LOB: 1<br>BB: 1<br>P: 22 | R: 0<br>E: 0<br>K: 0<br>S: 8 | H: 0<br>LOB: 0<br>BB: 0<br>P: 12 | R: 3<br>E: 0<br>K: 1<br>S: 14 | H: 3<br>LOB: 1<br>BB: 1<br>P: 25 | 1B: 8<br>2B: 1<br>3B: 0<br>HR: 1 | SF: 0<br>SAC: 2<br>DP: 0<br>HBP: 0 | WP: 0<br>PB: 0<br>SB: 1<br>CS: 0 | PA: 42 |
| <b>PITCHER</b>   | IP WLS BF H R ER SO BB IBB HBP BLK WP HR S P ERA WHIP |                                  |                              |                                  |                              |                                  |                              |                                  |                               |                                  |                              |                                 |                               |                                  |                              |                                  |                               |                                  |                                  |                                    |                                  |        |
| <b>Herm Wehmeier, R</b> (1, 1)<br>ERA: 5.92                | 8.0 L 35 7 4 4 4 4 4 0 0 0 0 0 0 69 119 4.50 1.375    |                                  |                              |                                  |                              |                                  |                              |                                  |                               |                                  |                              |                                 |                               |                                  |                              |                                  |                               |                                  |                                  |                                    |                                  |        |
| <b>Harry Perkowski, L</b> (9, 1)<br>ERA: 4.74              | 0.2 6 3 3 3 1 1 0 0 0 0 0 1 10 18 40.50 6.000         |                                  |                              |                                  |                              |                                  |                              |                                  |                               |                                  |                              |                                 |                               |                                  |                              |                                  |                               |                                  |                                  |                                    |                                  |        |
| <b>Johnny Hetki, R</b> (9, 1)<br>ERA: 4.98                 | 0.1 1 0 0 0 0 0 0 0 0 0 0 0 0 4 7 0.00 0.000          |                                  |                              |                                  |                              |                                  |                              |                                  |                               |                                  |                              |                                 |                               |                                  |                              |                                  |                               |                                  |                                  |                                    |                                  |        |

**Brooklyn Dodgers @ Cincinnati Reds**  
Crosley Field, Cincinnati, OH

Fri Jul 21 1950, 3:33 AM EDT  
Att. 4,415 - Unknown

[livebaseballscorecards.com](http://livebaseballscorecards.com)

**AB 35**  
**R 7**  
**H 10**  
**RBI 7**  
**BB 5**  
**SO 5**  
**LOB 14**



| Batter  | 1                            | 2                                | 3                             | 4                                | 5                             | 6                                | 7                             | 8                                | 9                                  | AB                              | R                            | H                                | RBI                          | BB                               | SO                            | LOB                              |                               |                                  |                                  |                                    |                                  |        |
|---|------------------------------|----------------------------------|-------------------------------|----------------------------------|-------------------------------|----------------------------------|-------------------------------|----------------------------------|------------------------------------|---------------------------------|------------------------------|----------------------------------|------------------------------|----------------------------------|-------------------------------|----------------------------------|-------------------------------|----------------------------------|----------------------------------|------------------------------------|----------------------------------|--------|
| <b>Bobby Adams, R</b><br>OBP: 0.330, SLG: 0.330<br>(1, 5)       | 0-0<br>F7                    |                                  | 1-2<br>F9                     |                                  |                               | 2-1<br>G1-4-3<br>1B              |                               | 0-1<br>1-3<br>2B                 |                                    | 4                               | 0                            | 2                                | 0                            | 0                                | 0                             | 1                                |                               |                                  |                                  |                                    |                                  |        |
| <b>Connie Ryan, R</b><br>OBP: 0.379, SLG: 0.385<br>(1, 4)       | 2-2<br>F4                    |                                  |                               | 0-1<br>B5-3                      |                               | 3-2<br>F7                        |                               | 0-0<br>F7                        |                                    | 4                               | 0                            | 0                                | 0                            | 0                                | 0                             | 3                                |                               |                                  |                                  |                                    |                                  |        |
| <b>Danny Litwhiler, R</b><br>OBP: 0.411, SLG: 0.486<br>(1, 9)   | 1-1<br>F8                    |                                  |                               | 0-0<br>HR                        |                               | 1-1<br>G1-4-3<br>1-2f            |                               |                                  | 0-1<br>FC5-4<br>1B                 | 4                               | 1                            | 2                                | 1                            | 0                                | 0                             | 1                                |                               |                                  |                                  |                                    |                                  |        |
| <b>Ted Kluszewski, L</b><br>OBP: 0.361, SLG: 0.587<br>(1, 3)    |                              | 3-2<br>6-3                       |                               | 2-1<br>6-3                       |                               | 1-2<br>4-3                       |                               |                                  | 1-2<br>FC5-4<br>1B                 | 4                               | 0                            | 1                                | 0                            | 0                                | 0                             | 0                                |                               |                                  |                                  |                                    |                                  |        |
| <b>Bob Usher, R</b><br>OBP: 0.333, SLG: 0.392<br>(1, 8)         |                              | 1-2<br>F8                        |                               | 0-1<br>2B                        |                               | 1-1<br>F3                        |                               |                                  | 2-2<br>FC5-4<br>1-3<br>1-2f<br>2-3 | 4                               | 0                            | 1                                | 0                            | 0                                | 0                             | 2                                |                               |                                  |                                  |                                    |                                  |        |
| <b>Joe Adcock, R</b><br>OBP: 0.305, SLG: 0.393<br>(1, 7)        |                              | 0-0<br>5-3                       |                               | 0-0<br>6-3                       |                               | 1-1<br>F7                        |                               |                                  | 1-2<br>1-3                         | 4                               | 0                            | 0                                | 0                            | 0                                | 0                             | 3                                |                               |                                  |                                  |                                    |                                  |        |
| <b>Dixie Howell, R</b><br>OBP: 0.321, SLG: 0.278<br>(1, 2)      |                              |                                  | 2-2<br>4-3<br>1B              |                                  | 1-2<br>5-3                    |                                  | 1-2<br>FC6-4<br>1B            |                                  | 3-2<br>L7                          | 4                               | 0                            | 2                                | 0                            | 0                                | 0                             | 2                                |                               |                                  |                                  |                                    |                                  |        |
| <b>Virgil Stallcup, R</b><br>OBP: 0.295, SLG: 0.379<br>(1, 6)   |                              |                                  | 0-0<br>4-3                    |                                  | 0-0<br>5-3                    |                                  | 0-1<br>FC6-4<br>FC4-6<br>1-2f |                                  |                                    | 3                               | 0                            | 0                                | 0                            | 0                                | 0                             | 2                                |                               |                                  |                                  |                                    |                                  |        |
| <b>Herm Wehmeier, R</b><br>OBP: 0.207, SLG: 0.246<br>(1, 1)     |                              |                                  | 0-0<br>F8                     |                                  | 1-0<br>F7                     |                                  | 0-1<br>FC4-6<br>2B<br>1-2f    |                                  |                                    | 2                               | 0                            | 0                                | 0                            | 0                                | 0                             | 1                                |                               |                                  |                                  |                                    |                                  |        |
| <b>Peanuts Lowrey, R</b><br>OBP: 0.322, SLG: 0.298<br>(8, PH)   |                              |                                  |                               |                                  |                               |                                  |                               |                                  |                                    | 1                               | 0                            | 0                                | 0                            | 0                                | 0                             | 1                                |                               |                                  |                                  |                                    |                                  |        |
| <b>Harry Perkowski, L</b><br>OBP: 0.412, SLG: 0.375<br>(9, 1)   |                              |                                  |                               |                                  |                               |                                  |                               |                                  |                                    | 0                               | 0                            | 0                                | 0                            | 0                                | 0                             | 0                                |                               |                                  |                                  |                                    |                                  |        |
| <b>Johnny Hetki, R</b><br>OBP: 0.250, SLG: 0.143<br>(9, 1)      |                              |                                  |                               |                                  |                               |                                  |                               |                                  |                                    | 0                               | 0                            | 0                                | 0                            | 0                                | 0                             | 0                                |                               |                                  |                                  |                                    |                                  |        |
| <b>Inning Stats</b>   | R: 0<br>E: 0<br>K: 0<br>S: 8 | H: 0<br>LOB: 0<br>BB: 0<br>P: 11 | R: 0<br>E: 0<br>K: 0<br>S: 10 | H: 0<br>LOB: 0<br>BB: 0<br>P: 14 | R: 0<br>E: 0<br>K: 0<br>S: 10 | H: 1<br>LOB: 1<br>BB: 0<br>P: 13 | R: 1<br>E: 0<br>K: 0<br>S: 8  | H: 2<br>LOB: 1<br>BB: 0<br>P: 10 | R: 0<br>E: 0<br>K: 0<br>S: 7       | H: 0<br>LOB: 0<br>BB: 0<br>P: 9 | R: 0<br>E: 0<br>K: 0<br>S: 7 | H: 1<br>LOB: 0<br>BB: 0<br>P: 13 | R: 0<br>E: 0<br>K: 0<br>S: 7 | H: 0<br>LOB: 0<br>BB: 0<br>P: 11 | R: 0<br>E: 0<br>K: 0<br>S: 12 | H: 2<br>LOB: 2<br>BB: 0<br>P: 13 | R: 0<br>E: 0<br>K: 0<br>S: 15 | H: 2<br>LOB: 2<br>BB: 0<br>P: 22 | 1B: 5<br>2B: 2<br>3B: 0<br>HR: 1 | SF: 0<br>SAC: 0<br>DP: 1<br>HBP: 0 | WP: 0<br>PB: 0<br>SB: 0<br>CS: 0 | PA: 34 |
| <b>PITCHER</b><br><b>Preacher Roe, L</b><br>ERA: 2.95<br>(1, 1) | IP<br>9.0                    | WLS<br>W                         | BF<br>34                      | H<br>8                           | R<br>1                        | ER<br>1                          | SO<br>0                       | BB<br>0                          | IBB<br>0                           | HBP<br>0                        | BLK<br>0                     | WP<br>0                          | HR<br>1                      | S<br>85                          | P<br>116                      | ERA<br>1.00                      | WHIP<br>0.889                 |                                  |                                  |                                    |                                  |        |

**BOTTOM**

**Brooklyn Dodgers @ Cincinnati Reds**  
Crosley Field, Cincinnati, OH  
Fri Jul 21 1950, 3:33 AM EDT  
Att. 4,415 - Unknown

|     |    |
|-----|----|
| AB  | 34 |
| R   | 1  |
| H   | 8  |
| RBI | 1  |
| BB  | 0  |
| SO  | 0  |
| LOB | 16 |



|       |        |
|-------|--------|
| WP: 0 | PA: 34 |
| PB: 0 |        |
| SB: 0 |        |
| CS: 0 |        |

|     |      |  |  |  |
|-----|------|--|--|--|
| ERA | WHIP |  |  |  |
|-----|------|--|--|--|

livebaseballscores.com

| Batter   | 1   | 2   | 3   | 4   | 5   | 6   | 7   | 8   | 9   | AB R H RBI BB SO LOB                                       | TOP  |   |
|--|---|---|---|---|---|---|---|---|---|--|--|---|
| Eddie Waitkus, L (1, 3)<br>OBP: 0.324, SLG: 0.349  | 0-0<br>F8   |   | 0-0<br>F7   |   |   | 0-0<br>3-1  |   | 0-0<br>G4-6-3                                       |   | 4 0 0 0 0 0 2  | <b>Philadelphia Phillies @ Cincinnati Reds</b><br>Crosley Field, Cincinnati, OH<br>Sat Jul 22 1950, 3:33 AM EDT<br>Unknown<br><a href="http://livebaseballscorecards.com">livebaseballscorecards.com</a> |   |
| Richie Ashburn, L (1, 8)<br>OBP: 0.386, SLG: 0.409   | 0-3<br>K  |   | 0-3<br>K  |   |   | 0-0<br>4-3  |   | 0-0<br>1B   |   | 4 0 1 0 0 2 1  |  |   |
| Dick Sisler, L (1, 7)<br>OBP: 0.417, SLG: 0.517  | 0-0<br>4-3  |   |   |   | 0-0<br>F9   |   | 0-0<br>F8   |   | 0-0<br>F8   | 4 0 0 0 0 0 1  |  |   |
| Del Ennis, R (1, 9)<br>OBP: 0.343, SLG: 0.509  |   | 0-0<br>6-3  |   |   | 0-0<br>F9   |   | 0-0<br>E WP L7 1B                                   |   | 0-0<br>F7   | 4 1 1 0 0 0 0  |  |   |
| Willie Jones, R (1, 5)<br>OBP: 0.380, SLG: 0.569   |   | 0-0<br>5-3  |   | 4-0<br>FC5-4 BB                                     |   | 0-0<br>F2   |   | 0-3<br>K  |   | 3 0 0 0 1 1 1  |  |   |
| Granny Hamner, R (1, 6)<br>OBP: 0.317, SLG: 0.383  |   | 0-0<br>F2   |   | 0-0<br>FC5-4  |   | 0-0<br>E5   |   | 0-0<br>F6   |   | 4 0 0 0 0 0 2  |  |   |
| Andy Seminick, R (1, 2)<br>OBP: 0.441, SLG: 0.574  |   |   | 0-0<br>E F7 1B                                      |   | 0-0<br>F7   |   | 0-0<br>L7   |   |   | 3 1 1 1 0 0 1  |  |   |
| Stan Lopata, R (7, 2)<br>OBP: 0.324, SLG: 0.226  |   |   |   |   |   | 0-0<br>F3   |   | 0-0<br>4-3  |   | 0 0 0 0 0 0 0  |  |   |
| Mike Goliat, R (1, 4)<br>OBP: 0.306, SLG: 0.368  |   |   | 0-0<br>E9 PB 1B                                     |   | 0-0<br>F7   |   | 0-0<br>3-H  |   |   | 3 0 1 0 0 0 1  |  |   |
| Robin Roberts, S (1, 1)<br>OBP: 0.143, SLG: 0.069  |   |   | 0-0<br>F7   |   | 0-0<br>6-3  |   |   | 0-0<br>G4-6-3 1B                                    |   | 3 0 1 1 0 0 1  |  |   |
| <b>Inning Stats</b>  | R: 0 H: 0<br>E: 0 LOB: 0<br>K: 1 BB: 0<br>S: 5 P: 5   | R: 0 H: 0<br>E: 0 LOB: 0<br>K: 0 BB: 0<br>S: 3 P: 3 | R: 1 H: 2<br>E: 1 LOB: 1<br>K: 1 BB: 0<br>S: 7 P: 7 | R: 0 H: 0<br>E: 0 LOB: 1<br>K: 0 BB: 1<br>S: 3 P: 7 | R: 0 H: 0<br>E: 0 LOB: 0<br>K: 0 BB: 0<br>S: 3 P: 3 | R: 0 H: 0<br>E: 0 LOB: 0<br>K: 0 BB: 0<br>S: 3 P: 3 | R: 1 H: 1<br>E: 1 LOB: 1<br>K: 0 BB: 0<br>S: 5 P: 5 | R: 0 H: 2<br>E: 0 LOB: 1<br>K: 0 BB: 0<br>S: 4 P: 4 | R: 0 H: 0<br>E: 0 LOB: 0<br>K: 1 BB: 0<br>S: 5 P: 5 | 1B: 5 SF: 0<br>2B: 0 SAC: 0<br>3B: 0 DP: 1<br>HR: 0 HBP: 0 | WP: 1 PA: 33<br>PB: 1<br>SB: 1<br>CS: 0  |   |
| <b>PITCHER</b><br>Willie Ramsdell, R (1, 1)<br>ERA: 4.09<br>Frank Smith, R (9, 1)<br>ERA: 3.42 | IP WLS BF H R ER SO BB IBB HBP BLK WP HR S P ERA WHIP |   |   |   |   |   |   |   |   |  |  | <b>PITCHER</b><br>IP WLS BF H R ER SO BB IBB HBP BLK WP HR S P ERA WHIP |
|  | 8.0 L 30 5 2 1 2 1 0 0 0 0 1 0 33 37 1.12 0.750       |   |   |   |   |   |   |   |   |  |  |   |





| Batter   | 1          | 2                     | 3          | 4                     | 5          | 6                   | 7         | 8         | 9         | AB R H RBI BB SO LOB |
|--|------------|-----------------------|------------|-----------------------|------------|---------------------|-----------|-----------|-----------|----------------------|
| Lloyd Merriman, L (1, 8)<br>OBP: 0.321, SLG: 0.366   | 0-0<br>F8  |                       | 0-0<br>4-3 |                       |            | 4-0<br>G4-3<br>BB   |           |           | 0-0<br>F9 | 3 0 0 0 1 0 0        |
| Connie Ryan, R (1, 4)<br>OBP: 0.384, SLG: 0.392      | 0-0<br>2B  |                       |            | 4-0<br>G4-6-3<br>BB   |            | 0-0<br>G4-3<br>1-2f |           |           | 0-0<br>1B | 3 0 2 0 1 0 1        |
| Grady Hatton, L (1, 5)<br>OBP: 0.354, SLG: 0.434     | 0-0<br>F6  |                       |            | 0-0<br>G4-6-3<br>1-2f |            |                     | 0-0<br>F9 |           | 0-0<br>F8 | 4 0 0 0 0 0 3        |
| Ted Kluszewski, L (1, 3)<br>OBP: 0.356, SLG: 0.578   | 0-0<br>6-3 |                       |            | 0-0<br>6-3            |            |                     | 0-0<br>F8 |           | 0-0<br>F5 | 4 0 0 0 0 0 2        |
| Bob Usher, R (1, 9)<br>OBP: 0.333, SLG: 0.397        |            | 0-0<br>FC6-5<br>2B    |            |                       | 0-0<br>6-3 |                     | 0-0<br>F9 |           |           | 3 0 1 0 0 0 0        |
| Joe Adcock, R (1, 7)<br>OBP: 0.298, SLG: 0.383       |            | 0-0<br>FC6-5<br>2-3   |            |                       | 0-0<br>F9  |                     |           | 0-0<br>F8 |           | 3 0 0 0 0 0 1        |
| Johnny Pramesa, R (1, 2)<br>OBP: 0.358, SLG: 0.451   |            | 0-0<br>G6-4-3<br>1-2f |            |                       | 4-0<br>BB  |                     |           | 0-0<br>F8 |           | 2 0 0 0 1 0 1        |
| Virgil Stallcup, R (1, 6)<br>OBP: 0.295, SLG: 0.378  |            |                       | 0-3<br>K   |                       | 0-0<br>G3  |                     |           | 0-0<br>1B |           | 3 0 1 0 0 1 1        |
| Willie Ramsdell, R (1, 1)<br>OBP: 0.242, SLG: 0.167  |            |                       | 0-0<br>F9  |                       |            | 0-3<br>K            |           | 0-3<br>K  |           | 2 0 0 0 0 1 0        |
| Harry Perkowski, L (8, PH)<br>OBP: 0.389, SLG: 0.353 |            |                       |            |                       |            |                     |           |           |           | 1 0 0 0 0 1 1        |
| Frank Smith, R (9, 1)<br>OBP: 0.071, SLG: 0.071      |            |                       |            |                       |            |                     |           |           |           | 0 0 0 0 0 0 0        |

| Inning Stats                                    | R: 0<br>E: 0<br>K: 0<br>S: 4  | H: 1<br>LOB: 1<br>BB: 0<br>P: 4 | R: 0<br>E: 0<br>K: 0<br>S: 3 | H: 1<br>LOB: 0<br>BB: 0<br>P: 3 | R: 0<br>E: 0<br>K: 1<br>S: 5 | H: 0<br>LOB: 0<br>BB: 0<br>P: 5 | R: 0<br>E: 0<br>K: 0<br>S: 2 | H: 0<br>LOB: 0<br>BB: 1<br>P: 6 | R: 0<br>E: 0<br>K: 0<br>S: 3 | H: 0<br>LOB: 1<br>BB: 1<br>P: 7 | R: 0<br>E: 0<br>K: 1<br>S: 4 | H: 0<br>LOB: 0<br>BB: 1<br>P: 8 | R: 0<br>E: 0<br>K: 0<br>S: 3 | H: 0<br>LOB: 0<br>BB: 0<br>P: 3 | R: 0<br>E: 0<br>K: 1<br>S: 6 | H: 1<br>LOB: 1<br>BB: 0<br>P: 6 | R: 0<br>E: 0<br>K: 0<br>S: 4 | H: 1<br>LOB: 1<br>BB: 0<br>P: 4 | 1B: 2<br>2B: 2<br>3B: 0<br>HR: 0 | SF: 0<br>SAC: 0<br>DP: 3<br>HBP: 0 |
|---|---|---------------------------------|------------------------------|---------------------------------|------------------------------|---------------------------------|------------------------------|---------------------------------|------------------------------|---------------------------------|------------------------------|---------------------------------|------------------------------|---------------------------------|------------------------------|---------------------------------|------------------------------|---------------------------------|----------------------------------|------------------------------------|
| PITCHER<br>Robin Roberts, R (1, 1)<br>ERA: 3.27 | IP 9.0<br>WLS W<br>BF 31<br>H 4<br>R 0<br>ER 0<br>SO 3<br>BB 3<br>IBB 0<br>HBP 0<br>BLK 0<br>WP 0<br>HR 0<br>S 34<br>P 46<br>ERA 0.00<br>WHIP 0.778 |                                 |                              |                                 |                              |                                 |                              |                                 |                              |                                 |                              |                                 |                              |                                 |                              |                                 |                              |                                 | WP: 0<br>PB: 0<br>SB: 0<br>CS: 0 | PA: 31<br>ERA<br>WHIP              |

**BOTTOM**

**Philadelphia Phillies @ Cincinnati Reds**  
Crosley Field, Cincinnati, OH  
Sat Jul 22 1950, 3:33 AM EDT  
Unknown

[livebaseballscorecards.com](http://livebaseballscorecards.com)

|            |           |
|------------|-----------|
| <b>AB</b>  | <b>28</b> |
| <b>R</b>   | <b>0</b>  |
| <b>H</b>   | <b>4</b>  |
| <b>RBI</b> | <b>0</b>  |
| <b>BB</b>  | <b>3</b>  |
| <b>SO</b>  | <b>3</b>  |
| <b>LOB</b> | <b>10</b> |



| Batter  | 1  | 2                               | 3                            | 4                               | 5                            | 6                               | 7                            | 8                               | 9                            | AB R H RBI BB SO LOB            | TOP  |                                 |                              |                                 |                              |                                 |                              |                                 |                                  |                                    |                                  |        |
|---|--|---------------------------------|------------------------------|---------------------------------|------------------------------|---------------------------------|------------------------------|---------------------------------|------------------------------|---------------------------------|--|---------------------------------|------------------------------|---------------------------------|------------------------------|---------------------------------|------------------------------|---------------------------------|----------------------------------|------------------------------------|----------------------------------|--------|
| <b>Eddie Waitkus, L</b> (1, 3)<br>OBP: 0.324, SLG: 0.348    | 0-0<br>6-3   |                                 | 0-0<br>1B                    |                                 |                              | 0-0<br>4-3                      |                              | 0-0<br>L7                       |                              | 4 0 1 0 0 0 0                   | <b>Philadelphia Phillies @ Cincinnati Reds</b><br>Crosley Field, Cincinnati, OH<br>Sat Jul 22 1950, 3:38 AM EDT<br>Att. 13,215 - Unknown<br><a href="http://livebaseballscorecards.com">livebaseballscorecards.com</a> |                                 |                              |                                 |                              |                                 |                              |                                 |                                  |                                    |                                  |        |
| <b>Richie Ashburn, L</b> (1, 8)<br>OBP: 0.384, SLG: 0.407   | 0-3<br>K   |                                 | 0-0<br>1-3                   |                                 |                              | 0-0<br>F9                       |                              |                                 | 0-0<br>1B<br>1B              | 4 1 1 0 0 1 2                   |  |                                 |                              |                                 |                              |                                 |                              |                                 |                                  |                                    |                                  |        |
| <b>Dick Sisler, L</b> (1, 7)<br>OBP: 0.418, SLG: 0.517      | 0-0<br>F7  |                                 |                              |                                 |                              | 0-0<br>1B                       |                              |                                 | 0-0<br>1B<br>1B              | 4 0 2 0 0 0 0                   |  |                                 |                              |                                 |                              |                                 |                              |                                 |                                  |                                    |                                  |        |
| <b>Del Ennis, R</b> (1, 9)<br>OBP: 0.342, SLG: 0.506        |  | 0-0<br>P6                       |                              |                                 |                              | 0-0<br>F8                       |                              |                                 | 0-0<br>F9                    | 4 0 1 0 0 0 3                   |  |                                 |                              |                                 |                              |                                 |                              |                                 |                                  |                                    |                                  |        |
| <b>Willie Jones, R</b> (1, 5)<br>OBP: 0.379, SLG: 0.564     |  | 0-0<br>F3                       |                              |                                 |                              |                                 | 4-0<br>G6-4-3<br>BB          |                                 | 0-0<br>L8                    | 3 0 0 0 1 0 3                   |  |                                 |                              |                                 |                              |                                 |                              |                                 |                                  |                                    |                                  |        |
| <b>Granny Hamner, R</b> (1, 6)<br>OBP: 0.319, SLG: 0.387    |  | 0-0<br>5-3                      |                              |                                 |                              |                                 | 0-0<br>F3                    |                                 | 0-0<br>1B<br>1-2<br>2-H      | 4 0 2 1 0 0 1                   |  |                                 |                              |                                 |                              |                                 |                              |                                 |                                  |                                    |                                  |        |
| <b>Stan Lopata, R</b> (1, 2)<br>OBP: 0.313, SLG: 0.216      |  |                                 | 0-0<br>5-3                   |                                 |                              |                                 | 0-0<br>G6-4-3                |                                 | 0-0<br>F8                    | 4 0 0 0 0 1 3                   |  |                                 |                              |                                 |                              |                                 |                              |                                 |                                  |                                    |                                  |        |
| <b>Mike Goliat, R</b> (1, 4)<br>OBP: 0.304, SLG: 0.365      |  |                                 | 0-0<br>P4                    |                                 |                              |                                 |                              |                                 |                              | 2 0 0 0 0 0 0                   |  |                                 |                              |                                 |                              |                                 |                              |                                 |                                  |                                    |                                  |        |
| <b>Dick Whitman, L</b> (8, PH)<br>OBP: 0.328, SLG: 0.314    |  |                                 |                              |                                 |                              |                                 |                              |                                 |                              | 1 0 0 0 0 1 0                   |  |                                 |                              |                                 |                              |                                 |                              |                                 |                                  |                                    |                                  |        |
| <b>Jimmy Bloodworth, R</b> (8, 4)<br>OBP: 0.262, SLG: 0.247 |  |                                 |                              |                                 |                              |                                 |                              |                                 |                              | 0 0 0 0 0 0 0                   |  |                                 |                              |                                 |                              |                                 |                              |                                 |                                  |                                    |                                  |        |
| <b>Ken Heintzelman, R</b> (1, 1)<br>OBP: 0.069, SLG: 0.036  |  |                                 | 4-0<br>1B<br>BB              |                                 |                              |                                 |                              |                                 |                              | 1 0 0 0 1 1 0                   |  |                                 |                              |                                 |                              |                                 |                              |                                 |                                  |                                    |                                  |        |
| <b>Bill Nicholson, L</b> (8, PH)<br>OBP: 0.333, SLG: 0.550  |  |                                 |                              |                                 |                              |                                 |                              |                                 |                              | 1 0 0 0 0 1 0                   |  |                                 |                              |                                 |                              |                                 |                              |                                 |                                  |                                    |                                  |        |
| <b>Milo Candini, R</b> (8, 1)                               |  |                                 |                              |                                 |                              |                                 |                              |                                 |                              | 0 0 0 0 0 0 0                   |  |                                 |                              |                                 |                              |                                 |                              |                                 |                                  |                                    |                                  |        |
| <b>Inning Stats</b>   | R: 0<br>E: 0<br>K: 1<br>S: 5   | H: 0<br>LOB: 0<br>BB: 0<br>P: 5 | R: 0<br>E: 0<br>K: 0<br>S: 3 | H: 0<br>LOB: 0<br>BB: 0<br>P: 3 | R: 0<br>E: 0<br>K: 0<br>S: 4 | H: 1<br>LOB: 2<br>BB: 1<br>P: 8 | R: 0<br>E: 0<br>K: 0<br>S: 4 | H: 2<br>LOB: 2<br>BB: 0<br>P: 4 | R: 0<br>E: 0<br>K: 2<br>S: 7 | H: 0<br>LOB: 0<br>BB: 0<br>P: 7 | R: 0<br>E: 0<br>K: 0<br>S: 4   | H: 1<br>LOB: 1<br>BB: 0<br>P: 4 | R: 0<br>E: 0<br>K: 0<br>S: 2 | H: 0<br>LOB: 0<br>BB: 1<br>P: 6 | R: 0<br>E: 0<br>K: 2<br>S: 7 | H: 0<br>LOB: 0<br>BB: 0<br>P: 7 | R: 1<br>E: 0<br>K: 0<br>S: 6 | H: 3<br>LOB: 2<br>BB: 0<br>P: 6 | 1B: 6<br>2B: 1<br>3B: 0<br>HR: 0 | SF: 0<br>SAC: 0<br>DP: 1<br>HBP: 0 | WP: 0<br>PB: 0<br>SB: 0<br>CS: 0 | PA: 34 |
| <b>PITCHER</b><br><b>Howie Fox, R</b> (1, 1)<br>ERA: 4.73   | IP: 9.0<br>WLS: W<br>BF: 34<br>H: 7<br>R: 1<br>ER: 1<br>SO: 5<br>BB: 2<br>IBB: 0<br>HBP: 0<br>BLK: 0<br>WP: 0<br>HR: 0<br>S: 42<br>P: 50<br>ERA: 1.00<br>WHIP: 1.000 |                                 |                              |                                 |                              |                                 |                              |                                 |                              |                                 |  |                                 |                              |                                 |                              |                                 |                              |                                 |                                  |                                    |                                  |        |
| <b>PITCHER</b>  | IP   | WLS                             | BF                           | H                               | R                            | ER                              | SO                           | BB                              | IBB                          | HBP                             | BLK  | WP                              | HR                           | S                               | P                            | ERA                             | WHIP                         |                                 |                                  |                                    |                                  |        |



| Batter  | 1                     | 2                       | 3         | 4          | 5         | 6                 | 7  | 8          | 9 |
|---|-----------------------|-------------------------|-----------|------------|-----------|-------------------|--|------------|---|
| Bobby Adams, R (1, 5)<br>OBP: 0.333, SLG: 0.344<br>Grady Hatton, L (8, 5)<br>OBP: 0.354, SLG: 0.434       | 0-0<br>G4-6-3<br>1B   |                         | 0-0<br>F9 |            | 0-0<br>F8 |                   | 0-0<br>F7<br>2-H<br>3B                           |            |   |
| Connie Ryan, R (1, 4)<br>OBP: 0.382, SLG: 0.390   | 0-0<br>F3             |                         | 0-0<br>F8 |            |           | 0-0<br>4-3<br>1B  | 0-0<br>F7<br>3-H                                 |            |   |
| Danny Litwhiler, R (1, 9)<br>OBP: 0.394, SLG: 0.461<br>Lloyd Merriman, L (8, 8)<br>OBP: 0.321, SLG: 0.366 | 0-0<br>G4-6-3<br>1-2f |                         | 0-3<br>K  |            |           | 0-0<br>F8         | 0-0<br>5-3                                       |            |   |
| Ted Kluszewski, L (1, 3)<br>OBP: 0.354, SLG: 0.574  |                       | 0-0<br>2B<br>2B<br>1B   |           | 0-0<br>F9  |           | 0-0<br>4-3<br>1-2 |  | 0-0<br>4-3 |   |
| Bob Usher, R (1, 8)<br>OBP: 0.332, SLG: 0.399<br>(8, 9)   |                       | 0-0<br>1-3<br>2B<br>2B  |           | 0-0<br>F9  |           | 0-0<br>F8         |  | 0-0<br>6-3 |   |
| Joe Adcock, R (1, 7)<br>OBP: 0.312, SLG: 0.403  |                       | 0-0<br>2-H<br>3-H<br>2B |           | 0-0<br>6-3 |           |                   | 0-0<br>BB<br>1B<br>1B                            | 0-0<br>1B  |   |
| Dixie Howell, R (1, 2)<br>OBP: 0.319, SLG: 0.271  |                       | 0-0<br>6-3              |           | 0-0<br>6-3 |           | 0-0<br>6-3        | 4-0<br>BB<br>BB<br>BB<br>1B<br>1B<br>SH1-4<br>BB | 0-0<br>F7  |   |
| Virgil Stallcup, R (1, 6)<br>OBP: 0.296, SLG: 0.378   |                       | 0-0<br>6-3              |           | 0-0<br>6-3 |           | 0-0<br>6-3        | 0-0<br>1-3<br>2-H<br>3B<br>1B<br>SH1-4           |            |   |
| Howie Fox, R (1, 1)<br>OBP: 0.229, SLG: 0.343   |                       | 0-0<br>6-3              |           | 0-0<br>1B  |           |                   | 0-0<br>1-2<br>3-H<br>SH1-4                       |            |   |

| Inning Stats                     | R: 0<br>E: 0<br>K: 0<br>S: 3       | H: 1<br>LOB: 0<br>BB: 0<br>P: 3            | R: 2<br>E: 0<br>K: 0<br>S: 6 | H: 3<br>LOB: 1<br>BB: 0<br>P: 6 | R: 0<br>E: 0<br>K: 1<br>S: 5 | H: 0<br>LOB: 0<br>BB: 0<br>P: 5 | R: 0<br>E: 0<br>K: 0<br>S: 3 | H: 0<br>LOB: 0<br>BB: 0<br>P: 3 | R: 0<br>E: 0<br>K: 0<br>S: 4 | H: 1<br>LOB: 1<br>BB: 0<br>P: 4 | R: 0<br>E: 0<br>K: 0<br>S: 4 | H: 1<br>LOB: 1<br>BB: 0<br>P: 4 | R: 4<br>E: 0<br>K: 0<br>S: 6 | H: 3<br>LOB: 0<br>BB: 1<br>P: 10 | R: 0<br>E: 0<br>K: 0<br>S: 4 | H: 1<br>LOB: 1<br>BB: 0<br>P: 4 |
|----------------------------------|------------------------------------|--|------------------------------|---------------------------------|------------------------------|---------------------------------|------------------------------|---------------------------------|------------------------------|---------------------------------|------------------------------|---------------------------------|------------------------------|----------------------------------|------------------------------|---------------------------------|
| 1B: 7<br>2B: 2<br>3B: 1<br>HR: 0 | SF: 0<br>SAC: 1<br>DP: 1<br>HBP: 0 | WP: 0<br>PA: 34<br>PB: 0<br>SB: 0<br>CS: 0 |                              |                                 |                              |                                 |                              |                                 |                              |                                 |                              |                                 |                              |                                  |                              |                                 |

| PITCHER                               | IP  | WLS | BF | H | R | ER | SO | BB | IBB | HBP | BLK | WP | HR | S  | P  | ERA  | WHIP  |
|---------------------------------------|-----|-----|----|---|---|----|----|----|-----|-----|-----|----|----|----|----|------|-------|
| Ken Heintzelman, L (1, 1)<br>ERA: 4.1 | 7.0 | L   | 30 | 9 | 6 | 6  | 1  | 1  | 0   | 0   | 0   | 0  | 0  | 31 | 35 | 7.71 | 1.429 |
| Milo Candini, R (8, 1)<br>ERA: 5.4    | 1.0 |     | 4  | 1 | 0 | 0  | 0  | 0  | 0   | 0   | 0   | 0  | 0  | 4  | 4  | 0.00 | 1.000 |

**BOTTOM**

**Philadelphia Phillies @ Cincinnati Reds**  
Crosley Field, Cincinnati, OH

Sat Jul 22 1950, 3:38 AM EDT  
Att. 13,215 - Unknown

|     |    |
|-----|----|
| AB  | 32 |
| R   | 6  |
| H   | 10 |
| RBI | 6  |
| BB  | 1  |
| SO  | 1  |
| LOB | 10 |



| Batter  | 1                            | 2                               | 3                            | 4                               | 5                            | 6                               | 7                             | 8                                | 9                            | AB                              | R                            | H                               | RBI                          | BB                               | SO                           | LOB                             | TOP                          |                                 |                                  |                                    |                                  |        |  |  |  |  |  |
|---|------------------------------|---------------------------------|------------------------------|---------------------------------|------------------------------|---------------------------------|-------------------------------|----------------------------------|------------------------------|---------------------------------|------------------------------|---------------------------------|------------------------------|----------------------------------|------------------------------|---------------------------------|------------------------------|---------------------------------|----------------------------------|------------------------------------|----------------------------------|--------|--|--|--|--|--|
| Eddie Waitkus, L (1, 3)<br>OBP: 0.323, SLG: 0.346<br>Jimmy Bloodworth, R (8, PH)<br>OBP: 0.260, SLG: 0.245<br>(8, 3)                                      | 0-0<br>E3<br>3B              | 0-0<br>F5                       |                              | 0-0<br>1-3<br>3B<br>1B          |                              | 0-0<br>1-3                      |                               | 0-0<br>F7                        |                              | 4                               | 2                            | 1                               | 0                            | 0                                | 0                            | 1                               |                              |                                 |                                  |                                    |                                  |        |  |  |  |  |  |
| Richie Ashburn, L (1, 8)<br>OBP: 0.382, SLG: 0.410  | 0-3<br>K                     |                                 | 0-0<br>F9                    | 0-0<br>HR<br>3B                 |                              | 0-0<br>F9                       |                               | 0-0<br>4-3                       |                              | 5                               | 1                            | 1                               | 2                            | 0                                | 1                            | 1                               |                              |                                 |                                  |                                    |                                  |        |  |  |  |  |  |
| Willie Jones, R (1, 5)<br>OBP: 0.382, SLG: 0.582  | 0-0<br>F8                    |                                 | 0-0<br>HR<br>1B              | 0-0<br>HR                       |                              |                                 | 0-0<br>6-3                    | 0-0<br>HR                        |                              | 5                               | 3                            | 3                               | 3                            | 0                                | 0                            | 1                               |                              |                                 |                                  |                                    |                                  |        |  |  |  |  |  |
| Del Ennis, R (1, 9)<br>OBP: 0.345, SLG: 0.526   | 0-0<br>1-H<br>3B             |                                 | 0-0<br>1-H<br>HR             | 0-0<br>L5                       |                              |                                 | 0-3<br>K                      | 0-0<br>2B                        |                              | 5                               | 1                            | 3                               | 3                            | 0                                | 1                            | 0                               |                              |                                 |                                  |                                    |                                  |        |  |  |  |  |  |
| Dick Sisler, L (1, 7)<br>OBP: 0.415, SLG: 0.515   | 0-0<br>F5                    |                                 | 0-0<br>4-3                   | 0-3<br>K                        |                              |                                 | 0-0<br>1B<br>2B               | 0-3<br>K                         |                              | 5                               | 1                            | 1                               | 0                            | 0                                | 2                            | 2                               |                              |                                 |                                  |                                    |                                  |        |  |  |  |  |  |
| Granny Hamner, R (1, 6)<br>OBP: 0.321, SLG: 0.386<br>Putsy Caballero, R (9, PH)<br>OBP: 0.143, SLG: 0.100<br>(9, 6)                                       |                              | 0-0<br>1B<br>E<br>1B            | 0-0<br>F7                    |                                 | 0-0<br>E5<br>FC6-4           |                                 | 4-0<br>1B<br>1B<br>BB         | 0-0<br>F9                        |                              | 3                               | 2                            | 1                               | 0                            | 1                                | 0                            | 0                               |                              |                                 |                                  |                                    |                                  |        |  |  |  |  |  |
| Andy Seminick, R (1, 2)<br>OBP: 0.446, SLG: 0.594<br>Bubba Church, R (7, PR)<br>OBP: 0.211, SLG: 0.263<br>Stan Lopata, R (7, 2)<br>OBP: 0.310, SLG: 0.214 |                              | 0-0<br>E<br>1B                  |                              | 0-0<br>HR                       | 0-0<br>FC6-4<br>G4-6-3       |                                 | 0-0<br>1B<br>1B               | 0-3<br>K                         |                              | 4                               | 1                            | 3                               | 3                            | 0                                | 0                            | 1                               |                              |                                 |                                  |                                    |                                  |        |  |  |  |  |  |
| Mike Goliat, R (1, 4)<br>OBP: 0.302, SLG: 0.362   |                              | 0-0<br>F2                       |                              | 0-3<br>K                        | 0-0<br>G4-6-3                |                                 | 0-0<br>1B                     | 0-3<br>K                         |                              | 5                               | 0                            | 1                               | 0                            | 0                                | 2                            | 2                               |                              |                                 |                                  |                                    |                                  |        |  |  |  |  |  |
| Curt Simmons, L (1, 1)<br>OBP: 0.250, SLG: 0.192  |                              | 0-0<br>F8                       |                              | 0-0<br>1B<br>3B<br>1B           |                              | 0-0<br>5-3                      | 0-0<br>L5                     |                                  |                              | 4                               | 1                            | 1                               | 0                            | 0                                | 0                            | 3                               |                              |                                 |                                  |                                    |                                  |        |  |  |  |  |  |
| <b>Inning Stats</b>   | R: 1<br>E: 1<br>K: 1<br>S: 7 | H: 1<br>LOB: 1<br>BB: 0<br>P: 7 | R: 1<br>E: 1<br>K: 0<br>S: 5 | H: 2<br>LOB: 1<br>BB: 0<br>P: 5 | R: 2<br>E: 0<br>K: 0<br>S: 5 | H: 2<br>LOB: 0<br>BB: 0<br>P: 5 | R: 5<br>E: 0<br>K: 2<br>S: 12 | H: 5<br>LOB: 0<br>BB: 0<br>P: 12 | R: 0<br>E: 1<br>K: 0<br>S: 3 | H: 0<br>LOB: 0<br>BB: 0<br>P: 3 | R: 0<br>E: 0<br>K: 0<br>S: 3 | H: 0<br>LOB: 0<br>BB: 0<br>P: 3 | R: 2<br>E: 0<br>K: 1<br>S: 8 | H: 3<br>LOB: 2<br>BB: 1<br>P: 12 | R: 1<br>E: 0<br>K: 1<br>S: 7 | H: 2<br>LOB: 1<br>BB: 0<br>P: 7 | R: 0<br>E: 0<br>K: 2<br>S: 7 | H: 0<br>LOB: 0<br>BB: 0<br>P: 7 | 1B: 7<br>2B: 2<br>3B: 2<br>HR: 4 | SF: 0<br>SAC: 0<br>DP: 1<br>HBP: 0 | WP: 0<br>PB: 0<br>SB: 0<br>CS: 0 | PA: 44 |  |  |  |  |  |
| <b>PITCHER</b>  | IP                           | WLS                             | BF                           | H                               | R                            | ER                              | SO                            | BB                               | IBB                          | HBP                             | BLK                          | WP                              | HR                           | S                                | P                            | ERA                             | WHIP                         |                                 |                                  |                                    |                                  |        |  |  |  |  |  |
| Ken Raffensberger, L (1, 1)<br>ERA: 4.19  | 3.1                          | L                               | 20                           | 9                               | 8                            | 6                               | 2                             | 0                                | 0                            | 0                               | 0                            | 0                               | 2                            | 24                               | 24                           | 16.20                           | 2.700                        |                                 |                                  |                                    |                                  |        |  |  |  |  |  |
| Frank Smith, R (4, 1)<br>ERA: 3.54  | 0.2                          |                                 | 3                            | 1                               | 1                            | 1                               | 1                             | 0                                | 0                            | 0                               | 0                            | 0                               | 1                            | 5                                | 5                            | 13.50                           | 1.500                        |                                 |                                  |                                    |                                  |        |  |  |  |  |  |
| Eddie Erautt, R (5, 1)<br>ERA: 8.47   | 4.0                          |                                 | 18                           | 5                               | 3                            | 3                               | 2                             | 1                                | 0                            | 0                               | 0                            | 0                               | 1                            | 21                               | 25                           | 6.75                            | 1.500                        |                                 |                                  |                                    |                                  |        |  |  |  |  |  |
| Harry Perkowski, L (9, 1)<br>ERA: 4.56  | 1.0                          |                                 | 3                            | 0                               | 0                            | 0                               | 2                             | 0                                | 0                            | 0                               | 0                            | 0                               | 0                            | 7                                | 7                            | 0.00                            | 0.000                        |                                 |                                  |                                    |                                  |        |  |  |  |  |  |

Philadelphia Phillies @ Cincinnati Reds  
Crosley Field, Cincinnati, OH  
Sun Jul 23 1950, 3:33 AM EDT  
Cloudy - 88 F

livebaseballscorecards.com

|     |    |
|-----|----|
| AB  | 42 |
| R   | 12 |
| H   | 15 |
| RBI | 11 |
| BB  | 1  |
| SO  | 7  |
| LOB | 11 |



| Batter   | 1             | 2                       | 3                 | 4         | 5           | 6               | 7        | 8                  | 9                 | AB R H RBI BB SO LOB   |
|--|---------------|-------------------------|-------------------|-----------|-------------|-----------------|----------|--------------------|-------------------|--|
| <b>Bobby Adams, R</b><br>OBP: 0.330, SLG: 0.340<br>(1, 5) X  | 0-0 F8 X      | 0-0 E 1B<br>1-3 2-H     |                   | 0-0 F9 X  |             | 0-0 5-3 X       |          |                    | 0-0 F8 X          | 5 0 1 1 0 0 1  |
| <b>Connie Ryan, R</b><br>OBP: 0.380, SLG: 0.388<br><b>Peanuts Lowrey, R</b><br>OBP: 0.325, SLG: 0.298<br>(1, 4) S S S<br>(8, 4)  | 0-3 K X       | 0-0 E6<br>1-3 3-H       |                   | 0-0 1B X  |             |                 | 0-0 F9 X |                    | 4-0 BB<br>B B B B | 4 0 1 0 0 1 1<br>0 0 0 0 1 0 0                                   |
| <b>Danny Litwhiler, R</b><br>OBP: 0.394, SLG: 0.488<br>(1, 9) B B B B  | 4-0 1B BB X   | 0-3 K S S S             |                   | 0-0 5-3 X |             |                 | 0-0 HR X |                    | 0-3 K S S S       | 4 1 1 1 1 2 5  |
| <b>Ted Kluszewski, L</b><br>OBP: 0.353, SLG: 0.569<br>(1, 3) X   | 0-0 1B<br>1-2 |                         | 0-0 4-3 X         |           | 0-3 K S S S |                 | 0-0 F8 X |                    |                   | 4 0 1 0 0 1 0  |
| <b>Bob Usher, R</b><br>OBP: 0.330, SLG: 0.412<br>(1, 8) S S S  | 0-3 K X       |                         | 0-0 E5<br>FC5-4   |           | 0-0 HR X    |                 | 0-0 F4 X |                    |                   | 4 1 1 1 0 1 2  |
| <b>Joe Adcock, R</b><br>OBP: 0.310, SLG: 0.398<br>(1, 7) X   |               | 0-0 F7 X                | 0-0 FC5-4<br>1-2f |           | 0-0 6-3 X   |                 |          | 0-0 G5-4-3<br>1B   |                   | 4 0 1 0 0 0 1  |
| <b>Johnny Pramesa, R</b><br>OBP: 0.354, SLG: 0.444<br>(1, 2) X   |               | 0-0 FC6-4<br>1B         | 0-0 F9 X          |           | 0-0 F8 X    |                 |          | 0-3 K S S S        |                   | 4 0 1 0 0 1 2  |
| <b>Virgil Stallcup, R</b><br>OBP: 0.294, SLG: 0.375<br><b>Eddie Erault, R</b><br>OBP: 0.286, SLG: 0.429<br><b>Bob Scheffing, R</b><br>OBP: 0.316, SLG: 0.396<br><b>Harry Perkowski, L</b><br>OBP: 0.389, SLG: 0.353<br>(1, 6)<br>(5, 1)<br>(8, PH)<br>(9, 1) |               | 0-0 FC6-4<br>1B<br>1-2f |                   | 0-0 F9 X  |             | 0-0 L1-3<br>1B  |          | 0-0 G5-4-3<br>1-2f |                   | 2 1 0 0 0 0 1<br>1 0 1 0 0 0 0<br>1 0 0 0 0 0 1<br>0 0 0 0 0 0 0 |
| <b>Ken Raffensberger, R</b><br>OBP: 0.218, SLG: 0.191<br><b>Frank Smith, R</b><br>OBP: 0.071, SLG: 0.071<br><b>Sammy Meeks, R</b><br>OBP: 0.300, SLG: 0.378<br>(1, 1)<br>(4, 1)<br>(4, PH)<br>(5, 6)   |               | 0-0 1B<br>1-2 E 1B      |                   | 0-0 1B X  |             | 0-0 L1-3<br>1-2 |          | 0-3 K S S S        |                   | 1 1 1 0 0 0 0<br>0 0 0 0 0 0 0<br>3 0 1 0 0 1 1                  |

| Inning Stats | R: 0 | H: 1 | E: 0 | K: 2 | S: 8 | H: 1 | LOB: 2 | BB: 1 | P: 12 | R: 2 | H: 3 | E: 1 | K: 1 | S: 9 | R: 0 | H: 0 | E: 1 | K: 0 | S: 4 | R: 0 | H: 2 | E: 0 | K: 0 | S: 5 | R: 1 | H: 1 | E: 0 | K: 1 | S: 6 | R: 0 | H: 1 | E: 0 | K: 0 | S: 3 | R: 1 | H: 1 | E: 0 | K: 0 | S: 4 | R: 0 | H: 1 | E: 0 | K: 1 | S: 5 | R: 0 | H: 1 | E: 0 | K: 2 | S: 7 | R: 0 | H: 0 | E: 0 | K: 2 | S: 7 | 1B: 8 | SF: 0 | 2B: 1 | SAC: 0 | 3B: 0 | DP: 2 | HR: 2 | HBP: 0 | WP: 0 | PA: 39 |
|--------------|------|------|------|------|------|------|--------|-------|-------|------|------|------|------|------|------|------|------|------|------|------|------|------|------|------|------|------|------|------|------|------|------|------|------|------|------|------|------|------|------|------|------|------|------|------|------|------|------|------|------|------|------|------|------|------|-------|-------|-------|--------|-------|-------|-------|--------|-------|--------|
|--------------|------|------|------|------|------|------|--------|-------|-------|------|------|------|------|------|------|------|------|------|------|------|------|------|------|------|------|------|------|------|------|------|------|------|------|------|------|------|------|------|------|------|------|------|------|------|------|------|------|------|------|------|------|------|------|------|-------|-------|-------|--------|-------|-------|-------|--------|-------|--------|

| PITCHER                                       | IP  | WLS | BF | H  | R | ER | SO | BB | IBB | HBP | BLK | WP | HR | S  | P  | ERA  | WHIP  | PITCHER | IP | WLS | BF | H | R | ER | SO | BB | IBB | HBP | BLK | WP | HR | S | P | ERA | WHIP |  |  |  |  |  |  |  |  |  |  |  |  |  |  |  |  |  |  |
|---|-----|-----|----|----|---|----|----|----|-----|-----|-----|----|----|----|----|------|-------|---------|----|-----|----|---|---|----|----|----|-----|-----|-----|----|----|---|---|-----|------|--|--|--|--|--|--|--|--|--|--|--|--|--|--|--|--|--|--|
| <b>Curt Simmons, L</b><br>ERA: 3.64<br>(1, 1) | 9.0 | W   | 39 | 10 | 4 | 3  | 7  | 2  | 0   | 0   | 0   | 0  | 2  | 51 | 59 | 3.00 | 1.333 |         |    |     |    |   |   |    |    |    |     |     |     |    |    |   |   |     |      |  |  |  |  |  |  |  |  |  |  |  |  |  |  |  |  |  |  |

**BOTTOM**

**Philadelphia Phillies @ Cincinnati Reds**  
Crosley Field, Cincinnati, OH  
Sun Jul 23 1950, 3:33 AM EDT  
Cloudy - 88 F

livebaseballscores.com

|            |           |
|------------|-----------|
| <b>AB</b>  | <b>37</b> |
| <b>R</b>   | <b>4</b>  |
| <b>H</b>   | <b>10</b> |
| <b>RBI</b> | <b>3</b>  |
| <b>BB</b>  | <b>2</b>  |
| <b>SO</b>  | <b>7</b>  |
| <b>LOB</b> | <b>15</b> |



| Batter  | 1   | 2   | 3  | 4   | 5   | 6   | 7  | 8   | 9   | AB R H RBI BB SO LOB  | TOP  |
|---|---|---|--|---|---|---|--|---|---|---|--|
| Eddie Waitkus, L (1, 3)<br>OBP: 0.332, SLG: 0.358   | 0-0<br>S<br>1B  |   | 0-0<br>SH1-4<br>1B   | 0-0<br>E5<br>1B   |   | 0-0<br>2B   |  | 0-0<br>6-3<br>SH1-4<br>1B                                       |   | 5 2 5 2 0 0 0   | <b>Philadelphia Phillies @ Cincinnati Reds</b><br>Crosley Field, Cincinnati, OH<br>Sun Jul 23 1950, 3:38 AM EDT<br>Att: 28,831 - Unknown<br><a href="http://livebaseballscorecards.com">livebaseballscorecards.com</a> |
| Richie Ashburn, L (1, 8)<br>OBP: 0.380, SLG: 0.408  | 0-0<br>F7   |   | 0-0<br>BB<br>SH1-4<br>1B   | 0-0<br>F5   |   | 0-0<br>F8   |  | 0-0<br>SH1-4  |   | 4 0 1 0 0 0 4   |  |
| Dick Sisler, L (1, 7)<br>OBP: 0.416, SLG: 0.515   | 0-0<br>HBP<br>1B  |   | 0-0<br>SH1-4   | 0-0<br>F9   |   |   | 0-0<br>1B<br>SH5-3<br>WP<br>1B                                   | 0-0<br>6-3  |   | 4 1 2 1 0 0 3   |  |
| Del Ennis, R (1, 9)<br>OBP: 0.344, SLG: 0.521   | 0-0<br>F9   |   | 4-0<br>BB<br>IBB   |   | 0-3<br>K  |   | 0-0<br>SH5-3   | 0-3<br>K  |   | 3 0 0 0 1 2 2   |  |
| Willie Jones, R (1, 5)<br>OBP: 0.385, SLG: 0.582  | 1-0<br>HBP  |   | 4-0<br>G6-4-3<br>BB  |   | 0-0<br>F9   |   | 0-0<br>1B  | 0-0<br>F9   | 0 0 0 1 1 0 0   | 0 1 0 0 0 0 0   |  |
| Jimmy Bloodworth, R (3, 5)<br>OBP: 0.262, SLG: 0.248  | 1-2<br>HBP  |   | 1-2<br>2-3<br>3-H  |   | 0-0<br>F9   |   | 2-3<br>1B  |   |   |   |  |
| Granny Hamner, R (1, 6)<br>OBP: 0.317, SLG: 0.381   | 0-0<br>F9   |   | 0-0<br>G6-4-3  |   | 0-0<br>P4   |   | 0-0<br>6-3   | 0-0<br>F2   | 5 0 0 0 0 0 6   |   |  |
| Stan Lopata, R (1, 2)<br>OBP: 0.314, SLG: 0.225   |   | 0-0<br>4-3  |  | 0-0<br>1B<br>1B<br>2B   |   | 0-3<br>K  | 4-0<br>3B<br>IBB   | 0-0<br>F9   | 4 2 1 0 1 1 0   |   |  |
| Mike Goliat, R (1, 4)<br>OBP: 0.304, SLG: 0.372   |   | 0-0<br>F7   |  | 0-0<br>P3   |   | 0-0<br>SH5-4<br>2B<br>1B  | 1-2<br>3-H<br>3B   |   | 4 1 2 2 0 0 1   |   |  |
| Russ Meyer, S (1, 1)<br>OBP: 0.219, SLG: 0.226  |   | 0-3<br>K  |  | 0-0<br>E<br>1B<br>1B  |   | 0-0<br>SH5-4  | 0-0<br>1-3   |   | 3 0 1 0 0 1 1   |   |  |
| Jim Konstanty, R (8, 1)<br>OBP: 0.056, SLG: 0.056   |   |   |  |   |   |   |  |   | 0 0 0 0 0 0 0   |   |  |
| <b>Inning Stats</b>   | R: 1<br>E: 0<br>K: 0<br>S: 5<br>H: 2<br>LOB: 2<br>BB: 0<br>P: 6   | R: 0<br>E: 0<br>K: 1<br>S: 5<br>H: 0<br>LOB: 0<br>BB: 0<br>P: 5 | R: 1<br>E: 0<br>K: 0<br>S: 4<br>H: 2<br>LOB: 2<br>BB: 2<br>P: 12 | R: 1<br>E: 1<br>K: 0<br>S: 6<br>H: 3<br>LOB: 2<br>BB: 0<br>P: 6 | R: 0<br>E: 0<br>K: 1<br>S: 5<br>H: 0<br>LOB: 0<br>BB: 0<br>P: 5 | R: 1<br>E: 0<br>K: 1<br>S: 7<br>H: 2<br>LOB: 1<br>BB: 0<br>P: 7   | R: 3<br>E: 0<br>K: 0<br>S: 6<br>H: 3<br>LOB: 1<br>BB: 1<br>P: 10 | R: 0<br>E: 0<br>K: 1<br>S: 6<br>H: 1<br>LOB: 1<br>BB: 0<br>P: 6 | R: 0<br>E: 0<br>K: 0<br>S: 3<br>H: 0<br>LOB: 0<br>BB: 0<br>P: 3 | 1B: 10<br>2B: 2<br>3B: 1<br>HR: 0<br>SF: 0<br>SAC: 4<br>DP: 1<br>HBP: 1 | WP: 1<br>PB: 0<br>SB: 1<br>CS: 0<br>PA: 43   |
| <b>PITCHER</b><br>Ewell Blackwell, R (1, 1)<br>ERA: 3.89<br>Johnny Hetki, R (8, 1)<br>ERA: 4.71 | IP: 7.0<br>WLS: L<br>BF: 36<br>H: 12<br>R: 7<br>ER: 7<br>SO: 3<br>BB: 1<br>IBB: 2<br>HBP: 1<br>BLK: 0<br>WP: 1<br>HR: 0<br>S: 38<br>P: 51<br>ERA: 9.00<br>WHIP: 1.857 |   |  |   |   | <b>PITCHER</b><br>IP: 2.0<br>WLS:<br>BF: 7<br>H: 1<br>R: 0<br>ER: 0<br>SO: 1<br>BB: 0<br>IBB: 0<br>HBP: 0<br>BLK: 0<br>WP: 0<br>HR: 0<br>S: 9<br>P: 9<br>ERA: 0.00<br>WHIP: 0.500 |  |   |   |   |  |



| Batter  | 1           | 2                               | 3           | 4                              | 5          | 6                               | 7                | 8                     | 9 |
|---|-------------|---------------------------------|-------------|--------------------------------|------------|---------------------------------|------------------|-----------------------|---|
| Lloyd Merriman, L (1, 8)<br>OBP: 0.319, SLG: 0.363  | 0-0 1-3<br> |                                 | 0-0 4-3<br> |                                |            | 0-0 6-3<br>                     |                  | 0-0 FC4-8 1B<br>      |   |
| Connie Ryan, R (1, 4)<br>OBP: 0.379, SLG: 0.386<br>Bobby Adams, R (3, PH)<br>OBP: 0.326, SLG: 0.335   | 0-0 6-3<br> |                                 | 0-0 F9<br>  |                                |            | 0-0 4-3<br>                     |                  | 0-0 F7<br>            |   |
| Grady Hatton, L (1, 5)<br>OBP: 0.352, SLG: 0.429  | 0-0 F3<br>  |                                 |             | 4-0 FC6-4 BB<br>               |            | 0-0 4-3<br>                     |                  | 0-0 F7<br>            |   |
| Ted Kluszewski, L (1, 3)<br>OBP: 0.351, SLG: 0.568  |             | 0-0 E4<br>1-3 1B<br>6-3<br>     |             | 0-0 FC6-4<br>FC5-4<br>1-2f<br> |            | 0-0 1B<br>1B<br>2B<br>          |                  | 0-0 FC4-6<br>1-2f<br> |   |
| Bob Usher, R (1, 9)<br>OBP: 0.333, SLG: 0.414   |             | 0-0<br>6-3 1-3<br>1-2<br>1B<br> |             | 0-0 F7<br>                     |            | 0-0 1B<br>2-3<br>1B<br>         |                  | 0-0 F7<br>            |   |
| Joe Adcock, R (1, 7)<br>OBP: 0.308, SLG: 0.394  |             | 0-0 1-3<br>1-2<br>2-3<br>       |             | 0-0 FC5-4<br>1-2f<br>          |            | 0-0 6-3<br>1-3<br>3-H<br>1B<br> |                  | 0-0 6-3<br>           |   |
| Dixie Howell, R (1, 2)<br>OBP: 0.312, SLG: 0.264<br>Peanuts Lowrey, R (9, PH)<br>OBP: 0.324, SLG: 0.296   |             | 0-0 6-3<br>2-3<br>3-H<br>       |             | 0-0 6-3<br>                    |            | 0-0 6-3<br>2-3<br>3-H<br>       |                  | 0-0 6-3<br>           |   |
| Virgil Stallcup, R (1, 6)<br>OBP: 0.291, SLG: 0.371   |             | 0-0 K<br>6-3<br>                |             | 0-0 6-3<br>                    |            | 0-0 6-3<br>3-H<br>              |                  | 0-0 6-3<br>           |   |
| Ewell Blackwell, R (1, 1)<br>OBP: 0.156, SLG: 0.073<br>Harry Perkowski, L (7, PH)<br>OBP: 0.368, SLG: 0.333<br>Johnny Hetki, R (8, 1)<br>OBP: 0.250, SLG: 0.143 |             |                                 | 0-0 6-3<br> |                                | 0-0 F2<br> |                                 | 0-0 K<br>6-3<br> |                       |   |

| BOTTOM |   |   |     |    |    |     |  |  |  |
|--------|---|---|-----|----|----|-----|--|--|--|
| AB     | R | H | RBI | BB | SO | LOB |  |  |  |
| 4      | 0 | 1 | 0   | 0  | 0  | 0   |  |  |  |
| 1      | 0 | 0 | 0   | 0  | 0  | 0   |  |  |  |
| 3      | 0 | 0 | 0   | 0  | 0  | 1   |  |  |  |
| 3      | 0 | 0 | 0   | 1  | 0  | 1   |  |  |  |
| 4      | 2 | 1 | 0   | 0  | 0  | 2   |  |  |  |
| 4      | 1 | 2 | 0   | 0  | 0  | 1   |  |  |  |
| 4      | 1 | 1 | 1   | 0  | 0  | 3   |  |  |  |
| 3      | 0 | 0 | 2   | 0  | 0  | 2   |  |  |  |
| 1      | 0 | 0 | 0   | 0  | 0  | 0   |  |  |  |
| 3      | 0 | 0 | 1   | 0  | 1  | 1   |  |  |  |
| 2      | 0 | 0 | 0   | 0  | 0  | 0   |  |  |  |
| 1      | 0 | 0 | 0   | 0  | 1  | 0   |  |  |  |
| 0      | 0 | 0 | 0   | 0  | 0  | 0   |  |  |  |

Philadelphia Phillies @ Cincinnati Reds  
 Crosley Field, Cincinnati, OH  
 Sun Jul 23 1950, 3:38 AM EDT  
 Att. 28,831 - Unknown

|     |    |
|-----|----|
| AB  | 33 |
| R   | 4  |
| H   | 5  |
| RBI | 4  |
| BB  | 1  |
| SO  | 2  |
| LOB | 11 |



| Inning Stats                         |     | R: 0 | H: 0 | E: 0 | K: 0 | S: 3 | R: 1 | H: 1 | E: 1 | K: 1 | S: 7 | R: 0 | H: 0 | E: 0 | K: 0 | S: 3 | R: 0  | H: 0 | E: 0 | K: 0 | S: 3 | R: 0 | H: 0 | E: 0 | K: 0 | S: 3 | R: 0 | H: 0 | E: 0 | K: 0 | S: 3 | R: 3 | H: 3 | E: 0 | K: 1 | S: 8 | R: 0 | H: 1 | E: 0 | K: 0 | S: 3 | R: 0 | H: 0 | E: 0 | K: 0 | S: 3 | 1B: 4 | SF: 0 | 2B: 1 | SAC: 0 | 3B: 0 | DP: 0 | HR: 0 | HBP: 0 | WP: 0 | PA: 34 |
|--------------------------------------|-----|------|------|------|------|------|------|------|------|------|------|------|------|------|------|------|-------|------|------|------|------|------|------|------|------|------|------|------|------|------|------|------|------|------|------|------|------|------|------|------|------|------|------|------|------|------|-------|-------|-------|--------|-------|-------|-------|--------|-------|--------|
| PITCHER                              | IP  | WLS  | BF   | H    | R    | ER   | SO   | BB   | IBB  | HBP  | BLK  | WP   | HR   | S    | P    | ERA  | WHIP  |      |      |      |      |      |      |      |      |      |      |      |      |      |      |      |      |      |      |      |      |      |      |      |      |      |      |      |      |      |       |       |       |        |       |       |       |        |       |        |
| Russ Meyer, R (1, 1)<br>ERA: 5.77    | 7.0 | W    | 28   | 5    | 4    | 3    | 2    | 1    | 0    | 0    | 0    | 0    | 0    | 31   | 35   | 3.86 | 0.857 |      |      |      |      |      |      |      |      |      |      |      |      |      |      |      |      |      |      |      |      |      |      |      |      |      |      |      |      |      |       |       |       |        |       |       |       |        |       |        |
| Jim Konstanty, R (8, 1)<br>ERA: 3.07 | 2.0 | S    | 6    | 0    | 0    | 0    | 0    | 0    | 0    | 0    | 0    | 0    | 0    | 6    | 6    | 0.00 | 0.000 |      |      |      |      |      |      |      |      |      |      |      |      |      |      |      |      |      |      |      |      |      |      |      |      |      |      |      |      |      |       |       |       |        |       |       |       |        |       |        |

| Batter   | 1   | 2                               | 3                            | 4                               | 5                            | 6                               | 7                            | 8                               | 9                            | AB R H RBI BB SO LOB            | TOP                          |                                 |                              |                                 |                              |                                  |                              |                                 |                                  |                                    |  |  |  |  |  |  |  |
|--|---|---------------------------------|------------------------------|---------------------------------|------------------------------|---------------------------------|------------------------------|---------------------------------|------------------------------|---------------------------------|------------------------------|---------------------------------|------------------------------|---------------------------------|------------------------------|----------------------------------|------------------------------|---------------------------------|----------------------------------|------------------------------------|--|--|--|--|--|--|--|
| <b>Bobby Adams, R</b> (1, 5)<br>OBP: 0.328, SLG: 0.337     | 0-0<br>F8   |                                 | 0-0<br>G4-6-3 SH<br>1B       |                                 | 0-0<br>1-3                   |                                 | 0-0<br>1B                    |                                 | 0-0<br>F6                    | 5 1 2 0 0 0 0                   |                              |                                 |                              |                                 |                              |                                  |                              |                                 |                                  |                                    |  |  |  |  |  |  |  |
| <b>Peanuts Lowrey, R</b> (1, 9)<br>OBP: 0.327, SLG: 0.300  | 0-0<br>1B   |                                 | 0-0<br>SH<br>G4-6-3          |                                 | 0-0<br>F4                    |                                 | 0-0<br>F7                    |                                 | 0-0<br>2B<br>1B              | 4 1 2 0 0 0 1                   |                              |                                 |                              |                                 |                              |                                  |                              |                                 |                                  |                                    |  |  |  |  |  |  |  |
| <b>Bob Usher, R</b> (1, 8)<br>OBP: 0.335, SLG: 0.410       | 0-0<br>F9   |                                 | 0-0<br>G4-6-3                |                                 | 4-0<br>BB                    |                                 |                              | 0-0<br>BB BB<br>F9<br>1B        | 0-0<br>F2                    | 4 1 1 0 1 0 4                   |                              |                                 |                              |                                 |                              |                                  |                              |                                 |                                  |                                    |  |  |  |  |  |  |  |
| <b>Ted Kluszewski, L</b> (1, 3)<br>OBP: 0.355, SLG: 0.570  | 0-0<br>F7   |                                 | 0-0<br>FC5-4<br>1B           |                                 | 0-0<br>F8                    |                                 |                              | 4-0<br>BB BB<br>F9<br>BB        | 0-0<br>2B                    | 4 1 2 2 1 0 2                   |                              |                                 |                              |                                 |                              |                                  |                              |                                 |                                  |                                    |  |  |  |  |  |  |  |
| <b>Connie Ryan, R</b> (1, 4)<br>OBP: 0.383, SLG: 0.397     |   | 0-0<br>HR                       | 0-0<br>FC5-4<br>1B           |                                 | 0-0<br>5-3                   |                                 |                              | 4-0<br>BB BB<br>F9<br>BB        | 4-0<br>IBB                   | 3 1 1 1 2 0 1                   |                              |                                 |                              |                                 |                              |                                  |                              |                                 |                                  |                                    |  |  |  |  |  |  |  |
| <b>Joe Adcock, R</b> (1, 7)<br>OBP: 0.297, SLG: 0.379      |   | 0-0<br>4-3                      |                              | 0-0<br>F3                       |                              | 0-0<br>F9                       |                              | 0-0<br>F9                       | 0-0<br>F9                    | 5 0 0 1 0 0 4                   |                              |                                 |                              |                                 |                              |                                  |                              |                                 |                                  |                                    |  |  |  |  |  |  |  |
| <b>Dixie Howell, R</b> (1, 2)<br>OBP: 0.303, SLG: 0.256    |   | 0-3<br>K                        |                              | 0-0<br>F8                       |                              | 0-0<br>P2                       |                              | 0-0<br>5-3                      |                              | 4 0 0 1 0 1 1                   |                              |                                 |                              |                                 |                              |                                  |                              |                                 |                                  |                                    |  |  |  |  |  |  |  |
| <b>Virgil Stallcup, R</b> (1, 6)<br>OBP: 0.293, SLG: 0.371 |   | 0-0<br>F4                       |                              | 0-0<br>1B                       |                              |                                 | 0-0<br>6-3                   | 4-0<br>BB                       |                              | 3 0 1 0 1 0 0                   |                              |                                 |                              |                                 |                              |                                  |                              |                                 |                                  |                                    |  |  |  |  |  |  |  |
| <b>Herm Wehmeier, R</b> (1, 1)<br>OBP: 0.210, SLG: 0.246   |   |                                 | 0-0<br>SH<br>G4-6-3<br>1B    |                                 | 0-3<br>K                     |                                 | 0-3<br>K                     | 0-0<br>P3                       |                              | 4 1 1 0 0 2 3                   |                              |                                 |                              |                                 |                              |                                  |                              |                                 |                                  |                                    |  |  |  |  |  |  |  |
| <b>Ewell Blackwell, R</b> (8, 1)<br>OBP: 0.156, SLG: 0.073 |   |                                 |                              |                                 |                              |                                 |                              |                                 |                              | 0 0 0 0 0 0 0                   |                              |                                 |                              |                                 |                              |                                  |                              |                                 |                                  |                                    |  |  |  |  |  |  |  |
| <b>Inning Stats</b>  | R: 0<br>E: 0<br>K: 0<br>S: 4                          | H: 1<br>LOB: 1<br>BB: 0<br>P: 4 | R: 1<br>E: 0<br>K: 1<br>S: 6 | H: 1<br>LOB: 0<br>BB: 0<br>P: 6 | R: 2<br>E: 0<br>K: 0<br>S: 6 | H: 3<br>LOB: 1<br>BB: 0<br>P: 6 | R: 0<br>E: 0<br>K: 1<br>S: 6 | H: 1<br>LOB: 1<br>BB: 0<br>P: 6 | R: 0<br>E: 0<br>K: 0<br>S: 3 | H: 0<br>LOB: 1<br>BB: 1<br>P: 7 | R: 0<br>E: 0<br>K: 0<br>S: 3 | H: 0<br>LOB: 0<br>BB: 0<br>P: 3 | R: 0<br>E: 0<br>K: 1<br>S: 6 | H: 1<br>LOB: 1<br>BB: 0<br>P: 6 | R: 2<br>E: 0<br>K: 0<br>S: 4 | H: 1<br>LOB: 2<br>BB: 3<br>P: 16 | R: 1<br>E: 0<br>K: 0<br>S: 5 | H: 2<br>LOB: 2<br>BB: 1<br>P: 9 | 1B: 8<br>2B: 1<br>3B: 0<br>HR: 1 | SF: 0<br>SAC: 1<br>DP: 1<br>HBP: 0 | WP: 0<br>PA: 42<br>PB: 0<br>SB: 0<br>CS: 0 |  |  |  |  |  |  |
| <b>PITCHER</b>   | IP WLS BF H R ER SO BB IBB HBP BLK WP HR S P ERA WHIP |                                 |                              |                                 |                              |                                 |                              |                                 |                              |                                 |                              |                                 |                              |                                 |                              |                                  |                              |                                 |                                  |                                    |  |  |  |  |  |  |  |
| <b>Monty Kennedy, L</b> (1, 1)<br>ERA: 4.8                 | 3.0   |                                 | 14                           | 5                               | 3                            | 3                               | 1                            | 0                               | 0                            | 0                               | 0                            | 0                               | 1                            | 16                              | 16                           | 9.00                             | 1.667                        |                                 |                                  |                                    |  |  |  |  |  |  |  |
| <b>Andy Hansen, R</b> (4, 1)<br>ERA: 5.46                  | 4.0   |                                 | 18                           | 3                               | 2                            | 2                               | 2                            | 3                               | 0                            | 0                               | 0                            | 0                               | 0                            | 19                              | 31                           | 4.50                             | 1.500                        |                                 |                                  |                                    |  |  |  |  |  |  |  |
| <b>Dave Koslo, L</b> (8, 1)<br>ERA: 4.34                   | 2.0   | W                               | 10                           | 2                               | 1                            | 1                               | 0                            | 1                               | 1                            | 0                               | 0                            | 0                               | 0                            | 8                               | 16                           | 4.50                             | 1.500                        |                                 |                                  |                                    |  |  |  |  |  |  |  |

**Cincinnati Reds @ New York Giants**  
Polo Grounds, New York, NY  
Tue Jul 25 1950, 3:33 AM EDT  
Att. 8,838 - Unknown

livebaseballscorecards.com

|            |    |
|------------|----|
| <b>AB</b>  | 36 |
| <b>R</b>   | 6  |
| <b>H</b>   | 10 |
| <b>RBI</b> | 5  |
| <b>BB</b>  | 5  |
| <b>SO</b>  | 3  |
| <b>LOB</b> | 16 |







| Batter  | 1   | 2   | 3   | 4   | 5  | 6   | 7   | 8   | 9   | AB R H RBI BB SO LOB   | TOP  |   |
|---|---|---|---|---|--|---|---|---|---|--|--|---|
| Lloyd Merriman, L (1, 8)<br>OBP: 0.317, SLG: 0.360  | 0-0<br>3-1  |   | 0-0<br>F8   |   | 0-0<br>1B  |   |   | 0-0<br>F7   |   | 4 0 1 1 0 0 1  |  |   |
| Connie Ryan, R (1, 4)<br>OBP: 0.381, SLG: 0.392   | 0-3<br>K  |   | 0-0<br>G3   |   | 0-0<br>F7  |   |   | 4-0<br>BB   |   | 3 0 0 1 1 1 3  |  |   |
| Grady Hatton, L (1, 5)<br>OBP: 0.348, SLG: 0.423  | 0-0<br>3-1  |   |   | 0-0<br>4-3  | 0-0<br>G3  |   |   | 0-0<br>G4-6-3   |   | 4 0 0 0 0 0 3  |  |   |
| Ted Kluszewski, L (1, 3)<br>OBP: 0.354, SLG: 0.566  |   | 0-0<br>F7   |   | 0-0<br>4-3  |  | 0-0<br>FC5-4<br>1B  |   | 0-0<br>F7   |   | 4 0 1 0 0 0 0  |  |   |
| Bob Usher, R (1, 9)<br>OBP: 0.333, SLG: 0.407   |   | 0-0<br>F3   |   | 0-0<br>F2   |  | 0-0<br>FC5-4<br>CS  |   | 0-0<br>1-3<br>1B  |   | 4 0 1 0 0 0 1  |  |   |
| Joe Adcock, R (1, 7)<br>OBP: 0.303, SLG: 0.378  |   | 4-0<br>BB   |   |   | 0-0<br>BB<br>1B<br>1B  | 0-0<br>F8   |   | 0-0<br>1-3  |   | 3 1 1 0 1 0 2  |  |   |
| Virgil Stallcup, R (1, 6)<br>OBP: 0.294, SLG: 0.370<br>Bob Scheffing, R (9, PH)<br>OBP: 0.310, SLG: 0.389 |   | 0-0<br>FC6-4  |   | 0-0<br>FC6-4  | 0-0<br>1B<br>BB<br>F7<br>1B                                      | 0-0<br>CS   | 0-0<br>F2   | 0-0<br>5-3  |   | 3 1 1 0 0 0 1<br>1 0 0 0 0 0 1   | AB 31<br>R 2<br>H 6<br>RBI 2<br>BB 3<br>SO 2<br>LOB 16 |   |
| Dixie Howell, R (1, 2)<br>OBP: 0.310, SLG: 0.260  |   |   | 0-0<br>1B   |   | 4-0<br>F7<br>1B<br>BB  |   | 0-0<br>4-3  |   | 0-0<br>2  | 2 0 1 0 1 0 0  |  |   |
| Howie Fox, R (1, 1)<br>OBP: 0.211, SLG: 0.316   |   |   | 0-3<br>K  |   | 0-0<br>L4  |   | 0-0<br>6-3  |   | 0-0<br>3  | 3 0 0 0 0 1 4  |  |   |
| <b>Inning Stats</b>   | R: 0<br>E: 0<br>K: 1<br>S: 5<br>H: 0<br>LOB: 0<br>BB: 0<br>P: 5   | R: 0<br>E: 0<br>K: 0<br>S: 3<br>H: 0<br>LOB: 1<br>BB: 1<br>P: 7 | R: 0<br>E: 0<br>K: 1<br>S: 6<br>H: 1<br>LOB: 1<br>BB: 0<br>P: 6 | R: 0<br>E: 0<br>K: 0<br>S: 3<br>H: 0<br>LOB: 0<br>BB: 0<br>P: 3 | R: 2<br>E: 0<br>K: 0<br>S: 6<br>H: 3<br>LOB: 2<br>BB: 1<br>P: 10 | R: 0<br>E: 0<br>K: 0<br>S: 3<br>H: 1<br>LOB: 0<br>BB: 0<br>P: 3 | R: 0<br>E: 0<br>K: 0<br>S: 3<br>H: 0<br>LOB: 0<br>BB: 0<br>P: 3 | R: 0<br>E: 0<br>K: 0<br>S: 2<br>H: 0<br>LOB: 0<br>BB: 1<br>P: 6 | R: 0<br>E: 0<br>K: 0<br>S: 4<br>H: 1<br>LOB: 1<br>BB: 0<br>P: 4 | 1B: 6<br>2B: 0<br>3B: 0<br>HR: 0<br>SF: 0<br>SAC: 0<br>DP: 1<br>HBP: 0 | WP: 0<br>PB: 0<br>SB: 0<br>CS: 1<br>PA: 35             |   |
| <b>PITCHER</b><br>Sal Maglie, R (1, 1)<br>ERA: 2.98   | IP 9.0<br>WLS W<br>BF 34<br>H 6<br>R 2<br>ER 2<br>SO 2<br>BB 3<br>IBB 0<br>HBP 0<br>BLK 0<br>WP 0<br>HR 0<br>S 35<br>P 47<br>ERA 2.00<br>WHIP 1.000 |   |   |   |  |   |   |   |   |  |  | <b>PITCHER</b><br>IP WLS BF H R ER SO BB IBB HBP BLK WP HR S P ERA WHIP |

Cincinnati Reds @ New York Giants  
Polo Grounds, New York, NY  
Wed Jul 26 1950, 3:33 AM EDT  
Att. 4,852 - Cloudy - 78 F

livebaseballscorecards.com



| Batter  | 1          | 2                       | 3          | 4                   | 5                    | 6                    | 7                          | 8                | 9 |
|---|------------|-------------------------|------------|---------------------|----------------------|----------------------|----------------------------|------------------|---|
| <b>Eddie Stanky, R</b><br>OBP: 0.457, SLG: 0.420 (1, 4)   | 0-0<br>6-3 |                         | 0-0<br>5-3 |                     | 0-0<br>1-3           |                      | 0-0<br>FC4-6<br>BB<br>1-2f |                  |   |
| <b>Whitey Lockman, L</b><br>OBP: 0.381, SLG: 0.451 (1, 7) | 0-0<br>F4  |                         | 0-0<br>G3  |                     | 0-0<br>F7-3-6<br>3-H |                      | 4-0<br>BB<br>1-2<br>BB     |                  |   |
| <b>Don Mueller, L</b><br>OBP: 0.317, SLG: 0.375 (1, 9)    | 0-0<br>F5  |                         | 0-0<br>4-3 |                     |                      | 0-0<br>FC5-4<br>1B   | 0-0<br>F9                  |                  |   |
| <b>Hank Thompson, L</b><br>OBP: 0.401, SLG: 0.485 (1, 5)  |            | 0-0<br>E<br>1B<br>1B    |            | 0-0<br>6-4-3<br>1B  |                      | 0-0<br>F4            |                            | 0-0<br>4-3       |   |
| <b>Wes Westrum, R</b><br>OBP: 0.391, SLG: 0.507 (1, 2)    |            | 0-0<br>F9               |            | 0-0<br>F7           |                      | 0-0<br>FC5-4<br>1-2f |                            | 0-0<br>E7<br>1B  |   |
| <b>Bobby Thomson, R</b><br>OBP: 0.327, SLG: 0.434 (1, 8)  |            | 0-0<br>E6<br>1B<br>1-3  |            | 0-0<br>6-4-3<br>1-2 |                      | 0-0<br>F8            |                            | 0-3<br>K         |   |
| <b>Alvin Dark, R</b><br>OBP: 0.341, SLG: 0.486 (1, 6)     |            | 0-0<br>2-H<br>3-H<br>1B |            | 4-0<br>IBB          |                      |                      | 0-0<br>SH3<br>1B<br>1B     | 0-0<br>1-2<br>1B |   |
| <b>Tookie Gilbert, L</b><br>OBP: 0.331, SLG: 0.331 (1, 3) |            | 0-0<br>G3               |            | 0-0<br>G3           |                      |                      | 0-0<br>SH3<br>1-2          | 0-3<br>K         |   |
| <b>Sal Maglie, R</b><br>OBP: 0.133, SLG: 0.207 (1, 1)     |            | 0-0<br>1-3              |            |                     | 0-0<br>F7-3-6<br>3B  |                      | 0-0<br>FC4-6<br>2-H<br>1B  |                  |   |

| Inning Stats | R: 0   | H: 0  | E: 0   | K: 0  | S: 3 | R: 2   | H: 2  | E: 1   | K: 0  | S: 6 | R: 0   | H: 0  | E: 0   | K: 0  | S: 3 | R: 0   | H: 1  | E: 0   | K: 0  | S: 4 | R: 0   | H: 1  | E: 0   | K: 0  | S: 3 | R: 0   | H: 1  | E: 0   | K: 0  | S: 4 | R: 1  | H: 2   | E: 0  | K: 0   | S: 5  | R: 0  | H: 1  | E: 1  | K: 2 | S: 9 |
|--------------|--------|-------|--------|-------|------|--------|-------|--------|-------|------|--------|-------|--------|-------|------|--------|-------|--------|-------|------|--------|-------|--------|-------|------|--------|-------|--------|-------|------|-------|--------|-------|--------|-------|-------|-------|-------|------|------|
|              | LOB: 0 | BB: 0 | LOB: 1 | BB: 0 | P: 3 | LOB: 0 | BB: 0 | LOB: 2 | BB: 0 | P: 8 | LOB: 0 | BB: 0 | LOB: 1 | BB: 0 | P: 3 | LOB: 2 | BB: 1 | LOB: 1 | BB: 0 | P: 4 | LOB: 2 | BB: 1 | LOB: 2 | BB: 0 | P: 9 | LOB: 2 | BB: 1 | LOB: 2 | BB: 0 | P: 9 | SF: 0 | SAC: 1 | DP: 1 | HBP: 0 | 1B: 7 | 2B: 1 | 3B: 1 | HR: 0 |      |      |

| PITCHER                                 | IP  | WLS | BF | H | R | ER | SO | BB | IBB | HBP | BLK | WP | HR | S  | P  | ERA  | WHIP  |
|---|-----|-----|----|---|---|----|----|----|-----|-----|-----|----|----|----|----|------|-------|
| <b>Howie Fox, R</b><br>ERA: 4.47 (1, 1) | 8.0 | L   | 35 | 8 | 3 | 1  | 2  | 1  | 1   | 0   | 0   | 0  | 0  | 37 | 45 | 1.12 | 1.125 |

**BOTTOM**

| AB | R | H | RBI | BB | SO | LOB |
|----|---|---|-----|----|----|-----|
| 4  | 0 | 0 | 0   | 0  | 0  | 2   |
| 3  | 0 | 0 | 0   | 1  | 0  | 1   |
| 4  | 0 | 1 | 0   | 0  | 0  | 2   |
| 4  | 1 | 2 | 0   | 0  | 0  | 1   |
| 4  | 0 | 0 | 0   | 0  | 0  | 3   |
| 4  | 1 | 0 | 0   | 0  | 1  | 4   |
| 3  | 1 | 3 | 2   | 1  | 0  | 0   |
| 3  | 0 | 0 | 0   | 0  | 1  | 5   |
| 3  | 0 | 2 | 1   | 0  | 0  | 1   |

|            |           |
|------------|-----------|
| <b>AB</b>  | <b>32</b> |
| <b>R</b>   | <b>3</b>  |
| <b>H</b>   | <b>8</b>  |
| <b>RBI</b> | <b>3</b>  |
| <b>BB</b>  | <b>2</b>  |
| <b>SO</b>  | <b>2</b>  |
| <b>LOB</b> | <b>19</b> |



| WP | HR | S | P  | ERA | WHIP |
|----|----|---|----|-----|------|
| 0  | 0  | 1 | 35 | 0   | 0    |

**Cincinnati Reds @ New York Giants**  
**Polo Grounds, New York, NY**  
 Wed Jul 26 1950, 3:33 AM EDT  
 Att. 4,852 - Cloudy - 78 F

[livebaseballscorecards.com](http://livebaseballscorecards.com)

| Batter   | 1   | 2   | 3   | 4  | 5   | 6   | 7   | 8   | 9   | AB R H RBI BB SO LOB                                       | TOP                                     |                |   |
|--|---|---|---|--|---|---|---|---|---|--|---|----------------|---|
| <b>Bobby Adams, R</b> (1, 5)<br>OBP: 0.326, SLG: 0.340<br><b>Grady Hatton, L</b> (7, 5)<br>OBP: 0.347, SLG: 0.421    | 0-0<br>F9   |   | 0-0<br>F7   | 0-0<br>5-3   |   |   | 0-0<br>2B   | 0-0<br>1-3  |   | 4 1 1 0 0 0 2<br>1 0 0 0 0 0 0                             |   |                |   |
| <b>Peanuts Lowrey, R</b> (1, 9)<br>OBP: 0.328, SLG: 0.304  | 4-0<br>BB   |   | 0-0<br>F5   |  | 0-0<br>1-3  |   | 0-0<br>2B   | 0-0<br>4-3  |   | 4 1 1 2 1 0 0  |   |                |   |
| <b>Bob Usher, R</b> (1, 8)<br>OBP: 0.326, SLG: 0.397   | 0-0<br>F8   |   | 0-0<br>F5   |  | 0-0<br>F7   |   | 0-0<br>1-3  | 0-0<br>1-3  |   | 5 0 0 0 0 0 2  |   |                |   |
| <b>Ted Kluszewski, L</b> (1, 3)<br>OBP: 0.348, SLG: 0.556  | 0-0<br>4-3  |   |   | 0-0<br>E3<br>1B S<br>FC5-4                           | 0-0<br>F5   |   | 0-0<br>E4<br>2B                                       |   | 0-0<br>F8   | 5 2 0 0 0 0 2  |   |                |   |
| <b>Connie Ryan, R</b> (1, 4)<br>OBP: 0.381, SLG: 0.393   |   | 0-0<br>2B<br>1B                                     |   | 0-0<br>FC5-4<br>1B                                   |   | 0-0<br>F5   | 0-3<br>K  |   | 0-3<br>K  | 5 1 2 0 0 2 2  |   |                |   |
| <b>Joe Adcock, R</b> (1, 7)<br>OBP: 0.306, SLG: 0.386  |   | 0-3<br>K  |   | 0-0<br>FC5-4<br>1B<br>1-2f<br>3-H                    |   | 0-0<br>1B   | 0-0<br>1B<br>2B                                       |   | 0-0<br>F8   | 5 2 2 3 0 1 2  |   |                |   |
| <b>Johnny Pramesa, R</b> (1, 2)<br>OBP: 0.359, SLG: 0.455  |   | 0-0<br>1-H<br>2B                                    |   | 0-0<br>2-3   |   | 0-0<br>F4   | 0-0<br>1B<br>1B                                       |   |   | 4 0 2 2 0 0 2  |   |                |   |
| <b>Virgil Stallcup, R</b> (1, 6)<br>OBP: 0.296, SLG: 0.370   |   | 0-0<br>5-3  |   | 4-0<br>1B<br>IBB                                     |   | 0-0<br>6-3  | 0-0<br>1B<br>1B                                       |   |   | 3 0 1 0 1 0 2  |   |                |   |
| <b>Ewell Blackwell, R</b> (1, 1)<br>OBP: 0.184, SLG: 0.111<br><b>Frank Smith, R</b> (8, 1)<br>OBP: 0.071, SLG: 0.071 |   | 0-0<br>6-3  |   | 0-0<br>1B  |   |   | 0-0<br>1B<br>3-1                                      |   |   | 4 1 2 1 0 0 3<br>0 0 0 0 0 0 0                             |   |                |   |
| <b>Inning Stats</b>  | R: 0 H: 0<br>E: 0 LOB: 1<br>K: 0 BB: 1<br>S: 3 P: 7   | R: 1 H: 2<br>E: 0 LOB: 1<br>K: 1 BB: 0<br>S: 7 P: 7 | R: 0 H: 0<br>E: 0 LOB: 0<br>K: 0 BB: 0<br>S: 3 P: 3 | R: 2 H: 2<br>E: 1 LOB: 2<br>K: 0 BB: 1<br>S: 6 P: 10 | R: 0 H: 0<br>E: 0 LOB: 0<br>K: 0 BB: 0<br>S: 3 P: 3 | R: 0 H: 1<br>E: 0 LOB: 1<br>K: 0 BB: 0<br>S: 4 P: 4 | R: 5 H: 6<br>E: 1 LOB: 2<br>K: 1 BB: 0<br>S: 12 P: 12 | R: 0 H: 0<br>E: 0 LOB: 0<br>K: 0 BB: 0<br>S: 3 P: 3 | R: 0 H: 0<br>E: 0 LOB: 0<br>K: 1 BB: 0<br>S: 5 P: 5 | 1B: 7 SF: 0<br>2B: 4 SAC: 0<br>3B: 0 DP: 0<br>HR: 0 HBP: 0 | WP: 0 PA: 42<br>PB: 0<br>SB: 1<br>CS: 0 |                |   |
| <b>PITCHER</b>   | IP WLS BF H R ER SO BB IBB HBP BLK WP HR S P ERA WHIP |   |   |  |   |   |   |   |   |  |   | <b>PITCHER</b> | IP WLS BF H R ER SO BB IBB HBP BLK WP HR S P ERA WHIP |
| <b>Bob Chipman, L</b> (1, 1)<br>ERA: 5.24  | 6.0 L 29 8 6 3 1 1 1 0 0 0 0 0 29 37 4.50 1.500       |   |   |  |   |   |   |   |   |  |   |                |   |
| <b>Ernie Johnson, R</b> (7, 1)<br>ERA: 6.75  | 2.0 10 3 2 0 1 0 0 0 0 0 0 0 12 12 0.00 1.500         |   |   |  |   |   |   |   |   |  |   |                |   |
| <b>Normie Roy, R</b> (9, 1)<br>ERA: 5.36   | 1.0 3 0 0 0 0 1 0 0 0 0 0 0 5 5 0.00 0.000            |   |   |  |   |   |   |   |   |  |   |                |   |

**Cincinnati Reds @ Boston Braves**  
 Braves Field, Boston, MA  
 Fri Jul 28 1950, 3:33 AM EDT  
 Att. 13,505 - Unknown

livebaseballscorecards.com

|            |           |
|------------|-----------|
| <b>AB</b>  | <b>40</b> |
| <b>R</b>   | <b>8</b>  |
| <b>H</b>   | <b>11</b> |
| <b>RBI</b> | <b>8</b>  |
| <b>BB</b>  | <b>2</b>  |
| <b>SO</b>  | <b>3</b>  |
| <b>LOB</b> | <b>17</b> |



| Batter  | 1               | 2              | 3                | 4                | 5               | 6               | 7              | 8                          | 9                | AB R H RBI BB SO LOB  |
|---|-----------------|----------------|------------------|------------------|-----------------|-----------------|----------------|----------------------------|------------------|---|
| Roy Hartsfield, R<br>OBP: 0.342, SLG: 0.390<br>(1, 4)   | 0-0<br>4-3<br>① |                | 4-0<br>BB<br>BBB |                  |                 | 0-0<br>1-3<br>① |                | 0-0<br>HR<br>1B<br>2-H     | 0-3<br>K<br>②    | 4 1 1 1 1 1 1   |
| Sam Jethroe, S<br>OBP: 0.358, SLG: 0.466<br>(1, 8)  | 0-3<br>K<br>②   |                | 0-0<br>F5<br>③   |                  |                 | 0-0<br>2B<br>②  |                | 0-0<br>HR<br>1B<br>1-2     | 0-0<br>E8<br>1-H | 5 1 2 0 0 1 1   |
| Earl Torgeson, L<br>OBP: 0.400, SLG: 0.458<br>(1, 3)  | 0-3<br>K<br>③   |                |                  |                  | 0-3<br>K<br>①   | 0-3<br>K<br>②   |                | 0-0<br>HR<br>1-H<br>2-H    | 0-0<br>F7<br>③   | 5 1 1 3 0 3 2   |
| Bob Elliott, R<br>OBP: 0.370, SLG: 0.495<br>(1, 5)  |                 | 0-0<br>2B<br>① |                  | 0-0<br>1-3<br>②  |                 | 0-0<br>6-3<br>③ |                | 4-0<br>FC6-4<br>BB<br>BBB  |                  | 3 0 1 0 1 0 1   |
| Sid Gordon, R<br>OBP: 0.420, SLG: 0.589<br>(1, 7)   |                 | 0-0<br>F9<br>① |                  | 4-0<br>BB<br>BBB |                 |                 | 0-3<br>K<br>①  | 0-0<br>FC6-4<br>1B<br>1-2f |                  | 3 0 0 0 1 1 2   |
| Tommy Holmes, L<br>OBP: 0.392, SLG: 0.473<br>(1, 9)   |                 | 0-0<br>F8<br>② |                  | 0-0<br>F8<br>③   |                 |                 | 0-0<br>F7<br>② | 0-0<br>1B<br>1-2           |                  | 4 0 1 0 0 0 2   |
| Del Crandall, R<br>OBP: 0.269, SLG: 0.344<br>(1, 2)   |                 | 0-0<br>F4<br>③ |                  |                  | 0-0<br>F4<br>①  |                 | 0-3<br>K<br>③  | 0-3<br>K<br>③              |                  | 4 0 0 0 0 2 3   |
| Buddy Kerr, R<br>OBP: 0.277, SLG: 0.288<br>Walker Cooper, R<br>OBP: 0.367, SLG: 0.506<br>(9, PH)  |                 |                | 0-3<br>K<br>①    |                  | 0-0<br>4-3<br>② |                 |                | 0-3<br>K<br>①              | 0-3<br>K<br>①    | 3 0 0 0 0 2 0<br>1 0 0 0 0 1 0  |
| Bob Chipman, L<br>OBP: 0.240, SLG: 0.174<br>Ernie Johnson, R<br>OBP: 0.500, SLG: 0.500<br>Willard Marshall, L<br>OBP: 0.333, SLG: 0.365<br>Normie Roy, R<br>OBP: 0.267, SLG: 0.214<br>Pete Reiser, L<br>OBP: 0.377, SLG: 0.291<br>(9, PH) |                 |                | 0-0<br>F4<br>②   |                  | 0-3<br>K<br>③   |                 |                | 0-0<br>1B<br>2B<br>BBB     | 4-0<br>E<br>BB   | 2 0 0 0 0 1 0<br>0 0 0 0 0 0 0<br>1 1 1 0 0 0 0<br>0 0 0 0 0 0 0<br>0 1 0 0 1 0 0 |

| Inning Stats | R: 0<br>E: 0<br>K: 2<br>S: 7 | H: 0<br>LOB: 0<br>BB: 0<br>P: 7 | R: 0<br>E: 0<br>K: 0<br>S: 4 | H: 1<br>LOB: 1<br>BB: 0<br>P: 4 | R: 0<br>E: 0<br>K: 1<br>S: 5 | H: 0<br>LOB: 1<br>BB: 1<br>P: 9 | R: 0<br>E: 0<br>K: 1<br>S: 5 | H: 0<br>LOB: 0<br>BB: 0<br>P: 5 | R: 0<br>E: 0<br>K: 1<br>S: 6 | H: 1<br>LOB: 1<br>BB: 0<br>P: 6 | R: 0<br>E: 0<br>K: 2<br>S: 7 | H: 0<br>LOB: 0<br>BB: 0<br>P: 7 | R: 4<br>E: 0<br>K: 2<br>S: 12 | H: 5<br>LOB: 2<br>BB: 1<br>P: 16 | R: 1<br>E: 1<br>K: 2<br>S: 8 | H: 0<br>LOB: 1<br>BB: 1<br>P: 12 | 1B: 3<br>2B: 3<br>3B: 0<br>HR: 1 | SF: 0<br>SAC: 0<br>DP: 0<br>HBP: 0 |
|--------------|------------------------------|---------------------------------|------------------------------|---------------------------------|------------------------------|---------------------------------|------------------------------|---------------------------------|------------------------------|---------------------------------|------------------------------|---------------------------------|-------------------------------|----------------------------------|------------------------------|----------------------------------|----------------------------------|------------------------------------|
|--------------|------------------------------|---------------------------------|------------------------------|---------------------------------|------------------------------|---------------------------------|------------------------------|---------------------------------|------------------------------|---------------------------------|------------------------------|---------------------------------|-------------------------------|----------------------------------|------------------------------|----------------------------------|----------------------------------|------------------------------------|

| PITCHER                                   | IP  | WLS | BF | H | R | ER | SO | BB | IBB | HBP | BLK | WP | HR | S  | P  | ERA  | WHIP  |
|---|-----|-----|----|---|---|----|----|----|-----|-----|-----|----|----|----|----|------|-------|
| Ewell Blackwell, R<br>ERA: 3.95<br>(1, 1) | 7.2 | W   | 33 | 7 | 4 | 4  | 9  | 3  | 0   | 0   | 0   | 0  | 1  | 48 | 60 | 4.70 | 1.304 |
| Frank Smith, R<br>ERA: 3.46<br>(8, 1)     | 1.1 | S   | 6  | 0 | 1 | 0  | 3  | 1  | 0   | 0   | 0   | 0  | 0  | 11 | 15 | 0.00 | 0.750 |

**BOTTOM**

**Cincinnati Reds @ Boston Braves**  
 Braves Field, Boston, MA  
 Fri Jul 28 1950, 3:33 AM EDT  
 Att. 13,505 - Unknown

|            |           |
|------------|-----------|
| <b>AB</b>  | <b>35</b> |
| <b>R</b>   | <b>5</b>  |
| <b>H</b>   | <b>7</b>  |
| <b>RBI</b> | <b>4</b>  |
| <b>BB</b>  | <b>4</b>  |
| <b>SO</b>  | <b>12</b> |
| <b>LOB</b> | <b>12</b> |



| WP | PA | ERA | WHIP |
|----|----|-----|------|
| 0  | 39 |     |      |
| 0  |    |     |      |
| 0  |    |     |      |

| Batter  | 1   | 2   | 3   | 4   | 5   | 6   | 7   | 8   | 9  | AB R H RBI BB SO LOB                            | TOP   |
|---|---|---|---|---|---|---|---|---|--|---|---|
| Lloyd Merriman, L (1, 9)<br>OBP: 0.315, SLG: 0.364  | 0-0<br>F9<br>2B                                       |   | 0-0<br>G3-6-3<br>1-2f                               |   | 0-0<br>F7   |   |   | 0-0<br>4-3  |  | 4 0 1 0 0 0 3                                   | <b>Cincinnati Reds @ Boston Braves</b><br>Braves Field, Boston, MA<br>Sat Jul 29 1950, 3:33 AM EDT<br>Att. 6,394 - Sunny - 89 F |
| Grady Hatton, L (1, 5)<br>OBP: 0.342, SLG: 0.415  | 0-0<br>F9<br>2-3                                      |   | 0-0<br>F8   |   | 0-0<br>F8   |   |   | 0-0<br>G3   |  | 4 0 0 0 0 0 3                                   |   |
| Bob Usher, R (1, 8)<br>OBP: 0.320, SLG: 0.389   | 0-0<br>F3   |   |   | 0-0<br>F7   |   | 0-0<br>5-3  |   | 0-0<br>F2   |  | 4 0 0 0 0 0 1                                   |   |
| Ted Kluszewski, L (1, 3)<br>OBP: 0.354, SLG: 0.569  | 0-0<br>4-3  |   |   | 0-0<br>HR   |   | 0-0<br>FC6-4<br>1B                                  |   | 0-0<br>G6-3<br>1B                                   |  | 4 1 3 1 0 0 1                                   |   |
| Connie Ryan, R (1, 4)<br>OBP: 0.377, SLG: 0.387   |   | 0-0<br>6-3  |   | 0-3<br>K  |   | 0-0<br>FC6-4<br>1-2f                                |   | 0-3<br>K  |  | 4 0 0 0 0 2 2                                   |   |
| Joe Adcock, R (1, 7)<br>OBP: 0.298, SLG: 0.375  |   | 0-0<br>5-3  |   | 0-0<br>F7   |   | 0-0<br>6-3  |   | 0-0<br>G6-3<br>1-2f                                 |  | 4 0 0 0 0 0 2                                   |   |
| Johnny Pramesa, R (1, 2)<br>OBP: 0.366, SLG: 0.463  |   | 0-0<br>2B   |   |   | 4-0<br>1B G3<br>BB                                  |   | 0-0<br>F7   |   |  | 2 0 1 0 1 0 0                                   |   |
| Virgil Stallcup, R (1, 6)<br>OBP: 0.294, SLG: 0.366   |   | 0-0<br>6-3  |   |   | 0-0<br>G3<br>1-2                                    |   | 0-0<br>6-3  |   |  | 3 0 0 0 0 0 2                                   |   |
| Herm Wehmeier, R (1, 1)<br>OBP: 0.222, SLG: 0.258<br>Bob Scheffing, R (5, PH)<br>OBP: 0.322, SLG: 0.400<br>Johnny Hetki, R (5, 1)<br>OBP: 0.222, SLG: 0.125 |   |   | 0-0<br>G3-6-3<br>1B                                 |   | 0-0<br>1B   |   | 0-0<br>5-3  |   |  | 1 0 1 0 0 0 0<br>1 0 1 0 0 0 0<br>1 0 0 0 0 0 0 |   |
| <b>Inning Stats</b>   | R: 0 H: 1<br>E: 0 LOB: 1<br>K: 0 BB: 0<br>S: 4 P: 4   | R: 0 H: 1<br>E: 0 LOB: 1<br>K: 0 BB: 0<br>S: 4 P: 4 | R: 0 H: 1<br>E: 0 LOB: 0<br>K: 0 BB: 0<br>S: 3 P: 3 | R: 1 H: 1<br>E: 0 LOB: 0<br>K: 1 BB: 0<br>S: 6 P: 6 | R: 0 H: 1<br>E: 0 LOB: 2<br>K: 0 BB: 1<br>S: 4 P: 8 | R: 0 H: 1<br>E: 0 LOB: 1<br>K: 0 BB: 0<br>S: 4 P: 4 | R: 0 H: 0<br>E: 0 LOB: 0<br>K: 0 BB: 0<br>S: 3 P: 3 | R: 0 H: 0<br>E: 0 LOB: 0<br>K: 1 BB: 0<br>S: 5 P: 5 | 1B: 4 SF: 0<br>2B: 2 SAC: 0<br>3B: 0 DP: 2<br>HR: 1 HBP: 0 | WP: 0 PA: 33<br>PB: 0<br>SB: 0<br>CS: 0         |   |
| <b>PITCHER</b><br>Johnny Sain, R (1, 1)<br>ERA: 4.16  | IP WLS BF H R ER SO BB IBB HBP BLK WP HR S P ERA WHIP |   |   |   |   |   |   |   |  |   |   |
|   | 9.0 W 33 7 1 1 2 1 0 0 0 0 1 36 40 1.00 0.889         |   |   |   |   |   |   |   |  |   |   |

|            |    |
|------------|----|
| <b>AB</b>  | 32 |
| <b>R</b>   | 1  |
| <b>H</b>   | 7  |
| <b>RBI</b> | 1  |
| <b>BB</b>  | 1  |
| <b>SO</b>  | 2  |
| <b>LOB</b> | 14 |





| Batter   | 1  | 2                                | 3                            | 4                               | 5                            | 6                               | 7                            | 8                               | 9                            | AB R H RBI BB SO LOB            | TOP                          |                                 |                              |                                 |                              |                                 |                                  |                                    |                                  |        |
|--|--|----------------------------------|------------------------------|---------------------------------|------------------------------|---------------------------------|------------------------------|---------------------------------|------------------------------|---------------------------------|------------------------------|---------------------------------|------------------------------|---------------------------------|------------------------------|---------------------------------|----------------------------------|------------------------------------|----------------------------------|--------|
| Lloyd Merriman, L (1, 7)<br>OBP: 0.308, SLG: 0.354     | 0-0<br>6-3   | 0-0<br>F2                        |                              |                                 | 0-0<br>1-3                   |                                 | 0-0<br>F5                    |                                 |                              | 4 0 0 0 0 0 1                   |                              |                                 |                              |                                 |                              |                                 |                                  |                                    |                                  |        |
| Grady Hatton, L (1, 5)<br>OBP: 0.344, SLG: 0.414       | 4-0<br>4-3<br>E<br>BB  |                                  | 0-0<br>F9                    |                                 | 0-0<br>3-1                   |                                 |                              | 0-0<br>L4-3<br>1B               |                              | 3 1 1 0 1 0 0                   |                              |                                 |                              |                                 |                              |                                 |                                  |                                    |                                  |        |
| Johnny Wyrostek, L (1, 9)<br>OBP: 0.399, SLG: 0.460    | 0-0<br>4-3   |                                  | 0-0<br>4-3                   |                                 | 4-0<br>BB                    |                                 |                              | 0-0<br>L4-3<br>1-2              |                              | 3 0 0 0 1 0 2                   |                              |                                 |                              |                                 |                              |                                 |                                  |                                    |                                  |        |
| Ted Kluszewski, L (1, 3)<br>OBP: 0.352, SLG: 0.563     | 4-0<br>E<br>IBB  |                                  | 0-0<br>F8                    |                                 | 0-0<br>F5                    |                                 |                              | 0-0<br>4-3                      |                              | 3 0 0 0 1 0 1                   |                              |                                 |                              |                                 |                              |                                 |                                  |                                    |                                  |        |
| Connie Ryan, R (1, 4)<br>OBP: 0.378, SLG: 0.386        | 0-0<br>E5<br>1-3<br>2-H  |                                  |                              | 0-0<br>1B<br>FC4-6<br>1B        |                              | 0-0<br>5-3                      |                              | 4-0<br>FC5-4<br>BB              |                              | 3 1 1 0 1 0 1                   |                              |                                 |                              |                                 |                              |                                 |                                  |                                    |                                  |        |
| Bob Usher, R (1, 8)<br>OBP: 0.319, SLG: 0.387          | 0-3<br>K   |                                  |                              | 0-0<br>1-3<br>FC4-6<br>1B       |                              | 0-0<br>F6                       |                              | 0-0<br>F7                       |                              | 4 0 1 0 0 1 3                   |                              |                                 |                              |                                 |                              |                                 |                                  |                                    |                                  |        |
| Virgil Stallcup, R (1, 6)<br>OBP: 0.290, SLG: 0.361    |  | 0-0<br>F7                        |                              | 0-0<br>F4                       |                              | 0-0<br>F8                       |                              | 0-0<br>FC5-4<br>1-2f            |                              | 4 0 0 0 0 0 3                   |                              |                                 |                              |                                 |                              |                                 |                                  |                                    |                                  |        |
| Hobie Landrith, L (1, 2)<br>OBP: 0.250, SLG: 0.250     |  | 0-0<br>1B                        |                              | 0-0<br>FC4-6<br>1-2f<br>3-H     |                              | 0-0<br>F8                       |                              | 0-0<br>F8                       |                              | 4 0 1 1 0 0 2                   |                              |                                 |                              |                                 |                              |                                 |                                  |                                    |                                  |        |
| Ken Raffensberger, R (1, 1)<br>OBP: 0.204, SLG: 0.180  |  | 0-0<br>F6                        |                              | 0-0<br>F6                       |                              | 0-3<br>K                        |                              |                                 |                              | 3 0 0 0 0 1 2                   |                              |                                 |                              |                                 |                              |                                 |                                  |                                    |                                  |        |
| <b>Inning Stats</b>                                    | R: 1<br>E: 1<br>K: 1<br>S: 6   | H: 0<br>LOB: 2<br>BB: 2<br>P: 14 | R: 0<br>E: 0<br>K: 0<br>S: 4 | H: 1<br>LOB: 1<br>BB: 0<br>P: 4 | R: 0<br>E: 0<br>K: 0<br>S: 3 | H: 0<br>LOB: 0<br>BB: 0<br>P: 3 | R: 1<br>E: 0<br>K: 0<br>S: 5 | H: 2<br>LOB: 1<br>BB: 0<br>P: 5 | R: 0<br>E: 0<br>K: 0<br>S: 3 | H: 0<br>LOB: 1<br>BB: 1<br>P: 7 | R: 0<br>E: 0<br>K: 1<br>S: 5 | H: 0<br>LOB: 0<br>BB: 0<br>P: 5 | R: 0<br>E: 0<br>K: 0<br>S: 3 | H: 1<br>LOB: 0<br>BB: 0<br>P: 3 | R: 0<br>E: 0<br>K: 0<br>S: 3 | H: 0<br>LOB: 1<br>BB: 1<br>P: 7 | 1B: 4<br>2B: 1<br>3B: 0<br>HR: 0 | SF: 0<br>SAC: 0<br>DP: 1<br>HBP: 0 | WP: 0<br>PB: 0<br>SB: 0<br>CS: 0 | PA: 35 |
| <b>PITCHER</b><br>Vern Bickford, R (1, 1)<br>ERA: 3.31 | IP: 9.0<br>WLS: W<br>BF: 35<br>H: 4<br>R: 2<br>ER: 1<br>SO: 2<br>BB: 3<br>IBB: 1<br>HBP: 0<br>BLK: 0<br>WP: 0<br>HR: 0<br>S: 35<br>P: 51<br>ERA: 1.00<br>WHIP: 0.778 |                                  |                              |                                 |                              |                                 |                              |                                 |                              |                                 |                              |                                 |                              |                                 |                              |                                 |                                  |                                    |                                  |        |

Cincinnati Reds @ Boston Braves  
 Braves Field, Boston, MA  
 Sun Jul 30 1950, 3:33 AM EDT  
 Sunny - 96 F

livebaseballscorecards.com

|     |    |
|-----|----|
| AB  | 31 |
| R   | 2  |
| H   | 4  |
| RBI | 1  |
| BB  | 4  |
| SO  | 2  |
| LOB | 15 |





| Batter   | 1   | 2   | 3   | 4   | 5   | 6 | 7   | 8 | 9 | AB | R | H | RBI | BB | SO | LOB |
|--|-----|-----|-----|-----|-----|---|-----|---|---|----|---|---|-----|----|----|-----|
| <b>Roy Hartsfield, R</b><br>OBP: 0.338, SLG: 0.383<br>(1, 4) | 0-3 |     | 0-0 |     | 0-0 |   | 0-0 |   |   | 4  | 0 | 0 | 1   | 0  | 1  | 1   |
| <b>Sam Jethroe, S</b><br>OBP: 0.354, SLG: 0.465<br>(1, 8)    | 0-0 |     | 0-0 |     | 0-0 |   | 0-0 |   |   | 4  | 0 | 1 | 0   | 0  | 0  | 1   |
| <b>Earl Torgeson, L</b><br>OBP: 0.404, SLG: 0.490<br>(1, 3)  | 0-0 |     | 0-3 |     |     |   |     |   |   | 4  | 1 | 1 | 1   | 0  | 1  | 1   |
| <b>Bob Elliott, R</b><br>OBP: 0.372, SLG: 0.500<br>(1, 5)    | 0-0 |     | 0-0 | 0-0 |     |   |     |   |   | 4  | 1 | 1 | 1   | 0  | 0  | 0   |
| <b>Sid Gordon, R</b><br>OBP: 0.418, SLG: 0.583<br>(1, 7)     |     | 0-0 |     | 0-0 |     |   |     |   |   | 4  | 0 | 1 | 0   | 0  | 0  | 0   |
| <b>Luis Olmo, R</b><br>OBP: 0.354, SLG: 0.417<br>(1, 9)      |     | 0-0 |     | 0-3 |     |   |     |   |   | 4  | 1 | 2 | 1   | 0  | 1  | 1   |
| <b>Del Crandall, R</b><br>OBP: 0.276, SLG: 0.351<br>(1, 2)   |     | 0-0 |     |     |     |   |     |   |   | 3  | 1 | 2 | 0   | 0  | 0  | 2   |
| <b>Buddy Kerr, R</b><br>OBP: 0.277, SLG: 0.285<br>(1, 6)     |     | 0-0 |     |     |     |   |     |   |   | 2  | 0 | 0 | 0   | 0  | 0  | 3   |
| <b>Vern Bickford, R</b><br>OBP: 0.110, SLG: 0.071<br>(1, 1)  |     | 0-0 |     |     |     |   |     |   |   | 2  | 0 | 0 | 0   | 0  | 0  | 1   |

| Inning Stats | R: 1<br>E: 0<br>K: 1<br>S: 6 | H: 1<br>LOB: 0<br>BB: 0<br>P: 6 | R: 1<br>E: 0<br>K: 0<br>S: 5 | H: 2<br>LOB: 1<br>BB: 0<br>P: 5 | R: 0<br>E: 0<br>K: 1<br>S: 5 | H: 1<br>LOB: 0<br>BB: 0<br>P: 5 | R: 0<br>E: 0<br>K: 1<br>S: 5 | H: 0<br>LOB: 0<br>BB: 0<br>P: 5 | R: 1<br>E: 0<br>K: 0<br>S: 5 | H: 1<br>LOB: 1<br>BB: 0<br>P: 5 | R: 1<br>E: 1<br>K: 0<br>S: 6 | H: 2<br>LOB: 2<br>BB: 0<br>P: 6 | R: 0<br>E: 0<br>K: 0<br>S: 3 | H: 0<br>LOB: 0<br>BB: 0<br>P: 3 | R: 0<br>E: 0<br>K: 0<br>S: 4 | H: 1<br>LOB: 1<br>BB: 0<br>P: 4 | 1B: 5<br>2B: 0<br>3B: 0<br>HR: 3 | SF: 0<br>SAC: 2<br>DP: 0<br>HBP: 0 |
|--------------|------------------------------|---------------------------------|------------------------------|---------------------------------|------------------------------|---------------------------------|------------------------------|---------------------------------|------------------------------|---------------------------------|------------------------------|---------------------------------|------------------------------|---------------------------------|------------------------------|---------------------------------|----------------------------------|------------------------------------|
|--------------|------------------------------|---------------------------------|------------------------------|---------------------------------|------------------------------|---------------------------------|------------------------------|---------------------------------|------------------------------|---------------------------------|------------------------------|---------------------------------|------------------------------|---------------------------------|------------------------------|---------------------------------|----------------------------------|------------------------------------|

| PITCHER  | IP  | WLS | BF | H | R | ER | SO | BB | IBB | HBP | BLK | WP | HR | S  | P  | ERA  | WHIP  |
|--|-----|-----|----|---|---|----|----|----|-----|-----|-----|----|----|----|----|------|-------|
| <b>Ken Raffensberger, L</b><br>ERA: 4.21<br>(1, 1) | 8.0 | L   | 33 | 8 | 4 | 4  | 3  | 0  | 0   | 0   | 0   | 0  | 3  | 39 | 39 | 4.50 | 1.000 |

**BOTTOM**

**Cincinnati Reds @ Boston Braves**  
Braves Field, Boston, MA  
Sun Jul 30 1950, 3:33 AM EDT  
Sunny - 96 F

|            |           |
|------------|-----------|
| <b>AB</b>  | <b>31</b> |
| <b>R</b>   | <b>4</b>  |
| <b>H</b>   | <b>8</b>  |
| <b>RBI</b> | <b>4</b>  |
| <b>BB</b>  | <b>0</b>  |
| <b>SO</b>  | <b>3</b>  |
| <b>LOB</b> | <b>10</b> |

[livebaseballscorecards.com](http://livebaseballscorecards.com)

|       |        |
|-------|--------|
| WP: 0 | PA: 34 |
| PB: 0 |        |
| SB: 2 |        |
| CS: 0 |        |

| Batter  | 1   | 2                               | 3                            | 4                               | 5                            | 6                               | 7                            | 8                               | 9                            | AB R H RBI BB SO LOB            | TOP                          |                                 |                              |                                 |                              |                                 |                                  |                                    |                                  |        |
|---|---|---------------------------------|------------------------------|---------------------------------|------------------------------|---------------------------------|------------------------------|---------------------------------|------------------------------|---------------------------------|------------------------------|---------------------------------|------------------------------|---------------------------------|------------------------------|---------------------------------|----------------------------------|------------------------------------|----------------------------------|--------|
| Bobby Adams, R (1, 5)<br>OBP: 0.329, SLG: 0.340           | 0-0<br>CS<br>1B                                       |                                 |                              | 0-0<br>F7                       |                              | 0-0<br>F9                       |                              |                                 | 4-0<br>BB<br>1B              | 3 0 1 0 1 0 1                   |                              |                                 |                              |                                 |                              |                                 |                                  |                                    |                                  |        |
| Peanuts Lowrey, R (1, 9)<br>OBP: 0.327, SLG: 0.303        | 0-0<br>F7<br>1-2                                      |                                 |                              | 0-0<br>F7                       |                              |                                 | 0-0<br>F6                    |                                 | 0-0<br>G5-4-3<br>1B          | 4 0 1 0 0 0 1                   |                              |                                 |                              |                                 |                              |                                 |                                  |                                    |                                  |        |
| Bob Usher, R (1, 8)<br>OBP: 0.313, SLG: 0.380             | 0-0<br>F7   |                                 |                              | 0-0<br>F8                       |                              |                                 | 0-0<br>4-3                   |                                 | 0-0<br>G5-4-3<br>1-2f        | 4 0 0 0 0 0 2                   |                              |                                 |                              |                                 |                              |                                 |                                  |                                    |                                  |        |
| Ted Kluszewski, L (1, 3)<br>OBP: 0.349, SLG: 0.558        |   | 0-0<br>1-3                      |                              |                                 | 0-0<br>6-3                   |                                 |                              | 0-0<br>4-3                      |                              | 3 0 0 0 0 0 0                   |                              |                                 |                              |                                 |                              |                                 |                                  |                                    |                                  |        |
| Connie Ryan, R (1, 4)<br>OBP: 0.379, SLG: 0.387           |   | 0-0<br>1B                       |                              |                                 | 0-0<br>F5                    |                                 |                              | 0-0<br>F6                       |                              | 2 0 1 0 0 0 0                   |                              |                                 |                              |                                 |                              |                                 |                                  |                                    |                                  |        |
| Grady Hatton, L (7, 4)<br>OBP: 0.343, SLG: 0.412          |   |                                 |                              |                                 |                              |                                 |                              |                                 |                              | 1 0 0 0 0 0 0                   |                              |                                 |                              |                                 |                              |                                 |                                  |                                    |                                  |        |
| Joe Adcock, R (1, 7)<br>OBP: 0.292, SLG: 0.367            |   | 0-0<br>4-3                      |                              |                                 | 0-0<br>4-3                   |                                 |                              | 0-0<br>F8                       |                              | 3 0 0 0 0 0 0                   |                              |                                 |                              |                                 |                              |                                 |                                  |                                    |                                  |        |
| Virgil Stallcup, R (1, 6)<br>OBP: 0.288, SLG: 0.359       |   |                                 | 0-0<br>4-3                   |                                 |                              | 0-0<br>F9                       |                              | 0-0<br>FC6-4<br>1B              |                              | 2 0 0 0 0 0 0                   |                              |                                 |                              |                                 |                              |                                 |                                  |                                    |                                  |        |
| Sammy Meeks, R (6, 6)<br>OBP: 0.317, SLG: 0.395           |   |                                 |                              |                                 |                              |                                 |                              |                                 |                              | 1 0 1 0 0 0 0                   |                              |                                 |                              |                                 |                              |                                 |                                  |                                    |                                  |        |
| Dixie Howell, R (1, 2)<br>OBP: 0.304, SLG: 0.254          |   |                                 | 0-0<br>L4                    |                                 |                              | 0-0<br>F4                       |                              | 0-0<br>FC6-4<br>1-2f            |                              | 3 0 0 0 0 0 1                   |                              |                                 |                              |                                 |                              |                                 |                                  |                                    |                                  |        |
| Howie Fox, R (1, 1)<br>OBP: 0.205, SLG: 0.308             |   |                                 | 0-0<br>6-3                   |                                 |                              | 0-0<br>1B                       |                              |                                 | 0-0<br>F9                    | 1 0 0 0 0 0 0                   |                              |                                 |                              |                                 |                              |                                 |                                  |                                    |                                  |        |
| Eddie Erault, R (3, 1)<br>OBP: 0.286, SLG: 0.429          |   |                                 |                              |                                 |                              |                                 |                              |                                 |                              | 0 0 0 0 0 0 0                   |                              |                                 |                              |                                 |                              |                                 |                                  |                                    |                                  |        |
| Harry Perkowski, L (5, 1)<br>OBP: 0.400, SLG: 0.368       |   |                                 |                              |                                 |                              |                                 |                              |                                 |                              | 1 0 1 0 0 0 0                   |                              |                                 |                              |                                 |                              |                                 |                                  |                                    |                                  |        |
| Danny Litwhiler, R (9, PH)<br>OBP: 0.390, SLG: 0.481      |   |                                 |                              |                                 |                              |                                 |                              |                                 |                              | 1 0 0 0 0 0 0                   |                              |                                 |                              |                                 |                              |                                 |                                  |                                    |                                  |        |
| <b>Inning Stats</b>                                       | R: 0<br>E: 0<br>K: 0<br>S: 3                          | H: 1<br>LOB: 0<br>BB: 0<br>P: 3 | R: 0<br>E: 0<br>K: 0<br>S: 3 | H: 1<br>LOB: 0<br>BB: 0<br>P: 3 | R: 0<br>E: 0<br>K: 0<br>S: 3 | H: 0<br>LOB: 0<br>BB: 0<br>P: 3 | R: 0<br>E: 0<br>K: 0<br>S: 3 | H: 0<br>LOB: 0<br>BB: 0<br>P: 3 | R: 0<br>E: 0<br>K: 0<br>S: 4 | H: 1<br>LOB: 1<br>BB: 0<br>P: 4 | R: 0<br>E: 0<br>K: 0<br>S: 3 | H: 0<br>LOB: 0<br>BB: 0<br>P: 3 | R: 0<br>E: 0<br>K: 0<br>S: 4 | H: 1<br>LOB: 1<br>BB: 0<br>P: 4 | R: 0<br>E: 0<br>K: 0<br>S: 3 | H: 1<br>LOB: 1<br>BB: 1<br>P: 7 | 1B: 5<br>2B: 0<br>3B: 0<br>HR: 0 | SF: 0<br>SAC: 0<br>DP: 1<br>HBP: 0 | WP: 0<br>PB: 0<br>SB: 0<br>CS: 1 | PA: 30 |
| <b>PITCHER</b><br>Johnny Antonelli, L (1, 1)<br>ERA: 5.93 | IP WLS BF H R ER SO BB IBB HBP BLK WP HR S P ERA WHIP |                                 |                              |                                 |                              |                                 |                              |                                 |                              |                                 |                              |                                 |                              |                                 |                              |                                 |                                  |                                    |                                  |        |

Cincinnati Reds @ Boston Braves  
 Braves Field, Boston, MA  
 Sun Jul 30 1950, 3:38 AM EDT  
 Att. 16,562 - Sunny - 96 F

livebaseballscorecards.com

**AB** 29  
**R** 0  
**H** 5  
**RBI** 0  
**BB** 1  
**SO** 0  
**LOB** 5





| Batter | 1 | 2 | 3 | 4 | 5 | 6 | 7 | 8 | 9 | AB R H RBI BB SO LOB | TOP |
|--------|---|---|---|---|---|---|---|---|---|----------------------|-----|
|--------|---|---|---|---|---|---|---|---|---|----------------------|-----|

|   |                 |            |  |            |            |           |  |                          |  |               |  |
|---|-----------------|------------|--|------------|------------|-----------|--|--------------------------|--|---------------|--|
| <b>Lloyd Merriman, L</b><br>OBP: 0.299, SLG: 0.344<br>(1, 8) x  | 0-0<br>6-3<br>K | 0-3<br>K   |  | 0-3<br>K   |            | 0-0<br>F6 |  | 0-0<br>F8                |  | 5 0 0 0 0 2 2 |  |
| <b>Peanuts Lowrey, R</b><br>OBP: 0.336, SLG: 0.313<br>(1, 7) x  | 0-0<br>3B<br>1B | 0-0<br>1B  |  | 0-0<br>6-3 |            | 0-0<br>1B |  | 0-0<br>FC4-6<br>1B<br>1B |  | 5 1 4 0 0 0 1 |  |
| <b>Johnny Wyrostek, L</b><br>OBP: 0.396, SLG: 0.462<br>(1, 9) x | 0-0<br>F8<br>3B | 0-0<br>4-3 |  |            | 0-0<br>1-3 | 0-0<br>F5 |  | 0-0<br>F7                |  | 5 1 1 1 0 0 3 |  |

|  |                        |  |                   |  |                   |  |                       |  |                                      |               |  |
|--|------------------------|--|-------------------|--|-------------------|--|-----------------------|--|--------------------------------------|---------------|--|
| <b>Ted Kluszewski, L</b><br>OBP: 0.350, SLG: 0.555<br>(1, 3) x | 0-0<br>F8<br>3-H       |  | 0-0<br>3-1        |  | 0-0<br>4-3<br>1B  |  | 0-0<br>4-3            |  | 0-0<br>FC4-6<br>1-2<br>1B            | 5 1 2 1 0 0 0 |  |
| <b>Grady Hatton, L</b><br>OBP: 0.347, SLG: 0.416<br>(1, 5) x   | 0-0<br>E<br>1B<br>1B   |  | 0-0<br>5-3<br>1B  |  | 0-0<br>4-3<br>1-2 |  | 0-0<br>G5-4-3<br>1B   |  | 0-0<br>FC4-6<br>FC6-4<br>1-2f<br>2-3 | 5 1 3 0 0 0 3 |  |
| <b>Connie Ryan, R</b><br>OBP: 0.376, SLG: 0.382<br>(1, 4) x    | 0-0<br>E5<br>1B<br>1-2 |  | 0-0<br>5-3<br>1-2 |  | 0-0<br>1B<br>BB   |  | 0-0<br>G5-4-3<br>1-2f |  | 0-0<br>FC6-4<br>1-2f                 | 4 0 0 0 1 0 5 |  |

|   |                         |  |           |                  |                         |           |  |                 |  |               |  |
|---|-------------------------|--|-----------|------------------|-------------------------|-----------|--|-----------------|--|---------------|--|
| <b>Virgil Stallcup, R</b><br>OBP: 0.291, SLG: 0.361<br>(1, 6) x | 0-0<br>1-3<br>2-H<br>1B |  | 0-0<br>L7 |                  | 0-0<br>1-2<br>2-H<br>1B |           |  | 0-0<br>L8       |  | 4 0 2 2 0 0 1 |  |
| <b>Hobie Landrith, L</b><br>OBP: 0.375, SLG: 0.286<br>(1, 2) x  | 0-0<br>F9               |  |           | 0-0<br>BLK<br>1B |                         | 0-0<br>L9 |  | 4-0<br>BB<br>BB |  | 3 0 1 0 1 0 4 |  |
| <b>Bobby Adams, R</b><br>OBP: 0.329, SLG: 0.340<br>(8, PR)      |                         |  |           |                  |                         |           |  |                 |  | 0 0 0 0 0 0 0 |  |
| <b>Dixie Howell, R</b><br>OBP: 0.304, SLG: 0.254<br>(8, 2)      |                         |  |           |                  |                         |           |  |                 |  | 0 0 0 0 0 0 0 |  |

|   |  |          |  |                  |  |          |  |           |  |                 |  |
|---|--|----------|--|------------------|--|----------|--|-----------|--|-----------------|--|
| <b>Herm Wehmeier, R</b><br>OBP: 0.215, SLG: 0.250<br>(1, 1)   |  | 0-3<br>K |  | 0-0<br>F7<br>1-2 |  | 0-3<br>K |  | 0-0<br>F3 |  | 2 0 0 0 0 0 1 1 |  |
| <b>Frank Smith, R</b><br>OBP: 0.071, SLG: 0.071<br>(5, 1)     |  |          |  |                  |  |          |  |           |  | 0 0 0 0 0 0 0 0 |  |
| <b>Danny Litwiler, R</b><br>OBP: 0.396, SLG: 0.476<br>(6, PH) |  |          |  |                  |  |          |  |           |  | 1 0 0 0 0 0 1 0 |  |
| <b>Johnny Hetki, R</b><br>OBP: 0.222, SLG: 0.125<br>(6, 1)    |  |          |  |                  |  |          |  |           |  | 0 0 0 0 0 0 0 0 |  |
| <b>Bob Usher, R</b><br>OBP: 0.312, SLG: 0.378<br>(8, PH)      |  |          |  |                  |  |          |  |           |  | 1 0 0 0 0 0 0 1 |  |
| <b>Harry Parkowski, L</b><br>OBP: 0.400, SLG: 0.388<br>(8, 1) |  |          |  |                  |  |          |  |           |  | 0 0 0 0 0 0 0 0 |  |

|                     |                              |                                 |                              |                                 |                              |                                 |                              |                                 |                              |                                 |                              |                                 |                              |                                 |                              |                                 |                              |                                 |                                   |                                    |                                  |        |
|---------------------|------------------------------|---------------------------------|------------------------------|---------------------------------|------------------------------|---------------------------------|------------------------------|---------------------------------|------------------------------|---------------------------------|------------------------------|---------------------------------|------------------------------|---------------------------------|------------------------------|---------------------------------|------------------------------|---------------------------------|-----------------------------------|------------------------------------|----------------------------------|--------|
| <b>Inning Stats</b> | R: 3<br>E: 1<br>K: 0<br>S: 8 | H: 4<br>LOB: 2<br>BB: 0<br>P: 8 | R: 0<br>E: 0<br>K: 2<br>S: 8 | H: 1<br>LOB: 1<br>BB: 0<br>P: 8 | R: 0<br>E: 0<br>K: 0<br>S: 4 | H: 1<br>LOB: 1<br>BB: 0<br>P: 4 | R: 0<br>E: 0<br>K: 1<br>S: 6 | H: 1<br>LOB: 1<br>BB: 0<br>P: 6 | R: 1<br>E: 0<br>K: 0<br>S: 5 | H: 2<br>LOB: 2<br>BB: 1<br>P: 9 | R: 0<br>E: 0<br>K: 1<br>S: 6 | H: 1<br>LOB: 1<br>BB: 0<br>P: 6 | R: 0<br>E: 0<br>K: 0<br>S: 3 | H: 1<br>LOB: 0<br>BB: 0<br>P: 3 | R: 0<br>E: 0<br>K: 0<br>S: 3 | H: 0<br>LOB: 1<br>BB: 1<br>P: 7 | R: 0<br>E: 0<br>K: 0<br>S: 5 | H: 2<br>LOB: 2<br>BB: 0<br>P: 5 | 1B: 12<br>2B: 0<br>3B: 1<br>HR: 0 | SF: 0<br>SAC: 0<br>DP: 1<br>HBP: 0 | WP: 0<br>PB: 0<br>SB: 0<br>CS: 0 | PA: 42 |
|---------------------|------------------------------|---------------------------------|------------------------------|---------------------------------|------------------------------|---------------------------------|------------------------------|---------------------------------|------------------------------|---------------------------------|------------------------------|---------------------------------|------------------------------|---------------------------------|------------------------------|---------------------------------|------------------------------|---------------------------------|-----------------------------------|------------------------------------|----------------------------------|--------|

|   |     |     |    |    |   |    |    |    |     |     |     |    |    |    |    |      |       |  |  |     |     |    |   |   |    |    |    |     |     |     |    |    |   |      |       |      |
|---|-----|-----|----|----|---|----|----|----|-----|-----|-----|----|----|----|----|------|-------|--|--|-----|-----|----|---|---|----|----|----|-----|-----|-----|----|----|---|------|-------|------|
| <b>PITCHER</b>                              | IP  | WLS | BF | H  | R | ER | SO | BB | IBB | HBP | BLK | WP | HR | S  | P  | ERA  | WHIP  | <b>PITCHER</b>                                 |  | IP  | WLS | BF | H | R | ER | SO | BB | IBB | HBP | BLK | WP | HR | S | P    | ERA   | WHIP |
| <b>Bob Miller, R</b><br>ERA: 3.09<br>(1, 1) | 8.1 | W   | 40 | 13 | 4 | 3  | 4  | 2  | 0   | 0   | 1   | 0  | 0  | 46 | 54 | 3.24 | 1.800 | <b>Jim Konstanty, R</b><br>ERA: 2.85<br>(9, 1) |  | 0.2 | S   | 2  | 0 | 0 | 0  | 0  | 0  | 0   | 0   | 0   | 0  | 2  | 2 | 0.00 | 0.000 |      |

**Cincinnati Reds @ Philadelphia Phillies**  
 Shibe Park, Philadelphia, PA  
 Tue Aug 01 1950, 3:33 AM EDT  
 Unknown

**AB 40**  
**R 4**  
**H 13**  
**RBI 4**  
**BB 2**  
**SO 4**  
**LOB 21**





| Batter  | 1   |  | 2                            |                                 | 3                            |                                 | 4                            |                                  | 5                            |                                 | 6                            |                                 | 7                            |                                 | 8                            |                                 | 9                            |                                 | AB R H RBI BB SO LOB             | TOP   |                                  |        |
|---|---|--|------------------------------|---------------------------------|------------------------------|---------------------------------|------------------------------|----------------------------------|------------------------------|---------------------------------|------------------------------|---------------------------------|------------------------------|---------------------------------|------------------------------|---------------------------------|------------------------------|---------------------------------|----------------------------------|---|----------------------------------|--------|
| <b>Bobby Adams, R</b> (1, 5)<br>OBP: 0.333, SLG: 0.341<br><b>Grady Hatton, L</b> (7, PH)<br>OBP: 0.348, SLG: 0.420<br>(7, 5)  | 4-0<br>FC3-6<br>BB  | x  | 0-0<br>1B                    | x                               |                              | x                               | 0-0<br>F8                    |                                  |                              |                                 |                              | x                               | 0-0<br>E<br>FC4-6<br>2B      |                                 |                              | x                               | 0-0<br>L8                    |                                 | 2 0 1 0 1 0 1<br>2 1 1 0 0 0 0   | <b>Cincinnati Reds @ Philadelphia Phillies</b><br>Shibe Park, Philadelphia, PA<br>Tue Aug 01 1950, 3:38 AM EDT<br>Att: 34,728 - Unknown<br><a href="http://livebaseballscorecards.com">livebaseballscorecards.com</a> |                                  |        |
| <b>Peanuts Lowrey, R</b> (1, 9)<br>OBP: 0.337, SLG: 0.312<br>(4, 8)   | 0-0<br>FC3-6<br>1B<br>1-2f  | x  | 0-0<br>1B                    | x                               |                              | BB<br>BB<br>BB<br>BB            | 4-0<br>1-2<br>BB             |                                  |                              |                                 |                              | x                               | 0-0<br>E5<br>FC4-6<br>2-3    |                                 |                              | x                               | 0-0<br>B2                    |                                 | 4 1 1 0 1 0 2                    |   |                                  |        |
| <b>Bob Usher, R</b> (1, 8)<br>OBP: 0.314, SLG: 0.379<br><b>Johnny Wyrostek, L</b> (4, PH)<br>OBP: 0.394, SLG: 0.459<br>(4, 9) | 0-0<br>E5<br>1B<br>1-H  | x  | 0-0<br>4-3                   | x                               |                              |                                 | 0-0<br>P6                    |                                  |                              |                                 |                              | x                               | 0-0<br>FC4-6<br>1-2f<br>3-H  |                                 |                              |                                 |                              |                                 | 2 1 1 0 0 0 2<br>2 0 0 1 0 0 3   |   |                                  |        |
| <b>Ted Kluszewski, L</b> (1, 3)<br>OBP: 0.345, SLG: 0.548   | 0-0<br>F5   | x  |                              | x                               |                              |                                 | 0-0<br>F8                    |                                  |                              |                                 |                              | x                               | 0-0<br>L8                    |                                 |                              |                                 |                              |                                 | 4 0 0 0 0 0 2                    |   |                                  |        |
| <b>Connie Ryan, R</b> (1, 4)<br>OBP: 0.375, SLG: 0.380  | 0-0<br>1B<br>2-H  | x  |                              | x                               |                              |                                 | 0-0<br>L8                    |                                  |                              |                                 |                              | x                               | 0-0<br>6-3<br>F7             |                                 |                              |                                 |                              |                                 | 4 0 1 1 0 0 1                    |   |                                  |        |
| <b>Joe Adcock, R</b> (1, 7)<br>OBP: 0.291, SLG: 0.364   | 0-0<br>FC5-4<br>1-2<br>1B   | x  |                              | x                               |                              |                                 | 0-0<br>B1-3                  |                                  |                              |                                 |                              | x                               | 0-0<br>5-3                   |                                 |                              |                                 |                              |                                 | 4 0 1 0 0 0 0                    |   |                                  |        |
| <b>Virgil Stallcup, R</b> (1, 6)<br>OBP: 0.290, SLG: 0.366  | 0-0<br>FC5-4<br>1-2f  | x  |                              | x                               |                              |                                 | 0-0<br>1B<br>3B              |                                  |                              |                                 |                              | x                               | 0-0<br>F7                    |                                 |                              |                                 |                              |                                 | 4 1 1 0 0 0 2                    |   |                                  |        |
| <b>Dixie Howell, R</b> (1, 2)<br>OBP: 0.303, SLG: 0.254   |   | x  | 0-0<br>4-3                   | x                               |                              |                                 | 0-0<br>BB<br>1B<br>3-H       |                                  |                              |                                 |                              | x                               | 0-0<br>F3                    |                                 |                              |                                 |                              |                                 | 4 0 1 1 0 0 0                    |   |                                  |        |
| <b>Ewell Blackwell, R</b> (1, 1)<br>OBP: 0.170, SLG: 0.102  |   |  | 0-3<br>K                     |                                 |                              |                                 | 0-3<br>K                     |                                  |                              |                                 |                              | x                               | 0-0<br>L9                    |                                 |                              |                                 |                              |                                 | 4 0 0 0 0 2 1                    |   |                                  |        |
| <b>Inning Stats</b>   | R: 2<br>E: 1<br>K: 0<br>S: 6  | H: 3<br>LOB: 2<br>BB: 1<br>P: 10                                     | R: 0<br>E: 0<br>K: 1<br>S: 7 | H: 2<br>LOB: 2<br>BB: 0<br>P: 7 | R: 0<br>E: 0<br>K: 0<br>S: 3 | H: 0<br>LOB: 0<br>BB: 0<br>P: 3 | R: 1<br>E: 0<br>K: 1<br>S: 7 | H: 2<br>LOB: 2<br>BB: 1<br>P: 11 | R: 0<br>E: 0<br>K: 0<br>S: 3 | H: 0<br>LOB: 0<br>BB: 0<br>P: 3 | R: 0<br>E: 0<br>K: 0<br>S: 3 | H: 0<br>LOB: 0<br>BB: 0<br>P: 3 | R: 1<br>E: 1<br>K: 0<br>S: 5 | H: 1<br>LOB: 1<br>BB: 0<br>P: 5 | R: 0<br>E: 0<br>K: 0<br>S: 3 | H: 0<br>LOB: 0<br>BB: 0<br>P: 3 | R: 0<br>E: 0<br>K: 0<br>S: 3 | H: 0<br>LOB: 0<br>BB: 0<br>P: 3 | 1B: 6<br>2B: 1<br>3B: 1<br>HR: 0 | SF: 0<br>SAC: 0<br>DP: 0<br>HBP: 0  | WP: 0<br>PB: 0<br>SB: 0<br>CS: 0 | PA: 38 |
| <b>PITCHER</b>  | IP<br>WLS<br>BF<br>H<br>R<br>ER<br>SO<br>BB<br>IBB<br>HBP<br>BLK<br>WP<br>HR<br>S<br>P<br>ERA<br>WHIP | <b>PITCHER</b> IP WLS BF H R ER SO BB IBB HBP BLK WP HR S P ERA WHIP |                              |                                 |                              |                                 |                              |                                  |                              |                                 |                              |                                 |                              |                                 |                              |                                 |                              |                                 |                                  |   |                                  |        |
| <b>Curt Simmons, L</b> (1, 1)<br>ERA: 3.57  | 3.2<br>L<br>20<br>7<br>3<br>2<br>2<br>2<br>0<br>0<br>0<br>0<br>0<br>0<br>22<br>30<br>4.91<br>2.455    |  |                              |                                 |                              |                                 |                              |                                  |                              |                                 |                              |                                 |                              |                                 |                              |                                 |                              |                                 |                                  |   |                                  |        |
| <b>Milo Candini, R</b> (4, 1)<br>ERA: 3.5   | 4.1<br>15<br>1<br>1<br>0<br>0<br>0<br>0<br>0<br>0<br>0<br>0<br>0<br>0<br>15<br>15<br>0.00<br>0.231    |  |                              |                                 |                              |                                 |                              |                                  |                              |                                 |                              |                                 |                              |                                 |                              |                                 |                              |                                 |                                  |   |                                  |        |
| <b>Jim Konstanty, R</b> (9, 1)<br>ERA: 2.82   | 1.0<br>3<br>0<br>0<br>0<br>0<br>0<br>0<br>0<br>0<br>0<br>0<br>0<br>0<br>3<br>3<br>0.00<br>0.000       |  |                              |                                 |                              |                                 |                              |                                  |                              |                                 |                              |                                 |                              |                                 |                              |                                 |                              |                                 |                                  |   |                                  |        |

|     |    |
|-----|----|
| AB  | 36 |
| R   | 4  |
| H   | 8  |
| RBI | 3  |
| BB  | 2  |
| SO  | 2  |
| LOB | 14 |



| Batter   | 1         | 2        | 3                  | 4                | 5         | 6          | 7          | 8         | 9         | AB | R | H | RBI | BB | SO | LOB |
|--|-----------|----------|--------------------|------------------|-----------|------------|------------|-----------|-----------|----|---|---|-----|----|----|-----|
| Eddie Waitkus, L (1, 3)<br>OBP: 0.339, SLG: 0.367  | 0-0<br>2B |          | 0-3<br>K           |                  | 0-0<br>1B |            |            | 0-0<br>1B |           | 4  | 0 | 3 | 0   | 0  | 1  | 1   |
| Richie Ashburn, L (1, 8)<br>OBP: 0.383, SLG: 0.416 | 0-0<br>F9 |          | 0-0<br>F9          |                  | 0-0<br>F5 |            |            | 0-0<br>F8 |           | 4  | 0 | 0 | 0   | 0  | 0  | 4   |
| Dick Sisler, L (1, 7)<br>OBP: 0.399, SLG: 0.486    | 0-0<br>F7 |          |                    | 0-0<br>1-3       |           | 0-0<br>L8  |            | 0-3<br>K  |           | 4  | 0 | 0 | 0   | 0  | 1  | 2   |
| Del Ennis, R (1, 9)<br>OBP: 0.350, SLG: 0.565      | 0-0<br>F7 |          |                    | 4-0<br>6-3<br>BB |           | 0-0<br>P6  |            |           | 0-0<br>L5 | 3  | 0 | 0 | 0   | 1  | 0  | 1   |
| Willie Jones, R (1, 5)<br>OBP: 0.384, SLG: 0.564   |           | 0-3<br>K |                    | 0-0<br>6-3       |           | 0-0<br>5-3 |            |           | 0-0<br>F3 | 4  | 0 | 0 | 0   | 0  | 1  | 1   |
| Granny Hamner, R (1, 6)<br>OBP: 0.312, SLG: 0.381  |           | 0-3<br>K |                    | 0-0<br>F7        |           |            | 0-0<br>F3  |           | 0-0<br>F9 | 4  | 0 | 0 | 0   | 0  | 1  | 1   |
| Stan Lopata, R (1, 2)<br>OBP: 0.318, SLG: 0.248    |           | 0-3<br>K |                    |                  | 0-0<br>HR |            | 0-0<br>F2  |           |           | 3  | 1 | 1 | 1   | 0  | 1  | 0   |
| Mike Goliat, R (1, 4)<br>OBP: 0.310, SLG: 0.370    |           |          | 4-0<br>SH3-4<br>BB |                  | 0-0<br>F7 |            | 0-0<br>4-3 |           |           | 2  | 0 | 0 | 0   | 1  | 0  | 0   |
| Curt Simmons, L (1, 1)<br>OBP: 0.250, SLG: 0.196   |           |          | 0-0<br>SH3-4       |                  | 0-0<br>L8 |            |            | 0-0<br>F7 |           | 0  | 0 | 0 | 0   | 0  | 0  | 0   |
| Milo Candini, R (4, 1)                             |           |          |                    |                  |           |            |            |           |           | 1  | 0 | 0 | 0   | 0  | 0  | 0   |
| Dick Whitman, L (8, PH)<br>OBP: 0.322, SLG: 0.308  |           |          |                    |                  |           |            |            |           |           | 1  | 0 | 0 | 0   | 0  | 0  | 0   |
| Jim Konstanty, R (9, 1)<br>OBP: 0.053, SLG: 0.053  |           |          | 1-2                |                  |           |            |            |           |           | 0  | 0 | 0 | 0   | 0  | 0  | 0   |

| Inning Stats | R: 0   | H: 1  | E: 0 | K: 0   | S: 4  | R: 0 | H: 0   | E: 0  | K: 3 | S: 9   | R: 0  | H: 0 | E: 0   | K: 1  | S: 5 | R: 0   | H: 0  | E: 0 | K: 0   | S: 3  | R: 1 | H: 2   | E: 0  | K: 0 | S: 5   | R: 0  | H: 0 | E: 0   | K: 0  | S: 3 | R: 0   | H: 0  | E: 0 | K: 0   | S: 3  | R: 0 | H: 1   | E: 0  | K: 1 | S: 6   | R: 0  | H: 0 | E: 0   | K: 0  | S: 3 | R: 0   | H: 0  | E: 0 | K: 0   | S: 3  | R: 0 | H: 0 | E: 0 | K: 0 | S: 3 |
|--------------|--------|-------|------|--------|-------|------|--------|-------|------|--------|-------|------|--------|-------|------|--------|-------|------|--------|-------|------|--------|-------|------|--------|-------|------|--------|-------|------|--------|-------|------|--------|-------|------|--------|-------|------|--------|-------|------|--------|-------|------|--------|-------|------|--------|-------|------|------|------|------|------|
|              | LOB: 1 | BB: 0 | P: 4 | LOB: 0 | BB: 0 | P: 9 | LOB: 1 | BB: 1 | P: 9 | LOB: 1 | BB: 0 | P: 5 | LOB: 0 | BB: 0 | P: 3 | LOB: 1 | BB: 0 | P: 6 | LOB: 0 | BB: 0 | P: 3 | LOB: 0 | BB: 0 | P: 5 | LOB: 0 | BB: 0 | P: 3 | LOB: 1 | BB: 0 | P: 6 | LOB: 0 | BB: 0 | P: 3 | LOB: 0 | BB: 0 | P: 6 | LOB: 0 | BB: 0 | P: 3 | LOB: 0 | BB: 0 | P: 3 | LOB: 0 | BB: 0 | P: 3 | LOB: 0 | BB: 0 | P: 3 | LOB: 0 | BB: 0 | P: 3 |      |      |      |      |

| PITCHER                                | IP  | WLS | BF | H | R | ER | SO | BB | IBB | HBP | BLK | WP | HR | S  | P  | ERA  | WHIP  | PITCHER | IP | WLS | BF | H | R | ER | SO | BB | IBB | HBP | BLK | WP | HR | S | P | ERA | WHIP |  |  |  |  |  |  |  |  |  |  |  |  |  |  |  |  |
|--|-----|-----|----|---|---|----|----|----|-----|-----|-----|----|----|----|----|------|-------|---------|----|-----|----|---|---|----|----|----|-----|-----|-----|----|----|---|---|-----|------|--|--|--|--|--|--|--|--|--|--|--|--|--|--|--|--|
| Ewell Blackwell, R (1, 1)<br>ERA: 3.78 | 9.0 | W   | 33 | 4 | 1 | 1  | 5  | 2  | 0   | 0   | 0   | 0  | 1  | 41 | 49 | 1.00 | 0.667 |         |    |     |    |   |   |    |    |    |     |     |     |    |    |   |   |     |      |  |  |  |  |  |  |  |  |  |  |  |  |  |  |  |  |

BOTTOM

Cincinnati Reds @ Philadelphia Phillies  
 Shibe Park, Philadelphia, PA  
 Tue Aug 01 1950, 3:38 AM EDT  
 Att. 34,728 - Unknown

|     |    |
|-----|----|
| AB  | 30 |
| R   | 1  |
| H   | 4  |
| RBI | 1  |
| BB  | 2  |
| SO  | 5  |
| LOB | 10 |

|    |   |     |    |
|----|---|-----|----|
| 1B | 2 | SF  | 0  |
| 2B | 1 | SAC | 1  |
| 3B | 0 | DP  | 0  |
| HR | 1 | HBP | 0  |
| WP | 0 | PA  | 33 |
| PB | 0 | SB  | 0  |
| CS | 0 |     |    |

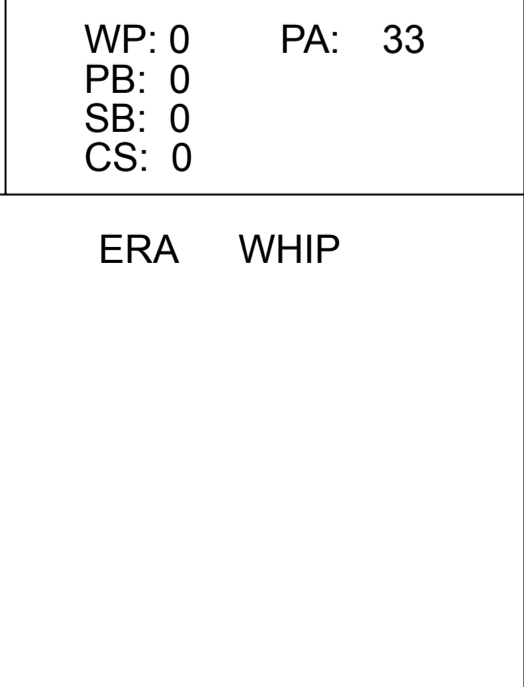

| Batter | 1 | 2 | 3 | 4 | 5 | 6 | 7 | 8 | 9 | AB R H RBI BB SO LOB | TOP |
|--------|---|---|---|---|---|---|---|---|---|----------------------|-----|
|--------|---|---|---|---|---|---|---|---|---|----------------------|-----|

|  |             |                         |                      |              |              |              |             |                         |               |               |       |
|--|-------------|-------------------------|----------------------|--------------|--------------|--------------|-------------|-------------------------|---------------|---------------|-------|
| Lloyd Merriman, L (1, 8)<br>OBP: 0.298, SLG: 0.337<br>BB | 4-0<br>BB   |                         | x 0-0<br>F5          |              |              | x 0-0<br>6-3 |             |                         | x 0-0<br>3-1  | 3 0 0 0 1 0 1 |       |
| Peanuts Lowrey, R (1, 7)<br>OBP: 0.332, SLG: 0.307       | x 0-0<br>F1 |                         | x 0-0<br>FC6-4       |              |              | x 0-0<br>4-3 |             |                         | x 0-0<br>F8   | 4 0 0 0 0 0 2 |       |
| Johnny Wyrostek, L (1, 9)<br>OBP: 0.395, SLG: 0.461      | x 0-0<br>F7 |                         |                      | x 0-0<br>3-1 |              |              | x 0-0<br>2B |                         | BBB 4-0<br>BB | 3 0 1 0 1 0 1 |       |
| Ted Kluszewski, L (1, 3)<br>OBP: 0.341, SLG: 0.541       | x 0-0<br>F8 |                         |                      | x 0-0<br>F6  |              |              | x 0-0<br>F8 |                         | x 0-0<br>F6   | 4 0 0 0 0 0 3 |       |
| Grady Hatton, L (1, 5)<br>OBP: 0.345, SLG: 0.415         |             | x 0-0<br>F8             |                      | x 0-0<br>F8  |              |              | x 0-0<br>F8 |                         |               | 3 0 0 0 0 0 1 |       |
| Connie Ryan, R (1, 4)<br>OBP: 0.374, SLG: 0.377          |             | BBB 4-0<br>G1-6-3<br>BB |                      |              | x 0-0<br>F8  |              | x 0-0<br>F7 |                         |               | 2 0 0 0 1 0 1 |       |
| Johnny Pramesa, R (1, 2)<br>OBP: 0.366, SLG: 0.463       |             | x 0-0<br>G1-6-3         |                      |              | x 0-0<br>F5  |              |             | x 0-0<br>G3<br>CS<br>2B |               | 0 0 0 0 0 0 0 |       |
| Dixie Howell, R (1, 2)<br>OBP: 0.303, SLG: 0.263         |             | 1-2<br>G1-6-3           |                      |              | x 0-0<br>6-3 |              |             | x 0-0<br>G3<br>2-3      |               | 3 0 1 0 0 0 1 | AB 28 |
| Virgil Stallcup, R (1, 6)<br>OBP: 0.288, SLG: 0.363      |             |                         | x 0-0<br>F4          |              |              |              |             | x 0-0<br>F7<br>3-H      |               | 2 0 0 0 0 0 0 | R 0   |
| Harry Perkowski, L (8, PH)<br>OBP: 0.381, SLG: 0.350     |             |                         |                      |              |              |              |             |                         |               | 1 0 0 0 0 0 1 | H 3   |
| Sammy Meeks, R (8, 6)<br>OBP: 0.317, SLG: 0.395          |             |                         |                      |              |              |              |             |                         |               | 0 0 0 0 0 0 0 | RBI 0 |
| Willie Ramsdell, R (1, 1)<br>OBP: 0.250, SLG: 0.182      |             |                         | x 0-0<br>FC6-4<br>1B |              |              | 0-3<br>K     |             |                         |               | 3 0 1 0 0 1 1 | BB 3  |

|              |   |   |   |   |   |   |   |   |   |  |   |
|--------------|---|---|---|---|---|---|---|---|---|--|---|
| Inning Stats | R: 0 H: 0<br>E: 0 LOB: 1<br>K: 0 BB: 1<br>S: 3 P: 7 | R: 0 H: 0<br>E: 0 LOB: 0<br>K: 0 BB: 1<br>S: 2 P: 6 | R: 0 H: 1<br>E: 0 LOB: 1<br>K: 0 BB: 0<br>S: 4 P: 4 | R: 0 H: 0<br>E: 0 LOB: 0<br>K: 0 BB: 0<br>S: 3 P: 3 | R: 0 H: 0<br>E: 0 LOB: 0<br>K: 0 BB: 0<br>S: 3 P: 3 | R: 0 H: 0<br>E: 0 LOB: 0<br>K: 1 BB: 0<br>S: 5 P: 5 | R: 0 H: 1<br>E: 0 LOB: 1<br>K: 0 BB: 0<br>S: 4 P: 4 | R: 0 H: 1<br>E: 0 LOB: 0<br>K: 0 BB: 0<br>S: 3 P: 3 | R: 0 H: 0<br>E: 0 LOB: 1<br>K: 0 BB: 1<br>S: 3 P: 7 | 1B: 1 SF: 0<br>2B: 2 SAC: 0<br>3B: 0 DP: 1<br>HR: 0 HBP: 0 | WP: 0 PA: 31<br>PB: 0<br>SB: 0<br>CS: 1 |
|--------------|---|---|---|---|---|---|---|---|---|--|---|

|  |   |   |
|--|---|---|
| PITCHER<br>Bubba Church, R (1, 1)<br>ERA: 2.39 | IP WLS BF H R ER SO BB IBB HBP BLK WP HR S P ERA WHIP | 9.0 W 31 3 0 0 1 3 0 0 0 0 0 0 30 42 0.00 0.667 |
|--|---|---|

Cincinnati Reds @ Philadelphia Phillies  
 Shibe Park, Philadelphia, PA  
 Wed Aug 02 1950, 3:33 AM EDT  
 Att: 8,540 - Unknown - 75 F





| Batter   | 1                      | 2            | 3                               | 4           | 5 | 6            | 7            | 8 | 9 | AB R H RBI BB SO LOB |
|--|------------------------|--------------|---------------------------------|-------------|---|--------------|--------------|---|---|----------------------|
| <b>Eddie Waitkus, L</b><br>OBP: 0.339, SLG: 0.365 (1, 3)<br>BBB  | 4-0<br>WP BB<br>BB     |              | x 0-0<br>F7                     | x 0-0<br>F4 |   |              | x 0-0<br>F6  |   |   | 3 0 0 0 1 0 3        |
| <b>Richie Ashburn, L</b><br>OBP: 0.384, SLG: 0.415 (1, 8)<br>BBB | 4-0<br>WP BB<br>1-2 BB |              | x 0-0<br>BB<br>1B               |             |   | x 0-0<br>L4  | x 0-0<br>F8  |   |   | 3 0 1 0 1 0 1        |
| <b>Dick Sister, L</b><br>OBP: 0.400, SLG: 0.483 (1, 7)<br>SSS    | 0-3<br>K<br>1-2 2-3    |              | B 4-0<br>BB<br>1-2 BB<br>G6-4-3 |             |   | B 4-0<br>BB  | x 0-0<br>G3  |   |   | 2 0 0 0 2 1 3        |
| <b>Del Ennis, R</b><br>OBP: 0.352, SLG: 0.571 (1, 9)<br>---      | 4-0<br>FC4-6<br>IBB    |              | x 0-0<br>G6-4-3<br>1-2f         |             |   | x 0-0<br>F8  | x 0-0<br>HR  |   |   | 3 1 1 1 1 0 3        |
| <b>Willie Jones, R</b><br>OBP: 0.381, SLG: 0.558 (1, 5)<br>X     | 0-0<br>F6              |              | x 0-0<br>F7                     |             |   | x 0-0<br>F9  | SSS 0-3<br>K |   |   | 4 0 0 0 0 1 4        |
| <b>Granny Hamner, R</b><br>OBP: 0.312, SLG: 0.380 (1, 6)<br>X    | 0-0<br>FC4-6<br>1-2f   |              | x 0-0<br>1B<br>1B               |             |   | x 0-0<br>6-3 | x 0-0<br>6-3 |   |   | 4 1 1 0 0 0 3        |
| <b>Andy Seminick, R</b><br>OBP: 0.421, SLG: 0.539 (1, 2)<br>---  |                        | x 0-0<br>6-3 | x 0-0<br>1B<br>1-2 1B           |             |   | x 0-0<br>F7  | SSS 0-3<br>K |   |   | 4 0 1 0 0 1 0        |
| <b>Mike Goliat, R</b><br>OBP: 0.307, SLG: 0.366 (1, 4)<br>---    |                        | x 0-0<br>6-3 | x 0-0<br>F9                     |             |   | x 0-0<br>F3  |              |   |   | 3 0 0 0 0 0 2        |
| <b>Bubba Church, R</b><br>OBP: 0.222, SLG: 0.259 (1, 1)<br>---   |                        | x 0-0<br>5-3 | x 0-0<br>1-2 2-H<br>1B          |             |   | x 0-0<br>1B  |              |   |   | 3 0 2 1 0 0 0        |

| Inning Stats | R: 0 | H: 0 | E: 0 | K: 1 | S: 5 | LOB: 3 | BB: 3 | P: 17 |
|--------------|------|------|------|------|------|--------|-------|-------|
|              | R: 0 | H: 0 | E: 0 | K: 0 | S: 3 | LOB: 0 | BB: 0 | P: 3  |
|              | R: 0 | H: 1 | E: 0 | K: 0 | S: 3 | LOB: 1 | BB: 1 | P: 7  |
|              | R: 1 | H: 3 | E: 0 | K: 0 | S: 6 | LOB: 2 | BB: 0 | P: 6  |
|              | R: 0 | H: 0 | E: 0 | K: 0 | S: 3 | LOB: 1 | BB: 1 | P: 7  |
|              | R: 0 | H: 0 | E: 0 | K: 0 | S: 3 | LOB: 0 | BB: 0 | P: 3  |
|              | R: 0 | H: 1 | E: 0 | K: 2 | S: 8 | LOB: 1 | BB: 0 | P: 8  |

| PITCHER                                       | IP  | WLS | BF | H | R | ER | SO | BB | IBB | HBP | BLK | WP | HR | S  | P  | ERA  | WHIP  |
|---|-----|-----|----|---|---|----|----|----|-----|-----|-----|----|----|----|----|------|-------|
| <b>Willie Ramsdell, R</b><br>ERA: 3.93 (1, 1) | 8.0 | L   | 34 | 6 | 2 | 2  | 3  | 4  | 1   | 0   | 0   | 1  | 1  | 35 | 55 | 2.25 | 1.250 |

**BOTTOM**

**Cincinnati Reds @ Philadelphia Phillies**  
Shibe Park, Philadelphia, PA

Wed Aug 02 1950, 3:33 AM EDT  
Att. 8,540 - Unknown - 75 F

|            |           |
|------------|-----------|
| <b>AB</b>  | <b>29</b> |
| <b>R</b>   | <b>2</b>  |
| <b>H</b>   | <b>6</b>  |
| <b>RBI</b> | <b>2</b>  |
| <b>BB</b>  | <b>5</b>  |
| <b>SO</b>  | <b>3</b>  |
| <b>LOB</b> | <b>19</b> |

[livebaseballscorecards.com](http://livebaseballscorecards.com)

**WP: 1 PA: 34**  
**PB: 0 SB: 0 CS: 0**

| Batter  | 1  | 2                                | 3                            | 4                               | 5                             | 6                                | 7                             | 8                                | 9                            | AB R H RBI BB SO LOB             | TOP                          |                                  |  |                                 |                              |                                  |                              |                                  |                                  |                                    |                                  |        |
|---|--|----------------------------------|------------------------------|---------------------------------|-------------------------------|----------------------------------|-------------------------------|----------------------------------|------------------------------|----------------------------------|------------------------------|----------------------------------|--|---------------------------------|------------------------------|----------------------------------|------------------------------|----------------------------------|----------------------------------|------------------------------------|----------------------------------|--------|
| Lloyd Merriman, L (1, 8)<br>OBP: 0.303, SLG: 0.347    | 1-2<br>FC4<br>2B   |                                  | 0-0<br>1B                    |                                 | 1-1<br>F8                     |                                  |                               | 0-0<br>F6                        |                              | 4 0 2 0 0 0 1                    |                              |                                  |  |                                 |                              |                                  |                              |                                  |                                  |                                    |                                  |        |
| Peanuts Lowrey, R (1, 7)<br>OBP: 0.327, SLG: 0.302    | 2-1<br>FC4<br>G5-4-3   |                                  | 2-2<br>F4                    |                                 | 2-1<br>FC5-4                  |                                  |                               | 1-1<br>F7                        |                              | 4 0 0 0 0 0 3                    |                              |                                  |  |                                 |                              |                                  |                              |                                  |                                  |                                    |                                  |        |
| Johnny Wyrostek, L (1, 9)<br>OBP: 0.393, SLG: 0.458   | 0-3<br>K   |                                  |                              | 1-2<br>6-3                      |                               | 2-2<br>FC4-6<br>1B               |                               | 3-3<br>K                         |                              | 4 0 1 0 0 2 2                    |                              |                                  |  |                                 |                              |                                  |                              |                                  |                                  |                                    |                                  |        |
| Ted Kluszewski, L (1, 3)<br>OBP: 0.337, SLG: 0.534    | 0-0<br>G5-4-3  |                                  |                              | 0-2<br>4-3                      |                               | 0-0<br>FC4-6                     |                               | 0-1<br>F7                        |                              | 4 0 0 0 0 0 3                    |                              |                                  |  |                                 |                              |                                  |                              |                                  |                                  |                                    |                                  |        |
| Grady Hatton, L (1, 5)<br>OBP: 0.347, SLG: 0.415      |  | 0-1<br>4-3                       |                              | 4-1<br>3B<br>BB                 |                               | 1-0<br>F8                        |                               | 0-0<br>BB<br>1B                  |                              | 3 1 1 0 1 0 1                    |                              |                                  |  |                                 |                              |                                  |                              |                                  |                                  |                                    |                                  |        |
| Connie Ryan, R (1, 4)<br>OBP: 0.373, SLG: 0.382       |  | 0-0<br>5-3                       |                              | 0-2<br>1-H<br>3B                |                               | 0-2<br>F9                        |                               | 0-1<br>F7                        |                              | 4 0 1 1 0 0 2                    |                              |                                  |  |                                 |                              |                                  |                              |                                  |                                  |                                    |                                  |        |
| Hobie Landrith, L (1, 2)<br>OBP: 0.333, SLG: 0.200    |  | 0-1<br>4-3                       |                              | 2-0<br>F2                       |                               | 1-0<br>F5                        |                               | 4-1<br>1-2<br>BB                 |                              | 3 0 0 0 1 0 1                    |                              |                                  |  |                                 |                              |                                  |                              |                                  |                                  |                                    |                                  |        |
| Virgil Stallcup, R (1, 6)<br>OBP: 0.288, SLG: 0.362   |  |                                  | 0-1<br>B2-6-4<br>1B          |                                 | 0-0<br>F7                     |                                  | 0-0<br>L7                     | 0-3<br>K                         |                              | 4 0 1 0 0 1 2                    |                              |                                  |  |                                 |                              |                                  |                              |                                  |                                  |                                    |                                  |        |
| Ken Raffensberger, R (1, 1)<br>OBP: 0.214, SLG: 0.192 |  |                                  | 0-1<br>B2-6-4                |                                 | 0-1<br>FC5-4<br>1B            |                                  | 1-1<br>3-1                    |                                  |                              | 2 0 1 0 0 0 1                    |                              |                                  |  |                                 |                              |                                  |                              |                                  |                                  |                                    |                                  |        |
| Harry Perkowski, L (7, PH)<br>OBP: 0.364, SLG: 0.333  |  |                                  |                              |                                 |                               |                                  |                               |                                  |                              | 1 0 0 0 0 0 0                    |                              |                                  |  |                                 |                              |                                  |                              |                                  |                                  |                                    |                                  |        |
| Howie Fox, R (7, 1)<br>OBP: 0.205, SLG: 0.308         |  |                                  |                              |                                 |                               |                                  |                               |                                  |                              | 0 0 0 0 0 0 0                    |                              |                                  |  |                                 |                              |                                  |                              |                                  |                                  |                                    |                                  |        |
| <b>Inning Stats</b>                                   | R: 0<br>E: 0<br>K: 1<br>S: 9   | H: 1<br>LOB: 1<br>BB: 0<br>P: 12 | R: 0<br>E: 0<br>K: 0<br>S: 5 | H: 0<br>LOB: 0<br>BB: 0<br>P: 5 | R: 0<br>E: 0<br>K: 0<br>S: 10 | H: 2<br>LOB: 1<br>BB: 0<br>P: 12 | R: 1<br>E: 0<br>K: 0<br>S: 11 | H: 1<br>LOB: 1<br>BB: 1<br>P: 18 | R: 0<br>E: 0<br>K: 0<br>S: 7 | H: 1<br>LOB: 1<br>BB: 0<br>P: 10 | R: 0<br>E: 1<br>K: 0<br>S: 9 | H: 1<br>LOB: 1<br>BB: 0<br>P: 12 | R: 0<br>E: 0<br>K: 0<br>S: 4   | H: 0<br>LOB: 0<br>BB: 0<br>P: 6 | R: 0<br>E: 0<br>K: 1<br>S: 6 | H: 0<br>LOB: 0<br>BB: 0<br>P: 10 | R: 0<br>E: 0<br>K: 1<br>S: 9 | H: 1<br>LOB: 2<br>BB: 1<br>P: 13 | 1B: 5<br>2B: 1<br>3B: 1<br>HR: 0 | SF: 0<br>SAC: 0<br>DP: 2<br>HBP: 0 | WP: 0<br>PB: 0<br>SB: 0<br>CS: 0 | PA: 35 |
| <b>PITCHER</b><br>Don Newcombe, R (1, 1)<br>ERA: 4.06 | IP: 9.0<br>WLS: W<br>BF: 35<br>H: 7<br>R: 1<br>ER: 1<br>SO: 3<br>BB: 2<br>IBB: 0<br>HBP: 0<br>BLK: 0<br>WP: 0<br>HR: 0<br>S: 70<br>P: 98<br>ERA: 1.00<br>WHIP: 1.000 |                                  |                              |                                 |                               |                                  |                               |                                  |                              |                                  |                              | <b>PITCHER</b>                   | IP: 9.0<br>WLS: W<br>BF: 35<br>H: 7<br>R: 1<br>ER: 1<br>SO: 3<br>BB: 2<br>IBB: 0<br>HBP: 0<br>BLK: 0<br>WP: 0<br>HR: 0<br>S: 70<br>P: 98<br>ERA: 1.00<br>WHIP: 1.000 |                                 |                              |                                  |                              |                                  |                                  |                                    |                                  |        |

**Cincinnati Reds @ Brooklyn Dodgers**  
 Ebbets Field, Brooklyn, NY  
 Fri Aug 04 1950, 3:33 AM EDT  
 Att. 20,191 - Unknown

livebaseballscorecards.com

|            |    |
|------------|----|
| <b>AB</b>  | 33 |
| <b>R</b>   | 1  |
| <b>H</b>   | 7  |
| <b>RBI</b> | 1  |
| <b>BB</b>  | 2  |
| <b>SO</b>  | 3  |
| <b>LOB</b> | 16 |



| Batter  | 1             | 2         | 3         | 4          | 5         | 6          | 7          | 8          | 9 | AB | R | H | RBI | BB | SO | LOB |
|---|---------------|-----------|-----------|------------|-----------|------------|------------|------------|---|----|---|---|-----|----|----|-----|
| <b>Pee Wee Reese, R</b><br>OBP: 0.364, SLG: 0.355<br>(1, 6)   | 1-2<br>2B     |           | 0-1<br>1B | 3-3<br>K   |           | 2-2<br>2B  | 3-2<br>5-3 |            |   | 5  | 0 | 3 | 1   | 0  | 1  | 4   |
| <b>Jim Russell, S</b><br>OBP: 0.339, SLG: 0.494<br>(1, 7)     | 4-0<br>BB     |           | 3-3<br>K  |            | 0-0<br>F4 | 0-3<br>K   |            | 1-0<br>4-3 |   | 4  | 0 | 0 | 0   | 1  | 2  | 3   |
| <b>Duke Snider, L</b><br>OBP: 0.374, SLG: 0.540<br>(1, 8)     | 0-0<br>B1     |           | 0-1<br>L8 |            | 2-1<br>1B | 0-3<br>K   |            | 0-1<br>F9  |   | 5  | 1 | 1 | 0   | 0  | 1  | 5   |
| <b>Jackie Robinson, R</b><br>OBP: 0.452, SLG: 0.574<br>(1, 4) | 1-2<br>G6-4-3 |           | 0-0<br>F2 |            | 2-0<br>L3 |            | 2-2<br>F3  | 1-0<br>2B  |   | 5  | 0 | 1 | 0   | 0  | 0  | 4   |
| <b>Carl Furillo, R</b><br>OBP: 0.348, SLG: 0.475<br>(1, 9)    |               | 3-1<br>3B |           | 0-0<br>1-3 | 0-1<br>1B |            | 2-1<br>1B  | 0-0<br>6-3 |   | 5  | 2 | 3 | 1   | 0  | 0  | 1   |
| <b>Gil Hodges, R</b><br>OBP: 0.386, SLG: 0.491<br>(1, 3)      |               | 1-1<br>L7 |           | 1-1<br>6-3 | 0-3<br>K  |            | 0-0<br>1B  |            |   | 4  | 2 | 2 | 1   | 0  | 1  | 1   |
| <b>Roy Campanella, R</b><br>OBP: 0.385, SLG: 0.585<br>(1, 2)  |               | 1-1<br>L7 |           | 0-1<br>1B  |           | 3-2<br>1-3 | 4-0<br>1B  |            |   | 3  | 1 | 1 | 1   | 1  | 0  | 0   |
| <b>Billy Cox, R</b><br>OBP: 0.307, SLG: 0.395<br>(1, 5)       |               | 1-1<br>F3 |           | 1-0<br>1B  |           | 4-2<br>2B  | 1-1<br>1B  |            |   | 3  | 1 | 2 | 2   | 1  | 0  | 0   |
| <b>Don Newcombe, L</b><br>OBP: 0.339, SLG: 0.340<br>(1, 1)    |               | 3-3<br>K  |           | 3-2<br>1B  |           | 4-2<br>2B  | 3-3<br>K   |            |   | 3  | 0 | 1 | 1   | 1  | 2  | 2   |

| Inning Stats | R: 0 | H: 1 | E: 0 | K: 0 | S: 10 | LOB: 1 | BB: 1 | P: 16 |
|--------------|------|------|------|------|-------|--------|-------|-------|
|              | R: 2 | H: 2 | E: 0 | K: 1 | S: 12 | LOB: 0 | BB: 0 | P: 21 |
|              | R: 0 | H: 1 | E: 0 | K: 1 | S: 8  | LOB: 1 | BB: 0 | P: 11 |
|              | R: 1 | H: 3 | E: 0 | K: 1 | S: 13 | LOB: 2 | BB: 0 | P: 21 |
|              | R: 1 | H: 2 | E: 0 | K: 1 | S: 9  | LOB: 1 | BB: 0 | P: 13 |
|              | R: 1 | H: 1 | E: 0 | K: 2 | S: 18 | LOB: 2 | BB: 2 | P: 31 |
|              | R: 2 | H: 3 | E: 0 | K: 1 | S: 14 | LOB: 2 | BB: 1 | P: 29 |
|              | R: 0 | H: 1 | E: 0 | K: 0 | S: 5  | LOB: 1 | BB: 0 | P: 7  |

| PITCHER  | IP  | WLS | BF | H  | R | ER | SO | BB | IBB | HBP | BLK | WP | HR | S  | P   | ERA  | WHIP  |
|--|-----|-----|----|----|---|----|----|----|-----|-----|-----|----|----|----|-----|------|-------|
| <b>Ken Raffensberger, L</b><br>ERA: 4.34<br>(1, 1) | 6.0 | L   | 30 | 10 | 5 | 5  | 6  | 3  | 0   | 0   | 0   | 0  | 0  | 70 | 113 | 7.50 | 2.167 |
| <b>Howie Fox, R</b><br>ERA: 4.78<br>(7, 1)         | 2.0 |     | 11 | 4  | 2 | 2  | 1  | 0  | 1   | 0   | 0   | 0  | 0  | 19 | 36  | 9.00 | 2.000 |

**BOTTOM**

**Cincinnati Reds @ Brooklyn Dodgers**  
Ebbets Field, Brooklyn, NY

Fri Aug 04 1950, 3:33 AM EDT  
Att. 20,191 - Unknown

|     |    |
|-----|----|
| AB  | 37 |
| R   | 7  |
| H   | 14 |
| RBI | 7  |
| BB  | 4  |
| SO  | 7  |
| LOB | 20 |

livebaseballscorecards.com

WP: 0 PA: 41  
PB: 0 SB: 1  
CS: 0



| Batter   | 1   | 2                                | 3                            | 4                                | 5                             | 6                                | 7                            | 8                               | 9                             | AB R H RBI BB SO LOB             | TOP   |                                 |                              |                                 |                               |                                  |                              |                                  |                                  |                                    |                                  |        |
|--|---|----------------------------------|------------------------------|----------------------------------|-------------------------------|----------------------------------|------------------------------|---------------------------------|-------------------------------|----------------------------------|---|---------------------------------|------------------------------|---------------------------------|-------------------------------|----------------------------------|------------------------------|----------------------------------|----------------------------------|------------------------------------|----------------------------------|--------|
| <b>Bobby Adams, R</b> (1, 5)<br><small>OBP: 0.333, SLG: 0.355</small><br><b>Grady Hatton, L</b> (7, PH)<br><small>OBP: 0.345, SLG: 0.412</small> (7, 5)        | 3-1<br>5-3  | 0-0<br>F9                        |                              |                                  | 1-1<br>HR                     |                                  | 0-0<br>F9                    |                                 | 0-1<br>F7                     | 3 1 1 1 0 0 2<br>2 0 0 0 0 0 0   | <b>Cincinnati Reds @ Brooklyn Dodgers</b><br><b>Ebbets Field, Brooklyn, NY</b><br>Sat Aug 05 1950, 3:33 AM EDT<br>Att: 10,958 - Unknown |                                 |                              |                                 |                               |                                  |                              |                                  |                                  |                                    |                                  |        |
| <b>Peanuts Lowrey, R</b> (1, 7)<br><small>OBP: 0.323, SLG: 0.297</small> (8, 8)  | 0-1<br>F8   |                                  | 2-1<br>F8                    |                                  | 1-2<br>F4                     |                                  | 1-2<br>F3                    |                                 |                               | 4 0 0 0 0 0 0                    |   |                                 |                              |                                 |                               |                                  |                              |                                  |                                  |                                    |                                  |        |
| <b>Danny Litwhiler, R</b> (1, 9)<br><small>OBP: 0.385, SLG: 0.506</small><br><b>Johnny Wyrostek, L</b> (8, PH)<br><small>OBP: 0.392, SLG: 0.457</small> (8, 9) | 1-1<br>G3   |                                  | 2-2<br>1-3                   |                                  | 2-1<br>HR                     |                                  |                              | 1-2<br>F4                       |                               | 3 1 1 1 0 0 0<br>1 0 0 0 0 0 0   |   |                                 |                              |                                 |                               |                                  |                              |                                  |                                  |                                    |                                  |        |
| <b>Bob Usher, R</b> (1, 8)<br><small>OBP: 0.318, SLG: 0.387</small><br><b>Ted Kluszewski, L</b> (8, PH)<br><small>OBP: 0.339, SLG: 0.539</small> (8, 3)        |   | 2-2<br>SH<br>2B                  | 2-2                          |                                  | 1-3<br>K                      |                                  |                              | 2-2<br>2B                       |                               | 3 1 2 0 0 1 0<br>1 0 1 0 0 0 0   |   |                                 |                              |                                 |                               |                                  |                              |                                  |                                  |                                    |                                  |        |
| <b>Connie Ryan, R</b> (1, 4)<br><small>OBP: 0.369, SLG: 0.377</small> (1, 4)   |   | 0-0<br>4-3<br>2B                 | 2-2<br>L7                    |                                  |                               | 0-0<br>4-3                       |                              | 2-1<br>L7                       |                               | 4 0 0 0 0 0 3                    |   |                                 |                              |                                 |                               |                                  |                              |                                  |                                  |                                    |                                  |        |
| <b>Joe Adcock, R</b> (1, 3)<br><small>OBP: 0.302, SLG: 0.370</small> (8, 7)  |   | 1-0<br>SH<br>2B<br>1B            |                              | 0-0<br>5-3                       |                               | 1-1                              |                              | 4-0<br>FC5-4<br>BB              |                               | 3 1 2 0 1 0 0                    |   |                                 |                              |                                 |                               |                                  |                              |                                  |                                  |                                    |                                  |        |
| <b>Virgil Stallcup, R</b> (1, 6)<br><small>OBP: 0.285, SLG: 0.358</small> (1, 6)   |   | 0-0<br>SH<br>2B                  | 1-0<br>5-3                   |                                  | 0-3<br>K                      |                                  | 0-1<br>FC5-4                 |                                 |                               | 3 0 0 1 0 1 3                    |   |                                 |                              |                                 |                               |                                  |                              |                                  |                                  |                                    |                                  |        |
| <b>Dixie Howell, R</b> (1, 2)<br><small>OBP: 0.302, SLG: 0.270</small> (1, 2)  |   | 2-0<br>3-H<br>2B                 | 0-1<br>F3                    |                                  |                               | 1-0<br>1-3                       |                              |                                 | 3-3<br>K                      | 4 0 1 1 0 1 1                    |   |                                 |                              |                                 |                               |                                  |                              |                                  |                                  |                                    |                                  |        |
| <b>Herm Wehmeier, R</b> (1, 1)<br><small>OBP: 0.203, SLG: 0.235</small> (1, 1)   |   | 1-0<br>5-3                       |                              | 1-3<br>K                         |                               |                                  | 1-2<br>4-3                   |                                 | 3-2<br>6-3                    | 4 0 0 0 0 1 2                    |   |                                 |                              |                                 |                               |                                  |                              |                                  |                                  |                                    |                                  |        |
| <b>Inning Stats</b>  | R: 0<br>E: 0<br>K: 0<br>S: 6                          | H: 0<br>LOB: 0<br>BB: 0<br>P: 10 | R: 2<br>E: 1<br>K: 0<br>S: 9 | H: 3<br>LOB: 2<br>BB: 0<br>P: 15 | R: 0<br>E: 0<br>K: 0<br>S: 12 | H: 1<br>LOB: 1<br>BB: 0<br>P: 20 | R: 0<br>E: 0<br>K: 0<br>S: 4 | H: 0<br>LOB: 0<br>BB: 0<br>P: 5 | R: 2<br>E: 0<br>K: 2<br>S: 14 | H: 2<br>LOB: 0<br>BB: 0<br>P: 20 | R: 0<br>E: 0<br>K: 1<br>S: 7  | H: 1<br>LOB: 1<br>BB: 0<br>P: 9 | R: 0<br>E: 0<br>K: 0<br>S: 7 | H: 0<br>LOB: 0<br>BB: 0<br>P: 9 | R: 0<br>E: 0<br>K: 0<br>S: 11 | H: 1<br>LOB: 2<br>BB: 1<br>P: 20 | R: 0<br>E: 0<br>K: 1<br>S: 8 | H: 0<br>LOB: 0<br>BB: 0<br>P: 14 | 1B: 3<br>2B: 3<br>3B: 0<br>HR: 2 | SF: 0<br>SAC: 1<br>DP: 0<br>HBP: 0 | WP: 0<br>PB: 0<br>SB: 0<br>CS: 0 | PA: 37 |
| <b>PITCHER</b>   | IP WLS BF H R ER SO BB IBB HBP BLK WP HR S P ERA WHIP |                                  |                              |                                  |                               |                                  |                              |                                 |                               |                                  |   |                                 |                              |                                 |                               |                                  |                              |                                  |                                  |                                    |                                  |        |
| <b>Preacher Roe, L</b> (1, 1)<br><small>ERA: 3.47</small>  | 5.0 L 22 6 4 4 2 0 0 0 0 0 0 2 45 70 7.20 1.200       |                                  |                              |                                  |                               |                                  |                              |                                 |                               |                                  |   |                                 |                              |                                 |                               |                                  |                              |                                  |                                  |                                    |                                  |        |
| <b>Erv Palica, R</b> (6, 1)<br><small>ERA: 3.99</small>  | 2.0 7 1 0 0 1 0 0 0 0 0 0 0 14 18 0.00 0.500          |                                  |                              |                                  |                               |                                  |                              |                                 |                               |                                  |   |                                 |                              |                                 |                               |                                  |                              |                                  |                                  |                                    |                                  |        |
| <b>Dan Bankhead, R</b> (8, 1)<br><small>ERA: 5.36</small>  | 2.0 8 1 0 0 1 1 0 0 0 0 0 0 19 34 0.00 1.000          |                                  |                              |                                  |                               |                                  |                              |                                 |                               |                                  |   |                                 |                              |                                 |                               |                                  |                              |                                  |                                  |                                    |                                  |        |

livebaseballscorecards.com

|            |    |
|------------|----|
| <b>AB</b>  | 35 |
| <b>R</b>   | 4  |
| <b>H</b>   | 8  |
| <b>RBI</b> | 4  |
| <b>BB</b>  | 1  |
| <b>SO</b>  | 4  |
| <b>LOB</b> | 11 |



| Batter  | 1         | 2 | 3                    | 4                   | 5                      | 6                | 7                          | 8         | 9          | AB | R | H | RBI | BB | SO | LOB |
|---|-----------|---|----------------------|---------------------|------------------------|------------------|----------------------------|-----------|------------|----|---|---|-----|----|----|-----|
| <b>Pee Wee Reese, R</b><br>OBP: 0.365, SLG: 0.354<br>(1, 6)   | 2-3<br>K  |   | 0-0<br>F8            |                     |                        | 4-1<br>BB<br>BB  | 2-2<br>1-3<br>2-H<br>1B    |           | 3-3<br>K   | 4  | 0 | 1 | 1   | 1  | 2  | 1   |
| <b>Gene Hermanski, L</b><br>OBP: 0.377, SLG: 0.468<br>(1, 7)  | 2-0<br>L8 |   |                      | 2-1<br>G6-4-3<br>1B |                        | 2-2<br>F8        | 1-1<br>1-3                 |           | 4-2<br>BB  | 4  | 0 | 1 | 0   | 1  | 0  | 3   |
| <b>Duke Snider, L</b><br>OBP: 0.371, SLG: 0.535<br>(1, 8)     | 0-0<br>F4 |   |                      | 1-2<br>L7           |                        | 4-0<br>1-2<br>BB |                            | 0-0<br>F3 | 0-2<br>4-3 | 4  | 0 | 0 | 0   | 1  | 0  | 3   |
| <b>Jackie Robinson, R</b><br>OBP: 0.447, SLG: 0.568<br>(1, 4) |           |   | 3-2<br>F7            |                     | 0-0<br>G6-4-3<br>1-2f  | 0-0<br>F8        |                            | 1-3<br>K  |            | 4  | 0 | 0 | 0   | 0  | 1  | 3   |
| <b>Carl Furillo, R</b><br>OBP: 0.350, SLG: 0.481<br>(1, 9)    |           |   | 1-1<br>F8            |                     | 2-0<br>HR<br>1B        | 3-2<br>F8        |                            | 0-0<br>3B |            | 4  | 1 | 2 | 0   | 0  | 0  | 2   |
| <b>Gil Hodges, R</b><br>OBP: 0.392, SLG: 0.501<br>(1, 3)      |           |   | 4-2<br>FC6-4<br>BB   |                     | 1-1<br>1-H<br>HR<br>1B |                  | 4-2<br>FC6-4<br>BB         | 4-0<br>BB |            | 1  | 1 | 1 | 2   | 3  | 0  | 0   |
| <b>Roy Campanella, R</b><br>OBP: 0.381, SLG: 0.576<br>(1, 2)  |           |   | 1-1<br>FC6-4<br>1-2f |                     | 3-3<br>K               |                  | 0-1<br>F7                  | 0-0<br>F5 |            | 4  | 0 | 0 | 0   | 0  | 1  | 4   |
| <b>Billy Cox, R</b><br>OBP: 0.310, SLG: 0.401<br>(1, 5)       |           |   | 1-0<br>F8            |                     | 1-2<br>G4-6-3<br>1B    |                  | 3-1<br>FC6-4<br>1-2f<br>1B |           | 2-1<br>2B  | 4  | 1 | 2 | 0   | 0  | 0  | 1   |
| <b>Preacher Roe, R</b><br>OBP: 0.175, SLG: 0.177<br>(5, PH)   |           |   | 0-3<br>K             |                     | 1-2<br>G4-6-3<br>1-2f  |                  | 4-2<br>1B<br>1-2<br>BB     |           | 2-1<br>F6  | 1  | 0 | 0 | 0   | 0  | 1  | 0   |
| <b>Wayne Belardi, L</b><br>(6, 1)                             |           |   |                      |                     |                        |                  |                            |           |            | 1  | 0 | 0 | 0   | 0  | 0  | 1   |
| <b>Erv Palica, R</b><br>OBP: 0.192, SLG: 0.269<br>(7, PH)     |           |   |                      |                     |                        |                  |                            |           |            | 0  | 0 | 0 | 0   | 0  | 0  | 0   |
| <b>Jim Russell, S</b><br>OBP: 0.342, SLG: 0.494<br>(8, 1)     |           |   |                      |                     |                        |                  |                            |           |            | 0  | 0 | 0 | 0   | 1  | 0  | 0   |
| <b>Dan Bankhead, R</b><br>OBP: 0.294, SLG: 0.303<br>(9, PH)   |           |   |                      |                     |                        |                  |                            |           |            | 0  | 0 | 0 | 0   | 0  | 0  | 0   |
| <b>Tommy Brown, R</b><br>OBP: 0.320, SLG: 0.652               |           |   |                      |                     |                        |                  |                            |           |            | 1  | 0 | 0 | 0   | 0  | 0  | 1   |

| Inning Stats   | R: 0 | H: 0 | E: 0 | K: 1 | S: 5 | R: 0 | H: 0 | E: 0 | K: 0 | S: 9 | R: 0 | H: 0 | E: 0 | K: 1 | S: 5 | R: 0 | H: 1  | E: 0 | K: 0           | S: 6 | R: 2 | H: 3 | E: 0 | K: 1 | S: 12 | R: 0 | H: 0 | E: 0 | K: 0 | S: 11 | R: 1 | H: 1 | E: 0 | K: 0 | S: 16 | R: 0 | H: 1 | E: 0 | K: 1 | S: 6 | R: 0 | H: 1 | E: 0 | K: 1 | S: 13 | R: 0 | H: 1 | E: 0 | K: 1 | S: 9 | 1B: 4 | 2B: 1 | 3B: 1 | HR: 1 | SF: 0 | SAC: 0 | DP: 2 | HBP: 0 | WP: 0 | PA: 39 |
|--|------|------|------|------|------|------|------|------|------|------|------|------|------|------|------|------|-------|------|----------------|------|------|------|------|------|-------|------|------|------|------|-------|------|------|------|------|-------|------|------|------|------|------|------|------|------|------|-------|------|------|------|------|------|-------|-------|-------|-------|-------|--------|-------|--------|-------|--------|
| <b>PITCHER</b><br><b>Herm Wehmeier, R</b><br>ERA: 5.92<br>(1, 1) | IP   | WLS  | BF   | H    | R    | ER   | SO   | BB   | IBB  | HBP  | BLK  | WP   | HR   | S    | P    | ERA  | WHIP  |      |                |      |      |      |      |      |       |      |      |      |      |       |      |      |      |      |       |      |      |      |      |      |      |      |      |      |       |      |      |      |      |      |       |       |       |       |       |        |       |        |       |        |
|  | 9.0  | W    | 39   | 7    | 3    | 3    | 5    | 7    | 0    | 0    | 0    | 0    | 1    | 83   | 151  | 3.00 | 1.556 |      |                |      |      |      |      |      |       |      |      |      |      |       |      |      |      |      |       |      |      |      |      |      |      |      |      |      |       |      |      |      |      |      |       |       |       |       |       |        |       |        |       |        |
|  |      |      |      |      |      |      |      |      |      |      |      |      |      |      |      |      |       |      | <b>PITCHER</b> | IP   | WLS  | BF   | H    | R    | ER    | SO   | BB   | IBB  | HBP  | BLK   | WP   | HR   | S    | P    | ERA   | WHIP |      |      |      |      |      |      |      |      |       |      |      |      |      |      |       |       |       |       |       |        |       |        |       |        |

**BOTTOM**

**Cincinnati Reds @ Brooklyn Dodgers**  
Ebbets Field, Brooklyn, NY

Sat Aug 05 1950, 3:33 AM EDT  
Att. 10,958 - Unknown

|            |           |
|------------|-----------|
| <b>AB</b>  | <b>32</b> |
| <b>R</b>   | <b>3</b>  |
| <b>H</b>   | <b>7</b>  |
| <b>RBI</b> | <b>3</b>  |
| <b>BB</b>  | <b>7</b>  |
| <b>SO</b>  | <b>5</b>  |
| <b>LOB</b> | <b>19</b> |



| Batter  | 1   | 2                                | 3                            | 4                               | 5                             | 6                                | 7                               | 8                                | 9                            | AB R H RBI BB SO LOB            | TOP   |                                 |                              |                                  |                               |                                  |                               |                                  |                                  |                                    |                                  |        |
|---|---|----------------------------------|------------------------------|---------------------------------|-------------------------------|----------------------------------|---------------------------------|----------------------------------|------------------------------|---------------------------------|---|---------------------------------|------------------------------|----------------------------------|-------------------------------|----------------------------------|-------------------------------|----------------------------------|----------------------------------|------------------------------------|----------------------------------|--------|
| Lloyd Merriman, L (1, 8)<br>OBP: 0.304, SLG: 0.349  | 0-1<br>1B<br>2B                                       | 1-0<br>F6                        |                              | 2-1<br>F7                       |                               | 0-1<br>4-3                       |                                 | 0-1<br>4-3                       | 4-0<br>1B<br>BB              | 5 1 1 0 1 0 2                   |   |                                 |                              |                                  |                               |                                  |                               |                                  |                                  |                                    |                                  |        |
| Grady Hatton, L (1, 5)<br>OBP: 0.350, SLG: 0.415    | 1-0<br>F8   |                                  | 2-2<br>2B<br>E<br>1B         | 1-0<br>1-2<br>1B                |                               | 0-0<br>F7                        |                                 | 4-2<br>HR<br>BB                  | 2-1<br>1-3<br>2-H<br>1B      | 5 2 3 1 1 0 1                   |   |                                 |                              |                                  |                               |                                  |                               |                                  |                                  |                                    |                                  |        |
| Johnny Wyrostek, L (1, 9)<br>OBP: 0.394, SLG: 0.462 | 1-2<br>3-1  |                                  | 1-2<br>E2<br>1B<br>2B        | 3-1<br>F9                       |                               |                                  | 2-0<br>1B<br>2B                 | 4-1<br>HR<br>BB                  | 0-1<br>F8                    | 5 3 2 0 1 0 5                   |   |                                 |                              |                                  |                               |                                  |                               |                                  |                                  |                                    |                                  |        |
| Ted Kluszewski, L (1, 3)<br>OBP: 0.349, SLG: 0.557  | 2-1<br>1B<br>2-H<br>1B                                |                                  | 4-0<br>1B<br>IBB             |                                 | 0-1<br>E9<br>2B<br>2B         |                                  | 0-0<br>2B<br>1B<br>2-H          | 1-0<br>HR<br>2-H                 |                              | 4 3 4 5 1 0 0                   |   |                                 |                              |                                  |                               |                                  |                               |                                  |                                  |                                    |                                  |        |
| Connie Ryan, R (1, 4)<br>OBP: 0.375, SLG: 0.391     | 1-0<br>1-3<br>1B                                      |                                  | 3-2<br>L5-3<br>1B            | 1-3<br>3-H<br>1B                | 0-0<br>4-3<br>FC4-2-5-2<br>2B |                                  | 1-0<br>SH1-4<br>1B<br>2B<br>2-H | 1-3<br>K                         |                              | 5 1 4 3 0 1 0                   |   |                                 |                              |                                  |                               |                                  |                               |                                  |                                  |                                    |                                  |        |
| Joe Adcock, R (1, 7)<br>OBP: 0.299, SLG: 0.361      | 2-3<br>K  |                                  | 1-1<br>L5-3<br>1B            | 1-1<br>1-2                      | 0-0<br>4-3                    |                                  | 4-2<br>SH1-4<br>1B<br>BB        | 2-2<br>6-3                       |                              | 4 0 0 0 1 1 5                   |   |                                 |                              |                                  |                               |                                  |                               |                                  |                                  |                                    |                                  |        |
| Virgil Stallcup, R (1, 6)<br>OBP: 0.282, SLG: 0.354 |   | 0-0<br>F8                        | 0-3<br>K                     |                                 | 0-0<br>FC4-2-5-2              |                                  | 1-1<br>SH1-4                    |                                  | 1-1<br>5-3                   | 4 0 0 0 0 1 2                   | AB 40<br>R 11<br>H 16<br>RBI 10<br>BB 6<br>SO 3<br>LOB 19                             |                                 |                              |                                  |                               |                                  |                               |                                  |                                  |                                    |                                  |        |
| Dixie Howell, R (1, 2)<br>OBP: 0.311, SLG: 0.276    |   | 0-0<br>E5                        |                              | 0-1<br>1B<br>1B                 | 1-0<br>F6                     |                                  | 0-0<br>1-2<br>2-3<br>1B         |                                  | 4-2<br>SH1-4<br>1B<br>BB     | 4 1 2 1 1 0 1                   |   |                                 |                              |                                  |                               |                                  |                               |                                  |                                  |                                    |                                  |        |
| Ewell Blackwell, R (1, 1)<br>OBP: 0.158, SLG: 0.094 |   | 0-1<br>F8                        |                              | 0-1<br>F3                       |                               | 1-1<br>G3                        | 0-0<br>5-3                      |                                  | 1-0<br>SH1-4                 | 4 0 0 0 0 0 3                   |  |                                 |                              |                                  |                               |                                  |                               |                                  |                                  |                                    |                                  |        |
| Inning Stats  | R: 1<br>E: 0<br>K: 1<br>S: 12                         | H: 3<br>LOB: 2<br>BB: 0<br>P: 19 | R: 0<br>E: 1<br>K: 0<br>S: 5 | H: 0<br>LOB: 1<br>BB: 0<br>P: 6 | R: 2<br>E: 1<br>K: 1<br>S: 14 | H: 3<br>LOB: 1<br>BB: 1<br>P: 25 | R: 0<br>E: 0<br>K: 0<br>S: 9    | H: 2<br>LOB: 2<br>BB: 0<br>P: 15 | R: 1<br>E: 1<br>K: 0<br>S: 6 | H: 2<br>LOB: 1<br>BB: 0<br>P: 7 | R: 0<br>E: 0<br>K: 0<br>S: 5  | H: 0<br>LOB: 0<br>BB: 0<br>P: 6 | R: 3<br>E: 0<br>K: 0<br>S: 9 | H: 4<br>LOB: 1<br>BB: 1<br>P: 17 | R: 3<br>E: 0<br>K: 1<br>S: 13 | H: 1<br>LOB: 0<br>BB: 2<br>P: 25 | R: 1<br>E: 0<br>K: 0<br>S: 11 | H: 1<br>LOB: 2<br>BB: 2<br>P: 23 | 1B: 9<br>2B: 7<br>3B: 0<br>HR: 1 | SF: 0<br>SAC: 2<br>DP: 1<br>HBP: 0 | WP: 0<br>PB: 0<br>SB: 1<br>CS: 0 | PA: 48 |
| PITCHER   | IP WLS BF H R ER SO BB IBB HBP BLK WP HR S P ERA WHIP |                                  |                              |                                 |                               |                                  |                                 |                                  |                              |                                 |   |                                 |                              |                                  |                               |                                  |                               |                                  |                                  |                                    |                                  |        |
| Ralph Branca, R (1, 1)<br>ERA: 4.72                 | 5.0 L 26 10 4 3 2 0 1 0 0 0 0 0 46 72 5.40 2.000      |                                  |                              |                                 |                               |                                  |                                 |                                  |                              |                                 |   |                                 |                              |                                  |                               |                                  |                               |                                  |                                  |                                    |                                  |        |
| Joe Hatten, L (6, 1)<br>ERA: 4.98                   | 1.0 7 3 3 3 0 1 0 0 0 0 0 0 10 18 27.00 4.000         |                                  |                              |                                 |                               |                                  |                                 |                                  |                              |                                 |   |                                 |                              |                                  |                               |                                  |                               |                                  |                                  |                                    |                                  |        |
| Joe Landrum, R (7, 1)<br>ERA: 8.1                   | 1.0 3 1 0 0 0 0 0 0 0 0 0 0 4 5 0.00 1.000            |                                  |                              |                                 |                               |                                  |                                 |                                  |                              |                                 |   |                                 |                              |                                  |                               |                                  |                               |                                  |                                  |                                    |                                  |        |
| Dan Bankhead, R (8, 1)<br>ERA: 5.63                 | 2.0 12 2 4 4 1 4 0 0 0 0 0 1 24 48 18.00 3.000        |                                  |                              |                                 |                               |                                  |                                 |                                  |                              |                                 |   |                                 |                              |                                  |                               |                                  |                               |                                  |                                  |                                    |                                  |        |

Cincinnati Reds @ Brooklyn Dodgers  
 Ebbets Field, Brooklyn, NY  
 Sun Aug 06 1950, 3:33 AM EDT  
 Att: 13,242 - Unknown

livebaseballscorecards.com

| Batter  | 1       | 2       | 3       | 4       | 5       | 6       | 7       | 8       | 9       | AB R H RBI BB SO LOB |
|---|---------|---------|---------|---------|---------|---------|---------|---------|---------|----------------------|
| <b>Pee Wee Reese, R</b><br>OBP: 0.365, SLG: 0.368<br>(1, 6)   | 2-3<br> |         | 0-1<br> |         | 0-0<br> |         |         | 0-2<br> | 1-1<br> | 5 1 2 3 0 1 0        |
| <b>Gene Hermanski, L</b><br>OBP: 0.390, SLG: 0.484<br>(1, 7)  | 1-0<br> |         | 1-3<br> |         |         | 2-2<br> |         | 1-2<br> | 0-0<br> | 5 2 4 0 0 1 1        |
| <b>Jim Russell, S</b><br>OBP: 0.333, SLG: 0.480<br>(1, 8)     | 3-3<br> |         | 3-3<br> |         |         | 1-2<br> |         | 2-1<br> | 1-0<br> | 5 0 0 1 0 2 4        |
| <b>Roy Campanella, R</b><br>OBP: 0.376, SLG: 0.568<br>(1, 2)  | 0-0<br> |         |         | 1-2<br> |         | 2-2<br> |         | 0-1<br> |         | 4 0 0 0 0 0 2        |
| <b>Carl Furillo, R</b><br>OBP: 0.353, SLG: 0.494<br>(1, 9)    |         | 2-2<br> |         | 0-1<br> |         | 1-0<br> |         |         | 0-0<br> | 4 2 3 1 0 0 0        |
| <b>Gil Hodges, R</b><br>OBP: 0.393, SLG: 0.499<br>(1, 3)      |         | 1-3<br> |         | 4-1<br> |         | 3-3<br> |         |         | 4-2<br> | 2 0 0 0 2 2 1        |
| <b>Jackie Robinson, R</b><br>OBP: 0.443, SLG: 0.561<br>(1, 4) |         | 2-1<br> |         | 0-2<br> |         |         | 0-1<br> |         | 2-2<br> | 4 1 0 0 0 0 3        |
| <b>Billy Cox, R</b><br>OBP: 0.309, SLG: 0.398<br>(1, 5)       |         | 2-1<br> |         |         | 1-0<br> |         | 1-0<br> |         | 1-1<br> | 4 1 1 1 0 0 0        |
| <b>Ralph Branca, R</b><br>OBP: 0.290, SLG: 0.308<br>(5, PH)   |         |         | 1-2<br> |         | 1-3<br> |         | 2-3<br> |         | 0-0<br> | 1 0 0 0 0 0 0        |
| <b>Wayne Belardi, L</b><br>OBP: 0.091, SLG: 0.091<br>(6, PH)  |         |         |         |         |         |         |         |         |         | 1 0 0 0 0 0 1        |
| <b>Joe Hatten, R</b><br>OBP: 0.091, SLG: 0.091<br>(7, PH)     |         |         |         |         |         |         |         |         |         | 0 0 0 0 0 0 0        |
| <b>Joe Landrum, R</b><br>OBP: 0.091, SLG: 0.091<br>(7, PH)    |         |         |         |         |         |         |         |         |         | 0 0 0 0 0 0 0        |
| <b>Cal Abrams, L</b><br>OBP: 0.091, SLG: 0.091<br>(8, PH)     |         |         |         |         |         |         |         |         |         | 1 0 0 0 0 0 1        |
| <b>Dan Bankhead, R</b><br>OBP: 0.294, SLG: 0.303<br>(9, PH)   |         |         |         |         |         |         |         |         |         | 0 0 0 0 0 0 0        |
| <b>Tommy Brown, R</b><br>OBP: 0.308, SLG: 0.625<br>(9, PH)    |         |         |         |         |         |         |         |         |         | 1 0 0 0 0 0 2        |

| Inning Stats  | R: 0 | H: 1 | E: 0 | K: 2 | S: 8 | R: 1 | H: 1 | E: 0 | K: 1 | S: 10 | R: 0 | H: 1 | E: 0 | K: 2 | S: 12 | R: 0 | H: 0 | E: 0           | K: 0 | S: 10 | R: 0 | H: 0 | E: 0 | K: 1 | S: 5 | R: 1 | H: 2 | E: 1 | K: 1 | S: 13 | R: 0 | H: 0 | E: 0 | K: 1 | S: 6 | R: 1 | H: 1 | E: 0 | K: 0 | S: 10 | R: 4 | H: 4 | E: 0 | K: 0 | S: 13 | 1B: 5 | 2B: 3 | 3B: 0 | HR: 2 | SF: 0 | SAC: 0 | DP: 1 | HBP: 0 | WP: 1 | PA: 39 |
|---|------|------|------|------|------|------|------|------|------|-------|------|------|------|------|-------|------|------|----------------|------|-------|------|------|------|------|------|------|------|------|------|-------|------|------|------|------|------|------|------|------|------|-------|------|------|------|------|-------|-------|-------|-------|-------|-------|--------|-------|--------|-------|--------|
| <b>PITCHER</b><br><b>Ewell Blackwell, R</b><br>ERA: 3.9<br>(1, 1) | IP   | WLS  | BF   | H    | R    | ER   | SO   | BB   | IBB  | HBP   | BLK  | WP   | HR   | S    | P     | ERA  | WHIP |                |      |       |      |      |      |      |      |      |      |      |      |       |      |      |      |      |      |      |      |      |      |       |      |      |      |      |       |       |       |       |       |       |        |       |        |       |        |
|   |      |      |      |      |      |      |      |      |      |       |      |      |      |      |       |      |      | <b>PITCHER</b> | IP   | WLS   | BF   | H    | R    | ER   | SO   | BB   | IBB  | HBP  | BLK  | WP    | HR   | S    | P    | ERA  | WHIP |      |      |      |      |       |      |      |      |      |       |       |       |       |       |       |        |       |        |       |        |

**BOTTOM**

**Cincinnati Reds @ Brooklyn Dodgers**  
Ebbets Field, Brooklyn, NY

Sun Aug 06 1950, 3:33 AM EDT  
Att. 13,242 - Unknown

|            |           |
|------------|-----------|
| <b>AB</b>  | <b>37</b> |
| <b>R</b>   | <b>7</b>  |
| <b>H</b>   | <b>10</b> |
| <b>RBI</b> | <b>6</b>  |
| <b>BB</b>  | <b>2</b>  |
| <b>SO</b>  | <b>8</b>  |
| <b>LOB</b> | <b>13</b> |

B

| Batter  | 1   | 2                               | 3                            | 4                               | 5                            | 6                               | 7                            | 8                               | 9                            | AB R H RBI BB SO LOB                            | TOP                          |                                 |   |                                 |                              |                                 |                              |                                 |                                  |                                    |                                  |        |
|---|---|---------------------------------|------------------------------|---------------------------------|------------------------------|---------------------------------|------------------------------|---------------------------------|------------------------------|---|------------------------------|---------------------------------|---|---------------------------------|------------------------------|---------------------------------|------------------------------|---------------------------------|----------------------------------|------------------------------------|----------------------------------|--------|
| Wayne Terwilliger, R (1, 4)<br>OBP: 0.302, SLG: 0.354   | 0-0<br>1B   |                                 | 0-0<br>F9                    |                                 | 0-0<br>P1                    |                                 | 0-0<br>F9                    |                                 |                              | 4 0 1 0 0 0 2                                   |                              |                                 |   |                                 |                              |                                 |                              |                                 |                                  |                                    |                                  |        |
| Bill Serena, R (1, 5)<br>OBP: 0.349, SLG: 0.435   | 0-0<br>1B   |                                 | 0-0<br>F3                    |                                 | 0-0<br>L3                    |                                 |                              | 0-0<br>F9                       |                              | 4 0 1 0 0 0 1                                   |                              |                                 |   |                                 |                              |                                 |                              |                                 |                                  |                                    |                                  |        |
| Bob Borkowski, R (1, 7)<br>OBP: 0.330, SLG: 0.430   | 0-0<br>F4   |                                 | 0-0<br>HR                    |                                 | 0-0<br>4-3 5-3<br>1B         |                                 |                              | 0-0<br>1B                       |                              | 4 1 3 1 0 0 1                                   |                              |                                 |   |                                 |                              |                                 |                              |                                 |                                  |                                    |                                  |        |
| Hank Sauer, R (1, 3)<br>OBP: 0.357, SLG: 0.489  | 0-0<br>1B   |                                 | 0-0<br>F4                    |                                 | 0-0<br>5-3                   |                                 |                              | 0-0<br>F7                       |                              | 4 0 1 0 0 0 2                                   |                              |                                 |   |                                 |                              |                                 |                              |                                 |                                  |                                    |                                  |        |
| Andy Paiko, R (1, 8)<br>OBP: 0.419, SLG: 0.635<br>Carmen Mauro, L (7, 8)<br>OBP: 0.320, SLG: 0.414  | 0-0<br>5-3  |                                 |                              | 0-0<br>G5-4-3<br>1B             |                              | 0-0<br>4-3                      |                              | 0-0<br>1-3                      |                              | 3 0 1 0 0 0 3<br>1 0 0 0 0 0 1                  |                              |                                 |   |                                 |                              |                                 |                              |                                 |                                  |                                    |                                  |        |
| Roy Smalley, R (1, 6)<br>OBP: 0.312, SLG: 0.449   |   | 0-0<br>6-3                      |                              | 0-0<br>F3                       |                              | 0-0<br>F5                       |                              |                                 | 0-0<br>1B                    | 4 0 1 0 0 0 2                                   |                              |                                 |   |                                 |                              |                                 |                              |                                 |                                  |                                    |                                  |        |
| Hal Jeffcoat, R (1, 9)<br>OBP: 0.233, SLG: 0.310  |   | 0-0<br>5-3                      |                              | 0-0<br>G5-4-3                   |                              |                                 | 0-0<br>F7                    |                                 | 0-0<br>F7                    | 4 0 0 0 0 0 2                                   |                              |                                 |   |                                 |                              |                                 |                              |                                 |                                  |                                    |                                  |        |
| Mickey Owen, R (1, 2)<br>OBP: 0.250, SLG: 0.277   |   | 4-0<br>BB                       |                              |                                 | 0-0<br>4-3<br>2B             |                                 | 0-0<br>2B                    |                                 | 0-0<br>F9                    | 3 0 2 0 1 0 1                                   |                              |                                 |   |                                 |                              |                                 |                              |                                 |                                  |                                    |                                  |        |
| Bob Rush, R (1, 1)<br>OBP: 0.194, SLG: 0.197<br>Dutch Leonard, R (4, 1)<br>OBP: 0.100, SLG: 0.100<br>Emil Verban, R (9, PH)<br>OBP: 0.167, SLG: 0.147 |   | 0-0<br>F3                       |                              |                                 | 0-0<br>4-3                   |                                 | 0-0<br>F7                    |                                 | 0-0<br>F9                    | 1 0 0 0 0 0 1<br>2 0 0 0 0 0 2<br>1 0 0 0 0 0 1 |                              |                                 |   |                                 |                              |                                 |                              |                                 |                                  |                                    |                                  |        |
| <b>Inning Stats</b>   | R: 0<br>E: 0<br>K: 0<br>S: 5  | H: 3<br>LOB: 2<br>BB: 0<br>P: 5 | R: 0<br>E: 0<br>K: 0<br>S: 3 | H: 0<br>LOB: 1<br>BB: 1<br>P: 7 | R: 1<br>E: 0<br>K: 0<br>S: 4 | H: 1<br>LOB: 0<br>BB: 0<br>P: 4 | R: 0<br>E: 0<br>K: 0<br>S: 3 | H: 1<br>LOB: 0<br>BB: 0<br>P: 3 | R: 0<br>E: 0<br>K: 0<br>S: 4 | H: 1<br>LOB: 1<br>BB: 0<br>P: 4                 | R: 0<br>E: 0<br>K: 0<br>S: 4 | H: 1<br>LOB: 1<br>BB: 0<br>P: 4 | R: 0<br>E: 0<br>K: 0<br>S: 4  | H: 1<br>LOB: 1<br>BB: 0<br>P: 4 | R: 0<br>E: 0<br>K: 0<br>S: 4 | H: 1<br>LOB: 1<br>BB: 0<br>P: 4 | R: 0<br>E: 0<br>K: 0<br>S: 4 | H: 1<br>LOB: 1<br>BB: 0<br>P: 4 | 1B: 7<br>2B: 2<br>3B: 0<br>HR: 1 | SF: 0<br>SAC: 0<br>DP: 1<br>HBP: 0 | WP: 0<br>PB: 0<br>SB: 0<br>CS: 0 | PA: 36 |
| <b>PITCHER</b><br>Ken Raffensberger, L (1, 1)<br>ERA: 4.15  | IP: 9.0<br>WLS: W<br>BF: 36<br>H: 10<br>R: 1<br>ER: 1<br>SO: 0<br>BB: 1<br>IBB: 0<br>HBP: 0<br>BLK: 0<br>WP: 0<br>HR: 1<br>S: 35<br>P: 39<br>ERA: 1.00<br>WHIP: 1.222 |                                 |                              |                                 |                              |                                 |                              |                                 |                              |   |                              | <b>PITCHER</b>                  | IP: 9.0<br>WLS: W<br>BF: 36<br>H: 10<br>R: 1<br>ER: 1<br>SO: 0<br>BB: 1<br>IBB: 0<br>HBP: 0<br>BLK: 0<br>WP: 0<br>HR: 1<br>S: 35<br>P: 39<br>ERA: 1.00<br>WHIP: 1.222 |                                 |                              |                                 |                              |                                 |                                  |                                    |                                  |        |

Chicago Cubs @ Cincinnati Reds  
Crosley Field, Cincinnati, OH  
Tue Aug 08 1950, 3:33 AM EDT  
Unknown

livebaseballscorecards.com

AB 35  
R 1  
H 10  
RBI 1  
BB 1  
SO 0  
LOB 19





| Batter   | 1                      | 2                      | 3               | 4               | 5 | 6                        | 7 | 8          | 9 | AB | R | H | RBI | BB | SO | LOB |
|--|------------------------|------------------------|-----------------|-----------------|---|--------------------------|---|------------|---|----|---|---|-----|----|----|-----|
| Lloyd Merriman, L<br>OBP: 0.311, SLG: 0.358<br>(1, 8)  | 0-0<br>1B<br>2B        | 0-0<br>3-1             |                 | 0-0<br>2B<br>1B |   | 4-0<br>2B<br>BB          |   | 0-0<br>F4  |   | 4  | 3 | 2 | 1   | 1  | 0  | 1   |
| Grady Hatton, L<br>OBP: 0.354, SLG: 0.419<br>(1, 5)  | 0-0<br>4-3<br>2B<br>1B | 0-0<br>G1              |                 | 4-0<br>2B<br>BB |   | 0-0<br>2B<br>2B          |   | 0-0<br>3-1 |   | 4  | 3 | 2 | 3   | 1  | 0  | 1   |
| Johnny Wyrostek, L<br>OBP: 0.395, SLG: 0.469<br>Bob Usher, R<br>OBP: 0.318, SLG: 0.387<br>(1, 9)<br>(8, 9) | 0-0<br>3-1<br>1-2      | 0-0<br>F7              |                 | 0-0<br>2B       |   | 0-0<br>4-3<br>2B         |   |            |   | 4  | 0 | 2 | 3   | 0  | 0  | 2   |
| Ted Kluszewski, L<br>OBP: 0.345, SLG: 0.550<br>(1, 3)  | 0-0<br>4-3<br>2-3      |                        | 0-0<br>F8       | 0-0<br>F9       |   | 0-0<br>4-3<br>2-3        |   |            |   | 4  | 0 | 0 | 0   | 0  | 0  | 3   |
| Connie Ryan, R<br>OBP: 0.376, SLG: 0.390<br>Bobby Adams, R<br>OBP: 0.333, SLG: 0.355<br>(1, 4)<br>(8, 4)   | 4-0<br>2B<br>BB        |                        | 0-0<br>F7<br>1B |                 |   | 0-0<br>F4<br>F8          |   |            |   | 3  | 1 | 1 | 0   | 1  | 0  | 1   |
| Joe Adcock, R<br>OBP: 0.298, SLG: 0.364<br>(1, 7)  | 0-0<br>1B<br>2B        |                        | 0-0<br>F7       |                 |   | 0-0<br>F5                |   | 0-0<br>F7  |   | 4  | 1 | 1 | 2   | 0  | 0  | 1   |
| Sammy Meeks, R<br>OBP: 0.333, SLG: 0.405<br>(1, 6)   | 0-0<br>1B              |                        |                 | 0-0<br>1B<br>1B |   | 0-0<br>6-3               |   | 0-3<br>K   |   | 4  | 1 | 2 | 1   | 0  | 1  | 0   |
| Hobie Landrith, L<br>OBP: 0.313, SLG: 0.214<br>(1, 2)  | 0-0<br>6-3             |                        |                 | 0-3<br>K<br>1-2 |   | 0-0<br>SH1-4<br>2B<br>1B |   | 0-0<br>3-1 |   | 4  | 1 | 1 | 0   | 0  | 1  | 2   |
| Ken Raffensberger, R<br>OBP: 0.203, SLG: 0.182<br>(1, 1)   |                        | 0-0<br>E6<br>G1<br>3-1 |                 | 0-3<br>K        |   | 0-0<br>SH1-4             |   | 0-0<br>1-3 |   | 3  | 0 | 0 | 0   | 0  | 1  | 1   |

| Inning Stats                            | R: 4  | H: 4  | E: 0  | LOB: 1 | K: 0  | P: 11 | R: 0  | H: 0   | E: 1  | LOB: 1 | K: 0 | P: 4 | R: 0 | H: 1 | E: 0 | LOB: 0 | K: 0  | P: 3 | R: 3 | H: 3 | E: 0 | LOB: 1 | K: 2 | P: 14 | R: 0 | H: 0 | E: 0 | LOB: 0 | K: 0 | P: 3 | R: 3 | H: 3 | E: 0 | LOB: 1 | K: 0 | P: 10 | R: 0 | H: 0 | E: 0 | LOB: 0 | K: 1 | P: 5 | R: 0 | H: 0 | E: 0 | LOB: 0 | K: 0 | P: 3 |
|---|-------|-------|-------|--------|-------|-------|-------|--------|-------|--------|------|------|------|------|------|--------|-------|------|------|------|------|--------|------|-------|------|------|------|--------|------|------|------|------|------|--------|------|-------|------|------|------|--------|------|------|------|------|------|--------|------|------|
|   | 1B: 6 | SF: 0 | 2B: 5 | SAC: 1 | 3B: 0 | DP: 0 | HR: 0 | HBP: 0 | WP: 0 | PA: 38 |      |      |      |      |      |        |       |      |      |      |      |        |      |       |      |      |      |        |      |      |      |      |      |        |      |       |      |      |      |        |      |      |      |      |      |        |      |      |
| PITCHER                                 | IP    | WLS   | BF    | H      | R     | ER    | SO    | BB     | IBB   | HBP    | BLK  | WP   | HR   | S    | P    | ERA    | WHIP  |      |      |      |      |        |      |       |      |      |      |        |      |      |      |      |      |        |      |       |      |      |      |        |      |      |      |      |      |        |      |      |
| Bob Rush, R<br>ERA: 4.22<br>(1, 1)      | 3.2   | L     | 21    | 8      | 7     | 7     | 2     | 2      | 0     | 0      | 0    | 0    | 0    | 23   | 31   | 17.18  | 2.727 |      |      |      |      |        |      |       |      |      |      |        |      |      |      |      |      |        |      |       |      |      |      |        |      |      |      |      |      |        |      |      |
| Dutch Leonard, R<br>ERA: 4.94<br>(4, 1) | 4.1   |       | 17    | 3      | 3     | 3     | 1     | 1      | 0     | 0      | 0    | 0    | 0    | 18   | 22   | 6.23   | 0.923 |      |      |      |      |        |      |       |      |      |      |        |      |      |      |      |      |        |      |       |      |      |      |        |      |      |      |      |      |        |      |      |

**Chicago Cubs @ Cincinnati Reds**  
 Crosley Field, Cincinnati, OH  
 Tue Aug 08 1950, 3:33 AM EDT  
 Unknown

|     |    |
|-----|----|
| AB  | 34 |
| R   | 10 |
| H   | 11 |
| RBI | 10 |
| BB  | 3  |
| SO  | 3  |
| LOB | 12 |



|       |        |
|-------|--------|
| WP: 0 | PA: 38 |
| PB: 0 | SB: 1  |
| CS: 0 |        |
| ERA   | WHIP   |

livebaseballscorecards.com

| Batter   | 1  | 2   | 3   | 4   | 5   | 6   | 7   | 8   | 9   | AB R H RBI BB SO LOB   | TOP  |   |
|--|--|---|---|---|---|---|---|---|---|--|--|---|
| Emil Verban, R (1, 4)<br>OBP: 0.175, SLG: 0.135          | 4-0<br>F7<br>BB  |   | 0-0<br>F7   |   |   | 0-3<br>K  |   | 0-0<br>F8   |   | 3 0 0 0 1 1 2  |  |   |
| Bill Serena, R (1, 5)<br>OBP: 0.348, SLG: 0.431          | 0-0<br>F7<br>1-2   |   |   | 0-0<br>6-3  |   | 0-0<br>F2   |   |   | 4-0<br>G4-6-3<br>BB   | 3 0 0 0 1 0 1  |  |   |
| Preston Ward, L (1, 3)<br>OBP: 0.343, SLG: 0.444         | 0-0<br>F8  |   |   | 0-0<br>FC4-6<br>1B  |   | 0-0<br>4-3  |   |   | 0-0<br>G4-6-3<br>1-2f   | 4 0 1 0 0 0 1  |  |   |
| Ron Northey, L (1, 9)<br>OBP: 0.362, SLG: 0.494          |  | 0-0<br>F3   |   | 0-0<br>FC4-6<br>1B<br>1-2f                                      |   |   | 0-0<br>F4   |   | 0-0   | 4 0 1 0 0 0 1  |  |   |
| Andy Pafko, R (1, 8)<br>OBP: 0.417, SLG: 0.630           |  | 0-0<br>6-3  |   | 0-0<br>1-2<br>1B  |   |   | 0-0<br>F8   |   | 0-0<br>F8   | 4 0 1 0 0 0 1  |  |   |
| Carmen Mauro, L (1, 7)<br>OBP: 0.321, SLG: 0.411         |  | 0-0<br>2-4<br>1B  |   | 0-0<br>F8   |   |   | 0-0<br>F6   |   |   | 3 0 1 0 0 0 2  |  |   |
| Roy Smalley, R (1, 6)<br>OBP: 0.312, SLG: 0.448          | 0-0<br>2-4<br>1-2  |   | 0-0<br>F7   |   | 0-0<br>F8   |   |   | 0-0<br>1B   |   | 3 0 1 0 0 0 0  |  |   |
| Carl Sawatski, L (1, 2)                                  |  |   | 0-0<br>4-3  |   | 0-3<br>K  |   |   | 0-0<br>F7   |   | 3 0 0 0 0 1 1  |  |   |
| Johnny Klippstein, R (1, 1)<br>OBP: 0.409, SLG: 0.591    |  |   | 4-0<br>BB   |   | 0-0<br>F7   |   |   | 0-3<br>K  |   | 0 0 0 0 0 0 0  |  |   |
| Doyle Lade, R (2, 1)<br>OBP: 0.367, SLG: 0.393           |  |   |   |   |   |   |   |   |   | 1 0 0 0 1 0 0  |  |   |
| Rube Walker, L (8, PH)<br>OBP: 0.289, SLG: 0.339         |  |   |   |   |   |   |   |   |   | 1 0 0 0 0 1 1  |  |   |
| Johnny Vander Meer, S (8, 1)<br>OBP: 0.143, SLG: 0.231   |  |   |   |   |   |   |   |   |   | 0 0 0 0 0 0 0  |  |   |
| <b>Inning Stats</b>                                      | R: 0<br>E: 0<br>K: 0<br>S: 2<br>H: 0<br>LOB: 0<br>BB: 1<br>P: 6  | R: 0<br>E: 0<br>K: 0<br>S: 3<br>H: 1<br>LOB: 1<br>BB: 0<br>P: 3 | R: 0<br>E: 0<br>K: 0<br>S: 3<br>H: 0<br>LOB: 1<br>BB: 1<br>P: 7 | R: 0<br>E: 0<br>K: 0<br>S: 5<br>H: 2<br>LOB: 2<br>BB: 0<br>P: 5 | R: 0<br>E: 0<br>K: 1<br>S: 5<br>H: 0<br>LOB: 0<br>BB: 0<br>P: 5 | R: 0<br>E: 0<br>K: 1<br>S: 5<br>H: 0<br>LOB: 0<br>BB: 0<br>P: 5 | R: 0<br>E: 0<br>K: 0<br>S: 3<br>H: 0<br>LOB: 0<br>BB: 0<br>P: 3 | R: 0<br>E: 0<br>K: 1<br>S: 6<br>H: 1<br>LOB: 1<br>BB: 0<br>P: 6 | R: 0<br>E: 0<br>K: 0<br>S: 3<br>H: 1<br>LOB: 1<br>BB: 1<br>P: 7 | 1B: 5<br>2B: 0<br>3B: 0<br>HR: 0<br>SF: 0<br>SAC: 0<br>DP: 1<br>HBP: 0 | WP: 0<br>PB: 0<br>SB: 0<br>CS: 0<br>PA: 32 |   |
| <b>PITCHER</b><br>Willie Ramsdell, R (1, 1)<br>ERA: 3.58 | IP<br>9.0<br>WLS<br>W<br>BF<br>33<br>H<br>5<br>R<br>0<br>ER<br>0<br>SO<br>3<br>BB<br>3<br>IBB<br>0<br>HBP<br>0<br>BLK<br>0<br>WP<br>0<br>HR<br>0<br>S<br>35<br>P<br>47<br>ERA<br>0.00<br>WHIP<br>0.889 |   |   |   |   |   |   |   |   |  |  | <b>PITCHER</b><br>IP<br>WLS<br>BF<br>H<br>R<br>ER<br>SO<br>BB<br>IBB<br>HBP<br>BLK<br>WP<br>HR<br>S<br>P<br>ERA<br>WHIP |

Chicago Cubs @ Cincinnati Reds  
 Crosley Field, Cincinnati, OH  
 Tue Aug 08 1950, 3:38 AM EDT  
 Att: 12,950 - Unknown

livebaseballscorecards.com

AB 29  
 R 0  
 H 5  
 RBI 0  
 BB 3  
 SO 3  
 LOB 10



| Batter   | 1          | 2                                    | 3                              | 4                         | 5                | 6                | 7                   | 8                      | 9 | AB | R | H | RBI | BB | SO | LOB |
|--|------------|--------------------------------------|--------------------------------|---------------------------|------------------|------------------|---------------------|------------------------|---|----|---|---|-----|----|----|-----|
| Lloyd Merriman, L (1, 8)<br>OBP: 0.318, SLG: 0.361   | 0-0<br>F8  | 4-0<br>BB<br>1B                      | 0-0<br>S<br>1B                 |                           | 0-0<br>1-2<br>1B |                  | 0-0<br>G4-6-3       |                        |   | 4  | 1 | 2 | 1   | 1  | 0  | 1   |
| Grady Hatton, L (1, 5)<br>OBP: 0.358, SLG: 0.417   | 4-0<br>BB  | 4-0<br>1-2<br>2-3<br>2B<br>BB        | 4-0<br>1-2<br>BB               |                           | 0-0<br>4-3       |                  | 0-0<br>1-3          |                        |   | 2  | 1 | 0 | 0   | 3  | 0  | 2   |
| Johnny Wyrostek, L (1, 9)<br>OBP: 0.397, SLG: 0.470<br>Bob Usher, R (7, 9)<br>OBP: 0.317, SLG: 0.386 | 0-0<br>F8  | 0-0<br>2B<br>1-2<br>2-H<br>3-H<br>1B | 0-0<br>6-3                     |                           |                  | 0-0<br>HR<br>1B  |                     | 0-0<br>6-3             |   | 4  | 1 | 2 | 2   | 0  | 0  | 3   |
| Ted Kluszewski, L (1, 3)<br>OBP: 0.348, SLG: 0.563   | 0-0<br>4-3 | 0-0<br>1-3<br>2-H<br>2B              |                                | 0-0<br>K2-4<br>1B         |                  | 0-0<br>1-H<br>HR |                     | 0-0<br>E5<br>1B<br>F8  |   | 5  | 2 | 3 | 3   | 0  | 0  | 1   |
| Connie Ryan, R (1, 4)<br>OBP: 0.379, SLG: 0.392  |            | 0-0<br>3B<br>1B                      |                                | 0-3<br>K2-4<br>1-2f<br>1B |                  | 0-0<br>6-3       |                     | 0-0<br>1B<br>1-3<br>1B |   | 4  | 1 | 2 | 0   | 1  | 1  | 1   |
| Joe Adcock, R (1, 7)<br>OBP: 0.301, SLG: 0.383   |            | 0-0<br>3B<br>FC6-4                   |                                | 0-0<br>F8                 |                  | 0-0<br>2B        |                     | 0-0<br>F8<br>3-H       |   | 5  | 1 | 2 | 2   | 0  | 0  | 4   |
| Sammy Meeks, R (1, 6)<br>OBP: 0.320, SLG: 0.383  |            | 0-0<br>F9<br>3-H                     | 0-0<br>6-3                     |                           | 0-0<br>F7        | 0-0<br>1-3       |                     | 0-0<br>1-2<br>1B       |   | 5  | 0 | 1 | 1   | 0  | 0  | 1   |
| Dixie Howell, R (1, 2)<br>OBP: 0.320, SLG: 0.277   |            | 4-0<br>BB<br>SH3-4<br>1B<br>BB       | 0-0<br>WP<br>SH3-4<br>1B<br>1B |                           | 4-0<br>1B<br>BB  | 0-0<br>6-3       |                     | 0-0<br>F8              |   | 3  | 2 | 1 | 0   | 2  | 0  | 3   |
| Willie Ramsdell, R (1, 1)<br>OBP: 0.263, SLG: 0.200  |            | 0-0<br>SH3-4<br>1-2                  | 0-0<br>SH3-4<br>1-2            |                           | 0-3<br>K         |                  | 0-0<br>G4-6-3<br>1B |                        |   | 2  | 0 | 1 | 0   | 0  | 1  | 1   |

| Inning Stats | R: 0 | H: 0 | E: 0 | K: 0 | S: 3 | LOB: 1 | BB: 1 | P: 7  |
|--------------|------|------|------|------|------|--------|-------|-------|
|              | R: 5 | H: 4 | E: 0 | K: 0 | S: 7 | LOB: 3 | BB: 4 | P: 23 |
|              | R: 1 | H: 2 | E: 0 | K: 0 | S: 5 | LOB: 2 | BB: 1 | P: 9  |
|              | R: 0 | H: 1 | E: 0 | K: 1 | S: 5 | LOB: 0 | BB: 0 | P: 5  |
|              | R: 0 | H: 1 | E: 0 | K: 1 | S: 6 | LOB: 2 | BB: 1 | P: 10 |
|              | R: 2 | H: 3 | E: 0 | K: 0 | S: 6 | LOB: 1 | BB: 0 | P: 6  |
|              | R: 0 | H: 1 | E: 0 | K: 0 | S: 3 | LOB: 0 | BB: 0 | P: 3  |
|              | R: 1 | H: 2 | E: 1 | K: 0 | S: 6 | LOB: 2 | BB: 0 | P: 6  |

| PITCHER                                   | IP  | WLS | BF | H | R | ER | SO | BB | IBB | HBP | BLK | WP | HR | S  | P  | ERA   | WHIP  |
|---|-----|-----|----|---|---|----|----|----|-----|-----|-----|----|----|----|----|-------|-------|
| Johnny Klippstein, R (1, 1)<br>ERA: 5.2   | 1.2 | L   | 13 | 4 | 5 | 5  | 0  | 4  | 0   | 0   | 0   | 0  | 0  | 9  | 25 | 27.00 | 4.800 |
| Doyle Lade, R (2, 1)<br>ERA: 4.47         | 5.1 |     | 25 | 8 | 3 | 3  | 2  | 3  | 0   | 0   | 0   | 1  | 1  | 26 | 38 | 5.06  | 2.062 |
| Johnny Vander Meer, L (8, 1)<br>ERA: 4.15 | 1.0 |     | 6  | 2 | 1 | 0  | 0  | 0  | 0   | 0   | 0   | 0  | 0  | 6  | 6  | 0.00  | 2.000 |

**BOTTOM**

**Chicago Cubs @ Cincinnati Reds**  
Crosley Field, Cincinnati, OH

Tue Aug 08 1950, 3:38 AM EDT  
Att. 12,950 - Unknown

|     |    |
|-----|----|
| AB  | 35 |
| R   | 9  |
| H   | 14 |
| RBI | 9  |
| BB  | 7  |
| SO  | 2  |
| LOB | 17 |

livebaseballscorecards.com



|        |        |       |        |
|--------|--------|-------|--------|
| 1B: 10 | SF: 0  | WP: 1 | PA: 44 |
| 2B: 3  | SAC: 2 | PB: 0 |        |
| 3B: 1  | DP: 2  | SB: 1 |        |
| HR: 1  | HBP: 0 | CS: 0 |        |

| Batter   | 1  | 2                               | 3                            | 4                                | 5                            | 6                               | 7                            | 8                               | 9                              | AB R H RBI BB SO LOB            | TOP                          |                                 |  |                                 |                              |                                 |                              |                                  |                                  |                                    |                                  |        |
|--|--|---------------------------------|------------------------------|----------------------------------|------------------------------|---------------------------------|------------------------------|---------------------------------|--------------------------------|---------------------------------|------------------------------|---------------------------------|--|---------------------------------|------------------------------|---------------------------------|------------------------------|----------------------------------|----------------------------------|------------------------------------|----------------------------------|--------|
| Tommy Glaviano, R (1, 4)<br>OBP: 0.409, SLG: 0.416       | 4-0<br>FC1-6<br>BB   |                                 | 0-3<br>K                     |                                  | 0-0<br>FC6-4<br>1-2f         |                                 |                              | 0-0<br>FC5-4<br>1B              | 0-3<br>K                       | 4 0 1 0 1 2 3                   |                              |                                 |  |                                 |                              |                                 |                              |                                  |                                  |                                    |                                  |        |
| Red Schoendienst, S (1, 6)<br>OBP: 0.320, SLG: 0.416     | 0-0<br>F7  |                                 | 0-0<br>P5                    |                                  |                              | 0-0<br>F9                       |                              | 0-0<br>F8                       |                                | 4 0 0 0 0 0 2                   |                              |                                 |  |                                 |                              |                                 |                              |                                  |                                  |                                    |                                  |        |
| Stan Musial, L (1, 8)<br>OBP: 0.448, SLG: 0.603          | 0-0<br>FC1-6<br>1-2f   |                                 | 0-0<br>P5                    |                                  |                              | 4-0<br>FC5-4<br>BB              |                              | 0-0<br>F9                       |                                | 3 0 0 0 1 0 2                   |                              |                                 |  |                                 |                              |                                 |                              |                                  |                                  |                                    |                                  |        |
| Enos Slaughter, L (1, 9)<br>OBP: 0.397, SLG: 0.474       | 0-0<br>4-3   |                                 |                              | 0-0<br>4-3                       |                              | 0-0<br>FC5-4<br>1-2f            |                              | 0-0<br>FC5-4<br>1-2f            |                                | 4 0 0 0 0 0 3                   |                              |                                 |  |                                 |                              |                                 |                              |                                  |                                  |                                    |                                  |        |
| Hal Rice, L (1, 7)<br>OBP: 0.500, SLG: 0.333             |  | 4-0<br>3-1<br>1B<br>BB          |                              | 0-0<br>6-3                       |                              | 0-0<br>F4                       |                              |                                 | 0-0<br>BB<br>E<br>5-3<br>1B    | 3 2 1 0 1 0 1                   |                              |                                 |  |                                 |                              |                                 |                              |                                  |                                  |                                    |                                  |        |
| Eddie Kazak, R (1, 5)<br>OBP: 0.336, SLG: 0.398          |  | 0-3<br>K                        |                              | 0-0<br>P4                        |                              |                                 | 0-0<br>E5                    |                                 | 0-0<br>E6<br>5-3<br>BB<br>1-2  | 4 0 0 0 0 1 2                   |                              |                                 |  |                                 |                              |                                 |                              |                                  |                                  |                                    |                                  |        |
| Rocky Nelson, L (1, 3)<br>OBP: 0.327, SLG: 0.378         |  |                                 | 0-0<br>3-1<br>1-2            |                                  | 0-0<br>1-3                   |                                 | 0-0<br>F7                    |                                 | 0-0<br>F7                      | 4 0 0 0 0 0 4                   |                              |                                 |  |                                 |                              |                                 |                              |                                  |                                  |                                    |                                  |        |
| Del Rice, R (1, 2)<br>OBP: 0.334, SLG: 0.365             |  |                                 | 0-0<br>1B                    |                                  | 0-0<br>P4                    |                                 | 0-3<br>K                     |                                 | 4-0<br>5-3<br>BB<br>1-2<br>2-3 | 3 0 1 1 1 1 1                   |                              |                                 |  |                                 |                              |                                 |                              |                                  |                                  |                                    |                                  |        |
| Cloyd Boyer, R (1, 1)<br>OBP: 0.273, SLG: 0.250          |  |                                 | 0-3<br>K                     |                                  | 0-0<br>1B                    |                                 | 0-0<br>4-3                   |                                 | 0-0<br>5-3                     | 2 0 1 0 0 1 1                   |                              |                                 |  |                                 |                              |                                 |                              |                                  |                                  |                                    |                                  |        |
| Ted Wilks, R (6, 1)                                      |  |                                 |                              |                                  |                              |                                 |                              |                                 |                                | 0 0 0 0 0 0 0                   |                              |                                 |  |                                 |                              |                                 |                              |                                  |                                  |                                    |                                  |        |
| Bill Howerton, L (7, PH)<br>OBP: 0.392, SLG: 0.472       |  |                                 |                              |                                  |                              |                                 |                              |                                 |                                | 1 0 0 0 0 0 1                   |                              |                                 |  |                                 |                              |                                 |                              |                                  |                                  |                                    |                                  |        |
| Red Munger, R (7, 1)<br>OBP: 0.195, SLG: 0.179           |  |                                 |                              |                                  |                              |                                 |                              |                                 |                                | 0 0 0 0 0 0 0                   |                              |                                 |  |                                 |                              |                                 |                              |                                  |                                  |                                    |                                  |        |
| Nippy Jones, R (9, PH)<br>OBP: 0.304, SLG: 0.200         |  |                                 |                              |                                  |                              |                                 |                              |                                 |                                | 1 0 0 1 0 0 2                   |                              |                                 |  |                                 |                              |                                 |                              |                                  |                                  |                                    |                                  |        |
| <b>Inning Stats</b>                                      | R: 0<br>E: 0<br>K: 0<br>S: 3   | H: 0<br>LOB: 1<br>BB: 1<br>P: 7 | R: 1<br>E: 0<br>K: 2<br>S: 8 | H: 1<br>LOB: 1<br>BB: 1<br>P: 12 | R: 0<br>E: 0<br>K: 1<br>S: 5 | H: 0<br>LOB: 0<br>BB: 0<br>P: 5 | R: 0<br>E: 0<br>K: 0<br>S: 3 | H: 0<br>LOB: 0<br>BB: 0<br>P: 3 | R: 0<br>E: 0<br>K: 0<br>S: 4   | H: 1<br>LOB: 1<br>BB: 0<br>P: 4 | R: 0<br>E: 0<br>K: 0<br>S: 3 | H: 0<br>LOB: 1<br>BB: 1<br>P: 7 | R: 0<br>E: 1<br>K: 1<br>S: 6   | H: 0<br>LOB: 1<br>BB: 0<br>P: 6 | R: 0<br>E: 0<br>K: 0<br>S: 4 | H: 1<br>LOB: 1<br>BB: 0<br>P: 4 | R: 0<br>E: 0<br>K: 0<br>S: 7 | H: 1<br>LOB: 2<br>BB: 1<br>P: 11 | 1B: 4<br>2B: 0<br>3B: 0<br>HR: 0 | SF: 0<br>SAC: 0<br>DP: 0<br>HBP: 0 | WP: 0<br>PB: 0<br>SB: 0<br>CS: 0 | PA: 37 |
| <b>PITCHER</b><br>Ewell Blackwell, R (1, 1)<br>ERA: 3.75 | IP: 9.0<br>WLS: W<br>BF: 37<br>H: 4<br>R: 2<br>ER: 1<br>SO: 5<br>BB: 4<br>IBB: 0<br>HBP: 0<br>BLK: 0<br>WP: 0<br>HR: 0<br>S: 43<br>P: 59<br>ERA: 1.00<br>WHIP: 0.889 |                                 |                              |                                  |                              |                                 |                              |                                 |                                |                                 |                              | <b>PITCHER</b>                  | IP: WLS: BF: H: R: ER: SO: BB: IBB: HBP: BLK: WP: HR: S: P: ERA: WHIP: |                                 |                              |                                 |                              |                                  |                                  |                                    |                                  |        |

St. Louis Cardinals @ Cincinnati Reds  
 Crosley Field, Cincinnati, OH  
 Fri Aug 11 1950, 3:33 AM EDT  
 Att: 12,654 - Unknown

livebaseballscorecards.com

|     |    |
|-----|----|
| AB  | 33 |
| R   | 2  |
| H   | 4  |
| RBI | 2  |
| BB  | 4  |
| SO  | 5  |
| LOB | 22 |



| Batter  | 1          | 2         | 3         | 4            | 5          | 6         | 7            | 8            | 9 |
|---|------------|-----------|-----------|--------------|------------|-----------|--------------|--------------|---|
| Lloyd Merriman, L<br><small>OBP: 0.325, SLG: 0.360</small>  | 0-0<br>1-3 |           | 0-0<br>F5 |              | 4-0<br>1B  | 0-0<br>1B |              | 4-0<br>BB    |   |
| Grady Hatton, L<br><small>OBP: 0.358, SLG: 0.413</small>    | 4-0<br>BB  |           | 0-0<br>P6 |              | 0-0<br>F8  | 4-0<br>1B |              | 0-0<br>FC3-6 |   |
| Johnny Wyrostek, L<br><small>OBP: 0.399, SLG: 0.468</small> | 0-0<br>F8  |           |           | 4-0<br>2B    | 0-0<br>2B  | 0-0<br>1B |              | 4-0<br>BB    |   |
| Ted Kluszewski, L<br><small>OBP: 0.352, SLG: 0.569</small>  | 0-0<br>F2  |           |           | 0-0<br>F9    | 0-0<br>2B  |           | 0-0<br>SH2-3 | 0-0<br>P6    |   |
| Connie Ryan, R<br><small>OBP: 0.376, SLG: 0.388</small>     |            | 0-0<br>P4 |           | 0-0<br>P6    | 0-0<br>E3  |           | 0-0<br>SH2-3 |              |   |
| Joe Adcock, R<br><small>OBP: 0.300, SLG: 0.376</small>      |            | 4-0<br>BB |           | 0-0<br>F9    | 0-0<br>4-3 |           | 0-0<br>6-3   |              |   |
| Sammy Meeks, R<br><small>OBP: 0.352, SLG: 0.412</small>     |            | 0-0<br>1B |           | 0-0<br>FC5-4 |            | 0-0<br>1B |              | 0-0<br>F9    |   |
| Bob Scheffing, R<br><small>OBP: 0.317, SLG: 0.390</small>   |            | 0-0<br>F5 |           | 0-0<br>FC5-4 |            | 0-0<br>F9 |              | 0-0<br>FC1-6 |   |
| Ewell Blackwell, R<br><small>OBP: 0.148, SLG: 0.088</small> |            |           | 0-0<br>F7 |              | 0-0<br>F3  | 0-0<br>F9 |              | 0-0<br>FC1-6 |   |

| Inning Stats | R: 0 | H: 0 | E: 0 | K: 0 | S: 3 | R: 0 | H: 1 | E: 0 | K: 0 | S: 3 | R: 0 | H: 0 | E: 0 | K: 0 | S: 3 | R: 2 | H: 2 | E: 1 | K: 0 | S: 5 | R: 2 | H: 2 | E: 1 | K: 0 | S: 6 | R: 1 | H: 2 | E: 1 | K: 0 | S: 5 | R: 0 | H: 1 | E: 0 | K: 0 | S: 4 | R: 0 | H: 1 | E: 0 | K: 0 | S: 4 | R: 0 | H: 1 | E: 0 | K: 0 | S: 4 |   |   |   |   |
|--------------|------|------|------|------|------|------|------|------|------|------|------|------|------|------|------|------|------|------|------|------|------|------|------|------|------|------|------|------|------|------|------|------|------|------|------|------|------|------|------|------|------|------|------|------|------|---|---|---|---|
|              | 0    | 0    | 0    | 0    | 3    | 0    | 1    | 0    | 0    | 3    | 0    | 0    | 0    | 0    | 3    | 2    | 2    | 1    | 0    | 5    | 2    | 2    | 1    | 0    | 6    | 1    | 2    | 1    | 2    | 1    | 0    | 0    | 4    | 0    | 1    | 0    | 4    | 0    | 1    | 0    | 4    | 0    | 1    | 0    | 4    | 0 | 1 | 0 | 2 |

| PITCHER                                    | IP     | WLS | BF | H  | R | ER | SO | BB | IBB | HBP | BLK | WP | HR | S  | P  | ERA  | WHIP  |
|--|--------|-----|----|----|---|----|----|----|-----|-----|-----|----|----|----|----|------|-------|
| Cloyd Boyer, R<br><small>ERA: 2.84</small> | (1, 1) | 5.2 | L  | 29 | 7 | 5  | 3  | 0  | 5   | 0   | 0   | 0  | 0  | 24 | 44 | 4.76 | 2.118 |
| Ted Wilks, R<br><small>ERA: 7.94</small>   | (6, 1) | 0.1 |    | 1  | 0 | 0  | 0  | 0  | 0   | 0   | 0   | 0  | 0  | 1  | 1  | 0.00 | 0.000 |
| Red Munger, R<br><small>ERA: 4.09</small>  | (7, 1) | 2.0 |    | 10 | 2 | 0  | 0  | 2  | 0   | 0   | 0   | 0  | 0  | 8  | 16 | 0.00 | 2.000 |

AB R H RBI BB SO LOB

|   |   |   |   |   |   |   |
|---|---|---|---|---|---|---|
| 3 | 1 | 1 | 1 | 2 | 0 | 0 |
| 3 | 0 | 0 | 0 | 2 | 0 | 3 |
| 3 | 2 | 1 | 1 | 2 | 0 | 3 |
| 5 | 1 | 3 | 1 | 0 | 0 | 4 |
| 3 | 0 | 0 | 0 | 0 | 0 | 2 |
| 3 | 0 | 0 | 1 | 1 | 0 | 3 |
| 4 | 1 | 3 | 0 | 0 | 0 | 1 |
| 4 | 0 | 1 | 0 | 0 | 0 | 3 |
| 4 | 0 | 0 | 0 | 0 | 0 | 2 |

|       |        |       |        |
|-------|--------|-------|--------|
| 1B: 7 | SF: 0  | WP: 0 | PA: 40 |
| 2B: 2 | SAC: 1 | PB: 0 |        |
| 3B: 0 | DP: 0  | SB: 1 |        |
| HR: 0 | HBP: 0 | CS: 1 |        |

| PITCHER | IP | WLS | BF | H | R | ER | SO | BB | IBB | HBP | BLK | WP | HR | S | P | ERA | WHIP |
|---------|----|-----|----|---|---|----|----|----|-----|-----|-----|----|----|---|---|-----|------|
|         |    |     |    |   |   |    |    |    |     |     |     |    |    |   |   |     |      |

**St. Louis Cardinals @ Cincinnati Reds**  
 Crosley Field, Cincinnati, OH  
 Fri Aug 11 1950, 3:33 AM EDT  
 Att. 12,654 - Unknown

livebaseballscorecards.com

|     |    |
|-----|----|
| AB  | 32 |
| R   | 5  |
| H   | 9  |
| RBI | 4  |
| BB  | 7  |
| SO  | 0  |
| LOB | 21 |



| Batter  | 1   | 2  | 3  | 4  | 5   | 6   | 7   | 8  | 9   | AB R H RBI BB SO LOB   | TOP   |
|---|---|--|--|--|---|---|---|--|---|--|---|
| Tommy Glaviano, R (1, 4)<br>OBP: 0.417, SLG: 0.426  | 4-0<br>1B<br>BB   | 4-0<br>BB  |  | 4-0<br>L4-3<br>BB  |   | 0-0<br>2B   |   | 0-0<br>1-3<br>2B   |   | 2 1 2 0 3 0 0  |   |
| Red Schoendienst, S (1, 6)<br>OBP: 0.317, SLG: 0.411  | 0-0<br>4-3<br>1-2   | 0-0<br>F9  |  | 0-0<br>L4-3<br>1-2   |   | 0-0<br>4-3  |   | 0-0<br>F8  |   | 5 0 0 0 0 0 7  |   |
| Stan Musial, L (1, 8)<br>(9, 7)<br>OBP: 0.452, SLG: 0.605   | 0-0<br>FC3-6<br>2-H<br>1B   |  | 0-0<br>E<br>1B   | 4-0<br>BB  |   | 0-0<br>P6   |   | 0-0<br>1B<br>SH<br>F8<br>1B                                      |   | 4 2 3 1 1 0 1  |   |
| Enos Slaughter, L (1, 9)<br>OBP: 0.393, SLG: 0.470  | 0-0<br>FC3-6<br>1-2f<br>E   |  | 0-0<br>F5  | 0-0<br>F8  |   |   | 0-0<br>F2   | 0-0<br>SH<br>1B  |   | 4 0 0 0 0 0 3  |   |
| Hal Rice, L (1, 7)<br>OBP: 0.353, SLG: 0.214<br>Chuck Diering, R (9, 8)<br>OBP: 0.385, SLG: 0.372 | 0-0<br>E4<br>1-2  |  | 0-0<br>E3<br>BB<br>E   |  | 0-0<br>6-3  |   | 0-3<br>K  | 0-0<br>P1  |   | 5 0 0 0 0 1 4<br>0 0 0 0 0 0 0   |   |
| Eddie Kazak, R (1, 5)<br>OBP: 0.338, SLG: 0.394   | 0-0<br>4-3  |  | 0-0<br>E3<br>BB  | 4-0<br>BB  |   | 0-0<br>F3   |   | 0-0<br>1-2<br>2-3<br>1B  |   | 4 0 1 1 1 0 3  |   |
| Rocky Nelson, L (1, 3)<br>OBP: 0.329, SLG: 0.374  |   | 0-0<br>1-3<br>1B   | 0-0<br>F8  |  | 0-0<br>F9   |   |   | 4-0<br>FC3-6<br>BB   | 0-0<br>F8<br>3-H  | 4 0 1 1 1 0 5  | AB 36<br>R 3<br>H 7<br>RBI 3<br>BB 7<br>SO 5<br>LOB 33                                |
| Del Rice, R (1, 2)<br>OBP: 0.332, SLG: 0.360  |   | 0-3<br>K   | 4-0<br>BB  | 0-0<br>F8<br>1-2<br>2-3<br>BB                                    |   | 0-0<br>F8   |   | 0-0<br>FC3-6<br>2B<br>1-2f                                       | 0-0<br>F3   | 4 0 0 0 1 1 5  |   |
| Max Lanier, R (1, 1)<br>OBP: 0.207, SLG: 0.218  |   | 0-0<br>1-3   | 0-3<br>K   |  |   | 0-3<br>K  |   | 0-3<br>K   |   | 4 0 0 0 0 3 5  |  |
| Inning Stats  | R: 1<br>E: 1<br>K: 0<br>S: 5<br>H: 1<br>LOB: 2<br>BB: 1<br>P: 9   | R: 0<br>E: 0<br>K: 1<br>S: 6<br>H: 1<br>LOB: 2<br>BB: 1<br>P: 10 | R: 1<br>E: 2<br>K: 1<br>S: 8<br>H: 1<br>LOB: 3<br>BB: 1<br>P: 12 | R: 0<br>E: 0<br>K: 0<br>S: 2<br>H: 0<br>LOB: 1<br>BB: 2<br>P: 10 | R: 0<br>E: 0<br>K: 0<br>S: 3<br>H: 0<br>LOB: 1<br>BB: 1<br>P: 7 | R: 0<br>E: 0<br>K: 1<br>S: 6<br>H: 1<br>LOB: 1<br>BB: 0<br>P: 6 | R: 0<br>E: 0<br>K: 1<br>S: 5<br>H: 0<br>LOB: 0<br>BB: 0<br>P: 5 | R: 0<br>E: 0<br>K: 1<br>S: 6<br>H: 1<br>LOB: 2<br>BB: 1<br>P: 10 | R: 1<br>E: 1<br>K: 0<br>S: 6<br>H: 2<br>LOB: 2<br>BB: 0<br>P: 6 | 1B: 5<br>2B: 3<br>3B: 0<br>HR: 0<br>SF: 0<br>SAC: 1<br>DP: 1<br>HBP: 0 | WP: 0<br>PB: 0<br>SB: 0<br>CS: 0<br>PA: 44  |
| PITCHER<br>Herm Wehmeier, R (1, 1)<br>ERA: 5.67   | IP 9.0<br>WLS L<br>BF 44<br>H 7<br>R 3<br>ER 1<br>SO 5<br>BB 7<br>IBB 0<br>HBP 0<br>BLK 0<br>WP 0<br>HR 0<br>S 47<br>P 75<br>ERA 1.00<br>WHIP 1.556 | PITCHER<br>IP WLS BF H R ER SO BB IBB HBP BLK WP HR S P ERA WHIP |  |  |   |   |   |  |   |  |   |

St. Louis Cardinals @ Cincinnati Reds  
 Crosley Field, Cincinnati, OH  
 Sat Aug 12 1950, 3:33 AM EDT  
 Att: 14,293 - Unknown

livebaseballscorecards.com

| Batter  | 1         | 2                      | 3          | 4                   | 5         | 6               | 7               | 8                       | 9                        | AB R H RBI BB SO LOB           |
|---|-----------|------------------------|------------|---------------------|-----------|-----------------|-----------------|-------------------------|--------------------------|--------------------------------|
| <b>Bobby Adams, R</b> (1, 5)<br>OBP: 0.331, SLG: 0.349  | 0-0<br>F8 |                        | 0-0<br>6-3 |                     | 0-3<br>K  |                 |                 | 0-0<br>6-3              | 4-0<br>BB                | 4 0 0 0 1 1 1                  |
| <b>Bob Usher, R</b> (1, 8)<br>OBP: 0.318, SLG: 0.386  | 0-0<br>P6 |                        | 0-0<br>5-3 |                     |           | 0-0<br>G3<br>1B |                 | 0-0<br>E BB<br>F7<br>1B | 0-3<br>K                 | 5 1 2 0 0 1 3                  |
| <b>Johnny Wyrostek, L</b> (1, 9)<br>OBP: 0.396, SLG: 0.464<br><b>Peanuts Lowrey, R</b> (7, 9)<br>OBP: 0.324, SLG: 0.296 | 0-3<br>K  |                        |            | 0-0<br>4-3          |           | 0-3<br>K        |                 | 4-0<br>BB               | 0-3<br>K                 | 3 0 0 0 0 2 1<br>1 0 0 0 1 1 3 |
| <b>Ted Kluszewski, L</b> (1, 3)<br>OBP: 0.348, SLG: 0.563   |           | 0-0<br>F5              |            | 0-0<br>E8<br>E      |           | 0-0<br>G3       |                 | 0-0<br>E6               |                          | 4 0 0 0 0 0 3                  |
| <b>Connie Ryan, R</b> (1, 4)<br>OBP: 0.375, SLG: 0.384  |           | 4-0<br>1B<br>5-3<br>BB |            | 0-0<br>E1<br>G6-4-3 |           | 0-0<br>P6       |                 | 0-0<br>F7               |                          | 3 0 0 1 1 0 4                  |
| <b>Joe Adcock, R</b> (1, 7)<br>OBP: 0.299, SLG: 0.374   |           | 0-0<br>5-3             |            | 0-0<br>G6-4-3       |           |                 | 0-0<br>G3<br>1B | 0-3<br>K                |                          | 4 0 1 0 0 1 5                  |
| <b>Sammy Meeks, R</b> (1, 6)<br>OBP: 0.362, SLG: 0.418  |           | 0-0<br>1B              |            |                     | 0-0<br>F9 |                 | 0-0<br>G3       |                         | 0-0<br>SH5-4<br>BB<br>1B | 4 0 2 0 0 0 1                  |
| <b>Dixie Howell, R</b> (1, 2)<br>OBP: 0.318, SLG: 0.272<br><b>Lloyd Merriman, L</b> (9, PR)<br>OBP: 0.325, SLG: 0.360   |           | 0-3<br>K               |            | 0-0<br>6-3          |           | 0-0<br>P6       |                 | 4-0<br>SH5-4<br>BB      | 0-3<br>K                 | 3 0 0 0 1 1 3<br>0 0 0 0 0 0 0 |
| <b>Herm Wehmeier, R</b> (1, 1)<br>OBP: 0.208, SLG: 0.239<br><b>Danny Litwhiler, R</b> (9, PH)<br>OBP: 0.385, SLG: 0.506 |           |                        | 0-0<br>F3  |                     | 0-0<br>1B |                 | 0-3<br>K        |                         | 0-0<br>SH5-4             | 3 0 1 0 0 1 1<br>0 0 0 0 0 0 0 |

| Inning Stats                             | R: 0 | H: 0 | E: 0 | K: 1 | S: 5 | R: 0 | H: 1 | E: 0 | K: 1 | S: 6 | R: 0 | H: 0 | E: 0 | K: 0 | S: 3 | R: 0 | H: 0 | E: 2 | K: 0 | S: 4 | R: 0 | H: 1 | E: 0 | K: 1 | S: 6 | R: 0 | H: 1 | E: 0 | K: 1 | S: 6 | R: 0 | H: 1 | E: 1 | K: 1 | S: 7 | R: 0 | H: 1 | E: 0 | K: 2 | S: 8 | R: 0 | H: 1 | E: 0 | K: 1 | S: 8 | 1B: 6 | 2B: 0 | 3B: 0 | HR: 0 | SF: 0 | SAC: 1 | DP: 1 | HBP: 0 | WP: 0 | PA: 39 |
|--|------|------|------|------|------|------|------|------|------|------|------|------|------|------|------|------|------|------|------|------|------|------|------|------|------|------|------|------|------|------|------|------|------|------|------|------|------|------|------|------|------|------|------|------|------|-------|-------|-------|-------|-------|--------|-------|--------|-------|--------|
| <b>Max Lanier, L</b> (1, 1)<br>ERA: 2.65 | IP   | WLS  | BF   | H    | R    | ER   | SO   | BB   | IBB  | HBP  | BLK  | WP   | HR   | S    | P    | ERA  | WHIP |      |      |      |      |      |      |      |      |      |      |      |      |      |      |      |      |      |      |      |      |      |      |      |      |      |      |      |      |       |       |       |       |       |        |       |        |       |        |

**St. Louis Cardinals @ Cincinnati Reds**  
Crosley Field, Cincinnati, OH  
Sat Aug 12 1950, 3:33 AM EDT  
Att. 14,293 - Unknown

|     |    |
|-----|----|
| AB  | 34 |
| R   | 1  |
| H   | 6  |
| RBI | 1  |
| BB  | 4  |
| SO  | 8  |
| LOB | 25 |



| Batter  | 1   | 2   | 3   | 4   | 5   | 6   | 7   | 8   | 9   | AB R H RBI BB SO LOB  | TOP  |   |
|---|---|---|---|---|---|---|---|---|---|---|--|---|
| Tommy Glaviano, R (1, 4)<br>OBP: 0.420, SLG: 0.430  | 0-0<br>FC4-6<br>1B                                    |   | 0-0<br>FC6-4<br>3B                                  |   | 0-0<br>FC4-6<br>1B                                  |   |   | 0-0<br>1B<br>1B                                     |   | 4 1 3 0 0 0 1   | <b>St. Louis Cardinals @ Cincinnati Reds</b><br>Crosley Field, Cincinnati, OH<br>Sun Aug 13 1950, 3:33 AM EDT<br>Att: 13,824 - Unknown |   |
| Red Schoendienst, S (1, 6)<br>OBP: 0.319, SLG: 0.416  | 0-0<br>F7   |   | 0-0<br>1B<br>3B                                     |   | 0-0<br>FC4-6  |   |   | 0-0<br>1-2<br>1B                                    |   | 4 1 2 1 0 0 2   |  |   |
| Stan Musial, L (1, 7)<br>OBP: 0.451, SLG: 0.601   | 0-0<br>FC4-6  |   | 0-0<br>1B   |   |   | 0-0<br>P6   |   | 0-0<br>F8   |   | 4 0 1 1 0 0 3   |  |   |
| Enos Slaughter, L (1, 9)<br>OBP: 0.391, SLG: 0.466<br>Hal Rice, L (6, 9)<br>OBP: 0.333, SLG: 0.200  | 0-0<br>F7   |   | 0-0<br>F9   |   |   | 0-0<br>F8   |   | 0-0<br>F8   |   | 3 0 0 0 0 0 2<br>1 0 0 0 0 0 2  |  |   |
| Eddie Kazak, R (1, 5)<br>OBP: 0.336, SLG: 0.390   |   | 0-0<br>1-3  |   | 0-0<br>6-3  |   | 0-0<br>5-3  |   |   | 0-0<br>FC6-4<br>1B                                  | 4 0 1 0 0 0 0   |  |   |
| Rocky Nelson, L (1, 3)<br>OBP: 0.321, SLG: 0.364  |   | 0-0<br>F7   |   | 0-0<br>F9   |   | 0-0<br>P4   |   |   | 0-0<br>FC6-4  | 4 0 0 0 0 0 1   |  |   |
| Chuck Diering, R (1, 8)<br>OBP: 0.382, SLG: 0.369   |   | 0-0<br>5-3  |   | 0-0<br>F7   |   | 0-0<br>G6-4-3<br>1B                                 |   |   | 0-3<br>K  | 4 0 1 0 0 1 1   |  |   |
| Del Rice, R (1, 2)<br>OBP: 0.328, SLG: 0.354  |   |   | 0-0<br>F3   |   | 0-0<br>5-3  |   | 0-0<br>G6-4-3                                       |   | 0-0<br>F7   | 4 0 0 0 0 0 2   |  |   |
| Al Brazle, L (1, 1)<br>OBP: 0.205, SLG: 0.205<br>Gerry Staley, R (5, 1)<br>OBP: 0.179, SLG: 0.162<br>Howie Pollet, L (5, 1)<br>OBP: 0.154, SLG: 0.129<br>Marty Marion, R (8, PH)<br>OBP: 0.337, SLG: 0.360<br>Fred Martin, R (8, 1)<br>OBP: 0.231, SLG: 0.385 |   |   | 0-0<br>FC6-4<br>1B                                  |   | 0-0<br>P5   |   |   | 0-0<br>5-3  |   | 2 0 1 0 0 0 0<br>0 0 0 0 0 0 0<br>0 0 0 0 0 0 0<br>1 0 0 0 0 0 0<br>0 0 0 0 0 0 0 |  |   |
| <b>Inning Stats</b>   | R: 0 H: 1<br>E: 0 LOB: 1<br>K: 0 BB: 0<br>S: 4 P: 4   | R: 0 H: 0<br>E: 0 LOB: 0<br>K: 0 BB: 0<br>S: 3 P: 3 | R: 2 H: 3<br>E: 0 LOB: 1<br>K: 0 BB: 0<br>S: 6 P: 6 | R: 0 H: 0<br>E: 0 LOB: 0<br>K: 0 BB: 0<br>S: 3 P: 3 | R: 0 H: 1<br>E: 0 LOB: 1<br>K: 0 BB: 0<br>S: 4 P: 4 | R: 0 H: 0<br>E: 0 LOB: 0<br>K: 0 BB: 0<br>S: 3 P: 3 | R: 0 H: 1<br>E: 0 LOB: 0<br>K: 0 BB: 0<br>S: 3 P: 3 | R: 0 H: 2<br>E: 0 LOB: 2<br>K: 0 BB: 0<br>S: 5 P: 5 | R: 0 H: 1<br>E: 0 LOB: 1<br>K: 1 BB: 0<br>S: 6 P: 6 | 1B: 8 SF: 0<br>2B: 0 SAC: 0<br>3B: 1 DP: 1<br>HR: 0 HBP: 0                        |  | WP: 0 PA: 35<br>PB: 0<br>SB: 0<br>CS: 0                                 |
| <b>PITCHER</b><br>Ken Raffensberger, L (1, 1)<br>ERA: 4.04  | IP WLS BF H R ER SO BB IBB HBP BLK WP HR S P ERA WHIP |   |   |   |   |   |   |   |   |   |  | <b>PITCHER</b><br>IP WLS BF H R ER SO BB IBB HBP BLK WP HR S P ERA WHIP |
|   | 9.0 W 35 9 2 2 1 0 0 0 0 0 0 0 37 37 2.00 1.000       |   |   |   |   |   |   |   |   |   |  |   |

livebaseballscorecards.com

|            |    |
|------------|----|
| <b>AB</b>  | 35 |
| <b>R</b>   | 2  |
| <b>H</b>   | 9  |
| <b>RBI</b> | 2  |
| <b>BB</b>  | 0  |
| <b>SO</b>  | 1  |
| <b>LOB</b> | 14 |





| Batter   | 1                     | 2                    | 3          | 4                  | 5                                 | 6         | 7                              | 8 | 9 |
|--|-----------------------|----------------------|------------|--------------------|-----------------------------------|-----------|--------------------------------|---|---|
| <b>Bobby Adams, R</b><br>OBP: 0.341, SLG: 0.369 (1, 5)   | 0-0<br>G6-4-3<br>1B   |                      | 0-0<br>2B  |                    | 0-0<br>1B 2B<br>1-H<br>2-H<br>3-H |           | 0-0<br>FC3-6<br>1B             |   |   |
| <b>Peanuts Lowrey, R</b><br>OBP: 0.322, SLG: 0.294 (1, 7)<br><b>Lloyd Merriman, L</b><br>OBP: 0.327, SLG: 0.362 (4, 7)   | 0-0<br>G6-4-3<br>1-2f |                      | 0-0<br>F8  |                    | 0-0<br>1B                         |           | 0-0<br>FC3-6<br>G1-6-3<br>1-2f |   |   |
| <b>Danny Litwhiler, R</b><br>OBP: 0.377, SLG: 0.494 (1, 9)<br><b>Johnny Wyrostek, L</b><br>OBP: 0.397, SLG: 0.464 (5, 9) | 0-0<br>F7             |                      |            | 0-0<br>5-3         | 0-0<br>2B 1B                      |           | 0-0<br>G1-6-3<br>1-2f          |   |   |
| <b>Bob Usher, R</b><br>OBP: 0.317, SLG: 0.388 (1, 8)   |                       | 0-0<br>F8            |            | 0-0<br>L7          | 0-0<br>2B                         |           | 0-0<br>L9                      |   |   |
| <b>Connie Ryan, R</b><br>OBP: 0.376, SLG: 0.384 (1, 4)   |                       | 0-0<br>5-3           |            | 0-0<br>FC4<br>1B   | 0-0<br>FC6-4<br>BB                |           | 0-3<br>K                       |   |   |
| <b>Joe Adcock, R</b><br>OBP: 0.298, SLG: 0.367 (1, 3)  |                       | 4-0<br>FC6-4<br>BB   |            | 0-0<br>FC4<br>1-2f | 0-0<br>FC6-4<br>1-2f              |           | 0-0<br>6-3                     |   |   |
| <b>Sammy Meeks, R</b><br>OBP: 0.361, SLG: 0.431 (1, 6)   |                       | 0-0<br>FC6-4<br>1-2f |            |                    | 0-0<br>1B 2B                      | 0-0<br>F9 |                                |   |   |
| <b>Dixie Howell, R</b><br>OBP: 0.318, SLG: 0.273 (1, 2)  |                       |                      | 0-0<br>5-3 |                    | 0-0<br>1B 2B                      | 0-3<br>K  |                                |   |   |
| <b>Ken Raffensberger, R</b><br>OBP: 0.210, SLG: 0.190 (1, 1)   |                       |                      | 0-0<br>6-3 |                    | 0-0<br>2B 1B                      | 0-0<br>F8 |                                |   |   |

| Inning Stats                     | R: 0<br>E: 0<br>K: 0<br>S: 3       | H: 1<br>LOB: 0<br>BB: 0<br>P: 3 | R: 0<br>E: 0<br>K: 0<br>S: 3 | H: 0<br>LOB: 1<br>BB: 1<br>P: 7 | R: 0<br>E: 0<br>K: 0<br>S: 4 | H: 1<br>LOB: 1<br>BB: 0<br>P: 4 | R: 0<br>E: 0<br>K: 0<br>S: 4 | H: 1<br>LOB: 1<br>BB: 0<br>P: 4 | R: 3<br>E: 0<br>K: 0<br>S: 8 | H: 7<br>LOB: 3<br>BB: 1<br>P: 12 | R: 0<br>E: 0<br>K: 1<br>S: 5 | H: 0<br>LOB: 0<br>BB: 0<br>P: 5 | R: 0<br>E: 0<br>K: 0<br>S: 3 | H: 1<br>LOB: 0<br>BB: 0<br>P: 3 | R: 0<br>E: 0<br>K: 1<br>S: 5 | H: 0<br>LOB: 0<br>BB: 0<br>P: 5 |
|----------------------------------|------------------------------------|---------------------------------|------------------------------|---------------------------------|------------------------------|---------------------------------|------------------------------|---------------------------------|------------------------------|----------------------------------|------------------------------|---------------------------------|------------------------------|---------------------------------|------------------------------|---------------------------------|
| 1B: 7<br>2B: 4<br>3B: 0<br>HR: 0 | SF: 0<br>SAC: 0<br>DP: 2<br>HBP: 0 | WP: 0<br>PA: 33<br>ERA<br>WHIP  |                              |                                 |                              |                                 |                              |                                 |                              |                                  |                              |                                 |                              |                                 |                              |                                 |

| PITCHER                                    | IP  | WLS | BF | H | R | ER | SO | BB | IBB | HBP | BLK | WP | HR | S  | P  | ERA  | WHIP  |
|--|-----|-----|----|---|---|----|----|----|-----|-----|-----|----|----|----|----|------|-------|
| <b>Al Brazle, L</b><br>ERA: 4.99 (1, 1)    | 4.1 | L   | 19 | 7 | 3 | 3  | 0  | 1  | 0   | 0   | 0   | 0  | 0  | 18 | 22 | 6.23 | 1.846 |
| <b>Gerry Staley, R</b><br>ERA: 5.54 (5, 1) | 0.1 |     | 3  | 3 | 0 | 0  | 0  | 0  | 0   | 0   | 0   | 0  | 0  | 3  | 3  | 0.00 | 9.000 |
| <b>Howie Pollet, L</b><br>ERA: 3.39 (5, 1) | 2.1 |     | 8  | 1 | 0 | 0  | 1  | 1  | 0   | 0   | 0   | 0  | 0  | 9  | 13 | 0.00 | 0.857 |
| <b>Fred Martin, R</b><br>ERA: 5.03 (8, 1)  | 1.0 |     | 3  | 0 | 0 | 0  | 1  | 0  | 0   | 0   | 0   | 0  | 0  | 5  | 5  | 0.00 | 0.000 |

**BOTTOM**

**St. Louis Cardinals @ Cincinnati Reds**  
Crosley Field, Cincinnati, OH

Sun Aug 13 1950, 3:33 AM EDT  
Att. 13,824 - Unknown

livebaseballscorecards.com

|            |           |
|------------|-----------|
| <b>AB</b>  | <b>31</b> |
| <b>R</b>   | <b>3</b>  |
| <b>H</b>   | <b>11</b> |
| <b>RBI</b> | <b>3</b>  |
| <b>BB</b>  | <b>2</b>  |
| <b>SO</b>  | <b>2</b>  |
| <b>LOB</b> | <b>9</b>  |



| Batter   | 1   | 2                               | 3                            | 4                               | 5                             | 6                                | 7                            | 8                               | 9                            | AB R H RBI BB SO LOB                            | TOP                          |                                 |                              |                                 |                              |                                 |                              |                                 |                                  |                                    |                                  |        |
|--|---|---------------------------------|------------------------------|---------------------------------|-------------------------------|----------------------------------|------------------------------|---------------------------------|------------------------------|---|------------------------------|---------------------------------|------------------------------|---------------------------------|------------------------------|---------------------------------|------------------------------|---------------------------------|----------------------------------|------------------------------------|----------------------------------|--------|
| <b>Bobby Adams, R</b> (1, 5)<br>OBP: 0.346, SLG: 0.369<br><b>Grady Hatton, L</b> (3, PH)<br>OBP: 0.357, SLG: 0.408   | 4-0<br>1B<br>BB                                       |                                 | HBP 1B<br>BB                 |                                 | 0-0<br>4-3                    |                                  | 0-0<br>G3                    |                                 | 0-0<br>F9                    | 0 1 0 0 2 0 0<br>3 1 0 1 1 0 2                  |                              |                                 |                              |                                 |                              |                                 |                              |                                 |                                  |                                    |                                  |        |
| <b>Bob Usher, R</b> (1, 8)<br>OBP: 0.319, SLG: 0.389<br><b>Lloyd Merriman, L</b> (3, PH)<br>OBP: 0.330, SLG: 0.361   | 0-0<br>F9   |                                 | HBP 1B<br>BB                 |                                 | 0-0<br>4-3                    |                                  | 0-0                          |                                 | 0-0<br>P1                    | 2 1 1 0 0 0 1<br>3 1 1 2 1 0 1                  |                              |                                 |                              |                                 |                              |                                 |                              |                                 |                                  |                                    |                                  |        |
| <b>Johnny Wyrostek, L</b> (1, 9)<br>OBP: 0.399, SLG: 0.465   | 0-0<br>F9   |                                 | HBP 1B<br>BB                 |                                 |                               | 0-0<br>SH1-4<br>FC6-2<br>1B      | 0-0<br>6-3                   |                                 |                              | 4 2 2 2 0 0 2                                   |                              |                                 |                              |                                 |                              |                                 |                              |                                 |                                  |                                    |                                  |        |
| <b>Ted Kluszewski, L</b> (1, 3)<br>OBP: 0.354, SLG: 0.568  | 0-0<br>1B   |                                 | HBP 1B<br>BB                 |                                 |                               | 0-0<br>FC6-2<br>SH1-4<br>1B      |                              | 0-0<br>F9                       |                              | 4 1 3 3 1 0 0                                   |                              |                                 |                              |                                 |                              |                                 |                              |                                 |                                  |                                    |                                  |        |
| <b>Connie Ryan, R</b> (1, 4)<br>OBP: 0.375, SLG: 0.382   | 0-0<br>F2   |                                 | HBP 1B<br>BB                 |                                 |                               | 0-0<br>SH1-4                     |                              | 0-0<br>F6                       |                              | 4 1 1 2 0 0 3                                   |                              |                                 |                              |                                 |                              |                                 |                              |                                 |                                  |                                    |                                  |        |
| <b>Joe Adcock, R</b> (1, 7)<br>OBP: 0.301, SLG: 0.381  |   | 0-0<br>F4                       | 0-0<br>F2                    | 4-0<br>G6-4-3<br>BB             |                               | 0-0<br>FC6-2<br>FC5-4            |                              | 0-0<br>HR                       |                              | 4 1 1 1 1 0 4                                   |                              |                                 |                              |                                 |                              |                                 |                              |                                 |                                  |                                    |                                  |        |
| <b>Sammy Meeks, R</b> (1, 6)<br>OBP: 0.348, SLG: 0.413   |   | 0-0<br>F8                       | 0-0<br>BB<br>HBP<br>BB<br>1B | 0-0<br>G6-4-3                   |                               | 0-0<br>FC5-4                     |                              | 0-0<br>5-3                      |                              | 5 1 1 2 0 0 3                                   |                              |                                 |                              |                                 |                              |                                 |                              |                                 |                                  |                                    |                                  |        |
| <b>Dixie Howell, R</b> (1, 2)<br>OBP: 0.320, SLG: 0.278  |   | 0-3<br>K                        | 1-0<br>BB<br>BB<br>HBP       | 0-0<br>P2                       |                               |                                  | 0-0<br>F7                    |                                 | 0-0<br>2B                    | 4 1 1 0 0 1 0                                   |                              |                                 |                              |                                 |                              |                                 |                              |                                 |                                  |                                    |                                  |        |
| <b>Willie Ramsdell, R</b> (1, 1)<br>OBP: 0.268, SLG: 0.189<br><b>Howie Fox, R</b> (5, 1)<br>OBP: 0.225, SLG: 0.325<br><b>Frank Smith, R</b> (7, 1)<br>OBP: 0.067, SLG: 0.067 |   |                                 | F7                           |                                 | 0-0<br>F7                     |                                  | 0-0<br>G3<br>1B              |                                 | 0-3<br>K2-3                  | 2 1 0 0 1 0 0<br>1 1 1 0 0 0 0<br>1 0 0 0 0 1 1 |                              |                                 |                              |                                 |                              |                                 |                              |                                 |                                  |                                    |                                  |        |
| <b>Inning Stats</b>  | R: 0<br>E: 0<br>K: 0<br>S: 4                          | H: 1<br>LOB: 2<br>BB: 1<br>P: 8 | R: 0<br>E: 0<br>K: 1<br>S: 5 | H: 0<br>LOB: 0<br>BB: 5<br>P: 5 | R: 11<br>E: 0<br>K: 0<br>S: 8 | H: 5<br>LOB: 1<br>BB: 5<br>P: 30 | R: 0<br>E: 0<br>K: 0<br>S: 2 | H: 0<br>LOB: 0<br>BB: 1<br>P: 6 | R: 0<br>E: 0<br>K: 0<br>S: 3 | H: 0<br>LOB: 0<br>BB: 0<br>P: 3                 | R: 0<br>E: 0<br>K: 0<br>S: 5 | H: 2<br>LOB: 2<br>BB: 0<br>P: 5 | R: 1<br>E: 0<br>K: 0<br>S: 5 | H: 2<br>LOB: 1<br>BB: 0<br>P: 5 | R: 1<br>E: 0<br>K: 0<br>S: 4 | H: 1<br>LOB: 0<br>BB: 0<br>P: 4 | R: 0<br>E: 0<br>K: 1<br>S: 6 | H: 1<br>LOB: 1<br>BB: 0<br>P: 6 | 1B: 9<br>2B: 2<br>3B: 0<br>HR: 1 | SF: 0<br>SAC: 1<br>DP: 1<br>HBP: 2 | WP: 0<br>PB: 0<br>SB: 0<br>CS: 0 | PA: 47 |
| <b>PITCHER</b>   | IP WLS BF H R ER SO BB IBB HBP BLK WP HR S P ERA WHIP |                                 |                              |                                 |                               |                                  |                              |                                 |                              |   |                              |                                 |                              |                                 |                              |                                 |                              |                                 |                                  |                                    |                                  |        |
| <b>Vic Lombardi, L</b> (1, 1)<br>ERA: 7.64   | 2.1 L 14 3 5 5 1 3 0 1 0 0 0 12 25 19.29 2.571        |                                 |                              |                                 |                               |                                  |                              |                                 |                              |   |                              |                                 |                              |                                 |                              |                                 |                              |                                 |                                  |                                    |                                  |        |
| <b>Bill Pierro, R</b> (3, 1)<br>ERA: 10.72   | 0.1 6 1 2 2 0 3 0 1 0 0 0 2 15 54.00 12.000           |                                 |                              |                                 |                               |                                  |                              |                                 |                              |   |                              |                                 |                              |                                 |                              |                                 |                              |                                 |                                  |                                    |                                  |        |
| <b>Murry Dickson, R</b> (3, 1)<br>ERA: 4.04  | 3.1 14 4 4 4 0 1 0 0 0 0 0 13 17 10.80 1.500          |                                 |                              |                                 |                               |                                  |                              |                                 |                              |   |                              |                                 |                              |                                 |                              |                                 |                              |                                 |                                  |                                    |                                  |        |
| <b>Bill MacDonald, R</b> (7, 1)<br>ERA: 4.66   | 3.0 13 4 2 2 1 0 0 0 0 0 0 1 15 6.00 1.333            |                                 |                              |                                 |                               |                                  |                              |                                 |                              |   |                              |                                 |                              |                                 |                              |                                 |                              |                                 |                                  |                                    |                                  |        |

**Cincinnati Reds @ Pittsburgh Pirates**  
 Forbes Field, Pittsburgh, PA  
 Mon Aug 14 1950, 3:33 AM EDT  
 Att. 4,306 - Unknown

[livebaseballscorecards.com](http://livebaseballscorecards.com)

**AB 37**  
**R 13**  
**H 12**  
**RBI 13**  
**BB 7**  
**SO 2**  
**LOB 17**



BOTTOM

Cincinnati Reds @ Pittsburgh Pirates  
Forbes Field, Pittsburgh, PA  
Mon Aug 14 1950, 3:33 AM EDT  
Att. 4,306 - Unknown

livebaseballscorecards.com

AB 40  
R 8  
H 13  
RBI 6  
BB 6  
SO 5  
LOB 30



WP: 3 PA: 46  
PB: 0  
SB: 2  
CS: 0

AB R H RBI BB SO LOB

2 1 1 0 1 0 1  
2 2 1 0 1 0 2

5 1 2 1 0 1 1

4 0 1 0 1 0 3

4 2 1 1 1 0 5

5 2 2 1 0 1 5

4 0 2 2 1 1 2

1 0 1 0 0 0 0  
3 0 1 1 1 1 1

2 0 0 0 0 0 2  
3 0 0 0 0 1 5

1B: 8 SF: 0  
2B: 4 SAC: 0  
3B: 1 DP: 2  
HR: 0 HBP: 0

| Batter   | 1                      | 2                   | 3                     | 4               | 5  | 6                | 7                                 | 8                     | 9         |
|--|------------------------|---------------------|-----------------------|-----------------|--|------------------|-----------------------------------|-----------------------|-----------|
| Bob Dillinger, R (1, 5)<br>Pete Castiglione, R (5, PR)<br>Pete Castiglione, R (6, 5)   | 0-0<br>E<br>F7<br>2B   | 0-0<br>F8           |                       |                 | 4-0<br>2B<br>FC6-4<br>BB                 | 0-0<br>4-3<br>3B |                                   | 4-0<br>1B<br>BB       | 0-0<br>F3 |
| Johnny Hopp, L (1, 3)<br>OBP: 0.415, SLG: 0.502  | 0-3<br>K               |                     | 0-0<br>6-3            |                 | 0-0<br>FC6-4<br>WP<br>2B                 | 0-0<br>4-3       |                                   | 0-0<br>1-3<br>S<br>1B |           |
| Danny O'Connell, R (1, 6)<br>OBP: 0.290, SLG: 0.427  | 0-0<br>E6<br>BB<br>2-3 |                     | 0-0<br>G6-4-3<br>1B   |                 | 4-0<br>FC6-4<br>BB                       | 0-0<br>F2        |                                   | 0-0<br>F5<br>1-2      |           |
| Ralph Kiner, R (1, 7)<br>OBP: 0.416, SLG: 0.606  | 4-0<br>1-2<br>BB       |                     | 0-0<br>G6-4-3<br>1-2f |                 | 0-0<br>FC6-4<br>WP<br>1-2f<br>2-3<br>3-H |                  | 0-0<br>2B<br>1B<br>1B             | 0-0<br>F4             |           |
| Gus Bell, L (1, 9)<br>OBP: 0.314, SLG: 0.417   | 0-0<br>F7<br>3-H       |                     |                       | 0-0<br>1B<br>2B | 0-3<br>K<br>1-3<br>3-H                   |                  | 0-0<br>1B<br>2B                   | 0-0<br>4-3            |           |
| Wally Westlake, R (1, 8)<br>OBP: 0.344, SLG: 0.445   | 0-0<br>F7              |                     |                       | 0-0<br>1B       | 4-0<br>BB<br>WP<br>BB                    |                  | 0-0<br>G4-6-3<br>1B<br>2-3<br>3-H | 0-3<br>K              |           |
| Danny Murtaugh, R (1, 4)<br>Johnny Berardino, R (4, 4)<br>OBP: 0.372, SLG: 0.401<br>OBP: 0.500, SLG: 0.375   |                        | 0-0<br>E<br>S<br>1B |                       | 0-3<br>K        | 4-0<br>1-3<br>BB                         |                  | 0-0<br>G4-6-3<br>1B<br>1-2        | 0-0<br>E4<br>1B       |           |
| Clyde McCullough, R (1, 2)<br>Ray Mueller, R (5, PH)<br>Ray Mueller, R (6, 2)<br>OBP: 0.357, SLG: 0.452<br>OBP: 0.311, SLG: 0.443  |                        | 0-0<br>F3<br>1-3    |                       | 0-0<br>F9       | 0-0<br>6-3                               |                  | 0-0<br>G4-6-3<br>1-2f<br>2-3      | 0-3<br>K              |           |
| Vic Lombardi, L (1, 1)<br>Bill Pierre, R (3, 1)<br>Murry Dickson, R (3, 1)<br>Ted Beard, L (6, PH)<br>Bill MacDonald, R (7, 1)<br>Hank Schenz, R (9, PH)<br>OBP: 0.318, SLG: 0.250<br>OBP: 0.250, SLG: 0.250<br>OBP: 0.250, SLG: 0.255<br>OBP: 0.333, SLG: 0.356<br>OBP: 0.206, SLG: 0.129<br>OBP: 0.274, SLG: 0.340 |                        | 0-0<br>F8           |                       | 0-0<br>1-3      |  | 0-0<br>F7        | 0-0<br>F9                         | 0-0<br>1-2<br>1B      |           |

| Inning Stats | R: 1 | H: 1 | E: 1 | K: 1 | S: 7 | LOB: 2 | BB: 1 | P: 11 | R: 0 | H: 1 | E: 0 | K: 0 | S: 4 | LOB: 1 | BB: 0 | P: 4 | R: 0 | H: 1 | E: 0 | K: 0 | S: 3 | LOB: 0 | BB: 0 | P: 3 | R: 1 | H: 2 | E: 0 | K: 1 | S: 7 | LOB: 1 | BB: 0 | P: 7 | R: 3 | H: 1 | E: 0 | K: 1 | S: 6 | LOB: 2 | BB: 4 | P: 22 | R: 1 | H: 1 | E: 0 | K: 0 | S: 4 | LOB: 0 | BB: 0 | P: 4 | R: 2 | H: 4 | E: 0 | K: 0 | S: 6 | LOB: 1 | BB: 0 | P: 6 | R: 0 | H: 1 | E: 0 | K: 0 | S: 4 | LOB: 2 | BB: 1 | P: 8 | R: 0 | H: 1 | E: 1 | K: 2 | S: 9 | LOB: 2 | BB: 0 | P: 9 | 1B: 8 | SF: 0 | 2B: 4 | SAC: 0 | 3B: 1 | DP: 2 | HR: 0 | HBP: 0 | WP: 3 | PA: 46 |
|--------------|------|------|------|------|------|--------|-------|-------|------|------|------|------|------|--------|-------|------|------|------|------|------|------|--------|-------|------|------|------|------|------|------|--------|-------|------|------|------|------|------|------|--------|-------|-------|------|------|------|------|------|--------|-------|------|------|------|------|------|------|--------|-------|------|------|------|------|------|------|--------|-------|------|------|------|------|------|------|--------|-------|------|-------|-------|-------|--------|-------|-------|-------|--------|-------|--------|
|--------------|------|------|------|------|------|--------|-------|-------|------|------|------|------|------|--------|-------|------|------|------|------|------|------|--------|-------|------|------|------|------|------|------|--------|-------|------|------|------|------|------|------|--------|-------|-------|------|------|------|------|------|--------|-------|------|------|------|------|------|------|--------|-------|------|------|------|------|------|------|--------|-------|------|------|------|------|------|------|--------|-------|------|-------|-------|-------|--------|-------|-------|-------|--------|-------|--------|

| PITCHER                                | IP  | WLS | BF | H | R | ER | SO | BB | IBB | HBP | BLK | WP | HR | S  | P  | ERA   | WHIP  |
|--|-----|-----|----|---|---|----|----|----|-----|-----|-----|----|----|----|----|-------|-------|
| Willie Ramsdell, R (1, 1)<br>ERA: 3.76 | 4.2 |     | 25 | 6 | 5 | 4  | 3  | 5  | 0   | 0   | 0   | 2  | 0  | 26 | 46 | 7.71  | 2.357 |
| Howie Fox, R (5, 1)<br>ERA: 4.95       | 1.1 |     | 9  | 5 | 3 | 3  | 0  | 0  | 0   | 0   | 0   | 0  | 0  | 9  | 9  | 20.25 | 3.750 |
| Frank Smith, R (7, 1)<br>ERA: 3.39     | 3.0 | W   | 12 | 2 | 0 | 0  | 2  | 1  | 0   | 0   | 0   | 0  | 0  | 15 | 19 | 0.00  | 1.000 |

| Batter | 1 | 2 | 3 | 4 | 5 | 6 | 7 | 8 | 9 | AB R H RBI BB SO LOB | TOP |
|--------|---|---|---|---|---|---|---|---|---|----------------------|-----|
|--------|---|---|---|---|---|---|---|---|---|----------------------|-----|

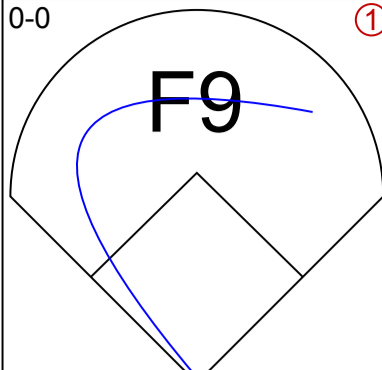
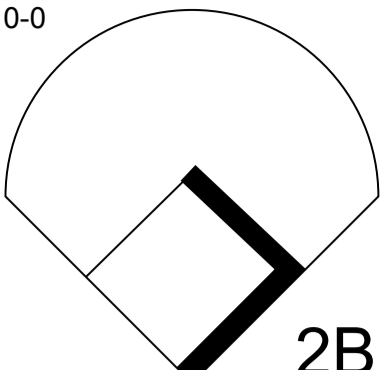
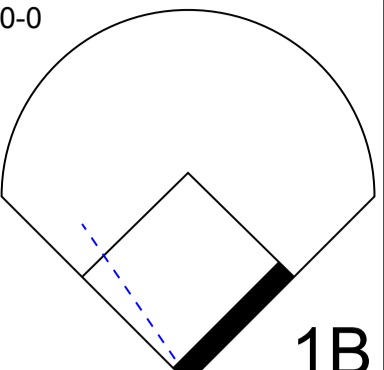
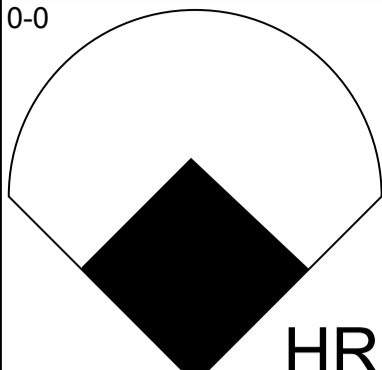
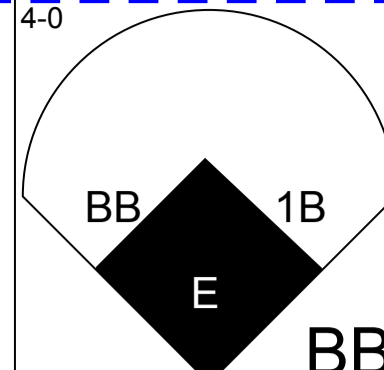
|  |   |  |   |  |   |  |  |   |   |                                |   |
|--|---|--|---|--|---|--|--|---|---|--------------------------------|---|
| <b>Bobby Adams, R</b> (1, 5)<br><small>OBP: 0.353, SLG: 0.394</small><br><b>Lloyd Merriman, L</b> (9, PH)<br><small>OBP: 0.333, SLG: 0.361</small><br>(9, 8) | 0-0  |  | 0-0  |  | 0-0  |  |  | 0-0  | 4-0  | 4 1 3 1 0 0 0<br>0 1 0 0 1 0 0 | <b>Cincinnati Reds @ Pittsburgh Pirates</b><br>Forbes Field, Pittsburgh, PA<br>Tue Aug 15 1950, 3:33 AM EDT<br>Att. 5,495 - Unknown |
|--|---|--|---|--|---|--|--|---|---|--------------------------------|---|

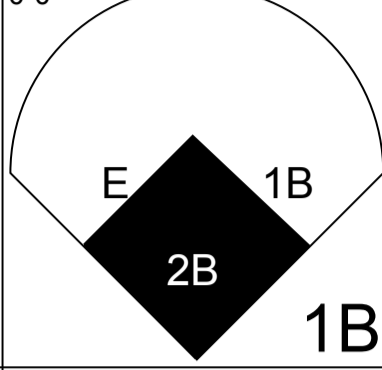
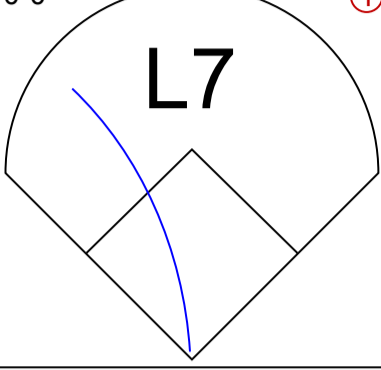
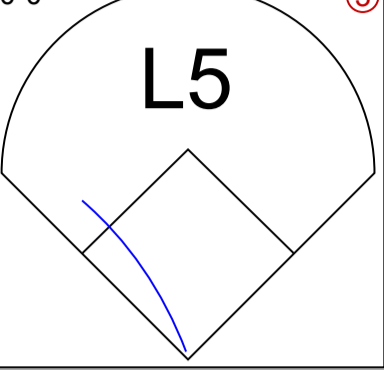
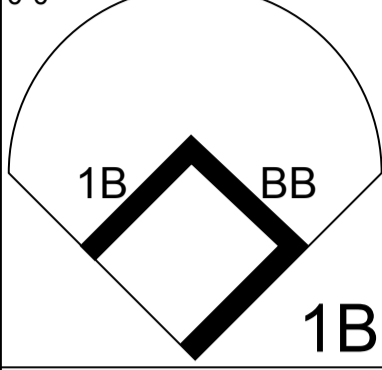
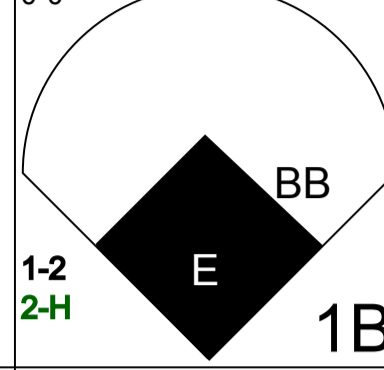
|  |   |  |   |  |   |  |  |   |   |                                |   |
|--|---|--|---|--|---|--|--|---|---|--------------------------------|---|
| <b>Bob Usher, R</b> (1, 8)<br><small>OBP: 0.322, SLG: 0.391</small><br><b>Grady Hatton, L</b> (9, PH)<br><small>OBP: 0.359, SLG: 0.410</small><br>(9, 5) | 0-0  |  | 0-0  |  | 0-0  |  |  | 0-0  | 0-0  | 4 1 2 0 0 0 2<br>1 1 1 1 0 0 0 | <b>Cincinnati Reds @ Pittsburgh Pirates</b><br>Forbes Field, Pittsburgh, PA<br>Tue Aug 15 1950, 3:33 AM EDT<br>Att. 5,495 - Unknown |
|--|---|--|---|--|---|--|--|---|---|--------------------------------|---|

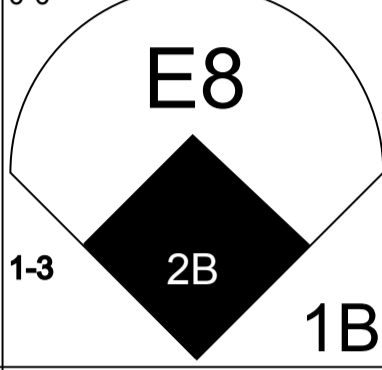
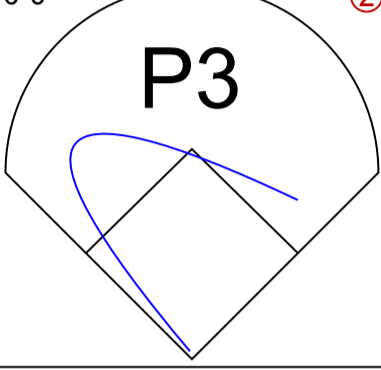
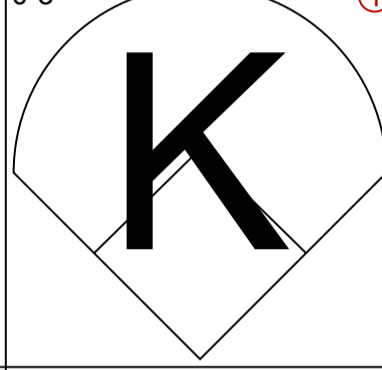
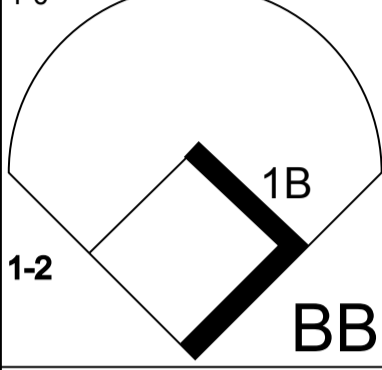
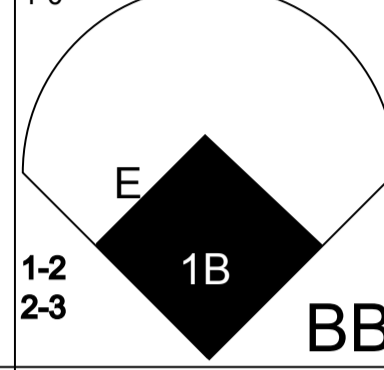
|   |   |  |   |  |  |   |  |   |   |               |   |
|---|---|--|---|--|--|---|--|---|---|---------------|---|
| <b>Johnny Wyrostek, L</b> (1, 9)<br><small>OBP: 0.402, SLG: 0.463</small> | 0-0  |  | 0-0  |  |  | 0-3  |  | 4-0  | 4-0  | 3 2 1 0 2 1 1 | <b>Cincinnati Reds @ Pittsburgh Pirates</b><br>Forbes Field, Pittsburgh, PA<br>Tue Aug 15 1950, 3:33 AM EDT<br>Att. 5,495 - Unknown |
|---|---|--|---|--|--|---|--|---|---|---------------|---|

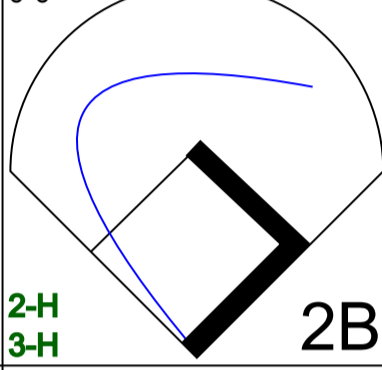
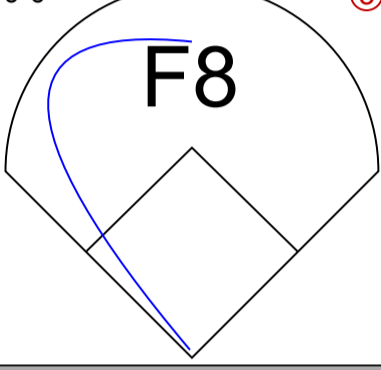
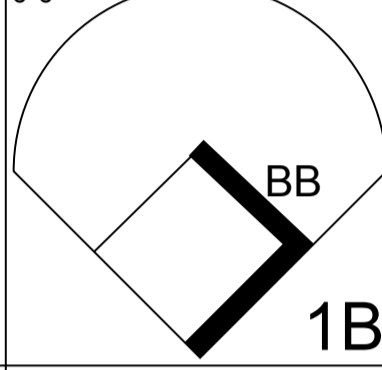
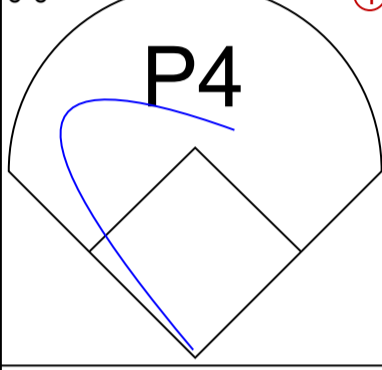
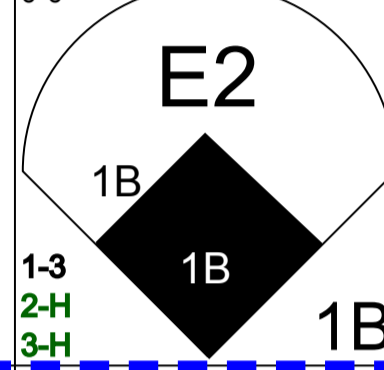
|  |   |  |   |  |  |   |  |   |   |               |   |
|--|---|--|---|--|--|---|--|---|---|---------------|---|
| <b>Ted Kluszewski, L</b> (1, 3)<br><small>OBP: 0.358, SLG: 0.571</small> | 0-0  |  | 0-0  |  |  | 0-0  |  | 0-0  | 0-0  | 5 1 3 2 0 0 3 | <b>Cincinnati Reds @ Pittsburgh Pirates</b><br>Forbes Field, Pittsburgh, PA<br>Tue Aug 15 1950, 3:33 AM EDT<br>Att. 5,495 - Unknown |
|--|---|--|---|--|--|---|--|---|---|---------------|---|

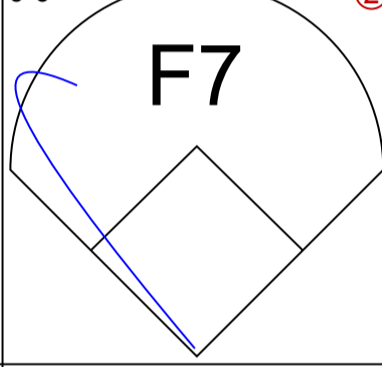
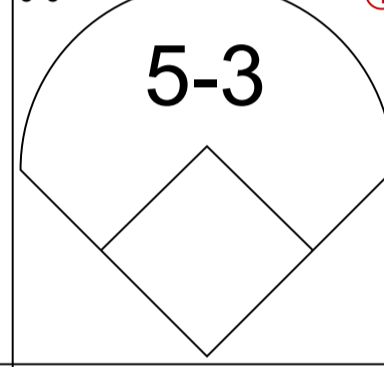
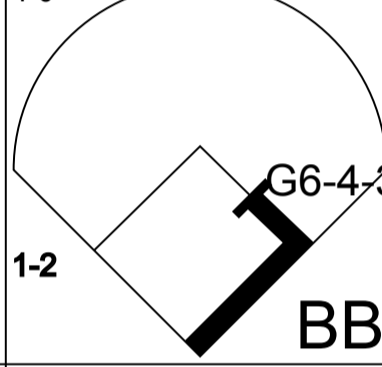
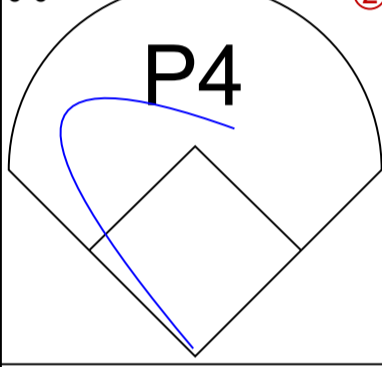
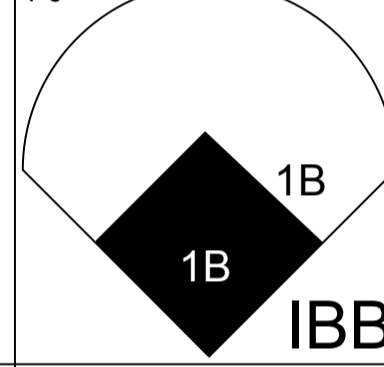
|   |   |  |  |   |  |  |  |   |   |   |               |   |
|---|---|--|--|---|--|--|--|---|---|---|---------------|---|
| <b>Connie Ryan, R</b> (1, 4)<br><small>OBP: 0.375, SLG: 0.378</small> | 0-0  |  |  | 0-0  |  |  |  | 4-0  | 0-0  | 4-0  | 3 1 0 0 2 0 3 | <b>Cincinnati Reds @ Pittsburgh Pirates</b><br>Forbes Field, Pittsburgh, PA<br>Tue Aug 15 1950, 3:33 AM EDT<br>Att. 5,495 - Unknown |
|---|---|--|--|---|--|--|--|---|---|---|---------------|---|

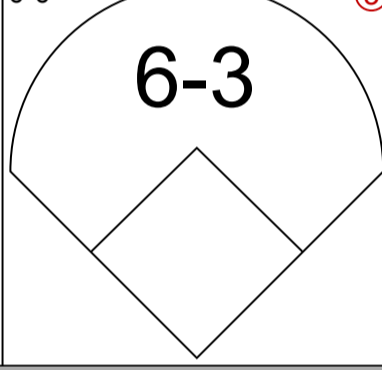
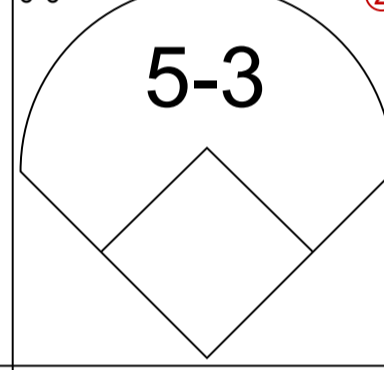
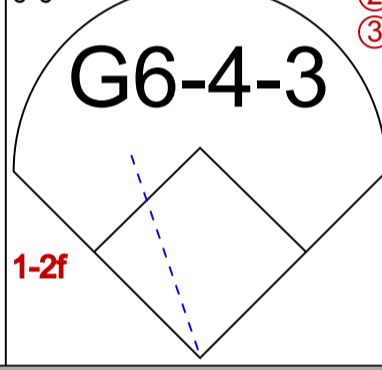
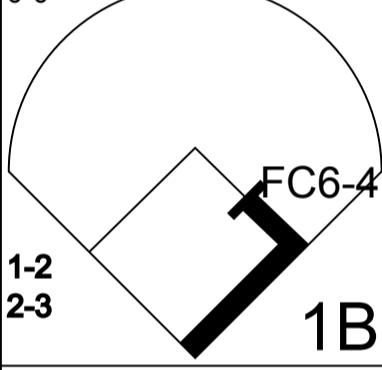
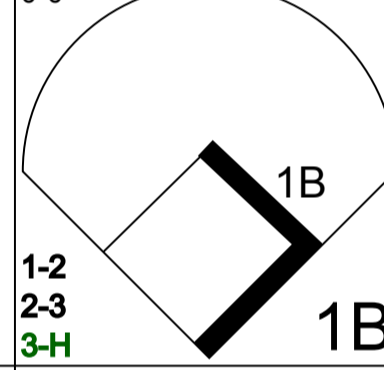
|  |  |  |  |  |  |  |  |  |  |  |               |   |
|--|--|--|--|--|--|--|--|--|--|--|---------------|---|
| <b>Joe Adcock, R</b> (1, 7)<br><small>OBP: 0.303, SLG: 0.382</small> | 0-0  |  |  | 0-0  |  |  |  | 0-0  | 0-0  | 0-0  | 5 0 2 1 0 0 3 | <b>Cincinnati Reds @ Pittsburgh Pirates</b><br>Forbes Field, Pittsburgh, PA<br>Tue Aug 15 1950, 3:33 AM EDT<br>Att. 5,495 - Unknown |
|--|--|--|--|--|--|--|--|--|--|--|---------------|---|

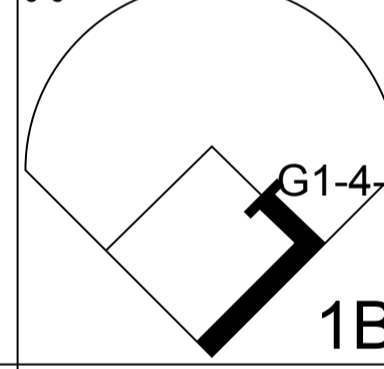
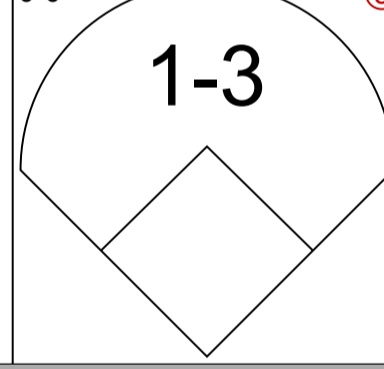
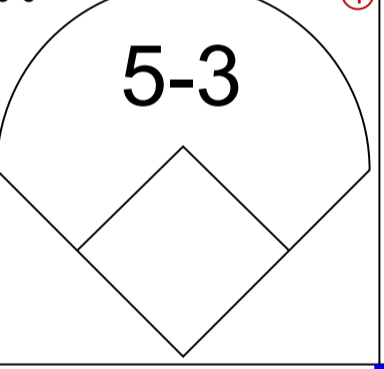
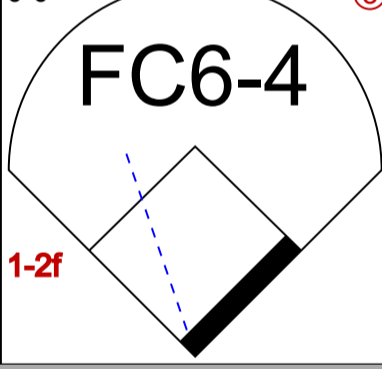
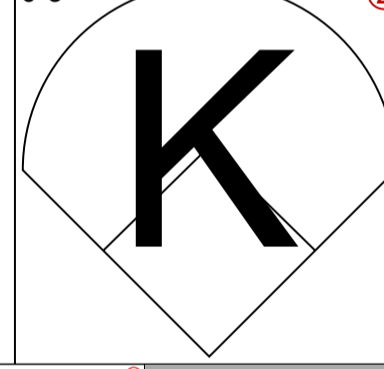
|   |  |   |  |   |  |  |  |   |   |   |               |   |
|---|--|---|--|---|--|--|--|---|---|---|---------------|---|
| <b>Virgil Stallcup, R</b> (1, 6)<br><small>OBP: 0.281, SLG: 0.352</small> |  | 0-0  |  | 0-0  |  |  |  | 0-0  | 0-0  | 0-3  | 5 0 1 0 0 1 6 | <b>Cincinnati Reds @ Pittsburgh Pirates</b><br>Forbes Field, Pittsburgh, PA<br>Tue Aug 15 1950, 3:33 AM EDT<br>Att. 5,495 - Unknown |
|---|--|---|--|---|--|--|--|---|---|---|---------------|---|

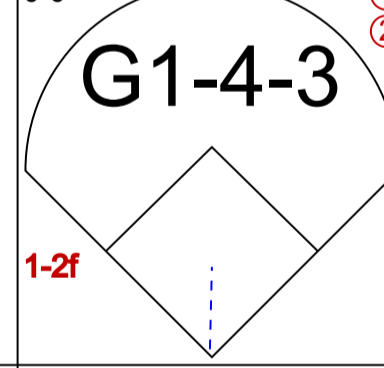
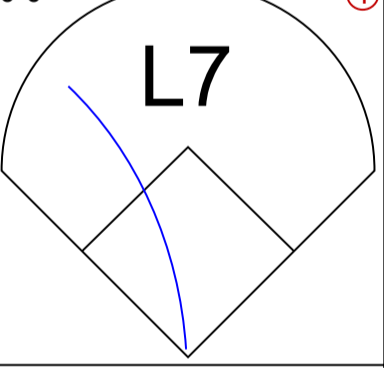
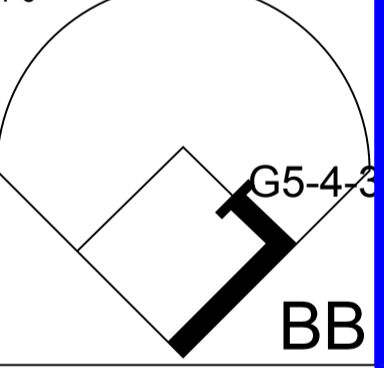
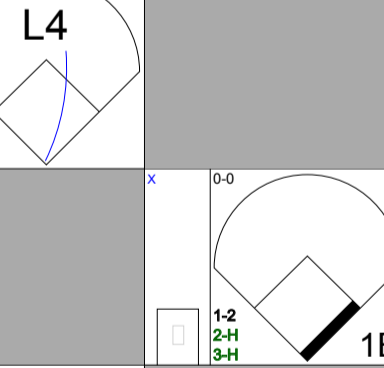
|  |  |   |  |   |  |  |  |   |  |   |   |   |
|--|--|---|--|---|--|--|--|---|--|---|---|---|
| <b>Dixie Howell, R</b> (1, 2)<br><small>OBP: 0.321, SLG: 0.275</small><br><b>Herm Wehmeier, R</b> (7, PR)<br><small>OBP: 0.208, SLG: 0.239</small><br><b>Johnny Pramesa, R</b> (7, 2)<br><small>OBP: 0.368, SLG: 0.464</small> |  | 0-0  |  | 0-0  |  |  |  | 4-0  |  | 0-0  | 2 0 0 0 1 0 1<br>0 0 0 0 0 0 0<br>2 0 1 2 0 0 0 | <b>Cincinnati Reds @ Pittsburgh Pirates</b><br>Forbes Field, Pittsburgh, PA<br>Tue Aug 15 1950, 3:33 AM EDT<br>Att. 5,495 - Unknown |
|--|--|---|--|---|--|--|--|---|--|---|---|---|

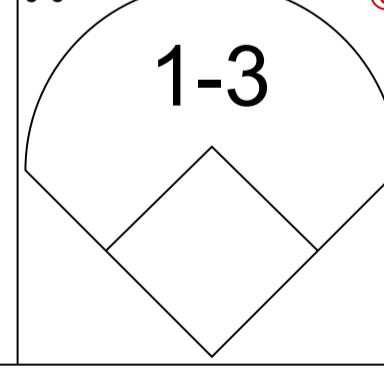
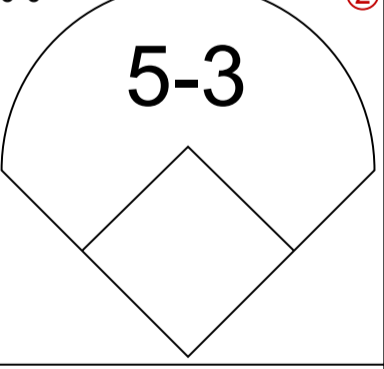
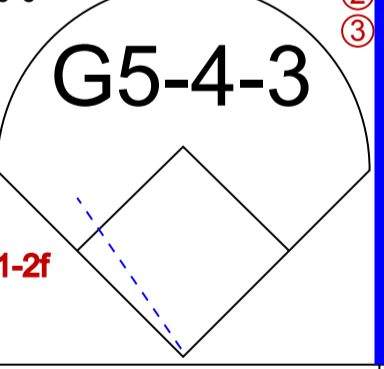
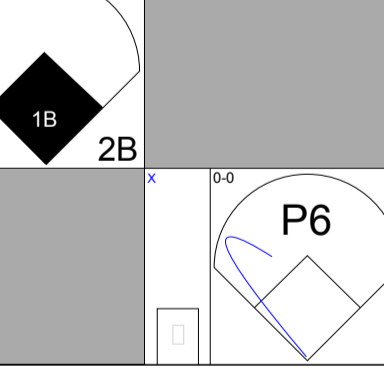
|  |  |   |  |   |  |  |  |   |  |   |   |   |
|--|--|---|--|---|--|--|--|---|--|---|---|---|
| <b>Ewell Blackwell, R</b> (1, 1)<br><small>OBP: 0.143, SLG: 0.085</small><br><b>Danny Litwhiler, R</b> (7, PH)<br><small>OBP: 0.374, SLG: 0.489</small><br><b>Frank Smith, R</b> (7, 1)<br><small>OBP: 0.097, SLG: 0.067</small><br><b>Sammy Meeks, R</b> (9, PH)<br><small>OBP: 0.356, SLG: 0.438</small><br><b>Peanuts Lowrey, R</b> (9, PR)<br><small>OBP: 0.321, SLG: 0.292</small><br><b>Howie Fox, R</b> (9, 1)<br><small>OBP: 0.225, SLG: 0.325</small><br><b>Johnny Hetki, R</b> (9, 1)<br><small>OBP: 0.222, SLG: 0.125</small> |  | 0-0  |  | 0-0  |  |  |  | 0-0  |  | 0-0  | 2 0 0 0 0 0 0<br>1 0 0 0 0 0 1<br>0 0 0 0 0 0 0<br>1 0 1 0 0 0 0<br>1 1 0 0 0 0 2<br>0 0 0 0 0 0 0<br>0 0 0 0 0 0 0 | <b>Cincinnati Reds @ Pittsburgh Pirates</b><br>Forbes Field, Pittsburgh, PA<br>Tue Aug 15 1950, 3:33 AM EDT<br>Att. 5,495 - Unknown |
|--|--|---|--|---|--|--|--|---|--|---|---|---|

| Inning Stats | R: 2<br>E: 1<br>K: 0<br>S: 6 | H: 3<br>LOB: 1<br>BB: 0<br>P: 6 | R: 0<br>E: 0<br>K: 0<br>S: 3 | H: 1<br>LOB: 0<br>BB: 0<br>P: 3 | R: 0<br>E: 0<br>K: 0<br>S: 4 | H: 1<br>LOB: 1<br>BB: 0<br>P: 4 | R: 0<br>E: 0<br>K: 0<br>S: 3 | H: 0<br>LOB: 0<br>BB: 0<br>P: 3 | R: 0<br>E: 0<br>K: 0<br>S: 4 | H: 1<br>LOB: 1<br>BB: 0<br>P: 4 | R: 0<br>E: 0<br>K: 1<br>S: 5 | H: 1<br>LOB: 1<br>BB: 1<br>P: 9 | R: 0<br>E: 0<br>K: 0<br>S: 2 | H: 0<br>LOB: 1<br>BB: 1<br>P: 6 | R: 1<br>E: 0<br>K: 0<br>S: 6 | H: 3<br>LOB: 3<br>BB: 1<br>P: 10 | R: 6<br>E: 1<br>K: 1<br>S: 10 | H: 5<br>LOB: 2<br>BB: 3<br>P: 22 | 1B: 11<br>2B: 3<br>3B: 0<br>HR: 1 | SF: 0<br>SAC: 0<br>DP: 3<br>HBP: 0 | WP: 0<br>PB: 0<br>SB: 0<br>CS: 0 | PA: 45 |
|--------------|------------------------------|---------------------------------|------------------------------|---------------------------------|------------------------------|---------------------------------|------------------------------|---------------------------------|------------------------------|---------------------------------|------------------------------|---------------------------------|------------------------------|---------------------------------|------------------------------|----------------------------------|-------------------------------|----------------------------------|-----------------------------------|------------------------------------|----------------------------------|--------|
|--------------|------------------------------|---------------------------------|------------------------------|---------------------------------|------------------------------|---------------------------------|------------------------------|---------------------------------|------------------------------|---------------------------------|------------------------------|---------------------------------|------------------------------|---------------------------------|------------------------------|----------------------------------|-------------------------------|----------------------------------|-----------------------------------|------------------------------------|----------------------------------|--------|

| PITCHER                                      | IP  | WLS | BF | H  | R | ER | SO | BB | IBB | HBP | BLK | WP | HR | S  | P  | ERA   | WHIP  |
|--|-----|-----|----|----|---|----|----|----|-----|-----|-----|----|----|----|----|-------|-------|
| <b>Bill Werle, L</b> (1, 1)<br>ERA: 4.46     | 8.1 |     | 36 | 11 | 4 | 4  | 1  | 3  | 0   | 0   | 0   | 0  | 1  | 35 | 47 | 4.32  | 1.680 |
| <b>Mel Queen, R</b> (9, 1)<br>ERA: 5.16      | 0.0 |     | 4  | 2  | 2 | 2  | 0  | 2  | 0   | 0   | 0   | 0  | 0  | 2  | 10 | ∞     | ∞     |
| <b>Bill MacDonald, R</b> (9, 1)<br>ERA: 4.73 | 0.2 | W   | 5  | 2  | 3 | 3  | 1  | 0  | 1   | 0   | 0   | 0  | 0  | 6  | 10 | 40.50 | 3.000 |



| Batter | 1 | 2 | 3 | 4 | 5 | 6 | 7 | 8 | 9 | AB | R | H | RBI | BB | SO | LOB | BOTTOM |
|--------|---|---|---|---|---|---|---|---|---|----|---|---|-----|----|----|-----|--------|
|--------|---|---|---|---|---|---|---|---|---|----|---|---|-----|----|----|-----|--------|

|   |                                   |  |  |  |                              |                                     |  |  |                                   |   |   |   |   |   |   |   |  |
|---|-----------------------------------|--|--|--|------------------------------|-------------------------------------|--|--|-----------------------------------|---|---|---|---|---|---|---|--|
| <b>Bob Dillinger, R</b> (1, 5)<br><small>OBP: 0.359, SLG: 0.428</small><br><b>Hank Schenz, R</b> (9, PR)<br><small>OBP: 0.274, SLG: 0.340</small> | 0-3<br><br><small>1-2 2-3</small> | 0-0<br>5-3<br><br><small>1-2 2-3</small> |  |  | 0-0<br><br><small>1B</small> | 0-0<br>4-3<br><br><small>1B</small> |  |  | 0-0<br><br><small>1B E 1B</small> | 5 | 0 | 2 | 0 | 0 | 1 | 4 |  |
|---|-----------------------------------|--|--|--|------------------------------|-------------------------------------|--|--|-----------------------------------|---|---|---|---|---|---|---|--|

|   |                                 |                              |  |  |                                 |  |                                    |  |                                   |   |   |   |   |   |   |   |  |
|---|---------------------------------|------------------------------|--|--|---------------------------------|--|------------------------------------|--|-----------------------------------|---|---|---|---|---|---|---|--|
| <b>Johnny Hopp, L</b> (1, 3)<br><small>OBP: 0.418, SLG: 0.503</small> | 0-0<br><br><small>1B BB</small> | 0-3<br><br><small>1B</small> |  |  | 0-0<br><br><small>1B HR</small> |  | 0-0<br>P4<br><br><small>1B</small> |  | 0-0<br><br><small>1B E 1B</small> | 5 | 3 | 3 | 1 | 0 | 1 | 2 |  |
|---|---------------------------------|------------------------------|--|--|---------------------------------|--|------------------------------------|--|-----------------------------------|---|---|---|---|---|---|---|--|

|   |                              |  |                              |  |                                    |  |                                    |  |                                   |   |   |   |   |   |   |   |  |
|---|------------------------------|--|------------------------------|--|------------------------------------|--|------------------------------------|--|-----------------------------------|---|---|---|---|---|---|---|--|
| <b>Danny O'Connell, R</b> (1, 6)<br><small>OBP: 0.287, SLG: 0.419</small> | 0-3<br><br><small>1B</small> |  | 0-3<br><br><small>1B</small> |  | 0-0<br>F8<br><br><small>1B</small> |  | 0-0<br>F8<br><br><small>1B</small> |  | 0-0<br><br><small>1B E 1B</small> | 5 | 1 | 1 | 0 | 0 | 2 | 2 |  |
|---|------------------------------|--|------------------------------|--|------------------------------------|--|------------------------------------|--|-----------------------------------|---|---|---|---|---|---|---|--|

|   |                                 |  |                                     |  |                                 |  |                              |  |                                    |   |   |   |   |   |   |   |  |
|---|---------------------------------|--|-------------------------------------|--|---------------------------------|--|------------------------------|--|------------------------------------|---|---|---|---|---|---|---|--|
| <b>Ralph Kiner, R</b> (1, 7)<br><small>OBP: 0.418, SLG: 0.613</small> | 4-0<br><br><small>1B BB</small> |  | 0-0<br>5-3<br><br><small>1B</small> |  | 0-0<br><br><small>1B HR</small> |  | 0-0<br><br><small>1B</small> |  | 0-0<br>F2<br><br><small>1B</small> | 4 | 1 | 2 | 2 | 1 | 0 | 3 |  |
|---|---------------------------------|--|-------------------------------------|--|---------------------------------|--|------------------------------|--|------------------------------------|---|---|---|---|---|---|---|--|

|  |                              |  |                                    |  |                                    |  |                                    |  |                                 |   |   |   |   |   |   |   |  |
|--|------------------------------|--|------------------------------------|--|------------------------------------|--|------------------------------------|--|---------------------------------|---|---|---|---|---|---|---|--|
| <b>Gus Bell, L</b> (1, 9)<br><small>OBP: 0.312, SLG: 0.413</small> | 0-0<br><br><small>1B</small> |  | 0-0<br>F7<br><br><small>1B</small> |  | 0-0<br>L7<br><br><small>1B</small> |  | 0-0<br>F8<br><br><small>1B</small> |  | 0-0<br><br><small>1B E4</small> | 5 | 1 | 1 | 2 | 0 | 0 | 3 |  |
|--|------------------------------|--|------------------------------------|--|------------------------------------|--|------------------------------------|--|---------------------------------|---|---|---|---|---|---|---|--|

|  |  |                                 |  |                                    |  |                                    |  |                                     |                              |   |   |   |   |   |   |   |  |
|--|--|---------------------------------|--|------------------------------------|--|------------------------------------|--|-------------------------------------|------------------------------|---|---|---|---|---|---|---|--|
| <b>Wally Westlake, R</b> (1, 8)<br><small>OBP: 0.342, SLG: 0.442</small> |  | 0-0<br><br><small>1B E8</small> |  | 0-0<br>P6<br><br><small>1B</small> |  | 0-0<br>L8<br><br><small>1B</small> |  | 0-0<br>5-3<br><br><small>1B</small> | 0-0<br><br><small>1B</small> | 5 | 2 | 1 | 1 | 0 | 0 | 0 |  |
|--|--|---------------------------------|--|------------------------------------|--|------------------------------------|--|-------------------------------------|------------------------------|---|---|---|---|---|---|---|--|

|  |  |                                 |  |                                    |  |                              |  |                                    |                              |   |   |   |   |   |   |   |  |
|--|--|---------------------------------|--|------------------------------------|--|------------------------------|--|------------------------------------|------------------------------|---|---|---|---|---|---|---|--|
| <b>Danny Murtaugh, R</b> (1, 4)<br><small>OBP: 0.375, SLG: 0.405</small> |  | 4-0<br><br><small>1B BB</small> |  | 0-0<br>P5<br><br><small>1B</small> |  | 0-0<br><br><small>2B</small> |  | 0-0<br>F3<br><br><small>1B</small> | 0-0<br><br><small>1B</small> | 4 | 0 | 2 | 2 | 1 | 0 | 0 |  |
|--|--|---------------------------------|--|------------------------------------|--|------------------------------|--|------------------------------------|------------------------------|---|---|---|---|---|---|---|--|

|  |  |                                  |  |                              |  |                                  |  |                              |                              |   |   |   |   |   |   |   |  |
|--|--|----------------------------------|--|------------------------------|--|----------------------------------|--|------------------------------|------------------------------|---|---|---|---|---|---|---|--|
| <b>Clyde McCullough, R</b> (1, 2)<br><small>OBP: 0.368, SLG: 0.468</small> |  | 0-0<br><br><small>1B 5-3</small> |  | 0-0<br><br><small>2B</small> |  | 0-0<br><br><small>1B 2-3</small> |  | 0-3<br><br><small>1B</small> | 0-0<br><br><small>1B</small> | 5 | 0 | 4 | 2 | 0 | 1 | 0 |  |
|--|--|----------------------------------|--|------------------------------|--|----------------------------------|--|------------------------------|------------------------------|---|---|---|---|---|---|---|--|

|  |  |                              |  |                                    |  |                              |  |                                 |                              |   |   |   |   |   |   |   |  |
|--|--|------------------------------|--|------------------------------------|--|------------------------------|--|---------------------------------|------------------------------|---|---|---|---|---|---|---|--|
| <b>Bill Werle, L</b> (1, 1)<br><small>OBP: 0.280, SLG: 0.283</small><br><b>Mel Queen, R</b> (9, 1)<br><small>OBP: 0.097, SLG: 0.067</small><br><b>Bill MacDonald, R</b> (9, 1)<br><small>OBP: 0.206, SLG: 0.129</small><br><b>Johnny Berardino, R</b> (9, PH)<br><small>OBP: 0.545, SLG: 0.375</small> |  | 0-3<br><br><small>1B</small> |  | 0-0<br>F9<br><br><small>1B</small> |  | 0-3<br><br><small>1B</small> |  | 4-0<br><br><small>1B BB</small> | 0-0<br><br><small>1B</small> | 3 | 0 | 0 | 0 | 0 | 2 | 5 |  |
|--|--|------------------------------|--|------------------------------------|--|------------------------------|--|---------------------------------|------------------------------|---|---|---|---|---|---|---|--|

| Inning Stats | R: 1<br>E: 0<br>K: 2<br>S: 8 | H: 2<br>LOB: 2<br>BB: 1<br>P: 12 | R: 1<br>E: 1<br>K: 2<br>S: 9 | H: 1<br>LOB: 2<br>BB: 1<br>P: 13 | R: 0<br>E: 0<br>K: 1<br>S: 5 | H: 0<br>LOB: 0<br>BB: 0<br>P: 5 | R: 0<br>E: 0<br>K: 0<br>S: 4 | H: 1<br>LOB: 1<br>BB: 0<br>P: 4 | R: 2<br>E: 0<br>K: 0<br>S: 5 | H: 3<br>LOB: 0<br>BB: 0<br>P: 5 | R: 0<br>E: 0<br>K: 1<br>S: 7 | H: 2<br>LOB: 2<br>BB: 0<br>P: 7 | R: 0<br>E: 0<br>K: 0<br>S: 4 | H: 1<br>LOB: 1<br>BB: 0<br>P: 4 | R: 0<br>E: 0<br>K: 1<br>S: 5 | H: 0<br>LOB: 0<br>BB: 0<br>P: 5 | R: 6<br>E: 1<br>K: 0<br>S: 8 | H: 6<br>LOB: 2<br>BB: 1<br>P: 12 | 1B: 13<br>2B: 2<br>3B: 0<br>HR: 1 | SF: 0<br>SAC: 0<br>DP: 0<br>HBP: 0 | WP: 0<br>PB: 0<br>SB: 0<br>CS: 0 | PA: 44 |
|--------------|------------------------------|----------------------------------|------------------------------|----------------------------------|------------------------------|---------------------------------|------------------------------|---------------------------------|------------------------------|---------------------------------|------------------------------|---------------------------------|------------------------------|---------------------------------|------------------------------|---------------------------------|------------------------------|----------------------------------|-----------------------------------|------------------------------------|----------------------------------|--------|
|--------------|------------------------------|----------------------------------|------------------------------|----------------------------------|------------------------------|---------------------------------|------------------------------|---------------------------------|------------------------------|---------------------------------|------------------------------|---------------------------------|------------------------------|---------------------------------|------------------------------|---------------------------------|------------------------------|----------------------------------|-----------------------------------|------------------------------------|----------------------------------|--------|

| PITCHER                                       | IP  | WLS | BF | H | R | ER | SO | BB | IBB | HBP | BLK | WP | HR | S  | P  | ERA   | WHIP  |
|---|-----|-----|----|---|---|----|----|----|-----|-----|-----|----|----|----|----|-------|-------|
| <b>Ewell Blackwell, R</b> (1, 1)<br>ERA: 3.78 | 6.0 |     | 28 | 9 | 4 | 3  | 6  | 2  | 0   | 0   | 0   | 0  | 1  | 38 | 46 | 4.50  | 1.833 |
| <b>Frank Smith, R</b> (7, 1)<br>ERA: 3.28     | 2.0 |     | 7  | 1 | 0 | 0  | 1  | 0  | 0   | 0   | 0   | 0  | 0  | 9  | 9  | 0.00  | 0.500 |
| <b>Howie Fox, R</b> (9, 1)<br>ERA: 5.25       | 0.0 |     | 4  | 3 | 4 | 4  | 0  | 1  | 0   | 0   | 0   | 0  | 0  | 3  | 7  | ∞     | ∞     |
| <b>Johnny Hetki, R</b> (9, 1)<br>ERA: 5.27    | 0.1 | L   | 5  | 3 | 2 | 1  | 0  | 0  | 0   | 0   | 0   | 0  | 0  | 5  | 5  | 27.00 | 9.000 |

**Cincinnati Reds @ Pittsburgh Pirates**  
 Forbes Field, Pittsburgh, PA  
 Tue Aug 15 1950, 3:33 AM EDT  
 Att. 5,495 - Unknown

|            |    |
|------------|----|
| <b>AB</b>  | 41 |
| <b>R</b>   | 10 |
| <b>H</b>   | 16 |
| <b>RBI</b> | 10 |
| <b>BB</b>  | 3  |
| <b>SO</b>  | 7  |
| <b>LOB</b> | 19 |



|       |        |
|-------|--------|
| WP: 0 | PA: 44 |
| PB: 0 | ERA    |
| SB: 0 | WHIP   |
| CS: 0 |        |

| Batter   | 1                            | 2                                | 3                            | 4                               | 5                            | 6                               | 7                            | 8                               | 9                                | 10                              | 11                           | 12                              | AB                           | R                               | H                            | RBI                             | BB                           | SO                              | LOB                          | TOP                             |                              |                                 |                                   |                                    |                                  |        |
|--|------------------------------|----------------------------------|------------------------------|---------------------------------|------------------------------|---------------------------------|------------------------------|---------------------------------|----------------------------------|---------------------------------|------------------------------|---------------------------------|------------------------------|---------------------------------|------------------------------|---------------------------------|------------------------------|---------------------------------|------------------------------|---------------------------------|------------------------------|---------------------------------|-----------------------------------|------------------------------------|----------------------------------|--------|
| Lloyd Merriman, L<br>OBP: 0.333, SLG: 0.357<br>(1, 8)  | 0-0<br>P6                    | 0-0<br>4-3                       |                              |                                 | 0-0<br>1B G3<br>1B           |                                 | 0-0<br>F9                    |                                 | 0-0<br>G2                        |                                 | 4-0<br>1B<br>BB              |                                 | 5                            | 0                               | 1                            | 0                               | 1                            | 0                               | 0                            |                                 |                              |                                 |                                   |                                    |                                  |        |
| Grady Hatton, L<br>OBP: 0.358, SLG: 0.407<br>(1, 5)  | 4-0<br>HR<br>BB              |                                  | 0-0<br>4-3                   |                                 | 0-0<br>G3                    |                                 | 0-0<br>4-3                   |                                 | 0-0<br>G3                        |                                 | 0-0<br>1B<br>1B              |                                 | 5                            | 1                               | 1                            | 0                               | 1                            | 0                               | 1                            |                                 |                              |                                 |                                   |                                    |                                  |        |
| Johnny Wyrostek, L<br>OBP: 0.404, SLG: 0.471<br>(1, 9)   | 0-0<br>1-H<br>HR             |                                  | 4-0<br>FC4-6<br>BB           |                                 | 0-0<br>1B<br>2-3             |                                 | 0-3<br>K                     |                                 | 0-0<br>L8                        |                                 | 0-0<br>P1                    |                                 | 5                            | 1                               | 2                            | 2                               | 1                            | 1                               | 2                            |                                 |                              |                                 |                                   |                                    |                                  |        |
| Ted Kluszewski, L<br>OBP: 0.354, SLG: 0.564<br>(1, 3)  | 0-0<br>4-3                   |                                  | 0-0<br>FC4-6<br>BLK          |                                 | 0-0<br>4-3                   |                                 |                              |                                 | 0-0<br>F9                        |                                 | 0-0<br>SH1<br>1B             |                                 | 6                            | 0                               | 1                            | 0                               | 0                            | 0                               | 5                            |                                 |                              |                                 |                                   |                                    |                                  |        |
| Joe Adcock, R<br>OBP: 0.310, SLG: 0.387<br>(1, 7)  | 0-0<br>1B<br>1B              |                                  | 0-0<br>F7                    |                                 |                              |                                 |                              |                                 | 0-0<br>SH3-4<br>FC5-2<br>1B      |                                 | 0-0<br>SH1<br>1B             |                                 | 5                            | 1                               | 3                            | 0                               | 0                            | 0                               | 1                            |                                 |                              |                                 |                                   |                                    |                                  |        |
| Johnny Pramesa, R<br>OBP: 0.379, SLG: 0.473<br>Peanuts Lowrey, R<br>OBP: 0.321, SLG: 0.292<br>Dixie Howell, R<br>OBP: 0.317, SLG: 0.272<br>(1, 2)<br>(8, PR)<br>(8, 2) | 0-0<br>1-2<br>1B             |                                  | 0-0<br>4-3                   |                                 |                              |                                 |                              |                                 | 0-0<br>SH3-4<br>1-2<br>1B        |                                 | 0-0<br>2B<br>FC1-2<br>1B     |                                 | 4                            | 0                               | 3                            | 0                               | 0                            | 0                               | 0                            |                                 |                              |                                 |                                   |                                    |                                  |        |
| Connie Ryan, R<br>OBP: 0.378, SLG: 0.383<br>(1, 4)   | 0-3<br>K                     |                                  | 0-0<br>L4-3<br>1B            |                                 |                              |                                 |                              |                                 | 0-0<br>SH3-4<br>1-2<br>2-3<br>1B |                                 | 4-0<br>BB                    |                                 | 4                            | 0                               | 2                            | 1                               | 1                            | 1                               | 2                            |                                 |                              |                                 |                                   |                                    |                                  |        |
| Sammy Meeks, R<br>OBP: 0.333, SLG: 0.406<br>(1, 6)   |                              | 0-0<br>F6                        |                              | 0-0<br>L4-3                     |                              |                                 |                              |                                 | 0-0<br>FC5-2                     |                                 | 0-0<br>FC1-2                 |                                 | 5                            | 0                               | 0                            | 0                               | 0                            | 0                               | 8                            |                                 |                              |                                 |                                   |                                    |                                  |        |
| Herm Wehmeier, R<br>OBP: 0.195, SLG: 0.224<br>(1, 1)   |                              | 0-0<br>F4                        |                              |                                 | 0-0<br>6-3                   |                                 |                              |                                 | 0-0<br>3-H<br>5-3                |                                 | 0-0<br>3-H<br>1-3            |                                 | 5                            | 0                               | 0                            | 0                               | 0                            | 0                               | 4                            |                                 |                              |                                 |                                   |                                    |                                  |        |
|  |                              |                                  |                              |                                 |                              |                                 |                              |                                 |                                  |                                 |                              |                                 |                              |                                 |                              |                                 |                              |                                 |                              |                                 |                              |                                 |                                   |                                    |                                  |        |
| <b>Inning Stats</b>  | R: 2<br>E: 0<br>K: 1<br>S: 8 | H: 3<br>LOB: 2<br>BB: 1<br>P: 12 | R: 0<br>E: 0<br>K: 0<br>S: 3 | H: 0<br>LOB: 0<br>BB: 0<br>P: 3 | R: 0<br>E: 0<br>K: 0<br>S: 3 | H: 0<br>LOB: 1<br>BB: 1<br>P: 7 | R: 0<br>E: 0<br>K: 0<br>S: 5 | H: 1<br>LOB: 0<br>BB: 0<br>P: 3 | R: 0<br>E: 0<br>K: 0<br>S: 5     | H: 2<br>LOB: 2<br>BB: 0<br>P: 5 | R: 0<br>E: 0<br>K: 1<br>S: 5 | H: 0<br>LOB: 0<br>BB: 0<br>P: 5 | R: 1<br>E: 0<br>K: 0<br>S: 6 | H: 3<br>LOB: 2<br>BB: 0<br>P: 6 | R: 0<br>E: 0<br>K: 0<br>S: 3 | H: 0<br>LOB: 0<br>BB: 0<br>P: 3 | R: 0<br>E: 0<br>K: 0<br>S: 4 | H: 1<br>LOB: 2<br>BB: 1<br>P: 8 | R: 0<br>E: 0<br>K: 0<br>S: 4 | H: 1<br>LOB: 2<br>BB: 1<br>P: 8 | R: 0<br>E: 0<br>K: 0<br>S: 3 | H: 0<br>LOB: 0<br>BB: 0<br>P: 3 | 1B: 11<br>2B: 2<br>3B: 0<br>HR: 1 | SF: 0<br>SAC: 2<br>DP: 1<br>HBP: 0 | WP: 0<br>PB: 0<br>SB: 0<br>CS: 0 | PA: 52 |
| <b>PITCHER</b><br>Frank Hiller, R<br>ERA: 3.71<br>(1, 1)   | IP<br>12.0                   | WLS<br>W                         | BF<br>52                     | H<br>13                         | R<br>3                       | ER<br>3                         | SO<br>2                      | BB<br>4                         | IBB<br>0                         | HBP<br>0                        | BLK<br>1                     | WP<br>0                         | HR<br>1                      | S<br>52                         | P<br>68                      | ERA<br>2.25                     | WHIP<br>1.417                |                                 |                              |                                 |                              |                                 |                                   |                                    |                                  |        |

Cincinnati Reds @ Chicago Cubs  
Wrigley Field, Chicago, IL  
Wed Aug 16 1950, 3:33 AM CDT  
Att: 9,562 - Unknown

livebaseballscorecards.com

|     |    |
|-----|----|
| AB  | 46 |
| R   | 3  |
| H   | 13 |
| RBI | 3  |
| BB  | 4  |
| SO  | 2  |
| LOB | 24 |



| Batter   | 1                   | 2          | 3                       | 4                    | 5                        | 6                       | 7          | 8          | 9          | 10       | 11 | 12                      | AB R H RBI BB SO LOB                            |
|--|---------------------|------------|-------------------------|----------------------|--------------------------|-------------------------|------------|------------|------------|----------|----|-------------------------|---|
| Wayne Terwilliger, R<br>OBP: 0.305, SLG: 0.350<br>Hank Sauer, R<br>OBP: 0.347, SLG: 0.473<br>Bob Ramazzotti, R<br>OBP: 0.276, SLG: 0.336 | 4-0<br>BB<br>BB     |            | 0-0<br>1B<br>1-2<br>1B  | 0-0<br>F9            |                          | 0-0<br>F8               |            |            | 0-3<br>K   |          |    | 0-0<br>1B<br>3B         | 3 0 1 0 1 0 2<br>1 0 0 0 0 1 0<br>1 1 1 0 0 0 0 |
| Bob Borkowski, R<br>OBP: 0.341, SLG: 0.438   | 0-0<br>F8           |            | 0-0<br>1B<br>1-3<br>2-H |                      | 0-0<br>SH2-3<br>BB<br>1B | 0-0<br>1B               |            |            | 0-3<br>K   |          |    | 0-0<br>6-3              | 6 1 3 1 0 1 2                                   |
| Preston Ward, L<br>OBP: 0.341, SLG: 0.435  | 4-0<br>G6-4-3<br>BB |            | 0-3<br>K                |                      | 0-0<br>SH2-3<br>1-2      |                         | 0-0<br>4-3 |            | 0-0<br>F4  |          |    | 4-0<br>1B<br>BB         | 3 0 0 0 2 1 2                                   |
| Hal Jeffcoat, R<br>OBP: 0.248, SLG: 0.316<br>Ron Northey, L<br>OBP: 0.364, SLG: 0.494  | 0-0<br>G6-4-3       |            | 0-3<br>K                |                      | 0-0<br>F8                |                         | 0-0<br>1B  |            | 0-0<br>1-3 |          |    | 0-0<br>1-2<br>3-H<br>1B | 5 0 1 0 0 1 5<br>1 0 1 1 0 0 0                  |
| Andy Pafko, R<br>OBP: 0.415, SLG: 0.634  |                     | 0-0<br>4-3 |                         | 0-0<br>HR            | 4-0<br>BB<br>BB<br>IBB   |                         | 0-0<br>P6  |            | 0-0<br>F9  |          |    |                         | 4 1 1 1 1 0 1                                   |
| Bill Serena, R<br>OBP: 0.335, SLG: 0.407   |                     | 0-0<br>F8  |                         | 0-0<br>1B<br>S<br>1B | 4-0<br>BB<br>BB<br>BB    | 1-2<br>2-3<br>BB        | 0-0<br>P4  |            | 0-3<br>K   |          |    |                         | 4 0 1 0 1 1 1                                   |
| Roy Smalley, R<br>OBP: 0.311, SLG: 0.439   |                     | 0-3<br>K   |                         | 0-0<br>F4<br>1-2     | 4-0<br>BB<br>BB<br>BB    | 1-2<br>2-3<br>3-H<br>BB | 0-0<br>6-3 |            | 0-3<br>K   |          |    |                         | 4 0 0 1 1 2 1                                   |
| Mickey Owen, R<br>OBP: 0.265, SLG: 0.288   |                     |            | 0-0<br>1B<br>1B         | 0-0<br>1B<br>2-3     | 0-0<br>L4                |                         | 0-0<br>L9  |            | 0-0<br>F4  |          |    |                         | 5 1 2 0 0 0 3                                   |
| Frank Hiller, R<br>OBP: 0.174, SLG: 0.136  |                     |            | 0-0<br>F3               | 0-0<br>F4            |                          | 0-0<br>F8               |            | 0-0<br>6-3 |            | 0-3<br>K |    |                         | 5 0 0 0 0 1 3                                   |

| Inning Stats | R: 0  | H: 0  | E: 0  | K: 0  | S: 2   | LOB: 1 | BB: 2 | P: 10  |
|--------------|-------|-------|-------|-------|--|--------|-------|--------|
|              | R: 0  | H: 0  | E: 0  | K: 1  | S: 5 <td>LOB: 0</td> <td>BB: 0</td> <td>P: 5 </td>   | LOB: 0 | BB: 0 | P: 5   |
|              | R: 1  | H: 3  | E: 0  | K: 2  | S: 10 <td>LOB: 2</td> <td>BB: 0</td> <td>P: 10 </td> | LOB: 2 | BB: 0 | P: 10  |
|              | R: 1  | H: 3  | E: 0  | K: 0  | S: 6 <td>LOB: 2</td> <td>BB: 0</td> <td>P: 6 </td>   | LOB: 2 | BB: 0 | P: 6   |
|              | R: 1  | H: 1  | E: 0  | K: 0  | S: 4 <td>LOB: 3</td> <td>BB: 3</td> <td>P: 16 </td>  | LOB: 3 | BB: 3 | P: 16  |
|              | R: 0  | H: 1  | E: 0  | K: 0  | S: 3 <td>LOB: 1</td> <td>BB: 0</td> <td>P: 3 </td>   | LOB: 1 | BB: 0 | P: 3   |
|              | R: 0  | H: 1  | E: 0  | K: 0  | S: 4 <td>LOB: 1</td> <td>BB: 0</td> <td>P: 4 </td>   | LOB: 1 | BB: 0 | P: 4   |
|              | R: 0  | H: 0  | E: 0  | K: 0  | S: 3 <td>LOB: 0</td> <td>BB: 0</td> <td>P: 3 </td>   | LOB: 0 | BB: 0 | P: 3   |
|              | R: 0  | H: 0  | E: 0  | K: 2  | S: 7 <td>LOB: 0</td> <td>BB: 0</td> <td>P: 7 </td>   | LOB: 0 | BB: 0 | P: 7   |
|              | R: 0  | H: 0  | E: 0  | K: 1  | S: 5 <td>LOB: 0</td> <td>BB: 0</td> <td>P: 5 </td>   | LOB: 0 | BB: 0 | P: 5   |
|              | R: 0  | H: 0  | E: 0  | K: 2  | S: 7 <td>LOB: 0</td> <td>BB: 0</td> <td>P: 7 </td>   | LOB: 0 | BB: 0 | P: 7   |
|              | R: 0  | H: 0  | E: 0  | K: 1  | S: 5 <td>LOB: 0</td> <td>BB: 0</td> <td>P: 5 </td>   | LOB: 0 | BB: 0 | P: 5   |
|              | R: 1  | H: 2  | E: 0  | K: 0  | S: 3 <td>LOB: 2</td> <td>BB: 1</td> <td>P: 7 </td>   | LOB: 2 | BB: 1 | P: 7   |
|              | 1B: 9 | 2B: 0 | 3B: 1 | HR: 1 | SF: 0  | SAC: 1 | DP: 1 | HBP: 0 |

| PITCHER                       | IP   | WLS | BF | H  | R | ER | SO | BB | IBB | HBP | BLK | WP | HR | S  | P  | ERA  | WHIP  |
|-------------------------------|------|-----|----|----|---|----|----|----|-----|-----|-----|----|----|----|----|------|-------|
| Herm Wehmeier, R<br>ERA: 5.52 | 11.1 | L   | 49 | 11 | 4 | 4  | 8  | 5  | 1   | 0   | 0   | 0  | 1  | 59 | 83 | 3.18 | 1.412 |

**BOTTOM**

**Cincinnati Reds @ Chicago Cubs**  
 Wrigley Field, Chicago, IL  
 Wed Aug 16 1950, 3:33 AM CDT  
 Att. 9,562 - Unknown

|     |    |
|-----|----|
| AB  | 42 |
| R   | 4  |
| H   | 11 |
| RBI | 4  |
| BB  | 6  |
| SO  | 8  |
| LOB | 20 |



|       |        |
|-------|--------|
| WP: 0 | PA: 49 |
| PB: 0 |        |
| SB: 1 |        |
| CS: 0 |        |

| Batter  | 1   | 2   | 3   | 4   | 5   | 6   | 7   | 8   | 9   | AB R H RBI BB SO LOB                                       | TOP                                     |  |
|---|---|---|---|---|---|---|---|---|---|--|---|--|
| Lloyd Merriman, L (1, 8)<br>OBP: 0.332, SLG: 0.352    | 4-0<br>BB<br>L6-3-4                                   |   | 0-0<br>4-3  |   | 0-0<br>4-3  |   |   | 0-0<br>F7   |   | 3 0 0 0 1 0 0  |   |  |
| Grady Hatton, L (1, 5)<br>OBP: 0.357, SLG: 0.405      | 0-0<br>L6-3-4<br>1-2                                  |   | 0-0<br>4-3  |   |   | 0-0<br>4-3<br>4-6-3<br>1B                           |   | 0-0<br>F8   |   | 4 0 1 0 0 0 1  |   |  |
| Johnny Wyrostek, L (1, 9)<br>OBP: 0.402, SLG: 0.472   | 0-0<br>2B   |   | 0-0<br>F8   |   |   | 0-0<br>4-6-3<br>1-2                                 |   |   | 0-0<br>4-3  | 4 0 1 0 0 0 1  |   |  |
| Ted Kluszewski, L (1, 3)<br>OBP: 0.359, SLG: 0.571    | 4-0<br>IBB  |   |   | 0-0<br>1B<br>2B                                     |   | 0-0<br>4-3<br>2-3                                   |   |   | 0-0<br>2B   | 3 1 2 0 1 0 1  |   |  |
| Joe Adcock, R (1, 7)<br>OBP: 0.309, SLG: 0.381        | 0-0<br>5-3  |   |   | 0-0<br>F9   |   | 0-0<br>6-3  |   |   | 4-0<br>4-3<br>BB                                    | 3 0 0 0 1 0 4  |   |  |
| Johnny Pramesa, R (1, 2)<br>OBP: 0.378, SLG: 0.470    |   | 0-0<br>F9   |   | 0-0<br>F7   |   |   | 0-0<br>CS<br>1B                                     |   | 0-0<br>4-3<br>1-2                                   | 3 0 1 0 0 0 1  |   |  |
| Bobby Adams, R (7, PR)<br>OBP: 0.353, SLG: 0.394      |   |   |   |   |   |   |   |   |   | 0 0 0 0 0 0 0  |   |  |
| Dixie Howell, R (7, 2)<br>OBP: 0.316, SLG: 0.270      |   |   |   |   |   |   |   |   |   | 1 0 0 0 0 0 2  |   |  |
| Connie Ryan, R (1, 4)<br>OBP: 0.380, SLG: 0.395       |   | 0-0<br>HR   |   | 0-0<br>2-H<br>1B                                    |   |   | 0-0<br>6-3<br>1-2                                   |   |   | 3 1 2 2 0 0 1  |   |  |
| Sammy Meeks, R (1, 6)<br>OBP: 0.320, SLG: 0.389       |   | 0-0<br>F9   |   |   | 0-0<br>B1   |   | 0-3<br>K  |   |   | 3 0 0 0 0 1 1  |   |  |
| Ken Raffensberger, R (1, 1)<br>OBP: 0.200, SLG: 0.180 |   | 0-0<br>6-3  |   |   | 0-3<br>K  |   |   | 0-0<br>5-3  |   | 3 0 0 0 0 1 0  |   |  |
| <b>Inning Stats</b>                                   | R: 0 H: 1<br>E: 0 LOB: 2<br>K: 0 BB: 2<br>S: 3 P: 11  | R: 1 H: 1<br>E: 0 LOB: 0<br>K: 0 BB: 0<br>S: 4 P: 4 | R: 0 H: 0<br>E: 0 LOB: 0<br>K: 0 BB: 0<br>S: 3 P: 3 | R: 1 H: 2<br>E: 0 LOB: 1<br>K: 0 BB: 0<br>S: 4 P: 4 | R: 0 H: 0<br>E: 0 LOB: 0<br>K: 1 BB: 0<br>S: 5 P: 5 | R: 0 H: 1<br>E: 0 LOB: 1<br>K: 0 BB: 0<br>S: 4 P: 4 | R: 0 H: 1<br>E: 0 LOB: 1<br>K: 1 BB: 0<br>S: 5 P: 5 | R: 0 H: 0<br>E: 0 LOB: 0<br>K: 0 BB: 0<br>S: 3 P: 3 | R: 0 H: 1<br>E: 0 LOB: 1<br>K: 0 BB: 1<br>S: 3 P: 7 | 1B: 3 SF: 0<br>2B: 5 SAC: 0<br>3B: 0 DP: 2<br>HR: 1 HBP: 0 | WP: 0 PA: 33<br>PB: 0<br>SB: 0<br>CS: 1 |  |
| <b>PITCHER</b><br>Bob Rush, R (1, 1)<br>ERA: 3.95     | IP WLS BF H R ER SO BB IBB HBP BLK WP HR S P ERA WHIP | 9.0 L 33 7 2 2 2 2 2 1 0 0 0 1 34 46 2.00 1.000     |   |   |   |   |   |   |   |  |   |  |

Cincinnati Reds @ Chicago Cubs  
Wrigley Field, Chicago, IL  
Thu Aug 17 1950, 3:33 AM CDT  
Att. 8,904 - Unknown

livebaseballscorecards.com

AB 30  
R 2  
H 7  
RBI 2  
BB 3  
SO 2  
LOB 12





| Batter   | 1       | 2       | 3       | 4 | 5       | 6       | 7       | 8       | 9       | AB      | R | H | RBI | BB | SO | LOB |
|--|---------|---------|---------|---|---------|---------|---------|---------|---------|---------|---|---|-----|----|----|-----|
| Wayne Terwilliger, R<br><small>(1, 4)<br/>OBP: 0.310, SLG: 0.355</small> | 0-0<br> |         | 0-0<br> |   |         | 0-0<br> |         | 0-0<br> |         | 4       | 0 | 3 | 0   | 0  | 0  | 0   |
| Bob Borkowski, R<br><small>(1, 9)<br/>OBP: 0.339, SLG: 0.435</small>     | 0-0<br> |         | 0-0<br> |   |         | 0-0<br> |         | 0-0<br> |         | 4       | 0 | 1 | 0   | 0  | 0  | 3   |
| Preston Ward, L<br><small>(1, 3)<br/>OBP: 0.333, SLG: 0.424</small>      | 0-0<br> |         |         |   | 0-0<br> |         | 0-3<br> |         | 0-0<br> |         | 4 | 0 | 0   | 0  | 0  | 1   |
| Hal Jeffcoat, R<br><small>(1, 7)<br/>OBP: 0.238, SLG: 0.304</small>      |         | 0-0<br> |         |   | 0-0<br> |         | 0-0<br> |         |         | 0-0<br> |   | 4 | 0   | 0  | 0  | 0   |
| Andy Pafko, R<br><small>(1, 8)<br/>OBP: 0.411, SLG: 0.627</small>        |         | 0-0<br> |         |   | 0-0<br> |         |         | 0-0<br> |         | 0-0<br> |   | 4 | 0   | 0  | 0  | 0   |
| Bill Serena, R<br><small>(1, 5)<br/>OBP: 0.332, SLG: 0.402</small>       |         | 0-0<br> |         |   |         | 0-0<br> |         | 0-0<br> |         | 0-0<br> |   | 4 | 0   | 0  | 0  | 0   |
| Roy Smalley, R<br><small>(1, 6)<br/>OBP: 0.309, SLG: 0.435</small>       |         |         | 0-0<br> |   |         | 0-0<br> |         | 0-0<br> |         |         |   | 3 | 0   | 0  | 0  | 0   |
| Mickey Owen, R<br><small>(1, 2)<br/>OBP: 0.266, SLG: 0.288</small>       |         |         | 0-0<br> |   |         | 0-0<br> |         | 0-0<br> |         |         |   | 3 | 0   | 1  | 0  | 0   |
| Bob Rush, R<br><small>(1, 1)<br/>OBP: 0.217, SLG: 0.279</small>          |         |         | 0-0<br> |   | 0-3<br> |         |         |         | 0-0<br> |         |   | 3 | 1   | 1  | 0  | 0   |

|   |                              |                                 |                              |                                 |                              |                                 |                              |                                 |                              |                                 |                              |                                 |                              |                                 |                              |                                 |                              |                                 |                                  |                                    |                                  |        |
|---|------------------------------|---------------------------------|------------------------------|---------------------------------|------------------------------|---------------------------------|------------------------------|---------------------------------|------------------------------|---------------------------------|------------------------------|---------------------------------|------------------------------|---------------------------------|------------------------------|---------------------------------|------------------------------|---------------------------------|----------------------------------|------------------------------------|----------------------------------|--------|
| <b>Inning Stats</b>   | R: 0<br>E: 0<br>K: 0<br>S: 3 | H: 1<br>LOB: 0<br>BB: 0<br>P: 3 | R: 0<br>E: 0<br>K: 0<br>S: 3 | H: 0<br>LOB: 0<br>BB: 0<br>P: 3 | R: 1<br>E: 1<br>K: 0<br>S: 5 | H: 2<br>LOB: 1<br>BB: 0<br>P: 5 | R: 0<br>E: 0<br>K: 0<br>S: 3 | H: 0<br>LOB: 0<br>BB: 0<br>P: 3 | R: 0<br>E: 0<br>K: 1<br>S: 6 | H: 1<br>LOB: 1<br>BB: 0<br>P: 6 | R: 0<br>E: 0<br>K: 1<br>S: 6 | H: 1<br>LOB: 1<br>BB: 0<br>P: 6 | R: 0<br>E: 1<br>K: 0<br>S: 4 | H: 0<br>LOB: 1<br>BB: 0<br>P: 4 | R: 0<br>E: 0<br>K: 0<br>S: 4 | H: 1<br>LOB: 1<br>BB: 0<br>P: 4 | R: 0<br>E: 0<br>K: 0<br>S: 3 | H: 0<br>LOB: 0<br>BB: 0<br>P: 3 | 1B: 5<br>2B: 1<br>3B: 0<br>HR: 0 | SF: 0<br>SAC: 0<br>DP: 0<br>HBP: 0 | WP: 0<br>PB: 0<br>SB: 1<br>CS: 1 | PA: 33 |
| <b>PITCHER</b><br>Ken Raffensberger, L<br><small>(1, 1)<br/>ERA: 3.89</small> | IP: 9.0                      | WLS: W                          | BF: 33                       | H: 6                            | R: 1                         | ER: 1                           | SO: 2                        | BB: 0                           | IBB: 0                       | HBP: 0                          | BLK: 0                       | WP: 0                           | HR: 0                        | S: 37                           | P: 37                        | ERA: 1.00                       | WHIP: 0.667                  |                                 |                                  |                                    |                                  |        |
| <b>PITCHER</b>  | IP                           | WLS                             | BF                           | H                               | R                            | ER                              | SO                           | BB                              | IBB                          | HBP                             | BLK                          | WP                              | HR                           | S                               | P                            | ERA                             | WHIP                         |                                 |                                  |                                    |                                  |        |

**BOTTOM**

**Cincinnati Reds @ Chicago Cubs**  
**Wrigley Field, Chicago, IL**  
 Thu Aug 17 1950, 3:33 AM CDT  
 Att. 8,904 - Unknown

[livebaseballscorecards.com](http://livebaseballscorecards.com)

|            |           |
|------------|-----------|
| <b>AB</b>  | <b>33</b> |
| <b>R</b>   | <b>1</b>  |
| <b>H</b>   | <b>6</b>  |
| <b>RBI</b> | <b>0</b>  |
| <b>BB</b>  | <b>0</b>  |
| <b>SO</b>  | <b>2</b>  |
| <b>LOB</b> | <b>8</b>  |



| Batter   | 1  | 2   | 3   | 4   | 5   | 6   | 7   | 8   | 9   | AB R H RBI BB SO LOB   | TOP  |
|--|--|---|---|---|---|---|---|---|---|--|--|
| <b>Peanuts Lowrey, R</b> (1, 7)<br>OBP: 0.324, SLG: 0.296  | 4-0<br>BB  | 0-0<br>F3   |   |   | 0-0<br>4-3  |   |   | 0-0<br>1B   |   | 0 0 0 0 0 0 0  |  |
| <b>Grady Hatton, L</b> (1, 5)<br>OBP: 0.358, SLG: 0.404    | 0-3<br>K   |   | 0-0<br>G3   |   | 0-0<br>P4   |   |   | 0-0<br>SH3-4  |   | 3 0 0 0 0 1 1  |  |
| <b>Danny Litwhiler, R</b> (1, 9)<br>OBP: 0.374, SLG: 0.474 | 0-0<br>1B  |   | 4-0<br>CS<br>BB   |   |   | 0-0<br>6-3  |   | 0-0<br>F8   |   | 3 0 1 0 1 0 1  |  |
| <b>Bob Usher, R</b> (1, 8)<br>OBP: 0.326, SLG: 0.385       | 0-3<br>K   |   | 0-3<br>K  |   | 4-0<br>FC1-6-4<br>BB  |   |   | 4-0<br>BB   |   | 2 0 0 0 2 2 3  |  |
| <b>Joe Adcock, R</b> (1, 3)<br>OBP: 0.310, SLG: 0.394      |  | 0-0<br>2B<br>F9<br>1B   |   | 0-0<br>HR   |   | 0-0<br>FC1-6-4  |   | 0-0<br>F9   |   | 4 2 2 1 0 0 3  |  |
| <b>Johnny Pramesa, R</b> (1, 2)<br>OBP: 0.371, SLG: 0.464  |  | 0-0<br>1-3<br>2B  |   | 0-0<br>6-3  |   | 0-0<br>P4   |   | 0-0<br>5-3  |   | 4 0 1 0 0 0 1  |  |
| <b>Connie Ryan, R</b> (1, 4)<br>OBP: 0.372, SLG: 0.384     |  | 0-0<br>1-3  |   | 0-0<br>6-3  |   | 0-0<br>6-3  |   | 0-0<br>1-3  |   | 4 0 0 0 0 0 2  |  |
| <b>Sammy Meeks, R</b> (1, 6)<br>OBP: 0.321, SLG: 0.380     |  | 4-0<br>IBB  |   | 0-0<br>5-3  |   | 0-0<br>4-3  |   | 0-0<br>2B   |   | 3 0 1 0 1 0 0  |  |
| <b>Ewell Blackwell, R</b> (1, 1)<br>OBP: 0.134, SLG: 0.079 |  | 0-0<br>F9   |   | 0-0<br>G3   |   | 0-0<br>F9   |   | 0-0<br>F1   |   | 4 0 0 1 0 0 3  |  |
| <b>Inning Stats</b>  | R: 0<br>E: 0<br>K: 2<br>S: 7<br>H: 1<br>LOB: 2<br>BB: 1<br>P: 11   | R: 1<br>E: 0<br>K: 0<br>S: 5<br>H: 2<br>LOB: 2<br>BB: 1<br>P: 9 | R: 0<br>E: 0<br>K: 1<br>S: 4<br>H: 0<br>LOB: 1<br>BB: 1<br>P: 8 | R: 1<br>E: 0<br>K: 0<br>S: 4<br>H: 1<br>LOB: 0<br>BB: 0<br>P: 4 | R: 0<br>E: 0<br>K: 0<br>S: 3<br>H: 0<br>LOB: 0<br>BB: 0<br>P: 3 | R: 0<br>E: 0<br>K: 0<br>S: 3<br>H: 0<br>LOB: 1<br>BB: 1<br>P: 7 | R: 0<br>E: 0<br>K: 0<br>S: 3<br>H: 0<br>LOB: 0<br>BB: 0<br>P: 3 | R: 0<br>E: 0<br>K: 0<br>S: 4<br>H: 1<br>LOB: 2<br>BB: 1<br>P: 8 | R: 0<br>E: 0<br>K: 0<br>S: 4<br>H: 1<br>LOB: 1<br>BB: 0<br>P: 4 | 1B: 3<br>2B: 4<br>3B: 0<br>HR: 1<br>SF: 0<br>SAC: 1<br>DP: 2<br>HBP: 0 | WP: 0<br>PB: 0<br>SB: 0<br>CS: 2<br>PA: 36 |
| <b>PITCHER</b><br><b>Al Brazle, L</b> (1, 1)<br>ERA: 4.78  | IP: 9.0<br>WLS: W<br>BF: 36<br>H: 6<br>R: 2<br>ER: 2<br>SO: 3<br>BB: 4<br>IBB: 1<br>HBP: 0<br>BLK: 0<br>WP: 0<br>HR: 1<br>S: 37<br>P: 57<br>ERA: 2.00<br>WHIP: 1.111 |   |   |   |   |   |   |   |   |  |  |

**Cincinnati Reds @ St. Louis Cardinals**  
**Sportsman's Park, St. Louis, MO**  
 Sat Aug 19 1950, 4:33 AM EDT  
 Att: 11,248 - Unknown

livebaseballscorecards.com

**AB 27**  
**R 2**  
**H 5**  
**RBI 2**  
**BB 4**  
**SO 3**  
**LOB 14**



| Batter  | 1                | 2          | 3                  | 4                | 5                  | 6         | 7                  | 8         | 9          | AB R H RBI BB SO LOB |
|---|------------------|------------|--------------------|------------------|--------------------|-----------|--------------------|-----------|------------|----------------------|
| Tommy Glaviano, R<br>OBP: 0.421, SLG: 0.426<br>(1, 5)   | 4-0<br>BB<br>2B  |            | 0-3<br>K           |                  | 0-0<br>P6          |           | 4-0<br>SH1-4<br>BB |           | 0-3<br>K   | 3 1 0 0 2 2 1        |
| Red Schoendienst, S<br>OBP: 0.319, SLG: 0.414<br>(1, 4) | 0-3<br>K         |            | 0-3<br>K           |                  | 0-0<br>4-3         |           | 0-0<br>SH1-4       |           | 0-0<br>3B  | 4 0 1 1 0 2 1        |
| Stan Musial, L<br>OBP: 0.448, SLG: 0.607<br>(1, 8)      | 0-0<br>1-H<br>2B |            | 4-0<br>FC4-6<br>BB |                  | 0-0<br>FC6-4<br>1B |           | 0-0<br>6-3         |           |            | 3 0 2 1 1 0 1        |
| Enos Slaughter, L<br>OBP: 0.382, SLG: 0.449<br>(1, 9)   | 0-3<br>K         |            | 0-0<br>FC4-6       |                  | 0-0<br>FC6-4       |           | 0-0<br>3-1         |           |            | 4 0 0 0 0 1 4        |
| Hal Rice, L<br>OBP: 0.257, SLG: 0.188<br>(1, 7)         | 0-0<br>4-3       |            |                    | 0-0<br>L5        |                    | 0-0<br>1B |                    | 0-0<br>1B |            | 4 0 2 0 0 0 1        |
| Marty Marion, R<br>OBP: 0.353, SLG: 0.374<br>(1, 6)     |                  | 0-0<br>F7  |                    | 0-0<br>4-3       |                    | 0-0<br>B3 |                    | 0-0<br>B3 |            | 4 0 0 0 0 0 2        |
| Rocky Nelson, L<br>OBP: 0.317, SLG: 0.351<br>(1, 3)     |                  | 0-0<br>E2  |                    | 4-0<br>2B<br>BB  |                    | 0-0<br>1B |                    | 0-0<br>F8 |            | 3 1 1 0 1 0 0        |
| Del Rice, R<br>OBP: 0.330, SLG: 0.370<br>(1, 2)         |                  | 0-0<br>F8  |                    | 0-0<br>1-H<br>2B |                    | 0-3<br>K  |                    |           | 0-0<br>4-3 | 4 0 1 1 0 1 3        |
| Al Brazle, L<br>OBP: 0.208, SLG: 0.208<br>(1, 1)        |                  | 0-0<br>4-3 |                    | 0-0<br>F7        |                    | 0-3<br>K  |                    |           | 0-0<br>3B  | 4 1 1 0 0 1 4        |

| Inning Stats | R: 1 | H: 1 | E: 0 | K: 2 | S: 8 | H: 1 | LOB: 1 | BB: 1 | P: 12 | R: 0 | H: 0 | E: 1 | K: 0 | S: 4 | H: 0 | LOB: 1 | BB: 0 | P: 4 | R: 0 | H: 0 | E: 0 | K: 2 | S: 7 | H: 0 | LOB: 1 | BB: 1 | P: 11 | R: 1 | H: 1 | E: 0 | K: 0 | S: 4 | H: 1 | LOB: 1 | BB: 0 | P: 4 | R: 0 | H: 2 | E: 0 | K: 2 | S: 9 | H: 2 | LOB: 2 | BB: 0 | P: 9 | R: 0 | H: 0 | E: 0 | K: 0 | S: 3 | H: 0 | LOB: 1 | BB: 1 | P: 7 | R: 0 | H: 1 | E: 0 | K: 0 | S: 3 | H: 1 | LOB: 0 | BB: 0 | P: 3 | R: 1 | H: 2 | E: 0 | K: 1 | S: 6 | H: 2 | LOB: 1 | BB: 0 | P: 6 | 1B: 5 | SF: 0 | 2B: 2 | SAC: 1 | 3B: 1 | DP: 1 | HR: 0 | HBP: 0 | WP: 0 | PA: 38 |
|--------------|------|------|------|------|------|------|--------|-------|-------|------|------|------|------|------|------|--------|-------|------|------|------|------|------|------|------|--------|-------|-------|------|------|------|------|------|------|--------|-------|------|------|------|------|------|------|------|--------|-------|------|------|------|------|------|------|------|--------|-------|------|------|------|------|------|------|------|--------|-------|------|------|------|------|------|------|------|--------|-------|------|-------|-------|-------|--------|-------|-------|-------|--------|-------|--------|
|--------------|------|------|------|------|------|------|--------|-------|-------|------|------|------|------|------|------|--------|-------|------|------|------|------|------|------|------|--------|-------|-------|------|------|------|------|------|------|--------|-------|------|------|------|------|------|------|------|--------|-------|------|------|------|------|------|------|------|--------|-------|------|------|------|------|------|------|------|--------|-------|------|------|------|------|------|------|------|--------|-------|------|-------|-------|-------|--------|-------|-------|-------|--------|-------|--------|

| PITCHER                                   | IP  | WLS | BF | H | R | ER | SO | BB | IBB | HBP | BLK | WP | HR | S  | P  | ERA  | WHIP  |
|---|-----|-----|----|---|---|----|----|----|-----|-----|-----|----|----|----|----|------|-------|
| Ewell Blackwell, R<br>ERA: 3.75<br>(1, 1) | 8.2 | L   | 38 | 8 | 3 | 3  | 7  | 4  | 0   | 0   | 0   | 0  | 0  | 48 | 64 | 3.12 | 1.385 |

**BOTTOM**

**Cincinnati Reds @ St. Louis Cardinals**  
Sportsman's Park, St. Louis, MO

Sat Aug 19 1950, 4:33 AM EDT  
Att. 11,248 - Unknown

livebaseballscorecards.com

|     |    |
|-----|----|
| AB  | 33 |
| R   | 3  |
| H   | 8  |
| RBI | 3  |
| BB  | 4  |
| SO  | 7  |
| LOB | 17 |



| Batter   | 1  | 2                               | 3                            | 4                               | 5                            | 6                               | 7                            | 8                               | 9                            | AB R H RBI BB SO LOB            | TOP   |  |                              |                                 |                              |                                 |                              |                                 |                                  |                                    |                                  |        |
|--|--|---------------------------------|------------------------------|---------------------------------|------------------------------|---------------------------------|------------------------------|---------------------------------|------------------------------|---------------------------------|---|--|------------------------------|---------------------------------|------------------------------|---------------------------------|------------------------------|---------------------------------|----------------------------------|------------------------------------|----------------------------------|--------|
| <b>Bobby Adams, R</b> (1, 5)<br>OBP: 0.351, SLG: 0.391       | 0-0<br>F4  |                                 | 0-0<br>5-3                   |                                 | 0-3<br>K                     |                                 |                              | 0-0<br>SH3-4<br>1B              |                              | 4 0 1 0 0 1 1                   | <b>Cincinnati Reds @ St. Louis Cardinals</b><br>Sportsman's Park, St. Louis, MO<br>Sun Aug 20 1950, 4:33 AM EDT<br>Att. 17,524 - Sunny - 68 F<br><br>livebaseballscorecards.com |  |                              |                                 |                              |                                 |                              |                                 |                                  |                                    |                                  |        |
| <b>Bob Usher, R</b> (1, 8)<br>OBP: 0.322, SLG: 0.381         | 0-0<br>F5  |                                 | 0-3<br>K                     |                                 | 0-0<br>F2                    |                                 | 0-0<br>SH3-4                 |                                 | 3 0 0 0 0 1 0                |                                 |   |  |                              |                                 |                              |                                 |                              |                                 |                                  |                                    |                                  |        |
| <b>Johnny Wyrostek, L</b> (1, 9)<br>OBP: 0.397, SLG: 0.465   | 0-3<br>K   |                                 |                              | 0-0<br>3-1                      | 0-0<br>4-3                   |                                 | 0-0<br>F9                    |                                 | 4 0 0 0 0 1 1                |                                 |   |  |                              |                                 |                              |                                 |                              |                                 |                                  |                                    |                                  |        |
| <b>Ted Kluszewski, L</b> (1, 3)<br>OBP: 0.360, SLG: 0.573    |  | 0-0<br>2B<br>1B                 |                              | 0-0<br>F7                       | 0-0<br>2B                    |                                 | 0-0<br>F3                    |                                 | 4 1 2 0 0 0 1                |                                 |   |  |                              |                                 |                              |                                 |                              |                                 |                                  |                                    |                                  |        |
| <b>Joe Adcock, R</b> (1, 7)<br>OBP: 0.309, SLG: 0.396        |  | 0-0<br>2B                       |                              | 0-0<br>F8                       | 0-3<br>K                     |                                 | 0-3<br>K                     |                                 | 4 0 1 1 0 2 1                |                                 |   |  |                              |                                 |                              |                                 |                              |                                 |                                  |                                    |                                  |        |
| <b>Johnny Pramesa, R</b> (1, 2)<br>OBP: 0.374, SLG: 0.462    |  | 0-0<br>F7                       |                              | 0-0<br>3B<br>1B                 |                              | 0-0<br>F7                       |                              | 4-0<br>BB                       | 3 1 1 0 1 0 1                |                                 |   |  |                              |                                 |                              |                                 |                              |                                 |                                  |                                    |                                  |        |
| <b>Lloyd Merriman, L</b> (9, PR)<br>OBP: 0.332, SLG: 0.352   |  |                                 |                              |                                 |                              |                                 |                              |                                 | 0 0 0 0 0 0 0                |                                 |   |  |                              |                                 |                              |                                 |                              |                                 |                                  |                                    |                                  |        |
| <b>Connie Ryan, R</b> (1, 4)<br>OBP: 0.370, SLG: 0.388       |  | 0-0<br>5-3                      |                              | 0-0<br>3B                       | 0-0<br>5-3                   |                                 | 0-0<br>F6                    |                                 | 4 0 1 1 0 0 2                |                                 |   |  |                              |                                 |                              |                                 |                              |                                 |                                  |                                    |                                  |        |
| <b>Virgil Stallcup, R</b> (1, 6)<br>OBP: 0.280, SLG: 0.350   |  | 0-0<br>F6                       |                              | 0-0<br>L6                       | 0-0<br>1B                    |                                 | 0-0<br>F4                    |                                 | 4 0 1 0 0 0 3                |                                 |   |  |                              |                                 |                              |                                 |                              |                                 |                                  |                                    |                                  |        |
| <b>Herm Wehmeier, R</b> (1, 1)<br>OBP: 0.188, SLG: 0.215     |  |                                 | 0-3<br>K                     |                                 | 0-0<br>6-3                   |                                 | 0-3<br>K                     |                                 | 3 0 0 0 0 2 2                |                                 |   |  |                              |                                 |                              |                                 |                              |                                 |                                  |                                    |                                  |        |
| <b>Ken Raffensberger, R</b> (7, 1)<br>OBP: 0.200, SLG: 0.180 |  |                                 |                              |                                 |                              |                                 |                              |                                 | 0 0 0 0 0 0 0                |                                 |   |  |                              |                                 |                              |                                 |                              |                                 |                                  |                                    |                                  |        |
| <b>Inning Stats</b>  | R: 0<br>E: 0<br>K: 1<br>S: 5   | H: 0<br>LOB: 0<br>BB: 0<br>P: 5 | R: 1<br>E: 0<br>K: 0<br>S: 5 | H: 2<br>LOB: 1<br>BB: 0<br>P: 5 | R: 0<br>E: 0<br>K: 2<br>S: 7 | H: 0<br>LOB: 0<br>BB: 0<br>P: 7 | R: 0<br>E: 0<br>K: 0<br>S: 3 | H: 0<br>LOB: 0<br>BB: 0<br>P: 3 | R: 1<br>E: 0<br>K: 1<br>S: 7 | H: 2<br>LOB: 1<br>BB: 0<br>P: 7 | R: 0<br>E: 0<br>K: 1<br>S: 6  | H: 1<br>LOB: 1<br>BB: 0<br>P: 6  | R: 0<br>E: 0<br>K: 1<br>S: 6 | H: 1<br>LOB: 1<br>BB: 0<br>P: 6 | R: 0<br>E: 0<br>K: 0<br>S: 4 | H: 1<br>LOB: 1<br>BB: 0<br>P: 4 | R: 0<br>E: 0<br>K: 1<br>S: 5 | H: 0<br>LOB: 1<br>BB: 1<br>P: 9 | 1B: 4<br>2B: 2<br>3B: 1<br>HR: 0 | SF: 0<br>SAC: 1<br>DP: 0<br>HBP: 0 | WP: 0<br>PB: 0<br>SB: 0<br>CS: 0 | PA: 35 |
| <b>PITCHER</b><br><b>Howie Pollet, L</b> (1, 1)<br>ERA: 3.3  | IP: 9.0<br>WLS: W<br>BF: 35<br>H: 7<br>R: 2<br>ER: 2<br>SO: 7<br>BB: 1<br>IBB: 0<br>HBP: 0<br>BLK: 0<br>WP: 0<br>HR: 0<br>S: 48<br>P: 52<br>ERA: 2.00<br>WHIP: 0.889 |                                 |                              |                                 |                              |                                 |                              |                                 |                              |                                 |   | <b>PITCHER</b><br>IP: WLS: BF: H: R: ER: SO: BB: IBB: HBP: BLK: WP: HR: S: P: ERA: WHIP: |                              |                                 |                              |                                 |                              |                                 |                                  |                                    |                                  |        |



| Batter   | 1         | 2                | 3               | 4         | 5                       | 6                     | 7                                | 8           | 9         | AB | R | H | RBI | BB | SO | LOB |   |
|--|-----------|------------------|-----------------|-----------|-------------------------|-----------------------|----------------------------------|-------------|-----------|----|---|---|-----|----|----|-----|---|
| Tommy Glaviano, R (1, 5)<br>OBP: 0.424, SLG: 0.429   | 0-0<br>1B |                  | 0-0<br>F9       |           | 4-0<br>1B BB            |                       | 0-0<br>SH5-4<br>1B               |             |           | 3  | 1 | 2 | 0   | 1  | 0  | 0   |   |
| Red Schoendienst, S (1, 4)<br>OBP: 0.317, SLG: 0.411   | 0-0<br>F9 |                  | 0-0<br>F8       |           | 0-0<br>F7               |                       | 0-0<br>SH5-4                     |             |           | 3  | 0 | 0 | 0   | 0  | 0  | 3   |   |
| Stan Musial, L (1, 8)<br>OBP: 0.450, SLG: 0.608<br>Chuck Diering, R (7, PR)<br>OBP: 0.377, SLG: 0.364 (8, 8) | 0-0<br>F9 |                  | 0-0<br>1B<br>1B |           | 0-0<br>1B<br>1-3<br>2-H |                       | 0-0<br>FC4-6<br>1B<br>2-H<br>3-H |             |           | 4  | 0 | 3 | 3   | 0  | 0  | 1   |   |
| Enos Slaughter, L (1, 9)<br>OBP: 0.381, SLG: 0.447   | 0-0<br>F8 |                  | 0-0<br>1B       |           | 0-0<br>L5               |                       | 0-0<br>FC4-6<br>1B<br>1-2f       |             |           | 4  | 0 | 1 | 0   | 0  | 0  | 4   |   |
| Hal Rice, L (1, 7)<br>OBP: 0.256, SLG: 0.194   |           | 0-0<br>4-3       | 0-0<br>F6       |           | 0-0<br>F8               |                       | 0-0<br>FC6-4<br>1B<br>1-2        |             |           | 4  | 0 | 1 | 0   | 0  | 0  | 4   |   |
| Marty Marion, R (1, 6)<br>OBP: 0.348, SLG: 0.368   |           | 0-0<br>F4        |                 | 0-3<br>K  |                         | 0-3<br>K              | 0-0<br>FC6-4<br>1-2f             |             |           | 4  | 0 | 0 | 0   | 0  | 2  | 2   |   |
| Rocky Nelson, L (1, 3)<br>OBP: 0.321, SLG: 0.354   |           | 0-0<br>BB<br>1B  |                 | 0-0<br>F9 |                         | 0-0<br>G6-4-3<br>1B   |                                  | 0-0<br>G3   |           | 4  | 0 | 2 | 0   | 0  | 0  | 0   |   |
| Del Rice, R (1, 2)<br>OBP: 0.329, SLG: 0.366   |           | 4-0<br>1-2<br>BB |                 | 0-0<br>F3 |                         | 0-0<br>G6-4-3<br>1-2f |                                  | 0-3<br>K2-3 |           | 3  | 0 | 0 | 0   | 1  | 1  | 1   |   |
| Howie Pollet, L (1, 1)<br>OBP: 0.181, SLG: 0.147   |           | 0-0<br>F5        |                 |           | 0-0<br>BB<br>1B<br>1B   |                       | 4-0<br>SH5-4<br>1B<br>BB         |             | 0-0<br>F6 |    | 3 | 2 | 1   | 0  | 1  | 0   | 2 |

| Inning Stats | R: 0 | H: 1 | E: 0 | LOB: 1 | K: 0 | BB: 0 | S: 4 | R: 0 | H: 1 | E: 0 | LOB: 2 | K: 0 | BB: 1 | S: 4 | R: 0 | H: 2 | E: 0 | LOB: 2 | K: 0 | BB: 0 | S: 5 | R: 0 | H: 0 | E: 0 | LOB: 0 | K: 1 | BB: 0 | S: 5 | R: 1 | H: 2 | E: 0 | LOB: 2 | K: 0 | BB: 1 | S: 5 | R: 0 | H: 1 | E: 0 | LOB: 0 | K: 1 | BB: 0 | S: 5 | R: 2 | H: 3 | E: 0 | LOB: 2 | K: 0 | BB: 1 | S: 6 | R: 0 | H: 0 | E: 0 | LOB: 0 | K: 1 | BB: 0 | S: 5 | 1B: 10 | SF: 0 | 2B: 0 | SAC: 1 | 3B: 0 | DP: 1 | HR: 0 | HBP: 0 |
|--------------|------|------|------|--------|------|-------|------|------|------|------|--------|------|-------|------|------|------|------|--------|------|-------|------|------|------|------|--------|------|-------|------|------|------|------|--------|------|-------|------|------|------|------|--------|------|-------|------|------|------|------|--------|------|-------|------|------|------|------|--------|------|-------|------|--------|-------|-------|--------|-------|-------|-------|--------|
|--------------|------|------|------|--------|------|-------|------|------|------|------|--------|------|-------|------|------|------|------|--------|------|-------|------|------|------|------|--------|------|-------|------|------|------|------|--------|------|-------|------|------|------|------|--------|------|-------|------|------|------|------|--------|------|-------|------|------|------|------|--------|------|-------|------|--------|-------|-------|--------|-------|-------|-------|--------|

| PITCHER                                  | IP  | WLS | BF | H | R | ER | SO | BB | IBB | HBP | BLK | WP | HR | S  | P  | ERA  | WHIP  |
|--|-----|-----|----|---|---|----|----|----|-----|-----|-----|----|----|----|----|------|-------|
| Herm Wehmer, R (1, 1)<br>ERA: 5.47       | 6.1 | L   | 30 | 9 | 3 | 3  | 2  | 3  | 0   | 0   | 0   | 0  | 0  | 31 | 43 | 4.26 | 1.895 |
| Ken Raffensberger, L (7, 1)<br>ERA: 3.85 | 1.2 |     | 6  | 1 | 0 | 0  | 1  | 0  | 0   | 0   | 0   | 0  | 0  | 8  | 8  | 0.00 | 0.600 |

**BOTTOM**

**Cincinnati Reds @ St. Louis Cardinals**  
 Sportsman's Park, St. Louis, MO  
 Sun Aug 20 1950, 4:33 AM EDT  
 Att. 17,524 - Sunny - 68 F

[livebaseballscorecards.com](http://livebaseballscorecards.com)

|            |           |
|------------|-----------|
| <b>AB</b>  | <b>32</b> |
| <b>R</b>   | <b>3</b>  |
| <b>H</b>   | <b>10</b> |
| <b>RBI</b> | <b>3</b>  |
| <b>BB</b>  | <b>3</b>  |
| <b>SO</b>  | <b>3</b>  |
| <b>LOB</b> | <b>17</b> |



| WP | HR | S | P | ERA | WHIP |
|----|----|---|---|-----|------|
| 0  | 0  | 0 | 0 | 0   | 0    |

| Batter  | 1   | 2                                      | 3                            | 4                               | 5                            | 6                                | 7                            | 8                               | 9                            | AB R H RBI BB SO LOB            | TOP                          |                                 |   |                                 |                              |                                 |                                  |                                    |                                  |        |
|---|---|--|------------------------------|---------------------------------|------------------------------|----------------------------------|------------------------------|---------------------------------|------------------------------|---------------------------------|------------------------------|---------------------------------|---|---------------------------------|------------------------------|---------------------------------|----------------------------------|------------------------------------|----------------------------------|--------|
| <b>Eddie Waitkus, L</b> (1, 3)<br>OBP: 0.331, SLG: 0.342  | 0-0<br>F9   | 0-0<br>1B                              |                              | 0-3<br>K                        |                              | 0-0<br>FC6-4<br>1B               |                              |                                 | 0-0<br>F4                    | 5 0 2 2 0 1 0                   |                              |                                 |   |                                 |                              |                                 |                                  |                                    |                                  |        |
| <b>Richie Ashburn, L</b> (1, 8)<br>OBP: 0.382, SLG: 0.419 | 0-0<br>2B   | 0-0<br>F6                              |                              | 0-0<br>F6                       |                              | 0-0<br>FC6-4<br>1-2f             |                              |                                 | 0-0<br>1B<br>1B              | 5 1 2 0 0 0 2                   |                              |                                 |   |                                 |                              |                                 |                                  |                                    |                                  |        |
| <b>Willie Jones, R</b> (1, 5)<br>OBP: 0.370, SLG: 0.531   | 0-0<br>F4   | 0-0<br>F7                              |                              | 0-0<br>F7                       |                              |                                  | 0-0<br>E5<br>FC5-4           |                                 | 0-0<br>1B<br>1-2<br>1B       | 5 0 1 0 0 0 2                   |                              |                                 |   |                                 |                              |                                 |                                  |                                    |                                  |        |
| <b>Del Ennis, R</b> (1, 9)<br>OBP: 0.354, SLG: 0.562      | 4-0<br>IBB  |  | 0-0<br>F4                    |                                 | 0-0<br>1B                    |                                  | 0-0<br>F6                    |                                 | 0-0<br>1B<br>1-2<br>2-H      | 4 0 2 1 1 0 1                   |                              |                                 |   |                                 |                              |                                 |                                  |                                    |                                  |        |
| <b>Dick Sisler, L</b> (1, 7)<br>OBP: 0.382, SLG: 0.457    | 0-0<br>6-3  |  | 0-0<br>BB<br>2B              |                                 | 0-0<br>F7                    |                                  | 0-0<br>F6                    |                                 | 0-0<br>F5                    | 5 0 1 0 0 0 6                   |                              |                                 |   |                                 |                              |                                 |                                  |                                    |                                  |        |
| <b>Granny Hamner, R</b> (1, 6)<br>OBP: 0.316, SLG: 0.395  |   | 0-0<br>1B<br>1B                        | 0-0<br>F4                    |                                 | 0-0<br>F4                    |                                  | 0-0<br>FC5-4<br>1-2f         |                                 | 0-0<br>F9                    | 5 1 1 0 0 0 5                   |                              |                                 |   |                                 |                              |                                 |                                  |                                    |                                  |        |
| <b>Andy Seminick, R</b> (1, 2)<br>OBP: 0.414, SLG: 0.549  |   | 0-0<br>SH3-4<br>1-3<br>1B<br>1B        | 4-0<br>BB<br>IBB             |                                 | 0-0<br>F5                    |                                  |                              | 0-0<br>6-3                      |                              | 3 1 1 0 1 0 1                   | <b>AB 38</b>                 |                                 |   |                                 |                              |                                 |                                  |                                    |                                  |        |
| <b>Mike Goliat, R</b> (1, 4)<br>OBP: 0.321, SLG: 0.390    |   | 0-0<br>SH3-4<br>1-2<br>3-H<br>1B<br>1B | 4-0<br>BB<br>BB<br>BB<br>BB  |                                 |                              | 0-0<br>F7                        |                              | 0-0<br>F7                       |                              | 3 1 1 1 1 0 0                   | <b>R 4</b>                   |                                 |   |                                 |                              |                                 |                                  |                                    |                                  |        |
| <b>Robin Roberts, S</b> (1, 1)<br>OBP: 0.176, SLG: 0.103  |   | 0-0<br>SH3-4<br>1-2<br>2-3             | 0-3<br>K                     |                                 |                              | 0-0<br>4-3                       |                              | 0-3<br>K                        |                              | 3 0 0 0 0 2 3                   | <b>H 11</b>                  |                                 |   |                                 |                              |                                 |                                  |                                    |                                  |        |
| <b>Inning Stats</b>                                       | R: 0<br>E: 0<br>K: 0<br>S: 4  | H: 1<br>LOB: 2<br>BB: 1<br>P: 8        | R: 3<br>E: 0<br>K: 0<br>S: 7 | H: 4<br>LOB: 1<br>BB: 0<br>P: 7 | R: 0<br>E: 0<br>K: 1<br>S: 6 | H: 1<br>LOB: 3<br>BB: 2<br>P: 14 | R: 0<br>E: 0<br>K: 1<br>S: 5 | H: 0<br>LOB: 0<br>BB: 0<br>P: 5 | R: 0<br>E: 0<br>K: 0<br>S: 4 | H: 1<br>LOB: 1<br>BB: 0<br>P: 4 | R: 0<br>E: 1<br>K: 0<br>S: 4 | H: 0<br>LOB: 1<br>BB: 0<br>P: 4 | R: 0<br>E: 0<br>K: 1<br>S: 5  | H: 0<br>LOB: 0<br>BB: 0<br>P: 5 | R: 1<br>E: 0<br>K: 0<br>S: 6 | H: 3<br>LOB: 2<br>BB: 0<br>P: 6 | 1B: 9<br>2B: 2<br>3B: 0<br>HR: 0 | SF: 0<br>SAC: 1<br>DP: 0<br>HBP: 0 | WP: 0<br>PB: 0<br>SB: 0<br>CS: 0 | PA: 42 |
| <b>PITCHER Ken Raffensberger, L</b> (1, 1)<br>ERA: 3.86   | IP: 9.0<br>WLS: L<br>BF: 42<br>H: 11<br>R: 4<br>ER: 4<br>SO: 3<br>BB: 1<br>IBB: 2<br>HBP: 0<br>BLK: 0<br>WP: 0<br>HR: 0<br>S: 45<br>P: 57<br>ERA: 4.00<br>WHIP: 1.333 |  |                              |                                 |                              |                                  |                              |                                 |                              |                                 |                              | <b>PITCHER</b>                  | IP: 9.0<br>WLS: L<br>BF: 42<br>H: 11<br>R: 4<br>ER: 4<br>SO: 3<br>BB: 1<br>IBB: 2<br>HBP: 0<br>BLK: 0<br>WP: 0<br>HR: 0<br>S: 45<br>P: 57<br>ERA: 4.00<br>WHIP: 1.333 |                                 |                              |                                 |                                  |                                    |                                  |        |

Philadelphia Phillies @ Cincinnati Reds  
Crosley Field, Cincinnati, OH  
Tue Aug 22 1950, 3:33 AM EDT  
Att. 11,660 - Unknown - 71 F

|            |    |
|------------|----|
| <b>AB</b>  | 38 |
| <b>R</b>   | 4  |
| <b>H</b>   | 11 |
| <b>RBI</b> | 4  |
| <b>BB</b>  | 3  |
| <b>SO</b>  | 3  |
| <b>LOB</b> | 20 |



| Batter  | 1          | 2         | 3          | 4                             | 5                             | 6          | 7                | 8                     | 9         | AB | R | H | RBI | BB | SO | LOB |
|---|------------|-----------|------------|-------------------------------|-------------------------------|------------|------------------|-----------------------|-----------|----|---|---|-----|----|----|-----|
| Lloyd Merriman, L (1, 8)<br>OBP: 0.339, SLG: 0.356  | 0-3<br>K   |           |            | 4-0<br>1B<br>4-3<br>BB        | 0-0<br>1B<br>1-2<br>2-3<br>1B |            | 0-0<br>CS<br>1B  |                       |           | 3  | 1 | 2 | 0   | 1  | 1  | 0   |
| Grady Hatton, L (1, 5)<br>OBP: 0.359, SLG: 0.403  | 0-0<br>6-3 |           |            | 0-0<br>1B<br>1-3<br>4-3<br>1B | 0-0<br>F9<br>2-3<br>3-H       |            | 0-0<br>CS<br>1-2 | 4-0<br>G4-6-3<br>BB   |           | 3  | 0 | 1 | 1   | 1  | 0  | 2   |
| Johnny Wyrostek, L (1, 9)<br>OBP: 0.395, SLG: 0.462   | 0-3<br>K   |           |            | 0-0<br>4-3<br>1-2<br>3-H      | 0-0<br>1-3<br>3-H<br>1B       |            |                  | 0-0<br>G4-6-3<br>1-2f |           | 4  | 0 | 1 | 2   | 0  | 1  | 2   |
| Ted Kluszewski, L (1, 3)<br>OBP: 0.359, SLG: 0.569  |            | 0-0<br>L6 |            | 0-0<br>FC6-4<br>2-3<br>1B     | 0-0<br>F3<br>3-H              |            |                  | 0-0<br>F2             |           | 4  | 0 | 1 | 0   | 0  | 0  | 2   |
| Joe Adcock, R (1, 7)<br>OBP: 0.306, SLG: 0.393  |            | 0-0<br>F6 |            | 0-0<br>F4                     |                               | 0-0<br>4-3 |                  |                       | 0-0<br>1B | 4  | 0 | 1 | 0   | 0  | 0  | 2   |
| Johnny Pramesa, R (1, 2)<br>OBP: 0.371, SLG: 0.452<br>Bobby Adams, R (9, PR)<br>OBP: 0.351, SLG: 0.391    |            | 0-3<br>K  |            | 0-0<br>FC6-4<br>1-2f          |                               | 0-0<br>F4  |                  | 4-0<br>FC4-6<br>BB    |           | 3  | 0 | 0 | 0   | 1  | 1  | 2   |
| Connie Ryan, R (1, 4)<br>OBP: 0.369, SLG: 0.387   |            |           | 0-0<br>F8  |                               | 0-0<br>1B<br>F9<br>1B<br>1B   | 0-0<br>F6  |                  | 0-0<br>F7             |           | 4  | 1 | 1 | 0   | 0  | 0  | 1   |
| Virgil Stallcup, R (1, 6)<br>OBP: 0.281, SLG: 0.350<br>Bob Scheffing, R (9, PH)<br>OBP: 0.313, SLG: 0.383 |            |           | 0-0<br>6-3 |                               | 0-0<br>F9<br>1-2<br>1B<br>1B  |            | 0-0<br>F2        | 0-0<br>FC4-6<br>1-2f  |           | 3  | 1 | 1 | 0   | 0  | 0  | 0   |
| Ken Raffensberger, R (1, 1)<br>OBP: 0.191, SLG: 0.172   |            |           | 0-0<br>1-3 |                               | 0-3<br>K                      |            | 0-0<br>F8        |                       |           | 1  | 0 | 0 | 0   | 0  | 1  | 2   |

|  |                              |                                 |                              |                                 |                              |                                 |                              |                                 |                              |                                 |                              |                                 |                              |                                 |                              |                                 |                                  |                                    |                       |
|--|------------------------------|---------------------------------|------------------------------|---------------------------------|------------------------------|---------------------------------|------------------------------|---------------------------------|------------------------------|---------------------------------|------------------------------|---------------------------------|------------------------------|---------------------------------|------------------------------|---------------------------------|----------------------------------|------------------------------------|-----------------------|
| <b>Inning Stats</b>                                    | R: 0<br>E: 0<br>K: 2<br>S: 7 | H: 0<br>LOB: 0<br>BB: 0<br>P: 7 | R: 0<br>E: 0<br>K: 1<br>S: 5 | H: 0<br>LOB: 0<br>BB: 0<br>P: 5 | R: 0<br>E: 0<br>K: 0<br>S: 3 | H: 0<br>LOB: 0<br>BB: 0<br>P: 3 | R: 1<br>E: 0<br>K: 0<br>S: 5 | H: 2<br>LOB: 2<br>BB: 1<br>P: 9 | R: 2<br>E: 0<br>K: 1<br>S: 9 | H: 4<br>LOB: 2<br>BB: 0<br>P: 9 | R: 0<br>E: 0<br>K: 0<br>S: 3 | H: 0<br>LOB: 0<br>BB: 0<br>P: 3 | R: 0<br>E: 0<br>K: 0<br>S: 2 | H: 0<br>LOB: 0<br>BB: 1<br>P: 6 | R: 0<br>E: 0<br>K: 0<br>S: 3 | H: 1<br>LOB: 1<br>BB: 1<br>P: 7 | 1B: 8<br>2B: 0<br>3B: 0<br>HR: 0 | SF: 0<br>SAC: 0<br>DP: 1<br>HBP: 0 |                       |
| <b>PITCHER</b><br>Robin Roberts, R (1, 1)<br>ERA: 2.99 | IP<br>9.0                    | WLS<br>W                        | BF<br>35                     | H<br>8                          | R<br>3                       | ER<br>3                         | SO<br>4                      | BB<br>3                         | IBB<br>0                     | HBP<br>0                        | BLK<br>0                     | WP<br>0                         | HR<br>0                      | S<br>40                         | P<br>52                      | ERA<br>3.00                     | WHIP<br>1.222                    | WP: 0<br>PB: 0<br>SB: 0<br>CS: 1   | PA: 36<br>ERA<br>WHIP |

**BOTTOM**

**Philadelphia Phillies @ Cincinnati Reds**  
Crosley Field, Cincinnati, OH

Tue Aug 22 1950, 3:33 AM EDT  
Att. 11,660 - Unknown - 71 F

|            |           |
|------------|-----------|
| <b>AB</b>  | <b>32</b> |
| <b>R</b>   | <b>3</b>  |
| <b>H</b>   | <b>8</b>  |
| <b>RBI</b> | <b>3</b>  |
| <b>BB</b>  | <b>3</b>  |
| <b>SO</b>  | <b>4</b>  |
| <b>LOB</b> | <b>14</b> |



| Batter   | 1   | 2                                | 3                            | 4                               | 5                            | 6                               | 7                            | 8                               | 9                            | AB R H RBI BB SO LOB            | TOP                          |                                 |                              |                                  |                              |                                  |                              |                                 |                                  |                                    |                                  |        |
|--|---|----------------------------------|------------------------------|---------------------------------|------------------------------|---------------------------------|------------------------------|---------------------------------|------------------------------|---------------------------------|------------------------------|---------------------------------|------------------------------|----------------------------------|------------------------------|----------------------------------|------------------------------|---------------------------------|----------------------------------|------------------------------------|----------------------------------|--------|
| Eddie Waitkus, L (1, 3)<br>OBP: 0.333, SLG: 0.342  | 4-0<br>G3<br>1B<br>BB                                 |                                  | x 0-0<br>F7                  | x 0-0<br>F9                     |                              |                                 | BBB 4-0<br>G4-6-3<br>BB      |                                 | x 0-0<br>1B                  | 3 1 1 0 2 0 0                   |                              |                                 |                              |                                  |                              |                                  |                              |                                 |                                  |                                    |                                  |        |
| Richie Ashburn, L (1, 8)<br>OBP: 0.380, SLG: 0.417 | x 0-0<br>G3   |                                  | x 0-0<br>1B                  |                                 | 0-0<br>K                     |                                 | x 0-0<br>G4-6-3              |                                 | x 0-0<br>L9                  | 5 1 1 0 0 1 4                   |                              |                                 |                              |                                  |                              |                                  |                              |                                 |                                  |                                    |                                  |        |
| Dick Sisler, L (1, 7)<br>OBP: 0.382, SLG: 0.455    | x 0-0<br>2B<br>1B                                     |                                  | x 0-0<br>F8                  |                                 | x 0-0<br>G3                  |                                 | BBB 4-0<br>HR<br>BB          |                                 | x 0-0<br>4-3                 | 4 2 1 1 1 0 2                   |                              |                                 |                              |                                  |                              |                                  |                              |                                 |                                  |                                    |                                  |        |
| Del Ennis, R (1, 9)<br>OBP: 0.355, SLG: 0.569      | 0-3<br>K  |                                  | x 0-0<br>1B                  | 1-H<br>1B                       | x 0-0<br>F9                  |                                 | x 0-0<br>HR                  |                                 |                              | 4 1 2 3 0 1 1                   |                              |                                 |                              |                                  |                              |                                  |                              |                                 |                                  |                                    |                                  |        |
| Willie Jones, R (1, 5)<br>OBP: 0.371, SLG: 0.533   | x 0-0<br>1-H<br>2B                                    |                                  | x 0-0<br>1B                  |                                 | x 0-0<br>6-3                 |                                 | x 0-0<br>P4                  |                                 |                              | 4 0 2 1 0 0 0                   |                              |                                 |                              |                                  |                              |                                  |                              |                                 |                                  |                                    |                                  |        |
| Granny Hamner, R (1, 6)<br>OBP: 0.314, SLG: 0.392  | x 0-0<br>5-3  |                                  | x 0-0<br>F7                  |                                 | x 0-0<br>F9                  |                                 | SSS 0-3<br>K                 |                                 |                              | 4 0 0 0 0 1 3                   |                              |                                 |                              |                                  |                              |                                  |                              |                                 |                                  |                                    |                                  |        |
| Andy Seminick, R (1, 2)<br>OBP: 0.415, SLG: 0.559  |   | x 0-0<br>5-3                     |                              | x 0-0<br>HR                     |                              | x 0-0<br>5-3                    |                              | x 0-0<br>FC6-4<br>1B            |                              | 4 1 2 1 0 0 0                   |                              |                                 |                              |                                  |                              |                                  |                              |                                 |                                  |                                    |                                  |        |
| Mike Goliat, R (1, 4)<br>OBP: 0.321, SLG: 0.386    |   | x 0-0<br>5-3                     |                              | x 0-0<br>F2                     |                              | BBB 4-0<br>PB<br>BB             |                              | x 0-0<br>FC6-4                  |                              | 3 0 0 0 1 0 1                   |                              |                                 |                              |                                  |                              |                                  |                              |                                 |                                  |                                    |                                  |        |
| Bob Miller, R (1, 1)<br>OBP: 0.220, SLG: 0.224     |   | x 0-0<br>5-3                     |                              | x 0-0<br>6-3                    |                              | x 0-0<br>F2                     |                              | x 0-0<br>F8                     |                              | 4 0 0 0 0 0 1                   |                              |                                 |                              |                                  |                              |                                  |                              |                                 |                                  |                                    |                                  |        |
| Jim Konstanty, R (9, 1)<br>OBP: 0.053, SLG: 0.053  |   |                                  |                              |                                 |                              |                                 |                              |                                 |                              | 0 0 0 0 0 0 0                   |                              |                                 |                              |                                  |                              |                                  |                              |                                 |                                  |                                    |                                  |        |
| <b>Inning Stats</b>                                | R: 2<br>E: 0<br>K: 1<br>S: 7                          | H: 2<br>LOB: 1<br>BB: 1<br>P: 11 | R: 0<br>E: 0<br>K: 0<br>S: 3 | H: 0<br>LOB: 0<br>BB: 0<br>P: 3 | R: 1<br>E: 0<br>K: 0<br>S: 6 | H: 3<br>LOB: 2<br>BB: 0<br>P: 6 | R: 1<br>E: 0<br>K: 0<br>S: 4 | H: 1<br>LOB: 0<br>BB: 0<br>P: 4 | R: 0<br>E: 0<br>K: 1<br>S: 5 | H: 0<br>LOB: 0<br>BB: 0<br>P: 5 | R: 0<br>E: 0<br>K: 0<br>S: 3 | H: 0<br>LOB: 0<br>BB: 0<br>P: 3 | R: 0<br>E: 0<br>K: 0<br>S: 2 | H: 0<br>LOB: 1<br>BB: 2<br>P: 10 | R: 2<br>E: 0<br>K: 1<br>S: 7 | H: 2<br>LOB: 1<br>BB: 1<br>P: 11 | R: 0<br>E: 0<br>K: 0<br>S: 4 | H: 1<br>LOB: 1<br>BB: 0<br>P: 4 | 1B: 6<br>2B: 1<br>3B: 0<br>HR: 2 | SF: 0<br>SAC: 0<br>DP: 1<br>HBP: 0 | WP: 0<br>PB: 1<br>SB: 1<br>CS: 0 | PA: 39 |
| <b>PITCHER</b>                                     | IP WLS BF H R ER SO BB IBB HBP BLK WP HR S P ERA WHIP |                                  |                              |                                 |                              |                                 |                              |                                 |                              |                                 |                              |                                 |                              |                                  |                              |                                  |                              |                                 |                                  |                                    |                                  |        |
| Willie Ramsdell, R (1, 1)<br>ERA: 3.69             | 4.0 L 19 6 4 4 1 1 0 0 0 0 0 1 20 24 9.00 1.750       |                                  |                              |                                 |                              |                                 |                              |                                 |                              |                                 |                              |                                 |                              |                                  |                              |                                  |                              |                                 |                                  |                                    |                                  |        |
| Howie Fox, R (5, 1)<br>ERA: 5.16                   | 2.0 6 0 0 0 1 0 0 0 0 0 0 0 8 8 0.00 0.000            |                                  |                              |                                 |                              |                                 |                              |                                 |                              |                                 |                              |                                 |                              |                                  |                              |                                  |                              |                                 |                                  |                                    |                                  |        |
| Harry Perkowski, L (7, 1)<br>ERA: 4.83             | 1.0 6 1 2 2 0 3 0 0 0 0 0 1 3 15 18.00 4.000          |                                  |                              |                                 |                              |                                 |                              |                                 |                              |                                 |                              |                                 |                              |                                  |                              |                                  |                              |                                 |                                  |                                    |                                  |        |
| Johnny Hetki, R (8, 1)<br>ERA: 5.04                | 2.0 8 2 0 0 1 0 0 0 0 0 0 0 10 10 0.00 1.000          |                                  |                              |                                 |                              |                                 |                              |                                 |                              |                                 |                              |                                 |                              |                                  |                              |                                  |                              |                                 |                                  |                                    |                                  |        |

Philadelphia Phillies @ Cincinnati Reds  
Crosley Field, Cincinnati, OH  
Wed Aug 23 1950, 3:33 AM EDT  
Att. 5,964 - Unknown

|     |    |
|-----|----|
| AB  | 35 |
| R   | 6  |
| H   | 9  |
| RBI | 6  |
| BB  | 4  |
| SO  | 3  |
| LOB | 12 |



livebaseballscorecards.com



| Batter  | 1                    | 2          | 3             | 4       | 5       | 6                      | 7          | 8      | 9              | AB R H RBI BB SO LOB   |
|---|----------------------|------------|---------------|---------|---------|------------------------|------------|--------|----------------|--|
| Lloyd Merriman, L (1, 8)<br>OBP: 0.332, SLG: 0.348  | 0-0 4-3              | 0-0 P5     |               | 0-0 4-3 |         |                        | 0-0 F8     |        | 0-3 K          | 5 0 0 0 0 1 3  |
| Grady Hatton, L (1, 5)<br>OBP: 0.360, SLG: 0.399  | 0-0 F7               | 0-0 3-1    |               |         | 0-0 1-3 |                        | 4-0 HR BB  |        | 4-0 1B 2B BB   | 3 2 0 0 2 0 2  |
| Johnny Wyrostek, L (1, 9)<br>OBP: 0.395, SLG: 0.460   | 4-0 BB 1B BB         |            | 0-0 6-3       |         | 0-0 L9  |                        | 0-0 P3     |        | 0-0 2B 1B      | 4 0 1 0 1 0 1  |
| Ted Kluszewski, L (1, 3)<br>OBP: 0.365, SLG: 0.586  | 0-0 BB 1-2 1B        |            | 0-0 FC6-5 2B  |         | 0-0 G3  |                        | 0-0 1-H HR |        | 0-0 1-3 2-H 2B | 5 1 4 3 0 0 0  |
| Joe Adcock, R (1, 7)<br>OBP: 0.310, SLG: 0.391  | 4-0 FC6-4 BB 1-2 2-3 |            | 0-0 FC6-5 2-3 |         |         | 0-0 G5-4-3 1B 1B       | 0-0 5-3    |        | 0-0 F9         | 4 1 1 0 1 0 3  |
| Johnny Pramesa, R (1, 2)<br>OBP: 0.368, SLG: 0.443  | 0-0 FC6-4 1-2f       |            | 0-0 1-3       |         |         | 4-0 G5-4-3 1-2 BB      |            | 0-0 F7 |                | 3 0 0 0 1 0 4  |
| Connie Ryan, R (1, 4)<br>OBP: 0.368, SLG: 0.385   |                      | 0-0 1B 1B  |               | 0-0 4-3 |         | 0-0 G5-4-3 1-2f 2-3 BB |            | 0-0 P5 |                | 4 0 1 0 0 0 2  |
| Virgil Stallcup, R (1, 6)<br>OBP: 0.280, SLG: 0.349   |                      | 0-0 P4     |               | 0-0 L8  |         | 0-0 3-H 1B             |            | 0-0 F7 |                | 4 0 1 1 0 0 1  |
| Willie Ramsdell, R (1, 1)<br>OBP: 0.277, SLG: 0.209<br>Danny Litwhiler, R (4, PH)<br>OBP: 0.379, SLG: 0.479<br>Howie Fox, R (5, 1)<br>OBP: 0.225, SLG: 0.325<br>Bob Scheffing, R (6, PH)<br>OBP: 0.364, SLG: 0.377<br>Harry Perkowski, L (7, 1)<br>OBP: 0.222, SLG: 0.125<br>Johnny Hetki, R (8, 1)<br>OBP: 0.222, SLG: 0.125<br>Bobby Adams, R (9, PH)<br>OBP: 0.350, SLG: 0.390 |                      | 0-0 1-2 1B |               | 0-0 1B  |         | 0-0 4-3                |            |        | 0-0 P5         | 1 0 1 0 0 0 0<br>1 0 1 0 0 0 0<br>0 0 0 0 0 0 0<br>1 0 0 0 0 0 1<br>0 0 0 0 0 0 0<br>0 0 0 0 0 0 0<br>0 0 0 0 0 0 0<br>1 0 0 0 0 0 0 |

| Inning Stats | R: 0 | H: 1 | E: 0 | K: 0 | S: 4 | H: 1 | LOB: 3 | BB: 2 | P: 12 | R: 0 | H: 2 | E: 0 | K: 0 | S: 5 | H: 1 | LOB: 2 | BB: 0 | P: 5 | R: 0 | H: 1 | E: 0 | K: 0 | S: 4 | H: 0 | LOB: 1 | BB: 0 | P: 4 | R: 0 | H: 1 | E: 0 | K: 0 | S: 4 | H: 0 | LOB: 0 | BB: 0 | P: 3 | R: 1 | H: 2 | E: 0 | K: 0 | S: 4 | H: 2 | LOB: 1 | BB: 1 | P: 8 | R: 2 | H: 1 | E: 0 | K: 0 | S: 4 | H: 1 | LOB: 0 | BB: 1 | P: 8 | R: 0 | H: 0 | E: 0 | K: 0 | S: 3 | H: 0 | LOB: 0 | BB: 0 | P: 3 | R: 1 | H: 2 | E: 0 | K: 1 | S: 7 | H: 2 | LOB: 2 | BB: 1 | P: 11 | 1B: 7 | 2B: 2 | 3B: 0 | HR: 1 | SF: 0 | SAC: 0 | DP: 1 | HBP: 0 | WP: 0 | PA: 41 |
|--------------|------|------|------|------|------|------|--------|-------|-------|------|------|------|------|------|------|--------|-------|------|------|------|------|------|------|------|--------|-------|------|------|------|------|------|------|------|--------|-------|------|------|------|------|------|------|------|--------|-------|------|------|------|------|------|------|------|--------|-------|------|------|------|------|------|------|------|--------|-------|------|------|------|------|------|------|------|--------|-------|-------|-------|-------|-------|-------|-------|--------|-------|--------|-------|--------|
|--------------|------|------|------|------|------|------|--------|-------|-------|------|------|------|------|------|------|--------|-------|------|------|------|------|------|------|------|--------|-------|------|------|------|------|------|------|------|--------|-------|------|------|------|------|------|------|------|--------|-------|------|------|------|------|------|------|------|--------|-------|------|------|------|------|------|------|------|--------|-------|------|------|------|------|------|------|------|--------|-------|-------|-------|-------|-------|-------|-------|--------|-------|--------|-------|--------|

| PITCHER                              | IP  | WLS | BF | H | R | ER | SO | BB | IBB | HBP | BLK | WP | HR | S  | P  | ERA  | WHIP  |
|--------------------------------------|-----|-----|----|---|---|----|----|----|-----|-----|-----|----|----|----|----|------|-------|
| Bob Miller, R (1, 1)<br>ERA: 3.16    | 8.2 | W   | 39 | 9 | 4 | 4  | 1  | 5  | 0   | 0   | 0   | 0  | 1  | 36 | 56 | 4.15 | 1.615 |
| Jim Konstanty, R (9, 1)<br>ERA: 2.42 | 0.1 | S   | 2  | 1 | 0 | 0  | 0  | 0  | 0   | 0   | 0   | 0  | 0  | 2  | 2  | 0.00 | 3.000 |

**BOTTOM**

**Philadelphia Phillies @ Cincinnati Reds**  
Crosley Field, Cincinnati, OH

Wed Aug 23 1950, 3:33 AM EDT  
Att. 5,964 - Unknown

livebaseballscorecards.com

|     |    |
|-----|----|
| AB  | 36 |
| R   | 4  |
| H   | 10 |
| RBI | 4  |
| BB  | 5  |
| SO  | 1  |
| LOB | 17 |



| Batter  | 1  | 2  | 3   | 4  | 5   | 6   | 7   | 8   | 9   | AB R H RBI BB SO LOB   | TOP  |
|---|--|--|---|--|---|---|---|---|---|--|--|
| <b>Pee Wee Reese, R</b> (1, 6)<br>OBP: 0.363, SLG: 0.363        | 2-1<br>6-3   |  |   | 2-2<br>6-3   | 4-1<br>BB   |   | 0-3<br>K  |   |   | 3 0 0 1 1 1 1  |  |
| <b>Gene Hermanski, L</b> (1, 7)<br>OBP: 0.379, SLG: 0.492       | 4-2<br>FC4-6<br>BB   |  |   | 3-2<br>L4  | 0-1<br>G3   |   |   | 0-1<br>4-3  |   | 3 0 0 0 1 0 3  |  |
| <b>Duke Snider, L</b> (1, 8)<br>OBP: 0.376, SLG: 0.535          | 1-1<br>FC4-6<br>CS   |  |   | 4-1<br>BB  |   | 0-1<br>2B   |   | 0-2<br>S<br>1B  |   | 3 0 2 0 1 0 1  |  |
| <b>Carl Furillo, R</b> (1, 9)<br>OBP: 0.362, SLG: 0.496         | 0-2<br>CS  | 0-0<br>1-4-3   |   | 1-0<br>F9  |   | 1-2<br>L7   |   | 3-3<br>K  |   | 4 0 0 0 0 1 3  |  |
| <b>Gil Hodges, R</b> (1, 3)<br>OBP: 0.387, SLG: 0.502           |  |  | 2-3<br>K  |  | 1-1<br>SH3-4<br>1B<br>BB  | 0-3<br>K  |   | 3-1<br>1B   |   | 4 1 2 0 0 2 1  |  |
| <b>Roy Campanella, R</b> (1, 2)<br>OBP: 0.379, SLG: 0.557       |  |  | 2-3<br>K  |  | 0-1<br>BB<br>SH3-4<br>1B  | 0-1<br>4-3  |   | 0-1<br>4-3  |   | 4 0 1 0 0 1 1  |  |
| <b>Jackie Robinson, R</b> (1, 4)<br>OBP: 0.419, SLG: 0.508      |  |  |   | 1-1<br>G4-6-3<br>1B  | 0-0<br>SH3-4  |   | 4-2<br>5-3<br>SH1-4<br>BB   | 0-0<br>5-3  |   | 2 0 1 0 1 0 0  |  |
| <b>Billy Cox, R</b> (1, 5)<br>OBP: 0.306, SLG: 0.374            |  |  | 0-0<br>G4-6-3   |  | 4-0<br>BB<br>IBB  |   | 1-1<br>SH1-4  | 0-1<br>F9   |   | 2 0 0 0 1 0 1  |  |
| <b>Preacher Roe, R</b> (1, 1)<br>OBP: 0.155, SLG: 0.157         |  |  | 1-3<br>K  |  | 0-3<br>K  |   | 0-2<br>5-3  |   |   | 3 0 0 0 0 2 4  |  |
| <b>Inning Stats</b>   | R: 0<br>E: 0<br>K: 0<br>S: 9<br>H: 0<br>LOB: 0<br>BB: 1<br>P: 16   | R: 0<br>E: 0<br>K: 2<br>S: 7<br>H: 0<br>LOB: 0<br>BB: 0<br>P: 11 | R: 0<br>E: 0<br>K: 1<br>S: 6<br>H: 1<br>LOB: 0<br>BB: 0<br>P: 8 | R: 0<br>E: 0<br>K: 0<br>S: 8<br>H: 0<br>LOB: 1<br>BB: 1<br>P: 18 | R: 1<br>E: 0<br>K: 1<br>S: 11<br>H: 2<br>LOB: 3<br>BB: 2<br>P: 20 | R: 0<br>E: 0<br>K: 1<br>S: 10<br>H: 1<br>LOB: 1<br>BB: 0<br>P: 11 | R: 0<br>E: 0<br>K: 1<br>S: 10<br>H: 0<br>LOB: 1<br>BB: 1<br>P: 15 | R: 0<br>E: 0<br>K: 1<br>S: 10<br>H: 2<br>LOB: 2<br>BB: 0<br>P: 16 | R: 0<br>E: 0<br>K: 0<br>S: 5<br>H: 0<br>LOB: 0<br>BB: 0<br>P: 5 | 1B: 5<br>2B: 1<br>3B: 0<br>HR: 0<br>SF: 0<br>SAC: 2<br>DP: 1<br>HBP: 0 | WP: 0<br>PB: 0<br>SB: 1<br>CS: 1<br>PA: 36 |
| <b>PITCHER</b><br><b>Ewell Blackwell, R</b> (1, 1)<br>ERA: 3.62 | IP 9.0<br>WLS L<br>BF 35<br>H 6<br>R 1<br>ER 1<br>SO 7<br>BB 4<br>IBB 1<br>HBP 0<br>BLK 0<br>WP 0<br>HR 0<br>S 76<br>P 120<br>ERA 1.00<br>WHIP 1.111 |  |   |  |   |   | <b>PITCHER</b>  | IP WLS BF H R ER SO BB IBB HBP BLK WP HR S P ERA WHIP             |   |  |  |

**Brooklyn Dodgers @ Cincinnati Reds**  
Crosley Field, Cincinnati, OH  
Thu Aug 24 1950, 3:33 AM EDT  
Unknown

[livebaseballscorecards.com](http://livebaseballscorecards.com)

**AB 28**  
**R 1**  
**H 6**  
**RBI 1**  
**BB 5**  
**SO 7**  
**LOB 15**



| Batter  | 1                            | 2                                | 3                            | 4                               | 5                            | 6                               | 7                            | 8                                | 9                             | AB                               | R                             | H                                | RBI                          | BB                              | SO                           | LOB                              | BOTTOM  |                                  |                                  |                                    |                                  |          |        |        |         |         |         |          |          |          |         |         |         |         |             |               |
|---|------------------------------|----------------------------------|------------------------------|---------------------------------|------------------------------|---------------------------------|------------------------------|----------------------------------|-------------------------------|----------------------------------|-------------------------------|----------------------------------|------------------------------|---------------------------------|------------------------------|----------------------------------|---|----------------------------------|----------------------------------|------------------------------------|----------------------------------|----------|--------|--------|---------|---------|---------|----------|----------|----------|---------|---------|---------|---------|-------------|---------------|
| <b>Bobby Adams, R</b><br>OBP: 0.348, SLG: 0.387<br>(1, 5)       | 1-0<br>F6                    |                                  | 1-1<br>1B                    |                                 | 1-3<br>K                     |                                 |                              | 1-3<br>K                         |                               | 4                                | 0                             | 1                                | 0                            | 0                               | 2                            | 0                                | <b>Brooklyn Dodgers @ Cincinnati Reds</b><br>Crosley Field, Cincinnati, OH<br>Thu Aug 24 1950, 3:33 AM EDT<br>Unknown |                                  |                                  |                                    |                                  |          |        |        |         |         |         |          |          |          |         |         |         |         |             |               |
| <b>Bob Usher, R</b><br>OBP: 0.325, SLG: 0.382<br>(1, 8)         | 0-1<br>CS<br>1B              |                                  | 0-0<br>F3                    |                                 | 3-2<br>1B                    |                                 |                              | 0-0<br>F7                        |                               | 4                                | 0                             | 2                                | 0                            | 0                               | 0                            | 2                                |   |                                  |                                  |                                    |                                  |          |        |        |         |         |         |          |          |          |         |         |         |         |             |               |
| <b>Johnny Wyrostek, L</b><br>OBP: 0.394, SLG: 0.456<br>(1, 9)   | 4-1<br>1-2<br>BB             |                                  | 0-0<br>F9                    |                                 | 0-0<br>F6                    |                                 |                              | 3-3<br>K                         |                               | 3                                | 0                             | 0                                | 0                            | 1                               | 1                            | 3                                |   |                                  |                                  |                                    |                                  |          |        |        |         |         |         |          |          |          |         |         |         |         |             |               |
| <b>Ted Kluszewski, L</b><br>OBP: 0.361, SLG: 0.579<br>(1, 3)    | 0-0<br>1-3                   |                                  |                              | 1-1<br>4-3                      |                              |                                 |                              | 2-2<br>4-3                       |                               | 4                                | 0                             | 0                                | 0                            | 0                               | 0                            | 1                                |   |                                  |                                  |                                    |                                  |          |        |        |         |         |         |          |          |          |         |         |         |         |             |               |
| <b>Connie Ryan, R</b><br>OBP: 0.367, SLG: 0.384<br>(1, 4)       |                              | 3-1<br>5-3                       |                              | 0-0<br>1B                       |                              |                                 |                              | 2-3<br>K                         |                               | 4                                | 0                             | 1                                | 0                            | 0                               | 2                            | 0                                |   |                                  |                                  |                                    |                                  |          |        |        |         |         |         |          |          |          |         |         |         |         |             |               |
| <b>Joe Adcock, R</b><br>OBP: 0.309, SLG: 0.388<br>(1, 7)        |                              | 0-0<br>G6-4-3<br>1B              |                              | 0-0<br>F8                       |                              |                                 |                              | 0-1<br>F2                        |                               | 4                                | 0                             | 1                                | 0                            | 0                               | 0                            | 1                                |   |                                  |                                  |                                    |                                  |          |        |        |         |         |         |          |          |          |         |         |         |         |             |               |
| <b>Johnny Pramesa, R</b><br>OBP: 0.373, SLG: 0.447<br>(1, 2)    |                              | 1-1<br>G6-4-3                    |                              | 0-0<br>FC6-4<br>1B              |                              |                                 |                              | 0-0<br>B3-4<br>1B                |                               | 3                                | 0                             | 2                                | 0                            | 0                               | 0                            | 1                                |   |                                  |                                  |                                    |                                  |          |        |        |         |         |         |          |          |          |         |         |         |         |             |               |
| <b>Peanuts Lowrey, R</b><br>OBP: 0.324, SLG: 0.296<br>(7, PR)   |                              |                                  |                              | 1-3<br>1B                       |                              |                                 |                              |                                  |                               | 0                                | 0                             | 0                                | 0                            | 0                               | 0                            | 0                                |   |                                  |                                  |                                    |                                  |          |        |        |         |         |         |          |          |          |         |         |         |         |             |               |
| <b>Dixie Howell, R</b><br>OBP: 0.316, SLG: 0.270<br>(8, 2)      |                              | 1-2f                             |                              | 1-2<br>FC6-4<br>1B              |                              |                                 |                              |                                  |                               | 0                                | 0                             | 0                                | 0                            | 0                               | 0                            | 0                                |   |                                  |                                  |                                    |                                  |          |        |        |         |         |         |          |          |          |         |         |         |         |             |               |
| <b>Virgil Stallcup, R</b><br>OBP: 0.281, SLG: 0.349<br>(1, 6)   |                              |                                  | 0-0<br>1B                    |                                 | 1-2<br>FC6-4                 |                                 |                              | 0-0<br>B3-4                      |                               | 3                                | 0                             | 1                                | 0                            | 0                               | 0                            | 3                                |   |                                  |                                  |                                    |                                  |          |        |        |         |         |         |          |          |          |         |         |         |         |             |               |
| <b>Ewell Blackwell, R</b><br>OBP: 0.129, SLG: 0.076<br>(1, 1)   |                              |                                  | 0-3<br>K                     |                                 | 0-2<br>4-3                   |                                 |                              | 1-0<br>6-3                       |                               | 3                                | 0                             | 0                                | 0                            | 0                               | 1                            | 2                                |   |                                  |                                  |                                    |                                  |          |        |        |         |         |         |          |          |          |         |         |         |         |             |               |
| <b>Inning Stats</b>   | R: 0<br>E: 0<br>K: 0<br>S: 5 | H: 1<br>LOB: 1<br>BB: 1<br>P: 10 | R: 0<br>E: 0<br>K: 0<br>S: 5 | H: 1<br>LOB: 0<br>BB: 0<br>P: 9 | R: 0<br>E: 0<br>K: 1<br>S: 8 | H: 2<br>LOB: 2<br>BB: 0<br>P: 9 | R: 0<br>E: 0<br>K: 0<br>S: 9 | H: 2<br>LOB: 2<br>BB: 0<br>P: 11 | R: 0<br>E: 0<br>K: 1<br>S: 10 | H: 1<br>LOB: 1<br>BB: 0<br>P: 14 | R: 0<br>E: 0<br>K: 1<br>S: 10 | H: 0<br>LOB: 0<br>BB: 0<br>P: 14 | R: 0<br>E: 0<br>K: 0<br>S: 3 | H: 1<br>LOB: 1<br>BB: 0<br>P: 4 | R: 0<br>E: 0<br>K: 2<br>S: 7 | H: 0<br>LOB: 0<br>BB: 0<br>P: 11 | R: 0<br>E: 0<br>K: 1<br>S: 8  | H: 0<br>LOB: 0<br>BB: 0<br>P: 11 | 1B: 8<br>2B: 1<br>3B: 0<br>HR: 0 | SF: 0<br>SAC: 0<br>DP: 2<br>HBP: 0 | WP: 0<br>PB: 0<br>SB: 0<br>CS: 1 | PA: 33   |        |        |         |         |         |          |          |          |         |         |         |         |             |               |
| <b>PITCHER</b><br><b>Preacher Roe, L</b><br>ERA: 3.08<br>(1, 1) | IP<br>9.0                    | WLS<br>W                         | BF<br>33                     | H<br>8                          | R<br>0                       | ER<br>0                         | SO<br>6                      | BB<br>1                          | IBB<br>0                      | HBP<br>0                         | BLK<br>0                      | WP<br>0                          | HR<br>0                      | S<br>65                         | P<br>93                      | ERA<br>0.00                      | WHIP<br>1.000   | PITCHER                          |                                  | IP<br>9.0                          | WLS<br>W                         | BF<br>33 | H<br>8 | R<br>0 | ER<br>0 | SO<br>6 | BB<br>1 | IBB<br>0 | HBP<br>0 | BLK<br>0 | WP<br>0 | HR<br>0 | S<br>65 | P<br>93 | ERA<br>0.00 | WHIP<br>1.000 |

livebaseballscorecards.com

**AB 32**  
**R 0**  
**H 8**  
**RBI 0**  
**BB 1**  
**SO 6**  
**LOB 13**



| Batter   | 1   | 2                                | 3                            | 4                                | 5                            | 6                               | 7                             | 8                                | 9                            | AB R H RBI BB SO LOB             | TOP                           |                                  |                              |                                  |                              |                                  |                              |                                  |                                   |                                    |                                  |        |
|--|---|----------------------------------|------------------------------|----------------------------------|------------------------------|---------------------------------|-------------------------------|----------------------------------|------------------------------|----------------------------------|-------------------------------|----------------------------------|------------------------------|----------------------------------|------------------------------|----------------------------------|------------------------------|----------------------------------|-----------------------------------|------------------------------------|----------------------------------|--------|
| <b>Pee Wee Reese, R</b> (1, 6)<br>OBP: 0.363, SLG: 0.362   | 2-1<br>6-3  |                                  | 1-1<br>4-3                   | 4-2<br>1B                        |                              | 2-0<br>1B                       |                               | 1-1<br>F9                        |                              | 4 1 1 1 1 0 0                    |                               |                                  |                              |                                  |                              |                                  |                              |                                  |                                   |                                    |                                  |        |
| <b>Gene Hermanski, L</b> (1, 7)<br>OBP: 0.384, SLG: 0.503  | 2-1<br>1B   |                                  | 0-0<br>4-3                   | 1-2<br>4-3                       |                              | 4-1<br>1B                       |                               | 1-0<br>2B                        |                              | 4 1 2 0 1 0 3                    |                               |                                  |                              |                                  |                              |                                  |                              |                                  |                                   |                                    |                                  |        |
| <b>Duke Snider, L</b> (1, 8)<br>OBP: 0.376, SLG: 0.540     | 1-2<br>1B   |                                  | 0-0<br>4-3                   |                                  | 1-0<br>HR                    | 2-3<br>K                        |                               | 2-1<br>4-3                       |                              | 5 1 2 1 0 1 4                    |                               |                                  |                              |                                  |                              |                                  |                              |                                  |                                   |                                    |                                  |        |
| <b>Carl Furillo, R</b> (1, 9)<br>OBP: 0.363, SLG: 0.495    | 0-0<br>1B   |                                  |                              | 2-3<br>K                         | 2-1<br>F9                    | 3-2<br>1B                       |                               |                                  | 2-2<br>6-3                   | 5 0 2 3 0 1 0                    |                               |                                  |                              |                                  |                              |                                  |                              |                                  |                                   |                                    |                                  |        |
| <b>Gil Hodges, R</b> (1, 3)<br>OBP: 0.385, SLG: 0.499      | 0-2<br>G6-4-3   |                                  |                              | 1-1<br>F7                        | 1-2<br>1B                    | 2-1<br>F8                       |                               |                                  | 0-1<br>F9                    | 5 1 1 0 0 0 4                    |                               |                                  |                              |                                  |                              |                                  |                              |                                  |                                   |                                    |                                  |        |
| <b>Jackie Robinson, R</b> (1, 4)<br>OBP: 0.423, SLG: 0.510 |   |                                  | 4-2<br>WP                    | 1-1<br>1B                        | 3-0<br>1B                    |                                 | 2-0<br>4-3                    |                                  | 4-0<br>1B                    | 3 1 2 1 2 0 0                    |                               |                                  |                              |                                  |                              |                                  |                              |                                  |                                   |                                    |                                  |        |
| <b>Bruce Edwards, R</b> (1, 2)<br>OBP: 0.202, SLG: 0.360   |   |                                  | 2-0<br>F7                    | 4-2<br>1B                        | 0-0<br>F8                    |                                 | 1-2<br>L8                     |                                  | 0-0<br>1B                    | 4 1 1 0 1 0 1                    |                               |                                  |                              |                                  |                              |                                  |                              |                                  |                                   |                                    |                                  |        |
| <b>Billy Cox, R</b> (1, 5)<br>OBP: 0.307, SLG: 0.372       |   |                                  | 3-1<br>F5                    | 4-1<br>1B                        |                              | 1-0<br>1B                       | 1-2<br>6-3                    |                                  | 2-3<br>K                     | 4 0 1 0 1 1 3                    |                               |                                  |                              |                                  |                              |                                  |                              |                                  |                                   |                                    |                                  |        |
| <b>Joe Hatten, R</b> (1, 1)<br>OBP: 0.125, SLG: 0.125      |   |                                  | 2-3<br>K                     | 0-0<br>1B                        |                              | 0-2<br>1B                       |                               | 0-2<br>L3                        |                              | 4 1 1 1 0 1 2                    |                               |                                  |                              |                                  |                              |                                  |                              |                                  |                                   |                                    |                                  |        |
| <b>Inning Stats</b>  | R: 1<br>E: 0<br>K: 0<br>S: 12                         | H: 3<br>LOB: 1<br>BB: 0<br>P: 17 | R: 0<br>E: 0<br>K: 1<br>S: 8 | H: 0<br>LOB: 1<br>BB: 1<br>P: 19 | R: 0<br>E: 0<br>K: 0<br>S: 4 | H: 0<br>LOB: 0<br>BB: 0<br>P: 5 | R: 2<br>E: 0<br>K: 1<br>S: 19 | H: 2<br>LOB: 3<br>BB: 3<br>P: 36 | R: 2<br>E: 0<br>K: 0<br>S: 8 | H: 3<br>LOB: 0<br>BB: 0<br>P: 15 | R: 2<br>E: 0<br>K: 1<br>S: 15 | H: 3<br>LOB: 2<br>BB: 1<br>P: 29 | R: 0<br>E: 0<br>K: 0<br>S: 7 | H: 0<br>LOB: 0<br>BB: 0<br>P: 11 | R: 0<br>E: 0<br>K: 0<br>S: 9 | H: 1<br>LOB: 1<br>BB: 0<br>P: 13 | R: 0<br>E: 0<br>K: 1<br>S: 9 | H: 1<br>LOB: 2<br>BB: 1<br>P: 17 | 1B: 10<br>2B: 2<br>3B: 0<br>HR: 1 | SF: 0<br>SAC: 0<br>DP: 1<br>HBP: 0 | WP: 1<br>PB: 0<br>SB: 1<br>CS: 0 | PA: 44 |
| <b>PITCHER</b>   | IP WLS BF H R ER SO BB IBB HBP BLK WP HR S P ERA WHIP |                                  |                              |                                  |                              |                                 |                               |                                  |                              |                                  |                               |                                  |                              |                                  |                              |                                  |                              |                                  |                                   |                                    |                                  |        |
| <b>Herm Wehmeier, R</b> (1, 1)<br>ERA: 5.56                | 5.0 L 25 8 5 5 2 4 0 0 0 0 1 1 51 92 9.00 2.400       |                                  |                              |                                  |                              |                                 |                               |                                  |                              |                                  |                               |                                  |                              |                                  |                              |                                  |                              |                                  |                                   |                                    |                                  |        |
| <b>Howie Fox, R</b> (6, 1)<br>ERA: 5.18                    | 3.0 14 4 2 2 1 1 0 0 0 0 0 0 31 53 6.00 1.667         |                                  |                              |                                  |                              |                                 |                               |                                  |                              |                                  |                               |                                  |                              |                                  |                              |                                  |                              |                                  |                                   |                                    |                                  |        |
| <b>Eddie Erault, R</b> (9, 1)<br>ERA: 8.03                 | 1.0 5 1 0 0 1 1 0 0 0 0 0 0 9 17 0.00 2.000           |                                  |                              |                                  |                              |                                 |                               |                                  |                              |                                  |                               |                                  |                              |                                  |                              |                                  |                              |                                  |                                   |                                    |                                  |        |

**Brooklyn Dodgers @ Cincinnati Reds**  
 Crosley Field, Cincinnati, OH  
 Thu Aug 24 1950, 3:38 AM EDT  
 Att: 14,196 - Unknown

[livebaseballscorecards.com](http://livebaseballscorecards.com)

|     |    |
|-----|----|
| AB  | 38 |
| R   | 7  |
| H   | 13 |
| RBI | 7  |
| BB  | 6  |
| SO  | 4  |
| LOB | 17 |



| Batter  | 1               | 2               | 3  | 4                                   | 5                            | 6               | 7                               | 8                            | 9              | AB | R | H | RBI | BB | SO | LOB |
|---|-----------------|-----------------|--|-------------------------------------|------------------------------|-----------------|---------------------------------|------------------------------|----------------|----|---|---|-----|----|----|-----|
| <b>Bobby Adams, R</b><br>OBP: 0.351, SLG: 0.397 (1, 5)<br>FC<br>B<br>X    | 1-2<br>5-3<br>① |                 | 2-1<br>FC6-4<br>2-H<br>1B<br>B<br>F<br>X |                                     | 0-0<br>FC5-4<br>1-2f<br>X    |                 |                                 | 0-0<br>6-3<br>1-H<br>3B<br>X |                | 4  | 1 | 2 | 2   | 0  | 0  | 1   |
| <b>Bob Usher, R</b><br>OBP: 0.320, SLG: 0.376 (1, 8)<br>X                 | 0-0<br>F9<br>②  |                 | 1-0<br>FC6-4<br>1-2f<br>B<br>X           |                                     |                              | 1-0<br>6-3<br>① |                                 | 0-1<br>6-3<br>②              |                | 4  | 0 | 0 | 1   | 0  | 0  | 1   |
| <b>Johnny Wyrostek, L</b><br>OBP: 0.390, SLG: 0.451 (1, 9)<br>F<br>B<br>X | 1-1<br>4-3<br>③ |                 |  | 0-0<br>F8<br>①                      |                              | 0-0<br>4-3<br>② |                                 | 2-0<br>F9<br>③               |                | 4  | 0 | 0 | 0   | 0  | 0  | 0   |
| <b>Ted Kluszewski, L</b><br>OBP: 0.357, SLG: 0.573 (1, 3)<br>B<br>X       |                 | 1-0<br>6-3<br>① |  | 3-1<br>4-3<br>②                     |                              | 0-1<br>4-3<br>③ |                                 |                              | 1-2<br>F5<br>① | 4  | 0 | 0 | 0   | 0  | 0  | 0   |
| <b>Connie Ryan, R</b><br>OBP: 0.368, SLG: 0.385 (1, 4)<br>B<br>X          |                 | 1-0<br>5-3<br>② |  | 0-2<br>FC5-4<br>1B<br>F<br>F<br>X   |                              |                 | 0-0<br>G6-4-3<br>1B<br>X        |                              | 2-2<br>L7<br>② | 4  | 0 | 2 | 0   | 0  | 0  | 0   |
| <b>Joe Adcock, R</b><br>OBP: 0.308, SLG: 0.386 (1, 7)<br>B<br>B<br>X      |                 | 2-0<br>6-3<br>③ |  | 1-1<br>FC5-4<br>1-2f<br>B<br>C<br>X |                              |                 | 1-0<br>G6-4-3<br>1-2f<br>B<br>X |                              | 2-2<br>1B<br>② | 4  | 0 | 1 | 0   | 0  | 0  | 2   |
| <b>Virgil Stallcup, R</b><br>OBP: 0.278, SLG: 0.345 (1, 6)<br>X           |                 |                 | 0-0<br>6-3<br>①                          |                                     | 2-2<br>6-3<br>①              |                 | 1-2<br>F7<br>③                  |                              | 1-0<br>L7<br>③ | 4  | 0 | 0 | 0   | 0  | 0  | 1   |
| <b>Dixie Howell, R</b><br>OBP: 0.326, SLG: 0.283 (1, 2)<br>C<br>X         |                 |                 | 0-1<br>E9<br>1B<br>1B<br>C<br>X          |                                     | 0-1<br>FC5-4<br>1B<br>C<br>X |                 |                                 | 0-0<br>3B<br>1B<br>X         |                | 3  | 2 | 3 | 0   | 0  | 0  | 0   |
| <b>Herm Wehmeier, R</b><br>OBP: 0.185, SLG: 0.213 (1, 1)                  |                 |                 | 0-0<br>F9<br>②                           |                                     | 1-1<br>F4<br>②               |                 |                                 | 1-3<br>K<br>①                |                | 1  | 0 | 0 | 0   | 0  | 0  | 1   |
| <b>Peanuts Lowrey, R</b><br>OBP: 0.323, SLG: 0.295 (5, PH)                |                 |                 |  |                                     |                              |                 |                                 |                              |                | 1  | 0 | 0 | 0   | 0  | 0  | 1   |
| <b>Howie Fox, R</b><br>OBP: 0.225, SLG: 0.325 (6, 1)                      |                 |                 |  |                                     |                              |                 |                                 |                              |                | 0  | 0 | 0 | 0   | 0  | 0  | 0   |
| <b>Danny Litwhiler, R</b><br>OBP: 0.376, SLG: 0.474 (8, PH)               |                 |                 |  |                                     |                              |                 |                                 |                              |                | 1  | 0 | 0 | 0   | 0  | 1  | 1   |
| <b>Eddie Erault, R</b><br>OBP: 0.286, SLG: 0.429 (9, 1)                   |                 |                 |  |                                     |                              |                 |                                 |                              |                | 0  | 0 | 0 | 0   | 0  | 0  | 0   |

|                     |                              |                                 |                              |                                 |                              |                                  |                              |                                  |                              |                                  |                              |                                 |                              |                                 |                              |                                  |                               |                                  |                                  |                                    |                                  |        |
|---------------------|------------------------------|---------------------------------|------------------------------|---------------------------------|------------------------------|----------------------------------|------------------------------|----------------------------------|------------------------------|----------------------------------|------------------------------|---------------------------------|------------------------------|---------------------------------|------------------------------|----------------------------------|-------------------------------|----------------------------------|----------------------------------|------------------------------------|----------------------------------|--------|
| <b>Inning Stats</b> | R: 0<br>E: 0<br>K: 0<br>S: 6 | H: 0<br>LOB: 0<br>BB: 0<br>P: 8 | R: 0<br>E: 0<br>K: 0<br>S: 3 | H: 0<br>LOB: 0<br>BB: 0<br>P: 7 | R: 1<br>E: 1<br>K: 0<br>S: 7 | H: 2<br>LOB: 1<br>BB: 0<br>P: 10 | R: 0<br>E: 0<br>K: 0<br>S: 8 | H: 1<br>LOB: 1<br>BB: 0<br>P: 12 | R: 0<br>E: 0<br>K: 0<br>S: 8 | H: 1<br>LOB: 1<br>BB: 0<br>P: 11 | R: 0<br>E: 0<br>K: 0<br>S: 4 | H: 0<br>LOB: 0<br>BB: 0<br>P: 5 | R: 0<br>E: 0<br>K: 0<br>S: 5 | H: 1<br>LOB: 0<br>BB: 0<br>P: 7 | R: 2<br>E: 0<br>K: 1<br>S: 9 | H: 2<br>LOB: 0<br>BB: 0<br>P: 12 | R: 0<br>E: 0<br>K: 0<br>S: 11 | H: 1<br>LOB: 1<br>BB: 0<br>P: 17 | 1B: 7<br>2B: 0<br>3B: 1<br>HR: 0 | SF: 0<br>SAC: 0<br>DP: 1<br>HBP: 0 | WP: 0<br>PB: 0<br>SB: 0<br>CS: 0 | PA: 34 |
|---------------------|------------------------------|---------------------------------|------------------------------|---------------------------------|------------------------------|----------------------------------|------------------------------|----------------------------------|------------------------------|----------------------------------|------------------------------|---------------------------------|------------------------------|---------------------------------|------------------------------|----------------------------------|-------------------------------|----------------------------------|----------------------------------|------------------------------------|----------------------------------|--------|

|  |           |          |          |        |        |         |         |         |          |          |          |         |         |         |         |             |               |                |    |     |    |   |   |    |    |    |     |     |     |    |    |   |   |     |      |
|--|-----------|----------|----------|--------|--------|---------|---------|---------|----------|----------|----------|---------|---------|---------|---------|-------------|---------------|----------------|----|-----|----|---|---|----|----|----|-----|-----|-----|----|----|---|---|-----|------|
| <b>PITCHER</b><br><b>Joe Hatten, L</b><br>ERA: 4.82 (1, 1) | IP<br>9.0 | WLS<br>W | BF<br>34 | H<br>8 | R<br>3 | ER<br>2 | SO<br>1 | BB<br>0 | IBB<br>0 | HBP<br>0 | BLK<br>0 | WP<br>0 | HR<br>0 | S<br>61 | P<br>89 | ERA<br>2.00 | WHIP<br>0.889 | <b>PITCHER</b> | IP | WLS | BF | H | R | ER | SO | BB | IBB | HBP | BLK | WP | HR | S | P | ERA | WHIP |
|--|-----------|----------|----------|--------|--------|---------|---------|---------|----------|----------|----------|---------|---------|---------|---------|-------------|---------------|----------------|----|-----|----|---|---|----|----|----|-----|-----|-----|----|----|---|---|-----|------|

**BOTTOM**

**Brooklyn Dodgers @ Cincinnati Reds**  
Crosley Field, Cincinnati, OH

Thu Aug 24 1950, 3:38 AM EDT  
Att. 14,196 - Unknown

|            |           |
|------------|-----------|
| <b>AB</b>  | <b>34</b> |
| <b>R</b>   | <b>3</b>  |
| <b>H</b>   | <b>8</b>  |
| <b>RBI</b> | <b>3</b>  |
| <b>BB</b>  | <b>0</b>  |
| <b>SO</b>  | <b>1</b>  |
| <b>LOB</b> | <b>8</b>  |



| Batter   | 1   | 2   | 3  | 4   | 5  | 6   | 7   | 8  | 9   | AB R H RBI BB SO LOB                                       | TOP                                     |
|--|---|---|--|---|--|---|---|--|---|--|---|
| <b>Pee Wee Reese, R</b> (1, 6)<br>OBP: 0.364, SLG: 0.370   | 2-1<br>6-3  |   | 2-3<br>K   |   | 0-0<br>HR  |   | 0-2<br>1B BB  |  | 1-3<br>K  | 5 1 2 1 0 2 0  |   |
| <b>Gene Hermanski, L</b> (1, 7)<br>OBP: 0.384, SLG: 0.498  | 4-0<br>CS BB  |   | 1-2<br>G3  |   | 3-2<br>F8  |   | 1-3<br>K  |  | 3-1<br>2B 1B  | 4 1 1 0 1 1 2  |   |
| <b>Duke Snider, L</b> (1, 8)<br>OBP: 0.378, SLG: 0.542     | 3-2<br>F5   |   |  | 1-0<br>FC6-4 BB<br>F9 1B                              | 0-1<br>F5  |   | 4-1<br>1B BB  |  | 1-2<br>2B 1-H   | 4 1 2 1 1 0 1  |   |
| <b>Carl Furillo, R</b> (1, 9)<br>OBP: 0.363, SLG: 0.492    | 3-2<br>CS 1-2   | 0-3<br>K  |  | 4-1<br>FC6-4 BB                                       |  | 1-0<br>F2   | 2-1<br>1B BB  |  | 3-1<br>6-3  | 4 0 1 1 1 1 1  |   |
| <b>Gil Hodges, R</b> (1, 3)<br>OBP: 0.384, SLG: 0.496      |   |   |  | 1-2<br>FC6-4 S  |  | 1-2<br>F3   | 0-1<br>F8   |  |   | 4 1 1 0 0 0 5  |   |
| <b>Roy Campanella, R</b> (1, 2)<br>OBP: 0.378, SLG: 0.553  |   |   |  | 0-2<br>F9 3-H   |  | 0-0<br>FC5-4 1B                                     |   | 2-1<br>6-3   |   | 4 0 1 1 0 1 2  |   |
| <b>Jackie Robinson, R</b> (1, 4)<br>OBP: 0.424, SLG: 0.516 |   |   |  | 4-2<br>1-2 BB   |  | 1-0<br>FC5-4 1-2f                                   |   | 1-1<br>F9  |   | 3 1 1 2 1 0 1  |   |
| <b>Billy Cox, R</b> (1, 5)<br>OBP: 0.306, SLG: 0.369       |   |   |  | 0-0<br>F3   |  |   | 2-2<br>4-3  |  | 4-1<br>CS BB  | 3 0 0 0 1 0 2  |   |
| <b>Don Newcombe, L</b> (1, 1)<br>OBP: 0.342, SLG: 0.348    |   |   |  | 0-1<br>G3   |  | 0-1<br>4-3  |   | 0-1<br>CS 1-2  | 0-1<br>B1-3   | 3 1 0 0 1 0 0  |   |
| <b>Inning Stats</b>  | R: 0 H: 0<br>E: 0 LOB: 0<br>K: 0 BB: 1<br>S: 9 P: 20  | R: 2 H: 2<br>E: 0 LOB: 0<br>K: 2 BB: 0<br>S: 13 P: 18 | R: 0 H: 0<br>E: 0 LOB: 0<br>K: 1 BB: 0<br>S: 9 P: 12 | R: 1 H: 1<br>E: 0 LOB: 2<br>K: 0 BB: 2<br>S: 13 P: 23 | R: 1 H: 1<br>E: 0 LOB: 0<br>K: 0 BB: 0<br>S: 8 P: 11 | R: 0 H: 1<br>E: 0 LOB: 1<br>K: 0 BB: 0<br>S: 6 P: 9 | R: 1 H: 2<br>E: 0 LOB: 3<br>K: 1 BB: 2<br>S: 15 P: 28 | R: 0 H: 0<br>E: 0 LOB: 0<br>K: 0 BB: 1<br>S: 6 P: 13 | R: 1 H: 2<br>E: 0 LOB: 1<br>K: 1 BB: 0<br>S: 13 P: 21 | 1B: 6 SF: 0<br>2B: 1 SAC: 0<br>3B: 0 DP: 0<br>HR: 2 HBP: 0 | WP: 0 PA: 42<br>PB: 0<br>SB: 1<br>CS: 2 |
| <b>PITCHER</b>   | IP WLS BF H R ER SO BB IBB HBP BLK WP HR S P ERA WHIP |   |  |   |  |   |   |  |   |  |   |
| <b>Frank Smith, R</b> (1, 1)<br>ERA: 3.53                  | 6.0 L 25 5 4 4 3 3 0 0 0 0 0 2 58 93 6.00 1.333       |   |  |   |  |   |   |  |   |  |   |
| <b>Willie Ramsdell, R</b> (7, 1)<br>ERA: 3.74              | 0.0 0 0 0 0 0 0 0 0 0 0 0 0 0 0 0 0 0                 |   |  |   |  |   |   |  |   |  |   |

**Brooklyn Dodgers @ Cincinnati Reds**  
Crosley Field, Cincinnati, OH

Fri Aug 25 1950, 3:33 AM EDT  
Att. 8,152 - Unknown

[livebaseballscorecards.com](http://livebaseballscorecards.com)

**AB 34**  
**R 6**  
**H 9**  
**RBI 6**  
**BB 6**  
**SO 5**  
**LOB 14**



| Batter  | 1          | 2                | 3          | 4                      | 5         | 6                  | 7         | 8          | 9             | AB R H RBI BB SO LOB |
|---|------------|------------------|------------|------------------------|-----------|--------------------|-----------|------------|---------------|----------------------|
| Lloyd Merriman, L (1, 8)<br>OBP: 0.331, SLG: 0.346  | 3-1<br>6-3 |                  |            | 0-0<br>G3-6-1 1B       |           | 3-1<br>6-3         |           |            | 0-0<br>F6     | 4 0 1 0 0 0 0        |
| Grady Hatton, L (1, 5)<br>OBP: 0.364, SLG: 0.404    | 1-1<br>F7  |                  |            | 1-1<br>G3-6-1 1B       |           |                    | 1-1<br>1B |            | 0-0<br>1B 1B  | 4 0 3 0 0 0 0        |
| Johnny Wyrostek, L (1, 9)<br>OBP: 0.389, SLG: 0.449 | 0-0<br>1-3 |                  |            | 3-1<br>G3-6-1 1-2f 2-3 |           |                    | 1-3<br>K  |            | 2-1<br>1B 1-3 | 4 0 1 0 0 1 3        |
| Ted Kluszewski, L (1, 3)<br>OBP: 0.356, SLG: 0.570  |            | 1-0<br>G6-3 1B   |            | 0-0<br>G3              |           |                    | 0-0<br>F3 |            | 1-0<br>F7     | 4 0 1 0 0 0 4        |
| Connie Ryan, R (1, 4)<br>OBP: 0.366, SLG: 0.382     |            | 0-3<br>K         |            |                        | 0-3<br>K  |                    | 0-0<br>F3 |            |               | 3 0 0 0 0 2 2        |
| Joe Adcock, R (1, 7)<br>OBP: 0.304, SLG: 0.381      |            | 1-2<br>G6-3 1-2f |            |                        | 3-3<br>K  |                    |           | 0-0<br>L7  |               | 3 0 0 0 0 1 1        |
| Johnny Pramesa, R (1, 2)<br>OBP: 0.367, SLG: 0.439  |            |                  | 0-0<br>F3  |                        | 0-0<br>L7 |                    |           | 3-1<br>6-3 |               | 3 0 0 0 0 0 0        |
| Virgil Stallcup, R (1, 6)<br>OBP: 0.278, SLG: 0.345 |            |                  | 0-0<br>5-3 |                        |           | 0-2<br>G4-6-3 1B   |           | 0-0<br>5-3 |               | 3 0 1 0 0 0 0        |
| Frank Smith, R (1, 1)<br>OBP: 0.063, SLG: 0.063     |            |                  | 0-1<br>6-3 |                        |           | 2-2<br>G4-6-3 1-2f |           |            | 1-3<br>K      | 1 0 0 0 0 0 0        |
| Peanuts Lowrey, R (6, PH)<br>OBP: 0.322, SLG: 0.294 |            |                  |            |                        |           |                    |           |            |               | 1 0 0 0 0 0 1        |
| Willie Ramsdell, R (7, 1)<br>OBP: 0.277, SLG: 0.209 |            |                  |            |                        |           |                    |           |            |               | 0 0 0 0 0 0 0        |
| Bobby Adams, R (9, PH)<br>OBP: 0.349, SLG: 0.396    |            |                  |            |                        |           |                    |           |            |               | 1 0 0 0 0 1 0        |

| Inning Stats                                   | R: 0    | H: 0   | E: 0   | K: 0 | S: 5 | R: 0  | H: 1  | E: 0  | K: 1   | S: 9   | R: 0   | H: 0  | E: 0  | K: 0  | S: 4  | R: 0      | H: 2        | E: 0 | K: 0 | S: 6 | R: 0 | H: 0 | E: 0 | K: 2 | S: 8 | R: 0 | H: 1 | E: 0 | K: 1    | S: 8   | R: 0   | H: 0 | E: 0 | K: 0  | S: 4  | R: 0  | H: 0   | E: 0   | K: 0   | S: 7  | R: 0  | H: 0  | E: 0  | K: 0      | S: 4        | R: 0 | H: 2 | E: 0 | K: 1 | S: 8 | 1B: 7 | 2B: 0 | 3B: 0 | HR: 0 | SF: 0 | SAC: 0 | DP: 3 | HBP: 0 | WP: 0 | PA: 31 |
|--|---------|--------|--------|------|------|-------|-------|-------|--------|--------|--------|-------|-------|-------|-------|-----------|-------------|------|------|------|------|------|------|------|------|------|------|------|---------|--------|--------|------|------|-------|-------|-------|--------|--------|--------|-------|-------|-------|-------|-----------|-------------|------|------|------|------|------|-------|-------|-------|-------|-------|--------|-------|--------|-------|--------|
| PITCHER<br>Don Newcombe, R (1, 1)<br>ERA: 4.06 | IP: 9.0 | WLS: W | BF: 31 | H: 7 | R: 0 | ER: 0 | SO: 5 | BB: 0 | IBB: 0 | HBP: 0 | BLK: 0 | WP: 0 | HR: 0 | S: 59 | P: 86 | ERA: 0.00 | WHIP: 0.778 |      |      |      |      |      |      |      |      |      |      |      |         |        |        |      |      |       |       |       |        |        |        |       |       |       |       |           |             |      |      |      |      |      |       |       |       |       |       |        |       |        |       |        |
| PITCHER  |         |        |        |      |      |       |       |       |        |        |        |       |       |       |       |           |             |      |      |      |      |      |      |      |      |      |      |      | IP: 9.0 | WLS: W | BF: 31 | H: 7 | R: 0 | ER: 0 | SO: 5 | BB: 0 | IBB: 0 | HBP: 0 | BLK: 0 | WP: 0 | HR: 0 | S: 59 | P: 86 | ERA: 0.00 | WHIP: 0.778 |      |      |      |      |      |       |       |       |       |       |        |       |        |       |        |

**BOTTOM**

**Brooklyn Dodgers @ Cincinnati Reds**  
Crosley Field, Cincinnati, OH

Fri Aug 25 1950, 3:33 AM EDT  
Att. 8,152 - Unknown

AB 31  
R 0  
H 7  
RBI 0  
BB 0  
SO 5  
LOB 11

livebaseballscorecards.com



| Batter   | 1   | 2                                | 3                             | 4                                | 5                            | 6                               | 7                            | 8                                | 9                             | AB R H RBI BB SO LOB             | TOP                           |                                  |                               |                                  |                              |                                  |                                  |                                    |                                  |        |
|--|---|----------------------------------|-------------------------------|----------------------------------|------------------------------|---------------------------------|------------------------------|----------------------------------|-------------------------------|----------------------------------|-------------------------------|----------------------------------|-------------------------------|----------------------------------|------------------------------|----------------------------------|----------------------------------|------------------------------------|----------------------------------|--------|
| <b>Pee Wee Reese, R</b> (1, 6)<br>OBP: 0.362, SLG: 0.368                               | 0-1<br>F4   |                                  | 2-2<br>6-3                    |                                  | 1-1<br>F7                    |                                 | 0-3<br>K                     | 0-0<br>2-H<br>1B                 |                               | 5 0 1 1 0 1 1                    |                               |                                  |                               |                                  |                              |                                  |                                  |                                    |                                  |        |
| <b>Jim Russell, S</b> (1, 7)<br>OBP: 0.340, SLG: 0.443                                 | 4-1<br>E  |                                  | 0-0<br>L6                     |                                  | 0-1<br>F2                    |                                 | 0-0<br>L7                    | 2-3<br>K                         |                               | 2 0 0 0 1 0 0                    |                               |                                  |                               |                                  |                              |                                  |                                  |                                    |                                  |        |
| <b>Cal Abrams, L</b> (6, 7)<br><b>Tommy Brown, R</b> (7, PH)<br>OBP: 0.323, SLG: 0.586 | BB  |                                  |                               |                                  |                              |                                 |                              |                                  |                               | 0 0 0 0 0 0 0                    |                               |                                  |                               |                                  |                              |                                  |                                  |                                    |                                  |        |
| <b>Gene Hermanski, L</b> (7, 7)<br>OBP: 0.382, SLG: 0.495                              |   |                                  |                               |                                  |                              |                                 |                              |                                  |                               | 1 0 0 0 0 0 1                    |                               |                                  |                               |                                  |                              |                                  |                                  |                                    |                                  |        |
| <b>Duke Snider, L</b> (1, 8)<br>OBP: 0.379, SLG: 0.540                                 | 0-0<br>E7   |                                  | 2-0<br>F6                     |                                  | 1-1<br>F9                    |                                 | 0-0<br>1-3<br>1B             |                                  | 4-1<br>FC1-5<br>SH3<br>BB     | 4 0 1 0 1 0 1                    |                               |                                  |                               |                                  |                              |                                  |                                  |                                    |                                  |        |
| <b>Jackie Robinson, R</b> (1, 4)<br>OBP: 0.422, SLG: 0.513                             | 0-2<br>G5-4-3   |                                  |                               | 2-0<br>6-3                       | 1-1<br>1B                    |                                 | 0-0<br>F9                    |                                  | 1-0<br>SH3                    | 4 0 1 0 0 0 4                    |                               |                                  |                               |                                  |                              |                                  |                                  |                                    |                                  |        |
| <b>Carl Furillo, R</b> (1, 9)<br>OBP: 0.361, SLG: 0.489                                |   | 0-1<br>F6                        |                               | 1-0<br>1-4-3                     | 0-0<br>1B                    |                                 |                              | 1-1<br>F6                        | 2-2<br>FC1-5                  | 5 0 1 0 0 0 1                    |                               |                                  |                               |                                  |                              |                                  |                                  |                                    |                                  |        |
| <b>Gil Hodges, R</b> (1, 3)<br>OBP: 0.387, SLG: 0.496                                  |   | 4-0<br>HR                        |                               | 0-0<br>HR                        | 1-3<br>K                     |                                 |                              | 1-0<br>HR                        | 0-2<br>F7                     | 4 3 2 0 1 1 3                    |                               |                                  |                               |                                  |                              |                                  |                                  |                                    |                                  |        |
| <b>Roy Campanella, R</b> (1, 2)<br>OBP: 0.384, SLG: 0.583                              |   | 0-2<br>HR                        |                               | 0-1<br>HR                        | 4-2<br>BB                    |                                 |                              | 0-0<br>HR                        |                               | 3 3 3 6 1 0 0                    |                               |                                  |                               |                                  |                              |                                  |                                  |                                    |                                  |        |
| <b>Bobby Morgan, R</b> (1, 5)<br>OBP: 0.347, SLG: 0.415                                |   | 1-2<br>5-3                       |                               | 2-1<br>4-3                       | 1-0<br>F3                    |                                 |                              | 0-1<br>E3                        | SH1-4<br>1B                   | 4 1 0 0 0 0 3                    |                               |                                  |                               |                                  |                              |                                  |                                  |                                    |                                  |        |
| <b>Erv Palica, R</b> (1, 1)<br>OBP: 0.238, SLG: 0.310                                  |   | 0-1<br>L4                        |                               |                                  | 0-0<br>1-3                   |                                 |                              | 0-0<br>SH1-4                     |                               | 3 0 1 0 0 0 0                    |                               |                                  |                               |                                  |                              |                                  |                                  |                                    |                                  |        |
| <b>Ralph Branca, R</b> (9, 1)<br>OBP: 0.212, SLG: 0.310                                |   |                                  |                               |                                  |                              |                                 |                              | 1-2<br>1B                        |                               | 0 0 0 0 0 0 0                    |                               |                                  |                               |                                  |                              |                                  |                                  |                                    |                                  |        |
| <b>Inning Stats</b>  | R: 0<br>E: 1<br>K: 0<br>S: 7                          | H: 0<br>LOB: 1<br>BB: 1<br>P: 11 | R: 2<br>E: 0<br>K: 0<br>S: 10 | H: 1<br>LOB: 0<br>BB: 1<br>P: 15 | R: 0<br>E: 0<br>K: 0<br>S: 5 | H: 0<br>LOB: 0<br>BB: 0<br>P: 9 | R: 2<br>E: 0<br>K: 0<br>S: 7 | H: 2<br>LOB: 0<br>BB: 0<br>P: 12 | R: 0<br>E: 0<br>K: 1<br>S: 13 | H: 2<br>LOB: 3<br>BB: 1<br>P: 21 | R: 0<br>E: 0<br>K: 1<br>S: 10 | H: 2<br>LOB: 2<br>BB: 0<br>P: 13 | R: 3<br>E: 1<br>K: 1<br>S: 11 | H: 3<br>LOB: 1<br>BB: 0<br>P: 15 | R: 0<br>E: 0<br>K: 0<br>S: 8 | H: 0<br>LOB: 1<br>BB: 1<br>P: 15 | 1B: 7<br>2B: 0<br>3B: 0<br>HR: 3 | SF: 0<br>SAC: 2<br>DP: 1<br>HBP: 0 | WP: 0<br>PB: 0<br>SB: 0<br>CS: 0 | PA: 42 |
| <b>PITCHER</b>   | IP WLS BF H R ER SO BB IBB HBP BLK WP HR S P ERA WHIP |                                  |                               |                                  |                              |                                 |                              |                                  |                               |                                  |                               |                                  |                               |                                  |                              |                                  |                                  |                                    |                                  |        |
| <b>Ken Raffensberger, L</b> (1, 1)<br>ERA: 3.97  | 8.0 L 38 10 7 6 3 3 0 0 0 0 0 3 68 102 6.75 1.625     |                                  |                               |                                  |                              |                                 |                              |                                  |                               |                                  |                               |                                  |                               |                                  |                              |                                  |                                  |                                    |                                  |        |
| <b>Eddie ERAutt, R</b> (9, 1)<br>ERA: 7.82   | 1.0 4 0 0 0 0 1 0 0 0 0 0 0 8 15 0.00 1.000           |                                  |                               |                                  |                              |                                 |                              |                                  |                               |                                  |                               |                                  |                               |                                  |                              |                                  |                                  |                                    |                                  |        |

**Brooklyn Dodgers @ Cincinnati Reds**  
 Crosley Field, Cincinnati, OH  
 Sat Aug 26 1950, 3:33 AM EDT  
 Att. 6,229 - Unknown

|     |    |
|-----|----|
| AB  | 36 |
| R   | 7  |
| H   | 10 |
| RBI | 7  |
| BB  | 4  |
| SO  | 3  |
| LOB | 15 |



[livebaseballscorecards.com](http://livebaseballscorecards.com)



| Batter  | 1                                     | 2                                | 3                            | 4                                | 5                            | 6                                | 7                             | 8                                | 9                             | AB                               | R                            | H                               | RBI                           | BB                               | SO                           | LOB                              |                                   |                                       |                                  |                    |             |
|---|---------------------------------------|----------------------------------|------------------------------|----------------------------------|------------------------------|----------------------------------|-------------------------------|----------------------------------|-------------------------------|----------------------------------|------------------------------|---------------------------------|-------------------------------|----------------------------------|------------------------------|----------------------------------|-----------------------------------|---------------------------------------|----------------------------------|--------------------|-------------|
| Lloyd Merriman, L (1, 8)<br>OBP: 0.332, SLG: 0.347    | 1-1<br>HBP<br>1B                      | 2-1<br>F6                        |                              |                                  | 0-0<br>1B                    |                                  | 0-0<br>B3-1                   |                                  | 3-2<br>F8                     | 5                                | 1                            | 2                               | 0                             | 0                                | 0                            | 0                                |                                   |                                       |                                  |                    |             |
| Grady Hatton, L (1, 5)<br>OBP: 0.367, SLG: 0.403      | 2-0<br>1B<br>1-2<br>F8<br>HBP         |                                  | 0-0<br>F5                    |                                  | 0-3<br>K                     |                                  | 3-2<br>1B                     |                                  | 4-0<br>1B<br>BB               | 3                                | 1                            | 1                               | 0                             | 1                                | 1                            | 1                                |                                   |                                       |                                  |                    |             |
| Johnny Wyrostek, L (1, 9)<br>OBP: 0.386, SLG: 0.445   | 3-2<br>1B<br>1-3<br>2-H               |                                  | 3-3<br>K                     |                                  | 2-2<br>F8                    |                                  | 0-0<br>G3                     |                                  | 1-0<br>F4                     | 5                                | 0                            | 1                               | 1                             | 0                                | 1                            | 3                                |                                   |                                       |                                  |                    |             |
| Ted Kluszewski, L (1, 3)<br>OBP: 0.359, SLG: 0.569    | 0-2<br>F8<br>3-H                      |                                  | 4-0<br>FC5-4<br>BB           |                                  | 1-2<br>4-3                   |                                  |                               | 2-1<br>G5-4-3<br>1B              | 1-0<br>1B<br>1-3              | 4                                | 0                            | 2                               | 1                             | 1                                | 0                            | 1                                |                                   |                                       |                                  |                    |             |
| Connie Ryan, R (1, 4)<br>OBP: 0.361, SLG: 0.377       | 0-3<br>K<br>1-2f                      |                                  | 1-2<br>FC5-4                 |                                  |                              | 1-2<br>6-3                       |                               | 1-1<br>G5-4-3<br>1-2f            | 0-0<br>F4                     | 5                                | 0                            | 0                               | 0                             | 0                                | 1                            | 4                                |                                   |                                       |                                  |                    |             |
| Joe Adcock, R (1, 7)<br>OBP: 0.303, SLG: 0.383        |                                       | 1-1<br>5-3                       |                              | 1-1<br>F2                        |                              | 0-1<br>5-3                       |                               | 0-0<br>1B<br>2B                  |                               | 4                                | 1                            | 1                               | 0                             | 0                                | 0                            | 0                                |                                   |                                       |                                  |                    |             |
| Johnny Pramesa, R (1, 2)<br>OBP: 0.382, SLG: 0.459    |                                       | 3-1<br>HR<br>1B                  |                              | 1-1<br>1B                        |                              | 0-1<br>2B                        |                               | 2-0<br>1B                        |                               | 4                                | 1                            | 4                               | 0                             | 0                                | 0                            | 0                                |                                   |                                       |                                  |                    |             |
| Bobby Adams, R (8, PR)<br>OBP: 0.349, SLG: 0.396      |                                       |                                  |                              |                                  |                              |                                  |                               | 2-3<br>1B                        |                               | 0                                | 0                            | 0                               | 0                             | 0                                | 0                            | 0                                |                                   |                                       |                                  |                    |             |
| Dixie Howell, R (9, 2)<br>OBP: 0.326, SLG: 0.283      |                                       |                                  |                              |                                  |                              |                                  |                               |                                  |                               | 0                                | 0                            | 0                               | 0                             | 0                                | 0                            | 0                                |                                   |                                       |                                  |                    |             |
| Virgil Stallcup, R (1, 6)<br>OBP: 0.281, SLG: 0.355   |                                       | 0-0<br>HR                        |                              | 0-2<br>L7                        |                              | 0-2<br>6-3                       |                               | 2-0<br>1B                        |                               | 4                                | 1                            | 2                               | 3                             | 0                                | 0                            | 2                                |                                   |                                       |                                  |                    |             |
| Ken Raffensberger, R (1, 1)<br>OBP: 0.183, SLG: 0.164 |                                       | 1-0<br>F4                        |                              | 1-2<br>F3                        |                              |                                  | 0-0<br>6-3                    |                                  | 1-2<br>3-H<br>K               | 3                                | 0                            | 0                               | 0                             | 0                                | 0                            | 1                                |                                   |                                       |                                  |                    |             |
| Danny Litwhiler, R (8, PH)<br>OBP: 0.373, SLG: 0.469  |                                       |                                  |                              |                                  |                              |                                  |                               |                                  |                               | 1                                | 0                            | 0                               | 0                             | 0                                | 1                            | 2                                |                                   |                                       |                                  |                    |             |
| Eddie Erault, R (9, 1)<br>OBP: 0.286, SLG: 0.429      |                                       |                                  |                              |                                  |                              |                                  |                               |                                  |                               | 0                                | 0                            | 0                               | 0                             | 0                                | 0                            | 0                                |                                   |                                       |                                  |                    |             |
| Inning Stats  | R: 2<br>E: 0<br>K: 1<br>S: 13         | H: 2<br>LOB: 0<br>BB: 0<br>P: 19 | R: 2<br>E: 0<br>K: 0<br>S: 8 | H: 2<br>LOB: 0<br>BB: 0<br>P: 15 | R: 0<br>E: 0<br>K: 1<br>S: 7 | H: 0<br>LOB: 1<br>BB: 1<br>P: 15 | R: 0<br>E: 0<br>K: 0<br>S: 10 | H: 1<br>LOB: 1<br>BB: 0<br>P: 13 | R: 0<br>E: 0<br>K: 1<br>S: 14 | H: 1<br>LOB: 1<br>BB: 0<br>P: 15 | R: 0<br>E: 0<br>K: 0<br>S: 6 | H: 1<br>LOB: 1<br>BB: 0<br>P: 9 | R: 1<br>E: 0<br>K: 1<br>S: 10 | H: 4<br>LOB: 2<br>BB: 0<br>P: 18 | R: 0<br>E: 0<br>K: 0<br>S: 7 | H: 1<br>LOB: 2<br>BB: 1<br>P: 16 | 1B: 10<br>2B: 2<br>3B: 0<br>HR: 1 | SF: 0<br>SAC: 0<br>DP: 1<br>HBP: 1    | WP: 0<br>PB: 0<br>SB: 0<br>CS: 0 | PA: 41             |             |
| PITCHER   | IP<br>WLS<br>BF<br>H<br>R<br>ER<br>SO | W<br>W<br>S<br>S                 | BF<br>40                     | H<br>13                          | R<br>5                       | ER<br>5                          | SO<br>4                       | BB<br>2                          | IBB<br>0                      | HBP<br>1                         | BLK<br>0                     | WP<br>0                         | HR<br>1                       | S<br>84                          | P<br>132                     | ERA<br>5.19                      | WHIP<br>1.731                     | IP<br>WLS<br>BF<br>H<br>R<br>ER<br>SO | BB<br>IBB<br>HBP<br>BLK          | WP<br>HR<br>S<br>P | ERA<br>WHIP |
| Erv Palica, R (1, 1)<br>ERA: 4.05                     | 8.2                                   | W                                | 40                           | 13                               | 5                            | 5                                | 4                             | 2                                | 0                             | 1                                | 0                            | 0                               | 1                             | 84                               | 132                          | 5.19                             | 1.731                             |                                       |                                  |                    |             |
| Ralph Branca, R (9, 1)<br>ERA: 4.4                    | 0.1                                   | S                                | 1                            | 0                                | 0                            | 0                                | 0                             | 0                                | 0                             | 0                                | 0                            | 0                               | 0                             | 1                                | 1                            | 0.00                             | 0.000                             |                                       |                                  |                    |             |

BOTTOM

Brooklyn Dodgers @ Cincinnati Reds  
Crosley Field, Cincinnati, OH  
Sat Aug 26 1950, 3:33 AM EDT  
Att. 6,229 - Unknown

livebaseballscorecards.com

AB 38  
R 5  
H 13  
RBI 5  
BB 2  
SO 4  
LOB 14



**New York Giants @ Cincinnati Reds**  
 Crosley Field, Cincinnati, OH  
 Sun Aug 27 1950, 3:33 AM EDT  
 Sunny - 89 F

[livebaseballscorecards.com](http://livebaseballscorecards.com)

|            |           |
|------------|-----------|
| <b>AB</b>  | <b>43</b> |
| <b>R</b>   | <b>11</b> |
| <b>H</b>   | <b>17</b> |
| <b>RBI</b> | <b>11</b> |
| <b>BB</b>  | <b>4</b>  |
| <b>SO</b>  | <b>6</b>  |
| <b>LOB</b> | <b>26</b> |



| AB     | R      | H | RBI | BB | SO | LOB |
|--------|--------|---|-----|----|----|-----|
| 3      | 3      | 2 | 2   | 2  | 0  | 1   |
| 1      | 0      | 0 | 0   | 0  | 1  | 1   |
| 5      | 0      | 2 | 0   | 0  | 0  | 3   |
| 6      | 3      | 5 | 3   | 0  | 0  | 1   |
| 5      | 1      | 3 | 3   | 0  | 0  | 4   |
| 1      | 0      | 0 | 0   | 0  | 0  | 2   |
| 5      | 0      | 0 | 1   | 0  | 1  | 3   |
| 5      | 1      | 3 | 1   | 0  | 1  | 1   |
| 0      | 0      | 0 | 0   | 0  | 0  | 0   |
| 2      | 1      | 0 | 0   | 2  | 0  | 2   |
| 1      | 0      | 0 | 0   | 0  | 0  | 0   |
| 5      | 1      | 2 | 1   | 0  | 2  | 4   |
| 1      | 0      | 0 | 0   | 0  | 0  | 0   |
| 3      | 1      | 0 | 0   | 0  | 1  | 4   |
| 1B: 12 | SF: 0  |   |     |    |    |     |
| 2B: 2  | SAC: 1 |   |     |    |    |     |
| 3B: 3  | DP: 0  |   |     |    |    |     |
| HR: 0  | HBP: 1 |   |     |    |    |     |

| Batter  | 1                            | 2                                | 3                            | 4                               | 5                            | 6                               | 7                            | 8                                | 9                            |                                  |                              |                                 |                              |                                 |                              |                                 |                              |                                 |
|---|------------------------------|----------------------------------|------------------------------|---------------------------------|------------------------------|---------------------------------|------------------------------|----------------------------------|------------------------------|----------------------------------|------------------------------|---------------------------------|------------------------------|---------------------------------|------------------------------|---------------------------------|------------------------------|---------------------------------|
| <b>Eddie Stanky, R</b> (1, 4)<br>OBP: 0.466, SLG: 0.419<br><b>Bill Rigney, R</b> (8, 4)<br>OBP: 0.250, SLG: 0.216   | 0-0<br>1B<br>1B              | 4-0<br>FC4-6<br>BB               |                              | 4-0<br>1B<br>2B<br>BB           | 0-0<br>SH1-3<br>E<br>1B      |                                 | 0-0<br>F8                    |                                  | 0-3<br>K                     |                                  |                              |                                 |                              |                                 |                              |                                 |                              |                                 |
| <b>Whitey Lockman, L</b> (1, 7)<br>OBP: 0.367, SLG: 0.443   | 0-0<br>1B<br>1B              | 0-0<br>FC4-6<br>1B               |                              | 0-0<br>F5                       | 0-0<br>SH1-3                 |                                 | 0-0<br>4-3                   |                                  | 0-0<br>1B<br>1B              |                                  |                              |                                 |                              |                                 |                              |                                 |                              |                                 |
| <b>Don Mueller, L</b> (1, 9)<br>OBP: 0.335, SLG: 0.389  | 0-0<br>1B<br>1B              | 0-0<br>1B                        |                              | 0-0<br>2B<br>1B                 | 0-0<br>E5<br>1B<br>1B        |                                 | 0-0<br>6-3                   |                                  | 0-0<br>1B                    |                                  |                              |                                 |                              |                                 |                              |                                 |                              |                                 |
| <b>Hank Thompson, L</b> (1, 5)<br>OBP: 0.395, SLG: 0.478<br><b>Jack Lohrke, R</b> (8, 5)<br>OBP: 0.243, SLG: 0.152  | 0-0<br>F5                    | 0-0<br>F9                        |                              | 0-0<br>4-3<br>2B                | 0-0<br>CS<br>1B              |                                 |                              | 0-0<br>F9<br>3B                  | 0-0<br>5-3                   |                                  |                              |                                 |                              |                                 |                              |                                 |                              |                                 |
| <b>Alvin Dark, R</b> (1, 6)<br>OBP: 0.337, SLG: 0.454   | 0-0<br>FC5-2-5<br>1B         |                                  | 0-3<br>K                     | 0-0<br>4-3                      | 0-0<br>CS                    | 0-0<br>5-3                      |                              | 0-0<br>F9                        |                              |                                  |                              |                                 |                              |                                 |                              |                                 |                              |                                 |
| <b>Monte Irvin, R</b> (1, 3)<br>OBP: 0.375, SLG: 0.424<br><b>Tookie Gilbert, L</b> (8, 3)<br>OBP: 0.322, SLG: 0.317 | 0-0<br>BB<br>1B              |                                  | 0-0<br>3B<br>1B              | 0-3<br>K                        |                              | 0-0<br>3B                       |                              | 0-0<br>F7                        |                              |                                  |                              |                                 |                              |                                 |                              |                                 |                              |                                 |
| <b>Wes Westrum, R</b> (1, 2)<br>OBP: 0.373, SLG: 0.465<br><b>Sam Calderone, R</b> (8, PH)<br>OBP: 0.339, SLG: 0.383 | 4-0<br>1B<br>BB              |                                  | 0-0<br>F9                    |                                 | 4-0<br>2B<br>1B<br>BB        | 0-0<br>F3                       |                              | 0-0<br>F8                        |                              |                                  |                              |                                 |                              |                                 |                              |                                 |                              |                                 |
| <b>Bobby Thomson, R</b> (1, 8)<br>OBP: 0.308, SLG: 0.415  | 0-3<br>K                     |                                  | 0-0<br>3B                    |                                 | 0-0<br>1B<br>2B              | 0-3<br>K                        |                              |                                  | 0-0<br>E1                    |                                  |                              |                                 |                              |                                 |                              |                                 |                              |                                 |
| <b>Jim Hearn, R</b> (1, 1)<br>OBP: 0.286, SLG: 0.167<br><b>Monty Kennedy, R</b> (2, 1)<br>OBP: 0.088, SLG: 0.061    |                              | 0-0<br>F4                        | 0-0<br>5-3                   |                                 | 0-3<br>K                     |                                 | 1-0<br>4-3<br>HBP            |                                  | 0-0<br>FC5-1-6<br>1B         |                                  |                              |                                 |                              |                                 |                              |                                 |                              |                                 |
| <b>Inning Stats</b>   | R: 2<br>E: 0<br>K: 1<br>S: 9 | H: 4<br>LOB: 3<br>BB: 1<br>P: 13 | R: 0<br>E: 0<br>K: 0<br>S: 4 | H: 1<br>LOB: 2<br>BB: 1<br>P: 8 | R: 1<br>E: 0<br>K: 1<br>S: 7 | H: 2<br>LOB: 1<br>BB: 0<br>P: 7 | R: 2<br>E: 0<br>K: 1<br>S: 7 | H: 2<br>LOB: 1<br>BB: 1<br>P: 11 | R: 4<br>E: 1<br>K: 1<br>S: 8 | H: 4<br>LOB: 0<br>BB: 1<br>P: 12 | R: 0<br>E: 0<br>K: 1<br>S: 6 | H: 1<br>LOB: 1<br>BB: 0<br>P: 6 | R: 0<br>E: 0<br>K: 0<br>S: 3 | H: 0<br>LOB: 1<br>BB: 0<br>P: 4 | R: 1<br>E: 0<br>K: 0<br>S: 4 | H: 1<br>LOB: 0<br>BB: 0<br>P: 4 | R: 1<br>E: 1<br>K: 1<br>S: 8 | H: 2<br>LOB: 2<br>BB: 0<br>P: 8 |

| PITCHER                                       | IP  | WLS | BF | H | R | ER | SO | BB | IBB | HBP | BLK | WP | HR | S  | P  | ERA   | WHIP  |
|---|-----|-----|----|---|---|----|----|----|-----|-----|-----|----|----|----|----|-------|-------|
| <b>Herm Wehmeier, R</b> (1, 1)<br>ERA: 5.7    | 3.1 | L   | 22 | 9 | 5 | 5  | 2  | 3  | 0   | 0   | 0   | 0  | 0  | 23 | 35 | 13.50 | 3.600 |
| <b>Johnny Hetki, R</b> (4, 1)<br>ERA: 5.48    | 1.1 |     | 9  | 4 | 4 | 3  | 2  | 1  | 0   | 0   | 0   | 0  | 0  | 12 | 16 | 20.25 | 3.750 |
| <b>Eddie Erault, R</b> (5, 1)<br>ERA: 7.36    | 2.1 |     | 8  | 1 | 0 | 0  | 1  | 0  | 0   | 1   | 0   | 0  | 0  | 9  | 10 | 0.00  | 0.429 |
| <b>Harry Perkowski, L</b> (8, 1)<br>ERA: 4.96 | 1.0 |     | 4  | 1 | 1 | 1  | 0  | 0  | 0   | 0   | 0   | 0  | 0  | 4  | 4  | 9.00  | 1.000 |
| <b>Frank Smith, R</b> (9, 1)<br>ERA: 3.48     | 1.0 |     | 6  | 2 | 1 | 0  | 1  | 0  | 0   | 0   | 0   | 0  | 0  | 8  | 8  | 0.00  | 2.000 |

|       |        |
|-------|--------|
| WP: 0 | PA: 50 |
| PB: 0 |        |
| SB: 0 |        |
| CS: 1 |        |

BOTTOM

New York Giants @ Cincinnati Reds  
Crosley Field, Cincinnati, OH  
Sun Aug 27 1950, 3:33 AM EDT  
Sunny - 89 F

livebaseballscorecards.com

|     |    |
|-----|----|
| AB  | 35 |
| R   | 6  |
| H   | 11 |
| RBI | 6  |
| BB  | 6  |
| SO  | 1  |
| LOB | 8  |



|     |   |     |    |
|-----|---|-----|----|
| WP: | 0 | PA: | 41 |
| PB: | 0 |     |    |
| SB: | 2 |     |    |
| CS: | 0 |     |    |

|     |   |   |   |   |   |   |   |
|-----|---|---|---|---|---|---|---|
| AB  | 2 | 1 | 1 | 0 | 0 | 0 | 0 |
| R   | 3 | 0 | 0 | 0 | 0 | 1 | 1 |
| H   |   |   |   |   |   |   |   |
| RBI |   |   |   |   |   |   |   |
| BB  |   |   |   |   |   |   |   |
| SO  |   |   |   |   |   |   |   |
| LOB |   |   |   |   |   |   |   |

|     |   |   |   |   |   |   |   |
|-----|---|---|---|---|---|---|---|
| AB  | 4 | 1 | 0 | 0 | 1 | 0 | 0 |
| R   |   |   |   |   |   |   |   |
| H   |   |   |   |   |   |   |   |
| RBI |   |   |   |   |   |   |   |
| BB  |   |   |   |   |   |   |   |
| SO  |   |   |   |   |   |   |   |
| LOB |   |   |   |   |   |   |   |

|     |   |   |   |   |   |   |   |
|-----|---|---|---|---|---|---|---|
| AB  | 5 | 2 | 3 | 1 | 0 | 0 | 0 |
| R   |   |   |   |   |   |   |   |
| H   |   |   |   |   |   |   |   |
| RBI |   |   |   |   |   |   |   |
| BB  |   |   |   |   |   |   |   |
| SO  |   |   |   |   |   |   |   |
| LOB |   |   |   |   |   |   |   |

|     |   |   |   |   |   |   |   |
|-----|---|---|---|---|---|---|---|
| AB  | 4 | 0 | 3 | 2 | 1 | 0 | 0 |
| R   |   |   |   |   |   |   |   |
| H   |   |   |   |   |   |   |   |
| RBI |   |   |   |   |   |   |   |
| BB  |   |   |   |   |   |   |   |
| SO  |   |   |   |   |   |   |   |
| LOB |   |   |   |   |   |   |   |

|     |   |   |   |   |   |   |   |
|-----|---|---|---|---|---|---|---|
| AB  | 4 | 1 | 1 | 0 | 1 | 0 | 1 |
| R   |   |   |   |   |   |   |   |
| H   |   |   |   |   |   |   |   |
| RBI |   |   |   |   |   |   |   |
| BB  |   |   |   |   |   |   |   |
| SO  |   |   |   |   |   |   |   |
| LOB |   |   |   |   |   |   |   |

|     |   |   |   |   |   |   |   |
|-----|---|---|---|---|---|---|---|
| AB  | 3 | 1 | 1 | 2 | 1 | 0 | 0 |
| R   |   |   |   |   |   |   |   |
| H   |   |   |   |   |   |   |   |
| RBI |   |   |   |   |   |   |   |
| BB  |   |   |   |   |   |   |   |
| SO  |   |   |   |   |   |   |   |
| LOB |   |   |   |   |   |   |   |

|     |   |   |   |   |   |   |   |
|-----|---|---|---|---|---|---|---|
| AB  | 2 | 0 | 0 | 0 | 2 | 0 | 3 |
| R   |   |   |   |   |   |   |   |
| H   |   |   |   |   |   |   |   |
| RBI |   |   |   |   |   |   |   |
| BB  |   |   |   |   |   |   |   |
| SO  |   |   |   |   |   |   |   |
| LOB |   |   |   |   |   |   |   |

|     |   |   |   |   |   |   |   |
|-----|---|---|---|---|---|---|---|
| AB  | 4 | 0 | 1 | 1 | 0 | 0 | 1 |
| R   |   |   |   |   |   |   |   |
| H   |   |   |   |   |   |   |   |
| RBI |   |   |   |   |   |   |   |
| BB  |   |   |   |   |   |   |   |
| SO  |   |   |   |   |   |   |   |
| LOB |   |   |   |   |   |   |   |

|     |   |   |   |   |   |   |   |
|-----|---|---|---|---|---|---|---|
| AB  | 1 | 0 | 0 | 0 | 0 | 0 | 0 |
| R   | 1 | 0 | 1 | 0 | 0 | 0 | 0 |
| H   | 0 | 0 | 0 | 0 | 0 | 0 | 0 |
| RBI | 1 | 0 | 0 | 0 | 0 | 0 | 0 |
| BB  | 0 | 0 | 0 | 0 | 0 | 0 | 0 |
| SO  | 0 | 0 | 0 | 0 | 0 | 0 | 0 |
| LOB | 1 | 0 | 0 | 0 | 0 | 0 | 2 |
|     | 0 | 0 | 0 | 0 | 0 | 0 | 0 |

|     |   |      |   |
|-----|---|------|---|
| 1B: | 6 | SF:  | 0 |
| 2B: | 4 | SAC: | 0 |
| 3B: | 1 | DP:  | 1 |
| HR: | 0 | HBP: | 0 |

|     |   |     |    |
|-----|---|-----|----|
| WP: | 0 | PA: | 41 |
| PB: | 0 |     |    |
| SB: | 2 |     |    |
| CS: | 0 |     |    |

|     |   |      |   |
|-----|---|------|---|
| 1B: | 6 | SF:  | 0 |
| 2B: | 4 | SAC: | 0 |
| 3B: | 1 | DP:  | 1 |
| HR: | 0 | HBP: | 0 |

| Batter  | 1                | 2         | 3 | 4                  | 5                | 6 | 7       | 8         | 9            |
|---|------------------|-----------|---|--------------------|------------------|---|---------|-----------|--------------|
| Lloyd Merriman, L (1, 8)<br>OBP: 0.333, SLG: 0.358<br>Bob Usher, R (4, PH)<br>OBP: 0.317, SLG: 0.372 (5, 8)   | 0-0 3-1<br>1B 3B | 0-0 1B 3B |   | 0-0 G5-4-3<br>1-2f |                  |   | 0-0 5-3 |           | 0-3 K        |
| Grady Hatton, L (1, 5)<br>OBP: 0.365, SLG: 0.398  | 0-0 4-3<br>1B BB | 4-0 1B BB |   | 0-0 F8             |                  |   | 0-0 F9  |           | 0-0 F8       |
| Johnny Wyrostek, L (1, 9)<br>OBP: 0.389, SLG: 0.453   | 0-0 BB 2B        | 0-0 1B 1B |   |                    | 0-0 4-3          |   |         | 0-0 F7    | 0-0 1B 2B    |
| Ted Kluszewski, L (1, 3)<br>OBP: 0.365, SLG: 0.571  | 4-0 BB S BB      | 0-0 1B 1B |   |                    | 0-0 F9           |   |         | 0-0 2B 1B | 0-0 FC4-6 1B |
| Johnny Pramesa, R (1, 2)<br>OBP: 0.382, SLG: 0.460  | 4-0 BB BB        |           |   |                    | 0-0 F8           |   |         | 0-0 2B 2B | 0-0 FC4-6 1B |
| Joe Adcock, R (1, 7)<br>OBP: 0.306, SLG: 0.386  | 4-0 BB           |           |   |                    | 0-0 5-3          |   | 0-0 F6  | 0-0 1B 2B |              |
| Connie Ryan, R (1, 4)<br>OBP: 0.363, SLG: 0.375   | 0-0 5-3          |           |   |                    | 0-0 BB           |   | 0-0 F6  | 0-0 1B BB |              |
| Virgil Stallcup, R (1, 6)<br>OBP: 0.280, SLG: 0.354   |                  |           |   |                    | 0-0 F8           |   | 0-0 F7  | 0-0 1B    |              |
| Herm Wehmeier, R (1, 1)<br>OBP: 0.183, SLG: 0.210<br>Johnny Hetki, R (4, 1)<br>OBP: 0.300, SLG: 0.222<br>Eddie Erskitt, R (5, 1)<br>OBP: 0.286, SLG: 0.429<br>Peanuts Lowrey, R (7, PH)<br>OBP: 0.251, SLG: 0.293<br>Harry Perkowski, L (8, 1)<br>OBP: 0.303, SLG: 0.333<br>Bob Scheffing, R (8, PH)<br>OBP: 0.303, SLG: 0.371<br>Frank Smith, R (9, 1)<br>OBP: 0.063, SLG: 0.063 |                  | 0-0 4-3   |   |                    | 0-0 G5-4-3<br>1B |   | 0-0 F7  | 0-0 F8    |              |

| Inning Stats | R: 1 | H: 1 | E: 0 | K: 0 | S: 4 | LOB: 3 | BB: 3 | P: 16 |
|--------------|------|------|------|------|------|--------|-------|-------|
|              | R: 2 | H: 3 | E: 0 | K: 0 | S: 5 | LOB: 2 | BB: 1 | P: 9  |
|              | R: 0 | H: 0 | E: 0 | K: 0 | S: 3 | LOB: 1 | BB: 1 | P: 7  |
|              | R: 0 | H: 1 | E: 0 | K: 0 | S: 3 | LOB: 0 | BB: 0 | P: 3  |
|              | R: 0 | H: 0 | E: 0 | K: 0 | S: 3 | LOB: 0 | BB: 0 | P: 3  |
|              | R: 0 | H: 0 | E: 0 | K: 0 | S: 3 | LOB: 0 | BB: 0 | P: 3  |
|              | R: 2 | H: 4 | E: 0 | K: 0 | S: 6 | LOB: 2 | BB: 1 | P: 10 |
|              | R: 1 | H: 2 | E: 0 | K: 1 | S: 7 | LOB: 1 | BB: 0 | P: 7  |

| PITCHER                              | IP  | WLS | BF | H | R | ER | SO | BB | IBB | HBP | BLK | WP | HR | S  | P  | ERA   | WHIP  |
|--------------------------------------|-----|-----|----|---|---|----|----|----|-----|-----|-----|----|----|----|----|-------|-------|
| Jim Hearn, R (1, 1)<br>ERA: 3.28     | 1.2 |     | 12 | 3 | 3 | 3  | 0  | 4  | 0   | 0   | 0   | 0  | 0  | 8  | 24 | 16.20 | 4.200 |
| Monty Kennedy, L (2, 1)<br>ERA: 4.78 | 7.1 | W   | 29 | 8 | 3 | 3  | 1  | 2  | 0   | 0   | 0   | 0  | 0  | 29 | 37 | 3.68  | 1.364 |

| Batter  | 1  | 2   | 3   | 4   | 5   | 6   | 7   | 8   | 9   | AB R H RBI BB SO LOB   | TOP  |   |
|---|--|---|---|---|---|---|---|---|---|--|--|---|
| Eddie Stanky, R<br>OBP: 0.465, SLG: 0.416<br>(1, 4) X   | 0-0<br>G3  |   | 0-0<br>L3   |   |   | 4-0<br>L4-3<br>BB   |   |   | 0-0<br>4-3  | 3 0 0 0 1 0 0  |  |   |
| Whitey Lockman, L<br>OBP: 0.363, SLG: 0.438<br>(1, 7) X | 0-0<br>F7  |   |   | 0-3<br>K  |   | 0-0<br>L4-3<br>1-2  |   |   | 0-0<br>6-3  | 4 0 0 0 0 1 1  |  |   |
| Don Mueller, L<br>OBP: 0.334, SLG: 0.388<br>(1, 9) X    | 0-0<br>1B  |   |   | 0-0<br>6-3  |   |   | 0-0<br>F9   |   | 0-0<br>1-3  | 4 0 1 0 0 0 0  |  |   |
| Hank Thompson, L<br>OBP: 0.394, SLG: 0.477<br>(1, 5) X  | 0-0<br>1B  |   |   | 0-0<br>F9   |   |   | 0-0<br>F5   |   |   | 3 0 1 0 0 0 0  |  |   |
| Alvin Dark, R<br>OBP: 0.337, SLG: 0.455<br>(1, 6) X     |  | 0-0<br>2B   |   |   | 0-0<br>F8   |   | 0-0<br>F7   |   |   | 3 0 1 0 0 0 0  |  |   |
| Monte Irvin, R<br>OBP: 0.378, SLG: 0.437<br>(1, 3) X    |  | 0-0<br>6-3<br>2-3   |   |   | 4-0<br>BB   |   |   | 0-0<br>HR   |   | 2 1 1 1 1 0 1  |  |   |
| Wes Westrum, R<br>OBP: 0.371, SLG: 0.463<br>(1, 2) X    |  | 0-0<br>F3   |   |   | 0-0<br>F8   |   |   | 0-0<br>4-3  |   | 2 0 0 0 0 0 1  |  |   |
| Tookie Gilbert, L<br>OBP: 0.321, SLG: 0.316<br>(8, PH)  |  |   |   |   |   |   |   |   |   | 1 0 0 0 0 0 0  |  |   |
| Sam Calderone, R<br>OBP: 0.339, SLG: 0.383<br>(8, 2) X  |  |   |   |   |   |   |   |   |   | 0 0 0 0 0 0 0  |  |   |
| Bobby Thomson, R<br>OBP: 0.306, SLG: 0.412<br>(1, 8) X  |  |   | 0-0<br>F8   |   |   | 0-0<br>F9   |   |   | 0-0<br>F8   | 3 0 0 0 0 0 1  |  |   |
| Sheldon Jones, R<br>OBP: 0.174, SLG: 0.116<br>(1, 1) X  |  |   | 0-0<br>4-3  |   |   |   |   |   | 0-0<br>F7   | 2 0 0 0 0 0 0  |  |   |
| Monty Kennedy, R<br>OBP: 0.088, SLG: 0.061<br>(7, 1) X  |  |   |   |   |   | 0-0<br>4-3  |   |   |   | 0 0 0 0 0 0 0  |  |   |
| Roy Weatherly, L<br>OBP: 0.391, SLG: 0.450<br>(8, PH)   |  |   |   |   |   |   |   |   |   | 1 0 0 0 0 0 0  |  |   |
| Jack Kramer, R<br>OBP: 0.381, SLG: 0.333<br>(8, 1) X    |  |   |   |   |   |   |   |   |   | 0 0 0 0 0 0 0  |  |   |
| <b>Inning Stats</b>                                     | R: 0<br>E: 0<br>K: 0<br>S: 4<br>H: 2<br>LOB: 2<br>BB: 0<br>P: 4  | R: 0<br>E: 0<br>K: 0<br>S: 3<br>H: 1<br>LOB: 0<br>BB: 0<br>P: 3 | R: 0<br>E: 0<br>K: 0<br>S: 3<br>H: 0<br>LOB: 0<br>BB: 0<br>P: 3 | R: 0<br>E: 0<br>K: 1<br>S: 5<br>H: 0<br>LOB: 0<br>BB: 0<br>P: 5 | R: 0<br>E: 0<br>K: 0<br>S: 3<br>H: 0<br>LOB: 1<br>BB: 1<br>P: 7 | R: 0<br>E: 0<br>K: 0<br>S: 2<br>H: 0<br>LOB: 0<br>BB: 1<br>P: 6 | R: 0<br>E: 0<br>K: 0<br>S: 3<br>H: 0<br>LOB: 0<br>BB: 0<br>P: 3 | R: 1<br>E: 0<br>K: 0<br>S: 4<br>H: 1<br>LOB: 0<br>BB: 0<br>P: 4 | R: 0<br>E: 0<br>K: 0<br>S: 3<br>H: 0<br>LOB: 0<br>BB: 0<br>P: 3 | 1B: 2<br>2B: 2<br>3B: 0<br>HR: 1<br>SF: 0<br>SAC: 0<br>DP: 1<br>HBP: 0 | WP: 0<br>PB: 0<br>SB: 0<br>CS: 0<br>PA: 30 |   |
| <b>PITCHER</b><br>Howie Fox, R<br>ERA: 4.9<br>(1, 1)    | IP: 9.0<br>WLS: W<br>BF: 30<br>H: 4<br>R: 1<br>ER: 1<br>SO: 1<br>BB: 2<br>IBB: 0<br>HBP: 0<br>BLK: 0<br>WP: 0<br>HR: 1<br>S: 30<br>P: 38<br>ERA: 1.00<br>WHIP: 0.667 |   |   |   |   |   |   |   |   |  |  | <b>PITCHER</b><br>IP: WLS: BF: H: R: ER: SO: BB: IBB: HBP: BLK: WP: HR: S: P: ERA: WHIP |

**New York Giants @ Cincinnati Reds**  
 Crosley Field, Cincinnati, OH  
 Sun Aug 27 1950, 3:38 AM EDT  
 Att. 15,676 - Sunny - 89 F

[livebaseballscorecards.com](http://livebaseballscorecards.com)

|            |    |
|------------|----|
| <b>AB</b>  | 28 |
| <b>R</b>   | 1  |
| <b>H</b>   | 4  |
| <b>RBI</b> | 1  |
| <b>BB</b>  | 2  |
| <b>SO</b>  | 1  |
| <b>LOB</b> | 4  |



BOTTOM

New York Giants @ Cincinnati Reds  
Crosley Field, Cincinnati, OH  
Sun Aug 27 1950, 3:38 AM EDT  
Att. 15,676 - Sunny - 89 F

livebaseballscorecards.com

|     |    |
|-----|----|
| AB  | 31 |
| R   | 3  |
| H   | 8  |
| RBI | 3  |
| BB  | 3  |
| SO  | 6  |
| LOB | 13 |



|     |   |     |    |
|-----|---|-----|----|
| WP: | 0 | PA: | 34 |
| PB: | 1 | SB: | 0  |
| CS: | 0 |     |    |

AB R H RBI BB SO LOB

4 1 1 1 0 2 0

4 0 3 1 0 0 0

4 0 1 0 0 0 3

3 1 1 0 1 0 2

3 0 0 0 1 0 3

4 0 1 1 0 1 1

4 0 1 0 0 1 2

2 0 0 0 1 1 0

3 1 0 0 0 1 2

|     |   |      |   |
|-----|---|------|---|
| 1B: | 3 | SF:  | 0 |
| 2B: | 5 | SAC: | 0 |
| 3B: | 1 | DP:  | 2 |
| HR: | 0 | HBP: | 0 |

| Batter   | 1                                  | 2                    | 3                            | 4               | 5                        | 6                               | 7                                   | 8                            | 9 |
|--|------------------------------------|----------------------|------------------------------|-----------------|--------------------------|---------------------------------|-------------------------------------|------------------------------|---|
| Bobby Adams, R<br>OBP: 0.348, SLG: 0.402<br>(1, 4)     | 0-3<br>K<br>①                      |                      | 0-0<br>6-3<br>①              |                 | 0-3<br>K<br>②            |                                 | 0-0<br>2B<br>3B<br>1-H              |                              |   |
| Lloyd Merriman, L<br>OBP: 0.340, SLG: 0.369<br>(1, 8)  | 0-0<br>FC4-6<br>1B                 |                      | 0-0<br>F6<br>②               |                 | 0-0<br>1B                |                                 | 0-0<br>FC6-5-6<br>2B<br>3-H         |                              |   |
| Johnny Wyrostek, L<br>OBP: 0.388, SLG: 0.453<br>(1, 9) | 0-0<br>FC4-6<br>FC5-4<br>1-2f<br>② |                      | 0-0<br>PB<br>2B              |                 | 0-0<br>F8<br>③           |                                 | 0-0<br>FC6-5-6<br>FC4-6<br>2-3<br>② |                              |   |
| Ted Kluszewski, L<br>OBP: 0.366, SLG: 0.572<br>(1, 3)  | 0-0<br>FC5-4<br>1-2f<br>③          |                      | 4-0<br>PB<br>IBB             |                 | 0-0<br>3-4-3<br>1B<br>2B |                                 | 0-0<br>FC4-6<br>1-2f<br>③           |                              |   |
| Grady Hatton, L<br>OBP: 0.363, SLG: 0.395<br>(1, 5)    |                                    | 0-0<br>3-1<br>①      | 0-0<br>F6<br>1-2<br>2-3<br>③ |                 | 0-0<br>3-4-3<br>①        |                                 | 4-0<br>L4-3<br>BB<br>B B B B        |                              |   |
| Joe Adcock, R<br>OBP: 0.306, SLG: 0.384<br>(1, 7)      |                                    | 0-0<br>F4<br>②       |                              | 0-0<br>6-3<br>① |                          | 0-0<br>G6-4-3<br>1B<br>3-H      |                                     | 0-3<br>K<br>①                |   |
| Virgil Stallcup, R<br>OBP: 0.280, SLG: 0.356<br>(1, 6) |                                    | 0-0<br>2B            |                              | 0-3<br>K<br>②   |                          | 0-0<br>G6-4-3<br>1-2f<br>②<br>③ |                                     | 0-0<br>L4-3<br>1-2<br>②<br>③ |   |
| Dixie Howell, R<br>OBP: 0.326, SLG: 0.280<br>(1, 2)    |                                    | 4-0<br>BB<br>B B B B |                              | 0-3<br>K<br>③   |                          | 0-0<br>F6<br>①                  |                                     |                              |   |
| Howie Fox, R<br>OBP: 0.209, SLG: 0.302<br>(1, 1)       |                                    | 0-0<br>F5<br>③       |                              | 0-3<br>K<br>①   |                          | 0-0<br>E3<br>3B                 |                                     |                              |   |

| Inning Stats | R: 0 | H: 1 | E: 0 | LOB: 1 | K: 1 | BB: 0 | S: 6 | P: 6 |
|--------------|------|------|------|--------|------|-------|------|------|
|              | R: 0 | H: 1 | E: 0 | LOB: 2 | K: 0 | BB: 1 | S: 4 | P: 8 |
|              | R: 0 | H: 1 | E: 0 | LOB: 2 | K: 0 | BB: 1 | S: 4 | P: 8 |
|              | R: 0 | H: 0 | E: 0 | LOB: 0 | K: 2 | BB: 0 | S: 7 | P: 7 |
|              | R: 0 | H: 1 | E: 0 | LOB: 1 | K: 2 | BB: 0 | S: 8 | P: 8 |
|              | R: 1 | H: 2 | E: 0 | LOB: 0 | K: 0 | BB: 0 | S: 4 | P: 4 |
|              | R: 2 | H: 2 | E: 1 | LOB: 1 | K: 0 | BB: 0 | S: 6 | P: 6 |
|              | R: 0 | H: 0 | E: 0 | LOB: 0 | K: 1 | BB: 1 | S: 4 | P: 8 |

| PITCHER                                 | IP  | WLS | BF | H | R | ER | SO | BB | IBB | HBP | BLK | WP | HR | S  | P  | ERA  | WHIP  |
|---|-----|-----|----|---|---|----|----|----|-----|-----|-----|----|----|----|----|------|-------|
| Sheldon Jones, R<br>ERA: 4.98<br>(1, 1) | 6.1 | L   | 29 | 8 | 3 | 2  | 5  | 1  | 1   | 0   | 0   | 0  | 0  | 37 | 45 | 2.84 | 1.421 |
| Monty Kennedy, L<br>ERA: 4.75<br>(7, 1) | 0.2 |     | 2  | 0 | 0 | 0  | 0  | 0  | 0   | 0   | 0   | 0  | 0  | 2  | 2  | 0.00 | 0.000 |
| Jack Kramer, R<br>ERA: 3.61<br>(8, 1)   | 1.0 |     | 3  | 0 | 0 | 0  | 1  | 1  | 0   | 0   | 0   | 0  | 0  | 4  | 8  | 0.00 | 1.000 |

| WP | HR | S | P | ERA  | WHIP  |
|----|----|---|---|------|-------|
| 0  | 0  | 0 | 0 | 0.00 | 0.000 |

| Batter  | 1                            | 2                               | 3                            | 4                               | 5                            | 6                                | 7                            | 8                                | 9                            | AB R H RBI BB SO LOB            | TOP   |                                 |                              |                                 |                              |                                 |                              |                                 |                                  |                                    |                                  |        |    |    |   |   |     |      |  |  |  |
|---|------------------------------|---------------------------------|------------------------------|---------------------------------|------------------------------|----------------------------------|------------------------------|----------------------------------|------------------------------|---------------------------------|---|---------------------------------|------------------------------|---------------------------------|------------------------------|---------------------------------|------------------------------|---------------------------------|----------------------------------|------------------------------------|----------------------------------|--------|----|----|---|---|-----|------|--|--|--|
| <b>Eddie Stanky, R</b> (1, 4)<br>OBP: 0.467, SLG: 0.416         | 0-0<br>F4                    |                                 | 0-0<br>BB 1B<br>F7 1B        | 4-0<br>1-2<br>BB                |                              |                                  | 4-0<br>BB<br>BB              |                                  |                              | 2 1 1 0 2 0 0                   | <b>New York Giants @ Cincinnati Reds</b><br>Crosley Field, Cincinnati, OH<br>Mon Aug 28 1950, 3:33 AM EDT<br>Att: 1,547 - Cloudy - 90 F |                                 |                              |                                 |                              |                                 |                              |                                 |                                  |                                    |                                  |        |    |    |   |   |     |      |  |  |  |
| <b>Whitey Lockman, L</b> (1, 7)<br>OBP: 0.365, SLG: 0.437       | 4-0<br>4-3<br>BB             |                                 | 0-0<br>1-2<br>BB 1B          | 0-0<br>F8                       |                              |                                  | 0-0<br>F7                    |                                  |                              | 3 1 1 0 1 0 3                   |   |                                 |                              |                                 |                              |                                 |                              |                                 |                                  |                                    |                                  |        |    |    |   |   |     |      |  |  |  |
| <b>Don Mueller, L</b> (1, 9)<br>OBP: 0.333, SLG: 0.385          | 0-0<br>4-3                   |                                 | 4-0<br>1-2 2-3<br>1B BB      |                                 |                              |                                  | 0-0<br>G3                    |                                  |                              | 3 0 0 0 1 0 2                   |   |                                 |                              |                                 |                              |                                 |                              |                                 |                                  |                                    |                                  |        |    |    |   |   |     |      |  |  |  |
| <b>Hank Thompson, L</b> (1, 5)<br>OBP: 0.393, SLG: 0.477        | 0-0<br>F8                    |                                 | 0-0<br>F7                    |                                 |                              |                                  | 0-0<br>L3-6<br>2B            |                                  |                              | 4 0 1 1 0 0 3                   |   |                                 |                              |                                 |                              |                                 |                              |                                 |                                  |                                    |                                  |        |    |    |   |   |     |      |  |  |  |
| <b>Alvin Dark, R</b> (1, 6)<br>OBP: 0.336, SLG: 0.453           |                              | 0-3<br>K                        | 0-0<br>1-3 2-H<br>1B         |                                 |                              |                                  | 0-0<br>L3-6                  |                                  |                              | 4 0 1 1 0 1 1                   |   |                                 |                              |                                 |                              |                                 |                              |                                 |                                  |                                    |                                  |        |    |    |   |   |     |      |  |  |  |
| <b>Tookie Gilbert, L</b> (1, 3)<br>OBP: 0.318, SLG: 0.312       |                              | 0-0<br>4-3                      | 0-0<br>4-3                   |                                 |                              |                                  | 0-0<br>F6                    |                                  |                              | 4 0 0 0 0 0 2                   |   |                                 |                              |                                 |                              |                                 |                              |                                 |                                  |                                    |                                  |        |    |    |   |   |     |      |  |  |  |
| <b>Bobby Thomson, R</b> (1, 8)<br>OBP: 0.307, SLG: 0.414        |                              | 0-0<br>2B                       |                              | 0-3<br>K                        |                              |                                  | 4-0<br>G6-4-3<br>BB          |                                  |                              | 3 0 1 0 1 1 0                   |   |                                 |                              |                                 |                              |                                 |                              |                                 |                                  |                                    |                                  |        |    |    |   |   |     |      |  |  |  |
| <b>Sam Calderone, R</b> (1, 2)<br>OBP: 0.318, SLG: 0.359        | 0-0<br>F4                    |                                 | 0-0<br>5-3                   |                                 |                              |                                  | 0-0<br>G6-4-3                |                                  |                              | 4 0 0 0 0 0 2                   |   |                                 |                              |                                 |                              |                                 |                              |                                 |                                  |                                    |                                  |        |    |    |   |   |     |      |  |  |  |
| <b>Dave Koslo, L</b> (1, 1)<br>OBP: 0.194, SLG: 0.175           |                              |                                 | 0-0<br>F9                    |                                 |                              |                                  | 0-3<br>K                     |                                  |                              | 4 0 1 0 0 2 0                   |   |                                 |                              |                                 |                              |                                 |                              |                                 |                                  |                                    |                                  |        |    |    |   |   |     |      |  |  |  |
| <b>Inning Stats</b>   | R: 0<br>E: 0<br>K: 0<br>S: 3 | H: 0<br>LOB: 1<br>BB: 1<br>P: 7 | R: 0<br>E: 0<br>K: 1<br>S: 6 | H: 1<br>LOB: 1<br>BB: 0<br>P: 6 | R: 2<br>E: 0<br>K: 0<br>S: 6 | H: 3<br>LOB: 2<br>BB: 1<br>P: 10 | R: 0<br>E: 0<br>K: 1<br>S: 6 | H: 1<br>LOB: 2<br>BB: 1<br>P: 10 | R: 0<br>E: 0<br>K: 0<br>S: 3 | H: 1<br>LOB: 0<br>BB: 0<br>P: 3 | R: 0<br>E: 0<br>K: 0<br>S: 2  | H: 0<br>LOB: 0<br>BB: 1<br>P: 6 | R: 0<br>E: 0<br>K: 1<br>S: 5 | H: 0<br>LOB: 1<br>BB: 1<br>P: 9 | R: 0<br>E: 0<br>K: 0<br>S: 3 | H: 0<br>LOB: 0<br>BB: 0<br>P: 3 | R: 0<br>E: 0<br>K: 1<br>S: 5 | H: 0<br>LOB: 0<br>BB: 0<br>P: 5 | 1B: 4<br>2B: 3<br>3B: 0<br>HR: 0 | SF: 0<br>SAC: 0<br>DP: 2<br>HBP: 0 | WP: 0<br>PB: 0<br>SB: 0<br>CS: 0 | PA: 36 |    |    |   |   |     |      |  |  |  |
| <b>PITCHER</b><br><b>Ewell Blackwell, R</b> (1, 1)<br>ERA: 3.55 | IP<br>9.0                    | WLS<br>W                        | BF<br>36                     | H<br>6                          | R<br>2                       | ER<br>2                          | SO<br>4                      | BB<br>5                          | IBB<br>0                     | HBP<br>0                        | BLK<br>0  | WP<br>0                         | HR<br>0                      | S<br>39                         | P<br>59                      | ERA<br>2.00                     | WHIP<br>1.222                |                                 |                                  |                                    |                                  |        |    |    |   |   |     |      |  |  |  |
|   |                              |                                 |                              |                                 |                              |                                  |                              |                                  |                              |                                 | <b>PITCHER</b>  | IP                              | WLS                          | BF                              | H                            | R                               | ER                           | SO                              | BB                               | IBB                                | HBP                              | BLK    | WP | HR | S | P | ERA | WHIP |  |  |  |

|            |    |
|------------|----|
| <b>AB</b>  | 31 |
| <b>R</b>   | 2  |
| <b>H</b>   | 6  |
| <b>RBI</b> | 2  |
| <b>BB</b>  | 5  |
| <b>SO</b>  | 4  |
| <b>LOB</b> | 13 |



livebaseballscorecards.com

| Batter   | 1                         | 2         | 3                     | 4                   | 5          | 6         | 7                        | 8          | 9         | AB | R | H | RBI | BB | SO | LOB |
|--|---------------------------|-----------|-----------------------|---------------------|------------|-----------|--------------------------|------------|-----------|----|---|---|-----|----|----|-----|
| <b>Bobby Adams, R</b><br>OBP: 0.350, SLG: 0.403 (1, 4)     | 0-0<br>SH1-3<br>1B        |           | 0-0<br>5-3            |                     | 0-0<br>1B  |           | 0-0<br>F9                |            |           | 4  | 1 | 2 | 1   | 0  | 0  | 1   |
| <b>Bob Usher, R</b><br>OBP: 0.313, SLG: 0.368 (1, 8)       | 0-0<br>SH1-3<br>1-2       |           | 0-0<br>6-3            |                     | 0-0<br>F7  |           | 0-0<br>F7                |            |           | 3  | 0 | 0 | 0   | 0  | 0  | 2   |
| <b>Johnny Wyrostek, L</b><br>OBP: 0.389, SLG: 0.454 (1, 9) | 0-0<br>FC6-4<br>2-H<br>1B |           |                       | 0-0<br>G4-6-3<br>1B |            | 0-0<br>F7 |                          | 0-0<br>1-3 |           | 4  | 0 | 2 | 1   | 0  | 0  | 0   |
| <b>Ted Kluszewski, L</b><br>OBP: 0.362, SLG: 0.566 (1, 3)  | 0-3<br>K                  |           | 0-0<br>G4-6-3<br>1-2f |                     | 0-0<br>4-3 |           | 0-0<br>6-3               |            |           | 4  | 0 | 0 | 0   | 0  | 1  | 2   |
| <b>Joe Adcock, R</b><br>OBP: 0.309, SLG: 0.386 (1, 7)      | 0-0<br>FC6-4<br>1-2f      |           | 0-0<br>1B             |                     | 0-0<br>1B  |           | 0-0<br>F8                |            |           | 4  | 0 | 2 | 0   | 0  | 0  | 1   |
| <b>Grady Hatton, L</b><br>OBP: 0.362, SLG: 0.393 (1, 5)    |                           | 0-0<br>F9 |                       | 0-0<br>1-3<br>1B    |            | 0-3<br>K  |                          | 0-0<br>4-3 |           | 4  | 0 | 1 | 0   | 0  | 1  | 1   |
| <b>Virgil Stallcup, R</b><br>OBP: 0.280, SLG: 0.354 (1, 6) |                           | 0-0<br>F8 |                       | 0-0<br>F2           |            | 0-0<br>1B | 0-0<br>SH1-4<br>F9<br>1B |            | 0-0<br>F4 | 4  | 1 | 1 | 0   | 0  | 0  | 2   |
| <b>Dixie Howell, R</b><br>OBP: 0.327, SLG: 0.298 (1, 2)    |                           | 0-0<br>F8 |                       |                     | 0-0<br>1-3 |           | 0-0<br>SH1-4             |            | 0-0<br>HR | 3  | 1 | 1 | 1   | 0  | 0  | 0   |
| <b>Ewell Blackwell, R</b><br>OBP: 0.137, SLG: 0.087 (1, 1) |                           |           | 0-0<br>4-3            |                     | 0-0<br>F9  |           | 0-0<br>1B                |            |           | 3  | 0 | 1 | 0   | 0  | 0  | 0   |

|   |                              |                                 |                              |                                 |                              |                                 |                              |                                 |                              |                                 |                              |                                 |                              |                                 |                              |                                 |                              |                                 |                                  |                                    |                                  |        |
|---|------------------------------|---------------------------------|------------------------------|---------------------------------|------------------------------|---------------------------------|------------------------------|---------------------------------|------------------------------|---------------------------------|------------------------------|---------------------------------|------------------------------|---------------------------------|------------------------------|---------------------------------|------------------------------|---------------------------------|----------------------------------|------------------------------------|----------------------------------|--------|
| <b>Inning Stats</b>                                       | R: 1<br>E: 0<br>K: 1<br>S: 7 | H: 2<br>LOB: 1<br>BB: 0<br>P: 7 | R: 0<br>E: 0<br>K: 0<br>S: 3 | H: 0<br>LOB: 0<br>BB: 0<br>P: 3 | R: 0<br>E: 0<br>K: 0<br>S: 3 | H: 0<br>LOB: 0<br>BB: 0<br>P: 3 | R: 0<br>E: 0<br>K: 0<br>S: 5 | H: 3<br>LOB: 2<br>BB: 0<br>P: 5 | R: 0<br>E: 0<br>K: 0<br>S: 4 | H: 1<br>LOB: 1<br>BB: 0<br>P: 4 | R: 0<br>E: 0<br>K: 1<br>S: 6 | H: 1<br>LOB: 1<br>BB: 0<br>P: 6 | R: 1<br>E: 0<br>K: 0<br>S: 5 | H: 2<br>LOB: 1<br>BB: 0<br>P: 5 | R: 0<br>E: 0<br>K: 0<br>S: 3 | H: 0<br>LOB: 0<br>BB: 0<br>P: 3 | R: 1<br>E: 0<br>K: 0<br>S: 3 | H: 1<br>LOB: 0<br>BB: 0<br>P: 3 | 1B: 9<br>2B: 0<br>3B: 0<br>HR: 1 | SF: 0<br>SAC: 2<br>DP: 1<br>HBP: 0 | WP: 0<br>PB: 0<br>SB: 0<br>CS: 0 | PA: 35 |
| <b>PITCHER</b><br><b>Dave Koslo, L</b><br>ERA: 3.8 (1, 1) | IP<br>8.2                    | WLS<br>L                        | BF<br>35                     | H<br>10                         | R<br>3                       | ER<br>3                         | SO<br>2                      | BB<br>0                         | IBB<br>0                     | HBP<br>0                        | BLK<br>0                     | WP<br>0                         | HR<br>1                      | S<br>39                         | P<br>39                      | ERA<br>3.12                     | WHIP<br>1.154                |                                 |                                  |                                    |                                  |        |

**BOTTOM**

**New York Giants @ Cincinnati Reds**  
Crosley Field, Cincinnati, OH

Mon Aug 28 1950, 3:33 AM EDT  
Att. 1,547 - Cloudy - 90 F

livebaseballscorecards.com

|            |           |
|------------|-----------|
| <b>AB</b>  | <b>33</b> |
| <b>R</b>   | <b>3</b>  |
| <b>H</b>   | <b>10</b> |
| <b>RBI</b> | <b>3</b>  |
| <b>BB</b>  | <b>0</b>  |
| <b>SO</b>  | <b>2</b>  |
| <b>LOB</b> | <b>9</b>  |



| Batter   | 1  | 2   | 3   | 4   | 5   | 6   | 7   | 8   | 9   | AB R H RBI BB SO LOB   | TOP  |                |   |
|--|--|---|---|---|---|---|---|---|---|--|--|----------------|---|
| Roy Hartsfield, R (1, 4)<br>OBP: 0.326, SLG: 0.370   | 0-0<br>BB<br>1B<br>2B  | 0-0<br>1B   |   | 0-0<br>1-3<br>2B  |   |   | 0-0<br>F4   |   | 0-0<br>FC4<br>1-2f  | 5 1 2 0 0 0 1  |  |                |   |
| Sam Jethroe, S (1, 8)<br>OBP: 0.349, SLG: 0.445      | 4-0<br>BB<br>1B<br>BB  | 0-0<br>F8   |   | 0-0<br>2B   |   |   | 0-0<br>F3   |   | 0-3<br>K  | 4 1 1 0 1 1 2  |  |                |   |
| Earl Torgeson, L (1, 3)<br>OBP: 0.402, SLG: 0.459    | 4-0<br>SH1-3<br>1-2<br>2-3<br>BB<br>1B                           |   | 0-0<br>4-3  | 0-3<br>K  |   |   | 0-0<br>CS<br>1B   |   |   | 3 0 1 0 1 1 1  |  |                |   |
| Bob Elliott, R (1, 5)<br>OBP: 0.387, SLG: 0.514      | 0-0<br>SH1-3<br>1-2<br>2-H<br>3-H<br>1B                          |   | 0-0<br>1B<br>2B   |   |   | 0-0<br>F9   | 0-0<br>CS<br>1-2  | 0-0<br>F7   |   | 4 1 2 2 0 0 0  |  |                |   |
| Walker Cooper, R (1, 2)<br>OBP: 0.372, SLG: 0.511    | 0-0<br>SH1-3<br>1-2<br>2-3                                       |   | 0-0<br>5-3<br>1B<br>2-H   |   |   | 0-0<br>F4   |   | 0-0<br>6-3  |   | 3 0 1 1 0 0 0  |  |                |   |
| Sid Gordon, R (1, 7)<br>OBP: 0.419, SLG: 0.571       | 0-3<br>K   |   | 0-0<br>5-3<br>1-2   |   |   | 0-0<br>F7   |   | 0-0<br>F8   |   | 4 0 0 0 0 1 3  |  |                |   |
| Willard Marshall, L (1, 9)<br>OBP: 0.328, SLG: 0.335 | 0-0<br>F8  |   | 4-0<br>FC6-4<br>IBB   |   |   | 0-0<br>F5   |   |   | 0-0<br>G1<br>1B<br>2B   | 3 1 1 0 1 0 2  |  |                |   |
| Buddy Kerr, R (1, 6)<br>OBP: 0.287, SLG: 0.303       |  | 0-0<br>F7   | 0-0<br>FC6-4<br>1-2f  |   |   | 0-0<br>1-3  |   |   | 0-0<br>G1<br>2-3  | 4 0 0 0 0 0 3  |  |                |   |
| Johnny Sain, R (1, 1)<br>OBP: 0.284, SLG: 0.256      |  | 0-0<br>F4   |   | 0-3<br>K  |   | 0-0<br>1-3  |   |   | 0-0<br>FC4<br>3-H<br>1B   | 4 0 1 1 0 1 0  |  |                |   |
| <b>Inning Stats</b>                                  | R: 2<br>E: 0<br>K: 1<br>S: 7<br>H: 2<br>LOB: 2<br>BB: 2<br>P: 15 | R: 0<br>E: 0<br>K: 0<br>S: 4<br>H: 1<br>LOB: 1<br>BB: 0<br>P: 4 | R: 1<br>E: 0<br>K: 0<br>S: 5<br>H: 2<br>LOB: 2<br>BB: 1<br>P: 9 | R: 0<br>E: 0<br>K: 2<br>S: 8<br>H: 1<br>LOB: 1<br>BB: 0<br>P: 8 | R: 0<br>E: 0<br>K: 0<br>S: 3<br>H: 0<br>LOB: 0<br>BB: 0<br>P: 3 | R: 0<br>E: 0<br>K: 0<br>S: 3<br>H: 0<br>LOB: 0<br>BB: 0<br>P: 3 | R: 0<br>E: 0<br>K: 0<br>S: 3<br>H: 1<br>LOB: 0<br>BB: 0<br>P: 3 | R: 0<br>E: 0<br>K: 0<br>S: 3<br>H: 0<br>LOB: 0<br>BB: 0<br>P: 3 | R: 1<br>E: 0<br>K: 1<br>S: 7<br>H: 2<br>LOB: 1<br>BB: 0<br>P: 7 | 1B: 5<br>2B: 4<br>3B: 0<br>HR: 0<br>SF: 0<br>SAC: 1<br>DP: 0<br>HBP: 0 | WP: 0<br>PB: 0<br>SB: 0<br>CS: 1<br>PA: 39 |                |   |
| <b>PITCHER</b>                                       | IP WLS BF H R ER SO BB IBB HBP BLK WP HR S P ERA WHIP            |   |   |   |   |   |   |   |   |  |  | <b>PITCHER</b> | IP WLS BF H R ER SO BB IBB HBP BLK WP HR S P ERA WHIP |
| Willie Ramsdell, R (1, 1)<br>ERA: 3.89               | 0.0 L 4 2 2 2 0 2 0 0 0 0 0 0 2 10 ∞ ∞                           |   |   |   |   |   |   |   |   |  |  |                |   |
| Frank Smith, R (1, 1)<br>ERA: 3.31                   | 6.0 23 4 1 1 3 0 1 0 0 0 0 28 32 1.50 0.667                      |   |   |   |   |   |   |   |   |  |  |                |   |
| Eddie Erault, R (7, 1)<br>ERA: 7.02                  | 2.0 6 1 0 0 0 0 0 0 0 0 0 6 6 0.00 0.500                         |   |   |   |   |   |   |   |   |  |  |                |   |
| Harry Perkowski, L (9, 1)<br>ERA: 5.08               | 1.0 5 2 1 1 1 0 0 0 0 0 0 7 7 9.00 2.000                         |   |   |   |   |   |   |   |   |  |  |                |   |

**Boston Braves @ Cincinnati Reds**  
Crosley Field, Cincinnati, OH  
Tue Aug 29 1950, 3:33 AM EDT  
Att: 8,348 - Unknown - 78 F

livebaseballscorecards.com

**AB 34**  
**R 4**  
**H 9**  
**RBI 4**  
**BB 3**  
**SO 4**  
**LOB 12**





| Batter   | 1          | 2          | 3          | 4                | 5                     | 6         | 7                | 8          | 9                     | AB | R | H | RBI | BB | SO | LOB |
|--|------------|------------|------------|------------------|-----------------------|-----------|------------------|------------|-----------------------|----|---|---|-----|----|----|-----|
| <b>Bobby Adams, R</b><br>(1, 4)<br>OBP: 0.352, SLG: 0.409<br>(9, 5)  | 0-0<br>F8  |            |            | 0-0<br>4-3<br>2B |                       | 0-0<br>F7 |                  | 0-0<br>1B  |                       | 4  | 0 | 2 | 0   | 0  | 0  | 0   |
| <b>Lloyd Merriman, L</b><br>(1, 8)<br>OBP: 0.335, SLG: 0.363   | 0-0<br>F6  |            |            | 0-0<br>F8        |                       | 0-0<br>F4 |                  | 0-0<br>G3  |                       | 4  | 0 | 0 | 0   | 0  | 0  | 2   |
| <b>Johnny Wyrostek, L</b><br>(1, 9)<br>OBP: 0.390, SLG: 0.451  | 0-0<br>3-1 |            |            | 4-0<br>4-3<br>BB |                       |           | 0-0<br>4-3       |            | 4-0<br>G4-6-3<br>BB   | 2  | 0 | 0 | 0   | 2  | 0  | 0   |
| <b>Ted Kluszewski, L</b><br>(1, 3)<br>OBP: 0.359, SLG: 0.560   |            | 0-0<br>4-3 |            | 0-0<br>4-3       |                       |           | 0-0<br>L7        |            | 0-0<br>G4-6-3<br>1-2f | 4  | 0 | 0 | 0   | 0  | 0  | 3   |
| <b>Grady Hatton, L</b><br>(1, 5)<br>OBP: 0.361, SLG: 0.391<br>(9, 6)   |            | 0-0<br>F9  |            | 0-0<br>G3        |                       |           | 0-0<br>1B<br>1B  |            | 0-0<br>F8             | 4  | 0 | 1 | 0   | 0  | 0  | 2   |
| <b>Joe Adcock, R</b><br>(1, 7)<br>OBP: 0.309, SLG: 0.385   |            | 0-0<br>6-3 |            |                  | 0-0<br>F8             |           | 0-0<br>1-2<br>1B |            |                       | 3  | 0 | 1 | 0   | 0  | 0  | 0   |
| <b>Johnny Pramesa, R</b><br>(1, 2)<br>OBP: 0.381, SLG: 0.458   |            |            | 0-0<br>F4  |                  | 0-0<br>G5-4-3<br>1B   |           | 0-0<br>F4        |            |                       | 3  | 0 | 1 | 0   | 0  | 0  | 2   |
| <b>Virgil Stallcup, R</b><br>(1, 6)<br><b>Connie Ryan, R</b><br>(9, 4)<br>OBP: 0.277, SLG: 0.351<br>OBP: 0.363, SLG: 0.375   |            |            | 0-0<br>6-3 |                  | 0-0<br>G5-4-3<br>1-2f |           |                  | 0-0<br>6-3 |                       | 3  | 0 | 0 | 0   | 0  | 0  | 1   |
| <b>Willie Ramsdell, R</b><br>(1, 1)<br><b>Frank Smith, R</b><br>(1, 1)<br><b>Sammy Meeks, R</b><br>(6, PH)<br><b>Eddie Erault, R</b><br>(7, 1)<br><b>Harry Perkowski, L</b><br>(8, PH)<br>(9, 1)<br>OBP: 0.277, SLG: 0.209<br>OBP: 0.059, SLG: 0.059<br>OBP: 0.318, SLG: 0.375<br>OBP: 0.250, SLG: 0.429<br>OBP: 0.346, SLG: 0.318 |            |            | 0-0<br>3-1 |                  |                       | 0-0<br>F7 |                  | 0-3<br>K   |                       | 0  | 0 | 0 | 0   | 0  | 0  | 0   |

**BOTTOM**

**Boston Braves @ Cincinnati Reds**  
Crosley Field, Cincinnati, OH

Tue Aug 29 1950, 3:33 AM EDT  
Att. 8,348 - Unknown - 78 F

livebaseballscorecards.com

|     |    |
|-----|----|
| AB  | 30 |
| R   | 0  |
| H   | 5  |
| RBI | 0  |
| BB  | 2  |
| SO  | 1  |
| LOB | 10 |

|    |   |     |    |
|----|---|-----|----|
| 1B | 4 | SF  | 0  |
| 2B | 1 | SAC | 0  |
| 3B | 0 | DP  | 2  |
| HR | 0 | HBP | 0  |
| WP | 0 | PA  | 32 |
| PB | 0 | SB  | 0  |
| CS | 0 |     |    |



| Inning Stats                                 | R: 0 | H: 0 | E: 0 | LOB: 0 | K: 0 | BB: 0 | S: 3 | P: 3 | R: 0 | H: 0 | E: 0 | LOB: 0 | K: 0 | BB: 0 | S: 3 | P: 3 | R: 0 | H: 1 | E: 0 | LOB: 2 | K: 0 | BB: 1 | S: 4 | P: 8 | R: 0 | H: 1 | E: 0 | LOB: 0 | K: 0 | BB: 0 | S: 3 | P: 3 | R: 0 | H: 2 | E: 0 | LOB: 2 | K: 0 | BB: 0 | S: 5 | P: 5 | R: 0 | H: 1 | E: 0 | LOB: 1 | K: 1 | BB: 0 | S: 6 | P: 6 | R: 0 | H: 0 | E: 0 | LOB: 0 | K: 0 | BB: 1 | S: 2 | P: 6 | 1B: 4 | SF: 0 | 2B: 1 | SAC: 0 | 3B: 0 | DP: 2 | HR: 0 | HBP: 0 | WP: 0 | PA: 32 | PB: 0 | SB: 0 | CS: 0 |
|--|------|------|------|--------|------|-------|------|------|------|------|------|--------|------|-------|------|------|------|------|------|--------|------|-------|------|------|------|------|------|--------|------|-------|------|------|------|------|------|--------|------|-------|------|------|------|------|------|--------|------|-------|------|------|------|------|------|--------|------|-------|------|------|-------|-------|-------|--------|-------|-------|-------|--------|-------|--------|-------|-------|-------|
| <b>Johnny Sain, R</b><br>(1, 1)<br>ERA: 4.14 | IP   | WLS  | BF   | H      | R    | ER    | SO   | BB   | IBB  | HBP  | BLK  | WP     | HR   | S     | P    | ERA  | WHIP | IP   | WLS  | BF     | H    | R     | ER   | SO   | BB   | IBB  | HBP  | BLK    | WP   | HR    | S    | P    | ERA  | WHIP | IP   | WLS    | BF   | H     | R    | ER   | SO   | BB   | IBB  | HBP    | BLK  | WP    | HR   | S    | P    | ERA  | WHIP |        |      |       |      |      |       |       |       |        |       |       |       |        |       |        |       |       |       |

| Batter   | 1   | 2  | 3   | 4   | 5   | 6   | 7  | 8   | 9   | AB R H RBI BB SO LOB  | TOP  |                |   |
|--|---|--|---|---|---|---|--|---|---|---|--|----------------|---|
| Roy Hartsfield, R<br>OBP: 0.324, SLG: 0.367 (1, 4) X | 0-0<br>4-3  | 0-0<br>E6<br>1B  |   | X 0-0<br>3-1  |   |   | X 0-0<br>SH3-4<br>1-2  | 0-0<br>2B<br>1B   | X 0-0<br>E3<br>1-3<br>2-H                                       | 5 0 1 0 0 0 3   |  |                |   |
| Sam Jethroe, S<br>OBP: 0.351, SLG: 0.455 (1, 8) X    | 0-0<br>F8   | 0-0<br>1-2<br>3-H<br>1B  |   | X 0-0<br>F8   |   |   | X 0-0<br>2-H<br>HR   | 0-0<br>1-3<br>2B  | X 0-0<br>F9<br>3  | 6 1 3 3 0 0 2   |  |                |   |
| Earl Torgeson, L<br>OBP: 0.400, SLG: 0.455 (1, 3) X  | 0-0<br>4-3  | 0-0<br>F9<br>3   |   | 0-0<br>K  |   |   | X 0-0<br>F9<br>2   | 4-0<br>FC6-4<br>IBB   |   | 4 0 0 0 1 1 2   |  |                |   |
| Bob Elliott, R<br>OBP: 0.387, SLG: 0.512 (1, 5)      |   | 0-0<br>BB<br>1B  |   | 0-0<br>F7<br>1  |   |   | X 0-0<br>1B<br>1B  | 0-0<br>FC6-4<br>1-2f  |   | 3 1 1 0 0 1 0   |  |                |   |
| Sibby Sisti, R<br>OBP: 0.306, SLG: 0.272 (5, 5)      |   |  |   | 0-0<br>K  |   |   | X 0-0<br>1B  |   |   | 2 0 1 0 0 0 3   |  |                |   |
| Sid Gordon, R<br>OBP: 0.418, SLG: 0.577 (1, 7)       |   | X 0-0<br>F9<br>1   |   | 0-0<br>6-3<br>2   |   |   | X 0-0<br>F8<br>1   | 0-0<br>1-3<br>BB<br>1B  | X 0-0<br>HR   | 5 1 2 1 0 0 1   |  |                |   |
| Luis Olmo, R<br>OBP: 0.315, SLG: 0.398 (1, 9)        |   | B<br>B<br>B<br>B<br>4-0<br>1B<br>1-2<br>2B<br>BB                 |   | X 0-0<br>F6<br>3  |   |   | X 0-0<br>HR  | B<br>B<br>B<br>B<br>4-0<br>1-2<br>FC6-4<br>BB                   | X 0-0<br>F8<br>1  | 3 2 1 1 2 0 0   |  |                |   |
| Del Crandall, R<br>OBP: 0.289, SLG: 0.332 (1, 2)     |   | X 0-0<br>2B<br>E<br>1B<br>1-2<br>2-H                             |   | X 0-0<br>SH1-3<br>1B  |   |   | X 0-0<br>L5<br>2   | 0-0<br>FC6-4<br>1-2f<br>BB                                      | X 0-0<br>F8<br>2  | 5 1 2 1 0 0 3   |  |                |   |
| Buddy Kerr, R<br>OBP: 0.289, SLG: 0.308 (1, 6)       |   | X 0-0<br>E<br>1B<br>1-3<br>2-H<br>2B                             |   | X 0-0<br>SH1-3<br>1-2   |   |   | X 0-0<br>F7<br>3   |   | X 0-0<br>6-3<br>1   | 4 2 2 1 0 0 0   |  |                |   |
| Vern Bickford, R<br>OBP: 0.155, SLG: 0.128 (1, 1)    |   | X 0-0<br>F6<br>2   |   | X 0-0<br>5-3<br>2   |   |   | X 0-0<br>SH3-4<br>HR<br>1B                                       | X 0-0<br>6-3<br>2   | X 0-0<br>E<br>1B<br>1-2   | 5 1 2 0 0 0 3   |  |                |   |
| <b>Inning Stats</b>                                  | R: 0<br>E: 0<br>K: 0<br>S: 3<br>H: 0<br>LOB: 0<br>BB: 0<br>P: 3 | R: 4<br>E: 1<br>K: 0<br>S: 8<br>H: 4<br>LOB: 2<br>BB: 1<br>P: 12 | R: 0<br>E: 0<br>K: 0<br>S: 3<br>H: 0<br>LOB: 0<br>BB: 0<br>P: 3 | R: 0<br>E: 0<br>K: 0<br>S: 4<br>H: 1<br>LOB: 1<br>BB: 0<br>P: 4 | R: 0<br>E: 0<br>K: 2<br>S: 7<br>H: 0<br>LOB: 0<br>BB: 0<br>P: 7 | R: 1<br>E: 0<br>K: 0<br>S: 4<br>H: 1<br>LOB: 0<br>BB: 0<br>P: 4 | R: 2<br>E: 0<br>K: 0<br>S: 7<br>H: 4<br>LOB: 3<br>BB: 1<br>P: 11 | R: 0<br>E: 0<br>K: 0<br>S: 5<br>H: 2<br>LOB: 3<br>BB: 1<br>P: 9 | R: 2<br>E: 1<br>K: 0<br>S: 7<br>H: 3<br>LOB: 2<br>BB: 0<br>P: 7 | 1B: 10<br>2B: 2<br>3B: 0<br>HR: 3<br>SF: 0<br>SAC: 2<br>DP: 0<br>HBP: 0 | WP: 0<br>PB: 0<br>SB: 0<br>CS: 0<br>PA: 47 |                |   |
| <b>PITCHER</b>                                       | IP WLS BF H R ER SO BB IBB HBP BLK WP HR S P ERA WHIP           |  |   |   |   |   |  |   |   |   |  | <b>PITCHER</b> | IP WLS BF H R ER SO BB IBB HBP BLK WP HR S P ERA WHIP |
| Ken Raffensberger, L<br>ERA: 4.07 (1, 1)             | 6.1 L 29 8 7 5 2 1 0 0 0 0 0 2 32 36 7.11 1.421                 |  |   |   |   |   |  |   |   |   |  |                |   |
| Eddie ERAutt, R<br>ERA: 6.91 (7, 1)                  | 0.2 5 2 0 0 0 1 0 0 0 0 0 0 4 8 0.00 4.500                      |  |   |   |   |   |  |   |   |   |  |                |   |
| Herm Wehmeier, R<br>ERA: 5.68 (8, 1)                 | 2.0 13 5 2 1 0 0 1 0 0 0 0 1 12 16 4.50 2.500                   |  |   |   |   |   |  |   |   |   |  |                |   |

**Boston Braves @ Cincinnati Reds**  
 Crosley Field, Cincinnati, OH  
 Wed Aug 30 1950, 3:33 AM EDT  
 Att: 1,472 - Cloudy - 78 F

livebaseballscorecards.com

|     |    |
|-----|----|
| AB  | 42 |
| R   | 9  |
| H   | 15 |
| RBI | 7  |
| BB  | 3  |
| SO  | 2  |
| LOB | 17 |



| Batter  | 1                          | 2         | 3                       | 4         | 5          | 6 | 7          | 8                     | 9                       | AB R H RBI BB SO LOB  |
|---|----------------------------|-----------|-------------------------|-----------|------------|---|------------|-----------------------|-------------------------|---|
| <b>Bobby Adams, R</b><br>OBP: 0.351, SLG: 0.410<br>(1, 4) X     | 0-0<br>1B<br>2B            |           | 0-0<br>L5               | 0-0<br>F8 |            |   | 0-0<br>F9  |                       |                         | 4 1 1 0 0 0 0   |
| <b>Lloyd Merriman, L</b><br>OBP: 0.341, SLG: 0.367<br>(1, 8) X  | 0-0<br>FC5-4<br>2-H<br>1B  |           | 0-0<br>1B<br>1B         |           | 0-0<br>F8  |   |            | 4-0<br>G1-6-3<br>BB   |                         | 3 1 2 1 1 0 0   |
| <b>Johnny Wyrostek, L</b><br>OBP: 0.389, SLG: 0.449<br>(1, 9) X | 0-0<br>FC5-4<br>1-2f<br>1B |           | 0-0<br>1B<br>F8<br>1B   |           | 0-0<br>3-1 |   |            | 0-0<br>G1-6-3<br>1-2f |                         | 4 1 1 0 0 0 2   |
| <b>Ted Kluszewski, L</b><br>OBP: 0.360, SLG: 0.560<br>(1, 3) X  | 0-0<br>1-2<br>1B           |           | 0-0<br>F8<br>BB<br>1B   |           | 0-0<br>F9  |   |            | 0-0<br>G3             |                         | 4 0 2 1 0 0 0   |
| <b>Grady Hatton, L</b><br>OBP: 0.360, SLG: 0.388<br>(1, 5) X    | 0-0<br>F4                  |           | 4-0<br>1-2<br>BB        |           | 0-0<br>F6  |   |            | 0-0<br>3-1            |                         | 3 0 0 0 1 0 2   |
| <b>Joe Adcock, R</b><br>OBP: 0.308, SLG: 0.383<br>(1, 7) X      | 0-0<br>F4                  |           | 0-0<br>F8<br>2-3<br>3-H |           | 0-0<br>4-3 |   |            | 0-0<br>2B<br>1B       |                         | 4 1 1 1 0 0 4   |
| <b>Virgil Stallcup, R</b><br>OBP: 0.275, SLG: 0.348<br>(1, 6) X |                            | 0-0<br>F4 | 0-0<br>F8               |           | 0-0<br>5-3 |   |            | 0-0<br>F8             |                         | 4 0 0 0 0 0 3   |
| <b>Dixie Howell, R</b><br>OBP: 0.323, SLG: 0.295<br>(1, 2) X    |                            | 0-0<br>F7 |                         | 0-0<br>F4 |            |   | 0-0<br>F8  |                       | 0-0<br>FC5<br>1-H<br>2B | 2 0 0 0 0 0 0<br>1 0 0 0 0 0 0<br>1 0 1 1 0 0 0                                   |
| <b>Peanuts Lowrey, R</b><br>OBP: 0.320, SLG: 0.292<br>(7, PH)   |                            |           |                         |           |            |   |            |                       |                         |   |
| <b>Johnny Pramesa, R</b><br>OBP: 0.385, SLG: 0.467<br>(8, 2)    |                            |           |                         |           |            |   |            |                       |                         |   |
| <b>Ken Raffensberger, R</b><br>OBP: 0.178, SLG: 0.159<br>(1, 1) |                            | 0-3<br>K  |                         | 0-3<br>K  |            |   | 0-0<br>5-3 |                       | 0-0<br>FC5<br>2-3       | 2 0 0 0 0 2 0<br>0 0 0 0 0 0 0<br>1 0 0 0 0 0 0<br>0 0 0 0 0 0 0<br>1 0 0 0 0 0 1 |
| <b>Eddie Erault, R</b><br>OBP: 0.286, SLG: 0.429<br>(7, 1)      |                            |           |                         |           |            |   |            |                       |                         |   |
| <b>Danny Litwhiler, R</b><br>OBP: 0.370, SLG: 0.465<br>(7, PH)  |                            |           |                         |           |            |   |            |                       |                         |   |
| <b>Herm Wehmeier, R</b><br>OBP: 0.183, SLG: 0.210<br>(8, 1)     |                            |           |                         |           |            |   |            |                       |                         |   |
| <b>Bob Usher, R</b><br>OBP: 0.312, SLG: 0.366<br>(9, PH)        |                            |           |                         |           |            |   |            |                       |                         |   |

|  |                              |                                 |                              |                                 |                              |                                  |                              |                                 |                              |                                 |                              |                                 |                              |                                 |                              |                                 |                                  |                                    |                                  |        |
|--|------------------------------|---------------------------------|------------------------------|---------------------------------|------------------------------|----------------------------------|------------------------------|---------------------------------|------------------------------|---------------------------------|------------------------------|---------------------------------|------------------------------|---------------------------------|------------------------------|---------------------------------|----------------------------------|------------------------------------|----------------------------------|--------|
| <b>Inning Stats</b>  | R: 1<br>E: 0<br>K: 0<br>S: 6 | H: 3<br>LOB: 2<br>BB: 0<br>P: 6 | R: 0<br>E: 0<br>K: 1<br>S: 5 | H: 0<br>LOB: 0<br>BB: 0<br>P: 5 | R: 2<br>E: 0<br>K: 0<br>S: 6 | H: 3<br>LOB: 2<br>BB: 1<br>P: 10 | R: 0<br>E: 0<br>K: 1<br>S: 5 | H: 0<br>LOB: 0<br>BB: 0<br>P: 5 | R: 0<br>E: 0<br>K: 0<br>S: 3 | H: 0<br>LOB: 0<br>BB: 0<br>P: 3 | R: 0<br>E: 0<br>K: 0<br>S: 3 | H: 0<br>LOB: 0<br>BB: 0<br>P: 3 | R: 0<br>E: 0<br>K: 0<br>S: 2 | H: 0<br>LOB: 0<br>BB: 1<br>P: 6 | R: 1<br>E: 0<br>K: 0<br>S: 5 | H: 2<br>LOB: 1<br>BB: 0<br>P: 5 | 1B: 6<br>2B: 2<br>3B: 0<br>HR: 0 | SF: 0<br>SAC: 0<br>DP: 1<br>HBP: 0 | WP: 0<br>PB: 0<br>SB: 0<br>CS: 0 | PA: 36 |
| <b>PITCHER</b><br><b>Vern Bickford, R</b><br>ERA: 3.21<br>(1, 1) | IP<br>9.0                    | WLS<br>W                        | BF<br>36                     | H<br>8                          | R<br>4                       | ER<br>4                          | SO<br>2                      | BB<br>2                         | IBB<br>0                     | HBP<br>0                        | BLK<br>0                     | WP<br>0                         | HR<br>0                      | S<br>38                         | P<br>46                      | ERA<br>4.00                     | WHIP<br>1.111                    |                                    |                                  |        |
| <b>PITCHER</b>   | IP                           | WLS                             | BF                           | H                               | R                            | ER                               | SO                           | BB                              | IBB                          | HBP                             | BLK                          | WP                              | HR                           | S                               | P                            | ERA                             | WHIP                             |                                    |                                  |        |

**BOTTOM**

**Boston Braves @ Cincinnati Reds**  
Crosley Field, Cincinnati, OH

Wed Aug 30 1950, 3:33 AM EDT  
Att. 1,472 - Cloudy - 78 F

livebaseballscorecards.com

|            |           |
|------------|-----------|
| <b>AB</b>  | <b>34</b> |
| <b>R</b>   | <b>4</b>  |
| <b>H</b>   | <b>8</b>  |
| <b>RBI</b> | <b>4</b>  |
| <b>BB</b>  | <b>2</b>  |
| <b>SO</b>  | <b>2</b>  |
| <b>LOB</b> | <b>12</b> |



| Batter  | 1   | 2   | 3  | 4   | 5   | 6   | 7  | 8   | 9   | AB R H RBI BB SO LOB   | TOP  |                |   |
|---|---|---|--|---|---|---|--|---|---|--|--|----------------|---|
| <b>Bobby Adams, R</b> (1, 5)<br>OBP: 0.352, SLG: 0.411<br><b>Grady Hatton, L</b> (4, PH)<br>OBP: 0.362, SLG: 0.392 (4, 5) | 0-3<br>K  |   | 0-0<br>1B<br>1B  | 0-0<br>F7   |   |   | 4-0<br>FC1-6<br>BB   |   | 0-0<br>SH4-3<br>2B  | 2 1 1 0 0 1 0<br>2 0 1 0 1 0 0   |  |                |   |
| <b>Bob Usher, R</b> (1, 8)<br>OBP: 0.311, SLG: 0.365  | 0-3<br>K  |   | 0-0<br>HR<br>1B  | 0-0<br>P3   |   |   | 0-0<br>FC1-6<br>BB<br>1-2f                                       |   | 0-0<br>SH4-3<br>2-3   | 4 1 1 2 0 1 1  |  |                |   |
| <b>Johnny Wyrostek, L</b> (1, 9)<br>OBP: 0.391, SLG: 0.456  | 0-0<br>3-1  |   | 0-0<br>HR<br>1-H   |   |   |   | 4-0<br>FC6-4<br>BB<br>1-2  |   | 4-0<br>G4-3<br>BB   | 3 1 1 2 2 0 0  |  |                |   |
| <b>Ted Kluszewski, L</b> (1, 3)<br>OBP: 0.358, SLG: 0.556   |   | 0-0<br>4-3  | 0-0<br>BB<br>1B<br>F9<br>1B                                      |   |   |   | 0-0<br>F8  |   | 0-0<br>F5   | 5 1 1 0 0 0 5  |  |                |   |
| <b>Joe Adcock, R</b> (1, 7)<br>OBP: 0.307, SLG: 0.381   |   | 0-0<br>5-3  | 0-0<br>BB<br>1B<br>1-2   |   |   |   | 0-0<br>5-3<br>1-2  |   | 0-0<br>FC6-4<br>1-2f  | 4 0 1 0 0 0 3  |  |                |   |
| <b>Johnny Pramesa, R</b> (1, 2)<br>OBP: 0.382, SLG: 0.459   |   | 0-0<br>E6   | 4-0<br>BB<br>1-2<br>2-3<br>BB                                    |   |   |   | 0-0<br>L4  |   | 0-0<br>F9   | 3 0 0 0 1 0 1  |  |                |   |
| <b>Connie Ryan, R</b> (1, 4)<br>OBP: 0.362, SLG: 0.372  | 0-3<br>K  |   | 0-0<br>F9<br>3-H   |   |   |   | 0-0<br>P4  |   | 4-0<br>FC5-4<br>BB  | 3 0 0 1 1 1 3  |  |                |   |
| <b>Virgil Stallcup, R</b> (1, 6)<br>OBP: 0.272, SLG: 0.344  |   |   | 6-3<br>1-3   |   |   |   | 0-0<br>4-3   |   | 0-0<br>FC5-4<br>FC4-6<br>1-2f                                   | 4 0 0 0 0 0 3  |  |                |   |
| <b>Ewell Blackwell, R</b> (1, 1)<br>OBP: 0.143, SLG: 0.096  |   |   | 0-0<br>1B<br>1B  | 0-0<br>6-3  |   |   | 0-0<br>G3  |   | 0-0<br>FC4-6<br>1-2f  | 4 1 1 0 0 0 1  |  |                |   |
| <b>Inning Stats</b>   | R: 0<br>E: 0<br>K: 2<br>S: 7<br>H: 0<br>LOB: 0<br>BB: 0<br>P: 7 | R: 0<br>E: 1<br>K: 1<br>S: 6<br>H: 0<br>LOB: 1<br>BB: 0<br>P: 6 | R: 5<br>E: 0<br>K: 0<br>S: 9<br>H: 6<br>LOB: 2<br>BB: 1<br>P: 13 | R: 0<br>E: 0<br>K: 0<br>S: 3<br>H: 0<br>LOB: 0<br>BB: 0<br>P: 3 | R: 0<br>E: 1<br>K: 0<br>S: 4<br>H: 0<br>LOB: 1<br>BB: 0<br>P: 4 | R: 0<br>E: 0<br>K: 0<br>S: 3<br>H: 0<br>LOB: 0<br>BB: 0<br>P: 3 | R: 0<br>E: 0<br>K: 0<br>S: 3<br>H: 0<br>LOB: 2<br>BB: 2<br>P: 11 | R: 0<br>E: 0<br>K: 0<br>S: 3<br>H: 0<br>LOB: 1<br>BB: 1<br>P: 7 | R: 0<br>E: 0<br>K: 0<br>S: 3<br>H: 1<br>LOB: 1<br>BB: 1<br>P: 7 | 1B: 5<br>2B: 1<br>3B: 0<br>HR: 1<br>SF: 0<br>SAC: 1<br>DP: 1<br>HBP: 0 | WP: 0<br>PB: 0<br>SB: 0<br>CS: 0<br>PA: 40 |                |   |
| <b>PITCHER</b>  | IP WLS BF H R ER SO BB IBB HBP BLK WP HR S P ERA WHIP           |   |  |   |   |   |  |   |   |  |  | <b>PITCHER</b> | IP WLS BF H R ER SO BB IBB HBP BLK WP HR S P ERA WHIP |
| <b>Paul Minner, L</b> (1, 1)<br>ERA: 3.78   | 2.1 L 15 6 5 5 3 1 0 0 0 0 1 20 24 19.29 3.000                  |   |  |   |   |   |  |   |   |  |  |                |   |
| <b>Johnny Klippstein, R</b> (3, 1)<br>ERA: 5.38   | 5.2 21 0 0 0 0 3 0 0 0 0 0 0 18 30 0.00 0.529                   |   |  |   |   |   |  |   |   |  |  |                |   |
| <b>Johnny Schmitz, L</b> (9, 1)<br>ERA: 4.87  | 1.0 4 1 0 0 0 1 0 0 0 0 0 0 3 7 0.00 2.000                      |   |  |   |   |   |  |   |   |  |  |                |   |

**Cincinnati Reds @ Chicago Cubs**  
**Wrigley Field, Chicago, IL**  
 Sat Sep 02 1950, 3:33 AM CDT  
 Att: 12,261 - Unknown

[livebaseballscorecards.com](http://livebaseballscorecards.com)

|            |           |
|------------|-----------|
| <b>AB</b>  | <b>34</b> |
| <b>R</b>   | <b>5</b>  |
| <b>H</b>   | <b>7</b>  |
| <b>RBI</b> | <b>5</b>  |
| <b>BB</b>  | <b>5</b>  |
| <b>SO</b>  | <b>3</b>  |
| <b>LOB</b> | <b>17</b> |



BOTTOM

Cincinnati Reds @ Chicago Cubs

Wrigley Field, Chicago, IL

Sat Sep 02 1950, 3:33 AM CDT

Att. 12,261 - Unknown

livebaseballscorecards.com

|     |    |
|-----|----|
| AB  | 25 |
| R   | 1  |
| H   | 1  |
| RBI | 1  |
| BB  | 5  |
| SO  | 10 |
| LOB | 9  |



|     |   |     |    |
|-----|---|-----|----|
| WP: | 0 | PA: | 32 |
| PB: | 0 | SB: | 0  |
| CS: | 1 |     |    |

AB R H RBI BB SO LOB

3 0 0 1 0 1 1

2 0 1 0 2 1 0

4 0 0 0 0 2 4

4 0 0 0 0 2 1

1 0 0 0 0 0 0  
2 0 0 0 0 1 0













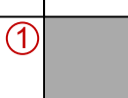

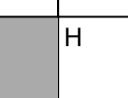





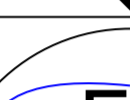



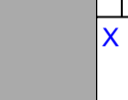



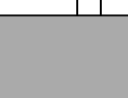
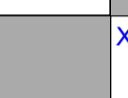









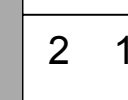

2 0 0 0 1 1 0

2 1 0 0 1 0 1

2 0 0 0 1 0 0

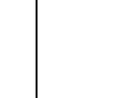
0 0 0 0 0 0 0  
2 0 0 0 0 2 0  
1 0 0 0 0 0 2  
0 0 0 0 0 0 0

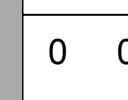
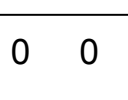
1B: 1 SF: 0  
2B: 1 SAC: 0  
3B: 0 DP: 2  
HR: 0 HBP: 1

| Batter   | 1   | 2   | 3   | 4   | 5   | 6   | 7 | 8  | 9 |
|--|---|---|---|---|---|---|---|--|---|
| <b>Carmen Mauro, L</b><br>OBP: 0.293, SLG: 0.333<br>(1, 9)    | 0-3    |   | H 1-0      |   |   | X 0-0      |   | X 0-0 <br>1-2f<br>3-H |   |
| <b>Phil Cavarretta, L</b><br>OBP: 0.385, SLG: 0.460<br>(1, 3)   | 4-0    |   | 4-0        |   |   | X 0-3     |   | X 0-0               |   |
| <b>Roy Smalley, R</b><br>OBP: 0.299, SLG: 0.426<br>(1, 6)   | 0-3    |   | X 0-0    |   |   | X 0-0    |   | X 0-3               |   |
| <b>Hank Sauer, R</b><br>OBP: 0.363, SLG: 0.533<br>(1, 7)    | 0-0  | 0-3      |   | X 0-3    |   | X 0-0    |   | X 0-0               |   |
| <b>Andy Pafko, R</b><br>OBP: 0.412, SLG: 0.625<br><b>Bob Borkowski, R</b><br>OBP: 0.327, SLG: 0.402<br>(1, 8)<br>(4, 8)  |   | X 0-0   |   | X 0-0   |   | X 0-3   |   | X 0-3              |   |
| <b>Bill Serena, R</b><br>OBP: 0.335, SLG: 0.420<br>(1, 5)   |   | 4-0    |   | X 0-3  |   | X 0-0  |   | X 4-0             |   |
| <b>Carl Sawatski, L</b><br>OBP: 0.191, SLG: 0.095<br>(1, 2)   |   | X 0-0  |   | X 0-0  |   | X 0-0  |   | X 4-0             |   |
| <b>Wayne Terwilliger, R</b><br>OBP: 0.307, SLG: 0.362<br>(1, 4)   |   |   | X 0-0  |   | X 0-0  | X 0-0  |   | X 4-0             |   |
| <b>Paul Minner, L</b><br>OBP: 0.276, SLG: 0.315<br><b>Johnny Klippstein, R</b><br>OBP: 0.333, SLG: 0.500<br><b>Ron Northey, L</b><br>OBP: 0.359, SLG: 0.481<br><b>Johnny Schmitz, R</b><br>OBP: 0.155, SLG: 0.175<br>(1, 1)<br>(3, 1)<br>(8, PH)<br>(9, 1) |   |   | X 0-3  |   | X 0-3  | X 0-3  |   | X 0-0             |   |

Inning Stats

PITCHER  
**Ewell Blackwell, R**  
ERA: 3.45  
(1, 1)

|     |     |    |   |   |    |    |    |     |     |     |    |    |    |    |      |       |
|-----|-----|----|---|---|----|----|----|-----|-----|-----|----|----|----|----|------|-------|
| IP  | WLS | BF | H | R | ER | SO | BB | IBB | HBP | BLK | WP | HR | S  | P  | ERA  | WHIP  |
| 9.0 | W   | 31 | 1 | 1 | 1  | 10 | 5  | 0   | 1   | 0   | 0  | 0  | 45 | 66 | 1.00 | 0.667 |

|    |     |    |   |   |    |    |    |     |     |     |    |    |   |   |     |      |
|----|-----|----|---|---|----|----|----|-----|-----|-----|----|----|---|---|-----|------|
| IP | WLS | BF | H | R | ER | SO | BB | IBB | HBP | BLK | WP | HR | S | P | ERA | WHIP |
|----|-----|----|---|---|----|----|----|-----|-----|-----|----|----|---|---|-----|------|

| Batter   | 1   | 2   | 3   | 4   | 5   | 6   | 7   | 8   | 9   | 10  | 11   | AB  | R                                       | H  | RBI | BB   | SO    | LOB | TOP |  |  |  |  |  |  |  |  |  |  |  |  |  |  |  |  |
|--|---|---|---|---|---|---|---|---|---|---|--|---|---|----|-----|------|-------|-----|-----|--|--|--|--|--|--|--|--|--|--|--|--|--|--|--|--|
| Lloyd Merriman, L (1, 8)<br>OBP: 0.335, SLG: 0.359<br>Bob Usher, R (10, 8)<br>OBP: 0.310, SLG: 0.363   | 0-3 K (1)   |   | x 0-0 L9 (1)  |   |   | x 0-0 F8 (1)  |   | x 0-0 P6 (1)  | x 0-0 P3 (3)  |   | x 0-0 E1 (1)   | 5   | 0                                       | 0  | 0   | 0    | 1     | 2   |     |  |  |  |  |  |  |  |  |  |  |  |  |  |  |  |  |
| Grady Hatton, L (1, 5)<br>OBP: 0.363, SLG: 0.390   | 0-0 P5 (2)  |   | x 0-0 P5 (2)  |   |   | x 0-3 K (2)   |   | x 4-0 P6 (2)  |   | x 0-0 FC6 (2)                                       | x 0-0 SH (2)   | 4   | 0                                       | 1  | 1   | 1    | 1     | 0   |     |  |  |  |  |  |  |  |  |  |  |  |  |  |  |  |  |
| Johnny Wyrostek, L (1, 9)<br>OBP: 0.389, SLG: 0.453  | 0-0 1B  |   | x 0-0 F9 (3)  |   |   | x 0-0 F9 (3)  |   | x 0-0 F9 (2)  |   | x 0-0 SH1-4 (1)                                     | x 0-3 K (2)  | 5   | 0                                       | 1  | 0   | 0    | 1     | 4   |     |  |  |  |  |  |  |  |  |  |  |  |  |  |  |  |  |
| Ted Kluszewski, L (1, 3)<br>OBP: 0.354, SLG: 0.548   | 0-0 P5 (3)  |   |   | x 0-0 F8 (1)  |   |   | x 0-0 G3 (1)  | x 0-0 6-3 (3)                                       |   | x 0-0 FC6 (2)                                       | x 0-0 4-3 (3)  | 6   | 0                                       | 0  | 0   | 0    | 0     | 6   |     |  |  |  |  |  |  |  |  |  |  |  |  |  |  |  |  |
| Joe Adcock, R (1, 7)<br>OBP: 0.313, SLG: 0.385   |   | x 0-0 HR (1)  |   | x 0-0 G5-4-3 (2)                                    |   |   | x 0-0 2B (1)  |   | x 0-0 4-3 (1)                                       | x 0-0 G5-4-3 (2)                                    |  | 5   | 2                                       | 3  | 0   | 0    | 0     | 2   |     |  |  |  |  |  |  |  |  |  |  |  |  |  |  |  |  |
| Johnny Pramesa, R (1, 2)<br>OBP: 0.377, SLG: 0.469   |   | x 0-0 HR (1)  |   | x 0-0 G5-4-3 (2)                                    |   |   | x 0-0 F8 (2)  |   | x 0-0 F8 (2)  |   | x 0-0 F5 (1)   | 5   | 1                                       | 1  | 2   | 0    | 0     | 2   |     |  |  |  |  |  |  |  |  |  |  |  |  |  |  |  |  |
| Connie Ryan, R (1, 4)<br>OBP: 0.367, SLG: 0.380  |   | x 0-0 P3 (1)  |   | x 0-0 F2 (1)  |   |   | x 0-0 1B (2)  |   | x 0-0 1B (1)  |   | x 0-0 BB (1)   | 5   | 3                                       | 4  | 1   | 0    | 0     | 0   |     |  |  |  |  |  |  |  |  |  |  |  |  |  |  |  |  |
| Virgil Stallcup, R (1, 6)<br>OBP: 0.272, SLG: 0.344<br>Bob Scheffing, R (9, PH)<br>OBP: 0.299, SLG: 0.365<br>Bobby Adams, R (9, PR)<br>OBP: 0.352, SLG: 0.411<br>Sammy Meeks, R (9, 6)<br>OBP: 0.326, SLG: 0.383   | 0-0 P3 (2)  |   | x 0-0 F8 (2)  |   |   | x 0-0 F8 (2)  |   | x 0-0 1B (2)  |   | x 0-0 E4 (1)  | x 0-0 SH (1)   | 3   | 0                                       | 1  | 1   | 0    | 0     | 1   |     |  |  |  |  |  |  |  |  |  |  |  |  |  |  |  |  |
| Ken Raffensberger, R (1, 1)<br>OBP: 0.171, SLG: 0.193<br>Frank Smith, R (8, 1)<br>OBP: 0.059, SLG: 0.059<br>Herm Wehmeier, R (8, 1)<br>OBP: 0.183, SLG: 0.210<br>Danny Litwiler, R (9, PH)<br>OBP: 0.375, SLG: 0.470<br>Peanuts Lowrey, R (9, PR)<br>OBP: 0.320, SLG: 0.292<br>Harry Perkowski, L (9, 1)<br>OBP: 0.348, SLG: 0.318<br>Eddie Erault, R (9, 1)<br>OBP: 0.379, SLG: 0.429 | 0-0 F8 (3)  |   | x 0-0 K (3)   |   |   | x 0-3 K (3)   |   | x 0-0 6-3 (3)                                       |   | x 0-0 1B (2)  | x 0-0 SH (1)   | 3   | 0                                       | 0  | 0   | 0    | 1     | 1   |     |  |  |  |  |  |  |  |  |  |  |  |  |  |  |  |  |
| <b>Inning Stats</b>  | R: 0 H: 1<br>E: 0 LOB: 1<br>K: 1 BB: 0<br>S: 6 P: 6   | R: 2 H: 3<br>E: 0 LOB: 0<br>K: 0 BB: 0<br>S: 5 P: 5 | R: 0 H: 0<br>E: 0 LOB: 0<br>K: 0 BB: 0<br>S: 3 P: 3 | R: 0 H: 1<br>E: 0 LOB: 0<br>K: 0 BB: 0<br>S: 3 P: 3 | R: 0 H: 0<br>E: 0 LOB: 0<br>K: 1 BB: 0<br>S: 5 P: 5 | R: 0 H: 0<br>E: 0 LOB: 0<br>K: 1 BB: 0<br>S: 5 P: 5 | R: 2 H: 3<br>E: 0 LOB: 1<br>K: 0 BB: 0<br>S: 6 P: 6 | R: 0 H: 0<br>E: 0 LOB: 1<br>K: 0 BB: 1<br>S: 3 P: 7 | R: 1 H: 2<br>E: 1 LOB: 2<br>K: 0 BB: 0<br>S: 6 P: 6 | R: 0 H: 1<br>E: 0 LOB: 1<br>K: 0 BB: 0<br>S: 4 P: 4 | R: 2 H: 2<br>E: 2 LOB: 3<br>K: 1 BB: 1<br>S: 9 P: 13 | 1B: 11 SF: 0<br>2B: 2 SAC: 2<br>3B: 0 DP: 3<br>HR: 1 HBP: 0 | WP: 0 PA: 49<br>PB: 1<br>SB: 1<br>CS: 0 |    |     |      |       |     |     |  |  |  |  |  |  |  |  |  |  |  |  |  |  |  |  |
| <b>PITCHER</b>   | IP WLS BF H R ER SO BB IBB HBP BLK WP HR S P ERA WHIP |   |   |   |   |   |   |   |   |   |  |   |   |    |     |      |       |     |     |  |  |  |  |  |  |  |  |  |  |  |  |  |  |  |  |
| Frank Hiller, R (1, 1)<br>ERA: 3.83  | 7.0   | 27  | 8   | 4   | 4   | 3   | 0   | 0   | 0   | 0   | 0  | 0   | 1                                       | 33 | 33  | 5.14 | 1.143 |     |     |  |  |  |  |  |  |  |  |  |  |  |  |  |  |  |  |
| Dutch Leonard, R (8, 1)<br>ERA: 4.31   | 2.0   | 10  | 2   | 1   | 0   | 0   | 1   | 0   | 0   | 0   | 0  | 0   | 0                                       | 9  | 13  | 0.00 | 1.500 |     |     |  |  |  |  |  |  |  |  |  |  |  |  |  |  |  |  |
| Johnny Schmitz, L (10, 1)<br>ERA: 4.84   | 1.0   | 4   | 1   | 0   | 0   | 0   | 0   | 0   | 0   | 0   | 0  | 0   | 0                                       | 4  | 4   | 0.00 | 1.000 |     |     |  |  |  |  |  |  |  |  |  |  |  |  |  |  |  |  |
| Doyle Lade, R (11, 1)<br>ERA: 4.86   | 0.1   | L 4   | 2   | 2   | 0   | 0   | 1   | 0   | 0   | 0   | 0  | 0   | 0                                       | 3  | 7   | 0.00 | 9.000 |     |     |  |  |  |  |  |  |  |  |  |  |  |  |  |  |  |  |
| Johnny Vander Meer, L (11, 1)<br>ERA: 4.05   | 0.2   | 4   | 0   | 0   | 0   | 1   | 0   | 0   | 0   | 0   | 0  | 0   | 0                                       | 6  | 6   | 0.00 | 0.000 |     |     |  |  |  |  |  |  |  |  |  |  |  |  |  |  |  |  |

Cincinnati Reds @ Chicago Cubs  
Wrigley Field, Chicago, IL  
Sun Sep 03 1950, 3:33 AM CDT  
Att. 18,197 - Unknown

livebaseballscorecards.com

|     |    |
|-----|----|
| AB  | 44 |
| R   | 7  |
| H   | 13 |
| RBI | 6  |
| BB  | 2  |
| SO  | 4  |
| LOB | 20 |



| Batter   | 1              | 2          | 3                | 4         | 5                   | 6          | 7                      | 8                         | 9                | 10                       | 11         | AB R H RBI BB SO LOB   |
|--|----------------|------------|------------------|-----------|---------------------|------------|------------------------|---------------------------|------------------|--------------------------|------------|--|
| Hal Jeffcoat, R<br>OBP: 0.246, SLG: 0.300<br>(1, 8)        | 0-0<br>S<br>1B |            | 0-0<br>1B        |           |                     | 0-0<br>5-3 | 4-0<br>1-2<br>BB       |                           | 0-3<br>K         |                          | 0-0<br>G3  | 5 0 2 0 1 1 0  |
| Bob Borkowski, R<br>OBP: 0.327, SLG: 0.397<br>(1, 9)       | 0-0<br>F8      |            | 0-0<br>1-2<br>1B |           |                     | 0-0<br>F9  | 0-0<br>P4              |                           | 4-0<br>BB<br>BB  |                          | 0-0<br>5-3 | 5 0 1 0 1 0 3  |
| Roy Smalley, R<br>OBP: 0.300, SLG: 0.424<br>(1, 6)         | 0-3<br>K       |            | 0-3<br>K         |           |                     | 0-0<br>F9  |                        | 0-0<br>FC1-5<br>1B        | 4-0<br>1-2<br>BB |                          | 0-0<br>6-3 | 5 0 1 0 1 2 3  |
| Hank Sauer, R<br>OBP: 0.363, SLG: 0.531<br>(1, 7)          | 0-0<br>F9      |            |                  | 0-0<br>F8 |                     |            | 0-0<br>E<br>4-3<br>1B  | 0-0<br>1-2<br>FC1-5<br>1B | 0-0<br>P5        |                          |            | 5 2 2 0 0 0 3  |
| Bill Serena, R<br>OBP: 0.336, SLG: 0.419<br>(1, 5)         |                | 0-0<br>F7  |                  | 0-0<br>F9 |                     |            | 0-0<br>E7<br>4-3<br>1B | 0-0<br>FC1-5<br>1B<br>F8  |                  | 4-0<br>1B<br>FC4-2<br>BB |            | 4 2 1 0 1 0 2  |
| Phil Cavarretta, L<br>OBP: 0.382, SLG: 0.455<br>(1, 3)     |                | 0-0<br>4-3 |                  | 0-0<br>P6 |                     |            | 0-0<br>4-3             | 0-0<br>1-3<br>2-3<br>3-H  |                  | 0-0<br>F7                |            | 5 0 1 2 0 0 2  |
| Wayne Terwilliger, R<br>OBP: 0.307, SLG: 0.364<br>(8, PH)  |                | 0-0<br>G1  |                  |           | 0-0<br>F8           |            | 0-0<br>E9<br>1B<br>2B  | 0-0<br>F8                 |                  | 0-0<br>FC4-2<br>1B       |            | 3 1 1 1 0 0 0<br>1 0 0 1 0 0 1<br>1 0 1 0 0 0 0  |
| Bob Ramazzotti, R<br>OBP: 0.277, SLG: 0.336<br>(9, 4)      |                |            |                  |           |                     |            |                        |                           |                  |                          |            |  |
| Mickey Owen, R<br>OBP: 0.278, SLG: 0.309<br>(1, 2)         |                |            | 0-0<br>5-3       |           | 0-0<br>F8           |            | 0-0<br>E9<br>1B<br>2B  | 0-0<br>F8                 |                  | 0-0<br>FC4-2<br>1B       |            | 4 0 2 1 0 0 1<br>1 0 0 0 0 0 2<br>0 0 0 0 0 0 0<br>0 0 0 0 0 0 0                                   |
| Preston Ward, L<br>OBP: 0.329, SLG: 0.384<br>(10, PH)      |                |            |                  |           | 0-0<br>G6-4-3<br>1B |            | 0-0<br>BB<br>1B        | 0-0<br>P6                 |                  | 0-0<br>FC4-2             |            |  |
| Doyle Lade, R<br>OBP: 0.324, SLG: 0.343<br>(11, 1)         |                |            |                  |           |                     |            |                        |                           |                  | 0-0<br>1-2<br>3-H        |            |  |
| Johnny Vander Meer, S<br>OBP: 0.133, SLG: 0.214<br>(11, 1) |                |            |                  |           | 0-0<br>5-3          |            | 0-0<br>G6-4-3<br>1B    |                           | 0-0<br>1-3       | 0-3<br>K                 |            | 2 0 0 0 0 0 1<br>1 0 0 0 0 0 1<br>0 0 0 0 0 0 0<br>1 0 0 0 0 0 0<br>0 0 0 0 0 0 0<br>1 0 0 0 0 0 2 |
| Frank Hiller, R<br>OBP: 0.129, SLG: 0.100<br>(7, PH)       |                |            |                  |           |                     |            |                        |                           |                  |                          |            |  |
| Andy Parko, R<br>OBP: 0.411, SLG: 0.624<br>(8, 1)          |                |            |                  |           |                     |            |                        |                           |                  |                          |            |  |
| Dutch Leonard, R<br>OBP: 0.067, SLG: 0.067<br>(9, PH)      |                |            |                  |           |                     |            |                        |                           |                  |                          |            |  |
| Carmen Mauro, L<br>OBP: 0.291, SLG: 0.331<br>(10, 1)       |                |            |                  |           |                     |            |                        |                           |                  |                          |            |  |
| Johnny Schmitz, R<br>OBP: 0.165, SLG: 0.175<br>(10, PH)    |                |            |                  |           |                     |            |                        |                           |                  |                          |            |  |
| Carl Sawatski, L<br>OBP: 0.188, SLG: 0.093<br>(11, 2)      |                |            |                  |           |                     |            |                        |                           |                  |                          |            |  |

| Inning Stats | R: 0   | H: 1 | R: 0   | H: 0 | R: 0   | H: 2 | R: 0   | H: 0 | R: 0   | H: 1 | R: 0   | H: 0 | R: 3   | H: 4 | R: 2   | H: 3 | R: 0   | H: 0 | R: 0   | H: 1 | R: 0   | H: 0 |        |
|--------------|--------|------|--------|------|--------|------|--------|------|--------|------|--------|------|--------|------|--------|------|--------|------|--------|------|--------|------|--------|
| E: 0         | LOB: 1 | E: 0 | LOB: 0 | E: 0 | LOB: 2 | E: 0 | LOB: 0 | E: 0 | LOB: 0 | E: 0 | LOB: 0 | E: 0 | LOB: 2 | E: 0 | LOB: 1 | E: 0 | LOB: 2 | E: 0 | LOB: 2 | E: 0 | LOB: 2 | E: 0 | LOB: 0 |
| K: 1         | BB: 0  | K: 0 | BB: 0  | K: 1 | BB: 0  | K: 0 | BB: 0  | K: 0 | BB: 0  | K: 0 | BB: 0  | K: 0 | BB: 1  | K: 0 | BB: 0  | K: 1 | BB: 2  | K: 0 | BB: 2  | K: 1 | BB: 1  | K: 0 | BB: 0  |
| S: 6         | P: 6   | S: 3 | P: 3   | S: 7 | P: 7   | S: 3 | P: 3   | S: 3 | P: 3   | S: 3 | P: 3   | S: 3 | P: 11  | S: 6 | P: 6   | S: 5 | P: 13  | S: 6 | P: 10  | S: 3 | P: 3   | S: 3 | P: 3   |

|        |        |       |        |
|--------|--------|-------|--------|
| 1B: 11 | SF: 0  | WP: 0 | PA: 48 |
| 2B: 1  | SAC: 0 | PB: 0 |        |
| 3B: 0  | DP: 1  | SB: 1 |        |
| HR: 0  | HBP: 0 | CS: 0 |        |

| PITCHER                                     | IP  | WLS | BF | H | R | ER | SO | BB | IBB | HBP | BLK | WP | HR | S  | P  | ERA   | WHIP  |
|---|-----|-----|----|---|---|----|----|----|-----|-----|-----|----|----|----|----|-------|-------|
| Ken Raffensberger, L<br>ERA: 4.11<br>(1, 1) | 7.0 |     | 30 | 9 | 4 | 4  | 2  | 1  | 0   | 0   | 0   | 0  | 0  | 33 | 37 | 5.14  | 1.429 |
| Frank Smith, R<br>ERA: 3.42<br>(8, 1)       | 0.1 |     | 3  | 2 | 0 | 0  | 0  | 0  | 0   | 0   | 0   | 0  | 0  | 3  | 3  | 0.00  | 6.000 |
| Herm Wehmeier, R<br>ERA: 5.67<br>(8, 1)     | 0.2 |     | 2  | 0 | 1 | 1  | 0  | 0  | 0   | 0   | 0   | 0  | 0  | 2  | 2  | 13.50 | 0.000 |
| Harry Perkowski, L<br>ERA: 4.98<br>(9, 1)   | 0.2 |     | 4  | 0 | 0 | 0  | 1  | 2  | 0   | 0   | 0   | 0  | 0  | 4  | 12 | 0.00  | 3.000 |
| Eddie Eräutt, R<br>ERA: 6.55<br>(9, 1)      | 2.1 | W   | 9  | 1 | 0 | 0  | 1  | 1  | 0   | 0   | 0   | 0  | 0  | 10 | 14 | 0.00  | 0.857 |

BOTTOM

Cincinnati Reds @ Chicago Cubs  
Wrigley Field, Chicago, IL  
Sun Sep 03 1950, 3:33 AM CDT  
Att. 18,197 - Unknown

livebaseballscores.com

|     |    |
|-----|----|
| AB  | 44 |
| R   | 5  |
| H   | 12 |
| RBI | 5  |
| BB  | 4  |
| SO  | 4  |
| LOB | 21 |



| Batter  | 1                            | 2                               | 3                            | 4                               | 5                            | 6                               | 7                            | 8                               | 9                            | AB R H RBI BB SO LOB            | TOP  |                                 |                              |                                 |                              |                                 |                              |                                 |                                  |                                    |                                  |             |               |
|---|------------------------------|---------------------------------|------------------------------|---------------------------------|------------------------------|---------------------------------|------------------------------|---------------------------------|------------------------------|---------------------------------|--|---------------------------------|------------------------------|---------------------------------|------------------------------|---------------------------------|------------------------------|---------------------------------|----------------------------------|------------------------------------|----------------------------------|-------------|---------------|
| Tommy Glaviano, R (1, 5)<br>OBP: 0.431, SLG: 0.473      | 0-0<br>6-3                   |                                 | 0-0<br>5-3                   |                                 | 0-3<br>K                     |                                 | 0-0<br>F4                    |                                 |                              | 4 0 0 0 0 1 2                   | <b>St. Louis Cardinals @ Cincinnati Reds</b><br>Crosley Field, Cincinnati, OH<br>Mon Sep 04 1950, 3:33 AM EDT<br>Unknown<br><a href="http://livebaseballscorecards.com">livebaseballscorecards.com</a> |                                 |                              |                                 |                              |                                 |                              |                                 |                                  |                                    |                                  |             |               |
| Red Schoendienst, S (1, 4)<br>OBP: 0.314, SLG: 0.413    | 0-0<br>F5                    |                                 |                              | 0-0<br>HR<br>1B                 |                              | 0-0<br>2B<br>1B                 | 0-0<br>1-3                   |                                 |                              | 4 2 2 0 0 0 1                   |  |                                 |                              |                                 |                              |                                 |                              |                                 |                                  |                                    |                                  |             |               |
| Stan Musial, L (1, 7)<br>OBP: 0.446, SLG: 0.613         | 0-0<br>1-3                   |                                 |                              | 0-0<br>1-H<br>HR                |                              | 0-0<br>F9                       |                              | 0-0<br>F8                       |                              | 4 1 1 2 0 0 1                   |  |                                 |                              |                                 |                              |                                 |                              |                                 |                                  |                                    |                                  |             |               |
| Enos Slaughter, L (1, 9)<br>OBP: 0.370, SLG: 0.436      |                              | 0-0<br>F9                       |                              | 0-0<br>F8                       |                              | 0-0<br>1B<br>2B                 |                              | 0-0<br>F7                       |                              | 4 1 1 0 0 0 0                   |  |                                 |                              |                                 |                              |                                 |                              |                                 |                                  |                                    |                                  |             |               |
| Bill Howerton, L (1, 8)<br>OBP: 0.385, SLG: 0.504       |                              | 0-0<br>1B                       |                              | 0-0<br>F7                       |                              | 0-0<br>F5                       |                              | 4-0<br>BB                       |                              | 3 0 1 0 1 0 2                   |  |                                 |                              |                                 |                              |                                 |                              |                                 |                                  |                                    |                                  |             |               |
| Marty Marion, R (1, 6)<br>OBP: 0.338, SLG: 0.346        |                              | 0-3<br>K                        |                              | 0-0<br>6-3                      |                              | 0-0<br>2-H<br>3-H<br>1B         |                              | 0-0<br>6-3                      |                              | 4 0 1 2 0 1 2                   |  |                                 |                              |                                 |                              |                                 |                              |                                 |                                  |                                    |                                  |             |               |
| Rocky Nelson, L (1, 3)<br>OBP: 0.332, SLG: 0.349        |                              | 0-0<br>F3                       |                              |                                 | 0-0<br>F6                    | 0-0<br>4-3                      |                              | 0-0<br>F6                       |                              | 4 0 0 0 0 0 2                   |  |                                 |                              |                                 |                              |                                 |                              |                                 |                                  |                                    |                                  |             |               |
| Del Rice, R (1, 2)<br>OBP: 0.342, SLG: 0.402            |                              |                                 | 0-0<br>F8                    |                                 | 0-0<br>F7                    |                                 | 4-0<br>BB                    |                                 | 0-0<br>1-3                   | 2 0 0 0 1 0 0                   |  |                                 |                              |                                 |                              |                                 |                              |                                 |                                  |                                    |                                  |             |               |
| Chuck Diering, R (7, PR)<br>OBP: 0.359, SLG: 0.343      |                              |                                 |                              |                                 |                              |                                 |                              |                                 |                              | 0 0 0 0 0 0 0                   |  |                                 |                              |                                 |                              |                                 |                              |                                 |                                  |                                    |                                  |             |               |
| Joe Garagiola, L (7, 2)<br>OBP: 0.404, SLG: 0.513       |                              |                                 |                              |                                 |                              |                                 |                              |                                 |                              | 1 0 0 0 0 0 0                   |  |                                 |                              |                                 |                              |                                 |                              |                                 |                                  |                                    |                                  |             |               |
| Max Lanier, R (1, 1)<br>OBP: 0.209, SLG: 0.219          |                              |                                 | 0-0<br>F6                    |                                 | 0-0<br>1B                    |                                 | 0-0<br>F3                    |                                 | 0-0<br>F9                    | 1 0 0 0 0 0 0                   |   |                                 |                              |                                 |                              |                                 |                              |                                 |                                  |                                    |                                  |             |               |
| Al Brazle, L (4, 1)<br>OBP: 0.208, SLG: 0.208           |                              |                                 |                              |                                 |                              |                                 |                              |                                 |                              | 2 0 1 0 0 0 1                   |  |                                 |                              |                                 |                              |                                 |                              |                                 |                                  |                                    |                                  |             |               |
| Hal Rice, L (9, PH)<br>OBP: 0.254, SLG: 0.189           |                              |                                 |                              |                                 |                              |                                 |                              |                                 |                              | 1 0 0 0 0 0 0                   |  |                                 |                              |                                 |                              |                                 |                              |                                 |                                  |                                    |                                  |             |               |
| <b>Inning Stats</b>                                     | R: 0<br>E: 0<br>K: 0<br>S: 3 | H: 0<br>LOB: 0<br>BB: 0<br>P: 3 | R: 0<br>E: 0<br>K: 1<br>S: 6 | H: 1<br>LOB: 1<br>BB: 0<br>P: 6 | R: 0<br>E: 0<br>K: 0<br>S: 3 | H: 0<br>LOB: 0<br>BB: 0<br>P: 3 | R: 2<br>E: 0<br>K: 0<br>S: 5 | H: 2<br>LOB: 0<br>BB: 0<br>P: 5 | R: 0<br>E: 0<br>K: 1<br>S: 6 | H: 1<br>LOB: 1<br>BB: 0<br>P: 6 | R: 2<br>E: 0<br>K: 0<br>S: 6   | H: 3<br>LOB: 1<br>BB: 0<br>P: 6 | R: 0<br>E: 0<br>K: 0<br>S: 3 | H: 0<br>LOB: 1<br>BB: 1<br>P: 7 | R: 0<br>E: 0<br>K: 0<br>S: 3 | H: 0<br>LOB: 1<br>BB: 1<br>P: 7 | R: 0<br>E: 0<br>K: 0<br>S: 3 | H: 0<br>LOB: 0<br>BB: 0<br>P: 3 | 1B: 5<br>2B: 1<br>3B: 0<br>HR: 1 | SF: 0<br>SAC: 0<br>DP: 0<br>HBP: 0 | WP: 0<br>PB: 0<br>SB: 0<br>CS: 0 | PA: 36      |               |
| <b>PITCHER</b><br>Willie Ramsdell, R (1, 1)<br>ERA: 3.9 | IP<br>9.0                    | WLS<br>W                        | BF<br>36                     | H<br>7                          | R<br>4                       | ER<br>4                         | SO<br>2                      | BB<br>2                         | IBB<br>0                     | HBP<br>0                        | BLK<br>0   | WP<br>0                         | HR<br>1                      | S<br>38                         | P<br>46                      | ERA<br>4.00                     | WHIP<br>1.000                |                                 |                                  |                                    |                                  | ERA<br>4.00 | WHIP<br>1.000 |



| Batter   | 1                        | 2                        | 3                           | 4                                | 5               | 6                       | 7              | 8                                   | 9 |
|--|--------------------------|--------------------------|-----------------------------|----------------------------------|-----------------|-------------------------|----------------|-------------------------------------|---|
| <b>Bobby Adams, R</b><br>OBP: 0.353, SLG: 0.414 (1, 5) X     | 0-0<br>E4<br>SH2-4<br>1B | 0-0<br>G3<br>2-H<br>1B   |                             | 0-0<br>FC6-2<br>1-3<br>1B<br>2B  |                 | 0-0<br>F7<br>1          |                | 0-0<br>FC5-4<br>G6-4-3<br>1-2f<br>1 |   |
| <b>Bob Usher, R</b><br>OBP: 0.309, SLG: 0.362 (1, 8) X       | 0-0<br>SH2-4<br>1-2      | 0-0<br>G3<br>1-2         |                             | 0-0<br>FC6-2<br>1B<br>2-3<br>3-H |                 | 0-0<br>FC6<br>1B<br>2   |                | 0-0<br>G6-4-3<br>1-2f<br>2<br>3     |   |
| <b>Johnny Wyrostek, L</b><br>OBP: 0.390, SLG: 0.453 (1, 9) X | 0-0<br>4-3<br>2-H<br>1B  | 0-0<br>1-3<br>3          |                             | 0-0<br>BB<br>1B<br>2-H<br>3-H    |                 | 0-0<br>FC6<br>1-2f<br>2 |                |                                     |   |
| <b>Ted Kluszewski, L</b><br>OBP: 0.355, SLG: 0.546 (1, 3) X  | 0-0<br>4-3<br>2-3        |                          | 0-0<br>FC5-4<br>BB<br>BBB   | 0-0<br>BB<br>1B<br>1-2           |                 | 0-0<br>1-3<br>3         |                |                                     |   |
| <b>Joe Adcock, R</b><br>OBP: 0.315, SLG: 0.385 (1, 7) X      | 0-0<br>E<br>3-H<br>1B    |                          | 0-0<br>FC5-4<br>1-2f<br>BBB | 0-0<br>FC6-4<br>BB<br>1-2<br>2-3 |                 | 0-0<br>6-3<br>1         |                |                                     |   |
| <b>Johnny Pramesa, R</b><br>OBP: 0.374, SLG: 0.464 (1, 2) X  | 0-0<br>E6<br>1-3         |                          | 0-0<br>F8<br>2              | 0-0<br>FC6-4<br>1-2f<br>3        |                 | 0-0<br>FC4-6<br>1B<br>1 |                |                                     |   |
| <b>Connie Ryan, R</b><br>OBP: 0.363, SLG: 0.376 (1, 4) X     | 0-0<br>F9<br>3           |                          | 0-0<br>1-3<br>3             |                                  | 0-0<br>1-3<br>1 |                         | 0-0<br>F5<br>2 |                                     |   |
| <b>Virgil Stallcup, R</b><br>OBP: 0.275, SLG: 0.346 (1, 6) X |                          | 0-0<br>SH1-3<br>1B       |                             | 0-0<br>2B<br>FC6-2<br>1B         |                 | 0-0<br>6-3<br>2         |                | 0-0<br>FC4-6<br>1-2f<br>3           |   |
| <b>Willie Ramsdell, R</b><br>OBP: 0.280, SLG: 0.217 (1, 1) X |                          | 0-0<br>SH1-3<br>1-2<br>1 |                             | 0-0<br>F2<br>1                   |                 | 0-0<br>1-3<br>3         |                | 0-0<br>FC5-4<br>1B<br>1             |   |

| Inning Stats | R: 2 | H: 2 | E: 2 | LOB: 2 | K: 0 | BB: 0 | S: 7 | P: 7 | R: 1 | H: 2 | E: 0 | LOB: 1 | K: 0 | BB: 0 | S: 5 | P: 5 | R: 0 | H: 0 | E: 0 | LOB: 1 | K: 0 | BB: 1 | S: 3 | P: 7 | R: 2 | H: 4 | E: 0 | LOB: 3 | K: 0 | BB: 1 | S: 7 | P: 11 | R: 0 | H: 0 | E: 0 | LOB: 0 | K: 0 | BB: 0 | S: 3 | P: 3 | R: 0 | H: 1 | E: 0 | LOB: 1 | K: 0 | BB: 0 | S: 4 | P: 4 | R: 0 | H: 1 | E: 0 | LOB: 1 | K: 0 | BB: 0 | S: 4 | P: 4 | R: 0 | H: 1 | E: 0 | LOB: 0 | K: 0 | BB: 0 | S: 3 | P: 3 |
|--------------|------|------|------|--------|------|-------|------|------|------|------|------|--------|------|-------|------|------|------|------|------|--------|------|-------|------|------|------|------|------|--------|------|-------|------|-------|------|------|------|--------|------|-------|------|------|------|------|------|--------|------|-------|------|------|------|------|------|--------|------|-------|------|------|------|------|------|--------|------|-------|------|------|
|--------------|------|------|------|--------|------|-------|------|------|------|------|------|--------|------|-------|------|------|------|------|------|--------|------|-------|------|------|------|------|------|--------|------|-------|------|-------|------|------|------|--------|------|-------|------|------|------|------|------|--------|------|-------|------|------|------|------|------|--------|------|-------|------|------|------|------|------|--------|------|-------|------|------|

| PITCHER                                  | IP  | WLS | BF | H | R | ER | SO | BB | IBB | HBP | BLK | WP | HR | S  | P  | ERA  | WHIP  |
|--|-----|-----|----|---|---|----|----|----|-----|-----|-----|----|----|----|----|------|-------|
| <b>Max Lanier, L</b><br>ERA: 2.77 (1, 1) | 3.2 | L   | 22 | 8 | 5 | 3  | 0  | 1  | 0   | 0   | 0   | 0  | 0  | 21 | 25 | 7.36 | 2.455 |
| <b>Al Brazle, L</b><br>ERA: 4.48 (4, 1)  | 4.1 |     | 16 | 3 | 0 | 0  | 0  | 1  | 0   | 0   | 0   | 0  | 0  | 15 | 19 | 0.00 | 0.923 |

AB R H RBI BB SO LOB

|   |   |   |   |   |   |   |
|---|---|---|---|---|---|---|
| 5 | 2 | 2 | 1 | 0 | 0 | 1 |
| 4 | 1 | 1 | 0 | 0 | 0 | 4 |
| 4 | 1 | 2 | 3 | 0 | 0 | 2 |
| 3 | 0 | 1 | 0 | 1 | 0 | 2 |
| 3 | 0 | 1 | 1 | 1 | 0 | 1 |
| 4 | 0 | 1 | 0 | 0 | 0 | 5 |
| 4 | 0 | 0 | 0 | 0 | 0 | 4 |
| 4 | 1 | 2 | 0 | 0 | 0 | 1 |
| 3 | 0 | 1 | 0 | 0 | 0 | 1 |

|     |    |
|-----|----|
| AB  | 34 |
| R   | 5  |
| H   | 11 |
| RBI | 5  |
| BB  | 2  |
| SO  | 0  |
| LOB | 21 |

| WP | PA | ERA | WHIP |
|----|----|-----|------|
| 0  | 38 |     |      |

**St. Louis Cardinals @ Cincinnati Reds**  
Crosley Field, Cincinnati, OH  
Mon Sep 04 1950, 3:33 AM EDT  
Unknown

livebaseballscorecards.com

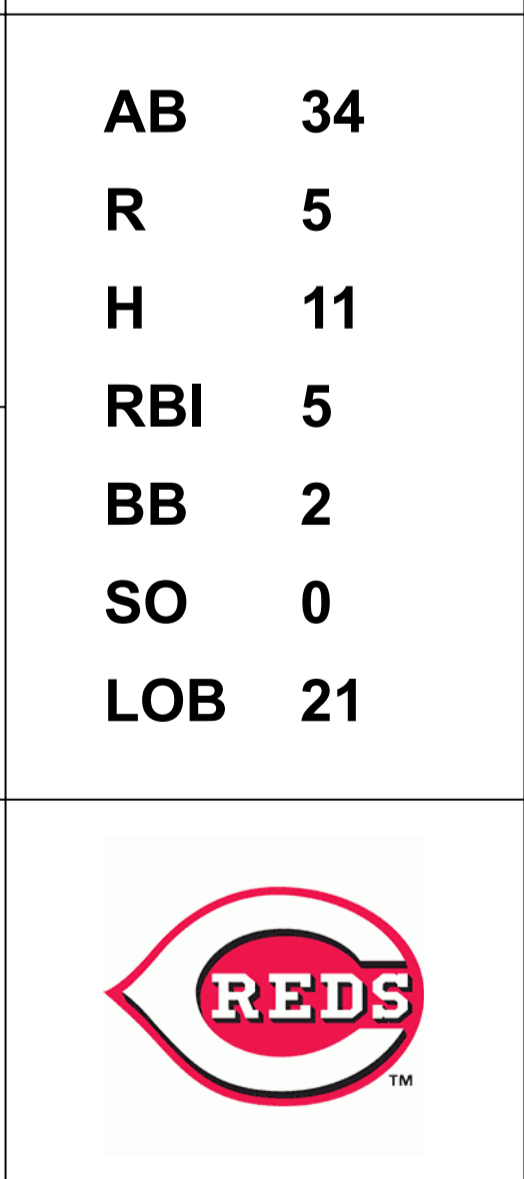

| Batter   | 1   | 2   | 3   | 4   | 5   | 6   | 7   | 8   | 9   | AB R H RBI BB SO LOB                                       | TOP   |  |
|--|---|---|---|---|---|---|---|---|---|--|---|--|
| Tommy Glaviano, R (1, 5)<br>OBP: 0.431, SLG: 0.474   | 4-0<br>2B 1-3<br>F9<br>BB                             | 0-0<br>FC4-6<br>1-2f                                |   | 0-0<br>1-3  |   |   | 0-0<br>5-3  |   | 0-0<br>2-H<br>2B                                    | 4 1 1 1 1 0 2  |   |  |
| Red Schoendienst, S (1, 4)<br>OBP: 0.311, SLG: 0.409 | 0-0<br>1-3<br>1-2                                     |   | 0-0<br>1-3  |   | 0-0<br>F6   |   | 0-0<br>F9   |   | 0-0<br>F8   | 5 0 0 0 0 0 2  |   |  |
| Stan Musial, L (1, 7)<br>OBP: 0.446, SLG: 0.615      | 0-0<br>2-3<br>2B                                      |   | 0-0<br>2B   |   | 0-0<br>F8   |   |   | 0-0<br>F7   | 0-0<br>G1   | 5 0 2 0 0 0 1  |   |  |
| Enos Slaughter, L (1, 9)<br>OBP: 0.371, SLG: 0.435   | 4-0<br>BB   |   | 0-0<br>F2   |   | 0-0<br>F6   |   |   | 0-0<br>HR<br>1B                                     |   | 3 1 1 0 1 0 1  |   |  |
| Bill Howerton, L (1, 8)<br>OBP: 0.391, SLG: 0.517    | 0-0<br>F9<br>3-H                                      |   | 4-0<br>IBB  |   | 4-0<br>4-3<br>BB                                    |   |   | 0-0<br>1-H<br>HR                                    |   | 2 1 1 3 2 0 2  |   |  |
| Joe Garagiola, L (1, 2)<br>OBP: 0.396, SLG: 0.500    | 0-0<br>1-3  |   | 0-0<br>G3   |   | 0-0<br>P3   |   |   | 0-0<br>F9   |   | 2 0 0 0 0 0 4  |   |  |
| Del Rice, R (3, 2)<br>OBP: 0.340, SLG: 0.399         |   |   |   |   |   |   |   |   |   | 2 0 0 0 0 0 1  |   |  |
| Marty Marion, R (1, 6)<br>OBP: 0.337, SLG: 0.345     |   | 0-0<br>P2   |   | 0-0<br>1B   |   | 0-0<br>4-3<br>1-2                                   |   | 0-0<br>F5   |   | 4 0 1 0 0 0 1  | AB 35<br>R 4<br>H 7<br>RBI 4<br>BB 4<br>SO 2<br>LOB 18                                |  |
| Rocky Nelson, L (1, 3)<br>OBP: 0.331, SLG: 0.347     |   | 0-0<br>F9   |   | 0-3<br>K  |   | 0-0<br>F7   |   |   | 0-0<br>1-3<br>2B<br>1B                              | 4 1 1 0 0 1 2  |   |  |
| Howie Pollet, L (1, 1)<br>OBP: 0.182, SLG: 0.151     |   | 0-0<br>E5   |   | 0-3<br>K  |   |   | 0-0<br>6-3  |   | 0-0<br>1-3  | 2 0 0 0 0 1 1  |  |  |
| Hal Rice, L (7, PH)<br>OBP: 0.250, SLG: 0.185        |   |   |   |   |   |   |   |   |   | 1 0 0 0 0 0 0  |   |  |
| Ted Wilks, R (7, 1)                                  |   |   |   |   |   |   |   |   |   | 0 0 0 0 0 0 0  |   |  |
| Erv Dusak, R (7, 1)                                  |   |   |   |   |   |   |   |   |   | 0 0 0 0 0 0 0  |   |  |
| Eddie Kazak, R (9, PH)<br>OBP: 0.305, SLG: 0.344     |   |   |   |   |   |   |   |   |   | 1 0 0 0 0 0 1  |   |  |
| <b>Inning Stats</b>                                  | R: 1 H: 1<br>E: 0 LOB: 2<br>K: 0 BB: 2<br>S: 4 P: 12  | R: 0 H: 0<br>E: 1 LOB: 1<br>K: 0 BB: 0<br>S: 4 P: 4 | R: 0 H: 1<br>E: 0 LOB: 2<br>K: 0 BB: 1<br>S: 4 P: 8 | R: 0 H: 1<br>E: 0 LOB: 1<br>K: 2 BB: 0<br>S: 8 P: 8 | R: 0 H: 0<br>E: 0 LOB: 0<br>K: 0 BB: 0<br>S: 3 P: 3 | R: 0 H: 0<br>E: 0 LOB: 1<br>K: 0 BB: 1<br>S: 3 P: 7 | R: 0 H: 0<br>E: 0 LOB: 0<br>K: 0 BB: 0<br>S: 3 P: 3 | R: 2 H: 2<br>E: 0 LOB: 0<br>K: 0 BB: 0<br>S: 5 P: 5 | R: 1 H: 2<br>E: 0 LOB: 1<br>K: 0 BB: 0<br>S: 5 P: 5 | 1B: 3 SF: 0<br>2B: 3 SAC: 0<br>3B: 0 DP: 0<br>HR: 1 HBP: 0 | WP: 0 PA: 39<br>PB: 0<br>SB: 0<br>CS: 0   |  |
| <b>PITCHER</b><br>Howie Fox, R (1, 1)<br>ERA: 4.85   | IP WLS BF H R ER SO BB IBB HBP BLK WP HR S P ERA WHIP | 9.0 W 39 7 4 4 2 3 1 0 0 0 1 39 55 4.00 1.111       |   |   |   |   |   |   |   |  |   |  |

St. Louis Cardinals @ Cincinnati Reds  
 Crosley Field, Cincinnati, OH  
 Mon Sep 04 1950, 3:38 AM EDT  
 Att: 12,468 - Unknown

livebaseballscorecards.com

| Batter  | 1                 | 2         | 3         | 4          | 5               | 6             | 7            | 8         | 9 | AB R H RBI BB SO LOB |
|---|-------------------|-----------|-----------|------------|-----------------|---------------|--------------|-----------|---|----------------------|
| <b>Bobby Adams, R</b><br>OBP: 0.355, SLG: 0.419<br>(1, 5) X     | 0-0 F9 ①          |           | 0-3 K ②   |            |                 | 0-0 PB 2B 1B  | 0-0 1B 2B    |           |   | 4 2 2 1 0 1 0        |
| <b>Bob Usher, R</b><br>OBP: 0.315, SLG: 0.366<br>(1, 8) B B B   | 4-0 E S 1B BB     |           | 0-0 F4 ③  |            |                 | 0-0 1-H HR 2B | 4-0 1B WP BB |           |   | 2 3 1 1 2 0 0        |
| <b>Johnny Wyrostek, L</b><br>OBP: 0.393, SLG: 0.464<br>(1, 9) X | 0-0 G6-4-3 1B 1-H |           | 0-3 K ①   |            |                 | 0-0 2-H HR    | 0-0 WP 1B    |           |   | 4 1 3 5 0 1 0        |
| <b>Ted Kluszewski, L</b><br>OBP: 0.352, SLG: 0.541<br>(1, 3) X  | 0-0 G6-4-3 1-2f   |           | 0-0 F8 ②  |            |                 | 0-0 1-3       | 0-0 F9 ③     |           |   | 4 0 0 0 0 0 2        |
| <b>Joe Adcock, R</b><br>OBP: 0.316, SLG: 0.386<br>(1, 7)        |                   | 0-0 1B    |           | 0-0 PO 1B  |                 | 0-0 6-3       |              | 0-0 6-3 ① |   | 4 0 2 0 0 0 0        |
| <b>Connie Ryan, R</b><br>OBP: 0.360, SLG: 0.372<br>(1, 4)       |                   | 0-0 F7 ①  |           | 0-0 PO 1-2 | 0-0 5-3 ①       |               | 0-0 F2 ①     | 0-0 F7 ②  |   | 4 0 0 0 0 0 1        |
| <b>Virgil Stallcup, R</b><br>OBP: 0.277, SLG: 0.350<br>(1, 6)   |                   | 0-0 F8 ②  |           |            | 0-0 K2-4-2 1B   |               | 0-0 2B 2B    | 0-0 F8 ③  |   | 4 1 2 0 0 0 1        |
| <b>Dixie Howell, R</b><br>OBP: 0.318, SLG: 0.290<br>(1, 2)      |                   | 0-0 6-3 ③ |           |            | 0-3 K2-4-2 1-2f |               | 0-3 K ②      |           |   | 3 0 0 0 0 2 3        |
| <b>Howie Fox, R</b><br>OBP: 0.217, SLG: 0.289<br>(1, 1)         |                   |           | 0-0 6-3 ① |            |                 | 0-3 K         | 4-0 2B 1B BB |           |   | 2 1 0 0 1 1 0        |

| Inning Stats | R: 1  | H: 1  | E: 1   | K: 0  | S: 3  | LOB: 0 | BB: 1  | P: 7  | R: 0   | H: 1 | E: 0 | K: 0 | S: 4 | LOB: 1 | BB: 0 | P: 4 | R: 0 | H: 0 | E: 0 | K: 1 | S: 5 | LOB: 0 | BB: 0 | P: 5 | R: 0 | H: 1 | E: 0 | K: 1 | S: 5 | LOB: 0 | BB: 0 | P: 5 | R: 0 | H: 3 | E: 0 | K: 1 | S: 8 | LOB: 0 | BB: 0 | P: 8 | R: 4 | H: 3 | E: 0 | K: 1 | S: 8 | LOB: 1 | BB: 2 | P: 16 | R: 0 | H: 0 | E: 0 | K: 0 | S: 3 | LOB: 0 | BB: 0 | P: 3 |
|--------------|-------|-------|--------|-------|-------|--------|--------|-------|--------|------|------|------|------|--------|-------|------|------|------|------|------|------|--------|-------|------|------|------|------|------|------|--------|-------|------|------|------|------|------|------|--------|-------|------|------|------|------|------|------|--------|-------|-------|------|------|------|------|------|--------|-------|------|
| 1B: 6        | SF: 0 | 2B: 4 | SAC: 0 | 3B: 0 | DP: 2 | HR: 1  | HBP: 0 | WP: 1 | PA: 35 |      |      |      |      |        |       |      |      |      |      |      |      |        |       |      |      |      |      |      |      |        |       |      |      |      |      |      |      |        |       |      |      |      |      |      |      |        |       |       |      |      |      |      |      |        |       |      |

| PITCHER                                       | IP  | WLS | BF | H | R | ER | SO | BB | IBB | HBP | BLK | WP | HR | S  | P  | ERA   | WHIP  |
|---|-----|-----|----|---|---|----|----|----|-----|-----|-----|----|----|----|----|-------|-------|
| <b>Howie Pollet, L</b><br>ERA: 3.47<br>(1, 1) | 6.0 | L   | 23 | 7 | 4 | 4  | 4  | 1  | 0   | 0   | 0   | 0  | 1  | 30 | 34 | 6.00  | 1.333 |
| <b>Ted Wilks, R</b><br>ERA: 9.26<br>(7, 1)    | 0.2 |     | 7  | 3 | 4 | 4  | 1  | 2  | 0   | 0   | 0   | 0  | 0  | 7  | 15 | 54.00 | 7.500 |
| <b>Erv Dusak, R</b><br>ERA: 3.18<br>(7, 1)    | 1.1 |     | 4  | 0 | 0 | 0  | 0  | 0  | 0   | 0   | 0   | 1  | 0  | 4  | 4  | 0.00  | 0.000 |

BOTTOM

**St. Louis Cardinals @ Cincinnati Reds**  
Crosley Field, Cincinnati, OH  
Mon Sep 04 1950, 3:38 AM EDT  
Att. 12,468 - Unknown

livebaseballscorecards.com

|     |    |
|-----|----|
| AB  | 31 |
| R   | 8  |
| H   | 10 |
| RBI | 7  |
| BB  | 3  |
| SO  | 5  |
| LOB | 7  |



| Batter   | 1                            | 2                               | 3                            | 4                               | 5                            | 6                               | 7                            | 8                               | 9                            | AB R H RBI BB SO LOB                            | TOP                          |                                 |                              |                                  |                              |                                 |                              |                                  |                                  |                                    |                                  |        |    |    |   |   |     |      |  |  |  |  |  |
|--|------------------------------|---------------------------------|------------------------------|---------------------------------|------------------------------|---------------------------------|------------------------------|---------------------------------|------------------------------|---|------------------------------|---------------------------------|------------------------------|----------------------------------|------------------------------|---------------------------------|------------------------------|----------------------------------|----------------------------------|------------------------------------|----------------------------------|--------|----|----|---|---|-----|------|--|--|--|--|--|
| Bob Dillinger, R (1, 5)<br>OBP: 0.356, SLG: 0.426        | 0-0<br>6-3                   |                                 |                              | 0-0<br>F9                       |                              | 0-0<br>G3-6                     |                              | 0-0<br>E1                       | 0-0<br>5-3                   | 5 0 0 0 0 0 5                                   |                              |                                 |                              |                                  |                              |                                 |                              |                                  |                                  |                                    |                                  |        |    |    |   |   |     |      |  |  |  |  |  |
| Danny O'Connell, R (1, 6)<br>OBP: 0.338, SLG: 0.448      | 0-0<br>F9                    |                                 |                              | 0-0<br>F6                       |                              |                                 | 0-0<br>SH1-4 BB<br>F8<br>1B  | 0-0<br>FC6-4                    |                              | 4 1 1 0 0 0 2                                   |                              |                                 |                              |                                  |                              |                                 |                              |                                  |                                  |                                    |                                  |        |    |    |   |   |     |      |  |  |  |  |  |
| Ralph Kiner, R (1, 7)<br>OBP: 0.418, SLG: 0.610          | 0-0<br>F4                    |                                 |                              | 0-0<br>F9                       |                              |                                 | 4-0<br>SH1-4<br>1-2 BB       | 0-3<br>K                        |                              | 3 0 0 0 1 1 2                                   |                              |                                 |                              |                                  |                              |                                 |                              |                                  |                                  |                                    |                                  |        |    |    |   |   |     |      |  |  |  |  |  |
| Gus Bell, L (1, 9)<br>OBP: 0.315, SLG: 0.420             |                              | 0-3<br>K                        |                              |                                 | 0-0<br>1-3                   |                                 | 0-0<br>SH1-4                 |                                 | 0-0<br>F4                    | 3 0 0 0 0 1 0                                   |                              |                                 |                              |                                  |                              |                                 |                              |                                  |                                  |                                    |                                  |        |    |    |   |   |     |      |  |  |  |  |  |
| Wally Westlake, R (1, 8)<br>OBP: 0.352, SLG: 0.465       |                              | 0-0<br>5-3                      |                              |                                 | 0-0<br>HR                    |                                 | 4-0<br>FC5-4<br>IBB          |                                 | 0-0<br>FC6-4<br>1B           | 3 1 2 1 1 0 0                                   |                              |                                 |                              |                                  |                              |                                 |                              |                                  |                                  |                                    |                                  |        |    |    |   |   |     |      |  |  |  |  |  |
| Jack Phillips, R (1, 3)<br>OBP: 0.333, SLG: 0.442        |                              | 0-0<br>F6                       |                              |                                 | 0-3<br>K                     |                                 | 0-0<br>F8                    |                                 | 0-0<br>FC6-4<br>1B BB<br>HBP | 2 0 0 0 0 1 0<br>1 0 0 1 0 0 2<br>1 1 0 0 0 0 1 |                              |                                 |                              |                                  |                              |                                 |                              |                                  |                                  |                                    |                                  |        |    |    |   |   |     |      |  |  |  |  |  |
| Tom Saffell, L (7, PH)<br>OBP: 0.245, SLG: 0.235         |                              |                                 |                              |                                 |                              |                                 |                              |                                 |                              |   |                              |                                 |                              |                                  |                              |                                 |                              |                                  |                                  |                                    |                                  |        |    |    |   |   |     |      |  |  |  |  |  |
| Ed Stevens, L (7, 3)                                     |                              |                                 |                              |                                 |                              |                                 |                              |                                 |                              |   |                              |                                 |                              |                                  |                              |                                 |                              |                                  |                                  |                                    |                                  |        |    |    |   |   |     |      |  |  |  |  |  |
| Johnny Berardino, R (1, 4)<br>OBP: 0.270, SLG: 0.231     |                              |                                 | 0-0<br>F8                    |                                 | 0-0<br>F7                    |                                 | 0-0<br>FC5-4                 |                                 | 4-0<br>HBP 1B<br>1-2 BB      | 3 0 0 0 1 0 2                                   |                              |                                 |                              |                                  |                              |                                 |                              |                                  |                                  |                                    |                                  |        |    |    |   |   |     |      |  |  |  |  |  |
| Clyde McCullough, R (1, 2)<br>OBP: 0.354, SLG: 0.449     |                              |                                 | 0-0<br>1-3                   |                                 |                              | 4-0<br>G3-6<br>BB               |                              | 0-3<br>K                        | 0-0<br>HBP<br>1B             | 3 0 1 0 1 1 0                                   |                              |                                 |                              |                                  |                              |                                 |                              |                                  |                                  |                                    |                                  |        |    |    |   |   |     |      |  |  |  |  |  |
| Vern Law, R (1, 1)<br>OBP: 0.162, SLG: 0.147             |                              |                                 | 0-0<br>6-3                   |                                 |                              | 0-3<br>K                        |                              | 0-0<br>FC6-4 E<br>1B            | 1-0<br>HBP                   | 3 0 1 1 0 1 1                                   |                              |                                 |                              |                                  |                              |                                 |                              |                                  |                                  |                                    |                                  |        |    |    |   |   |     |      |  |  |  |  |  |
| <b>Inning Stats</b>                                      | R: 0<br>E: 0<br>K: 0<br>S: 3 | H: 0<br>LOB: 0<br>BB: 0<br>P: 3 | R: 0<br>E: 0<br>K: 1<br>S: 5 | H: 0<br>LOB: 0<br>BB: 0<br>P: 5 | R: 0<br>E: 0<br>K: 0<br>S: 3 | H: 0<br>LOB: 0<br>BB: 0<br>P: 3 | R: 0<br>E: 0<br>K: 0<br>S: 3 | H: 0<br>LOB: 0<br>BB: 0<br>P: 3 | R: 1<br>E: 0<br>K: 1<br>S: 6 | H: 1<br>LOB: 0<br>BB: 0<br>P: 6                 | R: 0<br>E: 0<br>K: 1<br>S: 4 | H: 0<br>LOB: 0<br>BB: 1<br>P: 8 | R: 1<br>E: 0<br>K: 0<br>S: 4 | H: 1<br>LOB: 2<br>BB: 2<br>P: 12 | R: 0<br>E: 1<br>K: 2<br>S: 9 | H: 1<br>LOB: 2<br>BB: 0<br>P: 9 | R: 1<br>E: 0<br>K: 0<br>S: 5 | H: 2<br>LOB: 3<br>BB: 1<br>P: 10 | 1B: 4<br>2B: 0<br>3B: 0<br>HR: 1 | SF: 0<br>SAC: 1<br>DP: 1<br>HBP: 1 | WP: 0<br>PB: 0<br>SB: 0<br>CS: 0 | PA: 37 |    |    |   |   |     |      |  |  |  |  |  |
| <b>PITCHER</b><br>Ewell Blackwell, R (1, 1)<br>ERA: 3.43 | IP<br>9.0                    | WLS<br>L                        | BF<br>37                     | H<br>5                          | R<br>3                       | ER<br>3                         | SO<br>5                      | BB<br>3                         | IBB<br>1                     | HBP<br>1  | BLK<br>0                     | WP<br>0                         | HR<br>1                      | S<br>42                          | P<br>59                      | ERA<br>3.00                     | WHIP<br>0.889                |                                  |                                  |                                    |                                  |        |    |    |   |   |     |      |  |  |  |  |  |
|  |                              |                                 |                              |                                 |                              |                                 |                              |                                 |                              |   | <b>PITCHER</b>               | IP                              | WLS                          | BF                               | H                            | R                               | ER                           | SO                               | BB                               | IBB                                | HBP                              | BLK    | WP | HR | S | P | ERA | WHIP |  |  |  |  |  |

Pittsburgh Pirates @ Cincinnati Reds  
 Crosley Field, Cincinnati, OH  
 Wed Sep 06 1950, 3:33 AM EDT  
 Att. 7,079 - Unknown

livebaseballscorecards.com

|     |    |
|-----|----|
| AB  | 31 |
| R   | 3  |
| H   | 5  |
| RBI | 3  |
| BB  | 4  |
| SO  | 5  |
| LOB | 15 |



| Batter  | 1         | 2                 | 3                  | 4          | 5                          | 6          | 7          | 8          | 9             | AB R H RBI BB SO LOB |
|---|-----------|-------------------|--------------------|------------|----------------------------|------------|------------|------------|---------------|----------------------|
| Lloyd Merriman, L (1, 8)<br>OBP: 0.333, SLG: 0.354  | 0-0<br>F7 |                   | 4-0<br>FC4-6<br>BB |            | 0-0<br>L3-6                |            |            | 0-0<br>6-3 |               | 3 0 0 0 1 0 1        |
| Grady Hatton, L (1, 5)<br>OBP: 0.359, SLG: 0.386    | 0-0<br>F8 |                   | 0-0<br>FC4-6<br>1B |            |                            | 0-0<br>F9  |            | 0-0<br>F9  | 4 1 0 0 0 0 2 |                      |
| Johnny Wyrostek, L (1, 9)<br>OBP: 0.394, SLG: 0.463 | 4-0<br>BB |                   | 0-0<br>1B          |            |                            | 0-0<br>F9  |            | 0-3<br>K   | 3 0 1 1 1 1 0 |                      |
| Ted Kluszewski, L (1, 3)<br>OBP: 0.353, SLG: 0.543  | 0-0<br>G3 |                   | 0-0<br>1B          |            |                            | 0-0<br>F7  |            | 0-0<br>2B  | 4 0 2 1 0 0 1 |                      |
| Joe Adcock, R (1, 7)<br>OBP: 0.317, SLG: 0.384      |           | 0-0<br>F8-3<br>1B |                    | 0-0<br>5-3 |                            | 0-0<br>6-3 |            | 0-0<br>6-3 | 4 0 1 0 0 0 1 |                      |
| Johnny Pramesa, R (1, 2)<br>OBP: 0.369, SLG: 0.456  |           | 0-0<br>F8-3       |                    | 0-0<br>5-3 |                            | 0-0<br>F7  |            |            | 3 0 0 0 0 0 1 |                      |
| Connie Ryan, R (1, 4)<br>OBP: 0.358, SLG: 0.369     |           | 0-0<br>5-3        |                    | 0-3<br>K   |                            | 0-0<br>6-3 |            |            | 3 0 0 0 0 1 0 |                      |
| Virgil Stallcup, R (1, 6)<br>OBP: 0.280, SLG: 0.355 |           |                   | 0-0<br>FC4-6<br>1B |            | 0-0<br>L3-6<br>SH3-4<br>1B |            | 0-0<br>6-3 |            | 3 1 2 0 0 0 0 |                      |
| Ewell Blackwell, R (1, 1)<br>OBP: 0.139, SLG: 0.093 |           |                   | 0-0<br>1-3         |            | 0-0<br>SH3-4               |            | 0-0<br>4-3 |            | 2 0 0 0 0 0 1 |                      |

| Inning Stats                               | R: 0<br>E: 0<br>K: 0<br>S: 3 | H: 0<br>LOB: 1<br>BB: 1<br>P: 7 | R: 0<br>E: 0<br>K: 0<br>S: 3 | H: 1<br>LOB: 0<br>BB: 0<br>P: 3 | R: 2<br>E: 0<br>K: 0<br>S: 5 | H: 3<br>LOB: 2<br>BB: 1<br>P: 9 | R: 0<br>E: 0<br>K: 1<br>S: 5 | H: 0<br>LOB: 0<br>BB: 0<br>P: 5 | R: 0<br>E: 0<br>K: 0<br>S: 3 | H: 1<br>LOB: 0<br>BB: 0<br>P: 3 | R: 0<br>E: 0<br>K: 0<br>S: 3 | H: 0<br>LOB: 0<br>BB: 0<br>P: 3 | R: 0<br>E: 0<br>K: 0<br>S: 3 | H: 0<br>LOB: 0<br>BB: 0<br>P: 3 | R: 0<br>E: 0<br>K: 1<br>S: 6 | H: 1<br>LOB: 1<br>BB: 0<br>P: 6 | 1B: 4<br>2B: 4<br>3B: 0<br>HR: 0 | SF: 0<br>SAC: 1<br>DP: 2<br>HBP: 0 | WP: 0<br>PB: 0<br>SB: 0<br>CS: 0 | PA: 32 |
|--|------------------------------|---------------------------------|------------------------------|---------------------------------|------------------------------|---------------------------------|------------------------------|---------------------------------|------------------------------|---------------------------------|------------------------------|---------------------------------|------------------------------|---------------------------------|------------------------------|---------------------------------|----------------------------------|------------------------------------|----------------------------------|--------|
| PITCHER<br>Vern Law, R (1, 1)<br>ERA: 4.71 | IP 9.0                       | WLS W                           | BF 32                        | H 6                             | R 2                          | ER 2                            | SO 2                         | BB 2                            | IBB 0                        | HBP 0                           | BLK 0                        | WP 0                            | HR 0                         | S 34                            | P 42                         | ERA 2.00                        | WHIP 0.889                       |                                    |                                  |        |
| PITCHER                                    | IP                           | WLS                             | BF                           | H                               | R                            | ER                              | SO                           | BB                              | IBB                          | HBP                             | BLK                          | WP                              | HR                           | S                               | P                            | ERA                             | WHIP                             |                                    |                                  |        |

**BOTTOM**

**Pittsburgh Pirates @ Cincinnati Reds**  
Crosley Field, Cincinnati, OH

Wed Sep 06 1950, 3:33 AM EDT  
Att. 7,079 - Unknown

[livebaseballscorecards.com](http://livebaseballscorecards.com)

|            |           |
|------------|-----------|
| <b>AB</b>  | <b>29</b> |
| <b>R</b>   | <b>2</b>  |
| <b>H</b>   | <b>6</b>  |
| <b>RBI</b> | <b>2</b>  |
| <b>BB</b>  | <b>2</b>  |
| <b>SO</b>  | <b>2</b>  |
| <b>LOB</b> | <b>7</b>  |



Pittsburgh Pirates @ Cincinnati Reds  
 Crosley Field, Cincinnati, OH  
 Thu Sep 07 1950, 3:33 AM EDT  
 Att: 1,176 - Unknown

livebaseballscorecards.com

|     |    |
|-----|----|
| AB  | 37 |
| R   | 4  |
| H   | 8  |
| RBI | 4  |
| BB  | 2  |
| SO  | 5  |
| LOB | 15 |



|    |   |    |    |
|----|---|----|----|
| WP | 1 | PA | 41 |
| PB | 0 |    |    |
| SB | 0 |    |    |
| CS | 0 |    |    |

| Batter  | 1          | 2        | 3         | 4                         | 5          | 6                  | 7                  | 8          | 9                  | 10                 | AB | R | H | RBI | BB | SO | LOB |
|---|------------|----------|-----------|---------------------------|------------|--------------------|--------------------|------------|--------------------|--------------------|----|---|---|-----|----|----|-----|
| Bob Dillinger, R (1, 5)<br>OBP: 0.357, SLG: 0.426     | 0-0<br>1B  |          | 0-0<br>F9 |                           | 0-0<br>6-3 |                    | 0-0<br>FC5-4<br>1B |            | 0-0<br>6-3         |                    | 5  | 0 | 2 | 1   | 0  | 0  | 1   |
| Danny O'Connell, R (1, 6)<br>OBP: 0.335, SLG: 0.443   | 0-0<br>F8  |          |           | 0-0<br>WP<br>2B<br>1B     | 0-0<br>1-3 |                    | 0-0<br>FC5-4       |            |                    | 0-0<br>5-3         | 5  | 1 | 1 | 0   | 0  | 0  | 2   |
| Ralph Kiner, R (1, 7)<br>OBP: 0.417, SLG: 0.616       | 0-3<br>K   |          |           | 0-0<br>G3<br>1B<br>2B     |            | 0-0<br>4-3         |                    | 0-0<br>HR  |                    | 0-0<br>5-3         | 5  | 2 | 2 | 2   | 0  | 1  | 1   |
| Gus Bell, L (1, 9)<br>OBP: 0.314, SLG: 0.417          | 0-0<br>F6  |          |           | 0-0<br>G3                 |            | 0-0<br>F8          |                    | 0-0<br>F9  |                    | 0-0<br>FC5-4<br>1B | 5  | 0 | 1 | 0   | 0  | 0  | 2   |
| Wally Westlake, R (1, 8)<br>OBP: 0.352, SLG: 0.462    |            | 0-3<br>K |           | 1-0<br>FC5-6<br>1B<br>HBP |            | 4-0<br>FC4-6<br>BB |                    | 0-0<br>1-3 |                    | 0-0<br>FC5-4       | 3  | 0 | 0 | 0   | 1  | 1  | 1   |
| Jack Phillips, R (1, 3)<br>OBP: 0.350, SLG: 0.438     | 0-0<br>5-3 |          |           | 0-0<br>FC5-6<br>1B        |            | 0-0<br>FC4-6       |                    | 0-0<br>F7  |                    |                    | 4  | 0 | 1 | 1   | 0  | 0  | 1   |
| Johnny Berardino, R (1, 4)<br>OBP: 0.282, SLG: 0.235  | 0-0<br>F7  |          |           | 0-0<br>FC5-6              |            |                    | 0-0<br>BLK<br>1B   |            | 4-0<br>SH6-4<br>BB |                    | 3  | 1 | 1 | 0   | 1  | 0  | 2   |
| Clyde McCullough, R (1, 2)<br>OBP: 0.350, SLG: 0.443  |            |          | 0-0<br>F9 | 0-0<br>5-3                |            |                    | 0-3<br>K           |            | 0-0<br>SH6-4       |                    | 3  | 0 | 0 | 0   | 0  | 1  | 3   |
| Bill Werle, L (1, 1)<br>OBP: 0.281, SLG: 0.271        |            |          | 0-3<br>K  |                           | 0-0<br>3-1 |                    | 0-3<br>K           |            | 0-0<br>F8          |                    | 2  | 0 | 0 | 0   | 0  | 1  | 0   |
| Tom Saffell, L (7, PH)<br>OBP: 0.243, SLG: 0.234      |            |          |           |                           |            |                    |                    |            |                    |                    | 1  | 0 | 0 | 0   | 0  | 1  | 1   |
| Junior Walsh, R (7, 1)<br>OBP: 0.444, SLG: 0.333      |            |          |           |                           |            |                    |                    |            |                    |                    | 0  | 0 | 0 | 0   | 0  | 0  | 0   |
| Pete Castiglione, R (9, PH)<br>OBP: 0.318, SLG: 0.354 |            |          |           |                           |            |                    |                    |            |                    |                    | 1  | 0 | 0 | 0   | 0  | 0  | 1   |
| Frank Barrett, R (9, 1)                               |            |          |           |                           |            |                    |                    |            |                    |                    | 0  | 0 | 0 | 0   | 0  | 0  | 0   |

| Inning Stats | R: 0   | H: 1 | R: 0   | H: 0 | R: 0   | H: 0 | R: 0   | H: 0 | R: 0   | H: 0 | R: 1   | H: 2 | R: 1   | H: 1 | R: 0   | H: 0 | R: 0   | H: 1 | R: 0   | H: 1 | 1B: 6  | SF: 0 |        |
|--------------|--------|------|--------|------|--------|------|--------|------|--------|------|--------|------|--------|------|--------|------|--------|------|--------|------|--------|-------|--------|
| E: 0         | LOB: 1 | E: 0 | LOB: 0 | E: 0 | LOB: 0 | E: 0 | LOB: 0 | E: 0 | LOB: 0 | E: 0 | LOB: 1 | E: 0 | LOB: 0 | E: 0 | LOB: 0 | E: 0 | LOB: 1 | E: 0 | LOB: 1 | E: 0 | LOB: 1 | 2B: 1 | SAC: 1 |
| K: 1         | BB: 0  | K: 1 | BB: 0  | K: 1 | BB: 0  | K: 0 | BB: 0  | K: 0 | BB: 0  | K: 0 | BB: 1  | K: 2 | BB: 0  | K: 0 | BB: 0  | K: 0 | BB: 1  | K: 0 | BB: 0  | K: 0 | BB: 0  | 3B: 0 | DP: 0  |
| S: 6         | P: 6   | S: 5 | P: 5   | S: 5 | P: 5   | S: 6 | P: 7   | S: 3 | P: 3   | S: 3 | P: 7   | S: 9 | P: 9   | S: 4 | P: 4   | S: 3 | P: 7   | S: 4 | P: 4   | S: 4 | P: 4   | HR: 1 | HBP: 1 |

|  |      |     |    |   |   |    |    |    |     |     |     |    |    |    |    |      |       |
|--|------|-----|----|---|---|----|----|----|-----|-----|-----|----|----|----|----|------|-------|
| PITCHER<br>Eddie Erault, R (1, 1)<br>ERA: 6.02 | IP   | WLS | BF | H | R | ER | SO | BB | IBB | HBP | BLK | WP | HR | S  | P  | ERA  | WHIP  |
|  | 10.0 | W   | 41 | 8 | 4 | 4  | 5  | 2  | 0   | 1   | 1   | 1  | 1  | 48 | 57 | 3.60 | 1.000 |

|         |    |     |    |   |   |    |    |    |     |     |     |    |    |   |   |     |      |
|---------|----|-----|----|---|---|----|----|----|-----|-----|-----|----|----|---|---|-----|------|
| PITCHER | IP | WLS | BF | H | R | ER | SO | BB | IBB | HBP | BLK | WP | HR | S | P | ERA | WHIP |
|---------|----|-----|----|---|---|----|----|----|-----|-----|-----|----|----|---|---|-----|------|

**BOTTOM**

**Pittsburgh Pirates @ Cincinnati Reds**  
 Crosley Field, Cincinnati, OH  
 Thu Sep 07 1950, 3:33 AM EDT  
 Att. 1,176 - Unknown

[livebaseballscorecards.com](http://livebaseballscorecards.com)

|            |           |
|------------|-----------|
| <b>AB</b>  | <b>37</b> |
| <b>R</b>   | <b>6</b>  |
| <b>H</b>   | <b>8</b>  |
| <b>RBI</b> | <b>6</b>  |
| <b>BB</b>  | <b>3</b>  |
| <b>SO</b>  | <b>0</b>  |
| <b>LOB</b> | <b>14</b> |



|       |        |
|-------|--------|
| WP: 0 | PA: 40 |
| PB: 0 |        |
| SB: 1 |        |
| CS: 0 |        |

AB R H RBI BB SO LOB

3 1 1 0 2 0 1

5 2 0 0 0 0 3

5 1 2 1 0 0 1

5 1 2 3 0 0 1

3 0 0 1 1 0 3

4 0 0 0 0 0 2

4 1 2 1 0 0 0

4 0 1 0 0 0 1

0 0 0 0 0 0 0

0 0 0 0 0 0 0

4 0 0 0 0 0 2

1B: 4 SF: 0  
 2B: 3 SAC: 0  
 3B: 0 DP: 2  
 HR: 2 HBP: 0

| Batter   | 1                          | 2          | 3                     | 4          | 5 | 6          | 7         | 8                  | 9                            | 10               |
|--|----------------------------|------------|-----------------------|------------|---|------------|-----------|--------------------|------------------------------|------------------|
| <b>Bobby Adams, R</b> (1, 5)<br>OBP: 0.359, SLG: 0.419     | 4-0<br>S<br>2B<br>BB       |            | 4-0<br>FC6-4<br>BB    | 0-0<br>F6  |   |            | 0-0<br>1B |                    |                              | 0-0<br>F9        |
| <b>Bob Usher, R</b> (1, 8)<br>OBP: 0.310, SLG: 0.360       | 0-0<br>F6<br>1-2           |            | 0-0<br>FC6-4<br>1B    |            |   | 0-0<br>F5  | 0-0<br>F8 |                    |                              | 0-0<br>E4<br>HR  |
| <b>Johnny Wyrostek, L</b> (1, 9)<br>OBP: 0.394, SLG: 0.465 | 0-0<br>E<br>2-H<br>2B      |            | 0-0<br>1B<br>F8<br>1B |            |   | 0-0<br>6-3 |           | 0-0<br>F5          |                              | 0-0<br>F7        |
| <b>Ted Kluszewski, L</b> (1, 3)<br>OBP: 0.354, SLG: 0.548  | 0-0<br>E6<br>G4-6-3<br>2-3 |            | 0-0<br>FC6-4<br>1B    |            |   | 0-0<br>F8  |           | 0-0<br>F4          |                              | 0-0<br>HR<br>1-H |
| <b>Joe Adcock, R</b> (1, 7)<br>OBP: 0.316, SLG: 0.380      | 0-0<br>G4-6-3<br>1-2f      |            | 0-0<br>F8             |            |   | 0-0<br>P3  |           | 4-0<br>BB          |                              |                  |
| <b>Connie Ryan, R</b> (1, 4)<br>OBP: 0.354, SLG: 0.365     |                            | 0-0<br>5-3 | 0-0<br>FC6-4<br>1-2f  |            |   | 0-0<br>F8  |           | 0-0<br>1-3         |                              |                  |
| <b>Virgil Stallcup, R</b> (1, 6)<br>OBP: 0.282, SLG: 0.364 |                            | 0-0<br>HR  |                       | 0-0<br>F5  |   | 0-0<br>F6  |           | 0-0<br>FC3-6<br>1B |                              |                  |
| <b>Dixie Howell, R</b> (1, 2)<br>OBP: 0.317, SLG: 0.294    |                            | 0-0<br>P2  |                       | 0-0<br>2B  |   |            | 0-0<br>F8 |                    | 0-0<br>FC3-6<br>B1-4<br>1-2f |                  |
| <b>Herm Wehmeier, R</b> (9, PR)<br>OBP: 0.183, SLG: 0.210  |                            |            |                       |            |   |            |           |                    |                              |                  |
| <b>Johnny Pramesa, R</b> (10, 2)<br>OBP: 0.369, SLG: 0.456 |                            |            |                       |            |   |            |           |                    |                              |                  |
| <b>Eddie Erault, R</b> (1, 1)<br>OBP: 0.250, SLG: 0.273    |                            | 0-0<br>6-3 |                       | 0-0<br>6-3 |   |            | 0-0<br>F8 |                    | 0-0<br>B1-4<br>1-1f          |                  |

| Inning Stats | R: 1 | H: 1 | E: 1 | K: 0 | S: 4 | P: 8 | R: 1 | H: 1 | E: 0 | K: 0 | S: 4 | P: 4 | R: 2 | H: 2 | E: 0 | K: 0 | S: 5 | R: 0 | H: 1 | E: 0 | K: 0 | S: 4 | P: 4 | R: 0 | H: 0 | E: 0 | K: 0 | S: 3 | P: 3 | R: 0 | H: 0 | E: 0 | K: 0 | S: 3 | P: 3 | R: 0 | H: 1 | E: 0 | K: 0 | S: 4 | P: 4 | R: 0 | H: 0 | E: 0 | K: 0 | S: 3 | P: 7 | R: 0 | H: 1 | E: 0 | K: 0 | S: 3 | P: 3 | R: 2 | H: 1 | E: 1 | K: 0 | S: 4 | P: 4 | 1B: 4 | SF: 0 | 2B: 3 | SAC: 0 | 3B: 0 | DP: 2 | HR: 2 | HBP: 0 | WP: 0 | PA: 40 |
|--------------|------|------|------|------|------|------|------|------|------|------|------|------|------|------|------|------|------|------|------|------|------|------|------|------|------|------|------|------|------|------|------|------|------|------|------|------|------|------|------|------|------|------|------|------|------|------|------|------|------|------|------|------|------|------|------|------|------|------|------|-------|-------|-------|--------|-------|-------|-------|--------|-------|--------|
|--------------|------|------|------|------|------|------|------|------|------|------|------|------|------|------|------|------|------|------|------|------|------|------|------|------|------|------|------|------|------|------|------|------|------|------|------|------|------|------|------|------|------|------|------|------|------|------|------|------|------|------|------|------|------|------|------|------|------|------|------|-------|-------|-------|--------|-------|-------|-------|--------|-------|--------|

| PITCHER                                    | IP  | WLS | BF | H | R | ER | SO | BB | IBB | HBP | BLK | WP | HR | S  | P  | ERA  | WHIP  |
|--|-----|-----|----|---|---|----|----|----|-----|-----|-----|----|----|----|----|------|-------|
| <b>Bill Werle, L</b> (1, 1)<br>ERA: 4.31   | 6.0 |     | 25 | 5 | 4 | 4  | 0  | 2  | 0   | 0   | 0   | 0  | 1  | 23 | 31 | 6.00 | 1.167 |
| <b>Junior Walsh, R</b> (7, 1)<br>ERA: 6.29 | 2.0 |     | 8  | 1 | 0 | 0  | 0  | 1  | 0   | 0   | 0   | 0  | 0  | 7  | 11 | 0.00 | 1.000 |
| <b>Frank Barrett, R</b> (9, 1)<br>ERA:     | 1.2 | L   | 7  | 2 | 2 | 0  | 0  | 0  | 0   | 0   | 0   | 0  | 1  | 7  | 7  | 0.00 | 1.200 |

| Batter   | 1   | 2   | 3   | 4   | 5   | 6   | 7   | 8   | 9   | AB R H RBI BB SO LOB   | TOP  |
|--|---|---|---|---|---|---|---|---|---|--|--|
| Hal Jeffcoat, R (1, 9)<br>OBP: 0.269, SLG: 0.352   | 0-0<br>4-3  | 0-0<br>F7   |   |   | 0-0<br>HR   |   | 0-0<br>1-3<br>2B  |   | 0-0<br>5-3  | 5 1 2 1 0 0 1  |  |
| Phil Cavarretta, L (1, 3)<br>OBP: 0.374, SLG: 0.430  | 0-3<br>K  |   | 0-0<br>F7   |   | 0-0<br>F8   |   | 0-3<br>K  |   | 0-0<br>G3   | 5 0 0 0 0 2 1  |  |
| Bill Serena, R (1, 5)<br>OBP: 0.339, SLG: 0.426  | 0-0<br>1B<br>1B   |   | 0-0<br>P6   |   |   | 0-0<br>1B<br>2B   | 0-0<br>1-3  |   |   | 4 2 2 0 0 0 1  |  |
| Hank Sauer, R (1, 7)<br>OBP: 0.357, SLG: 0.521   | 0-0<br>1B<br>1-2<br>1B  |   | 0-0<br>4-3  |   |   | 0-0<br>1B<br>1B   | 0-0<br>5-3  |   |   | 4 1 2 0 0 0 1  |  |
| Andy Pafko, R (1, 8)<br>OBP: 0.413, SLG: 0.621   | 0-0<br>1B<br>1-2<br>2-H   |   |   | 0-0<br>6-3  |   | 0-0<br>F3   |   | 0-0<br>P6   |   | 4 0 1 1 0 0 2  |  |
| Roy Smalley, R (1, 6)<br>OBP: 0.291, SLG: 0.406  | 0-0<br>P3   |   |   | 0-0<br>6-3  |   | 0-0<br>1B<br>1B   |   | 0-0<br>G3   |   | 4 0 1 1 0 0 2  |  |
| Wayne Terwilliger, R (1, 4)<br>OBP: 0.303, SLG: 0.355  |   | 0-0<br>G4-6-3<br>1B   |   | 0-0<br>F4   |   | 0-0<br>1B<br>1-2<br>2-H   |   | 0-0<br>1B   |   | 4 0 3 1 0 0 0  |  |
| Mickey Owen, R (1, 2)<br>OBP: 0.274, SLG: 0.304  |   | 0-0<br>G4-6-3   |   |   | 0-0<br>5-3  | 0-0<br>P3   |   | 0-0<br>F3   |   | 4 0 0 0 0 0 4  |  |
| Monk Dubiel, R (1, 1)<br>OBP: 0.233, SLG: 0.244<br>Dutch Leonard, R (6, 1)<br>OBP: 0.067, SLG: 0.067<br>Bob Borkowski, R (9, PH)<br>OBP: 0.321, SLG: 0.385 |   | 0-0<br>1B   |   |   | 0-0<br>F7   | 0-0<br>1-3  |   | 0-3<br>K  |   | 3 0 1 0 0 0 2<br>0 0 0 0 0 0 0<br>1 0 0 0 0 1 0                        |  |
| <b>Inning Stats</b>  | R: 1<br>E: 0<br>K: 1<br>S: 8<br>H: 3<br>LOB: 2<br>BB: 0<br>P: 8   | R: 0<br>E: 0<br>K: 0<br>S: 4<br>H: 2<br>LOB: 1<br>BB: 0<br>P: 4 | R: 0<br>E: 0<br>K: 0<br>S: 3<br>H: 0<br>LOB: 0<br>BB: 0<br>P: 3 | R: 0<br>E: 0<br>K: 0<br>S: 3<br>H: 0<br>LOB: 0<br>BB: 0<br>P: 3 | R: 1<br>E: 0<br>K: 0<br>S: 4<br>H: 1<br>LOB: 0<br>BB: 0<br>P: 4 | R: 2<br>E: 0<br>K: 0<br>S: 7<br>H: 4<br>LOB: 2<br>BB: 0<br>P: 7 | R: 0<br>E: 0<br>K: 1<br>S: 6<br>H: 1<br>LOB: 1<br>BB: 0<br>P: 6 | R: 0<br>E: 0<br>K: 0<br>S: 4<br>H: 1<br>LOB: 1<br>BB: 0<br>P: 4 | R: 0<br>E: 0<br>K: 1<br>S: 5<br>H: 0<br>LOB: 0<br>BB: 0<br>P: 5 | 1B: 9<br>2B: 2<br>3B: 0<br>HR: 1<br>SF: 0<br>SAC: 0<br>DP: 1<br>HBP: 0 | WP: 0<br>PB: 0<br>SB: 0<br>CS: 0<br>PA: 38 |
| <b>PITCHER</b><br>Ken Raffensberger, L (1, 1)<br>ERA: 4.1  | IP: 9.0<br>WLS: W<br>BF: 38<br>H: 12<br>R: 4<br>ER: 4<br>SO: 3<br>BB: 0<br>IBB: 0<br>HBP: 0<br>BLK: 0<br>WP: 0<br>HR: 1<br>S: 44<br>P: 44<br>ERA: 4.00<br>WHIP: 1.333 |   |   |   |   |   |   |   |   |  |  |

Chicago Cubs @ Cincinnati Reds  
Crosley Field, Cincinnati, OH  
Sat Sep 09 1950, 3:33 AM EDT  
Unknown

livebaseballscorecards.com

|     |    |
|-----|----|
| AB  | 38 |
| R   | 4  |
| H   | 12 |
| RBI | 4  |
| BB  | 0  |
| SO  | 3  |
| LOB | 14 |





| Batter   | 1                          | 2                             | 3          | 4          | 5                | 6                                | 7                | 8 | 9 |
|--|----------------------------|-------------------------------|------------|------------|------------------|----------------------------------|------------------|---|---|
| Lloyd Merriman, L<br>OBP: 0.336, SLG: 0.357<br>(1, 8)    | 0-0<br>S<br>1B             | 0-0<br>F8                     |            |            | 0-0<br>1B<br>1B  | 0-3<br>K                         |                  |   |   |
| Grady Hatton, L<br>OBP: 0.363, SLG: 0.390<br>(1, 5)      | 0-0<br>G4-6-3<br>1-H<br>1B |                               | 0-0<br>3-1 |            | 0-0<br>1-2<br>1B |                                  | 0-0<br>6-3<br>1B |   |   |
| Johnny Wyrostek, L<br>OBP: 0.391, SLG: 0.460<br>(1, 9)   | 0-0<br>G4-6-3<br>1-2f      |                               | 0-0<br>1-3 |            | 0-0<br>F8        |                                  | 0-0<br>6-3       |   |   |
| Ted Kluszewski, L<br>OBP: 0.353, SLG: 0.552<br>(1, 3)    | 0-0<br>4-3                 |                               | 0-0<br>4-3 |            |                  | 0-0<br>HR                        | 0-0<br>L8        |   |   |
| Joe Adcock, R<br>OBP: 0.316, SLG: 0.382<br>(1, 7)        |                            | 0-0<br>1B<br>1B               |            | 0-0<br>F8  |                  | 0-0<br>FC3-4<br>1B               | 0-0<br>P3        |   |   |
| Connie Ryan, R<br>OBP: 0.354, SLG: 0.364<br>(1, 4)       |                            | 0-0<br>1B<br>1-2<br>1B        |            | 0-0<br>6-3 |                  | 0-0<br>FC3-4<br>2B<br>1-2f<br>CS | 0-3<br>K         |   |   |
| Virgil Stallcup, R<br>OBP: 0.284, SLG: 0.368<br>(1, 6)   |                            | 0-3<br>K                      |            | 0-0<br>1-3 |                  | 0-0<br>1-3<br>1B<br>2B           | 0-0<br>5-3<br>1B |   |   |
| Dixie Howell, R<br>OBP: 0.321, SLG: 0.295<br>(1, 2)      |                            | 0-0<br>1-3<br>2-H<br>HR<br>1B |            | 0-0<br>4-3 |                  | 4-0<br>1B<br>1B<br>BB            | 0-0<br>5-3       |   |   |
| Ken Raffensberger, R<br>OBP: 0.188, SLG: 0.211<br>(1, 1) |                            | 0-0<br>1-H<br>HR              |            | 0-0<br>F2  |                  | 0-0<br>1-H<br>2-H<br>3-H<br>1B   | 0-3<br>K         |   |   |

| Inning Stats | R: 1 | H: 2 | E: 0 | K: 0 | S: 4 | LOB: 0 | BB: 0 | P: 4  |
|--------------|------|------|------|------|------|--------|-------|-------|
|              | R: 3 | H: 4 | E: 0 | K: 1 | S: 8 | LOB: 0 | BB: 0 | P: 8  |
|              | R: 0 | H: 0 | E: 0 | K: 0 | S: 3 | LOB: 0 | BB: 0 | P: 3  |
|              | R: 0 | H: 0 | E: 0 | K: 0 | S: 3 | LOB: 0 | BB: 0 | P: 3  |
|              | R: 0 | H: 2 | E: 0 | K: 0 | S: 5 | LOB: 2 | BB: 0 | P: 5  |
|              | R: 3 | H: 4 | E: 0 | K: 1 | S: 8 | LOB: 1 | BB: 1 | P: 12 |
|              | R: 0 | H: 1 | E: 0 | K: 0 | S: 4 | LOB: 1 | BB: 0 | P: 4  |
|              | R: 0 | H: 1 | E: 0 | K: 2 | S: 8 | LOB: 1 | BB: 0 | P: 8  |

| PITCHER                                 | IP  | WLS | BF | H  | R | ER | SO | BB | IBB | HBP | BLK | WP | HR | S  | P  | ERA   | WHIP  |
|---|-----|-----|----|----|---|----|----|----|-----|-----|-----|----|----|----|----|-------|-------|
| Monk Dubiel, R<br>ERA: 4.07<br>(1, 1)   | 5.2 | L   | 27 | 12 | 7 | 7  | 1  | 1  | 0   | 0   | 0   | 0  | 2  | 28 | 32 | 11.12 | 2.294 |
| Dutch Leonard, R<br>ERA: 4.16<br>(6, 1) | 2.1 |     | 9  | 2  | 0 | 0  | 3  | 0  | 0   | 0   | 0   | 0  | 0  | 15 | 15 | 0.00  | 0.857 |

| AB | R | H | RBI | BB | SO | LOB |
|----|---|---|-----|----|----|-----|
| 4  | 1 | 2 | 0   | 0  | 1  | 1   |
| 4  | 0 | 3 | 1   | 0  | 0  | 0   |
| 4  | 0 | 0 | 0   | 0  | 0  | 4   |
| 4  | 1 | 1 | 1   | 0  | 0  | 1   |
| 4  | 1 | 2 | 0   | 0  | 0  | 1   |
| 4  | 0 | 1 | 0   | 0  | 1  | 1   |
| 4  | 1 | 2 | 0   | 0  | 1  | 2   |
| 3  | 2 | 1 | 1   | 1  | 0  | 1   |
| 4  | 1 | 2 | 4   | 0  | 1  | 1   |

**BOTTOM**

**Chicago Cubs @ Cincinnati Reds**  
Crosley Field, Cincinnati, OH

Sat Sep 09 1950, 3:33 AM EDT  
Unknown

livebaseballscorecards.com

|            |           |
|------------|-----------|
| <b>AB</b>  | <b>35</b> |
| <b>R</b>   | <b>7</b>  |
| <b>H</b>   | <b>14</b> |
| <b>RBI</b> | <b>7</b>  |
| <b>BB</b>  | <b>1</b>  |
| <b>SO</b>  | <b>4</b>  |
| <b>LOB</b> | <b>12</b> |



| 1B | 2B | 3B | HR | SF | SAC | DP | HBP |
|----|----|----|----|----|-----|----|-----|
| 11 | 1  | 0  | 2  | 0  | 0   | 1  | 0   |

| WP | PA | ERA | WHIP |
|----|----|-----|------|
| 0  | 36 |     |      |

| Batter   | 1   | 2                                | 3                            | 4                               | 5                            | 6                               | 7                            | 8                               | 9                            | AB R H RBI BB SO LOB            | TOP                          |                                 |                              |                                 |                              |                                  |                                  |                                    |                                  |        |
|--|---|----------------------------------|------------------------------|---------------------------------|------------------------------|---------------------------------|------------------------------|---------------------------------|------------------------------|---------------------------------|------------------------------|---------------------------------|------------------------------|---------------------------------|------------------------------|----------------------------------|----------------------------------|------------------------------------|----------------------------------|--------|
| <b>Carmen Mauro, L</b> (1, 9)<br>OBP: 0.295, SLG: 0.314      | 4-0<br>BB   |                                  | 0-0<br>1-3                   |                                 |                              | 0-0<br>G3                       |                              | 0-0<br>1B<br>1B                 | 0-3<br>K                     | 4 0 1 0 1 1 0                   |                              |                                 |                              |                                 |                              |                                  |                                  |                                    |                                  |        |
| <b>Preston Ward, L</b> (1, 3)<br>OBP: 0.325, SLG: 0.377      | 0-0<br>F5   |                                  | 0-0<br>F5                    |                                 |                              | 0-0<br>G3                       |                              | 0-0<br>1B<br>1B                 |                              | 4 0 1 0 0 0 1                   |                              |                                 |                              |                                 |                              |                                  |                                  |                                    |                                  |        |
| <b>Bill Serena, R</b> (1, 5)<br>OBP: 0.340, SLG: 0.424       | 0-3<br>K  |                                  |                              |                                 |                              | 0-0<br>F3                       |                              | 4-0<br>1B<br>BB                 |                              | 2 0 0 0 2 1 1                   |                              |                                 |                              |                                 |                              |                                  |                                  |                                    |                                  |        |
| <b>Hank Sauer, R</b> (1, 7)<br>OBP: 0.356, SLG: 0.526        | 0-3<br>K  |                                  |                              |                                 |                              | 0-0<br>FC6-4<br>BB              |                              | 0-0<br>G4-3<br>BB               |                              | 4 1 1 1 0 1 5                   |                              |                                 |                              |                                 |                              |                                  |                                  |                                    |                                  |        |
| <b>Andy Pafo, R</b> (1, 8)<br>OBP: 0.414, SLG: 0.626         |   |                                  |                              |                                 |                              | 0-0<br>G6-4-3                   |                              | 0-0<br>HR                       | 0-0<br>F3                    | 3 1 1 1 1 0 1                   |                              |                                 |                              |                                 |                              |                                  |                                  |                                    |                                  |        |
| <b>Carl Sawatski, L</b> (1, 2)<br>OBP: 0.284, SLG: 0.203     |   |                                  |                              |                                 |                              | 0-0<br>FC6-4<br>1B              |                              | 0-0<br>F8                       | 4-0<br>1B<br>HR<br>BB        | 3 1 2 0 1 0 0                   |                              |                                 |                              |                                 |                              |                                  |                                  |                                    |                                  |        |
| <b>Roy Smalley, R</b> (1, 6)<br>OBP: 0.291, SLG: 0.404       |   |                                  |                              |                                 |                              | 0-3<br>K                        |                              | 0-0<br>F8                       | 0-0<br>1B<br>HR              | 4 1 1 0 0 2 3                   |                              |                                 |                              |                                 |                              |                                  |                                  |                                    |                                  |        |
| <b>Wayne Terwilliger, R</b> (1, 4)<br>OBP: 0.301, SLG: 0.352 |   |                                  |                              |                                 |                              | 0-0<br>L4-3                     |                              | 0-3<br>K                        | 0-0<br>F7                    | 4 0 0 0 0 1 5                   |                              |                                 |                              |                                 |                              |                                  |                                  |                                    |                                  |        |
| <b>Johnny Klippstein, R</b> (1, 1)<br>OBP: 0.313, SLG: 0.469 |   |                                  | 0-3<br>K                     |                                 |                              | 0-0<br>F7                       |                              | 0-0<br>F6                       | 0-0<br>HR                    | 2 0 0 0 0 1 1                   |                              |                                 |                              |                                 |                              |                                  |                                  |                                    |                                  |        |
| <b>Doyle Lade, R</b> (5, 1)<br>OBP: 0.324, SLG: 0.343        |   |                                  |                              |                                 |                              |                                 |                              |                                 |                              | 0 0 0 0 0 0 0                   |                              |                                 |                              |                                 |                              |                                  |                                  |                                    |                                  |        |
| <b>Rube Walker, L</b> (8, PH)<br>OBP: 0.290, SLG: 0.363      |   |                                  |                              |                                 |                              |                                 |                              |                                 |                              | 1 0 0 0 0 0 0                   |                              |                                 |                              |                                 |                              |                                  |                                  |                                    |                                  |        |
| <b>Andy Varga, R</b> (8, 1)<br>OBP: 0.376, SLG: 0.444        |   |                                  |                              |                                 |                              |                                 |                              |                                 |                              | 0 0 0 0 0 0 0                   |                              |                                 |                              |                                 |                              |                                  |                                  |                                    |                                  |        |
| <b>Phil Cavarretta, L</b> (9, PH)<br>OBP: 0.376, SLG: 0.444  |   |                                  |                              |                                 |                              |                                 |                              |                                 |                              | 1 1 1 3 0 0 0                   |                              |                                 |                              |                                 |                              |                                  |                                  |                                    |                                  |        |
| <b>Inning Stats</b>  | R: 0<br>E: 0<br>K: 2<br>S: 7                          | H: 0<br>LOB: 1<br>BB: 1<br>P: 11 | R: 0<br>E: 0<br>K: 1<br>S: 5 | H: 1<br>LOB: 1<br>BB: 1<br>P: 9 | R: 0<br>E: 0<br>K: 1<br>S: 5 | H: 0<br>LOB: 0<br>BB: 0<br>P: 5 | R: 0<br>E: 0<br>K: 0<br>S: 2 | H: 0<br>LOB: 0<br>BB: 1<br>P: 6 | R: 0<br>E: 0<br>K: 1<br>S: 6 | H: 1<br>LOB: 1<br>BB: 0<br>P: 6 | R: 2<br>E: 0<br>K: 1<br>S: 7 | H: 2<br>LOB: 0<br>BB: 0<br>P: 7 | R: 0<br>E: 0<br>K: 0<br>S: 4 | H: 2<br>LOB: 2<br>BB: 1<br>P: 8 | R: 3<br>E: 0<br>K: 1<br>S: 7 | H: 2<br>LOB: 0<br>BB: 1<br>P: 11 | 1B: 5<br>2B: 1<br>3B: 0<br>HR: 3 | SF: 0<br>SAC: 0<br>DP: 3<br>HBP: 0 | WP: 0<br>PB: 0<br>SB: 0<br>CS: 0 | PA: 37 |
| <b>PITCHER</b>   | IP WLS BF H R ER SO BB IBB HBP BLK WP HR S P ERA WHIP |                                  |                              |                                 |                              |                                 |                              |                                 |                              |                                 |                              |                                 |                              |                                 |                              |                                  |                                  |                                    |                                  |        |
| <b>Willie Ramsdell, R</b> (1, 1)<br>ERA: 3.82                | 7.1 W 30 6 2 2 6 4 0 0 0 0 2 38 54 2.46 1.364         |                                  |                              |                                 |                              |                                 |                              |                                 |                              |                                 |                              |                                 |                              |                                 |                              |                                  |                                  |                                    |                                  |        |
| <b>Frank Smith, R</b> (8, 1)<br>ERA: 3.72                    | 1.1 6 2 3 3 0 1 0 0 0 0 1 5 9 20.25 2.250             |                                  |                              |                                 |                              |                                 |                              |                                 |                              |                                 |                              |                                 |                              |                                 |                              |                                  |                                  |                                    |                                  |        |
| <b>Ewell Blackwell, R</b> (9, 1)<br>ERA: 3.42                | 0.1 S 1 0 0 0 1 0 0 0 0 0 0 0 3 3 0.00 0.000          |                                  |                              |                                 |                              |                                 |                              |                                 |                              |                                 |                              |                                 |                              |                                 |                              |                                  |                                  |                                    |                                  |        |

**Chicago Cubs @ Cincinnati Reds**  
Crosley Field, Cincinnati, OH  
Sat Sep 09 1950, 3:38 AM EDT  
Att. 2,933 - Overcast

[livebaseballscorecards.com](http://livebaseballscorecards.com)

|     |    |
|-----|----|
| AB  | 32 |
| R   | 5  |
| H   | 8  |
| RBI | 5  |
| BB  | 5  |
| SO  | 7  |
| LOB | 17 |



BOTTOM

Chicago Cubs @ Cincinnati Reds  
Crosley Field, Cincinnati, OH  
Sat Sep 09 1950, 3:38 AM EDT  
Att. 2,933 - Overcast

livebaseballscorecards.com

|     |    |
|-----|----|
| AB  | 28 |
| R   | 7  |
| H   | 9  |
| RBI | 6  |
| BB  | 5  |
| SO  | 3  |
| LOB | 10 |



|     |   |     |    |
|-----|---|-----|----|
| WP: | 1 | PA: | 35 |
| PB: | 0 |     |    |
| SB: | 1 |     |    |
| CS: | 0 |     |    |

AB R H RBI BB SO LOB

|   |   |   |   |   |   |   |
|---|---|---|---|---|---|---|
| 4 | 1 | 1 | 1 | 0 | 0 | 1 |
| 3 | 1 | 1 | 0 | 1 | 0 | 0 |
| 3 | 2 | 1 | 2 | 1 | 0 | 1 |
| 3 | 1 | 1 | 1 | 1 | 0 | 1 |
| 3 | 1 | 2 | 2 | 1 | 0 | 1 |
| 4 | 0 | 1 | 0 | 0 | 0 | 3 |
| 3 | 0 | 0 | 0 | 1 | 2 | 2 |
| 4 | 1 | 2 | 0 | 0 | 0 | 1 |
| 1 | 0 | 0 | 0 | 0 | 1 | 0 |
| 0 | 0 | 0 | 0 | 0 | 0 | 0 |
| 0 | 0 | 0 | 0 | 0 | 0 | 0 |

|     |   |      |   |
|-----|---|------|---|
| 1B: | 5 | SF:  | 0 |
| 2B: | 3 | SAC: | 2 |
| 3B: | 1 | DP:  | 3 |
| HR: | 1 | HBP: | 0 |

|    |    |   |   |     |      |
|----|----|---|---|-----|------|
| WP | HR | S | P | ERA | WHIP |
|----|----|---|---|-----|------|

| Batter  | 1                          | 2           | 3           | 4            | 5                  | 6                 | 7                 | 8 | 9 |
|---|----------------------------|-------------|-------------|--------------|--------------------|-------------------|-------------------|---|---|
| Lloyd Merriman, L (1, 8)<br>OBP: 0.335, SLG: 0.359  | 0-0 F7<br>①                |             | 0-0 F8<br>① |              | 0-0 WP<br>3B 2B    | 0-0 L4-6<br>② ③   |                   |   |   |
| Grady Hatton, L (1, 5)<br>OBP: 0.364, SLG: 0.392    | 0-0 F8<br>②                |             | 0-0 F7<br>② |              | 4-0 3B<br>BB       |                   | 0-0 G3<br>2B      |   |   |
| Johnny Wyrostek, L (1, 9)<br>OBP: 0.391, SLG: 0.464 | 4-0 1B<br>BB<br>E          |             | 0-0 F8<br>③ |              | 0-0 1B<br>3B       |                   | 0-0 G3<br>①       |   |   |
| Ted Kluszewski, L (1, 3)<br>OBP: 0.354, SLG: 0.551  | 4-0 E<br>1-2<br>BB         |             |             | 0-0 6-3<br>① | 0-0 HR<br>1B       |                   | 0-0 L3<br>②       |   |   |
| Joe Adcock, R (1, 7)<br>OBP: 0.324, SLG: 0.396      | 0-0 E4<br>1-3<br>2-H<br>1B |             |             | 4-0 BB       | 0-0 HR             |                   | 0-0 1-3<br>③      |   |   |
| Johnny Pramesa, R (1, 2)<br>OBP: 0.366, SLG: 0.452  | 0-0 5-3<br>③               |             |             | 0-0 F4<br>②  | 0-0 G1-6-3<br>1B   |                   | 0-0 F7<br>①       |   |   |
| Connie Ryan, R (1, 4)<br>OBP: 0.353, SLG: 0.362     |                            | 0-3 K<br>①  |             | 0-3 K<br>③   | 0-0 G1-6-3<br>② ③  |                   | 4-0 G6-4-3<br>BB  |   |   |
| Virgil Stallcup, R (1, 6)<br>OBP: 0.286, SLG: 0.369 |                            | 0-0 F7<br>② |             |              | 0-0 SH1-4<br>2B 1B | 0-0 L4-6<br>SH1-4 | 0-0 G6-4-3<br>② ③ |   |   |
| Willie Ramsdell, R (1, 1)<br>OBP: 0.275, SLG: 0.213 |                            | 0-3 K<br>③  |             |              | 0-0 SH1-4<br>①     | 0-0 SH1-4<br>①    |                   |   |   |
| Frank Smith, R (8, 1)<br>OBP: 0.059, SLG: 0.059     |                            |             |             |              |                    |                   |                   |   |   |
| Ewell Blackwell, R (9, 1)<br>OBP: 0.139, SLG: 0.093 |                            |             |             |              |                    |                   |                   |   |   |

| Inning Stats | R: 1 | H: 1 | E: 1 | K: 0 | S: 4 | LOB: 2 | BB: 2 | P: 12 | R: 0 | H: 0 | E: 0 | K: 2 | S: 7 | LOB: 0 | BB: 0 | P: 7 | R: 0 | H: 0 | E: 0 | K: 0 | S: 3 | LOB: 0 | BB: 0 | P: 3 | R: 0 | H: 0 | E: 0 | K: 1 | S: 5 | LOB: 1 | BB: 1 | P: 9 | R: 6 | H: 6 | E: 0 | K: 0 | S: 8 | LOB: 0 | BB: 1 | P: 12 | R: 0 | H: 1 | E: 0 | K: 0 | S: 3 | LOB: 0 | BB: 0 | P: 3 | R: 0 | H: 1 | E: 0 | K: 0 | S: 4 | LOB: 1 | BB: 0 | P: 4 | R: 0 | H: 0 | E: 0 | K: 0 | S: 2 | LOB: 0 | BB: 1 | P: 6 |
|--------------|------|------|------|------|------|--------|-------|-------|------|------|------|------|------|--------|-------|------|------|------|------|------|------|--------|-------|------|------|------|------|------|------|--------|-------|------|------|------|------|------|------|--------|-------|-------|------|------|------|------|------|--------|-------|------|------|------|------|------|------|--------|-------|------|------|------|------|------|------|--------|-------|------|
|--------------|------|------|------|------|------|--------|-------|-------|------|------|------|------|------|--------|-------|------|------|------|------|------|------|--------|-------|------|------|------|------|------|------|--------|-------|------|------|------|------|------|------|--------|-------|-------|------|------|------|------|------|--------|-------|------|------|------|------|------|------|--------|-------|------|------|------|------|------|------|--------|-------|------|

| PITCHER                                  | IP  | WLS | BF | H | R | ER | SO | BB | IBB | HBP | BLK | WP | HR | S  | P  | ERA   | WHIP  |
|--|-----|-----|----|---|---|----|----|----|-----|-----|-----|----|----|----|----|-------|-------|
| Johnny Klippstein, R (1, 1)<br>ERA: 5.55 | 4.1 | L   | 22 | 5 | 6 | 5  | 3  | 4  | 0   | 0   | 0   | 1  | 0  | 24 | 40 | 10.38 | 2.077 |
| Doyle Lade, R (5, 1)<br>ERA: 4.83        | 2.2 |     | 10 | 4 | 1 | 1  | 0  | 0  | 0   | 0   | 0   | 0  | 1  | 10 | 10 | 3.38  | 1.500 |
| Andy Varga, L (8, 1)<br>ERA:             | 1.0 |     | 3  | 0 | 0 | 0  | 0  | 1  | 0   | 0   | 0   | 0  | 0  | 2  | 6  | 0.00  | 1.000 |

| Batter  | 1   | 2   | 3   | 4  | 5   | 6   | 7   | 8   | 9   | AB R H RBI BB SO LOB   | TOP                                     |  |  |
|---|---|---|---|--|---|---|---|---|---|--|---|--|--|
| <b>Carmen Mauro, L</b> (1, 9)<br>OBP: 0.295, SLG: 0.315<br><b>Bob Borkowski, R</b> (5, 9)<br>OBP: 0.322, SLG: 0.383   | 0-0<br>G6-4-3<br>1B                                   |   | 0-0<br>4-3<br>1-2                                   |  | 0-3<br>K  | 4-0<br>BB   |   | 0-0<br>6-3  |   | 3 0 1 0 0 1 1<br>1 0 0 0 1 0 0                                   |   |  |  |
| <b>Preston Ward, L</b> (1, 3)<br>OBP: 0.326, SLG: 0.382   | 0-0<br>F2   |   | 0-0<br>1B<br>2-H                                    |  | 0-0<br>1B<br>F7<br>2B                               | 0-0<br>G3   |   | 0-0<br>G3   |   | 5 1 2 1 0 0 3  |   |  |  |
| <b>Bill Serena, R</b> (1, 5)<br>OBP: 0.343, SLG: 0.426  | 0-0<br>G6-4-3<br>1-2f                                 |   | 0-0<br>FC5-4<br>1B                                  |  | 0-0<br>F7<br>1B                                     |   | 0-0<br>FC5-4<br>1B<br>1B                            | 0-0<br>F8   |   | 5 1 3 0 0 0 1  |   |  |  |
| <b>Hank Sauer, R</b> (1, 7)<br>OBP: 0.355, SLG: 0.522   |   | 0-0<br>L6   | 0-0<br>FC5-4<br>1-2f                                |  | 0-0<br>F7<br>1-2<br>3-H                             |   | 0-0<br>FC5-4<br>1B                                  |   | 0-0<br>6-3  | 5 0 1 1 0 0 3  |   |  |  |
| <b>Andy Paiko, R</b> (1, 8)<br>OBP: 0.414, SLG: 0.627   |   | 4-0<br>BB   |   | 0-0<br>3B  | 0-3<br>K  |   | 0-0<br>FC5-4<br>1B<br>1-2f<br>2-3                   | 0-0<br>F9   |   | 4 1 1 0 1 1 3  |   |  |  |
| <b>Carl Sawatski, L</b> (1, 2)<br>OBP: 0.292, SLG: 0.219  |   | 0-0<br>F7   |   | 0-0<br>F6  |   | 0-0<br>PB<br>E<br>1B                                | 0-0<br>1B<br>1B                                     | 0-0<br>4-3  |   | 5 1 2 1 0 0 2  |   |  |  |
| <b>Roy Smalley, R</b> (1, 6)<br>OBP: 0.290, SLG: 0.403  |   | 0-0<br>F4   |   | 0-3<br>K   |   | 0-0<br>F4   | 0-0<br>1B<br>1-2<br>2-H                             |   |   | 4 0 1 1 0 1 3  |   |  |  |
| <b>Wayne Terwilliger, R</b> (1, 4)<br>OBP: 0.303, SLG: 0.352<br><b>Phil Cavarretta, L</b> (7, PH)<br>OBP: 0.375, SLG: 0.442<br><b>Bob Ramazzotti, R</b> (7, 4)<br>OBP: 0.277, SLG: 0.336  |   |   | 0-0<br>1B<br>4-3<br>1B                              | H<br>1-0<br>HBP  |   | 0-0<br>5-3  | 0-0<br>F8   |   |   | 2 1 1 0 0 0 1<br>1 0 0 0 0 0 2<br>0 0 0 0 0 0 0                  |   |  |  |
| <b>Johnny Schmitz, R</b> (1, 1)<br>OBP: 0.143, SLG: 0.161<br><b>Johnny Vander Meer, S</b> (4, 1)<br>OBP: 0.188, SLG: 0.267<br><b>Ron Northey, L</b> (7, PH)<br>OBP: 0.351, SLG: 0.468<br><b>Paul Minner, L</b> (7, 1)<br>OBP: 0.274, SLG: 0.310 |   |   | 0-3<br>K<br>1B                                      | 0-0<br>4-3   |   | 0-0<br>E6<br>BB<br>1B                               | 0-0<br>F3   |   |   | 2 0 0 0 0 1 3<br>1 0 1 0 0 0 0<br>1 0 0 0 0 0 2<br>0 0 0 0 0 0 0 |   |  |  |
| <b>Inning Stats</b>   | R: 0 H: 1<br>E: 0 LOB: 0<br>K: 0 BB: 0<br>S: 3 P: 3   | R: 0 H: 0<br>E: 0 LOB: 1<br>K: 0 BB: 1<br>S: 3 P: 7 | R: 1 H: 3<br>E: 0 LOB: 2<br>K: 1 BB: 0<br>S: 8 P: 8 | R: 0 H: 1<br>E: 0 LOB: 2<br>K: 1 BB: 0<br>S: 6 P: 7                  | R: 1 H: 2<br>E: 0 LOB: 1<br>K: 2 BB: 0<br>S: 9 P: 9 | R: 1 H: 2<br>E: 1 LOB: 2<br>K: 0 BB: 1<br>S: 5 P: 9 | R: 2 H: 4<br>E: 0 LOB: 2<br>K: 0 BB: 0<br>S: 7 P: 7 | R: 0 H: 0<br>E: 0 LOB: 0<br>K: 0 BB: 0<br>S: 3 P: 3 | R: 0 H: 0<br>E: 0 LOB: 0<br>K: 0 BB: 0<br>S: 3 P: 3 | 1B: 11 SF: 0<br>2B: 1 SAC: 0<br>3B: 1 DP: 1<br>HR: 0 HBP: 1      | WP: 0 PA: 42<br>PB: 1<br>SB: 0<br>CS: 0 |  |  |
| <b>PITCHER</b><br><b>Herm Wehmeier, R</b> (1, 1)<br>ERA: 5.67<br><b>Eddie Erault, R</b> (7, 1)<br>ERA: 5.74   | IP WLS BF H R ER SO BB IBB HBP BLK WP HR S P ERA WHIP | 6.1 W 33 12 5 4 4 2 0 1 0 0 0 0 38 47 5.68 2.211    | 2.2 S 9 1 0 0 0 0 0 0 0 0 0 0 9 9 0.00 0.375        | <b>PITCHER</b> IP WLS BF H R ER SO BB IBB HBP BLK WP HR S P ERA WHIP |   |   |   |   |   |  |   |  |  |

**Chicago Cubs @ Cincinnati Reds**  
Crosley Field, Cincinnati, OH  
Sun Sep 10 1950, 3:33 AM EDT  
Cloudy - 76 F

livebaseballscorecards.com

|     |    |
|-----|----|
| AB  | 39 |
| R   | 5  |
| H   | 13 |
| RBI | 4  |
| BB  | 2  |
| SO  | 4  |
| LOB | 24 |



BOTTOM

Chicago Cubs @ Cincinnati Reds  
Crosley Field, Cincinnati, OH  
Sun Sep 10 1950, 3:33 AM EDT  
Cloudy - 76 F

livebaseballscorecards.com

|     |    |
|-----|----|
| AB  | 37 |
| R   | 12 |
| H   | 13 |
| RBI | 9  |
| BB  | 8  |
| SO  | 3  |
| LOB | 24 |



|     |   |     |    |
|-----|---|-----|----|
| WP: | 0 | PA: | 47 |
| PB: | 0 | SB: | 0  |
| CS: | 0 |     |    |

AB R H RBI BB SO LOB

|   |   |   |   |   |   |   |
|---|---|---|---|---|---|---|
| 4 | 2 | 2 | 1 | 2 | 0 | 1 |
| 4 | 1 | 1 | 2 | 2 | 0 | 3 |
| 5 | 1 | 1 | 2 | 0 | 1 | 4 |
| 4 | 1 | 0 | 0 | 1 | 0 | 3 |
| 4 | 1 | 1 | 0 | 1 | 0 | 3 |
| 4 | 3 | 3 | 1 | 1 | 0 | 1 |
| 5 | 2 | 3 | 1 | 0 | 0 | 2 |
| 3 | 1 | 2 | 2 | 1 | 0 | 2 |
| 3 | 0 | 0 | 0 | 0 | 1 | 3 |
| 1 | 0 | 0 | 0 | 0 | 1 | 2 |

|     |   |      |   |
|-----|---|------|---|
| 1B: | 9 | SF:  | 0 |
| 2B: | 4 | SAC: | 2 |
| 3B: | 0 | DP:  | 0 |
| HR: | 0 | HBP: | 0 |

|     |   |     |    |
|-----|---|-----|----|
| WP: | 0 | PA: | 47 |
| PB: | 0 | SB: | 0  |
| CS: | 0 |     |    |

| Batter  | 1               | 2                         | 3                       | 4                       | 5               | 6                        | 7                           | 8                        | 9 |
|---|-----------------|---------------------------|-------------------------|-------------------------|-----------------|--------------------------|-----------------------------|--------------------------|---|
| Bobby Adams, R<br>OBP: 0.365, SLG: 0.423<br>(1, 5)  | 0-0<br>5-3<br>1 |                           | 4-0<br>2B<br>BB         | 0-0<br>2B<br>2B         | 0-0<br>F9<br>2  |                          | 0-0<br>BB<br>1B             | 4-0<br>BB                |   |
| Bob Usher, R<br>OBP: 0.314, SLG: 0.362<br>(1, 8)  | 0-0<br>L5<br>2  |                           | 0-0<br>4-3<br>1-H<br>2B | 4-0<br>2B<br>E<br>IBB   | 0-0<br>1-3<br>3 |                          | 4-0<br>1-2<br>2-3<br>BB     | 0-0<br>L4<br>3           |   |
| Johnny Wyrostek, L<br>OBP: 0.389, SLG: 0.463<br>(1, 9)  | 0-0<br>F9<br>3  |                           | 0-0<br>4-3<br>2-3       | 0-0<br>E<br>2B          |                 | 0-0<br>F7<br>1<br>S.O.S. | 0-3<br>K<br>2               |                          |   |
| Ted Kluszewski, L<br>OBP: 0.352, SLG: 0.546<br>(1, 3)   |                 | 0-0<br>G3<br>1            | 4-0<br>BB               | 0-0<br>FC1<br>5-3<br>1B |                 | 0-0<br>4-3<br>2          | 0-0<br>F8<br>3              |                          |   |
| Joe Adcock, R<br>OBP: 0.326, SLG: 0.394<br>(1, 7)   |                 | 4-0<br>1B<br>BB           | 0-0<br>G3<br>3          | 0-0<br>5-3<br>2-3       |                 | 0-0<br>5-3<br>3          |                             | 0-0<br>1B<br>E<br>1B     |   |
| Connie Ryan, R<br>OBP: 0.357, SLG: 0.368<br>(1, 4)  |                 | 0-0<br>F3<br>2            |                         | 0-0<br>1B<br>BB         |                 |                          | 0-0<br>1B<br>2B             | 0-0<br>1-H<br>1B<br>1B   |   |
| Virgil Stallcup, R<br>OBP: 0.290, SLG: 0.372<br>(1, 6)  |                 | 0-0<br>FC6-4<br>1B        |                         | 0-0<br>1B<br>1B         |                 |                          | 0-0<br>1B<br>SH<br>BB<br>1B | 0-0<br>F2<br>1           |   |
| Dixie Howell, R<br>OBP: 0.329, SLG: 0.301<br>(1, 2)   |                 | 0-0<br>FC6-4<br>1-2f<br>3 |                         | 0-0<br>2B<br>1B         |                 | 4-0<br>E<br>BB           | 0-0<br>SH<br>BB<br>1B       | 0-0<br>SH1-4<br>1B       |   |
| Herm Wehmeier, R<br>OBP: 0.176, SLG: 0.202<br>Eddie Erault, R<br>OBP: 0.231, SLG: 0.250<br>(7, 1) |                 |                           | 0-0<br>1-3<br>1         | 0-0<br>F5<br>1          | 0-3<br>K<br>1-2 |                          | 0-3<br>K<br>1               | 0-0<br>SH1-4<br>1-2<br>2 |   |

| Inning Stats | R: 0 | H: 0 | E: 0 | K: 0 | S: 3 | LOB: 0 | BB: 0 | P: 3 | R: 0 | H: 1 | E: 0 | K: 0 | S: 4 | LOB: 2 | BB: 1 | P: 8 | R: 1 | H: 1 | E: 1 | K: 0 | S: 9 | LOB: 1 | BB: 2 | P: 12 | R: 0 | H: 0 | E: 0 | K: 1 | S: 5 | LOB: 1 | BB: 1 | P: 9 | R: 0 | H: 0 | E: 0 | K: 0 | S: 3 | LOB: 0 | BB: 0 | P: 3 | R: 2 | H: 3 | E: 0 | K: 2 | S: 11 | LOB: 3 | BB: 1 | P: 15 | R: 2 | H: 3 | E: 1 | K: 0 | S: 6 | LOB: 2 | BB: 1 | P: 10 |
|--------------|------|------|------|------|------|--------|-------|------|------|------|------|------|------|--------|-------|------|------|------|------|------|------|--------|-------|-------|------|------|------|------|------|--------|-------|------|------|------|------|------|------|--------|-------|------|------|------|------|------|-------|--------|-------|-------|------|------|------|------|------|--------|-------|-------|
|--------------|------|------|------|------|------|--------|-------|------|------|------|------|------|------|--------|-------|------|------|------|------|------|------|--------|-------|-------|------|------|------|------|------|--------|-------|------|------|------|------|------|------|--------|-------|------|------|------|------|------|-------|--------|-------|-------|------|------|------|------|------|--------|-------|-------|

| PITCHER                                      | IP  | WLS | BF | H | R | ER | SO | BB | IBB | HBP | BLK | WP | HR | S  | P  | ERA   | WHIP  |
|--|-----|-----|----|---|---|----|----|----|-----|-----|-----|----|----|----|----|-------|-------|
| Johnny Schmitz, L<br>ERA: 4.99<br>(1, 1)     | 3.1 | L   | 21 | 6 | 7 | 5  | 0  | 4  | 1   | 0   | 0   | 0  | 0  | 16 | 36 | 13.50 | 3.000 |
| Johnny Vander Meer, L<br>ERA: 3.89<br>(4, 1) | 2.2 |     | 11 | 1 | 1 | 0  | 1  | 1  | 0   | 0   | 0   | 0  | 0  | 12 | 16 | 0.00  | 0.750 |
| Paul Minner, L<br>ERA: 3.94<br>(7, 1)        | 2.0 |     | 15 | 6 | 4 | 3  | 2  | 2  | 0   | 0   | 0   | 0  | 0  | 17 | 25 | 13.50 | 4.000 |

| PITCHER                                      | IP  | WLS | BF | H | R | ER | SO | BB | IBB | HBP | BLK | WP | HR | S  | P  | ERA   | WHIP  |
|--|-----|-----|----|---|---|----|----|----|-----|-----|-----|----|----|----|----|-------|-------|
| Johnny Schmitz, L<br>ERA: 4.99<br>(1, 1)     | 3.1 | L   | 21 | 6 | 7 | 5  | 0  | 4  | 1   | 0   | 0   | 0  | 0  | 16 | 36 | 13.50 | 3.000 |
| Johnny Vander Meer, L<br>ERA: 3.89<br>(4, 1) | 2.2 |     | 11 | 1 | 1 | 0  | 1  | 1  | 0   | 0   | 0   | 0  | 0  | 12 | 16 | 0.00  | 0.750 |
| Paul Minner, L<br>ERA: 3.94<br>(7, 1)        | 2.0 |     | 15 | 6 | 4 | 3  | 2  | 2  | 0   | 0   | 0   | 0  | 0  | 17 | 25 | 13.50 | 4.000 |

| Batter   | 1                            | 2                               | 3                            | 4                               | 5                            | 6                               | 7                            | 8                               | 9                            | AB R H RBI BB SO LOB                            | TOP                          |                                 |                              |                                 |                              |                                 |                                  |                                    |                                  |        |     |     |    |    |   |   |     |      |  |  |  |  |
|--|------------------------------|---------------------------------|------------------------------|---------------------------------|------------------------------|---------------------------------|------------------------------|---------------------------------|------------------------------|---|------------------------------|---------------------------------|------------------------------|---------------------------------|------------------------------|---------------------------------|----------------------------------|------------------------------------|----------------------------------|--------|-----|-----|----|----|---|---|-----|------|--|--|--|--|
| <b>Carmen Mauro, L</b> (1, 9)<br>OBP: 0.293, SLG: 0.311              | 0-0<br>6-3                   |                                 | 0-3<br>K                     |                                 | 0-0<br>G3                    |                                 | 0-0<br>1-3<br>1B             |                                 | 0-0<br>F4                    | 5 0 1 0 0 1 2                                   |                              |                                 |                              |                                 |                              |                                 |                                  |                                    |                                  |        |     |     |    |    |   |   |     |      |  |  |  |  |
| <b>Phil Cavarretta, L</b> (1, 3)<br>OBP: 0.376, SLG: 0.445           | 4-0<br>CS<br>BB              |                                 | 0-0<br>5-3                   |                                 | 0-0<br>2B                    |                                 | 0-0<br>4-3                   |                                 |                              | 3 0 1 0 1 0 2                                   |                              |                                 |                              |                                 |                              |                                 |                                  |                                    |                                  |        |     |     |    |    |   |   |     |      |  |  |  |  |
| <b>Bill Serena, R</b> (1, 5)<br>OBP: 0.340, SLG: 0.422               | 0-0<br>E5<br>PB<br>1-2<br>1B |                                 | 0-3<br>K                     |                                 | 0-0<br>6-3                   |                                 |                              | 0-0<br>F6                       |                              | 4 0 0 0 0 1 2                                   |                              |                                 |                              |                                 |                              |                                 |                                  |                                    |                                  |        |     |     |    |    |   |   |     |      |  |  |  |  |
| <b>Hank Sauer, R</b> (1, 7)<br>OBP: 0.354, SLG: 0.520                | 0-0<br>2-H<br>1B             |                                 |                              | 0-0<br>4-3                      |                              | 0-0<br>F8                       |                              | 0-0<br>2-3                      |                              | 4 0 1 0 0 0 0                                   |                              |                                 |                              |                                 |                              |                                 |                                  |                                    |                                  |        |     |     |    |    |   |   |     |      |  |  |  |  |
| <b>Andy Pafko, R</b> (1, 8)<br>OBP: 0.413, SLG: 0.626                |                              | 0-0<br>1B<br>1B<br>2B           |                              | 0-0<br>4-3                      |                              | 0-0<br>6-3                      |                              | 0-0<br>5-3                      |                              | 4 1 1 0 0 0 0                                   |                              |                                 |                              |                                 |                              |                                 |                                  |                                    |                                  |        |     |     |    |    |   |   |     |      |  |  |  |  |
| <b>Rube Walker, L</b> (1, 2)<br>OBP: 0.269, SLG: 0.361               |                              | 0-0<br>F7                       |                              | 0-0<br>1B<br>1B                 |                              | 0-0<br>F8                       |                              | 0-0<br>F8                       |                              | 4 0 1 0 0 0 1                                   |                              |                                 |                              |                                 |                              |                                 |                                  |                                    |                                  |        |     |     |    |    |   |   |     |      |  |  |  |  |
| <b>Roy Smalley, R</b> (1, 6)<br>OBP: 0.294, SLG: 0.411               |                              | 0-0<br>1B<br>1B                 |                              | 0-0<br>1-2<br>1B                |                              | 0-0<br>FC1<br>3B                |                              | 0-0<br>1B<br>1B                 |                              | 3 0 3 0 0 0 0<br>1 0 1 0 0 0 0                  |                              |                                 |                              |                                 |                              |                                 |                                  |                                    |                                  |        |     |     |    |    |   |   |     |      |  |  |  |  |
| <b>Bob Ramazzotti, R</b> (7, PR)<br>(7, 6)<br>OBP: 0.282, SLG: 0.340 |                              | 2-3<br>1B                       |                              | 1-2<br>1B                       |                              |                                 |                              |                                 |                              |   |                              |                                 |                              |                                 |                              |                                 |                                  |                                    |                                  |        |     |     |    |    |   |   |     |      |  |  |  |  |
| <b>Wayne Terwilliger, R</b> (1, 4)<br>OBP: 0.303, SLG: 0.352         |                              | 0-0<br>1-2<br>G1-6-3<br>1B      |                              | 0-0<br>F2                       |                              | 0-0<br>F3                       |                              | 0-3<br>K                        |                              | 3 0 1 1 0 0 3<br>1 0 0 0 0 1 1                  |                              |                                 |                              |                                 |                              |                                 |                                  |                                    |                                  |        |     |     |    |    |   |   |     |      |  |  |  |  |
| <b>Carl Sawatski, L</b> (9, PH)<br>(9, PH)<br>OBP: 0.288, SLG: 0.215 |                              | 3-H<br>1B                       |                              |                                 |                              |                                 |                              |                                 |                              |   |                              |                                 |                              |                                 |                              |                                 |                                  |                                    |                                  |        |     |     |    |    |   |   |     |      |  |  |  |  |
| <b>Warren Hacker, R</b> (1, 1)<br>(9, PH)<br>OBP: 0.354, SLG: 0.471  |                              | 0-0<br>G1-6-3                   |                              |                                 |                              | 0-0<br>1-3                      |                              | 0-0<br>FC1<br>1B                |                              | 3 0 0 0 0 0 3<br>1 0 1 0 0 0 0<br>0 0 0 0 0 0 0 |                              |                                 |                              |                                 |                              |                                 |                                  |                                    |                                  |        |     |     |    |    |   |   |     |      |  |  |  |  |
| <b>Emil Verban, R</b> (9, PR)<br>(9, PR)<br>OBP: 0.175, SLG: 0.135   |                              | 1-2                             |                              |                                 |                              |                                 |                              | 3-H<br>1B                       |                              |   |                              |                                 |                              |                                 |                              |                                 |                                  |                                    |                                  |        |     |     |    |    |   |   |     |      |  |  |  |  |
| <b>Inning Stats</b>  | R: 0<br>E: 1<br>K: 0<br>S: 3 | H: 1<br>LOB: 2<br>BB: 1<br>P: 7 | R: 1<br>E: 0<br>K: 0<br>S: 5 | H: 3<br>LOB: 1<br>BB: 0<br>P: 5 | R: 0<br>E: 0<br>K: 2<br>S: 7 | H: 0<br>LOB: 0<br>BB: 0<br>P: 7 | R: 0<br>E: 0<br>K: 0<br>S: 5 | H: 2<br>LOB: 2<br>BB: 0<br>P: 5 | R: 0<br>E: 0<br>K: 0<br>S: 4 | H: 1<br>LOB: 1<br>BB: 0<br>P: 4                 | R: 0<br>E: 0<br>K: 0<br>S: 3 | H: 0<br>LOB: 0<br>BB: 0<br>P: 3 | R: 0<br>E: 0<br>K: 0<br>S: 5 | H: 2<br>LOB: 2<br>BB: 0<br>P: 5 | R: 0<br>E: 0<br>K: 1<br>S: 7 | H: 2<br>LOB: 2<br>BB: 0<br>P: 7 | 1B: 8<br>2B: 2<br>3B: 1<br>HR: 0 | SF: 0<br>SAC: 0<br>DP: 1<br>HBP: 0 | WP: 0<br>PB: 1<br>SB: 0<br>CS: 1 | PA: 37 |     |     |    |    |   |   |     |      |  |  |  |  |
| <b>PITCHER</b><br><b>Howie Fox, R</b> (1, 1)<br>ERA: 4.62            | IP<br>9.0                    | WLS<br>W                        | BF<br>37                     | H<br>11                         | R<br>1                       | ER<br>1                         | SO<br>3                      | BB<br>1                         | IBB<br>0                     | HBP<br>0  | BLK<br>0                     | WP<br>0                         | HR<br>0                      | S<br>42                         | P<br>46                      | ERA<br>1.00                     | WHIP<br>1.333                    |                                    |                                  |        |     |     |    |    |   |   |     |      |  |  |  |  |
|  |                              |                                 |                              |                                 |                              |                                 |                              |                                 |                              |   | <b>PITCHER</b>               | IP                              | WLS                          | BF                              | H                            | R                               | ER                               | SO                                 | BB                               | IBB    | HBP | BLK | WP | HR | S | P | ERA | WHIP |  |  |  |  |

**Chicago Cubs @ Cincinnati Reds**  
Crosley Field, Cincinnati, OH  
Sun Sep 10 1950, 3:38 AM EDT  
Att: 9,682 - Cloudy - 77 F

[livebaseballscorecards.com](http://livebaseballscorecards.com)

|            |    |
|------------|----|
| <b>AB</b>  | 36 |
| <b>R</b>   | 1  |
| <b>H</b>   | 11 |
| <b>RBI</b> | 1  |
| <b>BB</b>  | 1  |
| <b>SO</b>  | 3  |
| <b>LOB</b> | 14 |



| Batter   | 1          | 2                             | 3          | 4            | 5           | 6              | 7                           | 8 | 9 |
|--|------------|-------------------------------|------------|--------------|-------------|----------------|-----------------------------|---|---|
| Lloyd Merriman, L<br>OBP: 0.330, SLG: 0.353<br>(1, 8) X  | 0-0 F8 ① X | 0-0 F8 ③                      |            |              | X 0-0 4-3 ① |                | X 0-0 FC3-6 ①<br>CS<br>1-2f |   |   |
| Grady Hatton, L<br>OBP: 0.361, SLG: 0.388<br>(1, 5) X    | 0-0 F7 ②   |                               | X 0-0 F8 ① |              | X 0-0 F4 ②  |                | X 0-0 4-3 ②<br>③            |   |   |
| Johnny Wyrostek, L<br>OBP: 0.388, SLG: 0.464<br>(1, 9) X | 0-0 1-3 ③  |                               | X 0-0 F7 ② |              | X 0-0 2B    |                | X 0-0 F2 ①                  |   |   |
| Ted Kluszewski, L<br>OBP: 0.356, SLG: 0.546<br>(1, 3)    |            | B BB 4-0 SH1-3 1B<br>1B BB    | B BB 4-0   |              | X 0-0 F8 ③  |                | X 0-0 1B                    |   |   |
| Joe Adcock, R<br>OBP: 0.325, SLG: 0.392<br>(1, 7)        |            | X 0-0 SH1-3 1B<br>1-2 1B      | X 0-0 F7 ③ |              | X 0-0 F9 ①  |                | X 0-0 F4 ②                  |   |   |
| Johnny Pramesa, R<br>OBP: 0.366, SLG: 0.450<br>(1, 2)    |            | X 0-0 SH1-3 ①                 |            | X 0-0 F9 ①   |             | X 0-0 1B       | X 0-0 G3 ③                  |   |   |
| Connie Ryan, R<br>OBP: 0.359, SLG: 0.371<br>(1, 4)       |            | 4-0 1B<br>FC1-2 IBB           |            | X 0-0 1-3 2B |             | X 0-0 F9 ②     |                             |   |   |
| Sammy Meeks, R<br>OBP: 0.326, SLG: 0.381<br>(1, 6)       |            | X 0-0 FC1-2 1B<br>1-3 2-H 3-H |            | X 0-0 1-3 ②  |             | X 0-0 G3 ③     |                             |   |   |
| Howie Fox, R<br>OBP: 0.224, SLG: 0.292<br>(1, 1)         |            | X 0-0 FC1-2 ②                 |            | X 0-0 4-3 ③  |             | X 0-0 FC3-6 1B |                             |   |   |

| Inning Stats | R: 0 | H: 0 | E: 0 | K: 0 | S: 3   | LOB: 0 | BB: 0 | P: 3 |
|--------------|------|------|------|------|--------|--------|-------|------|
| R: 2         | H: 2 | E: 0 | K: 0 | S: 5 | LOB: 2 | BB: 2  | P: 13 |      |
| R: 0         | H: 0 | E: 0 | K: 0 | S: 3 | LOB: 1 | BB: 1  | P: 7  |      |
| R: 0         | H: 1 | E: 0 | K: 0 | S: 4 | LOB: 1 | BB: 0  | P: 4  |      |
| R: 0         | H: 1 | E: 0 | K: 0 | S: 4 | LOB: 1 | BB: 0  | P: 4  |      |
| R: 0         | H: 1 | E: 0 | K: 0 | S: 3 | LOB: 0 | BB: 0  | P: 3  |      |
| R: 0         | H: 1 | E: 0 | K: 0 | S: 4 | LOB: 1 | BB: 0  | P: 4  |      |

**BOTTOM**

**Chicago Cubs @ Cincinnati Reds**  
Crosley Field, Cincinnati, OH

Sun Sep 10 1950, 3:38 AM EDT  
Att. 9,682 - Cloudy - 77 F

livebaseballscorecards.com

|            |           |
|------------|-----------|
| <b>AB</b>  | <b>29</b> |
| <b>R</b>   | <b>2</b>  |
| <b>H</b>   | <b>7</b>  |
| <b>RBI</b> | <b>2</b>  |
| <b>BB</b>  | <b>3</b>  |
| <b>SO</b>  | <b>0</b>  |
| <b>LOB</b> | <b>14</b> |

**AB** 29  
**R** 2  
**H** 7  
**RBI** 2  
**BB** 3  
**SO** 0  
**LOB** 14



|       |        |       |        |
|-------|--------|-------|--------|
| 1B: 5 | SF: 0  | WP: 0 | PA: 33 |
| 2B: 2 | SAC: 1 | PB: 0 |        |
| 3B: 0 | DP: 0  | SB: 0 |        |
| HR: 0 | HBP: 0 | CS: 1 |        |

| PITCHER                                 | IP  | WLS | BF | H | R | ER | SO | BB | IBB | HBP | BLK | WP | HR | S  | P  | ERA  | WHIP  |
|---|-----|-----|----|---|---|----|----|----|-----|-----|-----|----|----|----|----|------|-------|
| Warren Hacker, R<br>ERA: 2.25<br>(1, 1) | 8.0 | L   | 33 | 7 | 2 | 2  | 0  | 2  | 1   | 0   | 0   | 0  | 0  | 30 | 42 | 2.25 | 1.125 |

| Batter  | 1   | 2                               | 3                            | 4                               | 5                            | 6                               | 7                            | 8                               | 9                            | AB R H RBI BB SO LOB            | TOP   |                                 |   |                                 |                              |                                  |                              |                                 |                                  |                                    |                                  |        |
|---|---|---------------------------------|------------------------------|---------------------------------|------------------------------|---------------------------------|------------------------------|---------------------------------|------------------------------|---------------------------------|---|---------------------------------|---|---------------------------------|------------------------------|----------------------------------|------------------------------|---------------------------------|----------------------------------|------------------------------------|----------------------------------|--------|
| Lloyd Merriman, L (1, 8)<br>OBP: 0.325, SLG: 0.348    | 0-0 L8  |                                 | 0-0 F8                       |                                 | 0-0 1-3                      |                                 |                              | 0-3 K                           |                              | 4 0 0 0 0 1 1                   | <b>Cincinnati Reds @ Brooklyn Dodgers</b><br>Ebbets Field, Brooklyn, NY<br>Tue Sep 12 1950, 3:33 AM EDT<br>Att. 3,323 - Unknown |                                 |   |                                 |                              |                                  |                              |                                 |                                  |                                    |                                  |        |
| Grady Hatton, L (1, 5)<br>OBP: 0.360, SLG: 0.385      | 0-0 4-3   |                                 | 0-0 F9                       |                                 |                              | 0-0 F5                          |                              | 4-0 BB                          |                              | 3 0 0 0 1 0 0                   |   |                                 |   |                                 |                              |                                  |                              |                                 |                                  |                                    |                                  |        |
| Johnny Wyrostek, L (1, 9)<br>OBP: 0.385, SLG: 0.459   | 0-0 E6  |                                 |                              | 0-0 3-1                         |                              | 0-0 F9                          |                              | 0-0 FC5                         |                              | 4 0 0 0 0 0 2                   |   |                                 |   |                                 |                              |                                  |                              |                                 |                                  |                                    |                                  |        |
| Ted Kluszewski, L (1, 3)<br>OBP: 0.355, SLG: 0.550    | 0-0 G3  |                                 |                              | 0-0 HR                          |                              | 0-3 K                           |                              |                                 | 0-0 4-3                      | 4 1 1 1 0 1 1                   |   |                                 |   |                                 |                              |                                  |                              |                                 |                                  |                                    |                                  |        |
| Joe Adcock, R (1, 7)<br>OBP: 0.320, SLG: 0.386        |   | 0-0 6-3                         |                              | 0-0 L5                          |                              |                                 | 0-0 F4                       |                                 | 0-0 1-3                      | 4 0 0 0 0 0 0                   |   |                                 |   |                                 |                              |                                  |                              |                                 |                                  |                                    |                                  |        |
| Johnny Pramesa, R (1, 2)<br>OBP: 0.368, SLG: 0.448    |   | 4-0 FC6-4 BB                    |                              | 0-0 1B                          |                              |                                 | 0-0 5-3                      |                                 | 0-0 6-3                      | 3 0 1 0 1 0 0                   |   |                                 |   |                                 |                              |                                  |                              |                                 |                                  |                                    |                                  |        |
| Connie Ryan, R (1, 4)<br>OBP: 0.357, SLG: 0.368       |   | 0-3 K                           |                              | 0-0 1-3                         |                              |                                 | 0-0 5-3                      |                                 |                              | 3 0 0 0 0 1 2                   |   |                                 |   |                                 |                              |                                  |                              |                                 |                                  |                                    |                                  |        |
| Virgil Stallcup, R (1, 6)<br>OBP: 0.288, SLG: 0.369   |   | 0-0 FC6-4                       |                              |                                 | 0-0 L7                       |                                 |                              | 0-0 5-3                         |                              | 3 0 0 0 0 0 1                   |   |                                 |   |                                 |                              |                                  |                              |                                 |                                  |                                    |                                  |        |
| Ewell Blackwell, R (1, 1)<br>OBP: 0.146, SLG: 0.115   |   |                                 | 0-3 K                        |                                 | 0-0 6-3                      |                                 |                              | 0-0 FC5 2B                      |                              | 3 0 1 0 0 1 0                   |   |                                 |   |                                 |                              |                                  |                              |                                 |                                  |                                    |                                  |        |
| <b>Inning Stats</b>                                   | R: 0<br>E: 1<br>K: 0<br>S: 4  | H: 0<br>LOB: 1<br>BB: 0<br>P: 4 | R: 0<br>E: 0<br>K: 1<br>S: 5 | H: 0<br>LOB: 1<br>BB: 1<br>P: 9 | R: 0<br>E: 0<br>K: 1<br>S: 5 | H: 0<br>LOB: 0<br>BB: 0<br>P: 5 | R: 1<br>E: 0<br>K: 0<br>S: 5 | H: 2<br>LOB: 1<br>BB: 0<br>P: 5 | R: 0<br>E: 0<br>K: 0<br>S: 3 | H: 0<br>LOB: 0<br>BB: 0<br>P: 3 | R: 0<br>E: 0<br>K: 1<br>S: 5  | H: 0<br>LOB: 0<br>BB: 0<br>P: 5 | R: 0<br>E: 0<br>K: 0<br>S: 3                          | H: 0<br>LOB: 0<br>BB: 0<br>P: 3 | R: 0<br>E: 0<br>K: 1<br>S: 6 | H: 1<br>LOB: 2<br>BB: 1<br>P: 10 | R: 0<br>E: 0<br>K: 0<br>S: 3 | H: 0<br>LOB: 0<br>BB: 0<br>P: 3 | 1B: 1<br>2B: 1<br>3B: 0<br>HR: 1 | SF: 0<br>SAC: 0<br>DP: 0<br>HBP: 0 | WP: 0<br>PB: 0<br>SB: 0<br>CS: 0 | PA: 33 |
| <b>PITCHER</b><br>Carl Erskine, R (1, 1)<br>ERA: 5.51 | IP 9.0<br>WLS W<br>BF 33<br>H 3<br>R 1<br>ER 1<br>SO 4<br>BB 2<br>IBB 0<br>HBP 0<br>BLK 0<br>WP 0<br>HR 1<br>S 39<br>P 47<br>ERA 1.00<br>WHIP 0.556 |                                 |                              |                                 |                              |                                 |                              |                                 |                              |                                 |   | <b>PITCHER</b>                  | IP WLS BF H R ER SO BB IBB HBP BLK WP HR S P ERA WHIP |                                 |                              |                                  |                              |                                 |                                  |                                    |                                  |        |

livebaseballscorecards.com

|            |    |
|------------|----|
| <b>AB</b>  | 31 |
| <b>R</b>   | 1  |
| <b>H</b>   | 3  |
| <b>RBI</b> | 1  |
| <b>BB</b>  | 2  |
| <b>SO</b>  | 4  |
| <b>LOB</b> | 7  |





| Batter  | 1          | 2          | 3          | 4                                 | 5          | 6          | 7         | 8                                    | 9 |
|---|------------|------------|------------|-----------------------------------|------------|------------|-----------|--------------------------------------|---|
| <b>Pee Wee Reese, R</b><br>OBP: 0.361, SLG: 0.371 (1, 6) X  | 0-0<br>5-3 |            |            | 4-0<br>1B PB<br>FC3-6 BB          |            | 0-3<br>K   |           | 0-0<br>FC4-2-5-2<br>4-3<br>1-3       |   |
| <b>Gene Hermanski, L</b><br>OBP: 0.359, SLG: 0.462 (1, 7) X | 0-0<br>4-3 |            |            | 0-0<br>1-3<br>FC3-6<br>1B         |            | 4-0<br>BB  |           | 0-0<br>4-3<br>2-3<br>3-H             |   |
| <b>Duke Snider, L</b><br>OBP: 0.375, SLG: 0.533 (1, 8) X    | 0-0<br>4-3 |            |            | 0-0<br>1-2f<br>3-H<br>FC3-6<br>CS |            | 0-0<br>F6  |           | 0-0<br>4-3                           |   |
| <b>Gil Hodges, R</b><br>OBP: 0.376, SLG: 0.500 (1, 3)       |            | 0-3<br>K   |            | 4-0<br>1-2<br>BB                  |            | 0-3<br>K   |           |                                      |   |
| <b>Carl Furillo, R</b><br>OBP: 0.350, SLG: 0.468 (1, 9) X   |            | 0-0<br>6-3 |            | 0-0<br>F9                         |            | 0-0<br>L3  |           |                                      |   |
| <b>Bobby Morgan, R</b><br>OBP: 0.340, SLG: 0.409 (1, 5)     |            | 0-3<br>K   |            |                                   | 0-0<br>F8  |            | 0-0<br>L7 |                                      |   |
| <b>Bruce Edwards, R</b><br>OBP: 0.228, SLG: 0.400 (1, 2) X  |            |            | 0-0<br>1-3 |                                   | 0-0<br>6-3 |            |           | 1-0<br>SH<br>WP<br>HBP               |   |
| <b>Billy Cox, R</b><br>OBP: 0.304, SLG: 0.363 (1, 4) X      |            |            | 0-0<br>5-3 |                                   | 0-0<br>4-3 |            |           | 0-0<br>SH<br>WP<br>4-3<br>1-3        |   |
| <b>Carl Erskine, R</b><br>OBP: 0.360, SLG: 0.348 (1, 1) S   |            |            | 0-3<br>K   |                                   |            | 0-0<br>6-3 |           | 4-0<br>FC4-2-5-2<br>2-3<br>3-H<br>BB |   |

| Inning Stats | R: 0 | H: 0 | E: 0 | LOB: 0 | K: 0 | BB: 0 | S: 3 | P: 3  |
|--------------|------|------|------|--------|------|-------|------|-------|
|              | R: 0 | H: 0 | E: 0 | LOB: 0 | K: 2 | BB: 0 | S: 7 | P: 7  |
|              | R: 0 | H: 0 | E: 0 | LOB: 0 | K: 1 | BB: 0 | S: 5 | P: 5  |
|              | R: 1 | H: 1 | E: 0 | LOB: 1 | K: 0 | BB: 2 | S: 3 | P: 11 |
|              | R: 0 | H: 0 | E: 0 | LOB: 0 | K: 0 | BB: 0 | S: 3 | P: 3  |
|              | R: 0 | H: 0 | E: 0 | LOB: 1 | K: 1 | BB: 1 | S: 5 | P: 9  |
|              | R: 0 | H: 0 | E: 0 | LOB: 0 | K: 1 | BB: 0 | S: 5 | P: 5  |
|              | R: 2 | H: 0 | E: 1 | LOB: 1 | K: 0 | BB: 1 | S: 4 | P: 9  |

| PITCHER                                       | IP  | WLS | BF | H | R | ER | SO | BB | IBB | HBP | BLK | WP | HR | S  | P  | ERA  | WHIP  |
|---|-----|-----|----|---|---|----|----|----|-----|-----|-----|----|----|----|----|------|-------|
| <b>Ewell Blackwell, R</b><br>ERA: 3.31 (1, 1) | 8.0 | L   | 30 | 1 | 3 | 0  | 5  | 4  | 0   | 1   | 0   | 1  | 0  | 35 | 52 | 0.00 | 0.625 |

**BOTTOM**

| AB | R | H | RBI | BB | SO | LOB |
|----|---|---|-----|----|----|-----|
| 3  | 1 | 0 | 0   | 1  | 1  | 2   |
| 3  | 0 | 1 | 1   | 1  | 0  | 1   |
| 4  | 0 | 0 | 1   | 0  | 0  | 3   |
| 2  | 0 | 0 | 0   | 1  | 2  | 0   |
| 3  | 0 | 0 | 0   | 0  | 0  | 1   |
| 3  | 0 | 0 | 0   | 0  | 1  | 0   |
| 2  | 1 | 0 | 0   | 0  | 0  | 0   |
| 2  | 1 | 0 | 0   | 0  | 0  | 0   |
| 2  | 0 | 0 | 0   | 1  | 1  | 0   |

|            |    |
|------------|----|
| <b>AB</b>  | 24 |
| <b>R</b>   | 3  |
| <b>H</b>   | 1  |
| <b>RBI</b> | 2  |
| <b>BB</b>  | 4  |
| <b>SO</b>  | 5  |
| <b>LOB</b> | 7  |

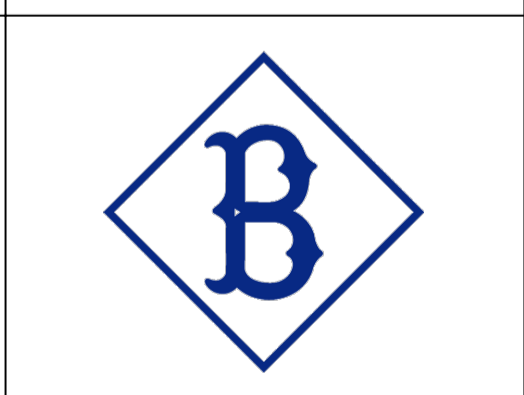

| WP | PA |
|----|----|
| 1  | 30 |

**Cincinnati Reds @ Brooklyn Dodgers**  
**Ebbets Field, Brooklyn, NY**  
 Tue Sep 12 1950, 3:33 AM EDT  
 Att. 3,323 - Unknown

[livebaseballscorecards.com](http://livebaseballscorecards.com)

| Batter  | 1   | 2   | 3   | 4   | 5   | 6   | 7   | 8   | 9  | AB R H RBI BB SO LOB                                       | TOP  |  |
|---|---|---|---|---|---|---|---|---|--|--|--|--|
| Lloyd Merriman, L (1, 8)<br>OBP: 0.324, SLG: 0.346    | 0-0<br>4-3 WP 4-3<br>1B                               |   | 0-0<br>4-3  |   | 0-0<br>F7   |   |   | 0-0<br>3-1  |  | 4 1 1 0 0 0 1  | <b>Cincinnati Reds @ Brooklyn Dodgers</b><br>Ebbets Field, Brooklyn, NY<br>Thu Sep 14 1950, 3:33 AM EDT<br>Unknown |  |
| Grady Hatton, L (1, 5)<br>OBP: 0.359, SLG: 0.382      | 0-0<br>4-3<br>1-2                                     |   | 4-0<br>BB   |   | 0-0<br>F7   |   |   | 0-0<br>3-1  |  | 3 0 0 0 1 0 1  |  |  |
| Johnny Wyrostek, L (1, 9)<br>OBP: 0.382, SLG: 0.455   | 0-0<br>4-3<br>2-3                                     |   | 0-0<br>G3   |   | 0-0<br>1-3  |   |   | 0-0<br>F7   |  | 4 0 0 0 0 0 2  |  |  |
| Ted Kluszewski, L (1, 3)<br>OBP: 0.354, SLG: 0.547    | 0-0<br>F3<br>3-H                                      |   |   | 0-0<br>F8   |   | 0-0<br>F3   |   |   | 0-0<br>FC5-4<br>1B                                   | 4 0 1 0 0 0 0  |  |  |
| Joe Adcock, R (1, 7)<br>OBP: 0.319, SLG: 0.395        |   | 0-0<br>HR   |   | 0-0<br>F7   |   |   | 0-0<br>5-3  |   | 0-0<br>FC5-4<br>BB<br>1-2f                           | 4 1 1 1 0 0 1  |  |  |
| Johnny Pramesa, R (1, 2)<br>OBP: 0.373, SLG: 0.451    |   | 0-0   |   | 0-0<br>L8   |   |   |   |   | 4-0<br>FC6-4<br>BB<br>1-2                            | 3 0 2 0 0 0 0<br>0 0 0 0 0 0 0<br>0 0 0 0 1 0 0            |  |  |
| Bobby Adams, R (7, PR)<br>OBP: 0.365, SLG: 0.423      |   | G6-4-3<br>1B  |   |   |   |   |   |   |  |  |  |  |
| Dixie Howell, R (7, 2)<br>OBP: 0.332, SLG: 0.301      |   |   |   |   |   |   |   |   |  |  |  |  |
| Connie Ryan, R (1, 4)<br>OBP: 0.354, SLG: 0.365       |   | 0-0<br>G6-4-3<br>1-2f                               |   | 0-0<br>5-3  |   | 0-0<br>F5   |   | 0-3<br>K  |  | 4 0 0 0 0 1 4  |  |  |
| Virgil Stallcup, R (1, 6)<br>OBP: 0.285, SLG: 0.366   |   | 0-3<br>K  |   | 0-0<br>6-3  |   | 0-0<br>F8   |   | 0-0<br>FC6-4<br>1-2f                                |  | 4 0 0 0 0 1 3  |  |  |
| Ken Raffensberger, R (1, 1)<br>OBP: 0.188, SLG: 0.211 |   |   | 0-0<br>1-3  |   | 0-0   |   |   | 0-0<br>HR   |  | 0 0 0 0 0 0 0  |  |  |
| Frank Smith, R (1, 1)<br>OBP: 0.105, SLG: 0.105       |   |   |   |   |   |   |   |   |  | 2 0 1 0 0 0 0  |  |  |
| Ted Tappe, L (8, PH)<br>OBP: 1.000, SLG: 4.000        |   |   |   |   |   |   |   |   |  | 1 1 1 1 0 0 0  |  |  |
| Bud Byerly, R (8, 1)                                  |   |   |   |   |   |   |   |   |  | 0 0 0 0 0 0 0  |  |  |
| <b>Inning Stats</b>                                   | R: 1 H: 1<br>E: 0 LOB: 0<br>K: 0 BB: 0<br>S: 4 P: 4   | R: 1 H: 2<br>E: 0 LOB: 0<br>K: 1 BB: 0<br>S: 6 P: 6 | R: 0 H: 0<br>E: 0 LOB: 1<br>K: 0 BB: 1<br>S: 3 P: 7 | R: 0 H: 0<br>E: 0 LOB: 0<br>K: 0 BB: 0<br>S: 3 P: 3 | R: 0 H: 1<br>E: 0 LOB: 1<br>K: 0 BB: 0<br>S: 4 P: 4 | R: 0 H: 0<br>E: 0 LOB: 0<br>K: 0 BB: 0<br>S: 3 P: 3 | R: 0 H: 1<br>E: 0 LOB: 1<br>K: 0 BB: 0<br>S: 4 P: 4 | R: 1 H: 1<br>E: 0 LOB: 0<br>K: 0 BB: 0<br>S: 4 P: 4 | R: 0 H: 1<br>E: 0 LOB: 2<br>K: 1 BB: 1<br>S: 6 P: 10 | 1B: 5 SF: 0<br>2B: 0 SAC: 0<br>3B: 0 DP: 1<br>HR: 2 HBP: 0 | WP: 1 PA: 35<br>PB: 0<br>SB: 0<br>CS: 0  |  |
| <b>PITCHER</b><br>Erv Palica, R (1, 1)<br>ERA: 4.04   | IP WLS BF H R ER SO BB IBB HBP BLK WP HR S P ERA WHIP | 9.0 W 35 7 3 3 2 2 0 0 0 0 1 2 37 45 3.00 1.000     |   |   |   |   |   |   |  |  |  |  |



| Batter   | 1            | 2             | 3      | 4       | 5            | 6         | 7      | 8       | 9 |
|--|--------------|---------------|--------|---------|--------------|-----------|--------|---------|---|
| <b>Pee Wee Reese, R</b><br>OBP: 0.360, SLG: 0.369 (1, 6) | 0-0 F9       | 4-0 G5-4-3 BB |        | 0-0 F7  |              | 0-0 F4    |        |         |   |
| <b>Tommy Brown, R</b><br>OBP: 0.321, SLG: 0.413 (1, 7)   | 4-0 2B BB    | 0-0 G5-4-3    |        |         | 0-0 F8       | 4-0 BB    |        |         |   |
| <b>Duke Snider, L</b><br>OBP: 0.374, SLG: 0.533 (1, 8)   | 0-0 HR 2B    |               | 0-0 F7 |         | 0-3 K        | 0-3 K     |        |         |   |
| <b>Gil Hodges, R</b><br>OBP: 0.379, SLG: 0.507 (1, 3)    | 0-0 HR       |               | 0-0 1B |         | 4-0 1B BB    |           | 0-0 F3 |         |   |
| <b>Carl Furillo, R</b><br>OBP: 0.351, SLG: 0.474 (1, 9)  | 0-0 HR       |               | 0-0 F7 |         | 0-0 FC5-4 1B |           | 0-0 F8 |         |   |
| <b>Bobby Morgan, R</b><br>OBP: 0.338, SLG: 0.406 (1, 5)  | 0-0 FC6-4 1B |               | 0-0 F7 |         | 0-0 FC5-4    |           | 0-3 K  |         |   |
| <b>Bruce Edwards, R</b><br>OBP: 0.228, SLG: 0.420 (1, 2) | 0-0 F7       |               |        | 0-0 5-3 |              | 0-0 HR    |        | 0-0 F7  |   |
| <b>Billy Cox, R</b><br>OBP: 0.303, SLG: 0.370 (1, 4)     | 0-0 FC6-4    |               |        | 0-0 HR  |              | 0-3 K     |        | 0-0 F9  |   |
| <b>Erv Palica, R</b><br>OBP: 0.226, SLG: 0.302 (1, 1)    |              | 0-0 5-3       |        | 0-0 5-3 |              | 0-0 BB 1B |        | 0-0 5-3 |   |

| Inning Stats | R: 4 | H: 4 | E: 0 | LOB: 1 | K: 0 | S: 7 | P: 11 | R: 0 | H: 0 | E: 0 | LOB: 0 | K: 0 | S: 2 | P: 6 | R: 0 | H: 1 | E: 0 | LOB: 1 | K: 0 | S: 4 | P: 4 | R: 1 | H: 1 | E: 0 | LOB: 0 | K: 0 | S: 4 | R: 0 | H: 1 | E: 0 | LOB: 2 | K: 1 | S: 6 | P: 10 | R: 1 | H: 2 | E: 0 | LOB: 2 | K: 2 | S: 9 | P: 13 | R: 0 | H: 0 | E: 0 | LOB: 0 | K: 1 | S: 5 | P: 5 | R: 0 | H: 0 | E: 0 | LOB: 0 | K: 0 | S: 3 | P: 3 |
|--------------|------|------|------|--------|------|------|-------|------|------|------|--------|------|------|------|------|------|------|--------|------|------|------|------|------|------|--------|------|------|------|------|------|--------|------|------|-------|------|------|------|--------|------|------|-------|------|------|------|--------|------|------|------|------|------|------|--------|------|------|------|
|--------------|------|------|------|--------|------|------|-------|------|------|------|--------|------|------|------|------|------|------|--------|------|------|------|------|------|------|--------|------|------|------|------|------|--------|------|------|-------|------|------|------|--------|------|------|-------|------|------|------|--------|------|------|------|------|------|------|--------|------|------|------|

| PITCHER   | IP  | WLS | BF | H | R | ER | SO | BB | IBB | HBP | BLK | WP | HR | S  | P  | ERA    | WHIP   |
|---|-----|-----|----|---|---|----|----|----|-----|-----|-----|----|----|----|----|--------|--------|
| <b>Ken Raffensberger, L</b><br>ERA: 4.26 (1, 1) | 0.1 | L   | 6  | 4 | 4 | 4  | 0  | 1  | 0   | 0   | 0   | 0  | 2  | 5  | 9  | 108.00 | 15.000 |
| <b>Frank Smith, R</b><br>ERA: 3.64 (1, 1)       | 6.2 |     | 27 | 5 | 2 | 2  | 4  | 3  | 0   | 0   | 0   | 0  | 2  | 32 | 44 | 2.70   | 1.200  |
| <b>Bud Byerly, R</b><br>ERA: (8, 1)             | 1.0 |     | 3  | 0 | 0 | 0  | 0  | 0  | 0   | 0   | 0   | 0  | 0  | 3  | 3  | 0.00   | 0.000  |

AB R H RBI BB SO LOB

|   |   |   |   |   |   |   |
|---|---|---|---|---|---|---|
| 3 | 0 | 0 | 0 | 1 | 0 | 1 |
| 2 | 1 | 0 | 0 | 2 | 0 | 1 |
| 4 | 1 | 1 | 1 | 0 | 2 | 2 |
| 3 | 1 | 2 | 2 | 1 | 0 | 0 |
| 4 | 1 | 2 | 1 | 0 | 0 | 1 |
| 4 | 0 | 1 | 0 | 0 | 1 | 3 |
| 4 | 1 | 1 | 1 | 0 | 0 | 1 |
| 4 | 1 | 1 | 1 | 0 | 1 | 1 |
| 4 | 0 | 1 | 0 | 0 | 0 | 0 |

|            |           |
|------------|-----------|
| <b>AB</b>  | <b>32</b> |
| <b>R</b>   | <b>6</b>  |
| <b>H</b>   | <b>9</b>  |
| <b>RBI</b> | <b>6</b>  |
| <b>BB</b>  | <b>4</b>  |
| <b>SO</b>  | <b>4</b>  |
| <b>LOB</b> | <b>10</b> |



| WP | HR | S | P | ERA | WHIP |
|----|----|---|---|-----|------|
| 0  | 0  | 0 | 0 | 0   | 0    |

WP: 0 PA: 36  
PB: 0  
SB: 0  
CS: 0

**Cincinnati Reds @ Brooklyn Dodgers**  
Ebbets Field, Brooklyn, NY  
Thu Sep 14 1950, 3:33 AM EDT  
Unknown

livebaseballscorecards.com

| Batter  | 1   | 2   | 3   | 4  | 5   | 6   | 7   | 8   | 9   | AB R H RBI BB SO LOB  | TOP                                     |
|---|---|---|---|--|---|---|---|---|---|---|---|
| <b>Bobby Adams, R</b> (1, 5)<br>OBP: 0.369, SLG: 0.424<br><b>Lloyd Merriman, L</b> (9, PH)<br>OBP: 0.323, SLG: 0.345  | 4-0<br>BB<br>G6-4-3                                   |   | 0-3<br>K  |  | 0-0<br>1B   |   |   | 4-0<br>BB<br>FC4-6                                  | 0-3<br>K  | 2 0 1 1 2 1 0<br>1 0 0 0 0 1 3  |   |
| <b>Bob Usher, R</b> (1, 8)<br>OBP: 0.310, SLG: 0.357  | 0-0<br>F7   |   | 0-0<br>F3   |  | 0-0<br>5-3  |   |   | 0-0<br>L8   |   | 4 0 0 0 0 0 3   |   |
| <b>Johnny Wyrostek, L</b> (1, 9)<br>OBP: 0.381, SLG: 0.453  | 0-0<br>G6-4-3<br>1-2f                                 |   |   |  |   |   |   | 0-0<br>F4   |   | 4 0 1 0 0 0 2   |   |
| <b>Ted Kluszewski, L</b> (1, 3)<br>OBP: 0.353, SLG: 0.544   |   | 0-0<br>F8   |   |  |   |   |   | 0-0<br>FC4-6<br>1-2f                                |   | 4 0 1 0 0 0 2   |   |
| <b>Joe Adcock, R</b> (1, 7)<br>OBP: 0.322, SLG: 0.406   |   | 0-0<br>HR   |   |  |   |   |   | 0-0<br>FC5-4<br>1-2f                                |   | 4 1 2 1 0 0 2   |   |
| <b>Connie Ryan, R</b> (1, 4)<br>OBP: 0.353, SLG: 0.364  |   | 0-0<br>F8   |   |  |   |   |   | 0-0<br>F8   |   | 4 0 1 0 0 0 2   |   |
| <b>Virgil Stallcup, R</b> (1, 6)<br>OBP: 0.287, SLG: 0.367  |   | 0-0<br>1B   |   |  |   |   |   | 0-0<br>F7   |   | 4 1 2 0 0 0 2   |   |
| <b>Dixie Howell, R</b> (1, 2)<br>OBP: 0.330, SLG: 0.296<br><b>Ted Tappe, L</b> (9, PR)<br>OBP: 1.000, SLG: 4.000  |   | 0-3<br>K  |   |  |   |   |   | 0-0<br>E5<br>1-2 2-3                                |   | 3 0 0 0 0 0 1 3<br>0 0 0 0 0 0 0 0  |   |
| <b>Eddie Erault, R</b> (1, 1)<br>OBP: 0.231, SLG: 0.250<br><b>Sammy Meeks, R</b> (3, PH)<br>OBP: 0.322, SLG: 0.376<br><b>Herm Wehmeier, R</b> (3, 1)<br>OBP: 0.172, SLG: 0.198<br><b>Danny Litwhiler, R</b> (9, PH)<br>OBP: 0.375, SLG: 0.470<br><b>Grady Hatton, L</b> (9, PH)<br>OBP: 0.358, SLG: 0.381 |   | 0-3<br>K  |   |  |   |   |   | 0-0<br>K  |   | 0 0 0 0 0 0 0 0<br>1 0 0 0 0 0 1 0<br>2 0 0 0 0 0 0 2<br>0 0 0 0 0 0 0 0<br>1 0 0 0 0 0 1 3 |   |
| <b>Inning Stats</b>   | R: 0 H: 0<br>E: 0 LOB: 0<br>K: 0 BB: 1<br>S: 2 P: 6   | R: 1 H: 2<br>E: 0 LOB: 1<br>K: 1 BB: 0<br>S: 7 P: 7 | R: 0 H: 0<br>E: 0 LOB: 0<br>K: 2 BB: 0<br>S: 7 P: 7 | R: 0 H: 1<br>E: 0 LOB: 1<br>K: 0 BB: 0<br>S: 4 P: 4                  | R: 1 H: 2<br>E: 0 LOB: 1<br>K: 0 BB: 0<br>S: 4 P: 5 | R: 0 H: 1<br>E: 0 LOB: 1<br>K: 0 BB: 0<br>S: 4 P: 4 | R: 0 H: 0<br>E: 0 LOB: 0<br>K: 0 BB: 0<br>S: 3 P: 3 | R: 0 H: 0<br>E: 0 LOB: 1<br>K: 0 BB: 1<br>S: 3 P: 7 | R: 0 H: 2<br>E: 1 LOB: 3<br>K: 2 BB: 0<br>S: 10 P: 10 | 1B: 7 SF: 0<br>2B: 0 SAC: 0<br>3B: 0 DP: 2<br>HR: 1 HBP: 1                                  | WP: 0 PA: 37<br>PB: 0<br>SB: 0<br>CS: 0 |
| <b>PITCHER</b><br><b>Preacher Roe, L</b> (1, 1)<br>ERA: 3.16<br><b>Ralph Branca, R</b> (9, 1)<br>ERA: 4.42  | IP WLS BF H R ER SO BB IBB HBP BLK WP HR S P ERA WHIP | 8.1 W 35 8 2 2 3 2 0 1 0 0 1 38 47 2.16 1.200       | 0.2 S 2 0 0 0 2 0 0 0 0 0 0 6 6 0.00 0.000          | <b>PITCHER</b> IP WLS BF H R ER SO BB IBB HBP BLK WP HR S P ERA WHIP |   |   |   |   |   |   |   |

**Cincinnati Reds @ Brooklyn Dodgers**  
 Ebbets Field, Brooklyn, NY  
 Thu Sep 14 1950, 3:38 AM EDT  
 Att. 3,431 - Unknown

[livebaseballscorecards.com](http://livebaseballscorecards.com)

|            |    |
|------------|----|
| <b>AB</b>  | 34 |
| <b>R</b>   | 2  |
| <b>H</b>   | 8  |
| <b>RBI</b> | 2  |
| <b>BB</b>  | 2  |
| <b>SO</b>  | 5  |
| <b>LOB</b> | 24 |



| Batter   | 1                     | 2                  | 3        | 4                   | 5            | 6         | 7          | 8                   | 9 |
|--|-----------------------|--------------------|----------|---------------------|--------------|-----------|------------|---------------------|---|
| <b>Pee Wee Reese, R</b><br>OBP: 0.363, SLG: 0.371<br>(1, 6)  | 4-0<br>1B BB<br>BB    | 0-0<br>3-1<br>1B   |          | 4-3                 |              | 0-0<br>1B |            |                     |   |
| <b>Gene Hermanski, L</b><br>OBP: 0.361, SLG: 0.458<br>(1, 7)   | 4-0<br>1B BB<br>BB    | 0-0<br>3-1         |          | 1-0<br>HBP          |              | 0-0<br>G3 |            |                     |   |
| <b>Duke Snider, L</b><br>OBP: 0.373, SLG: 0.531<br>(1, 8)  | 0-3<br>K              | 0-0<br>FC6-4<br>1B |          | 0-0<br>4-3          |              | 0-0<br>F4 |            |                     |   |
| <b>Gil Hodges, R</b><br>OBP: 0.380, SLG: 0.509<br>(1, 3)   | 0-0<br>1B             | 0-0<br>FC6-4       |          | 0-0<br>4-3          |              | 0-0<br>2B |            |                     |   |
| <b>Carl Furillo, R</b><br>OBP: 0.351, SLG: 0.474<br>(1, 9)   | 0-0<br>G6-4-3<br>1-2f |                    | 0-3<br>K |                     | 0-0<br>1B 2B |           | 0-0<br>5-3 |                     |   |
| <b>Bobby Morgan, R</b><br>OBP: 0.346, SLG: 0.424<br>(1, 5)   |                       | 0-0<br>2B 2B       |          | 0-0<br>2B           |              | 0-0<br>1B |            | 0-3<br>K            |   |
| <b>Bruce Edwards, R</b><br>OBP: 0.244, SLG: 0.434<br>(1, 2)  |                       | 0-0<br>G3 1B 2B    |          | 4-0<br>G6-4-3<br>BB |              | 0-0<br>F9 |            | 0-0<br>CS 6-3<br>1B |   |
| <b>Billy Cox, R</b><br>OBP: 0.300, SLG: 0.366<br>(1, 4)  |                       | 0-0<br>G3          |          | 0-0<br>G6-4-3       |              | 0-0<br>F7 |            | 0-0<br>6-3          |   |
| <b>Preacher Roe, R</b><br>OBP: 0.155, SLG: 0.157<br><b>Ralph Branca, R</b><br>OBP: 0.212, SLG: 0.310<br>(9, 1) |                       | 0-0<br>3-1 1B 1B   |          | 0-3<br>K            |              | 0-0<br>F6 |            | 0-3<br>K            |   |

| Inning Stats | R: 0 | H: 1 | E: 0 | K: 1 | S: 5 | LOB: 2 | BB: 2 | P: 13 |
|--------------|------|------|------|------|------|--------|-------|-------|
|              | R: 4 | H: 5 | E: 0 | K: 0 | S: 8 | LOB: 1 | BB: 0 | P: 8  |
|              | R: 0 | H: 1 | E: 0 | K: 1 | S: 5 | LOB: 1 | BB: 1 | P: 9  |
|              | R: 0 | H: 0 | E: 0 | K: 1 | S: 5 | LOB: 1 | BB: 0 | P: 6  |
|              | R: 1 | H: 2 | E: 0 | K: 0 | S: 4 | LOB: 0 | BB: 0 | P: 4  |
|              | R: 0 | H: 1 | E: 0 | K: 0 | S: 4 | LOB: 1 | BB: 0 | P: 4  |
|              | R: 0 | H: 1 | E: 0 | K: 1 | S: 6 | LOB: 1 | BB: 0 | P: 6  |
|              | R: 0 | H: 1 | E: 0 | K: 1 | S: 5 | LOB: 0 | BB: 0 | P: 5  |

| PITCHER  | IP  | WLS | BF | H | R | ER | SO | BB | IBB | HBP | BLK | WP | HR | S  | P  | ERA   | WHIP  |
|--|-----|-----|----|---|---|----|----|----|-----|-----|-----|----|----|----|----|-------|-------|
| <b>Eddie Erault, R</b><br>ERA: 6.15<br>(1, 1)  | 2.0 | L   | 13 | 6 | 4 | 4  | 1  | 2  | 0   | 0   | 0   | 0  | 0  | 13 | 21 | 18.00 | 4.000 |
| <b>Herm Wehmeier, R</b><br>ERA: 5.55<br>(3, 1) | 6.0 |     | 23 | 6 | 1 | 1  | 4  | 1  | 0   | 1   | 0   | 0  | 0  | 29 | 34 | 1.50  | 1.167 |

AB R H RBI BB SO LOB

|   |   |   |   |   |   |   |
|---|---|---|---|---|---|---|
| 3 | 1 | 2 | 0 | 1 | 0 | 0 |
| 2 | 0 | 0 | 0 | 1 | 0 | 3 |
| 4 | 0 | 1 | 2 | 0 | 1 | 3 |
| 4 | 0 | 2 | 0 | 0 | 0 | 1 |
| 4 | 1 | 1 | 0 | 0 | 1 | 4 |
| 4 | 1 | 3 | 1 | 0 | 1 | 1 |
| 3 | 1 | 2 | 1 | 1 | 0 | 0 |
| 4 | 0 | 0 | 0 | 0 | 0 | 4 |
| 4 | 1 | 1 | 1 | 0 | 2 | 1 |
| 0 | 0 | 0 | 0 | 0 | 0 | 0 |

| AB  | 32 |
|-----|----|
| R   | 5  |
| H   | 12 |
| RBI | 5  |
| BB  | 3  |
| SO  | 5  |
| LOB | 17 |



**Cincinnati Reds @ Brooklyn Dodgers**  
Ebbets Field, Brooklyn, NY  
Thu Sep 14 1950, 3:38 AM EDT  
Att. 3,431 - Unknown

livebaseballscorecards.com

| AB  | 32 |
|-----|----|
| R   | 5  |
| H   | 12 |
| RBI | 5  |
| BB  | 3  |
| SO  | 5  |
| LOB | 17 |

| WP | 0  |
|----|----|
| PA | 36 |
| PB | 0  |
| SB | 0  |
| CS | 1  |

| Batter   | 1                            | 2                                | 3                            | 4                               | 5                            | 6                               | 7                            | 8                               | 9                            | AB                              | R                            | H                               | RBI                          | BB                              | SO                           | LOB                             | TOP  |                                 |                                  |                                    |                                  |        |  |  |  |  |  |
|--|------------------------------|----------------------------------|------------------------------|---------------------------------|------------------------------|---------------------------------|------------------------------|---------------------------------|------------------------------|---------------------------------|------------------------------|---------------------------------|------------------------------|---------------------------------|------------------------------|---------------------------------|--|---------------------------------|----------------------------------|------------------------------------|----------------------------------|--------|--|--|--|--|--|
| Bobby Adams, R (1, 4)<br>OBP: 0.364, SLG: 0.416      | 0-0<br>5-3                   |                                  | 0-0<br>5-3                   |                                 | 0-0<br>F8                    |                                 | 0-0<br>6-3                   |                                 | 0-0<br>F4                    | 5                               | 0                            | 0                               | 0                            | 0                               | 0                            | 1                               | <b>Cincinnati Reds @ Philadelphia Phillies</b><br>Shibe Park, Philadelphia, PA<br>Fri Sep 15 1950, 3:33 AM EDT<br>Sunny - 75 F |                                 |                                  |                                    |                                  |        |  |  |  |  |  |
| Grady Hatton, L (1, 5)<br>OBP: 0.359, SLG: 0.383     | 4-0<br>BB<br>BB              |                                  | 0-0<br>F5                    |                                 | 0-0<br>2B                    |                                 | 0-0<br>F5                    |                                 |                              | 3                               | 0                            | 1                               | 0                            | 1                               | 0                            | 0                               |  |                                 |                                  |                                    |                                  |        |  |  |  |  |  |
| Johnny Wyrostek, L (1, 9)<br>OBP: 0.382, SLG: 0.451  | 4-0<br>1-2<br>FC6-4<br>BB    |                                  | 4-0<br>1B<br>BB              |                                 | 0-0<br>F8                    |                                 | 0-0<br>F6                    |                                 |                              | 2                               | 0                            | 0                               | 0                            | 2                               | 0                            | 1                               |  |                                 |                                  |                                    |                                  |        |  |  |  |  |  |
| Ted Kluszewski, L (1, 3)<br>OBP: 0.354, SLG: 0.544   | 0-0<br>F7                    |                                  | 0-0<br>1B                    |                                 | 0-0<br>FC1-6<br>1B           |                                 | 0-0<br>F8                    |                                 |                              | 4                               | 0                            | 2                               | 0                            | 0                               | 0                            | 2                               |  |                                 |                                  |                                    |                                  |        |  |  |  |  |  |
| Joe Adcock, R (1, 7)<br>OBP: 0.318, SLG: 0.401       | 0-0<br>FC6-4<br>1-2f         |                                  | 0-0<br>F8                    |                                 | 0-0<br>FC1-6<br>FC6<br>1-2f  |                                 | 0-0<br>F4                    |                                 |                              | 4                               | 0                            | 0                               | 0                            | 0                               | 0                            | 5                               |  |                                 |                                  |                                    |                                  |        |  |  |  |  |  |
| Lloyd Merriman, L (1, 8)<br>OBP: 0.323, SLG: 0.345   |                              | 0-0<br>L1-6<br>1B                |                              | 0-0<br>F9                       |                              | 0-0<br>FC6<br>1B<br>2B<br>1-2f  |                              | 0-3<br>K                        |                              | 3                               | 1                            | 1                               | 0                            | 0                               | 0                            | 1                               |  |                                 |                                  |                                    |                                  |        |  |  |  |  |  |
| Bob Usher, R (8, PH)<br>OBP: 0.309, SLG: 0.355       |                              |                                  |                              |                                 |                              |                                 |                              |                                 |                              | 1                               | 0                            | 0                               | 0                            | 0                               | 1                            | 0                               |  |                                 |                                  |                                    |                                  |        |  |  |  |  |  |
| Johnny Pramesa, R (1, 2)<br>OBP: 0.380, SLG: 0.457   |                              | 0-0<br>1-2<br>1B                 |                              | 0-0<br>L5-3<br>1B               |                              | 0-0<br>2B<br>1B<br>1-2          |                              | 0-0<br>F7                       |                              | 4                               | 0                            | 3                               | 0                            | 0                               | 0                            | 0                               |  |                                 |                                  |                                    |                                  |        |  |  |  |  |  |
| Virgil Stallcup, R (1, 6)<br>OBP: 0.287, SLG: 0.368  |                              | 0-0<br>F8                        |                              | 0-0<br>L5-3<br>1-2              |                              | 0-0<br>2B                       |                              | 0-0<br>F2                       |                              | 4                               | 0                            | 1                               | 1                            | 0                               | 0                            | 3                               |  |                                 |                                  |                                    |                                  |        |  |  |  |  |  |
| Willie Ramsdell, R (1, 1)<br>OBP: 0.259, SLG: 0.200  |                              | 0-0<br>L1-6<br>2-3               |                              | 0-0<br>4-3                      |                              | 0-0<br>F9                       |                              | 0-0<br>1B                       |                              | 3                               | 0                            | 0                               | 0                            | 0                               | 0                            | 4                               |  |                                 |                                  |                                    |                                  |        |  |  |  |  |  |
| Danny Litwhiler, R (9, PH)<br>OBP: 0.380, SLG: 0.475 |                              |                                  |                              |                                 |                              |                                 |                              |                                 |                              | 1                               | 0                            | 1                               | 0                            | 0                               | 0                            | 0                               |  |                                 |                                  |                                    |                                  |        |  |  |  |  |  |
| Herm Wehmeier, R (9, PR)<br>OBP: 0.172, SLG: 0.198   |                              |                                  |                              |                                 |                              |                                 |                              |                                 |                              | 0                               | 0                            | 0                               | 0                            | 0                               | 0                            | 0                               |  |                                 |                                  |                                    |                                  |        |  |  |  |  |  |
| <b>Inning Stats</b>                                  | R: 0<br>E: 0<br>K: 0<br>S: 3 | H: 0<br>LOB: 2<br>BB: 2<br>P: 11 | R: 0<br>E: 0<br>K: 0<br>S: 4 | H: 2<br>LOB: 1<br>BB: 0<br>P: 4 | R: 0<br>E: 0<br>K: 0<br>S: 4 | H: 1<br>LOB: 2<br>BB: 1<br>P: 8 | R: 0<br>E: 0<br>K: 0<br>S: 3 | H: 1<br>LOB: 0<br>BB: 0<br>P: 3 | R: 0<br>E: 0<br>K: 0<br>S: 4 | H: 1<br>LOB: 1<br>BB: 0<br>P: 4 | R: 1<br>E: 0<br>K: 0<br>S: 6 | H: 3<br>LOB: 2<br>BB: 0<br>P: 6 | R: 0<br>E: 0<br>K: 0<br>S: 3 | H: 0<br>LOB: 0<br>BB: 0<br>P: 3 | R: 0<br>E: 0<br>K: 1<br>S: 5 | H: 0<br>LOB: 0<br>BB: 0<br>P: 5 | R: 0<br>E: 0<br>K: 0<br>S: 4   | H: 1<br>LOB: 1<br>BB: 0<br>P: 4 | 1B: 7<br>2B: 4<br>3B: 0<br>HR: 0 | SF: 0<br>SAC: 0<br>DP: 2<br>HBP: 0 | WP: 0<br>PB: 0<br>SB: 0<br>CS: 0 | PA: 37 |  |  |  |  |  |
| PITCHER  | IP                           | WLS                              | BF                           | H                               | R                            | ER                              | SO                           | BB                              | IBB                          | HBP                             | BLK                          | WP                              | HR                           | S                               | P                            | ERA                             | WHIP   |                                 |                                  |                                    |                                  |        |  |  |  |  |  |
| Bubba Church, R (1, 1)<br>ERA: 2.18                  | 2.2                          |                                  | 13                           | 3                               | 0                            | 0                               | 0                            | 3                               | 0                            | 0                               | 0                            | 0                               | 0                            | 10                              | 22                           | 0.00                            | 2.250  |                                 |                                  |                                    |                                  |        |  |  |  |  |  |
| Ken Heintzelman, L (3, 1)<br>ERA: 4.16               | 6.1                          | W                                | 24                           | 6                               | 1                            | 1                               | 1                            | 0                               | 0                            | 0                               | 0                            | 0                               | 0                            | 26                              | 26                           | 1.42                            | 0.947  |                                 |                                  |                                    |                                  |        |  |  |  |  |  |

livebaseballscorecards.com

**AB** 34  
**R** 1  
**H** 9  
**RBI** 1  
**BB** 3  
**SO** 1  
**LOB** 17



| Batter  | 1                 | 2                         | 3                    | 4          | 5          | 6         | 7         | 8          | 9 |
|---|-------------------|---------------------------|----------------------|------------|------------|-----------|-----------|------------|---|
| <b>Eddie Waitkus, L</b><br>OBP: 0.342, SLG: 0.360<br>(1, 3) X   | 0-0<br>5-3<br>1B  |                           | 0-0<br>3-1           |            | 0-0<br>L5  |           |           | 0-0<br>1-3 |   |
| <b>Richie Ashburn, L</b><br>OBP: 0.383, SLG: 0.423<br>(1, 8) X  | 0-0<br>F9         |                           | 4-0<br>FC5-4<br>BB   |            | 0-0<br>F5  |           |           | 0-0<br>F8  |   |
| <b>Willie Jones, R</b><br>OBP: 0.351, SLG: 0.481<br>(1, 5) X  | 0-0<br>5-3<br>1-2 |                           | 0-0<br>F7            |            | 0-0<br>F8  |           |           | 4-0<br>BB  |   |
| <b>Del Ennis, R</b><br>OBP: 0.366, SLG: 0.560<br>(1, 9) X   | 4-0<br>IBB        |                           | 0-0<br>FC5-4<br>1-2f |            | 0-0<br>1-3 |           |           | 0-3<br>K   |   |
| <b>Jackie Mayo, L</b><br>OBP: 0.278, SLG: 0.294<br>(1, 7) X   | 0-0<br>F6         |                           |                      | 0-3<br>K   |            | 0-0<br>F5 |           |            |   |
| <b>Granny Hamner, R</b><br>OBP: 0.325, SLG: 0.394<br>(1, 6) X   |                   | 0-0<br>1B<br>F8-6<br>1B   |                      | 0-0<br>4-3 |            | 0-0<br>F7 |           |            |   |
| <b>Andy Seminick, R</b><br>OBP: 0.394, SLG: 0.540<br>(1, 2) X   |                   | 0-0<br>F8-6<br>1-3<br>1B  |                      | 0-0<br>HR  |            | 0-3<br>K  |           |            |   |
| <b>Mike Goliat, R</b><br>OBP: 0.318, SLG: 0.362<br>(1, 4) X   |                   | 0-0<br>F8-6<br>1-2<br>3-H |                      | 0-0<br>6-3 |            | 0-0<br>1B |           |            |   |
| <b>Bubba Church, R</b><br>OBP: 0.205, SLG: 0.233<br><b>Ken Heintzelman, R</b><br>OBP: 0.061, SLG: 0.031<br>(1, 1) X<br>(3, 1) X |                   | 0-0<br>F6                 |                      |            | 0-0<br>F9  |           | 0-0<br>F3 |            |   |

| AB | R | H | RBI | BB | SO | LOB |
|----|---|---|-----|----|----|-----|
| 4  | 0 | 1 | 0   | 0  | 0  | 0   |
| 3  | 0 | 0 | 0   | 1  | 0  | 1   |
| 3  | 0 | 0 | 0   | 1  | 0  | 2   |
| 3  | 0 | 0 | 0   | 1  | 1  | 2   |
| 3  | 0 | 0 | 0   | 0  | 1  | 2   |
| 3  | 1 | 1 | 0   | 0  | 0  | 0   |
| 3  | 1 | 2 | 1   | 0  | 1  | 0   |
| 3  | 0 | 1 | 1   | 0  | 0  | 1   |
| 1  | 0 | 0 | 0   | 0  | 0  | 0   |
| 2  | 0 | 0 | 0   | 0  | 0  | 1   |

**BOTTOM**

**Cincinnati Reds @ Philadelphia Phillies**  
Shibe Park, Philadelphia, PA  
Fri Sep 15 1950, 3:33 AM EDT  
Sunny - 75 F

livebaseballscorecards.com

|            |           |
|------------|-----------|
| <b>AB</b>  | <b>28</b> |
| <b>R</b>   | <b>2</b>  |
| <b>H</b>   | <b>5</b>  |
| <b>RBI</b> | <b>2</b>  |
| <b>BB</b>  | <b>3</b>  |
| <b>SO</b>  | <b>3</b>  |
| <b>LOB</b> | <b>9</b>  |



| Inning Stats   | R: 0 | H: 1 | E: 0 | K: 0 | S: 4 | P: 8 | R: 1 | H: 2 | E: 0 | K: 0 | S: 4 | R: 0 | H: 0 | E: 0 | K: 0 | S: 3 | R: 1  | H: 1 | E: 0 | K: 1 | S: 6 | R: 0 | H: 0 | E: 0 | K: 0 | S: 3 | R: 0 | H: 0 | E: 0 | K: 1 | S: 6 | R: 0 | H: 1 | E: 0 | K: 1 | S: 6 | R: 0 | H: 0 | E: 0 | K: 1 | S: 5 |  |
|--|------|------|------|------|------|------|------|------|------|------|------|------|------|------|------|------|-------|------|------|------|------|------|------|------|------|------|------|------|------|------|------|------|------|------|------|------|------|------|------|------|------|--|
| <b>PITCHER</b><br><b>Willie Ramsdell, R</b><br>ERA: 3.73<br>(1, 1) | IP   | WLS  | BF   | H    | R    | ER   | SO   | BB   | IBB  | HBP  | BLK  | WP   | HR   | S    | P    | ERA  | WHIP  |      |      |      |      |      |      |      |      |      |      |      |      |      |      |      |      |      |      |      |      |      |      |      |      |  |
|  | 8.0  | L    | 31   | 5    | 2    | 2    | 3    | 2    | 1    | 0    | 0    | 0    | 1    | 34   | 46   | 2.25 | 0.875 |      |      |      |      |      |      |      |      |      |      |      |      |      |      |      |      |      |      |      |      |      |      |      |      |  |
|  |      |      |      |      |      |      |      |      |      |      |      |      |      |      |      |      |       |      |      |      |      |      |      |      |      |      |      |      |      |      |      |      |      |      |      |      |      |      |      |      |      |  |

| WP | PA | ERA | WHIP |
|----|----|-----|------|
| 0  | 31 |     |      |
| 0  |    |     |      |
| 0  |    |     |      |

| Batter  | 1   | 2                               | 3                            | 4                               | 5                             | 6                                | 7                            | 8                               | 9                            | 10                              | 11                           | 12                              | 13                           | 14                              | 15                           | 16                              | 17                           | 18                              | 19                           | AB                              | R                            | H                               | RBI                          | BB                               | SO                           | LOB                             | TOP                      |                                    |                                  |        |  |  |  |  |  |  |  |
|---|---|---------------------------------|------------------------------|---------------------------------|-------------------------------|----------------------------------|------------------------------|---------------------------------|------------------------------|---------------------------------|------------------------------|---------------------------------|------------------------------|---------------------------------|------------------------------|---------------------------------|------------------------------|---------------------------------|------------------------------|---------------------------------|------------------------------|---------------------------------|------------------------------|----------------------------------|------------------------------|---------------------------------|--------------------------|------------------------------------|----------------------------------|--------|--|--|--|--|--|--|--|
| Lloyd Merriman, L (1, 8)<br>OBP: 0.327, SLG: 0.346  | 4-3   |                                 | 1B                           | 1B                              |                               | 4-3                              |                              |                                 | F9 1B                        |                                 | F8                           |                                 |                              | 4-3                             |                              | F7                              |                              | BB S                            |                              | 8                               | 2                            | 3                               | 1                            | 1                                | 0                            | 0                               |                          |                                    |                                  |        |  |  |  |  |  |  |  |
| Grady Hatton, L (1, 5)<br>OBP: 0.383, SLG: 0.384  | E6  |                                 | K                            | F7                              |                               | S                                |                              |                                 | 1B                           |                                 | F9                           |                                 |                              | BB                              |                              | 6-3                             |                              | BB                              |                              | 7                               | 1                            | 3                               | 0                            | 2                                | 1                            | 3                               |                          |                                    |                                  |        |  |  |  |  |  |  |  |
| Johnny Wyrostek, L (1, 9)<br>OBP: 0.277, SLG: 0.443   | FC4   |                                 | E3                           | 6-3                             |                               |                                  |                              |                                 | F8                           |                                 |                              |                                 |                              | 6-3                             |                              | 6-3                             |                              | BB                              |                              | 8                               | 1                            | 0                               | 0                            | 1                                | 0                            | 8                               |                          |                                    |                                  |        |  |  |  |  |  |  |  |
| Ted Kluszewski, L (1, 3)<br>OBP: 0.358, SLG: 0.541  | F6  |                                 | 1B                           |                                 |                               |                                  |                              |                                 | F9                           |                                 |                              |                                 |                              |                                 |                              |                                 |                              |                                 |                              | 6                               | 1                            | 2                               | 2                            | 3                                | 0                            | 4                               |                          |                                    |                                  |        |  |  |  |  |  |  |  |
| Joe Adcock, R (1, 7)<br>Bob Usher, R (18, 7)<br>OBP: 0.309, SLG: 0.355  | L6  |                                 | 1B                           |                                 |                               | FC5-6                            |                              |                                 | B1-3                         |                                 |                              |                                 |                              | F6                              |                              | 4-3                             |                              | G6-3                            |                              | 9                               | 0                            | 3                               | 2                            | 0                                | 0                            | 10                              |                          |                                    |                                  |        |  |  |  |  |  |  |  |
| Connie Ryan, R (1, 4)<br>OBP: 0.349, SLG: 0.361   |   | K                               | K                            |                                 |                               | FC5-6                            |                              |                                 | G6-4-3                       |                                 |                              |                                 |                              | F3                              |                              | 6-3                             |                              | 6-3                             |                              | 9                               | 0                            | 1                               | 0                            | 0                                | 2                            | 5                               |                          |                                    |                                  |        |  |  |  |  |  |  |  |
| Virgil Stallcup, R (1, 6)<br>OBP: 0.283, SLG: 0.363   |   | L1                              | F7                           |                                 |                               | F8                               |                              |                                 | 6-3                          |                                 |                              |                                 |                              | F5                              |                              |                                 |                              | 6-3                             |                              | 9                               | 0                            | 1                               | 1                            | 0                                | 0                            | 4                               |                          |                                    |                                  |        |  |  |  |  |  |  |  |
| Dixie Howell, R (1, 2)<br>OBP: 0.326, SLG: 0.298  |   | F7                              |                              |                                 |                               | F7                               |                              |                                 | K                            |                                 |                              |                                 |                              | K                               |                              |                                 |                              | F7                              |                              | 9                               | 1                            | 2                               | 0                            | 0                                | 2                            | 3                               |                          |                                    |                                  |        |  |  |  |  |  |  |  |
| Howie Fox, R (1, 1)<br>Ken Raffensberger, R (8, 1)<br>Herm Wehmeier, R (9, 1)<br>Ted Tappe, L (19, PH)<br>Eddie Erault, R (19, 1)<br>OBP: 0.231, SLG: 0.250 |   |                                 | E6                           | L4                              |                               | 6-3                              |                              |                                 | G3                           |                                 |                              |                                 |                              | FC6-4                           |                              | K                               |                              | K                               |                              | 4                               | 1                            | 0                               | 0                            | 0                                | 0                            | 1                               |                          |                                    |                                  |        |  |  |  |  |  |  |  |
| <b>Inning Stats</b>   | R: 0<br>E: 2<br>K: 0<br>S: 5  | H: 0<br>LOB: 2<br>BB: 0<br>P: 5 | R: 0<br>E: 0<br>K: 1<br>S: 5 | H: 0<br>LOB: 0<br>BB: 0<br>P: 5 | R: 3<br>E: 2<br>K: 2<br>S: 11 | H: 2<br>LOB: 2<br>BB: 1<br>P: 15 | R: 1<br>E: 0<br>K: 0<br>S: 5 | H: 2<br>LOB: 1<br>BB: 0<br>P: 5 | R: 1<br>E: 0<br>K: 1<br>S: 5 | H: 2<br>LOB: 1<br>BB: 0<br>P: 4 | R: 0<br>E: 0<br>K: 0<br>S: 4 | H: 1<br>LOB: 1<br>BB: 0<br>P: 4 | R: 0<br>E: 0<br>K: 1<br>S: 5 | H: 0<br>LOB: 0<br>BB: 0<br>P: 5 | R: 0<br>E: 0<br>K: 0<br>S: 3 | H: 0<br>LOB: 0<br>BB: 0<br>P: 3 | R: 0<br>E: 0<br>K: 0<br>S: 6 | H: 1<br>LOB: 1<br>BB: 0<br>P: 6 | R: 0<br>E: 0<br>K: 0<br>S: 4 | H: 1<br>LOB: 1<br>BB: 0<br>P: 8 | R: 0<br>E: 0<br>K: 1<br>S: 5 | H: 0<br>LOB: 0<br>BB: 0<br>P: 3 | R: 2<br>E: 0<br>K: 1<br>S: 5 | H: 1<br>LOB: 1<br>BB: 3<br>P: 17 | R: 0<br>E: 0<br>K: 0<br>S: 4 | H: 1<br>LOB: 1<br>BB: 0<br>P: 4 | 1B: 13<br>2B: 2<br>HR: 0 | SF: 0<br>SAC: 0<br>DP: 2<br>HBP: 0 | WP: 0<br>PB: 0<br>SB: 2<br>CS: 0 | PA: 81 |  |  |  |  |  |  |  |
| <b>PITCHER</b>  | IP<br>WLS<br>BF<br>H<br>R<br>ER<br>SO<br>BB<br>IBB<br>HBP<br>BLK<br>WP<br>HR<br>S<br>P<br>ERA<br>WHIP |                                 |                              |                                 |                               |                                  |                              |                                 |                              |                                 |                              |                                 |                              |                                 |                              |                                 |                              |                                 |                              |                                 |                              |                                 |                              |                                  |                              |                                 |                          |                                    |                                  |        |  |  |  |  |  |  |  |
| Robin Roberts, R (1, 1)<br>ERA: 2.98  | 7.0   |                                 |                              |                                 |                               |                                  |                              |                                 |                              |                                 |                              |                                 |                              |                                 |                              |                                 |                              |                                 |                              |                                 |                              |                                 |                              |                                  |                              |                                 |                          |                                    |                                  |        |  |  |  |  |  |  |  |
| Jack Brittin, R (8, 1)<br>ERA:  | 1.0   |                                 |                              |                                 |                               |                                  |                              |                                 |                              |                                 |                              |                                 |                              |                                 |                              |                                 |                              |                                 |                              |                                 |                              |                                 |                              |                                  |                              |                                 |                          |                                    |                                  |        |  |  |  |  |  |  |  |
| Jim Konstanty, R (9, 1)<br>ERA: 2.21  | 10.0  |                                 |                              |                                 |                               |                                  |                              |                                 |                              |                                 |                              |                                 |                              |                                 |                              |                                 |                              |                                 |                              |                                 |                              |                                 |                              |                                  |                              |                                 |                          |                                    |                                  |        |  |  |  |  |  |  |  |
| Blix Donnelly, R (19, 1)<br>ERA: 5.68   | 1.0   | W                               | 4                            | 1                               | 0                             | 0                                | 0                            | 0                               | 0                            | 0                               | 0                            | 0                               | 0                            | 0                               | 0                            | 0                               | 0                            | 0                               | 0                            | 0                               | 0                            | 0                               | 0                            | 0                                | 0                            | 0                               | 0                        |                                    |                                  |        |  |  |  |  |  |  |  |

Cincinnati Reds @ Philadelphia Phillies  
Shibe Park, Philadelphia, PA  
Fri Sep 15 1950, 3:38 AM EDT  
Att. 20,673 - Unknown - 75 F

AB 74  
R 7  
H 15  
RBI 6  
BB 7  
SO 7  
LOB 41





| Batter  | 1   | 2                               | 3                            | 4                                | 5                            | 6                               | 7                            | 8                               | 9                            | 10                              | 11                           | 12                               | 13                           | 14                               | 15                           | 16                               | 17                           | 18                              | 19                           | AB                              | R                            | H                               | RBI                          | BB                              | SO                           | LOB                             | BOTTOM  |                                 |                              |                                 |                              |                                 |                                   |                          |                                  |        |  |  |  |  |  |  |  |
|---|---|---------------------------------|------------------------------|----------------------------------|------------------------------|---------------------------------|------------------------------|---------------------------------|------------------------------|---------------------------------|------------------------------|----------------------------------|------------------------------|----------------------------------|------------------------------|----------------------------------|------------------------------|---------------------------------|------------------------------|---------------------------------|------------------------------|---------------------------------|------------------------------|---------------------------------|------------------------------|---------------------------------|---|---------------------------------|------------------------------|---------------------------------|------------------------------|---------------------------------|-----------------------------------|--------------------------|----------------------------------|--------|--|--|--|--|--|--|--|
| Eddie Waitkus, L (1, 3)<br>OBP: 0.346, SLG: 0.366     | F4  | BB                              |                              |                                  | FC4-6<br>1B                  |                                 | E4<br>1B                     | K                               |                              | FC3-6<br>1B                     |                              | 2B                               |                              | FC6-4<br>1-2r                    |                              |                                  | 2B                           |                                 | BB<br>1B                     | 9                               | 2                            | 5                               | 0                            | 1                               | 1                            | 4                               | Cincinnati Reds @ Philadelphia Phillies<br>Shibe Park, Philadelphia, PA<br>Fri Sep 15 1950, 3:38 AM EDT<br>Att. 20,673 - Unknown - 75 |                                 |                              |                                 |                              |                                 |                                   |                          |                                  |        |  |  |  |  |  |  |  |
| Richie Ashburn, L (1, 8)<br>OBP: 0.381, SLG: 0.420    | FC6-4<br>1B   | F3                              |                              |                                  | FC4-6<br>1-2r                |                                 | 1B<br>1-2                    | FC6-4<br>1-2r                   |                              | FC3-6<br>S                      |                              | F9                               |                              |                                  | 4-3                          |                                  | F8                           |                                 | 1B<br>BB<br>1B               | 9                               | 0                            | 2                               | 0                            | 1                               | 0                            | 9                               |   |                                 |                              |                                 |                              |                                 |                                   |                          |                                  |        |  |  |  |  |  |  |  |
| Willie Jones, R (1, 5)<br>OBP: 0.348, SLG: 0.474      | FC6-4<br>1B   |                                 |                              | F7                               | F7                           |                                 | F8                           |                                 | K                            | F5                              |                              |                                  | FC6-4<br>1B                  |                                  | 6-3                          |                                  | F2                           |                                 | BB<br>BB<br>BB<br>1B         | 9                               | 0                            | 1                               | 1                            | 1                               | 1                            | 6                               |   |                                 |                              |                                 |                              |                                 |                                   |                          |                                  |        |  |  |  |  |  |  |  |
| Del Ennis, R (1, 9)<br>OBP: 0.368, SLG: 0.560         | 1B  |                                 |                              | K                                | F9                           |                                 | 1B                           |                                 |                              | F9                              |                              |                                  | FC6-4<br>1-2r                |                                  | F9                           |                                  |                              |                                 | 1B<br>F8<br>2B               | 10                              | 2                            | 5                               | 2                            | 0                               | 1                            | 3                               |   |                                 |                              |                                 |                              |                                 |                                   |                          |                                  |        |  |  |  |  |  |  |  |
| Jackie Mayo, L (1, 7)<br>OBP: 0.227, SLG: 0.238       | F6  |                                 |                              | L4                               |                              | L4                              | 6-3                          |                                 |                              | 6-3                             |                              |                                  | F9                           |                                  | F9                           |                                  | F5                           |                                 | BB<br>1B                     | 4                               | 0                            | 0                               | 0                            | 0                               | 0                            | 4                               |   |                                 |                              |                                 |                              |                                 |                                   |                          |                                  |        |  |  |  |  |  |  |  |
| Stan Holmiec, R (9, PH)<br>OBP: 0.222, SLG: 0.444     |   |                                 |                              |                                  |                              |                                 |                              |                                 |                              |                                 |                              |                                  |                              |                                  |                              |                                  |                              |                                 |                              | 0                               | 1                            | 0                               | 0                            | 0                               | 0                            | 0                               |   |                                 |                              |                                 |                              |                                 |                                   |                          |                                  |        |  |  |  |  |  |  |  |
| Putsy Caballero, R (9, PR)<br>OBP: 0.240, SLG: 0.174  |   |                                 |                              |                                  |                              |                                 |                              |                                 |                              |                                 |                              |                                  |                              |                                  |                              |                                  |                              |                                 |                              | 0                               | 1                            | 0                               | 0                            | 0                               | 0                            | 0                               |   |                                 |                              |                                 |                              |                                 |                                   |                          |                                  |        |  |  |  |  |  |  |  |
| Dick Sleser, L (10, 7)<br>OBP: 0.373, SLG: 0.434      |   |                                 |                              |                                  |                              |                                 |                              |                                 |                              |                                 |                              |                                  |                              |                                  |                              |                                  |                              |                                 |                              | 4                               | 1                            | 1                               | 0                            | 0                               | 0                            | 1                               |   |                                 |                              |                                 |                              |                                 |                                   |                          |                                  |        |  |  |  |  |  |  |  |
| Granny Hamner, R (1, 6)<br>OBP: 0.325, SLG: 0.396     |   | 1B<br>2B                        |                              |                                  | 6-3                          |                                 | F4                           |                                 |                              | F9                              |                              |                                  | F8                           |                                  | F8                           |                                  | F8                           |                                 | 3B<br>1B                     | 8                               | 1                            | 2                               | 3                            | 1                               | 0                            | 2                               |   |                                 |                              |                                 |                              |                                 |                                   |                          |                                  |        |  |  |  |  |  |  |  |
| Andy Seminick, R (1, 2)<br>OBP: 0.396, SLG: 0.540     |   |                                 |                              |                                  |                              |                                 |                              |                                 |                              |                                 |                              |                                  |                              |                                  |                              |                                  |                              |                                 |                              | 2                               | 0                            | 1                               | 0                            | 1                               | 0                            | 0                               |   |                                 |                              |                                 |                              |                                 |                                   |                          |                                  |        |  |  |  |  |  |  |  |
| Stan Lopata, R (7, 2)<br>OBP: 0.324, SLG: 0.276       |   | BB<br>1B                        |                              |                                  | FC4-6<br>BB                  |                                 | 5-3                          |                                 |                              | F4                              |                              |                                  |                              |                                  | F8                           |                                  |                              |                                 | 3B                           | 4                               | 0                            | 1                               | 1                            | 2                               | 0                            | 1                               |   |                                 |                              |                                 |                              |                                 |                                   |                          |                                  |        |  |  |  |  |  |  |  |
| Mike Goliat, R (1, 4)<br>OBP: 0.316, SLG: 0.361       |   |                                 |                              |                                  |                              |                                 |                              |                                 |                              | F9                              |                              |                                  |                              |                                  | 1-3                          |                                  |                              |                                 | F4                           | 9                               | 1                            | 2                               | 0                            | 0                               | 1                            | 7                               |   |                                 |                              |                                 |                              |                                 |                                   |                          |                                  |        |  |  |  |  |  |  |  |
| Robin Roberts, S (1, 1)<br>OBP: 0.165, SLG: 0.098     |   |                                 |                              |                                  |                              |                                 |                              |                                 |                              |                                 |                              |                                  |                              |                                  |                              |                                  |                              |                                 |                              | 2                               | 0                            | 0                               | 0                            | 0                               | 0                            | 3                               |   |                                 |                              |                                 |                              |                                 |                                   |                          |                                  |        |  |  |  |  |  |  |  |
| Dick Winter, L (7, PH)<br>OBP: 0.209, SLG: 0.299      |   |                                 |                              |                                  |                              |                                 |                              |                                 |                              |                                 |                              |                                  |                              |                                  |                              |                                  |                              |                                 |                              | 0                               | 0                            | 0                               | 0                            | 0                               | 0                            | 0                               |   |                                 |                              |                                 |                              |                                 |                                   |                          |                                  |        |  |  |  |  |  |  |  |
| Jack Griffin, R (8, 1)<br>OBP: 0.267, SLG: 0.257      |   |                                 |                              |                                  |                              |                                 |                              |                                 |                              |                                 |                              |                                  |                              |                                  |                              |                                  |                              |                                 |                              | 0                               | 0                            | 1                               | 1                            | 0                               | 0                            | 0                               |   |                                 |                              |                                 |                              |                                 |                                   |                          |                                  |        |  |  |  |  |  |  |  |
| Jimmy Bloodworth, R (8, PH)<br>OBP: 0.267, SLG: 0.257 |   |                                 |                              |                                  |                              |                                 |                              |                                 |                              |                                 |                              |                                  |                              |                                  |                              |                                  |                              |                                 |                              | 0                               | 0                            | 1                               | 1                            | 0                               | 0                            | 0                               |   |                                 |                              |                                 |                              |                                 |                                   |                          |                                  |        |  |  |  |  |  |  |  |
| Ken Johnson, L (8, PH)<br>OBP: 0.267, SLG: 0.257      |   |                                 |                              |                                  |                              |                                 |                              |                                 |                              |                                 |                              |                                  |                              |                                  |                              |                                  |                              |                                 |                              | 0                               | 0                            | 0                               | 0                            | 0                               | 0                            | 0                               |   |                                 |                              |                                 |                              |                                 |                                   |                          |                                  |        |  |  |  |  |  |  |  |
| Jim Konstantin, L (8, PH)<br>OBP: 0.267, SLG: 0.257   |   |                                 |                              |                                  |                              |                                 |                              |                                 |                              |                                 |                              |                                  |                              |                                  |                              |                                  |                              |                                 |                              | 4                               | 0                            | 1                               | 0                            | 0                               | 0                            | 1                               |   |                                 |                              |                                 |                              |                                 |                                   |                          |                                  |        |  |  |  |  |  |  |  |
| Ken Silvestri, S (18, PH)<br>OBP: 0.267, SLG: 0.257   |   |                                 |                              |                                  |                              |                                 |                              |                                 |                              |                                 |                              |                                  |                              |                                  |                              |                                  |                              |                                 |                              | 1                               | 0                            | 0                               | 0                            | 0                               | 0                            | 1                               |   |                                 |                              |                                 |                              |                                 |                                   |                          |                                  |        |  |  |  |  |  |  |  |
| Bliz Donnelly, R (19, 1)<br>OBP: 0.267, SLG: 0.257    |   |                                 |                              |                                  |                              |                                 |                              |                                 |                              |                                 |                              |                                  |                              |                                  |                              |                                  |                              |                                 |                              | 0                               | 0                            | 0                               | 0                            | 0                               | 0                            | 1                               |   |                                 |                              |                                 |                              |                                 |                                   |                          |                                  |        |  |  |  |  |  |  |  |
| <b>Inning Stats</b>                                   | R: 0<br>E: 0<br>K: 5<br>S: 5                          | H: 2<br>LOB: 2<br>BB: 0<br>P: 5 | R: 0<br>E: 0<br>K: 1<br>S: 7 | H: 2<br>LOB: 3<br>BB: 1<br>P: 11 | R: 0<br>E: 0<br>K: 1<br>S: 5 | H: 0<br>LOB: 0<br>BB: 0<br>P: 5 | R: 0<br>E: 0<br>K: 1<br>S: 3 | H: 0<br>LOB: 1<br>BB: 1<br>P: 7 | R: 0<br>E: 0<br>K: 1<br>S: 4 | H: 0<br>LOB: 0<br>BB: 0<br>P: 3 | R: 2<br>E: 1<br>K: 0<br>S: 6 | H: 2<br>LOB: 2<br>BB: 1<br>P: 10 | R: 1<br>E: 0<br>K: 1<br>S: 7 | H: 2<br>LOB: 2<br>BB: 1<br>P: 11 | R: 2<br>E: 0<br>K: 1<br>S: 8 | H: 3<br>LOB: 2<br>BB: 1<br>P: 12 | R: 0<br>E: 0<br>K: 0<br>S: 4 | H: 1<br>LOB: 1<br>BB: 0<br>P: 4 | R: 0<br>E: 0<br>K: 0<br>S: 4 | H: 1<br>LOB: 1<br>BB: 0<br>P: 4 | R: 0<br>E: 0<br>K: 0<br>S: 4 | H: 1<br>LOB: 0<br>BB: 0<br>P: 4 | R: 0<br>E: 0<br>K: 0<br>S: 3 | H: 0<br>LOB: 0<br>BB: 0<br>P: 3 | R: 0<br>E: 0<br>K: 0<br>S: 3 | H: 0<br>LOB: 1<br>BB: 1<br>P: 7 | R: 0<br>E: 0<br>K: 1<br>S: 6  | H: 1<br>LOB: 1<br>BB: 0<br>P: 6 | R: 2<br>E: 0<br>K: 0<br>S: 6 | H: 3<br>LOB: 1<br>BB: 0<br>P: 6 | R: 1<br>E: 0<br>K: 0<br>S: 3 | H: 3<br>LOB: 3<br>BB: 1<br>P: 7 | 1B: 15<br>2B: 7<br>3B: 1<br>HR: 0 | SF: 0<br>DP: 0<br>HBP: 0 | WP: 0<br>PB: 0<br>SB: 1<br>CS: 0 | PA: 85 |  |  |  |  |  |  |  |
| <b>PITCHER</b>  | IP WLS BF H R ER SO BB IBB HBP BLK WP HR S P ERA WHIP |                                 |                              |                                  |                              |                                 |                              |                                 |                              |                                 |                              |                                  |                              |                                  |                              |                                  |                              |                                 |                              |                                 |                              |                                 |                              |                                 |                              |                                 | IP WLS BF H R ER SO BB IBB HBP BLK WP HR S P ERA WHIP   |                                 |                              |                                 |                              |                                 |                                   |                          |                                  |        |  |  |  |  |  |  |  |
| Howie Fox, R (1, 1)<br>ERA: 4.40                      | 7.1   | 36                              | 9                            | 3                                | 1                            | 2                               | 4                            | 0                               | 0                            | 0                               | 0                            | 0                                | 0                            | 0                                | 36                           | 52                               | 1.23                         | 1.773                           |                              |                                 |                              |                                 |                              |                                 |                              |                                 |   |                                 |                              |                                 |                              |                                 |                                   |                          |                                  |        |  |  |  |  |  |  |  |
| Ken Raffensberger, L (8, 1)<br>ERA: 4.32              | 1.0   | 5                               | 2                            | 2                                | 2                            | 2                               | 0                            | 0                               | 0                            | 0                               | 0                            | 0                                | 0                            | 9                                | 9                            | 18.00                            | 2.000                        |                                 |                              |                                 |                              |                                 |                              |                                 |                              |                                 |   |                                 |                              |                                 |                              |                                 |                                   |                          |                                  |        |  |  |  |  |  |  |  |
| Herm Wehmeier, R (9, 1)<br>ERA: 5.39                  | 9.2   | 40                              | 9                            | 2                                | 2                            | 1                               | 2                            | 0                               | 0                            | 0                               | 0                            | 0                                | 0                            | 40                               | 48                           | 1.86                             | 1.138                        |                                 |                              |                                 |                              |                                 |                              |                                 |                              |                                 |   |                                 |                              |                                 |                              |                                 |                                   |                          |                                  |        |  |  |  |  |  |  |  |
| Eddie Erault, R (19, 1)<br>ERA: 6.3                   | 0.0   | L 4                             | 3                            | 1                                | 1                            | 0                               | 1                            | 0                               | 0                            | 0                               | 0                            | 0                                | 0                            | 3                                | 7                            | ∞                                | ∞                            |                                 |                              |                                 |                              |                                 |                              |                                 |                              |                                 |   |                                 |                              |                                 |                              |                                 |                                   |                          |                                  |        |  |  |  |  |  |  |  |

Cincinnati Reds @ Philadelphia Phillies  
Shibe Park, Philadelphia, PA  
Fri Sep 15 1950, 3:38 AM EDT  
Att. 20,673 - Unknown - 75

AB 78  
R 8  
H 23  
RBI 8  
BB 7  
SO 5  
LOB 44



WP: 0 PA: 85  
PB: 0 SB: 1 CS: 0

| Batter  | 1   | 2   | 3   | 4   | 5   | 6   | 7  | 8   | 9   | AB R H RBI BB SO LOB   | TOP   |                |   |
|---|---|---|---|---|---|---|--|---|---|--|---|----------------|---|
| <b>Bobby Adams, R</b> (1, 4)<br>OBP: 0.367, SLG: 0.420  | 0-0<br>SH5-4<br>L8<br>E<br>1B                                   | 0-0<br>L5   |   |   | 0-0<br>5-3  |   | 0-0<br>1-2<br>1B   |   | 0-0<br>1-2<br>BB<br>1B  | 5 1 3 0 0 0 1  | <b>Cincinnati Reds @ Philadelphia Phillies</b><br>Shibe Park, Philadelphia, PA<br>Sat Sep 16 1950, 3:33 AM EDT<br>Att: 12,052 - Unknown<br><a href="http://livebaseballscorecards.com">livebaseballscorecards.com</a> |                |   |
| <b>Grady Hatton, L</b> (1, 5)<br>OBP: 0.364, SLG: 0.381   | 0-0<br>FC1<br>L8<br>SH5-4<br>1-2                                |   | 0-0<br>3-1  |   | 4-0<br>CS<br>BB   |   | 0-0<br>F9  |   | 4-0<br>1-2<br>2-3<br>BB   | 3 0 0 0 2 0 3  |   |                |   |
| <b>Johnny Wyrostek, L</b> (1, 9)<br>OBP: 0.378, SLG: 0.446  | 0-0<br>SH5-4<br>1-2<br>2-3                                      |   | 0-0<br>FC3-6<br>1B  |   | 0-0<br>CS<br>1-2  | 0-0<br>1B<br>2B   | 0-3<br>K   |   | 0-0<br>F8   | 4 1 2 0 0 1 5  |   |                |   |
| <b>Ted Kluszewski, L</b> (1, 3)<br>OBP: 0.357, SLG: 0.539   | 0-0<br>L8<br>2-3<br>3-H   |   | 0-0<br>FC3-6<br>1-2f  |   | 0-0<br>G3<br>2-H<br>1B  |   | 0-0<br>F7  |   |   | 4 0 1 2 0 0 2  |   |                |   |
| <b>Lloyd Merriman, L</b> (1, 8)<br>OBP: 0.326, SLG: 0.342<br><b>Bob Usher, R</b> (8, 8)<br>OBP: 0.309, SLG: 0.355 | 4-0<br>BB   |   | 0-0<br>G3   |   | 0-0<br>G3<br>2-3  |   | 0-0<br>F5  |   |   | 3 0 0 0 1 0 2<br>0 0 0 0 0 0 0   |   |                |   |
| <b>Joe Adcock, R</b> (1, 7)<br>OBP: 0.314, SLG: 0.394   | 0-0<br>4-3  |   | 0-0<br>5-3  |   | 0-0<br>6-3  |   | 0-0<br>4-3   |   |   | 4 0 0 0 0 0 3  |   |                |   |
| <b>Johnny Pramesa, R</b> (1, 2)<br>OBP: 0.373, SLG: 0.448   |   | 0-0<br>L8   | 0-0<br>5-3  |   | 0-0<br>F3   |   |  | 0-0<br>L9   |   | 4 0 0 0 0 0 1  |   |                |   |
| <b>Sammy Meeks, R</b> (1, 6)<br>OBP: 0.309, SLG: 0.360  |   | 0-3<br>K  | 0-0<br>4-3  |   |   | 0-0<br>F3   |  | 0-0<br>B1-3   |   | 4 0 0 0 0 1 0  |   |                |   |
| <b>Ewell Blackwell, R</b> (1, 1)<br>OBP: 0.174, SLG: 0.136  |   | 0-0<br>1B   |   | 0-0<br>1-3  |   | 4-0<br>1B<br>BB   |  | 0-0<br>BB<br>1B<br>1B   |   | 3 0 2 0 1 0 0  |   |                |   |
| <b>Inning Stats</b>   | R: 1<br>E: 1<br>K: 0<br>S: 5<br>H: 1<br>LOB: 2<br>BB: 1<br>P: 9 | R: 0<br>E: 0<br>K: 1<br>S: 6<br>H: 1<br>LOB: 1<br>BB: 0<br>P: 6 | R: 0<br>E: 0<br>K: 0<br>S: 4<br>H: 1<br>LOB: 1<br>BB: 0<br>P: 4 | R: 0<br>E: 0<br>K: 0<br>S: 3<br>H: 0<br>LOB: 0<br>BB: 0<br>P: 3 | R: 0<br>E: 0<br>K: 0<br>S: 2<br>H: 0<br>LOB: 0<br>BB: 1<br>P: 6 | R: 1<br>E: 0<br>K: 0<br>S: 5<br>H: 2<br>LOB: 1<br>BB: 0<br>P: 5 | R: 0<br>E: 0<br>K: 1<br>S: 6<br>H: 1<br>LOB: 2<br>BB: 1<br>P: 10 | R: 0<br>E: 0<br>K: 0<br>S: 3<br>H: 0<br>LOB: 0<br>BB: 0<br>P: 3 | R: 0<br>E: 0<br>K: 0<br>S: 5<br>H: 2<br>LOB: 3<br>BB: 1<br>P: 9 | 1B: 7<br>2B: 1<br>3B: 0<br>HR: 0<br>SF: 0<br>SAC: 1<br>DP: 0<br>HBP: 0 | WP: 0<br>PB: 0<br>SB: 0<br>CS: 1<br>PA: 40  |                |   |
| <b>PITCHER</b>  | IP WLS BF H R ER SO BB IBB HBP BLK WP HR S P ERA WHIP           |   |   |   |   |   |  |   |   |  |   | <b>PITCHER</b> | IP WLS BF H R ER SO BB IBB HBP BLK WP HR S P ERA WHIP |
| <b>Bob Miller, R</b> (1, 1)<br>ERA: 3.37  | 6.0 L 25 5 2 1 1 2 0 0 0 0 0 0 25 33 1.50 1.167                 |   |   |   |   |   |  |   |   |  |   |                |   |
| <b>Paul Stffel, R</b> (7, 1)<br>ERA:  | 2.0 8 1 0 0 1 1 0 0 0 0 0 0 9 13 0.00 1.000                     |   |   |   |   |   |  |   |   |  |   |                |   |
| <b>Milo Candini, R</b> (9, 1)<br>ERA: 3.16  | 1.0 6 2 0 0 0 0 1 0 0 0 0 0 5 9 0.00 3.000                      |   |   |   |   |   |  |   |   |  |   |                |   |



| Batter   | 1                             | 2            | 3             | 4            | 5                                    | 6           | 7            | 8                         | 9 | AB R H RBI BB SO LOB |
|--|-------------------------------|--------------|---------------|--------------|--------------------------------------|-------------|--------------|---------------------------|---|----------------------|
| <b>Eddie Waitkus, L</b><br>OBP: 0.345, SLG: 0.364<br>(1, 3) BB | 4-0<br>FC4-6<br>BB            |              | x 0-0<br>F7   |              | x 0-0<br>FC6-4                       |             |              | x 0-0<br>6-3              |   | 3 0 0 0 1 0 2        |
| <b>Richie Ashburn, L</b><br>OBP: 0.379, SLG: 0.417<br>(1, 8) X | 0-0<br>FC4-6<br>BB 1B<br>1-2f |              | x 0-0<br>G2-3 |              | x 0-0<br>6-3                         |             |              | SS 0-3<br>K               |   | 4 0 0 0 0 1 3        |
| <b>Willie Jones, R</b><br>OBP: 0.346, SLG: 0.471<br>(1, 5) SS  | 0-3<br>K                      |              | SS 0-3<br>K   |              |                                      | SS 0-3<br>K |              | x 0-0<br>F8               |   | 4 0 0 0 0 3 1        |
| <b>Del Ennis, R</b><br>OBP: 0.367, SLG: 0.558<br>(1, 9) X      | 0-0<br>BB<br>1-2<br>1B        |              |               | x 0-0<br>5-3 |                                      | SS 0-3<br>K |              | SS 0-3<br>K               |   | 4 0 1 0 0 2 0        |
| <b>Jackie Mayo, L</b><br>OBP: 0.269, SLG: 0.250<br>(1, 7) BB   | 4-0<br>BB<br>1-2<br>2-3<br>BB |              |               | x 0-0<br>G3  |                                      | x 0-0<br>F8 |              | x 0-0<br>BB<br>1B         |   | 3 0 1 0 1 0 0        |
| <b>Granny Hamner, R</b><br>OBP: 0.324, SLG: 0.393<br>(1, 6) X  | 0-0<br>4-3                    |              |               | x 0-0<br>1-3 |                                      |             | x 0-0<br>4-3 | BB 4-0<br>BB<br>1-2<br>BB |   | 3 0 0 0 1 0 3        |
| <b>Andy Seminick, R</b><br>OBP: 0.394, SLG: 0.537<br>(1, 2) X  |                               | x 0-0<br>5-3 |               |              | x 0-0<br>FC1-6<br>1B                 |             | x 0-0<br>6-3 | SS 0-3<br>K               |   | 4 0 1 0 0 1 2        |
| <b>Mike Goliat, R</b><br>OBP: 0.314, SLG: 0.359<br>(1, 4) SS   |                               | SS 0-3<br>K  |               |              | x 0-0<br>FC1-6<br>FC6-4<br>E<br>1-2f |             | x 0-0<br>6-3 |                           |   | 3 0 0 0 0 1 1        |
| <b>Bob Miller, R</b><br>OBP: 0.211, SLG: 0.214<br>(1, 1) X     |                               | x 0-0<br>4-3 |               |              | x 0-0<br>E6<br>FC6-4                 |             |              | x 0-0<br>4-3              |   | 2 0 0 0 0 0 1        |
| <b>Paul Stuffle, R</b><br>(7, 1) X                             |                               |              |               |              |                                      |             |              |                           |   | 0 0 0 0 0 0 0        |
| <b>Dick Whitman, L</b><br>OBP: 0.307, SLG: 0.297<br>(8, PH) X  |                               |              |               |              |                                      |             |              |                           |   | 1 0 0 0 0 0 0        |
| <b>Milo Candini, R</b><br>OBP: 0.200, SLG: 0.200<br>(9, 1) X   |                               |              |               |              |                                      |             |              |                           |   | 0 0 0 0 0 0 0        |

| Inning Stats   | R: 0 | H: 1 | E: 0 | K: 1 | S: 6 | LOB: 3 | BB: 2 | P: 14 | R: 0 | H: 0 | E: 0 | K: 1 | S: 5 | LOB: 0 | BB: 0 | P: 5 | R: 0  | H: 0 | E: 0 | K: 0 | S: 3 | LOB: 0 | BB: 0 | P: 3 | R: 0 | H: 1 | E: 1 | K: 0 | S: 5 | LOB: 2 | BB: 0 | P: 5 | R: 0 | H: 0 | E: 0 | K: 2 | S: 7 | LOB: 0 | BB: 0 | P: 7 | R: 0 | H: 0 | E: 0 | K: 0 | S: 3 | LOB: 0 | BB: 0 | P: 3 | R: 0 | H: 0 | E: 0 | K: 1 | S: 5 | LOB: 0 | BB: 0 | P: 5 | R: 0 | H: 1 | E: 0 | K: 2 | S: 8 | LOB: 2 | BB: 1 | P: 12 | 1B: 3 | 2B: 0 | 3B: 0 | HR: 0 | SF: 0 | SAC: 0 | DP: 0 | HBP: 0 | WP: 0 | PB: 0 | SB: 0 | CS: 0 | PA: 34 |
|--|------|------|------|------|------|--------|-------|-------|------|------|------|------|------|--------|-------|------|-------|------|------|------|------|--------|-------|------|------|------|------|------|------|--------|-------|------|------|------|------|------|------|--------|-------|------|------|------|------|------|------|--------|-------|------|------|------|------|------|------|--------|-------|------|------|------|------|------|------|--------|-------|-------|-------|-------|-------|-------|-------|--------|-------|--------|-------|-------|-------|-------|--------|
| <b>PITCHER</b><br><b>Ewell Blackwell, R</b><br>ERA: 3.19<br>(1, 1) | IP   | WLS  | BF   | H    | R    | ER     | SO    | BB    | IBB  | HBP  | BLK  | WP   | HR   | S      | P     | ERA  | WHIP  |      |      |      |      |        |       |      |      |      |      |      |      |        |       |      |      |      |      |      |      |        |       |      |      |      |      |      |      |        |       |      |      |      |      |      |      |        |       |      |      |      |      |      |      |        |       |       |       |       |       |       |       |        |       |        |       |       |       |       |        |
|  | 9.0  | W    | 34   | 3    | 0    | 0      | 8     | 3     | 0    | 0    | 0    | 0    | 0    | 47     | 59    | 0.00 | 0.667 |      |      |      |      |        |       |      |      |      |      |      |      |        |       |      |      |      |      |      |      |        |       |      |      |      |      |      |      |        |       |      |      |      |      |      |      |        |       |      |      |      |      |      |      |        |       |       |       |       |       |       |       |        |       |        |       |       |       |       |        |

**BOTTOM**

**Cincinnati Reds @ Philadelphia Phillies**  
Shibe Park, Philadelphia, PA

Sat Sep 16 1950, 3:33 AM EDT  
Att. 12,052 - Unknown

|            |           |
|------------|-----------|
| <b>AB</b>  | <b>31</b> |
| <b>R</b>   | <b>0</b>  |
| <b>H</b>   | <b>3</b>  |
| <b>RBI</b> | <b>0</b>  |
| <b>BB</b>  | <b>3</b>  |
| <b>SO</b>  | <b>8</b>  |
| <b>LOB</b> | <b>13</b> |

livebaseballscorecards.com



| Batter   | 1  | 2   | 3   | 4   | 5   | 6   | 7   | 8   | 9   | AB R H RBI BB SO LOB   | TOP   |
|--|--|---|---|---|---|---|---|---|---|--|---|
| <b>Bobby Adams, R</b> (1, 5)<br>OBP: 0.368, SLG: 0.419       | 0-0<br>4-3 S<br>1B   |   | 0-0<br>6-3  |   | 0-0<br>F8   |   | 0-0<br>6-3  |   | 0-0<br>1B   | 5 0 2 0 0 0 1  | <b>Cincinnati Reds @ Boston Braves</b><br>Braves Field, Boston, MA<br>Sun Sep 17 1950, 3:33 AM EDT<br>Unknown<br><a href="http://livebaseballscorecards.com">livebaseballscorecards.com</a> |
| <b>Bob Usher, R</b> (1, 8)<br>OBP: 0.307, SLG: 0.351         | 0-0<br>1-3<br>1-2  |   | 4-0<br>BB   |   | 0-0<br>F2   |   |   | 0-0<br>E1<br>FC6-4<br>1B  | 0-0<br>P2   | 4 1 0 0 1 0 3  |   |
| <b>Johnny Wyrostek, L</b> (1, 9)<br>OBP: 0.375, SLG: 0.442   | 0-0<br>4-3<br>2-3  |   | 0-0<br>F9   |   |   |   |   | 0-0<br>E1<br>FC6-4<br>1-2                                       |   | 4 0 0 0 0 0 3  |   |
| <b>Ted Kluszewski, L</b> (1, 3)<br>OBP: 0.356, SLG: 0.537    | 0-0<br>F7  |   |   | 0-0<br>E6<br>FC1-6  |   | 0-0<br>2B<br>1B   |   | 0-0<br>F7   |   | 4 1 1 0 0 0 3  |   |
| <b>Joe Adcock, R</b> (1, 7)<br>OBP: 0.314, SLG: 0.392        |  | 0-0<br>G5-3<br>E<br>1B  |   | 0-0<br>F9   |   | 0-0<br>F9   |   | 0-0<br>FC6-4<br>1-2f<br>2-3<br>1B                               |   | 4 0 1 0 0 0 4  |   |
| <b>Connie Ryan, R</b> (1, 4)<br>OBP: 0.350, SLG: 0.364       |  | 0-3<br>K  |   | 0-0<br>FC1-6<br>1-2f  |   | 0-0<br>1-H<br>2B  |   | 0-0<br>1-2<br>3-H<br>1B   |   | 4 0 2 2 0 1 2  |   |
| <b>Virgil Stallcup, R</b> (1, 6)<br>OBP: 0.281, SLG: 0.359   |  | 0-0<br>E4<br>1-2  |   | 0-0<br>F5   |   | 0-0<br>5-3  |   | 0-0<br>F2   |   | 4 0 0 0 0 0 5  |   |
| <b>Dixie Howell, R</b> (1, 2)<br>OBP: 0.325, SLG: 0.294      |  | 0-0<br>G5-3<br>2-3f   |   | 4-0<br>SH3-4<br>BB  |   | 0-0<br>F7   |   | 0-0<br>5-3  |   | 3 0 0 0 1 0 2  |   |
| <b>Kent Peterson, R</b> (1, 1)<br>OBP: 0.333, SLG: 0.333     |  |   | 0-0<br>1-3  |   | 0-0<br>SH3-4  |   | 0-0<br>F8   |   | 0-0<br>F3   | 1 0 0 0 0 0 0  |   |
| <b>Sammy Meeks, R</b> (7, PH)<br>OBP: 0.305, SLG: 0.356      |  |   |   |   | 1-2   |   |   |   |   | 1 0 0 0 0 0 0  |   |
| <b>Johnny Hetki, R</b> (7, 1)<br>OBP: 0.300, SLG: 0.222      |  |   |   |   |   |   |   |   |   | 0 0 0 0 0 0 0  |   |
| <b>Danny Litwhiler, R</b> (9, PH)<br>OBP: 0.377, SLG: 0.471  |  |   |   |   |   |   |   |   |   | 1 0 0 0 0 0 0  |   |
| <b>Inning Stats</b>  | R: 0<br>E: 0<br>K: 0<br>S: 4<br>H: 1<br>LOB: 1<br>BB: 0<br>P: 4  | R: 0<br>E: 1<br>K: 1<br>S: 6<br>H: 1<br>LOB: 1<br>BB: 0<br>P: 6         | R: 0<br>E: 0<br>K: 0<br>S: 3<br>H: 0<br>LOB: 1<br>BB: 1<br>P: 7 | R: 0<br>E: 1<br>K: 0<br>S: 4<br>H: 0<br>LOB: 1<br>BB: 0<br>P: 4 | R: 0<br>E: 0<br>K: 0<br>S: 3<br>H: 0<br>LOB: 1<br>BB: 1<br>P: 7 | R: 1<br>E: 0<br>K: 0<br>S: 5<br>H: 2<br>LOB: 1<br>BB: 0<br>P: 5 | R: 0<br>E: 0<br>K: 0<br>S: 3<br>H: 0<br>LOB: 0<br>BB: 0<br>P: 3 | R: 1<br>E: 2<br>K: 0<br>S: 6<br>H: 1<br>LOB: 2<br>BB: 0<br>P: 6 | R: 0<br>E: 0<br>K: 0<br>S: 4<br>H: 1<br>LOB: 1<br>BB: 0<br>P: 4 | 1B: 5<br>2B: 1<br>3B: 0<br>HR: 0<br>SF: 0<br>SAC: 1<br>DP: 1<br>HBP: 0 | WP: 0<br>PB: 0<br>SB: 1<br>CS: 0<br>PA: 38  |
| <b>PITCHER</b><br><b>Warren Spahn, L</b> (1, 1)<br>ERA: 3.12 | IP<br>9.0<br>WLS<br>W<br>BF<br>38<br>H<br>6<br>R<br>2<br>ER<br>1<br>SO<br>1<br>BB<br>2<br>IBB<br>0<br>HBP<br>0<br>BLK<br>0<br>WP<br>0<br>HR<br>0<br>S<br>38<br>P<br>46<br>ERA<br>1.00<br>WHIP<br>0.889 | <b>PITCHER</b><br>IP WLS BF H R ER SO BB IBB HBP BLK WP HR S P ERA WHIP |   |   |   |   |   |   |   |  |   |



| Batter   | 1        | 2                   | 3              | 4           | 5                | 6        | 7                 | 8         | 9 |
|--|----------|---------------------|----------------|-------------|------------------|----------|-------------------|-----------|---|
| Roy Hartsfield, R<br>OBP: 0.325, SLG: 0.381<br>(1, 4) X    | 0-0 F7 ① |                     |                | 0-0 5-3 ① X | 0-0 3B 1B        |          | 0-0 G4-3 1B       |           |   |
| Luis Olmo, R<br>OBP: 0.306, SLG: 0.389<br>(1, 8) X         | 0-0 F3 ② |                     |                | 0-0 G3 S 1B | 0-0 1-H HR 3B    |          | 0-0 G4-3 ② ③ 1-2f |           |   |
| Earl Torgeson, L<br>OBP: 0.406, SLG: 0.461<br>(1, 3) S S S | 0-3 K ③  |                     |                | 0-0 G3 1-3  | 0-0 3-H HR       |          |                   | 0-0 HR    |   |
| Bob Elliott, R<br>OBP: 0.390, SLG: 0.512<br>(1, 5)         |          | 0-0 G5-4-3 1B       |                | 4-0 BB      | 0-0 5-3 ③        |          |                   | 0-0 G3 ①  |   |
| Sid Gordon, R<br>OBP: 0.415, SLG: 0.575<br>(1, 7)          |          | 0-0 G5-4-3 ① ② 1-2f |                | 0-0 F9      |                  | 0-0 F5   |                   | 0-0 G3 ②  |   |
| Del Crandall, R<br>OBP: 0.269, SLG: 0.327<br>(1, 2)        |          | 0-0 5-3 ③           |                |             | 0-0 E 2B         | 0-0 F7 ② |                   | 0-0 5-3 ③ |   |
| Tommy Holmes, L<br>OBP: 0.383, SLG: 0.451<br>(1, 9)        |          |                     | 0-0 F4 ①       |             | 0-0 1B 3B 2B 2-H | 0-0 F7 ③ |                   |           |   |
| Buddy Kerr, R<br>OBP: 0.294, SLG: 0.311<br>(1, 6)          |          |                     | 0-0 L3 1B      |             | 0-0 6-3 ①        |          | 0-0 1B 1B         |           |   |
| Warren Spahn, L<br>OBP: 0.267, SLG: 0.214<br>(1, 1)        |          |                     | 0-0 L3 ② ③ 1-2 |             | 0-3 K ②          |          | 0-3 K ①           |           |   |

| Inning Stats | R: 0 | H: 0 | E: 0 | K: 1 | S: 5 | LOB: 0 | BB: 0 | P: 5 | R: 0 | H: 1 | E: 0 | K: 0 | S: 3 | LOB: 0 | BB: 0 | P: 3 | R: 0 | H: 1 | E: 0 | K: 0 | S: 3 | LOB: 2 | BB: 1 | P: 8 | R: 5 | H: 5 | E: 1 | K: 1 | S: 10 | LOB: 0 | BB: 0 | P: 10 | R: 0 | H: 0 | E: 0 | K: 0 | S: 3 | LOB: 0 | BB: 0 | P: 3 | R: 0 | H: 2 | E: 0 | K: 1 | S: 6 | LOB: 1 | BB: 0 | P: 6 | R: 1 | H: 1 | E: 0 | K: 0 | S: 4 | LOB: 0 | BB: 0 | P: 4 |
|--------------|------|------|------|------|------|--------|-------|------|------|------|------|------|------|--------|-------|------|------|------|------|------|------|--------|-------|------|------|------|------|------|-------|--------|-------|-------|------|------|------|------|------|--------|-------|------|------|------|------|------|------|--------|-------|------|------|------|------|------|------|--------|-------|------|
|--------------|------|------|------|------|------|--------|-------|------|------|------|------|------|------|--------|-------|------|------|------|------|------|------|--------|-------|------|------|------|------|------|-------|--------|-------|-------|------|------|------|------|------|--------|-------|------|------|------|------|------|------|--------|-------|------|------|------|------|------|------|--------|-------|------|

| AB | R | H | RBI | BB | SO | LOB |
|----|---|---|-----|----|----|-----|
| 4  | 1 | 2 | 0   | 0  | 0  | 0   |
| 4  | 1 | 2 | 2   | 0  | 0  | 2   |
| 4  | 2 | 2 | 3   | 0  | 1  | 1   |
| 3  | 0 | 1 | 0   | 1  | 0  | 0   |
| 4  | 0 | 0 | 0   | 0  | 0  | 3   |
| 4  | 1 | 1 | 0   | 0  | 0  | 0   |
| 3  | 1 | 1 | 0   | 0  | 0  | 0   |
| 3  | 0 | 2 | 0   | 0  | 0  | 1   |
| 3  | 0 | 0 | 0   | 0  | 2  | 3   |

| PITCHER                                | IP  | WLS | BF | H | R | ER | SO | BB | IBB | HBP | BLK | WP | HR | S  | P  | ERA  | WHIP  |
|--|-----|-----|----|---|---|----|----|----|-----|-----|-----|----|----|----|----|------|-------|
| Kent Peterson, L<br>ERA: 9.0<br>(1, 1) | 6.0 | L   | 25 | 8 | 5 | 5  | 2  | 1  | 0   | 0   | 0   | 0  | 1  | 28 | 32 | 7.50 | 1.500 |
| Johnny Hetki, R<br>ERA: 5.44<br>(7, 1) | 2.0 |     | 8  | 3 | 1 | 1  | 1  | 0  | 0   | 0   | 0   | 0  | 1  | 10 | 10 | 4.50 | 1.500 |

**BOTTOM**

**Cincinnati Reds @ Boston Braves**  
 Braves Field, Boston, MA  
 Sun Sep 17 1950, 3:33 AM EDT  
 Unknown

|     |    |
|-----|----|
| AB  | 32 |
| R   | 6  |
| H   | 11 |
| RBI | 5  |
| BB  | 1  |
| SO  | 3  |
| LOB | 10 |



|       |        |       |        |
|-------|--------|-------|--------|
| 1B: 6 | SF: 0  | WP: 0 | PA: 33 |
| 2B: 3 | SAC: 0 | PB: 0 |        |
| 3B: 1 | DP: 3  | SB: 1 |        |
| HR: 2 | HBP: 0 | CS: 0 |        |

livebaseballscorecards.com

| Batter   | 1  | 2                               | 3                            | 4                               | 5                            | 6                               | 7                            | 8                               | 9                            | AB R H RBI BB SO LOB             | TOP  |                                 |  |                                 |                              |                                 |                              |                                 |                                  |                                    |                                  |        |
|--|--|---------------------------------|------------------------------|---------------------------------|------------------------------|---------------------------------|------------------------------|---------------------------------|------------------------------|----------------------------------|--|---------------------------------|--|---------------------------------|------------------------------|---------------------------------|------------------------------|---------------------------------|----------------------------------|------------------------------------|----------------------------------|--------|
| <b>Bobby Adams, R</b> (1, 5)<br>OBP: 0.375, SLG: 0.435           | 0-0<br>1B<br>2B  |                                 | 4-0<br>BB                    |                                 | 0-0<br>1-2<br>2-3<br>1B      |                                 | 0-0<br>1-H<br>3B             |                                 |                              | 3 0 3 1 1 0 0                    | <b>Cincinnati Reds @ Boston Braves</b><br>Braves Field, Boston, MA<br>Sun Sep 17 1950, 3:38 AM EDT<br>Att. 9,626 - Sunny |                                 |  |                                 |                              |                                 |                              |                                 |                                  |                                    |                                  |        |
| <b>Bob Usher, R</b> (1, 8)<br>OBP: 0.303, SLG: 0.346             | 0-0<br>5-3   |                                 | 0-0<br>1-3                   |                                 | 0-3<br>K                     |                                 | 0-0<br>F8                    |                                 |                              | 4 0 0 0 0 1 6                    |  |                                 |  |                                 |                              |                                 |                              |                                 |                                  |                                    |                                  |        |
| <b>Danny Litwhiler, R</b> (1, 9)<br>OBP: 0.381, SLG: 0.472       | 0-0<br>2-3<br>1B   |                                 |                              | 0-3<br>K                        |                              | 0-0<br>F4                       |                              | 0-0<br>G5-3<br>1B               |                              | 4 0 2 0 0 1 0                    |  |                                 |  |                                 |                              |                                 |                              |                                 |                                  |                                    |                                  |        |
| <b>Ted Kluszewski, L</b> (1, 3)<br>OBP: 0.355, SLG: 0.534        | 0-0<br>3-1   |                                 |                              | 0-0<br>3-1                      |                              | 0-0<br>F3                       |                              | 0-0<br>G5-3<br>1B               |                              | 4 0 1 0 0 0 1                    |  |                                 |  |                                 |                              |                                 |                              |                                 |                                  |                                    |                                  |        |
| <b>Joe Adcock, R</b> (1, 7)<br>OBP: 0.313, SLG: 0.390            |  | 0-0<br>G3                       |                              | 0-0<br>F8                       |                              | 0-0<br>1B                       |                              | 0-0<br>G5-3<br>1-2<br>2-3f      |                              | 4 0 1 0 0 0 2                    |  |                                 |  |                                 |                              |                                 |                              |                                 |                                  |                                    |                                  |        |
| <b>Johnny Pramesa, R</b> (1, 2)<br>OBP: 0.371, SLG: 0.442        |  | 0-0<br>6-3                      |                              | 4-0<br>1B<br>1B<br>BB           |                              | 0-0<br>F9                       |                              | 0-0<br>5-3                      |                              | 3 0 0 0 1 0 2                    |  |                                 |  |                                 |                              |                                 |                              |                                 |                                  |                                    |                                  |        |
| <b>Connie Ryan, R</b> (1, 4)<br>OBP: 0.347, SLG: 0.361           |  | 0-0<br>5-3                      |                              | 0-0<br>F7                       |                              |                                 | 0-0<br>6-3                   |                                 | 0-0<br>F3                    | 4 0 0 0 0 0 1                    |  |                                 |  |                                 |                              |                                 |                              |                                 |                                  |                                    |                                  |        |
| <b>Virgil Stallcup, R</b> (1, 6)<br>OBP: 0.278, SLG: 0.356       |  |                                 | 0-0<br>4-3                   |                                 | 0-3<br>K                     |                                 | 0-0<br>F8                    |                                 | 0-0<br>6-3                   | 4 0 0 0 0 1 1                    |  |                                 |  |                                 |                              |                                 |                              |                                 |                                  |                                    |                                  |        |
| <b>Frank Smith, R</b> (1, 1)<br>OBP: 0.100, SLG: 0.100           |  |                                 | 0-0<br>4-3                   |                                 | 0-0<br>1B<br>1B              |                                 | 4-0<br>3B<br>BB              |                                 | 0-3<br>K                     | 1 0 0 0 0 0 0                    |  |                                 |  |                                 |                              |                                 |                              |                                 |                                  |                                    |                                  |        |
| <b>Sammy Meeks, R</b> (5, PH)<br>OBP: 0.313, SLG: 0.363          |  |                                 |                              |                                 |                              |                                 |                              |                                 |                              | 1 0 1 0 0 0 0                    |  |                                 |  |                                 |                              |                                 |                              |                                 |                                  |                                    |                                  |        |
| <b>Howie Fox, R</b> (5, 1)<br>OBP: 0.222, SLG: 0.269             |  |                                 |                              |                                 |                              |                                 |                              |                                 |                              | 0 1 0 0 1 0 0                    |  |                                 |  |                                 |                              |                                 |                              |                                 |                                  |                                    |                                  |        |
| <b>Dixie Howell, R</b> (9, PH)<br>OBP: 0.323, SLG: 0.292         |  |                                 |                              |                                 |                              |                                 |                              |                                 |                              | 1 0 0 0 0 1 0                    |  |                                 |  |                                 |                              |                                 |                              |                                 |                                  |                                    |                                  |        |
| <b>Inning Stats</b>  | R: 0<br>E: 0<br>K: 0<br>S: 4   | H: 2<br>LOB: 1<br>BB: 0<br>P: 4 | R: 0<br>E: 0<br>K: 0<br>S: 3 | H: 0<br>LOB: 0<br>BB: 0<br>P: 3 | R: 0<br>E: 0<br>K: 0<br>S: 3 | H: 0<br>LOB: 1<br>BB: 1<br>P: 7 | R: 0<br>E: 0<br>K: 1<br>S: 5 | H: 0<br>LOB: 0<br>BB: 0<br>P: 5 | R: 0<br>E: 0<br>K: 2<br>S: 9 | H: 2<br>LOB: 3<br>BB: 1<br>P: 13 | R: 0<br>E: 0<br>K: 0<br>S: 4   | H: 1<br>LOB: 1<br>BB: 0<br>P: 4 | R: 1<br>E: 0<br>K: 0<br>S: 4   | H: 1<br>LOB: 1<br>BB: 1<br>P: 8 | R: 0<br>E: 0<br>K: 0<br>S: 4 | H: 2<br>LOB: 1<br>BB: 0<br>P: 4 | R: 0<br>E: 0<br>K: 1<br>S: 5 | H: 0<br>LOB: 0<br>BB: 0<br>P: 5 | 1B: 6<br>2B: 1<br>3B: 1<br>HR: 0 | SF: 0<br>SAC: 0<br>DP: 1<br>HBP: 0 | WP: 0<br>PB: 0<br>SB: 0<br>CS: 0 | PA: 36 |
| <b>PITCHER</b><br><b>Johnny Antonelli, L</b> (1, 1)<br>ERA: 6.06 | IP: 9.0<br>WLS: W<br>BF: 36<br>H: 8<br>R: 1<br>ER: 1<br>SO: 4<br>BB: 3<br>IBB: 0<br>HBP: 0<br>BLK: 0<br>WP: 0<br>HR: 0<br>S: 41<br>P: 53<br>ERA: 1.00<br>WHIP: 1.222 |                                 |                              |                                 |                              |                                 |                              |                                 |                              |                                  |  | <b>PITCHER</b>                  | IP: 9.0<br>WLS: W<br>BF: 36<br>H: 8<br>R: 1<br>ER: 1<br>SO: 4<br>BB: 3<br>IBB: 0<br>HBP: 0<br>BLK: 0<br>WP: 0<br>HR: 0<br>S: 41<br>P: 53<br>ERA: 1.00<br>WHIP: 1.222 |                                 |                              |                                 |                              |                                 |                                  |                                    |                                  |        |

livebaseballscorecards.com

|            |           |
|------------|-----------|
| <b>AB</b>  | <b>33</b> |
| <b>R</b>   | <b>1</b>  |
| <b>H</b>   | <b>8</b>  |
| <b>RBI</b> | <b>1</b>  |
| <b>BB</b>  | <b>3</b>  |
| <b>SO</b>  | <b>4</b>  |
| <b>LOB</b> | <b>13</b> |



| Batter  | 1         | 2                                | 3                       | 4                 | 5                   | 6          | 7                  | 8 | 9 |
|---|-----------|----------------------------------|-------------------------|-------------------|---------------------|------------|--------------------|---|---|
| Roy Hartsfield, R<br>OBP: 0.325, SLG: 0.380<br>(1, 4)   | 0-0<br>1B | 0-0<br>F7                        |                         | 0-0<br>F9         |                     | 0-3<br>K   |                    |   |   |
| Bob Addis, L<br>OBP: 0.375, SLG: 0.357<br>(1, 8)        | 0-3<br>K  |                                  | 0-0<br>4-3<br>1B        | 0-0<br>1B         | 0-0<br>1-H<br>2B    |            | 0-0<br>4-3         |   |   |
| Earl Torgeson, L<br>OBP: 0.405, SLG: 0.459<br>(1, 3)    | 0-0<br>F4 |                                  | 0-0<br>4-3              | 4-0<br>1-2<br>IBB |                     |            | 0-0<br>F9          |   |   |
| Bob Elliott, R<br>OBP: 0.387, SLG: 0.507<br>(1, 5)      | 0-0<br>F4 |                                  | 0-0<br>4-3              | 0-0<br>6-3        |                     |            | 0-0<br>4-3         |   |   |
| Sid Gordon, R<br>OBP: 0.416, SLG: 0.576<br>(1, 7)       |           | 0-0<br>S<br>FC4-6<br>2B          | 4-0<br>1B<br>BB         |                   | 0-0<br>F8           |            | 0-0<br>F8          |   |   |
| Walker Cooper, R<br>OBP: 0.373, SLG: 0.503<br>(1, 2)    |           | 1-0<br>FC4-6<br>S<br>HBP         | 0-0<br>1-2<br>3-H<br>1B |                   | 4-0<br>BB<br>G6-4-3 |            | 0-0<br>FC5-4<br>1B |   |   |
| Tommy Holmes, L<br>OBP: 0.378, SLG: 0.444<br>(1, 9)     |           | 0-0<br>F8                        | 0-0<br>F4               |                   | 0-0<br>G6-4-3       |            | 0-0<br>FC5-4<br>BB |   |   |
| Buddy Kerr, R<br>OBP: 0.298, SLG: 0.312<br>(1, 6)       |           | 4-0<br>1-2<br>2-3<br>FC4-6<br>BB |                         | 0-0<br>2B<br>1B   |                     | 0-0<br>F9  | 4-0<br>1-2<br>BB   |   |   |
| Johnny Antonelli, L<br>OBP: 0.143, SLG: 0.143<br>(1, 1) |           | 0-0<br>FC4-6                     |                         | 0-0<br>F5         |                     | 0-0<br>4-3 | 0-3<br>K           |   |   |

| AB | R | H | RBI | BB | SO | LOB |
|----|---|---|-----|----|----|-----|
| 4  | 0 | 1 | 0   | 0  | 1  | 3   |
| 4  | 1 | 2 | 1   | 0  | 1  | 1   |
| 3  | 0 | 0 | 0   | 1  | 0  | 2   |
| 4  | 0 | 0 | 0   | 0  | 0  | 4   |
| 3  | 1 | 1 | 0   | 1  | 0  | 0   |
| 2  | 0 | 2 | 1   | 1  | 0  | 0   |
| 4  | 0 | 0 | 0   | 0  | 0  | 6   |
| 2  | 1 | 1 | 0   | 2  | 0  | 0   |
| 4  | 0 | 0 | 1   | 0  | 1  | 5   |

**BOTTOM**

**Cincinnati Reds @ Boston Braves**  
 Braves Field, Boston, MA  
 Sun Sep 17 1950, 3:38 AM EDT  
 Att: 9,626 - Sunny

|            |           |
|------------|-----------|
| <b>AB</b>  | <b>30</b> |
| <b>R</b>   | <b>3</b>  |
| <b>H</b>   | <b>7</b>  |
| <b>RBI</b> | <b>3</b>  |
| <b>BB</b>  | <b>5</b>  |
| <b>SO</b>  | <b>3</b>  |
| <b>LOB</b> | <b>21</b> |



| Inning Stats | R: 0 | H: 1 | E: 0 | K: 1 | S: 6   | LOB: 1 | BB: 0 | P: 6 |
|--------------|------|------|------|------|--------|--------|-------|------|
| R: 1         | H: 1 | E: 0 | K: 0 | S: 4 | LOB: 2 | BB: 1  | P: 9  |      |
| R: 1         | H: 2 | E: 0 | K: 0 | S: 5 | LOB: 2 | BB: 1  | P: 9  |      |
| R: 1         | H: 2 | E: 0 | K: 0 | S: 5 | LOB: 2 | BB: 1  | P: 9  |      |
| R: 0         | H: 0 | E: 0 | K: 0 | S: 2 | LOB: 0 | BB: 1  | P: 6  |      |
| R: 0         | H: 0 | E: 0 | K: 1 | S: 5 | LOB: 0 | BB: 0  | P: 5  |      |
| R: 0         | H: 0 | E: 0 | K: 0 | S: 3 | LOB: 0 | BB: 0  | P: 3  |      |
| R: 0         | H: 1 | E: 0 | K: 1 | S: 6 | LOB: 2 | BB: 1  | P: 10 |      |

| 1B | 2B | 3B | HR | SF | SAC | DP | HBP |
|----|----|----|----|----|-----|----|-----|
| 5  | 2  | 0  | 0  | 0  | 1   | 1  | 1   |

| WP | HR | S  | P  | ERA  | WHIP  |
|----|----|----|----|------|-------|
| 0  | 0  | 16 | 24 | 0.00 | 0.750 |

| PITCHER                               | IP  | WLS | BF | H | R | ER | SO | BB | IBB | HBP | BLK | WP | HR | S  | P  | ERA  | WHIP  |
|---------------------------------------|-----|-----|----|---|---|----|----|----|-----|-----|-----|----|----|----|----|------|-------|
| Frank Smith, R<br>ERA: 3.78<br>(1, 1) | 4.0 | L   | 22 | 6 | 3 | 3  | 1  | 2  | 1   | 0   | 0   | 0  | 0  | 20 | 33 | 6.75 | 2.000 |
| Howie Fox, R<br>ERA: 4.35<br>(5, 1)   | 4.0 |     | 14 | 1 | 0 | 0  | 2  | 2  | 0   | 0   | 0   | 0  | 0  | 16 | 24 | 0.00 | 0.750 |

| Batter   | 1   | 2   | 3   | 4   | 5   | 6   | 7   | 8   | 9   | AB R H RBI BB SO LOB  | TOP                                     |
|--|---|---|---|---|---|---|---|---|---|---|---|
| <b>Bobby Adams, R</b> (1, 5)<br>OBP: 0.373, SLG: 0.431     | 0-0 P2  |   | 0-0 F8  |   | 0-0 F3  |   | 0-0 FC6-4   |   | 0-0 1B  | 5 1 1 0 0 0 1   |   |
| <b>Bob Usher, R</b> (1, 8)<br>OBP: 0.305, SLG: 0.344       | 0-0 P6  |   | 0-0 P6  |   | 0-0 F7  |   | 4-0 BB  |   | 0-0 1B  | 4 0 1 1 1 0 0   |   |
| <b>Johnny Wyrostek, L</b> (1, 9)<br>OBP: 0.375, SLG: 0.441 | 0-0 G3  |   | 0-0 1B  |   | 0-0 1B  |   | 0-0 F9  |   | 0-0 F5  | 5 0 2 0 0 0 4   |   |
| <b>Ted Kluszewski, L</b> (1, 3)<br>OBP: 0.354, SLG: 0.531  |   | 0-0 1-3   | 0-0 F7  |   | 0-0 F5  |   | 0-0 1-3   |   | 0-0 1B  | 5 0 1 1 0 0 2   |   |
| <b>Joe Adcock, R</b> (1, 7)<br>OBP: 0.314, SLG: 0.390      |   | 0-0 2B  |   | 0-0 FC5-4   |   | 0-0 F9  |   | 0-0 5-3   | 0-3 K   | 5 1 2 0 0 1 3   |   |
| <b>Johnny Pramesa, R</b> (1, 2)<br>OBP: 0.373, SLG: 0.448  |   | 0-0 2B  |   | 0-0 F7  |   | 0-0 FC6-4   |   | 0-0 F7  |   | 4 0 2 1 0 0 1   |   |
| <b>Connie Ryan, R</b> (1, 4)<br>OBP: 0.349, SLG: 0.361     |   | 4-0 BB  |   | 0-0 P6  |   | 0-0 FC6-4   |   |   | 0-0 SH1-4   | 3 1 1 0 1 0 3   |   |
| <b>Virgil Stallcup, R</b> (1, 6)<br>OBP: 0.276, SLG: 0.354 |   | 0-0 F3  |   | 0-0 FC5-4   |   | 0-0 F7  |   |   | 0-0 SH1-4   | 3 0 0 0 0 0 3   |   |
| <b>Ewell Blackwell, R</b> (1, 1)<br>OBP: 0.189, SLG: 0.153 |   | 0-0 F8  |   | 0-0 F3  |   | 0-0 FC6-4   |   |   | 0-0 1B  | 4 1 2 1 0 0 2   |   |
| <b>Inning Stats</b>  | R: 0 H: 0<br>E: 0 LOB: 0<br>K: 0 BB: 0<br>S: 3 P: 3   | R: 1 H: 2<br>E: 0 LOB: 2<br>K: 0 BB: 1<br>S: 5 P: 9 | R: 0 H: 1<br>E: 0 LOB: 1<br>K: 0 BB: 0<br>S: 4 P: 4 | R: 0 H: 1<br>E: 0 LOB: 1<br>K: 0 BB: 0<br>S: 4 P: 4 | R: 0 H: 0<br>E: 0 LOB: 0<br>K: 0 BB: 0<br>S: 3 P: 3 | R: 0 H: 2<br>E: 0 LOB: 2<br>K: 0 BB: 0<br>S: 5 P: 5 | R: 0 H: 1<br>E: 0 LOB: 2<br>K: 0 BB: 1<br>S: 4 P: 8 | R: 0 H: 0<br>E: 0 LOB: 0<br>K: 0 BB: 0<br>S: 3 P: 3 | R: 3 H: 5<br>E: 0 LOB: 2<br>K: 1 BB: 0<br>S: 10 P: 10 | 1B: 11 SF: 0<br>2B: 1 SAC: 1<br>3B: 0 DP: 0<br>HR: 0 HBP: 0 | WP: 0 PA: 41<br>PB: 0<br>SB: 0<br>CS: 0 |
| <b>PITCHER</b>   | IP WLS BF H R ER SO BB IBB HBP BLK WP HR S P ERA WHIP |   |   |   |   |   |   |   |   |   |   |
| <b>Dave Koslo, L</b> (1, 1)<br>ERA: 3.91                   | 8.1 L 38 11 4 4 0 2 0 0 0 0 0 0 36 44 4.32 1.560      |   |   |   |   |   |   |   |   |   |   |
| <b>Monty Kennedy, L</b> (9, 1)<br>ERA: 4.71                | 0.2 3 1 0 0 1 0 0 0 0 0 0 0 5 5 0.00 1.500            |   |   |   |   |   |   |   |   |   |   |

Cincinnati Reds @ New York Giants  
Polo Grounds, New York, NY  
Wed Sep 20 1950, 3:33 AM EDT  
Unknown

livebaseballscorecards.com

|            |           |
|------------|-----------|
| <b>AB</b>  | <b>38</b> |
| <b>R</b>   | <b>4</b>  |
| <b>H</b>   | <b>12</b> |
| <b>RBI</b> | <b>4</b>  |
| <b>BB</b>  | <b>2</b>  |
| <b>SO</b>  | <b>1</b>  |
| <b>LOB</b> | <b>19</b> |





| Batter   | 1                      | 2         | 3         | 4                           | 5                | 6               | 7         | 8                             | 9          | AB | R | H | RBI | BB | SO | LOB |
|--|------------------------|-----------|-----------|-----------------------------|------------------|-----------------|-----------|-------------------------------|------------|----|---|---|-----|----|----|-----|
| Eddie Stanky, R<br>OBP: 0.463, SLG: 0.413 (1, 4)   | 0-0<br>F8              |           | 0-0<br>F2 |                             | 4-0<br>E<br>BB   |                 | 0-3<br>K  |                               |            | 3  | 0 | 0 | 0   | 1  | 1  | 0   |
| Whitey Lockman, L<br>OBP: 0.357, SLG: 0.415 (1, 7) | 4-0<br>1B<br>6-3<br>BB |           | 0-0<br>1B |                             | 0-0<br>E4<br>1-2 |                 | 0-0<br>F5 |                               |            | 3  | 0 | 1 | 0   | 1  | 0  | 1   |
| Don Mueller, L<br>OBP: 0.312, SLG: 0.366 (1, 9)    | 0-0<br>6-3<br>1-2      |           | 0-0<br>P4 |                             | 0-0<br>F7        |                 |           | 0-0<br>F7                     |            | 4  | 0 | 0 | 0   | 0  | 0  | 4   |
| Hank Thompson, L<br>OBP: 0.389, SLG: 0.464 (1, 5)  | 0-0<br>2-3<br>1B       |           |           | 4-0<br>1B<br>FC4-6<br>BB    | 0-0<br>F9        |                 |           | 4-0<br>FC5-4<br>BB            |            | 2  | 1 | 1 | 0   | 2  | 0  | 2   |
| Monte Irvin, R<br>OBP: 0.393, SLG: 0.486 (1, 3)    | 0-0<br>F7              |           |           | 0-0<br>FC4-6<br>1-3<br>1B   |                  | 0-0<br>5-3      |           | 0-0<br>FC5-4<br>1-2f<br>FC5-4 |            | 4  | 0 | 1 | 0   | 0  | 0  | 3   |
| Wes Westrum, R<br>OBP: 0.374, SLG: 0.454 (1, 2)    |                        | 0-3<br>K  |           | 0-0<br>F3                   |                  | 0-0<br>5-3      |           | 0-0<br>FC5-4<br>1-2f          |            | 4  | 0 | 0 | 0   | 0  | 1  | 3   |
| Alvin Dark, R<br>OBP: 0.334, SLG: 0.451 (1, 6)     |                        | 0-0<br>F9 |           | 0-0<br>FC4-6<br>1-2f<br>3-H |                  | 0-0<br>E4<br>1B |           |                               | 0-0<br>1-3 | 4  | 0 | 1 | 1   | 0  | 0  | 1   |
| Bobby Thomson, R<br>OBP: 0.313, SLG: 0.412 (1, 8)  |                        | 0-0<br>F7 |           | 0-0<br>F5                   |                  | 0-0<br>F5       |           |                               | 0-0<br>6-3 | 4  | 0 | 0 | 0   | 0  | 0  | 2   |
| Dave Koslo, L<br>OBP: 0.203, SLG: 0.190 (1, 1)     |                        |           | 0-0<br>G3 |                             | 0-0<br>4-3       |                 | 0-3<br>K  |                               | 0-0<br>1-3 | 3  | 0 | 0 | 0   | 0  | 1  | 0   |
| Monty Kennedy, R<br>OBP: 0.088, SLG: 0.061 (9, 1)  |                        |           |           |                             |                  |                 |           |                               |            | 0  | 0 | 0 | 0   | 0  | 0  | 0   |
| Roy Weatherly, L<br>OBP: 0.373, SLG: 0.415 (9, PH) |                        |           |           |                             |                  |                 |           |                               |            | 1  | 0 | 0 | 0   | 0  | 0  | 0   |

| Inning Stats                                      | R: 0 | H: 1 | E: 0 | K: 0 | S: 4 | LOB: 2 | BB: 1 | P: 8 | R: 0 | H: 0 | E: 0 | K: 1 | S: 5 | LOB: 0 | BB: 0 | P: 5 | R: 0  | H: 1  | E: 0  | K: 0   | S: 4  | LOB: 1 | BB: 0 | P: 4   | R: 1  | H: 1   | E: 0 | K: 0 | S: 4 | LOB: 1 | BB: 1 | P: 8 | R: 0 | H: 0 | E: 1    | K: 0 | S: 4 | LOB: 2 | BB: 1 | P: 8 | R: 0 | H: 1 | E: 1 | K: 0 | S: 4 | LOB: 1 | BB: 0 | P: 4 | R: 0 | H: 0 | E: 0 | K: 2 | S: 7 | LOB: 0 | BB: 0 | P: 7 | R: 0 | H: 0 | E: 0 | K: 0 | S: 3 | LOB: 1 | BB: 1 | P: 7 | R: 0 | H: 0 | E: 0 | K: 0 | S: 3 | LOB: 0 | BB: 0 | P: 3 | R: 0 | H: 0 | E: 0 | K: 0 | S: 3 | LOB: 0 | BB: 0 | P: 3 |
|---|------|------|------|------|------|--------|-------|------|------|------|------|------|------|--------|-------|------|-------|-------|-------|--------|-------|--------|-------|--------|-------|--------|------|------|------|--------|-------|------|------|------|---------|------|------|--------|-------|------|------|------|------|------|------|--------|-------|------|------|------|------|------|------|--------|-------|------|------|------|------|------|------|--------|-------|------|------|------|------|------|------|--------|-------|------|------|------|------|------|------|--------|-------|------|
| PITCHER<br>Ewell Blackwell, R<br>ERA: 3.11 (1, 1) | IP   | WLS  | BF   | H    | R    | ER     | SO    | BB   | IBB  | HBP  | BLK  | WP   | HR   | S      | P     | ERA  | WHIP  |       |       |        |       |        |       |        |       |        |      |      |      |        |       |      |      |      | PITCHER | IP   | WLS  | BF     | H     | R    | ER   | SO   | BB   | IBB  | HBP  | BLK    | WP    | HR   | S    | P    | ERA  | WHIP |      |        |       |      |      |      |      |      |      |        |       |      |      |      |      |      |      |        |       |      |      |      |      |      |      |        |       |      |
|   |      |      |      |      |      |        |       |      |      |      |      |      |      |        |       |      | 1B: 4 | SF: 0 | 2B: 0 | SAC: 0 | 3B: 0 | DP: 0  | HR: 0 | HBP: 0 | WP: 0 | PA: 36 |      |      |      |        |       |      |      |      |         |      |      |        |       |      |      |      |      | ERA  | WHIP |        |       |      |      |      |      |      |      |        |       |      |      |      |      |      |      |        |       |      |      |      |      |      |      |        |       |      |      |      |      |      |      |        |       |      |

**BOTTOM**

**Cincinnati Reds @ New York Giants**  
Polo Grounds, New York, NY  
Wed Sep 20 1950, 3:33 AM EDT  
Unknown

|            |           |
|------------|-----------|
| <b>AB</b>  | <b>32</b> |
| <b>R</b>   | <b>1</b>  |
| <b>H</b>   | <b>4</b>  |
| <b>RBI</b> | <b>1</b>  |
| <b>BB</b>  | <b>4</b>  |
| <b>SO</b>  | <b>3</b>  |
| <b>LOB</b> | <b>16</b> |

[livebaseballscorecards.com](http://livebaseballscorecards.com)

| Batter   | 1   | 2                               | 3                            | 4                               | 5                            | 6                               | 7                            | 8                               | 9                            | AB R H RBI BB SO LOB            | TOP                          |                                 |                              |                                 |                              |                                 |                                  |                                    |                                  |        |
|--|---|---------------------------------|------------------------------|---------------------------------|------------------------------|---------------------------------|------------------------------|---------------------------------|------------------------------|---------------------------------|------------------------------|---------------------------------|------------------------------|---------------------------------|------------------------------|---------------------------------|----------------------------------|------------------------------------|----------------------------------|--------|
| <b>Bobby Adams, R</b> (1, 4)<br>OBP: 0.371, SLG: 0.427       | 0-0<br>E5<br>WP<br>E                                  |                                 | 0-0<br>5-3                   |                                 | 0-0<br>F9                    |                                 |                              | 4-0<br>CS<br>BB                 |                              | 3 1 0 0 1 0 2                   |                              |                                 |                              |                                 |                              |                                 |                                  |                                    |                                  |        |
| <b>Grady Hatton, L</b> (1, 5)<br>OBP: 0.363, SLG: 0.379      | 0-0<br>F7   |                                 | 0-0<br>4-3                   |                                 |                              | 0-0<br>3-1                      |                              | 0-0<br>1-2<br>1B                |                              | 4 0 1 0 0 0 1                   |                              |                                 |                              |                                 |                              |                                 |                                  |                                    |                                  |        |
| <b>Johnny Wyrostek, L</b> (1, 9)<br>OBP: 0.372, SLG: 0.438   | 0-0<br>E7<br>2-H                                      |                                 |                              | 0-0<br>G3                       |                              | 0-3<br>K                        |                              | 0-0<br>F9                       |                              | 4 0 0 1 0 1 1                   |                              |                                 |                              |                                 |                              |                                 |                                  |                                    |                                  |        |
| <b>Ted Kluszewski, L</b> (1, 3)<br>OBP: 0.353, SLG: 0.535    | 0-0<br>L6   |                                 |                              | 0-0<br>F8                       |                              | 0-0<br>HR                       |                              |                                 | 0-0<br>6-3                   | 4 1 1 1 0 0 1                   |                              |                                 |                              |                                 |                              |                                 |                                  |                                    |                                  |        |
| <b>Lloyd Merriman, L</b> (1, 8)<br>OBP: 0.321, SLG: 0.337    | 0-0<br>6-3  |                                 |                              | 0-3<br>K2-3                     |                              | 0-0<br>4-3                      |                              |                                 | 0-3<br>K                     | 4 0 0 0 0 2 1                   |                              |                                 |                              |                                 |                              |                                 |                                  |                                    |                                  |        |
| <b>Joe Adcock, R</b> (1, 7)<br>OBP: 0.313, SLG: 0.392        |   | 0-0<br>5-3                      |                              |                                 | 0-0<br>F7<br>2B              |                                 | 0-0<br>F7                    |                                 | 0-0<br>4-3                   | 4 0 1 0 0 0 0                   |                              |                                 |                              |                                 |                              |                                 |                                  |                                    |                                  |        |
| <b>Virgil Stallcup, R</b> (1, 6)<br>OBP: 0.275, SLG: 0.351   |   | 0-0<br>F7                       |                              |                                 | 0-0<br>E3                    |                                 | 0-0<br>P4                    |                                 |                              | 3 0 0 0 0 0 1                   |                              |                                 |                              |                                 |                              |                                 |                                  |                                    |                                  |        |
| <b>Dixie Howell, R</b> (1, 2)<br>OBP: 0.319, SLG: 0.288      |   | 0-3<br>K                        |                              |                                 | 0-0<br>F2                    |                                 | 0-0<br>F7                    |                                 |                              | 3 0 0 0 0 1 2                   |                              |                                 |                              |                                 |                              |                                 |                                  |                                    |                                  |        |
| <b>Ken Raffensberger, R</b> (1, 1)<br>OBP: 0.181, SLG: 0.203 |   |                                 | 0-0<br>5-3                   |                                 | 0-0<br>F7<br>2-3             |                                 |                              | 0-3<br>K                        |                              | 3 0 0 0 0 1 2                   |                              |                                 |                              |                                 |                              |                                 |                                  |                                    |                                  |        |
| <b>Inning Stats</b>  | R: 1<br>E: 2<br>K: 0<br>S: 5                          | H: 0<br>LOB: 1<br>BB: 0<br>P: 5 | R: 0<br>E: 0<br>K: 1<br>S: 5 | H: 0<br>LOB: 0<br>BB: 0<br>P: 5 | R: 0<br>E: 0<br>K: 0<br>S: 3 | H: 0<br>LOB: 0<br>BB: 0<br>P: 3 | R: 0<br>E: 0<br>K: 1<br>S: 5 | H: 0<br>LOB: 0<br>BB: 0<br>P: 5 | R: 1<br>E: 0<br>K: 1<br>S: 6 | H: 1<br>LOB: 0<br>BB: 0<br>P: 6 | R: 0<br>E: 0<br>K: 0<br>S: 3 | H: 0<br>LOB: 0<br>BB: 0<br>P: 3 | R: 0<br>E: 0<br>K: 1<br>S: 5 | H: 1<br>LOB: 1<br>BB: 1<br>P: 9 | R: 0<br>E: 0<br>K: 1<br>S: 5 | H: 0<br>LOB: 0<br>BB: 0<br>P: 5 | 1B: 1<br>2B: 1<br>3B: 0<br>HR: 1 | SF: 0<br>SAC: 0<br>DP: 0<br>HBP: 0 | WP: 1<br>PB: 0<br>SB: 0<br>CS: 1 | PA: 33 |
| <b>PITCHER</b>   | IP WLS BF H R ER SO BB IBB HBP BLK WP HR S P ERA WHIP |                                 |                              |                                 |                              |                                 |                              |                                 |                              |                                 |                              |                                 |                              |                                 |                              |                                 |                                  |                                    |                                  |        |
| <b>Jim Hearn, R</b> (1, 1)<br>ERA: 2.56                      | 7.0 L 26 2 2 1 3 0 0 0 0 1 1 32 32 1.29 0.286         |                                 |                              |                                 |                              |                                 |                              |                                 |                              |                                 |                              |                                 |                              |                                 |                              |                                 |                                  |                                    |                                  |        |
| <b>Monty Kennedy, L</b> (8, 1)<br>ERA: 4.63                  | 2.0 7 1 0 0 2 1 0 0 0 0 0 10 14 0.00 1.000            |                                 |                              |                                 |                              |                                 |                              |                                 |                              |                                 |                              |                                 |                              |                                 |                              |                                 |                                  |                                    |                                  |        |

Cincinnati Reds @ New York Giants  
Polo Grounds, New York, NY  
Wed Sep 20 1950, 3:38 AM EDT  
Att. 3,182 - Unknown

[livebaseballscorecards.com](http://livebaseballscorecards.com)

AB 32  
R 2  
H 3  
RBI 2  
BB 1  
SO 5  
LOB 11



BOTTOM

Cincinnati Reds @ New York Giants  
Polo Grounds, New York, NY  
Wed Sep 20 1950, 3:38 AM EDT  
Att. 3,182 - Unknown

livebaseballscorecards.com

|     |    |
|-----|----|
| AB  | 33 |
| R   | 0  |
| H   | 6  |
| RBI | 0  |
| BB  | 3  |
| SO  | 2  |
| LOB | 20 |



|     |   |     |    |
|-----|---|-----|----|
| WP: | 0 | PA: | 36 |
| PB: | 0 | SB: | 0  |
| CS: | 0 |     |    |

AB R H RBI BB SO LOB

4 0 0 0 0 0 2

4 0 1 0 0 0 0

4 0 1 0 0 0 1

4 0 2 0 0 0 1

4 0 2 0 0 0 1

4 0 2 0 0 0 1

3 0 0 0 1 1 4

2 0 0 0 0 0 2

1 0 0 0 0 1 1

0 0 0 0 0 0 0

1B: 5 SF: 0

2B: 1 SAC: 0

3B: 0 DP: 0

HR: 0 HBP: 0

| Batter   | 1               | 2              | 3              | 4               | 5                | 6                         | 7                      | 8               | 9 |
|--|-----------------|----------------|----------------|-----------------|------------------|---------------------------|------------------------|-----------------|---|
| Eddie Stanky, R<br>OBP: 0.460, SLG: 0.409<br>(1, 4) X  | 0-0<br>4-3<br>① |                | 0-0<br>F7<br>③ |                 |                  | 0-0<br>6-3<br>① X         | 0-0<br>FC5<br>③        |                 |   |
| Whitey Lockman, L<br>OBP: 0.356, SLG: 0.414<br>(1, 7) X  | 0-0<br>F8<br>②  |                |                | 0-0<br>P5<br>①  |                  | 0-0<br>F9<br>②            |                        | 0-0<br>1B       |   |
| Alvin Dark, R<br>OBP: 0.333, SLG: 0.451<br>(1, 6) X  | 0-0<br>5-3<br>③ |                |                | 0-0<br>F8<br>②  |                  | 0-0<br>1B<br>2B           |                        | 0-0<br>F7<br>①  |   |
| Monte Irvin, R<br>OBP: 0.394, SLG: 0.486<br>(1, 3)<br>(8, 9)   |                 | 0-0<br>1B      |                | 0-0<br>5-3<br>③ |                  | 0-0<br>FC6-4<br>1B<br>2-3 |                        | 0-0<br>P5<br>②  |   |
| Wes Westrum, R<br>OBP: 0.375, SLG: 0.453<br>Jack Maguire, R<br>OBP: 0.262, SLG: 0.237<br>Sal Yvars, R<br>(6, 2)  |                 | 0-0<br>P3<br>① |                |                 | 4-0<br>1B<br>BB  | 0-0<br>FC6-4<br>③         |                        | 0-0<br>4-3<br>③ |   |
| Bobby Thomson, R<br>OBP: 0.314, SLG: 0.413<br>(1, 8)   |                 | 0-0<br>F8<br>② |                |                 | 0-0<br>1-2<br>1B |                           | 0-0<br>FC5<br>BB<br>1B | 0-0<br>F5<br>①  |   |
| Hank Thompson, L<br>OBP: 0.388, SLG: 0.461<br>(1, 5)   |                 | 0-3<br>K<br>③  |                |                 | 0-0<br>F7<br>①   |                           | 0-0<br>F7<br>①         | 4-0<br>BB       |   |
| Don Mueller, L<br>OBP: 0.310, SLG: 0.365<br>Clint Hartung, R<br>OBP: 0.317, SLG: 0.575<br>Tookie Gilbert, L<br>OBP: 0.316, SLG: 0.310<br>Jack Lohrke, R<br>OBP: 0.250, SLG: 0.175<br>(9, PH) |                 |                | 0-0<br>F7<br>① |                 | 0-0<br>P4<br>②   |                           | 0-3<br>K<br>②          | 0-0<br>P5<br>②  |   |
| Jim Hearn, R<br>OBP: 0.190, SLG: 0.105<br>Bill Rigney, R<br>OBP: 0.271, SLG: 0.221<br>Monty Kennedy, R<br>OBP: 0.088, SLG: 0.061<br>Rudy Rufer, R<br>(9, PH)                                 |                 |                | 0-0<br>F3<br>② |                 | 0-0<br>P3<br>③   |                           | 4-0<br>BB<br>1-2       | 0-0<br>P6<br>③  |   |

| Inning Stats | R: 0 | H: 0 | E: 0 | K: 0 | S: 3 | R: 0 | H: 1 | E: 0 | K: 1 | S: 6 | R: 0 | H: 0 | E: 0 | K: 0 | S: 3 | R: 0 | H: 0 | E: 0 | K: 0 | S: 3 | R: 0 | H: 1 | E: 0 | K: 0 | S: 4 | R: 0 | H: 2 | E: 0 | K: 1 | S: 5 | R: 0 | H: 1 | E: 0 | K: 1 | S: 6 | R: 0 | H: 1 | E: 0 | K: 0 | S: 4 | R: 0 | H: 0 | E: 0 | K: 0 | S: 3 | 1B: 5 | 2B: 1 | 3B: 0 | HR: 0 | SF: 0 | SAC: 0 | DP: 0 | HBP: 0 | WP: 0 | PB: 0 | SB: 0 | CS: 0 | PA: 36 |
|--------------|------|------|------|------|------|------|------|------|------|------|------|------|------|------|------|------|------|------|------|------|------|------|------|------|------|------|------|------|------|------|------|------|------|------|------|------|------|------|------|------|------|------|------|------|------|-------|-------|-------|-------|-------|--------|-------|--------|-------|-------|-------|-------|--------|
|--------------|------|------|------|------|------|------|------|------|------|------|------|------|------|------|------|------|------|------|------|------|------|------|------|------|------|------|------|------|------|------|------|------|------|------|------|------|------|------|------|------|------|------|------|------|------|-------|-------|-------|-------|-------|--------|-------|--------|-------|-------|-------|-------|--------|

| PITCHER                                     | IP  | WLS | BF | H | R | ER | SO | BB | IBB | HBP | BLK | WP | HR | S  | P  | ERA  | WHIP  |
|---|-----|-----|----|---|---|----|----|----|-----|-----|-----|----|----|----|----|------|-------|
| Ken Raffensberger, L<br>ERA: 4.15<br>(1, 1) | 9.0 | W   | 36 | 6 | 0 | 0  | 2  | 3  | 0   | 0   | 0   | 0  | 0  | 37 | 49 | 0.00 | 1.000 |

| Batter   | 1   | 2                               | 3                            | 4                               | 5                            | 6                               | 7                            | 8                                  | 9                            | AB R H RBI BB SO LOB            | TOP                          |                                 |                              |                                 |                              |                                  |                                   |                                    |                                  |        |
|--|---|---------------------------------|------------------------------|---------------------------------|------------------------------|---------------------------------|------------------------------|------------------------------------|------------------------------|---------------------------------|------------------------------|---------------------------------|------------------------------|---------------------------------|------------------------------|----------------------------------|-----------------------------------|------------------------------------|----------------------------------|--------|
| <b>Bobby Adams, R</b> (1, 4)<br>OBP: 0.369, SLG: 0.422     | 0-0<br>F8   |                                 | 0-0<br>E5<br>1B              | 4-0<br>1B<br>E<br>BB            |                              | 0-0<br>5-3                      |                              | 0-0<br>1-3                         |                              | 4 2 0 0 1 0 1                   |                              |                                 |                              |                                 |                              |                                  |                                   |                                    |                                  |        |
| <b>Grady Hatton, L</b> (1, 5)<br>OBP: 0.365, SLG: 0.382    | 0-0<br>G4-6-3<br>1B                                   |                                 | 0-0<br>1B<br>1-2<br>3-H      | 0-0<br>1B<br>E<br>1B            |                              | 0-0<br>F2                       |                              | 0-0<br>F8                          | 5 1 3 3 0 0 0                |                                 |                              |                                 |                              |                                 |                              |                                  |                                   |                                    |                                  |        |
| <b>Johnny Wyrostek, L</b> (1, 9)<br>OBP: 0.375, SLG: 0.439 | 0-0<br>G4-6-3<br>1-2f                                 |                                 | 0-0<br>1B<br>1-3<br>2-H      | 0-0<br>E3<br>1B                 |                              |                                 | 0-0<br>1B<br>F7<br>1B        | 0-0<br>BB<br>1B                    | 5 1 3 1 0 0 2                |                                 |                              |                                 |                              |                                 |                              |                                  |                                   |                                    |                                  |        |
| <b>Ted Kluszewski, L</b> (1, 3)<br>OBP: 0.353, SLG: 0.533  |   | 0-0<br>F2                       | 0-0<br>F8                    | 0-0<br>1B<br>1-2<br>2-H         |                              |                                 | 0-0<br>FC5-4<br>1B           | 0-0<br>F5                          | 5 0 2 1 0 0 3                |                                 |                              |                                 |                              |                                 |                              |                                  |                                   |                                    |                                  |        |
| <b>Lloyd Merriman, L</b> (1, 8)<br>OBP: 0.326, SLG: 0.339  |   | 0-0<br>CS<br>1B                 |                              | 0-0<br>FC1-6<br>1B              |                              |                                 | 0-0<br>F7                    | 4-0<br>BB<br>BB<br>BB<br>1-2<br>BB | 4 0 2 1 1 0 3                |                                 |                              |                                 |                              |                                 |                              |                                  |                                   |                                    |                                  |        |
| <b>Joe Adcock, R</b> (1, 7)<br>OBP: 0.310, SLG: 0.387      |   |                                 |                              | 0-0<br>FC1-6<br>2B<br>SH1-3     |                              |                                 | 0-0<br>FC5-4                 | 0-3<br>SS<br>SS<br>SS<br>K         | 4 1 0 0 0 0 3                |                                 |                              |                                 |                              |                                 |                              |                                  |                                   |                                    |                                  |        |
| <b>Ted Tappe, L</b> (9, PH)<br>OBP: 0.333, SLG: 1.333      | 5-3   |                                 |                              | 0-0<br>SH1-3                    |                              | 5-3                             |                              |                                    | 1 0 0 0 0 1 2                |                                 |                              |                                 |                              |                                 |                              |                                  |                                   |                                    |                                  |        |
| <b>Bob Usher, R</b> (9, 7)<br>OBP: 0.305, SLG: 0.344       | 1-2   |                                 |                              | 0-0<br>SH1-3<br>1B<br>2B        |                              |                                 | 1-2f                         |                                    | 0 0 0 0 0 0 0                |                                 |                              |                                 |                              |                                 |                              |                                  |                                   |                                    |                                  |        |
| <b>Virgil Stallcup, R</b> (1, 6)<br>OBP: 0.274, SLG: 0.353 |   |                                 | 0-0<br>F7                    | 0-0<br>SH1-3<br>1B<br>2B        |                              | 0-0<br>F7                       |                              | 0-0<br>F7                          | 4 1 1 0 0 0 1                |                                 |                              |                                 |                              |                                 |                              |                                  |                                   |                                    |                                  |        |
| <b>Dixie Howell, R</b> (1, 2)<br>OBP: 0.322, SLG: 0.293    |   |                                 | 0-0<br>E<br>1B<br>2B         | 4-0<br>SH1-3<br>1B<br>BB        |                              | 0-0<br>1-3                      |                              | 0-0<br>F5                          | 3 2 1 0 1 0 0                |                                 |                              |                                 |                              |                                 |                              |                                  |                                   |                                    |                                  |        |
| <b>Howie Fox, R</b> (1, 1)<br>OBP: 0.211, SLG: 0.255       |   |                                 | 0-3<br>K                     | 0-0<br>SH1-3                    |                              |                                 |                              | 0-0<br>1-3                         | 3 0 0 1 0 1 1                |                                 |                              |                                 |                              |                                 |                              |                                  |                                   |                                    |                                  |        |
| <b>Frank Smith, R</b> (8, 1)<br>OBP: 0.100, SLG: 0.100     |   |                                 | 0-0<br>K                     | 1-2<br>2-3<br>3-H               |                              | 0-0<br>5-3                      |                              |                                    | 0 0 0 0 0 0 0                |                                 |                              |                                 |                              |                                 |                              |                                  |                                   |                                    |                                  |        |
| <b>Inning Stats</b>  | R: 0<br>E: 0<br>K: 0<br>S: 3                          | H: 1<br>LOB: 0<br>BB: 0<br>P: 3 | R: 0<br>E: 0<br>K: 0<br>S: 3 | H: 1<br>LOB: 0<br>BB: 0<br>P: 3 | R: 2<br>E: 1<br>K: 1<br>S: 9 | H: 3<br>LOB: 2<br>BB: 0<br>P: 9 | R: 5<br>E: 1<br>K: 0<br>S: 8 | H: 4<br>LOB: 2<br>BB: 2<br>P: 16   | R: 0<br>E: 0<br>K: 0<br>S: 3 | H: 0<br>LOB: 0<br>BB: 0<br>P: 3 | R: 1<br>E: 0<br>K: 0<br>S: 5 | H: 2<br>LOB: 1<br>BB: 0<br>P: 5 | R: 0<br>E: 0<br>K: 0<br>S: 3 | H: 0<br>LOB: 0<br>BB: 0<br>P: 3 | R: 0<br>E: 0<br>K: 1<br>S: 6 | H: 1<br>LOB: 2<br>BB: 1<br>P: 10 | 1B: 10<br>2B: 2<br>3B: 0<br>HR: 0 | SF: 0<br>SAC: 1<br>DP: 1<br>HBP: 0 | WP: 0<br>PB: 0<br>SB: 0<br>CS: 1 | PA: 42 |
| <b>PITCHER</b>   | IP WLS BF H R ER SO BB IBB HBP BLK WP HR S P ERA WHIP |                                 |                              |                                 |                              |                                 |                              |                                    |                              |                                 |                              |                                 |                              |                                 |                              |                                  |                                   |                                    |                                  |        |
| <b>Sal Maglie, R</b> (1, 1)<br>ERA: 2.75                   | 3.2 L 20 8 7 3 1 2 0 0 0 0 0 0 20 28 7.36 2.727       |                                 |                              |                                 |                              |                                 |                              |                                    |                              |                                 |                              |                                 |                              |                                 |                              |                                  |                                   |                                    |                                  |        |
| <b>Monty Kennedy, L</b> (4, 1)<br>ERA: 4.61                | 0.1 3 1 0 0 0 0 0 0 0 0 0 0 3 3 0.00 3.000            |                                 |                              |                                 |                              |                                 |                              |                                    |                              |                                 |                              |                                 |                              |                                 |                              |                                  |                                   |                                    |                                  |        |
| <b>George Spencer, R</b> (5, 1)<br>ERA: 2.61               | 3.0 11 2 1 1 0 0 0 0 0 0 0 0 11 11 3.00 0.667         |                                 |                              |                                 |                              |                                 |                              |                                    |                              |                                 |                              |                                 |                              |                                 |                              |                                  |                                   |                                    |                                  |        |
| <b>Jack Kramer, R</b> (8, 1)<br>ERA: 3.44                  | 2.0 8 1 0 0 1 1 0 0 0 0 0 0 9 13 0.00 1.000           |                                 |                              |                                 |                              |                                 |                              |                                    |                              |                                 |                              |                                 |                              |                                 |                              |                                  |                                   |                                    |                                  |        |

Cincinnati Reds @ New York Giants  
Polo Grounds, New York, NY  
Thu Sep 21 1950, 3:33 AM EDT  
Att. 3,996 - Unknown

livebaseballscorecards.com

|     |    |
|-----|----|
| AB  | 38 |
| R   | 8  |
| H   | 12 |
| RBI | 7  |
| BB  | 3  |
| SO  | 2  |
| LOB | 16 |



| Batter   | 1       | 2             | 3             | 4                 | 5       | 6       | 7       | 8                   | 9       | AB | R | H | RBI | BB | SO | LOB |
|--|---------|---------------|---------------|-------------------|---------|---------|---------|---------------------|---------|----|---|---|-----|----|----|-----|
| <b>Eddie Stanky, R</b><br>OBP: 0.458, SLG: 0.406 (1, 4)    | 0-0 P5  |               | 0-0 F9        |                   | 0-0 F9  |         | 0-0 6-3 |                     | 1-0 HBP | 4  | 0 | 0 | 0   | 0  | 0  | 0   |
| <b>Whitey Lockman, L</b><br>OBP: 0.355, SLG: 0.412 (1, 7)  | 0-0 F9  |               | 0-0 F8        |                   | 0-0 4-3 |         |         | 0-0 BB<br>3B 1B     | 0-3 K   | 5  | 1 | 1 | 0   | 0  | 1  | 1   |
| <b>Alvin Dark, R</b><br>OBP: 0.332, SLG: 0.448 (1, 6)      | 0-0 5-3 |               | 0-0 E5<br>1B  |                   | 4-0 BB  |         |         | 0-3 K               | 0-0 4-3 | 4  | 0 | 0 | 0   | 1  | 1  | 2   |
| <b>Hank Thompson, L</b><br>OBP: 0.389, SLG: 0.460 (1, 5)   |         | 0-0 1-3       | 0-0 1-3<br>1B |                   | 0-0 G3  |         |         | 4-0 BB<br>1-2 3B BB |         | 3  | 1 | 1 | 0   | 1  | 0  | 1   |
| <b>Monte Irvin, R</b><br>OBP: 0.395, SLG: 0.502 (1, 3)     |         | 0-0 HR        | 0-0 L6        |                   |         | 0-0 4-3 |         | 0-0 1-H<br>2-H 3B   |         | 4  | 2 | 2 | 3   | 0  | 0  | 2   |
| <b>Bobby Thomson, R</b><br>OBP: 0.314, SLG: 0.411 (1, 8)   |         | 0-0 6-3       |               | 0-0 4-3<br>1-3 1B |         | 0-0 F8  |         | 0-0 F8              |         | 4  | 0 | 1 | 1   | 0  | 0  | 0   |
| <b>Don Mueller, L</b><br>OBP: 0.312, SLG: 0.372 (1, 9)     |         | 0-0 1B<br>1B  |               | 0-0 1-3<br>1-2 1B |         | 0-0 F7  |         | 0-0 3-H<br>HR       |         | 4  | 1 | 2 | 1   | 0  | 0  | 1   |
| <b>Sal Yvars, R</b><br>OBP: 0.167, SLG: 0.091 (1, 2)       |         | 0-0 1-3<br>1B |               | 0-0 4-3<br>2-3 1B |         | 0-0 F7  | 0-0 6-3 | 0-0 5-3             |         | 4  | 0 | 1 | 0   | 0  | 0  | 1   |
| <b>Sal Maglie, R</b><br>OBP: 0.180, SLG: 0.194 (1, 1)      |         | 0-0 1-3       |               | 0-3 K             |         | 0-3 K   |         |                     | 0-0 4-3 | 1  | 0 | 0 | 0   | 0  | 0  | 2   |
| <b>Monty Kennedy, R</b><br>OBP: 0.088, SLG: 0.061 (4, 1)   |         |               |               |                   |         |         |         |                     |         | 0  | 0 | 0 | 0   | 0  | 0  | 0   |
| <b>Bill Riney, R</b><br>OBP: 0.267, SLG: 0.218 (4, PH)     |         |               |               |                   |         |         |         |                     |         | 1  | 0 | 0 | 0   | 0  | 1  | 1   |
| <b>George Spencer, R</b><br>OBP: 0.267, SLG: 0.218 (5, 1)  |         |               |               |                   |         |         |         |                     |         | 0  | 0 | 0 | 0   | 0  | 0  | 0   |
| <b>Roy Weatherly, L</b><br>OBP: 0.266, SLG: 0.409 (7, PH)  |         |               |               |                   |         |         |         |                     |         | 1  | 0 | 0 | 0   | 0  | 1  | 0   |
| <b>Jack Kramer, R</b><br>OBP: 0.326, SLG: 0.250 (8, 1)     |         |               |               |                   |         |         |         |                     |         | 0  | 0 | 0 | 0   | 0  | 0  | 0   |
| <b>Tookie Gilbert, L</b><br>OBP: 0.315, SLG: 0.309 (9, PH) |         |               |               |                   |         |         |         |                     |         | 1  | 0 | 0 | 0   | 0  | 0  | 0   |

| Inning Stats | R: 0 | H: 0 | E: 0 | K: 0 | S: 3 | R: 1 | H: 3 | E: 0 | K: 0 | S: 6 | R: 0 | H: 1 | E: 1 | K: 0 | S: 5 | R: 0 | H: 0 | E: 0 | K: 0 | S: 3 | R: 0 | H: 0 | E: 0 | K: 1 | S: 5 | R: 0 | H: 0 | E: 0 | K: 1 | S: 5 | R: 4 | H: 3 | E: 0 | K: 1 | S: 8 | R: 0 | H: 0 | E: 0 | K: 1 | S: 5 | R: 0 | H: 0 | E: 0 | K: 1 | S: 6 | 1B: 5 | SF: 0 | 2B: 0 | 3B: 1 | HR: 2 | WP: 0 | PA: 39 |
|--------------|------|------|------|------|------|------|------|------|------|------|------|------|------|------|------|------|------|------|------|------|------|------|------|------|------|------|------|------|------|------|------|------|------|------|------|------|------|------|------|------|------|------|------|------|------|-------|-------|-------|-------|-------|-------|--------|
|--------------|------|------|------|------|------|------|------|------|------|------|------|------|------|------|------|------|------|------|------|------|------|------|------|------|------|------|------|------|------|------|------|------|------|------|------|------|------|------|------|------|------|------|------|------|------|-------|-------|-------|-------|-------|-------|--------|

| PITCHER                                   | IP  | WLS | BF | H | R | ER | SO | BB | IBB | HBP | BLK | WP | HR | S  | P  | ERA  | WHIP  |
|---|-----|-----|----|---|---|----|----|----|-----|-----|-----|----|----|----|----|------|-------|
| <b>Howie Fox, R</b><br>ERA: 4.42 (1, 1)   | 7.2 | W   | 34 | 8 | 5 | 5  | 3  | 2  | 0   | 0   | 0   | 0  | 2  | 38 | 46 | 5.87 | 1.304 |
| <b>Frank Smith, R</b><br>ERA: 3.72 (8, 1) | 1.1 | S   | 5  | 0 | 0 | 0  | 1  | 0  | 0   | 1   | 0   | 0  | 0  | 6  | 7  | 0.00 | 0.000 |

**BOTTOM**

**Cincinnati Reds @ New York Giants**

**Polo Grounds, New York, NY**

Thu Sep 21 1950, 3:33 AM EDT  
Att: 3,996 - Unknown

livebaseballscorecards.com

|            |           |
|------------|-----------|
| <b>AB</b>  | <b>36</b> |
| <b>R</b>   | <b>5</b>  |
| <b>H</b>   | <b>8</b>  |
| <b>RBI</b> | <b>5</b>  |
| <b>BB</b>  | <b>2</b>  |
| <b>SO</b>  | <b>4</b>  |
| <b>LOB</b> | <b>11</b> |



| Batter  | 1   | 2                               | 3   | 4                               | 5                            | 6                               | 7                            | 8                               | 9                            | 10                              | AB R H RBI BB SO LOB         | TOP   |                              |                                 |                              |                                 |                              |                                  |                                  |                                    |                                  |        |
|---|---|---------------------------------|---|---------------------------------|------------------------------|---------------------------------|------------------------------|---------------------------------|------------------------------|---------------------------------|------------------------------|---|------------------------------|---------------------------------|------------------------------|---------------------------------|------------------------------|----------------------------------|----------------------------------|------------------------------------|----------------------------------|--------|
| <b>Bobby Adams, R</b> (1, 4)<br>OBP: 0.372, SLG: 0.426      | 0-0<br>F4   |                                 | 0-0<br>2B   |                                 | 0-0<br>1B                    |                                 |                              | 4-0<br>1B BB                    | 0-0<br>F9                    |                                 | 4 1 2 0 1 0 2                | <b>Cincinnati Reds @ Pittsburgh Pirates</b><br>Forbes Field, Pittsburgh, PA<br>Fri Sep 22 1950, 3:33 AM EDT<br>Att: 12,979 - Unknown - 70 F |                              |                                 |                              |                                 |                              |                                  |                                  |                                    |                                  |        |
| <b>Bob Usher, R</b> (1, 8)<br>OBP: 0.309, SLG: 0.359        | 0-0<br>1B   |                                 | 0-0<br>F3   |                                 | 0-0<br>F2                    |                                 |                              | 0-0<br>1B 1B                    | 0-0<br>HR                    |                                 | 5 2 3 3 0 0 2                |   |                              |                                 |                              |                                 |                              |                                  |                                  |                                    |                                  |        |
| <b>Johnny Wyrostek, L</b> (1, 9)<br>OBP: 0.371, SLG: 0.435  | 0-0<br>F8   |                                 | 0-0<br>4-3  |                                 |                              |                                 |                              | 0-0<br>F5                       | 0-0<br>6-3                   |                                 | 5 0 0 0 0 0 4                |   |                              |                                 |                              |                                 |                              |                                  |                                  |                                    |                                  |        |
| <b>Ted Kluszewski, L</b> (1, 3)<br>OBP: 0.354, SLG: 0.532   | 0-0<br>1-3  |                                 |   | 0-0<br>4-3                      |                              |                                 |                              | 0-0<br>1B                       |                              | 0-0<br>SH3-4                    | 5 1 2 1 0 0 1                |   |                              |                                 |                              |                                 |                              |                                  |                                  |                                    |                                  |        |
| <b>Joe Adcock, R</b> (1, 7)<br>OBP: 0.309, SLG: 0.388       |   | 0-0<br>5-3                      |   | 0-0<br>2B                       |                              |                                 |                              | 0-0<br>F8                       |                              | 0-0<br>SH3-4                    | 4 0 1 1 0 0 1                |   |                              |                                 |                              |                                 |                              |                                  |                                  |                                    |                                  |        |
| <b>Johnny Pramesa, R</b> (1, 2)<br>OBP: 0.369, SLG: 0.442   |   | 0-0<br>F7                       |   | 0-3<br>K                        |                              |                                 |                              | 0-0<br>F9                       |                              | 0-0<br>2B CS                    | 5 0 1 0 0 1 2                |   |                              |                                 |                              |                                 |                              |                                  |                                  |                                    |                                  |        |
| <b>Connie Ryan, R</b> (10, PR)<br>OBP: 0.349, SLG: 0.361    |   |                                 |   |                                 |                              |                                 |                              | 0-0<br>F7                       |                              | 2-3<br>1B                       | 0 0 0 0 0 0 0                |   |                              |                                 |                              |                                 |                              |                                  |                                  |                                    |                                  |        |
| <b>Dixie Howell, R</b> (10, 2)<br>OBP: 0.322, SLG: 0.293    |   |                                 |   |                                 |                              |                                 |                              |                                 |                              |                                 | 0 0 0 0 0 0 0                |   |                              |                                 |                              |                                 |                              |                                  |                                  |                                    |                                  |        |
| <b>Grady Hatton, L</b> (1, 5)<br>OBP: 0.363, SLG: 0.382     |   | 0-0<br>F8                       |   | 0-0<br>3-1                      |                              |                                 |                              | 0-0<br>4-3                      |                              | 0-0<br>2B                       | 5 0 1 1 0 0 1                |   |                              |                                 |                              |                                 |                              |                                  |                                  |                                    |                                  |        |
| <b>Virgil Stallcup, R</b> (1, 6)<br>OBP: 0.280, SLG: 0.363  |   |                                 | 0-0<br>HR   |                                 | 0-0<br>F8                    |                                 |                              | 0-0<br>1B                       |                              | 0-0<br>HR                       | 4 2 3 1 1 0 0                |   |                              |                                 |                              |                                 |                              |                                  |                                  |                                    |                                  |        |
| <b>Willie Ramsdell, R</b> (1, 1)<br>OBP: 0.259, SLG: 0.200  |   |                                 | 0-0<br>6-3  |                                 | 0-3<br>K                     |                                 |                              | 0-0<br>F8                       |                              | 0-3<br>K                        | 0 0 0 0 0 0 0                |   |                              |                                 |                              |                                 |                              |                                  |                                  |                                    |                                  |        |
| <b>Howie Fox, R</b> (3, PH)<br>OBP: 0.207, SLG: 0.250       |   |                                 |   |                                 |                              |                                 |                              |                                 |                              |                                 | 1 0 0 0 0 0 0                |   |                              |                                 |                              |                                 |                              |                                  |                                  |                                    |                                  |        |
| <b>Bud Byerly, R</b> (3, 1)                                 |   |                                 |   |                                 |                              |                                 |                              |                                 |                              |                                 | 1 0 0 0 0 1 0                |   |                              |                                 |                              |                                 |                              |                                  |                                  |                                    |                                  |        |
| <b>Danny Litwhiler, R</b> (7, PH)<br>OBP: 0.378, SLG: 0.467 |   |                                 |   |                                 |                              |                                 |                              |                                 |                              |                                 | 1 0 0 0 0 0 1                |   |                              |                                 |                              |                                 |                              |                                  |                                  |                                    |                                  |        |
| <b>Eddie Erskine, R</b> (7, 1)<br>OBP: 0.231, SLG: 0.250    |   |                                 |   |                                 |                              |                                 |                              |                                 |                              |                                 | 0 0 0 0 0 0 0                |   |                              |                                 |                              |                                 |                              |                                  |                                  |                                    |                                  |        |
| <b>Sammy Miesicki, R</b> (9, PH)<br>OBP: 0.320, SLG: 0.370  |   |                                 |   |                                 |                              |                                 |                              |                                 |                              |                                 | 1 1 1 0 0 0 0                |   |                              |                                 |                              |                                 |                              |                                  |                                  |                                    |                                  |        |
| <b>Frank Smith, R</b> (9, 1)<br>OBP: 0.095, SLG: 0.095      |   |                                 |   |                                 |                              |                                 |                              |                                 |                              |                                 | 1 0 0 0 0 1 3                |   |                              |                                 |                              |                                 |                              |                                  |                                  |                                    |                                  |        |
| <b>Inning Stats</b>   | R: 0<br>E: 0<br>K: 0<br>S: 4                          | H: 1<br>LOB: 1<br>BB: 0<br>P: 4 | R: 0<br>E: 0<br>K: 0<br>S: 3  | H: 0<br>LOB: 0<br>BB: 0<br>P: 3 | R: 1<br>E: 0<br>K: 0<br>S: 5 | H: 2<br>LOB: 1<br>BB: 0<br>P: 5 | R: 0<br>E: 0<br>K: 1<br>S: 6 | H: 1<br>LOB: 1<br>BB: 0<br>P: 6 | R: 0<br>E: 0<br>K: 0<br>S: 3 | H: 0<br>LOB: 0<br>BB: 0<br>P: 3 | R: 0<br>E: 0<br>K: 0<br>S: 4 | H: 1<br>LOB: 1<br>BB: 0<br>P: 4   | R: 2<br>E: 0<br>K: 0<br>S: 5 | H: 2<br>LOB: 1<br>BB: 1<br>P: 9 | R: 3<br>E: 0<br>K: 0<br>S: 6 | H: 3<br>LOB: 0<br>BB: 0<br>P: 6 | R: 1<br>E: 0<br>K: 1<br>S: 7 | H: 3<br>LOB: 2<br>BB: 1<br>P: 11 | 1B: 9<br>2B: 3<br>3B: 0<br>HR: 2 | SF: 0<br>SAC: 1<br>DP: 0<br>HBP: 0 | WP: 0<br>PB: 0<br>SB: 0<br>CS: 1 | PA: 45 |
| <b>PITCHER</b>  | IP WLS BF H R ER SO BB IBB HBP BLK WP HR S P ERA WHIP |                                 |   |                                 |                              |                                 |                              |                                 |                              |                                 |                              |   |                              |                                 |                              |                                 |                              |                                  |                                  |                                    |                                  |        |
| <b>Cliff Chambers, L</b> (1, 1)<br>ERA: 4.42                | 9.0   | W 39                            | H 11 R 6 ER 6 SO 2 BB 1 IBB 0 HBP 0 BLK 0 WP 0 HR 2 S 42 P 46 ERA 6.00 WHIP 1.333 |                                 |                              |                                 |                              |                                 |                              |                                 |                              |   |                              |                                 |                              |                                 |                              |                                  |                                  |                                    |                                  |        |
| <b>Junior Walsh, R</b> (10, 1)<br>ERA: 5.53                 | 1.0   | W 6                             | H 3 R 1 ER 1 SO 1 BB 0 IBB 0 HBP 0 BLK 0 WP 0 HR 0 S 7 P 11 ERA 9.00 WHIP 3.000   |                                 |                              |                                 |                              |                                 |                              |                                 |                              |   |                              |                                 |                              |                                 |                              |                                  |                                  |                                    |                                  |        |

livebaseballscorecards.com

AB 42  
R 7  
H 14  
RBI 7  
BB 2  
SO 3  
LOB 17



| Batter  | 1   | 2                    | 3   | 4           | 5              | 6   | 7  | 8   | 9   | 10                 | AB | R | H | RBI | BB | SO | LOB |
|---|-----|----------------------|-----|-------------|----------------|-----|----|-----|-----|--------------------|----|---|---|-----|----|----|-----|
| Bob Dillinger, R (1.5)<br>OBP: 0.357, SLG: 0.418  | K   | CS<br>1B             |     | FC6-4       |                | K   |    | 4-3 |     |                    | 5  | 0 | 1 | 0   | 0  | 2  | 2   |
| Tom Saffell, L (1.8)<br>OBP: 0.262, SLG: 0.272  | F1  | CS                   | F7  | 4-3         |                | 4-3 |    |     | K   |                    | 5  | 0 | 0 | 0   | 0  | 1  | 2   |
| Ralph Kiner, R (1.7)<br>OBP: 0.414, SLG: 0.600  | 5-3 |                      | 4-3 |             | BB<br>1B<br>BB |     | F3 |     | F4  |                    | 4  | 1 | 0 | 0   | 1  | 0  | 0   |
| Gus Bell, L (1.9)<br>OBP: 0.335, SLG: 0.448   |     | PB<br>1B<br>BB       |     |             | F7             |     |    |     | 4-3 |                    | 4  | 1 | 2 | 0   | 1  | 0  | 1   |
| Danny O'Connell, R (1.6)<br>OBP: 0.352, SLG: 0.430  |     | 1B<br>PB<br>HR<br>1B | 5-3 |             | 1B<br>BB       |     | 1B |     |     | SH1-5-4<br>S<br>1B | 4  | 2 | 3 | 0   | 1  | 0  | 1   |
| Jack Phillips, R (1.3)<br>OBP: 0.337, SLG: 0.418  |     |                      | 6-3 |             | HR             |     | K  |     |     | SH1-5-4<br>1B      | 5  | 2 | 3 | 1   | 0  | 1  | 4   |
| Johnny Berardino, R (1.4)<br>OBP: 0.295, SLG: 0.248   |     | HR<br>1B             |     | FC6-4<br>BB |                |     |    | 4-3 |     | SH1-5-4            | 3  | 1 | 2 | 2   | 1  | 0  | 2   |
| Clyde McCullough, R (1.2)<br>OBP: 0.337, SLG: 0.403<br>Wally Westlake, R (10, PH)<br>OBP: 0.358, SLG: 0.486 | K   |                      |     | FC6-4<br>1B |                | F3  |    | F8  |     |                    | 4  | 0 | 0 | 0   | 0  | 1  | 5   |
| Cliff Chambers, L (1.1)<br>OBP: 0.330, SLG: 0.402<br>Junior Walsh, R (10, 1)<br>OBP: 0.444, SLG: 0.333      |     | HR                   |     | FC6-4<br>1B |                | 4-3 |    | K   |     |                    | 1  | 0 | 1 | 2   | 0  | 0  | 0   |

| Inning Stats | R: 0 | H: 0 | E: 0 | K: 1 | S: 5 | H: 0 | LOB: 0 | BB: 0 | P: 5 | R: 4 | H: 4 | E: 0 | K: 1 | S: 8 | H: 1 | LOB: 1 | BB: 0 | P: 4 | R: 0 | H: 1 | E: 0 | K: 0 | S: 4 | R: 1 | H: 2 | E: 0 | K: 0 | S: 5 | H: 1 | LOB: 1 | BB: 2 | P: 14 | R: 0 | H: 0 | E: 0 | K: 1 | S: 5 | H: 3 | LOB: 2 | BB: 0 | P: 5 | R: 0 | H: 0 | E: 0 | K: 1 | S: 5 | H: 0 | LOB: 0 | BB: 0 | P: 5 | R: 0 | H: 0 | E: 0 | K: 1 | S: 5 | R: 0 | H: 0 | E: 0 | K: 1 | S: 5 | R: 2 | H: 3 | E: 0 | K: 0 | S: 4 | H: 1 | LOB: 1 | BB: 0 | P: 4 | 1B: 11 | SF: 0 | 2B: 0 | SAC: 1 | 3B: 1 | DP: 0 | HR: 2 | HBP: 0 | WP: 0 | PA: 45 |
|--------------|------|------|------|------|------|------|--------|-------|------|------|------|------|------|------|------|--------|-------|------|------|------|------|------|------|------|------|------|------|------|------|--------|-------|-------|------|------|------|------|------|------|--------|-------|------|------|------|------|------|------|------|--------|-------|------|------|------|------|------|------|------|------|------|------|------|------|------|------|------|------|------|--------|-------|------|--------|-------|-------|--------|-------|-------|-------|--------|-------|--------|
|--------------|------|------|------|------|------|------|--------|-------|------|------|------|------|------|------|------|--------|-------|------|------|------|------|------|------|------|------|------|------|------|------|--------|-------|-------|------|------|------|------|------|------|--------|-------|------|------|------|------|------|------|------|--------|-------|------|------|------|------|------|------|------|------|------|------|------|------|------|------|------|------|------|--------|-------|------|--------|-------|-------|--------|-------|-------|-------|--------|-------|--------|

| PITCHER                               | IP  | WLS | BF | H | R | ER | SO | BB | IBB | HBP | BLK | WP | HR | S  | P  | ERA   | WHIP  |
|---------------------------------------|-----|-----|----|---|---|----|----|----|-----|-----|-----|----|----|----|----|-------|-------|
| Willie Ramsdell, R (1.1)<br>ERA: 3.93 | 2.0 |     | 10 | 4 | 4 | 4  | 2  | 1  | 0   | 0   | 0   | 0  | 1  | 13 | 17 | 18.00 | 2.500 |
| Bud Byerly, R (3.1)<br>ERA: 3.6       | 4.0 |     | 19 | 4 | 2 | 2  | 2  | 3  | 0   | 0   | 0   | 0  | 1  | 20 | 32 | 4.50  | 1.750 |
| Eddie Erault, R (7.1)<br>ERA: 6.1     | 2.0 |     | 8  | 3 | 0 | 0  | 1  | 0  | 0   | 0   | 0   | 0  | 0  | 10 | 10 | 0.00  | 1.500 |
| Frank Smith, R (9.1)<br>ERA: 3.87     | 1.1 | L   | 7  | 3 | 2 | 2  | 1  | 0  | 0   | 0   | 0   | 0  | 0  | 9  | 9  | 13.50 | 2.250 |

**BOTTOM**

**Cincinnati Reds @ Pittsburgh Pirates**  
**Forbes Field, Pittsburgh, PA**  
 Fri Sep 22 1950, 3:33 AM EDT  
 Att. 12,979 - Unknown - 70 F

|            |           |
|------------|-----------|
| <b>AB</b>  | <b>39</b> |
| <b>R</b>   | <b>8</b>  |
| <b>H</b>   | <b>14</b> |
| <b>RBI</b> | <b>8</b>  |
| <b>BB</b>  | <b>4</b>  |
| <b>SO</b>  | <b>6</b>  |
| <b>LOB</b> | <b>17</b> |



| Batter   | 1   | 2                               | 3                            | 4                               | 5                            | 6                               | 7                            | 8                               | 9                            | AB R H RBI BB SO LOB  | TOP                          |                                 |                              |                                 |                              |                                  |                                  |                                    |                                  |        |
|--|---|---------------------------------|------------------------------|---------------------------------|------------------------------|---------------------------------|------------------------------|---------------------------------|------------------------------|---|------------------------------|---------------------------------|------------------------------|---------------------------------|------------------------------|----------------------------------|----------------------------------|------------------------------------|----------------------------------|--------|
| <b>Bobby Adams, R</b> (1, 4)<br>OBP: 0.373, SLG: 0.427   | 0-0<br>3-1<br>FC1<br>2B                               |                                 | 0-0<br>5-3                   | 0-3<br>K                        |                              | 0-0<br>F2                       |                              |                                 | 4-0<br>1B<br>FC4-6<br>BB     | 4 2 1 0 1 1 2   |                              |                                 |                              |                                 |                              |                                  |                                  |                                    |                                  |        |
| <b>Grady Hatton, L</b> (1, 5)<br>OBP: 0.366, SLG: 0.383  | 0-0<br>3-1  |                                 | 0-0<br>1B                    |                                 | 4-0<br>G3<br>1B<br>BB        |                                 | 0-0<br>F9                    |                                 | 0-0<br>FC4-6<br>1B           | 4 1 2 2 1 0 1   |                              |                                 |                              |                                 |                              |                                  |                                  |                                    |                                  |        |
| <b>Johnny Wyrostek, L</b> (1, 9)<br>OBP: 0.369, SLG: 0.432   | 0-0<br>FC1<br>FC4-6                                   |                                 | 0-0<br>F8                    |                                 | 0-0<br>G3                    |                                 | 0-0<br>L4-3<br>1B            |                                 | 0-0<br>FC4-6<br>BB           | 5 0 1 2 0 0 3   |                              |                                 |                              |                                 |                              |                                  |                                  |                                    |                                  |        |
| <b>Ted Kluszewski, L</b> (1, 3)<br>OBP: 0.354, SLG: 0.530  | 0-0<br>FC4-6  |                                 | 0-0<br>F8                    |                                 | 0-0<br>FC6-4<br>1B           |                                 | 0-0<br>L4-3                  |                                 | 4-0<br>BB                    | 4 0 1 1 1 0 3   |                              |                                 |                              |                                 |                              |                                  |                                  |                                    |                                  |        |
| <b>Lloyd Merriman, L</b> (1, 8)<br>OBP: 0.325, SLG: 0.342<br><b>Bob Usher, R</b> (9, PH)<br>OBP: 0.308, SLG: 0.357   | 0-0<br>4-3  |                                 |                              | 0-0<br>1B<br>2B                 |                              | 0-0<br>F9                       |                              | 0-3<br>K                        | 0-0<br>F1                    | 4 1 1 0 0 1 2<br>1 0 0 0 0 0 1  |                              |                                 |                              |                                 |                              |                                  |                                  |                                    |                                  |        |
| <b>Joe Adcock, R</b> (1, 7)<br>OBP: 0.311, SLG: 0.392  |   | 0-0<br>2B                       |                              | 0-0<br>2B<br>1B                 |                              | 0-0<br>FC6-4                    |                              | 0-0<br>1-4-3                    |                              | 4 1 2 1 0 0 1   |                              |                                 |                              |                                 |                              |                                  |                                  |                                    |                                  |        |
| <b>Virgil Stallcup, R</b> (1, 6)<br>OBP: 0.280, SLG: 0.364   |   | 0-3<br>K                        |                              | 0-0<br>F4<br>2B                 |                              | 0-0<br>F8                       |                              | 0-0<br>F2                       |                              | 4 0 1 0 0 1 1   |                              |                                 |                              |                                 |                              |                                  |                                  |                                    |                                  |        |
| <b>Dixie Howell, R</b> (1, 2)<br>OBP: 0.329, SLG: 0.307  |   | 0-0<br>5-3                      |                              | 0-0<br>1B                       |                              | 0-0<br>1B                       |                              |                                 | 0-0<br>BB<br>2B              | 4 1 3 1 0 0 1   |                              |                                 |                              |                                 |                              |                                  |                                  |                                    |                                  |        |
| <b>Herm Wehmeier, R</b> (1, 1)<br>OBP: 0.161, SLG: 0.185<br><b>Ted Tappe, L</b> (6, PH)<br>OBP: 0.250, SLG: 1.000<br><b>Johnny Hetki, R</b> (6, 1)<br>OBP: 0.300, SLG: 0.222<br><b>Sammy Meeks, R</b> (9, PH)<br>OBP: 0.327, SLG: 0.370<br><b>Connie Ryan, R</b> (9, PR)<br>OBP: 0.349, SLG: 0.361 |   | 0-3<br>K                        |                              | 0-0<br>F4                       |                              | 0-0<br>F8                       |                              |                                 | 4-0<br>BB<br>1B<br>BB        | 2 0 0 0 0 1 3<br>1 0 0 0 0 0 1<br>0 0 0 0 0 0 0<br>0 0 0 0 1 0 0<br>0 1 0 0 0 0 0 |                              |                                 |                              |                                 |                              |                                  |                                  |                                    |                                  |        |
| <b>Inning Stats</b>  | R: 1<br>E: 0<br>K: 0<br>S: 5                          | H: 1<br>LOB: 1<br>BB: 0<br>P: 5 | R: 0<br>E: 0<br>K: 2<br>S: 8 | H: 1<br>LOB: 1<br>BB: 0<br>P: 8 | R: 0<br>E: 0<br>K: 0<br>S: 4 | H: 1<br>LOB: 1<br>BB: 0<br>P: 4 | R: 2<br>E: 0<br>K: 1<br>S: 8 | H: 4<br>LOB: 1<br>BB: 0<br>P: 8 | R: 1<br>E: 0<br>K: 0<br>S: 4 | H: 1<br>LOB: 1<br>BB: 0<br>P: 8   | R: 0<br>E: 0<br>K: 0<br>S: 3 | H: 1<br>LOB: 0<br>BB: 0<br>P: 3 | R: 0<br>E: 0<br>K: 1<br>S: 5 | H: 0<br>LOB: 0<br>BB: 0<br>P: 5 | R: 3<br>E: 0<br>K: 0<br>S: 4 | H: 2<br>LOB: 1<br>BB: 3<br>P: 16 | 1B: 7<br>2B: 6<br>3B: 0<br>HR: 0 | SF: 0<br>SAC: 0<br>DP: 1<br>HBP: 0 | WP: 0<br>PB: 0<br>SB: 0<br>CS: 0 | PA: 41 |
| <b>PITCHER</b>   | IP WLS BF H R ER SO BB IBB HBP BLK WP HR S P ERA WHIP |                                 |                              |                                 |                              |                                 |                              |                                 |                              |   |                              |                                 |                              |                                 |                              |                                  |                                  |                                    |                                  |        |
| <b>Vern Law, R</b> (1, 1)<br>ERA: 5.25   | 5.0 W 24 8 4 4 3 1 0 0 0 0 0 0 29 33 7.20 1.800       |                                 |                              |                                 |                              |                                 |                              |                                 |                              |   |                              |                                 |                              |                                 |                              |                                  |                                  |                                    |                                  |        |
| <b>Mel Queen, R</b> (6, 1)<br>ERA: 5.98  | 3.0 13 3 3 3 1 2 0 0 0 0 0 0 13 21 9.00 1.667         |                                 |                              |                                 |                              |                                 |                              |                                 |                              |   |                              |                                 |                              |                                 |                              |                                  |                                  |                                    |                                  |        |
| <b>Vic Lombardi, L</b> (9, 1)<br>ERA: 6.69   | 0.2 3 1 0 0 0 1 0 0 0 0 0 0 2 6 0.00 3.000            |                                 |                              |                                 |                              |                                 |                              |                                 |                              |   |                              |                                 |                              |                                 |                              |                                  |                                  |                                    |                                  |        |
| <b>Junior Walsh, R</b> (9, 1)<br>ERA: 5.49   | 0.1 S 1 0 0 0 0 0 0 0 0 0 0 0 1 1 0.00 0.000          |                                 |                              |                                 |                              |                                 |                              |                                 |                              |   |                              |                                 |                              |                                 |                              |                                  |                                  |                                    |                                  |        |

**Cincinnati Reds @ Pittsburgh Pirates**  
 Forbes Field, Pittsburgh, PA  
 Sat Sep 23 1950, 3:33 AM EDT  
 Att: 4,009 - Cloudy - 60 F

[livebaseballscorecards.com](http://livebaseballscorecards.com)

|     |    |
|-----|----|
| AB  | 37 |
| R   | 7  |
| H   | 12 |
| RBI | 7  |
| BB  | 4  |
| SO  | 4  |
| LOB | 19 |





BOTTOM

Cincinnati Reds @ Pittsburgh Pirates  
Forbes Field, Pittsburgh, PA

|     |    |
|-----|----|
| AB  | 33 |
| R   | 8  |
| H   | 11 |
| RBI | 7  |
| BB  | 8  |
| SO  | 3  |
| LOB | 19 |



|     |   |     |    |
|-----|---|-----|----|
| WP: | 1 | PA: | 42 |
| PB: | 0 |     |    |
| SB: | 0 |     |    |
| CS: | 1 |     |    |

|    |    |   |   |     |      |
|----|----|---|---|-----|------|
| WP | HR | S | P | ERA | WHIP |
|----|----|---|---|-----|------|

Sat Sep 23 1950, 3:33 AM EDT  
Att. 4,009 - Cloudy - 60 F

livebaseballscorecards.com

| AB | R | H | RBI | BB | SO | LOB |
|----|---|---|-----|----|----|-----|
| 5  | 0 | 1 | 1   | 0  | 1  | 2   |
| 4  | 2 | 2 | 0   | 1  | 0  | 3   |
| 3  | 3 | 2 | 0   | 2  | 0  | 0   |
| 4  | 0 | 0 | 0   | 1  | 0  | 4   |
| 4  | 0 | 2 | 2   | 1  | 0  | 0   |
| 4  | 1 | 1 | 2   | 0  | 0  | 5   |
| 2  | 1 | 0 | 0   | 2  | 1  | 1   |
| 3  | 1 | 2 | 0   | 1  | 0  | 0   |
| 2  | 0 | 0 | 0   | 0  | 1  | 4   |
| 1  | 0 | 1 | 2   | 0  | 0  | 0   |
| 0  | 0 | 0 | 0   | 0  | 0  | 0   |
| 1  | 0 | 0 | 0   | 0  | 0  | 0   |
| 0  | 0 | 0 | 0   | 0  | 0  | 0   |
| 0  | 0 | 0 | 0   | 0  | 0  | 0   |

|     |   |      |   |
|-----|---|------|---|
| 1B: | 7 | SF:  | 0 |
| 2B: | 4 | SAC: | 0 |
| 3B: | 0 | DP:  | 0 |
| HR: | 0 | HBP: | 0 |

|    |    |    |    |    |     |    |     |
|----|----|----|----|----|-----|----|-----|
| 1B | 2B | 3B | HR | SF | SAC | DP | HBP |
|----|----|----|----|----|-----|----|-----|

| Batter  | 1                                     | 2         | 3  | 4                | 5                                    | 6                         | 7                    | 8          | 9 |
|---|---------------------------------------|-----------|--|------------------|--------------------------------------|---------------------------|----------------------|------------|---|
| Bob Dillinger, R<br>OBP: 0.356, SLG: 0.416    | 0-0<br>6-3<br>1B                      | 0-3<br>K  |  | 0-0<br>4-3<br>1B | 0-0<br>F8<br>2B                      |                           | 0-0<br>FC4-6<br>1B   |            |   |
| Tom Saffell, L<br>OBP: 0.271, SLG: 0.277      | 4-0<br>2B<br>1B<br>BB                 |           | 0-0<br>2B<br>F7<br>1B                    | 0-0<br>BB<br>1B  | 0-0<br>1-3                           |                           | 0-0<br>FC4-6<br>1-2f |            |   |
| Ralph Kiner, R<br>OBP: 0.417, SLG: 0.605      | 0-0<br>1B<br>2B                       |           | 0-0<br>BB<br>WP<br>2B                    | 4-0<br>1-2<br>BB |                                      | 4-0<br>1B<br>FC6<br>BB    |                      | 0-0<br>F9  |   |
| Gus Bell, L<br>OBP: 0.333, SLG: 0.444         | 4-0<br>FC4<br>1B<br>CS<br>IBB         |           | 0-0<br>4-3                               | 0-0<br>F9        |                                      | 0-0<br>F7                 |                      | 0-0<br>4-3 |   |
| Danny O'Connell, R<br>OBP: 0.356, SLG: 0.431  | 0-0<br>FC4<br>1B<br>1-2<br>2-H<br>3-H |           | 4-0<br>WP<br>BB<br>IBB                   |                  | 0-0<br>4-3                           | 0-0<br>FC6<br>1B          |                      | 0-0<br>L6  |   |
| Jack Phillips, R<br>OBP: 0.335, SLG: 0.415    | 0-0<br>FC4<br>1-2f<br>2-3             |           | 0-0<br>F7                                |                  | 0-0<br>1B<br>BB<br>2B<br>1B          | 0-0<br>FC6<br>1-2f<br>3-H |                      | 0-0<br>FC6 |   |
| Johnny Berardino, R<br>OBP: 0.301, SLG: 0.243 | 0-0<br>CS<br>3-H                      | 0-3<br>K  | 4-0<br>WP<br>BB<br>1-2<br>2-3            |                  | 4-0<br>1B<br>BB<br>2B<br>BB          | 0-0<br>L4                 |                      | 0-0<br>F9  |   |
| Clyde McCullough, R<br>OBP: 0.342, SLG: 0.410 |                                       | 0-0<br>2B | 4-0<br>FC6-4<br>IBB<br>1-2<br>2-3<br>3-H |                  | 0-0<br>2B<br>F8<br>1B<br>1-2<br>2-3  |                           | 0-0<br>F9            |            |   |
| Vern Law, R<br>OBP: 0.146, SLG: 0.132         |                                       | 0-3<br>K  | 0-0<br>FC6-4<br>1-2f                     |                  | 0-0<br>F8<br>2B<br>1-3<br>2-H<br>3-H |                           | 0-0<br>1-3           |            |   |
| Ed Stevens, L<br>OBP: 0.220, SLG: 0.211       |                                       |           |  |                  |                                      |                           |                      |            |   |
| Hank Schrenz, R<br>OBP: 0.269, SLG: 0.333     |                                       |           |  |                  |                                      |                           |                      |            |   |
| Mel Queen, R<br>OBP: 0.053, SLG: 0.057        |                                       |           |  |                  |                                      |                           |                      |            |   |
| Vic Lombardi, L<br>OBP: 0.294, SLG: 0.313     |                                       |           |  |                  |                                      |                           |                      |            |   |
| Junior Walsh, R<br>OBP: 0.444, SLG: 0.333     |                                       |           |  |                  |                                      |                           |                      |            |   |

| Inning Stats | R | H | E | K | S  | P | WP | HR | S  | P  | ERA   | WHIP  |
|--------------|---|---|---|---|----|---|----|----|----|----|-------|-------|
|              | 2 | 2 | 0 | 0 | 4  | 5 | 0  | 0  | 28 | 56 | 12.60 | 2.600 |
|              | 0 | 1 | 0 | 3 | 10 | 7 | 0  | 0  | 11 | 15 | 3.00  | 1.000 |

| PITCHER                       | IP  | WLS | BF | H | R | ER | SO | BB | IBB | HBP | BLK | WP | HR | S  | P  | ERA   | WHIP  |
|-------------------------------|-----|-----|----|---|---|----|----|----|-----|-----|-----|----|----|----|----|-------|-------|
| Herm Wehmeier, R<br>ERA: 5.55 | 5.0 | L   | 29 | 9 | 7 | 7  | 3  | 4  | 3   | 0   | 0   | 1  | 0  | 28 | 56 | 12.60 | 2.600 |
| Johnny Hetki, R<br>ERA: 5.29  | 3.0 |     | 12 | 2 | 1 | 1  | 0  | 1  | 0   | 0   | 0   | 0  | 0  | 11 | 15 | 3.00  | 1.000 |

| Batter   | 1   | 2                               | 3                            | 4                                | 5                            | 6                               | 7                            | 8                               | 9                            | AB R H RBI BB SO LOB             | TOP   |                                 |                              |                                 |                              |                                 |                              |                                 |                                  |                                    |                                  |        |
|--|---|---------------------------------|------------------------------|----------------------------------|------------------------------|---------------------------------|------------------------------|---------------------------------|------------------------------|----------------------------------|---|---------------------------------|------------------------------|---------------------------------|------------------------------|---------------------------------|------------------------------|---------------------------------|----------------------------------|------------------------------------|----------------------------------|--------|
| <b>Bobby Adams, R</b> (1, 4)<br>OBP: 0.370, SLG: 0.423     | 0-0<br>L5   |                                 | 0-0<br>F9                    |                                  | 0-0<br>1B<br>1B              | 0-0<br>F3                       |                              |                                 | 0-0<br>FC4-6<br>2B<br>1-2f   | 5 2 1 0 0 0 1                    | <b>Cincinnati Reds @ Pittsburgh Pirates</b><br><b>Forbes Field, Pittsburgh, PA</b><br>Sun Sep 24 1950, 3:33 AM EST<br>Cloudy - 53 F |                                 |                              |                                 |                              |                                 |                              |                                 |                                  |                                    |                                  |        |
| <b>Grady Hatton, L</b> (1, 5)<br>OBP: 0.368, SLG: 0.387    | 0-0<br>G3   |                                 | 4-0<br>FC3-6<br>BB           |                                  | 0-0<br>1B<br>F7<br>1B        |                                 | 0-0<br>4-3<br>F7<br>2B       | 0-0<br>F6                       | 4 2 2 0 1 0 1                |                                  |   |                                 |                              |                                 |                              |                                 |                              |                                 |                                  |                                    |                                  |        |
| <b>Johnny Wyrostek, L</b> (1, 9)<br>OBP: 0.368, SLG: 0.432 | 0-0<br>F8   |                                 | 0-0<br>FC3-6<br>1-2f         |                                  | 0-3<br>K                     |                                 | 0-0<br>4-3                   | 0-0<br>2B<br>2B                 | 5 1 1 0 0 1 4                |                                  |   |                                 |                              |                                 |                              |                                 |                              |                                 |                                  |                                    |                                  |        |
| <b>Ted Kluszewski, L</b> (1, 3)<br>OBP: 0.355, SLG: 0.530  |   | 0-0<br>F7                       | 0-0<br>L4                    |                                  | 0-0<br>BB<br>1B              |                                 | 0-0<br>F7                    | 0-0<br>2B                       | 5 0 2 4 0 0 1                |                                  |   |                                 |                              |                                 |                              |                                 |                              |                                 |                                  |                                    |                                  |        |
| <b>Lloyd Merriman, L</b> (1, 8)<br>OBP: 0.323, SLG: 0.337  |   | 0-0<br>1-3                      |                              | 0-0<br>F5                        | 4-0<br>FC6-4<br>BB           |                                 | 0-3<br>K                     | 0-0<br>F6                       | 4 0 0 0 1 1 1                |                                  |   |                                 |                              |                                 |                              |                                 |                              |                                 |                                  |                                    |                                  |        |
| <b>Joe Adcock, R</b> (1, 7)<br>OBP: 0.313, SLG: 0.395      |   | 4-0<br>BB<br>1B<br>BB           |                              | 0-0<br>1B<br>F8<br>2B            | 0-0<br>F7                    |                                 | 0-0<br>5-3                   |                                 | 3 2 1 1 1 0 2                |                                  |   |                                 |                              |                                 |                              |                                 |                              |                                 |                                  |                                    |                                  |        |
| <b>Johnny Pramesa, R</b> (1, 2)<br>OBP: 0.371, SLG: 0.440  |   | 4-0<br>1B<br>BB                 |                              | 0-0<br>2-3<br>1B                 | 0-0<br>FC6-4<br>1-2f         |                                 | 0-0<br>3-1                   |                                 | 3 0 1 0 1 0 2                |                                  |   |                                 |                              |                                 |                              |                                 |                              |                                 |                                  |                                    |                                  |        |
| <b>Virgil Stallcup, R</b> (1, 6)<br>OBP: 0.279, SLG: 0.363 |   | 0-0<br>1-2<br>2-H<br>1B         |                              | 0-0<br>F8                        |                              | 0-0<br>5-3                      |                              | 0-0<br>1-3                      | 4 0 1 2 0 0 1                |                                  |   |                                 |                              |                                 |                              |                                 |                              |                                 |                                  |                                    |                                  |        |
| <b>Ewell Blackwell, R</b> (1, 1)<br>OBP: 0.191, SLG: 0.157 |   | 0-0<br>5-3                      |                              | 0-0<br>6-3                       |                              | 0-0<br>F9                       |                              | 0-0<br>FC4-6<br>1B              | 4 0 1 0 0 0 3                |                                  |   |                                 |                              |                                 |                              |                                 |                              |                                 |                                  |                                    |                                  |        |
| <b>Inning Stats</b>  | R: 0<br>E: 0<br>K: 0<br>S: 3                          | H: 0<br>LOB: 0<br>BB: 0<br>P: 3 | R: 1<br>E: 0<br>K: 0<br>S: 4 | H: 1<br>LOB: 2<br>BB: 2<br>P: 12 | R: 0<br>E: 0<br>K: 0<br>S: 3 | H: 0<br>LOB: 1<br>BB: 0<br>P: 7 | R: 1<br>E: 0<br>K: 0<br>S: 5 | H: 2<br>LOB: 1<br>BB: 0<br>P: 5 | R: 2<br>E: 0<br>K: 1<br>S: 8 | H: 3<br>LOB: 2<br>BB: 1<br>P: 12 | R: 0<br>E: 0<br>K: 0<br>S: 3  | H: 0<br>LOB: 0<br>BB: 0<br>P: 3 | R: 1<br>E: 0<br>K: 1<br>S: 6 | H: 1<br>LOB: 0<br>BB: 0<br>P: 6 | R: 0<br>E: 0<br>K: 0<br>S: 3 | H: 0<br>LOB: 0<br>BB: 0<br>P: 3 | R: 2<br>E: 0<br>K: 0<br>S: 6 | H: 3<br>LOB: 1<br>BB: 0<br>P: 6 | 1B: 6<br>2B: 4<br>3B: 0<br>HR: 0 | SF: 0<br>SAC: 0<br>DP: 0<br>HBP: 0 | WP: 0<br>PB: 0<br>SB: 0<br>CS: 0 | PA: 41 |
| <b>PITCHER</b>   | IP WLS BF H R ER SO BB IBB HBP BLK WP HR S P ERA WHIP |                                 |                              |                                  |                              |                                 |                              |                                 |                              |                                  |   |                                 |                              |                                 |                              |                                 |                              |                                 |                                  |                                    |                                  |        |
| <b>Bill MacDonald, R</b> (1, 1)<br>ERA: 4.29               | 5.0 L 25 6 4 4 1 4 0 0 0 0 0 0 23 39 7.20 2.000       |                                 |                              |                                  |                              |                                 |                              |                                 |                              |                                  |   |                                 |                              |                                 |                              |                                 |                              |                                 |                                  |                                    |                                  |        |
| <b>Junior Walsh, R</b> (6, 1)<br>ERA: 5.37                 | 3.0 10 1 1 1 1 0 0 0 0 0 0 0 12 12 3.00 0.333         |                                 |                              |                                  |                              |                                 |                              |                                 |                              |                                  |   |                                 |                              |                                 |                              |                                 |                              |                                 |                                  |                                    |                                  |        |
| <b>Vic Lombardi, L</b> (9, 1)<br>ERA: 6.84                 | 1.0 6 3 2 2 0 0 0 0 0 0 0 0 6 6 18.00 3.000           |                                 |                              |                                  |                              |                                 |                              |                                 |                              |                                  |   |                                 |                              |                                 |                              |                                 |                              |                                 |                                  |                                    |                                  |        |

livebaseballscorecards.com

|            |    |
|------------|----|
| <b>AB</b>  | 37 |
| <b>R</b>   | 7  |
| <b>H</b>   | 10 |
| <b>RBI</b> | 7  |
| <b>BB</b>  | 4  |
| <b>SO</b>  | 2  |
| <b>LOB</b> | 16 |



| Batter  | 1          | 2              | 3          | 4         | 5          | 6 | 7         | 8          | 9          | AB | R | H | RBI | BB | SO | LOB |
|---|------------|----------------|------------|-----------|------------|---|-----------|------------|------------|----|---|---|-----|----|----|-----|
| Bob Dillinger, R<br>OBP: 0.353, SLG: 0.413 (1, 5)     | 0-3<br>K   |                | 0-0<br>G3  |           | 0-0<br>F7  |   |           | 0-0<br>5-3 |            | 4  | 0 | 0 | 0   | 0  | 1  | 2   |
| Tom Saffell, L<br>OBP: 0.271, SLG: 0.282 (1, 8)       | 0-3<br>K   |                | 0-0<br>2B  |           | 0-3<br>K   |   |           | 0-0<br>F8  |            | 4  | 0 | 1 | 0   | 0  | 2  | 2   |
| Ralph Kiner, R<br>OBP: 0.416, SLG: 0.601 (1, 7)       | 4-0<br>BB  |                | 0-3<br>K   |           |            |   | 0-0<br>F3 | 0-0<br>F3  |            | 3  | 0 | 0 | 0   | 1  | 1  | 2   |
| Gus Bell, L<br>OBP: 0.333, SLG: 0.444 (1, 9)          | 0-0<br>1-3 |                |            | 0-0<br>F8 |            |   | 0-3<br>K  |            | 0-0<br>2B  | 4  | 1 | 1 | 0   | 0  | 1  | 1   |
| Danny O'Connell, R<br>OBP: 0.354, SLG: 0.432 (1, 6)   |            | 0-0<br>1-3     |            | 0-0<br>G3 |            |   | 0-0<br>F2 |            | 0-0<br>2B  | 4  | 0 | 1 | 1   | 0  | 0  | 0   |
| Ed Stevens, L<br>OBP: 0.222, SLG: 0.214 (1, 3)        |            | 0-0<br>1B      |            | 0-0<br>E4 |            |   | 0-3<br>K  |            | 0-0<br>F6  | 4  | 0 | 1 | 0   | 0  | 1  | 1   |
| Johnny Berardino, R<br>OBP: 0.299, SLG: 0.244 (1, 4)  |            | 0-0<br>1B      |            | 0-3<br>K  |            |   | 0-0<br>F7 |            | 0-0<br>5-3 | 4  | 0 | 1 | 0   | 0  | 1  | 2   |
| Ray Mueller, R<br>OBP: 0.301, SLG: 0.406 (1, 2)       |            | 0-0<br>G4-6-3  |            |           | 0-0<br>6-3 |   | 0-0<br>F2 |            | 0-3<br>K   | 3  | 0 | 0 | 0   | 0  | 0  | 2   |
| Wally Westlake, R<br>OBP: 0.357, SLG: 0.485 (9, PH)   |            | 1-2f<br>G4-6-3 |            |           |            |   |           |            | 0-0<br>K   | 1  | 0 | 0 | 0   | 0  | 1  | 1   |
| Bill MacDonald, R<br>OBP: 0.189, SLG: 0.143 (1, 1)    |            |                | 0-0<br>6-3 |           |            |   |           |            |            | 1  | 0 | 0 | 0   | 0  | 0  | 0   |
| Danny Murtaugh, R<br>OBP: 0.378, SLG: 0.393 (5, PH)   |            |                |            |           |            |   |           |            |            | 1  | 0 | 1 | 0   | 0  | 0  | 0   |
| Junior Walsh, R<br>OBP: 0.444, SLG: 0.333 (6, 1)      |            |                |            |           |            |   |           |            |            | 0  | 0 | 0 | 0   | 0  | 0  | 0   |
| Pete Castiglione, R<br>OBP: 0.317, SLG: 0.350 (8, PH) |            |                |            |           |            |   |           |            |            | 1  | 0 | 1 | 0   | 0  | 0  | 0   |
| Vic Lombardi, L<br>OBP: 0.294, SLG: 0.313 (9, 1)      |            |                |            |           |            |   |           |            | 5-3<br>1B  | 0  | 0 | 0 | 0   | 0  | 0  | 0   |

| Inning Stats | R: 0 | H: 0 | E: 0 | K: 2 | S: 7 | R: 0 | H: 2 | E: 0 | K: 0 | S: 4 | R: 0 | H: 1 | E: 0 | K: 1 | S: 6 | R: 0 | H: 0 | E: 1 | K: 1 | S: 6 | R: 0 | H: 1 | E: 0 | K: 1 | S: 6 | R: 0 | H: 0 | E: 0 | K: 1 | S: 5 | R: 0 | H: 0 | E: 0 | K: 1 | S: 5 | R: 0 | H: 0 | E: 0 | K: 1 | S: 5 | R: 0 | H: 1 | E: 0 | K: 0 | S: 4 | R: 1 | H: 2 | E: 0 | K: 1 | S: 7 | 1B: 4 | 2B: 3 | 3B: 0 | HR: 0 | SF: 0 | SAC: 0 | DP: 1 | HBP: 0 | WP: 0 | PB: 0 | SB: 0 | CS: 0 | PA: 35 |
|--------------|------|------|------|------|------|------|------|------|------|------|------|------|------|------|------|------|------|------|------|------|------|------|------|------|------|------|------|------|------|------|------|------|------|------|------|------|------|------|------|------|------|------|------|------|------|------|------|------|------|------|-------|-------|-------|-------|-------|--------|-------|--------|-------|-------|-------|-------|--------|
|--------------|------|------|------|------|------|------|------|------|------|------|------|------|------|------|------|------|------|------|------|------|------|------|------|------|------|------|------|------|------|------|------|------|------|------|------|------|------|------|------|------|------|------|------|------|------|------|------|------|------|------|-------|-------|-------|-------|-------|--------|-------|--------|-------|-------|-------|-------|--------|

| PITCHER                                | IP  | WLS | BF | H | R | ER | SO | BB | IBB | HBP | BLK | WP | HR | S  | P  | ERA  | WHIP  |
|--|-----|-----|----|---|---|----|----|----|-----|-----|-----|----|----|----|----|------|-------|
| Ewell Blackwell, R<br>ERA: 3.03 (1, 1) | 9.0 | W   | 35 | 7 | 1 | 1  | 8  | 1  | 0   | 0   | 0   | 0  | 0  | 50 | 54 | 1.00 | 0.889 |

**BOTTOM**

**Cincinnati Reds @ Pittsburgh Pirates**  
**Forbes Field, Pittsburgh, PA**  
 Sun Sep 24 1950, 3:33 AM EST  
 Cloudy - 53 F

|            |           |
|------------|-----------|
| <b>AB</b>  | <b>34</b> |
| <b>R</b>   | <b>1</b>  |
| <b>H</b>   | <b>7</b>  |
| <b>RBI</b> | <b>1</b>  |
| <b>BB</b>  | <b>1</b>  |
| <b>SO</b>  | <b>8</b>  |
| <b>LOB</b> | <b>13</b> |



| Batter  | 1  | 2   | 3   | 4   | 5   | 6   | 7   | 8   | 9   | AB R H RBI BB SO LOB   | TOP  |
|---|--|---|---|---|---|---|---|---|---|--|--|
| <b>Bobby Adams, R</b> (1, 4)<br>OBP: 0.366, SLG: 0.418  | 0-0<br>F4  |   | 0-0<br>F7   |   |   | 0-0<br>F2   |   | 0-0<br>F8   |   | 4 0 0 0 0 0 1  | <b>Cincinnati Reds @ Pittsburgh Pirates</b><br><b>Forbes Field, Pittsburgh, PA</b><br>Sun Sep 24 1950, 3:38 AM EST<br>Att. 25,233 - Cloudy |
| <b>Grady Hatton, L</b> (1, 5)<br>OBP: 0.367, SLG: 0.384   | 4-0<br>L5-3<br>BB  |   | 0-0<br>L4   |   |   | 0-0<br>G3   |   | 0-0<br>F6   |   | 3 0 0 0 1 0 1  |  |
| <b>Johnny Wyrostek, L</b> (1, 9)<br>OBP: 0.367, SLG: 0.430  | 0-0<br>L5-3<br>1-2   |   |   |   | 0-0<br>F5   |   | 0-0<br>F8   |   | 0-0<br>1B<br>FC3-6<br>1B  | 4 1 1 0 0 0 1  |  |
| <b>Ted Kluszewski, L</b> (1, 3)<br>OBP: 0.356, SLG: 0.530   |  | 0-0<br>1B<br>1B   |   |   | 0-0<br>F8   |   | 0-0<br>F6   |   | 0-0<br>1B<br>FC3-6<br>1B  | 4 1 2 0 0 0 0  |  |
| <b>Lloyd Merriman, L</b> (1, 8)<br>OBP: 0.328, SLG: 0.346   |  | 0-0<br>1B<br>1B   |   |   | 0-0<br>2B   |   | 0-0<br>1B   |   | 0-0<br>FC3-6<br>FC5-4<br>1-2f<br>3-H                            | 4 0 3 1 0 0 1  |  |
| <b>Joe Adcock, R</b> (1, 7)<br>OBP: 0.313, SLG: 0.393   |  | 0-0<br>1B<br>1B   |   |   | 0-0<br>6-3  |   | 0-0<br>F8   |   | 0-0<br>FC5-4<br>1B<br>1-2f                                      | 4 0 1 1 0 0 3  |  |
| <b>Virgil Stallcup, R</b> (1, 6)<br>OBP: 0.279, SLG: 0.362  |  | 0-0<br>F8   |   |   | 0-3<br>K  |   | 0-0<br>F2   |   | 0-0<br>1B<br>1-2  | 4 0 1 0 0 1 3  |  |
| <b>Dixie Howell, R</b> (1, 2)<br>OBP: 0.324, SLG: 0.301   |  | 0-0<br>G4-6-3<br>1-2f   |   |   | 0-0<br>5-3  |   |   | 0-0<br>1-3  | 0-0<br>F6   | 4 0 0 0 0 0 4  |  |
| <b>Ken Raffensberger, R</b> (1, 1)<br>OBP: 0.176, SLG: 0.198<br><b>Ted Tappe, L</b> (8, PH)<br>OBP: 0.400, SLG: 1.000<br><b>Frank Smith, R</b> (8, 1)<br>OBP: 0.095, SLG: 0.095 |  |   | 0-3<br>K  |   | 0-0<br>1-3  |   |   | 4-0<br>BB   |   | 2 0 0 0 0 1 0<br>0 0 0 0 1 0 0<br>0 0 0 0 0 0 0                        |  |
| <b>Inning Stats</b>   | R: 0<br>E: 0<br>K: 0<br>S: 2<br>H: 0<br>LOB: 0<br>BB: 1<br>P: 6  | R: 1<br>E: 0<br>K: 0<br>S: 5<br>H: 3<br>LOB: 1<br>BB: 0<br>P: 5 | R: 0<br>E: 0<br>K: 1<br>S: 5<br>H: 0<br>LOB: 0<br>BB: 0<br>P: 5 | R: 0<br>E: 0<br>K: 0<br>S: 4<br>H: 1<br>LOB: 1<br>BB: 0<br>P: 4 | R: 0<br>E: 0<br>K: 1<br>S: 5<br>H: 0<br>LOB: 0<br>BB: 0<br>P: 5 | R: 0<br>E: 0<br>K: 0<br>S: 3<br>H: 0<br>LOB: 0<br>BB: 0<br>P: 3 | R: 0<br>E: 0<br>K: 0<br>S: 4<br>H: 1<br>LOB: 1<br>BB: 0<br>P: 4 | R: 0<br>E: 0<br>K: 0<br>S: 3<br>H: 0<br>LOB: 1<br>BB: 1<br>P: 7 | R: 1<br>E: 0<br>K: 0<br>S: 6<br>H: 3<br>LOB: 2<br>BB: 0<br>P: 6 | 1B: 7<br>2B: 2<br>3B: 0<br>HR: 0<br>SF: 0<br>SAC: 0<br>DP: 2<br>HBP: 0 | WP: 0<br>PB: 0<br>SB: 0<br>CS: 0<br>PA: 35   |
| <b>PITCHER</b><br><b>Murry Dickson, R</b> (1, 1)<br>ERA: 3.87   | IP: 9.0<br>WLS: W<br>BF: 35<br>H: 8<br>R: 2<br>ER: 2<br>SO: 2<br>BB: 2<br>IBB: 0<br>HBP: 0<br>BLK: 0<br>WP: 0<br>HR: 0<br>S: 37<br>P: 45<br>ERA: 2.00<br>WHIP: 1.111 |   |   |   |   |   |   |   |   |  |  |

livebaseballscorecards.com

|            |    |
|------------|----|
| <b>AB</b>  | 33 |
| <b>R</b>   | 2  |
| <b>H</b>   | 8  |
| <b>RBI</b> | 2  |
| <b>BB</b>  | 2  |
| <b>SO</b>  | 2  |
| <b>LOB</b> | 14 |



| Batter   | 1                 | 2                   | 3          | 4                | 5               | 6                    | 7                        | 8                   | 9 | AB | R | H | RBI | BB | SO | LOB |
|--|-------------------|---------------------|------------|------------------|-----------------|----------------------|--------------------------|---------------------|---|----|---|---|-----|----|----|-----|
| Bob Dillinger, R<br>OBP: 0.353, SLG: 0.413 (1, 5)    | 0-0<br>1B         | 0-0<br>G5-4-3       |            |                  | 0-3<br>K        |                      | 0-0<br>SH3-4             |                     |   | 3  | 1 | 1 | 0   | 0  | 1  | 1   |
| Danny O'Connell, R<br>OBP: 0.353, SLG: 0.430 (1, 6)  | 0-0<br>6-3<br>1-2 |                     | 0-0<br>5-3 |                  | 0-0<br>CS<br>1B |                      | 0-0<br>F4                |                     |   | 4  | 0 | 1 | 0   | 0  | 0  | 2   |
| Ralph Kiner, R<br>OBP: 0.415, SLG: 0.598 (1, 7)      | 0-3<br>K          |                     | 0-3<br>K   |                  | 0-3<br>K        |                      | 0-0<br>FC6-4<br>1B       |                     |   | 4  | 0 | 1 | 0   | 0  | 3  | 2   |
| Gus Bell, L<br>OBP: 0.332, SLG: 0.442 (1, 9)         | 0-0<br>1B         |                     | 0-3<br>K   |                  |                 | 0-0<br>F8            | 0-0<br>FC6-4             |                     |   | 4  | 1 | 1 | 1   | 0  | 1  | 2   |
| Wally Westlake, R<br>OBP: 0.358, SLG: 0.487 (1, 8)   | 0-0<br>2B<br>1B   |                     |            | 0-0<br>F8        |                 | 0-0<br>1B<br>S<br>2B |                          | 0-0<br>F7           |   | 4  | 1 | 2 | 1   | 0  | 0  | 0   |
| Jack Phillips, R<br>OBP: 0.347, SLG: 0.431 (1, 3)    | 0-0<br>1-3<br>2B  |                     |            | 0-0<br>1B<br>1B  |                 | 0-0<br>S<br>1B       |                          | 0-0<br>G5-4-3<br>1B |   | 4  | 0 | 4 | 0   | 0  | 0  | 0   |
| Johnny Berardino, R<br>OBP: 0.298, SLG: 0.244 (1, 4) | 0-0<br>F7         |                     |            | 0-0<br>1-2<br>1B |                 | 0-0<br>F7            |                          | 0-0<br>G5-4-3       |   | 4  | 0 | 1 | 0   | 0  | 0  | 4   |
| Clyde McCullough, R<br>OBP: 0.339, SLG: 0.405 (1, 2) |                   | 0-0<br>6-3          |            | 0-0<br>F9        |                 | 0-0<br>F7            |                          |                     |   | 3  | 0 | 0 | 0   | 0  | 0  | 3   |
| Murry Dickson, R<br>OBP: 0.263, SLG: 0.304 (1, 1)    |                   | 0-0<br>G5-4-3<br>1B |            | 0-0<br>1-3       |                 |                      | 0-0<br>1B<br>SH3-4<br>1B |                     |   | 3  | 0 | 2 | 0   | 0  | 0  | 2   |

| Inning Stats                             | R: 2 | H: 4 | E: 0 | LOB: 2 | K: 1 | P: 9 | R: 0 | H: 1 | E: 0 | LOB: 0 | K: 0 | P: 3 | R: 0 | H: 0 | E: 0 | LOB: 0 | K: 2  | P: 7 | R: 0 | H: 2 | E: 0 | LOB: 2 | K: 0 | P: 5 | R: 0 | H: 1 | E: 0 | LOB: 1 | K: 2 | P: 7 | R: 1 | H: 2 | E: 0 | LOB: 1 | K: 0 | P: 5    | R: 0 | H: 2 | E: 0 | LOB: 2 | K: 0 | P: 5 | R: 0 | H: 1 | E: 0 | LOB: 0 | K: 0 | P: 3 |    |   |   |     |      |  |  |  |  |  |  |
|--|------|------|------|--------|------|------|------|------|------|--------|------|------|------|------|------|--------|-------|------|------|------|------|--------|------|------|------|------|------|--------|------|------|------|------|------|--------|------|---------|------|------|------|--------|------|------|------|------|------|--------|------|------|----|---|---|-----|------|--|--|--|--|--|--|
| PITCHER                                  | IP   | WLS  | BF   | H      | R    | ER   | SO   | BB   | IBB  | HBP    | BLK  | WP   | HR   | S    | P    | ERA    | WHIP  |      |      |      |      |        |      |      |      |      |      |        |      |      |      |      |      |        |      | PITCHER | IP   | WLS  | BF   | H      | R    | ER   | SO   | BB   | IBB  | HBP    | BLK  | WP   | HR | S | P | ERA | WHIP |  |  |  |  |  |  |
| Ken Raffensberger, L<br>ERA: 4.15 (1, 1) | 7.0  | L    | 31   | 12     | 3    | 3    | 5    | 0    | 0    | 0      | 0    | 0    | 0    | 0    | 41   | 3.86   | 1.714 |      |      |      |      |        |      |      |      |      |      |        |      |      |      |      |      |        |      |         |      |      |      |        |      |      |      |      |      |        |      |      |    |   |   |     |      |  |  |  |  |  |  |
| Frank Smith, R<br>ERA: 3.83 (8, 1)       | 1.0  |      | 3    | 1      | 0    | 0    | 0    | 0    | 0    | 0      | 0    | 0    | 0    | 3    | 3    | 0.00   | 1.000 |      |      |      |      |        |      |      |      |      |      |        |      |      |      |      |      |        |      |         |      |      |      |        |      |      |      |      |      |        |      |      |    |   |   |     |      |  |  |  |  |  |  |

**BOTTOM**

**Cincinnati Reds @ Pittsburgh Pirates**  
**Forbes Field, Pittsburgh, PA**  
 Sun Sep 24 1950, 3:38 AM EST  
 Att: 25,233 - Cloudy

livebaseballscores.com

|            |           |
|------------|-----------|
| <b>AB</b>  | <b>33</b> |
| <b>R</b>   | <b>3</b>  |
| <b>H</b>   | <b>13</b> |
| <b>RBI</b> | <b>2</b>  |
| <b>BB</b>  | <b>0</b>  |
| <b>SO</b>  | <b>5</b>  |
| <b>LOB</b> | <b>16</b> |



|       |        |
|-------|--------|
| WP: 0 | PA: 34 |
| PB: 0 |        |
| SB: 3 |        |
| CS: 1 |        |

| Batter   | 1   | 2  | 3   | 4  | 5   | 6   | 7   | 8 | 9 | AB R H RBI BB SO LOB   | TOP  |                |   |
|--|---|--|---|--|---|---|---|---|---|--|--|----------------|---|
| <b>Bobby Adams, R</b> (1, 4)<br>OBP: 0.370, SLG: 0.422     | 0-0<br>4-3  | 0-0<br>1B<br>1-2 2-H 3-H   |   | 0-0<br>1B<br>1-2   |   | 0-0<br>2B<br>2-H  |   |   |   | 4 1 3 3 0 0 0  | <b>Cincinnati Reds @ St. Louis Cardinals</b><br>Sportsman's Park, St. Louis, MO<br>Tue Sep 26 1950, 4:33 AM EST<br>Att: 2,531 - Unknown - 65 F |                |   |
| <b>Bob Usher, R</b> (1, 8)<br>OBP: 0.310, SLG: 0.362       | 0-0<br>6-3  | 0-0<br>1B<br>1-2 2-H   |   | 0-3<br>K   |   | 0-0<br>2B<br>2-H  |   |   |   | 4 0 2 2 0 1 2  |  |                |   |
| <b>Johnny Wyrostek, L</b> (1, 9)<br>OBP: 0.366, SLG: 0.431 | 0-0<br>2B   | 0-0<br>1-3   |   |  | 0-0<br>6-3  | 0-0<br>F8   |   |   |   | 4 0 1 0 0 0 3  |  |                |   |
| <b>Ted Kluszewski, L</b> (1, 3)<br>OBP: 0.353, SLG: 0.526  | 0-0<br>3-1  |  |   | 0-0<br>F8  |   |   | 0-0<br>F8   |   |   | 4 0 0 0 0 0 1  |  |                |   |
| <b>Joe Adcock, R</b> (1, 7)<br>OBP: 0.317, SLG: 0.397      |   | 0-0<br>CS<br>1B  | 0-0<br>CS<br>1B   |  | 0-0<br>5-3  |   | 0-0<br>4-3<br>1B<br>1B  |   |   | 4 1 3 0 0 0 0  |  |                |   |
| <b>Grady Hatton, L</b> (1, 5)<br>OBP: 0.368, SLG: 0.384    |   | 4-0<br>2B<br>1B<br>BB<br>1-2                                     | 0-0<br>4-3  |  |   | 0-0<br>FC5-4<br>1B  | 0-0<br>4-3  |   |   | 3 1 1 0 1 0 2  |  |                |   |
| <b>Virgil Stallcup, R</b> (1, 6)<br>OBP: 0.281, SLG: 0.365 |   | 0-0<br>1B<br>2B<br>1-3   |   | 0-0<br>F7  |   | 0-0<br>FC5-4<br>2B<br>F9<br>1-2                                 | 0-0<br>1B<br>2-H  |   |   | 4 2 2 1 0 0 1  |  |                |   |
| <b>Dixie Howell, R</b> (1, 2)<br>OBP: 0.331, SLG: 0.307    |   | 4-0<br>1B<br>1B<br>IBB   |   | 4-0<br>1B<br>BB  |   | 0-0<br>1B<br>2B   | 0-0<br>1-3  |   |   | 2 2 1 0 2 0 1  |  |                |   |
| <b>Howie Fox, R</b> (1, 1)<br>OBP: 0.197, SLG: 0.237       |   | 0-3<br>K   |   | 0-0<br>F8  |   | 0-0<br>F9<br>3-H  |   |   |   | 3 0 0 1 0 1 5  |  |                |   |
| <b>Inning Stats</b>  | R: 0<br>E: 0<br>K: 0<br>S: 4<br>H: 1<br>LOB: 1<br>BB: 0<br>P: 4 | R: 3<br>E: 0<br>K: 1<br>S: 8<br>H: 4<br>LOB: 2<br>BB: 2<br>P: 16 | R: 0<br>E: 0<br>K: 0<br>S: 3<br>H: 1<br>LOB: 0<br>BB: 0<br>P: 3 | R: 0<br>E: 0<br>K: 1<br>S: 6<br>H: 1<br>LOB: 2<br>BB: 1<br>P: 10 | R: 0<br>E: 0<br>K: 0<br>S: 3<br>H: 0<br>LOB: 0<br>BB: 0<br>P: 3 | R: 3<br>E: 0<br>K: 0<br>S: 7<br>H: 4<br>LOB: 1<br>BB: 0<br>P: 7 | R: 1<br>E: 0<br>K: 0<br>S: 5<br>H: 2<br>LOB: 1<br>BB: 0<br>P: 5 |   |   | 1B: 9<br>2B: 4<br>3B: 0<br>HR: 0<br>SF: 0<br>SAC: 0<br>DP: 0<br>HBP: 0 | WP: 0<br>PB: 0<br>SB: 0<br>CS: 2<br>PA: 35   |                |   |
| <b>PITCHER</b>   | IP WLS BF H R ER SO BB IBB HBP BLK WP HR S P ERA WHIP           |  |   |  |   |   |   |   |   |  |  | <b>PITCHER</b> | IP WLS BF H R ER SO BB IBB HBP BLK WP HR S P ERA WHIP |
| <b>Max Lanier, L</b> (1, 1)<br>ERA: 3.13                   | 5.2 L 28 10 6 6 2 2 1 0 0 0 0 0 29 41 9.53 2.118                |  |   |  |   |   |   |   |   |  |  |                |   |
| <b>Gerry Staley, R</b> (6, 1)<br>ERA: 5.27                 | 1.1 7 3 1 1 0 0 0 0 0 0 0 0 7 7 6.75 2.250                      |  |   |  |   |   |   |   |   |  |  |                |   |

livebaseballscorecards.com

|            |    |
|------------|----|
| <b>AB</b>  | 32 |
| <b>R</b>   | 7  |
| <b>H</b>   | 13 |
| <b>RBI</b> | 7  |
| <b>BB</b>  | 3  |
| <b>SO</b>  | 2  |
| <b>LOB</b> | 15 |



| Batter  | 1                     | 2          | 3            | 4          | 5                    | 6          | 7                     | 8 | 9 |
|---|-----------------------|------------|--------------|------------|----------------------|------------|-----------------------|---|---|
| <b>Peanuts Lowrey, R</b> (1, 5)<br>OBP: 0.324, SLG: 0.301   | 4-0<br>BB             |            | 0-0<br>1B    |            |                      | 0-0<br>F8  | 0-0<br>1B             |   |   |
| <b>Red Schoendienst, S</b> (1, 4)<br>OBP: 0.316, SLG: 0.409   | 0-0<br>1B             |            | 0-0<br>1-5-3 |            |                      | 0-0<br>4-3 | 0-0<br>F7             |   |   |
| <b>Bill Howerton, L</b> (1, 8)<br>OBP: 0.380, SLG: 0.512  | 0-0<br>F6             |            |              | 0-0<br>4-3 |                      | 4-0<br>BB  |                       |   |   |
| <b>Enos Slaughter, L</b> (1, 9)<br>OBP: 0.382, SLG: 0.409   | 0-0<br>G4-6-3<br>1-2f |            |              | 0-0<br>F7  |                      | 0-0<br>F7  |                       |   |   |
| <b>Hal Rice, L</b> (1, 7)<br>OBP: 0.266, SLG: 0.270   |                       | 0-0<br>L6  |              | 0-0<br>F4  |                      |            | 0-0<br>6-3            |   |   |
| <b>Marty Marion, R</b> (1, 6)<br>OBP: 0.329, SLG: 0.317   |                       | 0-3<br>K   |              |            | 0-3<br>K             |            | 0-0<br>E3<br>1B       |   |   |
| <b>Rocky Nelson, L</b> (1, 3)<br>OBP: 0.324, SLG: 0.336   |                       | 0-0<br>4-3 |              |            | 4-0<br>FC4-6<br>BB   |            | 0-0<br>1B<br>F8<br>1B |   |   |
| <b>Del Rice, R</b> (1, 2)<br>OBP: 0.323, SLG: 0.378   |                       |            | 0-0<br>1-3   |            | 0-3<br>K             |            | 0-0<br>1B<br>1B       |   |   |
| <b>Max Lanier, R</b> (1, 1)<br>OBP: 0.197, SLG: 0.206<br><b>Gerry Staley, R</b> (6, 1)<br>OBP: 0.200, SLG: 0.192<br><b>Joe Garagiola, L</b> (7, PH)<br>OBP: 0.388, SLG: 0.477 |                       |            | 0-0<br>4-3   |            | 0-0<br>FC4-6<br>1-2f |            | 0-0<br>F8<br>3-H      |   |   |

|                     |                              |                                 |                              |                                 |                              |                                 |                              |                                 |                              |                                  |                              |                                 |                              |                                 |                                  |                                    |                                  |        |
|---------------------|------------------------------|---------------------------------|------------------------------|---------------------------------|------------------------------|---------------------------------|------------------------------|---------------------------------|------------------------------|----------------------------------|------------------------------|---------------------------------|------------------------------|---------------------------------|----------------------------------|------------------------------------|----------------------------------|--------|
| <b>Inning Stats</b> | R: 0<br>E: 0<br>K: 0<br>S: 3 | H: 1<br>LOB: 1<br>BB: 1<br>P: 7 | R: 0<br>E: 0<br>K: 1<br>S: 5 | H: 0<br>LOB: 0<br>BB: 0<br>P: 5 | R: 0<br>E: 0<br>K: 0<br>S: 4 | H: 1<br>LOB: 1<br>BB: 0<br>P: 4 | R: 0<br>E: 0<br>K: 0<br>S: 3 | H: 0<br>LOB: 0<br>BB: 0<br>P: 3 | R: 0<br>E: 0<br>K: 2<br>S: 7 | H: 0<br>LOB: 1<br>BB: 1<br>P: 11 | R: 0<br>E: 0<br>K: 0<br>S: 3 | H: 0<br>LOB: 1<br>BB: 1<br>P: 7 | R: 2<br>E: 1<br>K: 0<br>S: 7 | H: 3<br>LOB: 2<br>BB: 0<br>P: 7 | 1B: 5<br>2B: 0<br>3B: 0<br>HR: 0 | SF: 0<br>SAC: 0<br>DP: 1<br>HBP: 0 | WP: 0<br>PB: 0<br>SB: 0<br>CS: 0 | PA: 29 |
|---------------------|------------------------------|---------------------------------|------------------------------|---------------------------------|------------------------------|---------------------------------|------------------------------|---------------------------------|------------------------------|----------------------------------|------------------------------|---------------------------------|------------------------------|---------------------------------|----------------------------------|------------------------------------|----------------------------------|--------|

|   |   |                |   |
|---|---|----------------|---|
| <b>PITCHER</b><br><b>Howie Fox, R</b> (1, 1)<br>ERA: 4.25 | IP 7.0<br>WLS W<br>BF 29<br>H 5<br>R 2<br>ER 0<br>SO 3<br>BB 3<br>IBB 0<br>HBP 0<br>BLK 0<br>WP 0<br>HR 0<br>S 32<br>P 44<br>ERA 0.00<br>WHIP 1.143 | <b>PITCHER</b> | IP<br>WLS<br>BF<br>H<br>R<br>ER<br>SO<br>BB<br>IBB<br>HBP<br>BLK<br>WP<br>HR<br>S<br>P<br>ERA<br>WHIP |
|---|---|----------------|---|

**BOTTOM**

|     |   |   |   |   |   |   |   |   |   |
|-----|---|---|---|---|---|---|---|---|---|
| AB  | 3 | 4 | 2 | 3 | 3 | 3 | 3 | 3 | 3 |
| R   | 0 | 0 | 0 | 0 | 0 | 0 | 0 | 0 | 1 |
| H   | 2 | 1 | 0 | 0 | 0 | 0 | 0 | 0 | 0 |
| RBI | 0 | 0 | 0 | 0 | 0 | 0 | 0 | 0 | 0 |
| BB  | 1 | 0 | 0 | 0 | 0 | 0 | 0 | 0 | 0 |
| SO  | 0 | 0 | 0 | 0 | 0 | 0 | 0 | 0 | 0 |
| LOB | 0 | 3 | 2 | 3 | 0 | 0 | 0 | 0 | 3 |

|            |           |
|------------|-----------|
| <b>AB</b>  | <b>26</b> |
| <b>R</b>   | <b>2</b>  |
| <b>H</b>   | <b>5</b>  |
| <b>RBI</b> | <b>2</b>  |
| <b>BB</b>  | <b>3</b>  |
| <b>SO</b>  | <b>3</b>  |
| <b>LOB</b> | <b>11</b> |



|       |        |
|-------|--------|
| WP: 0 | PA: 29 |
| PB: 0 | ERA    |
| SB: 0 | WHIP   |
| CS: 0 |        |

**Cincinnati Reds @ St. Louis Cardinals**  
**Sportsman's Park, St. Louis, MO**  
 Tue Sep 26 1950, 4:33 AM EST  
 Att. 2,531 - Unknown - 65 F

[livebaseballscorecards.com](http://livebaseballscorecards.com)

| Batter  | 1  | 2                               | 3                            | 4                               | 5                            | 6                               | 7                            | 8                               | 9                            | AB R H RBI BB SO LOB            | TOP                          |                                  |                              |                                 |                              |                                 |                                  |                                    |                                  |   |
|---|--|---------------------------------|------------------------------|---------------------------------|------------------------------|---------------------------------|------------------------------|---------------------------------|------------------------------|---------------------------------|------------------------------|----------------------------------|------------------------------|---------------------------------|------------------------------|---------------------------------|----------------------------------|------------------------------------|----------------------------------|---|
| <b>Bobby Adams, R</b> (1, 4)<br>OBP: 0.369, SLG: 0.420        | 0-0<br>6-3   |                                 | 0-0<br>5-3                   |                                 |                              | 0-0<br>FC6-4<br>1B              |                              |                                 | 0-3<br>K                     | 4 0 1 0 0 1 1                   |                              |                                  |                              |                                 |                              |                                 |                                  |                                    |                                  |   |
| <b>Bob Usher, R</b> (1, 8)<br>OBP: 0.307, SLG: 0.358          | 0-3<br>K   |                                 |                              |                                 | 0-3<br>K                     | 0-0<br>FC6-4<br>1-2f            |                              |                                 | 0-0<br>F4                    | 4 0 0 0 0 2 1                   |                              |                                  |                              |                                 |                              |                                 |                                  |                                    |                                  |   |
| <b>Johnny Wyrostek, L</b> (1, 9)<br>OBP: 0.365, SLG: 0.429    | 0-0<br>4-3   |                                 |                              |                                 | 0-0<br>G4-6-3<br>1B          |                                 |                              |                                 | 0-0<br>F8                    | 4 0 1 0 0 1 0                   |                              |                                  |                              |                                 |                              |                                 |                                  |                                    |                                  |   |
| <b>Ted Kluszewski, L</b> (1, 3)<br>OBP: 0.351, SLG: 0.523     |  | 0-0<br>F8                       |                              |                                 | 0-0<br>G4-6-3<br>1-2f        |                                 |                              |                                 | 0-3<br>K                     | 3 0 0 0 0 1 1                   |                              |                                  |                              |                                 |                              |                                 |                                  |                                    |                                  |   |
| <b>Joe Adcock, R</b> (1, 7)<br>OBP: 0.317, SLG: 0.395         |  | 0-0<br>F5                       |                              |                                 |                              | 0-3<br>K                        |                              |                                 | 4-0<br>BB                    | 2 0 0 0 1 1 0                   |                              |                                  |                              |                                 |                              |                                 |                                  |                                    |                                  |   |
| <b>Johnny Pramesa, R</b> (1, 2)<br>OBP: 0.367, SLG: 0.434     |  | 0-0<br>6-3                      |                              |                                 |                              | 0-0<br>F3                       |                              |                                 | 0-0<br>5-3                   | 3 0 0 0 0 0 1                   |                              |                                  |                              |                                 |                              |                                 |                                  |                                    |                                  |   |
| <b>Grady Hatton, L</b> (1, 5)<br>OBP: 0.368, SLG: 0.384       |  |                                 |                              |                                 |                              | 0-0<br>F6                       |                              |                                 | 0-0<br>F7                    | 3 0 1 0 0 0 0                   |                              |                                  |                              |                                 |                              |                                 |                                  |                                    |                                  |   |
| <b>Virgil Stallcup, R</b> (1, 6)<br>OBP: 0.279, SLG: 0.363    |  |                                 |                              |                                 |                              | 0-0<br>L1                       |                              |                                 | 0-0<br>F7                    | 3 0 0 0 0 0 1                   |                              |                                  |                              |                                 |                              |                                 |                                  |                                    |                                  |   |
| <b>Willie Ramsdell, R</b> (1, 1)<br>OBP: 0.250, SLG: 0.192    |  |                                 |                              |                                 |                              | 0-0<br>F4                       |                              |                                 | 0-0<br>F7                    | 2 0 0 0 0 0 0                   |                              |                                  |                              |                                 |                              |                                 |                                  |                                    |                                  |   |
| <b>Inning Stats</b>   | R: 0<br>E: 0<br>K: 1<br>S: 5   | H: 0<br>LOB: 0<br>BB: 0<br>P: 5 | R: 0<br>E: 0<br>K: 0<br>S: 3 | H: 0<br>LOB: 0<br>BB: 0<br>P: 3 | R: 0<br>E: 0<br>K: 0<br>S: 4 | H: 1<br>LOB: 1<br>BB: 0<br>P: 4 | R: 0<br>E: 0<br>K: 1<br>S: 5 | H: 1<br>LOB: 0<br>BB: 0<br>P: 5 | R: 0<br>E: 0<br>K: 1<br>S: 5 | H: 0<br>LOB: 0<br>BB: 0<br>P: 5 | R: 0<br>E: 0<br>K: 2<br>S: 7 | H: 0<br>LOB: 1<br>BB: 1<br>P: 11 | R: 0<br>E: 0<br>K: 3<br>S: 3 | H: 0<br>LOB: 0<br>BB: 0<br>P: 3 | R: 0<br>E: 0<br>K: 1<br>S: 5 | H: 0<br>LOB: 0<br>BB: 0<br>P: 5 | 1B: 3<br>2B: 0<br>3B: 0<br>HR: 0 | SF: 0<br>SAC: 1<br>DP: 1<br>HBP: 0 | WP: 0<br>PB: 0<br>SB: 0<br>CS: 0 | PA: 30  |
| <b>PITCHER</b><br><b>Harry Brecheen, L</b> (1, 1)<br>ERA: 3.8 | IP: 9.0<br>WLS: W<br>BF: 30<br>H: 3<br>R: 0<br>ER: 0<br>SO: 6<br>BB: 1<br>IBB: 0<br>HBP: 0<br>BLK: 0<br>WP: 0<br>HR: 0<br>S: 41<br>P: 45<br>ERA: 0.00<br>WHIP: 0.444 |                                 |                              |                                 |                              |                                 |                              |                                 |                              |                                 |                              |                                  |                              |                                 |                              |                                 |                                  |                                    |                                  | <b>PITCHER</b><br>IP: WLS: BF: H: R: ER: SO: BB: IBB: HBP: BLK: WP: HR: S: P: ERA: WHIP |

**Cincinnati Reds @ St. Louis Cardinals**  
**Sportsman's Park, St. Louis, MO**  
 Wed Sep 27 1950, 4:33 AM EST  
 Att: 2,094 - Unknown - 66 F

[livebaseballscorecards.com](http://livebaseballscorecards.com)

|            |           |
|------------|-----------|
| <b>AB</b>  | <b>28</b> |
| <b>R</b>   | <b>0</b>  |
| <b>H</b>   | <b>3</b>  |
| <b>RBI</b> | <b>0</b>  |
| <b>BB</b>  | <b>1</b>  |
| <b>SO</b>  | <b>6</b>  |
| <b>LOB</b> | <b>5</b>  |





| Batter  | 1                            | 2                               | 3                            | 4                               | 5                            | 6                               | 7                            | 8                               | 9                            | AB                              | R                            | H                               | RBI                          | BB                              | SO                           | LOB                             |               |
|---|------------------------------|---------------------------------|------------------------------|---------------------------------|------------------------------|---------------------------------|------------------------------|---------------------------------|------------------------------|---------------------------------|------------------------------|---------------------------------|------------------------------|---------------------------------|------------------------------|---------------------------------|---------------|
| <b>Peanuts Lowrey, R</b><br>OBP: 0.326, SLG: 0.301 (1, 4)       | 0-0<br>1B                    |                                 | H 1-0<br>1-2<br>HBP          |                                 | X 0-0<br>5-3                 |                                 |                              | X 0-0<br>5-3                    |                              | 3                               | 0                            | 1                               | 0                            | 0                               | 0                            | 0                               |               |
| <b>Red Schoendienst, S</b><br>OBP: 0.314, SLG: 0.407 (1, 6)     | 0-0<br>1-3                   |                                 | S S 0-3<br>K                 |                                 |                              | X 0-0<br>F5                     |                              | X 0-0<br>F3                     |                              | 4                               | 0                            | 0                               | 0                            | 0                               | 1                            | 3                               |               |
| <b>Stan Musial, L</b><br>OBP: 0.434, SLG: 0.592 (1, 3)          | 0-0<br>5-3                   |                                 | X 0-0<br>G3-6-3              |                                 |                              | X 0-0<br>L4-6 BB<br>1B          |                              |                                 |                              | 3                               | 0                            | 1                               | 0                            | 0                               | 0                            | 2                               |               |
| <b>Enos Slaughter, L</b><br>OBP: 0.366, SLG: 0.412 (1, 9)       | 4-0<br>FC4-6<br>BB           |                                 |                              | X 0-0<br>4-3<br>2B              |                              | B B B 4-0<br>1-2<br>BB          |                              |                                 |                              | 1                               | 0                            | 1                               | 0                            | 2                               | 0                            | 0                               |               |
| <b>Bill Howerton, L</b><br>OBP: 0.376, SLG: 0.507 (1, 8)        | 0-0<br>FC4-6                 |                                 |                              | X 0-0<br>F9                     |                              | X 0-0<br>L4-6                   |                              |                                 |                              | 3                               | 0                            | 0                               | 0                            | 0                               | 0                            | 4                               |               |
| <b>Hal Rice, L</b><br>OBP: 0.260, SLG: 0.263 (1, 7)             |                              | X 0-0<br>4-3                    |                              | X 0-0<br>4-3                    |                              | X 0-0<br>F5                     |                              |                                 |                              | 3                               | 0                            | 0                               | 0                            | 0                               | 0                            | 1                               |               |
| <b>Eddie Kazak, R</b><br>OBP: 0.302, SLG: 0.332 (1, 5)          |                              | X 0-0<br>5-3                    |                              | X 0-0<br>5-3                    |                              | 0-0<br>K                        |                              |                                 |                              | 3                               | 0                            | 0                               | 0                            | 0                               | 1                            | 1                               |               |
| <b>Del Rice, R</b><br>OBP: 0.321, SLG: 0.375 (1, 2)             |                              | X 0-0<br>F4                     |                              |                                 | X 0-0<br>F2                  |                                 | X 0-0<br>F7                  |                                 |                              | 3                               | 0                            | 0                               | 0                            | 0                               | 0                            | 0                               |               |
| <b>Harry Brecheen, L</b><br>OBP: 0.302, SLG: 0.328 (1, 1)       |                              |                                 | B B B 4-0<br>E HBP<br>BB     |                                 | X 0-0<br>F7                  |                                 | X 0-0<br>F9                  |                                 |                              | 2                               | 0                            | 0                               | 0                            | 1                               | 0                            | 0                               |               |
| <b>Inning Stats</b>   | R: 1<br>E: 1<br>K: 0<br>S: 4 | H: 1<br>LOB: 1<br>BB: 1<br>P: 8 | R: 0<br>E: 0<br>K: 0<br>S: 3 | H: 0<br>LOB: 0<br>BB: 0<br>P: 3 | R: 0<br>E: 1<br>K: 1<br>S: 4 | H: 0<br>LOB: 1<br>BB: 1<br>P: 9 | R: 0<br>E: 0<br>K: 0<br>S: 4 | H: 1<br>LOB: 1<br>BB: 0<br>P: 4 | R: 0<br>E: 0<br>K: 0<br>S: 3 | H: 0<br>LOB: 0<br>BB: 0<br>P: 3 | R: 0<br>E: 0<br>K: 1<br>S: 5 | H: 0<br>LOB: 0<br>BB: 0<br>P: 5 | R: 0<br>E: 0<br>K: 0<br>S: 3 | H: 0<br>LOB: 0<br>BB: 0<br>P: 3 | R: 0<br>E: 0<br>K: 0<br>S: 3 | H: 0<br>LOB: 0<br>BB: 0<br>P: 3 |               |
| <b>PITCHER</b><br><b>Willie Ramsdell, R</b><br>ERA: 3.73 (1, 1) | IP<br>8.0                    | WLS<br>L                        | BF<br>29                     | H<br>3                          | R<br>1                       | ER<br>0                         | SO<br>2                      | BB<br>3                         | IBB<br>0                     | HBP<br>1                        | BLK<br>0                     | WP<br>0                         | HR<br>0                      | S<br>29                         | P<br>42                      | ERA<br>0.00                     | WHIP<br>0.750 |

**BOTTOM**

**Cincinnati Reds @ St. Louis Cardinals**  
Sportsman's Park, St. Louis, MO  
Wed Sep 27 1950, 4:33 AM EST  
Att. 2,094 - Unknown - 66 F

[livebaseballscorecards.com](http://livebaseballscorecards.com)

|            |           |
|------------|-----------|
| <b>AB</b>  | <b>25</b> |
| <b>R</b>   | <b>0</b>  |
| <b>H</b>   | <b>3</b>  |
| <b>RBI</b> | <b>0</b>  |
| <b>BB</b>  | <b>3</b>  |
| <b>SO</b>  | <b>2</b>  |
| <b>LOB</b> | <b>11</b> |



|       |        |
|-------|--------|
| WP: 0 | PA: 29 |
| PB: 0 |        |
| SB: 0 |        |
| CS: 0 |        |

| Batter   | 1  | 2                               | 3                            | 4                               | 5                            | 6                               | 7                            | 8                               | 9                            | AB R H RBI BB SO LOB            | TOP                          |                                 |                              |                                 |                              |                                 |                                  |                                    |                                  |        |
|--|--|---------------------------------|------------------------------|---------------------------------|------------------------------|---------------------------------|------------------------------|---------------------------------|------------------------------|---------------------------------|------------------------------|---------------------------------|------------------------------|---------------------------------|------------------------------|---------------------------------|----------------------------------|------------------------------------|----------------------------------|--------|
| <b>Bobby Adams, R</b> (1, 4)<br>OBP: 0.365, SLG: 0.415       | 0-0<br>F7  |                                 | 0-0<br>F8                    |                                 |                              | 0-0<br>F4                       |                              | 0-0<br>F7                       |                              | 4 0 0 0 0 0 1                   |                              |                                 |                              |                                 |                              |                                 |                                  |                                    |                                  |        |
| <b>Bob Usher, R</b> (1, 8)<br>OBP: 0.309, SLG: 0.363         | 0-0<br>F2  |                                 |                              | 0-0<br>2B                       |                              | 0-0<br>1B                       |                              | 0-0<br>F2                       |                              | 4 0 2 0 0 0 1                   |                              |                                 |                              |                                 |                              |                                 |                                  |                                    |                                  |        |
| <b>Johnny Wyrostek, L</b> (1, 9)<br>OBP: 0.363, SLG: 0.426   | 0-0<br>F8  |                                 |                              | 0-0<br>F8                       |                              | 0-0<br>G1-6-3                   |                              |                                 | 0-0<br>1-3                   | 4 0 0 0 0 0 2                   |                              |                                 |                              |                                 |                              |                                 |                                  |                                    |                                  |        |
| <b>Ted Kluszewski, L</b> (1, 3)<br>OBP: 0.351, SLG: 0.521    |  | 0-3<br>K                        |                              | 0-0<br>F8                       |                              |                                 | 0-0<br>1B                    |                                 | 0-0<br>L4                    | 4 0 1 0 0 1 1                   |                              |                                 |                              |                                 |                              |                                 |                                  |                                    |                                  |        |
| <b>Joe Adcock, R</b> (1, 7)<br>OBP: 0.325, SLG: 0.400        |  | 0-0<br>FC4-6                    |                              | 4-0<br>BB                       |                              |                                 | 0-0<br>1-2                   |                                 | 0-0<br>1B                    | 3 0 3 0 1 0 0                   |                              |                                 |                              |                                 |                              |                                 |                                  |                                    |                                  |        |
| <b>Grady Hatton, L</b> (1, 5)<br>OBP: 0.365, SLG: 0.380      |  | 0-0<br>FC4-6                    |                              | 0-0<br>F8                       |                              |                                 | 0-0<br>F8                    |                                 | 0-3<br>K                     | 4 0 0 0 0 1 6                   |                              |                                 |                              |                                 |                              |                                 |                                  |                                    |                                  |        |
| <b>Virgil Stallcup, R</b> (1, 6)<br>OBP: 0.278, SLG: 0.361   |  | 0-0<br>F3                       |                              |                                 | 0-0<br>F4                    |                                 | 0-0<br>G5-4-3                |                                 |                              | 3 0 0 0 0 0 3                   |                              |                                 |                              |                                 |                              |                                 |                                  |                                    |                                  |        |
| <b>Dixie Howell, R</b> (1, 2)<br>OBP: 0.331, SLG: 0.305      |  |                                 | 0-0<br>5-3                   |                                 | 0-0<br>F5                    |                                 |                              | 4-0<br>BB                       |                              | 2 0 0 0 1 0 0                   |                              |                                 |                              |                                 |                              |                                 |                                  |                                    |                                  |        |
| <b>Ken Raffensberger, R</b> (1, 1)<br>OBP: 0.174, SLG: 0.195 |  |                                 | 0-0<br>F9                    |                                 | 0-0<br>1-3                   |                                 |                              | 0-3<br>K                        |                              | 1 0 0 0 0 0 0                   |                              |                                 |                              |                                 |                              |                                 |                                  |                                    |                                  |        |
| <b>Bud Byerly, R</b> (3, 1)<br>OBP: 0.349, SLG: 0.360        |  |                                 |                              |                                 |                              |                                 |                              |                                 |                              | 0 0 0 0 0 0 0                   |                              |                                 |                              |                                 |                              |                                 |                                  |                                    |                                  |        |
| <b>Connie Ryan, R</b> (5, PH)<br>OBP: 0.332, SLG: 0.333      |  |                                 |                              |                                 |                              |                                 |                              |                                 |                              | 1 0 0 0 0 0 0                   |                              |                                 |                              |                                 |                              |                                 |                                  |                                    |                                  |        |
| <b>Kent Peterson, R</b> (5, 1)<br>OBP: 0.375, SLG: 0.463     |  |                                 |                              |                                 |                              |                                 |                              |                                 |                              | 0 0 0 0 0 0 0                   |                              |                                 |                              |                                 |                              |                                 |                                  |                                    |                                  |        |
| <b>Danny Litwhiler, R</b> (8, PH)<br>OBP: 0.300, SLG: 0.222  |  |                                 |                              |                                 |                              |                                 |                              |                                 |                              | 1 0 0 0 0 1 1                   |                              |                                 |                              |                                 |                              |                                 |                                  |                                    |                                  |        |
| <b>Johnny Hetki, R</b> (8, 1)                                |  |                                 |                              |                                 |                              |                                 |                              |                                 |                              | 0 0 0 0 0 0 0                   |                              |                                 |                              |                                 |                              |                                 |                                  |                                    |                                  |        |
| <b>Inning Stats</b>  | R: 0<br>E: 0<br>K: 0<br>S: 3   | H: 0<br>LOB: 0<br>BB: 0<br>P: 3 | R: 0<br>E: 0<br>K: 1<br>S: 6 | H: 1<br>LOB: 1<br>BB: 0<br>P: 6 | R: 0<br>E: 0<br>K: 0<br>S: 3 | H: 0<br>LOB: 0<br>BB: 0<br>P: 3 | R: 0<br>E: 0<br>K: 0<br>S: 4 | H: 1<br>LOB: 2<br>BB: 1<br>P: 8 | R: 0<br>E: 0<br>K: 0<br>S: 3 | H: 0<br>LOB: 0<br>BB: 0<br>P: 3 | R: 0<br>E: 0<br>K: 0<br>S: 4 | H: 2<br>LOB: 1<br>BB: 0<br>P: 4 | R: 0<br>E: 0<br>K: 1<br>S: 5 | H: 0<br>LOB: 1<br>BB: 1<br>P: 9 | R: 0<br>E: 0<br>K: 1<br>S: 6 | H: 1<br>LOB: 1<br>BB: 0<br>P: 6 | 1B: 5<br>2B: 1<br>3B: 0<br>HR: 0 | SF: 0<br>SAC: 0<br>DP: 2<br>HBP: 0 | WP: 0<br>PB: 0<br>SB: 0<br>CS: 0 | PA: 33 |
| <b>PITCHER</b><br><b>Howie Pollet, L</b> (1, 1)<br>ERA: 3.3  | IP: 9.0<br>WLS: W<br>BF: 33<br>H: 6<br>R: 0<br>ER: 0<br>SO: 3<br>BB: 2<br>IBB: 0<br>HBP: 0<br>BLK: 0<br>WP: 0<br>HR: 0<br>S: 37<br>P: 45<br>ERA: 0.00<br>WHIP: 0.889 |                                 |                              |                                 |                              |                                 |                              |                                 |                              |                                 |                              |                                 |                              |                                 |                              |                                 |                                  |                                    |                                  |        |
| <b>PITCHER</b>   | IP   | WLS                             | BF                           | H                               | R                            | ER                              | SO                           | BB                              | IBB                          | HBP                             | BLK                          | WP                              | HR                           | S                               | P                            | ERA                             | WHIP                             |                                    |                                  |        |

**Cincinnati Reds @ St. Louis Cardinals**  
**Sportsman's Park, St. Louis, MO**  
 Thu Sep 28 1950, 4:33 AM EST  
 Att. 2,749 - Unknown

[livebaseballscorecards.com](http://livebaseballscorecards.com)

|     |    |
|-----|----|
| AB  | 31 |
| R   | 0  |
| H   | 6  |
| RBI | 0  |
| BB  | 2  |
| SO  | 3  |
| LOB | 15 |



| Batter  | 1          | 2                   | 3                       | 4          | 5          | 6             | 7                  | 8          | 9 |
|---|------------|---------------------|-------------------------|------------|------------|---------------|--------------------|------------|---|
| <b>Peanuts Lowrey, R</b><br>OBP: 0.330, SLG: 0.306<br>(1, 4)  | 0-0<br>1B  |                     | 0-0<br>1B               |            |            | 0-0<br>4-3    |                    | 0-0<br>L6  |   |
| <b>Red Schoendienst, S</b><br>OBP: 0.315, SLG: 0.406<br>(1, 6)  | 0-0<br>F9  |                     | 0-0<br>1B               |            |            | 4-0<br>BB     |                    | 0-0<br>4-3 |   |
| <b>Stan Musial, L</b><br>OBP: 0.432, SLG: 0.587<br><b>Don Bollweg, L</b><br>(7, 3)                                      | 0-0<br>4-3 |                     | 0-0<br>4-3              | 0-0<br>4-3 |            | 0-0<br>G4-6-3 |                    |            |   |
| <b>Enos Slaughter, L</b><br>OBP: 0.386, SLG: 0.413<br><b>Hal Rice, L</b><br>OBP: 0.256, SLG: 0.258<br>(3, PR)<br>(4, 7) | 0-0<br>1-3 |                     | 0-0<br>BB 1B<br>2B 1B   | 0-0<br>5-3 |            |               | 0-0<br>6-3         |            |   |
| <b>Bill Howerton, L</b><br>OBP: 0.378, SLG: 0.507<br>(4, 9)   |            | 0-0<br>F8           | 0-0<br>BB 1B<br>2B 1B   | 0-0<br>1B  |            |               | 0-3<br>K           |            |   |
| <b>Eddie Kazak, R</b><br>OBP: 0.311, SLG: 0.347<br>(1, 5)   |            | 0-0<br>2B 3B        | 4-0<br>1-2 2-3<br>2B BB | 0-0<br>F7  |            |               | 0-0<br>BB 1B       |            |   |
| <b>Chuck Diering, R</b><br>OBP: 0.361, SLG: 0.348<br>(1, 8)   |            | 0-0<br>1B 2B        | 0-0<br>1B 2B            |            | 0-0<br>6-3 |               | 4-0<br>FC6-4<br>BB |            |   |
| <b>Del Rice, R</b><br>OBP: 0.322, SLG: 0.376<br>(1, 2)  |            | 0-0<br>G6-4-3<br>1B | 0-0<br>2-H<br>1B        |            | 0-0<br>F3  |               | 0-0<br>FC6-4       |            |   |
| <b>Howie Pollet, L</b><br>OBP: 0.191, SLG: 0.167<br>(1, 1)  |            | 0-0<br>G6-4-3       | 0-3<br>K                |            | 0-0<br>F5  |               | 0-0<br>6-3         |            |   |

| Inning Stats                      | R: 0<br>E: 0<br>K: 0<br>S: 4       | H: 1<br>LOB: 1<br>BB: 0<br>P: 4  | R: 1<br>E: 0<br>K: 0<br>S: 5 | H: 3<br>LOB: 1<br>BB: 0<br>P: 5 | R: 6<br>E: 0<br>K: 1<br>S: 12 | H: 7<br>LOB: 2<br>BB: 1<br>P: 16 | R: 0<br>E: 0<br>K: 0<br>S: 4 | H: 1<br>LOB: 1<br>BB: 0<br>P: 4 | R: 0<br>E: 0<br>K: 0<br>S: 3 | H: 0<br>LOB: 0<br>BB: 0<br>P: 3 | R: 0<br>E: 0<br>K: 0<br>S: 2 | H: 0<br>LOB: 0<br>BB: 1<br>P: 6 | R: 0<br>E: 0<br>K: 1<br>S: 6 | H: 1<br>LOB: 2<br>BB: 1<br>P: 10 | R: 0<br>E: 0<br>K: 0<br>S: 3 | H: 0<br>LOB: 0<br>BB: 0<br>P: 3 |
|-----------------------------------|------------------------------------|----------------------------------|------------------------------|---------------------------------|-------------------------------|----------------------------------|------------------------------|---------------------------------|------------------------------|---------------------------------|------------------------------|---------------------------------|------------------------------|----------------------------------|------------------------------|---------------------------------|
| 1B: 10<br>2B: 2<br>3B: 1<br>HR: 0 | SF: 0<br>SAC: 0<br>DP: 2<br>HBP: 0 | WP: 0<br>PB: 0<br>SB: 0<br>CS: 0 | WP: 0<br>PA: 38              |                                 |                               |                                  |                              |                                 |                              |                                 |                              |                                 |                              |                                  |                              |                                 |

| PITCHER  | IP  | WLS | BF | H | R | ER | SO | BB | IBB | HBP | BLK | WP | HR | S  | P  | ERA   | WHIP  |
|--|-----|-----|----|---|---|----|----|----|-----|-----|-----|----|----|----|----|-------|-------|
| <b>Ken Raffensberger, L</b><br>ERA: 4.37<br>(1, 1) | 2.1 | L   | 16 | 9 | 7 | 7  | 0  | 1  | 0   | 0   | 0   | 0  | 0  | 15 | 19 | 27.00 | 4.286 |
| <b>Bud Byerly, R</b><br>ERA: 2.7<br>(3, 1)         | 1.2 |     | 8  | 3 | 0 | 0  | 1  | 0  | 0   | 0   | 0   | 0  | 0  | 10 | 10 | 0.00  | 1.800 |
| <b>Kent Peterson, L</b><br>ERA: 7.65<br>(5, 1)     | 3.0 |     | 11 | 1 | 0 | 0  | 1  | 2  | 0   | 0   | 0   | 0  | 0  | 11 | 19 | 0.00  | 1.000 |
| <b>Johnny Hetki, R</b><br>ERA: 5.19<br>(8, 1)      | 1.0 |     | 3  | 0 | 0 | 0  | 0  | 0  | 0   | 0   | 0   | 0  | 0  | 3  | 3  | 0.00  | 0.000 |

**BOTTOM**

**Cincinnati Reds @ St. Louis Cardinals**  
Sportsman's Park, St. Louis, MO  
Thu Sep 28 1950, 4:33 AM EST  
Att. 2,749 - Unknown

livebaseballscorecards.com

|            |           |
|------------|-----------|
| <b>AB</b>  | <b>35</b> |
| <b>R</b>   | <b>6</b>  |
| <b>H</b>   | <b>13</b> |
| <b>RBI</b> | <b>7</b>  |
| <b>BB</b>  | <b>3</b>  |
| <b>SO</b>  | <b>2</b>  |
| <b>LOB</b> | <b>13</b> |



| Batter   | 1  | 2                               | 3                            | 4                               | 5                            | 6                               | 7                            | 8                               | 9                            | AB R H RBI BB SO LOB            | TOP  |                                 |  |                                 |                              |                                 |                              |                                 |                                  |                                    |                                  |        |
|--|--|---------------------------------|------------------------------|---------------------------------|------------------------------|---------------------------------|------------------------------|---------------------------------|------------------------------|---------------------------------|--|---------------------------------|--|---------------------------------|------------------------------|---------------------------------|------------------------------|---------------------------------|----------------------------------|------------------------------------|----------------------------------|--------|
| Bob Dillinger, R (1, 5)<br>OBP: 0.353, SLG: 0.412    | 0-0 1-3  |                                 | 0-0 F9                       |                                 | 0-0 1-3                      |                                 |                              | 0-0 G3                          |                              | 4 0 0 0 0 0 1                   | <b>Pittsburgh Pirates @ Cincinnati Reds</b><br>Crosley Field, Cincinnati, OH<br>Sat Sep 30 1950, 3:33 AM EST<br>Att. 1,719 - Overcast - 80 F |                                 |  |                                 |                              |                                 |                              |                                 |                                  |                                    |                                  |        |
| Danny O'Connell, R (1, 6)<br>OBP: 0.352, SLG: 0.436  | 0-0 F5   |                                 | 0-0 2-3                      |                                 |                              | 0-0 F8                          |                              | 0-0 5-3                         |                              | 4 1 2 1 0 0 0                   |  |                                 |  |                                 |                              |                                 |                              |                                 |                                  |                                    |                                  |        |
| Ralph Kiner, R (1, 7)<br>OBP: 0.411, SLG: 0.596      | 0-0 6-3  |                                 | 0-0 3-H                      |                                 |                              | 0-0 2-3                         |                              | 0-0 F4                          |                              | 4 0 0 0 0 0 2                   |  |                                 |  |                                 |                              |                                 |                              |                                 |                                  |                                    |                                  |        |
| Gus Bell, L (1, 9)<br>OBP: 0.333, SLG: 0.448         |  | 0-0 F8                          |                              | 0-0 F9                          |                              | 0-0 4-3                         |                              | 0-0 1-3                         |                              | 4 0 0 1 0 0 0                   |  |                                 |  |                                 |                              |                                 |                              |                                 |                                  |                                    |                                  |        |
| Wally Westlake, R (1, 8)<br>OBP: 0.356, SLG: 0.482   |  | 0-0 F3                          |                              | 0-0 1B                          |                              | 0-0 6-3                         |                              | 0-3 K                           |                              | 4 0 1 0 0 1 0                   |  |                                 |  |                                 |                              |                                 |                              |                                 |                                  |                                    |                                  |        |
| Jack Phillips, R (1, 3)<br>OBP: 0.348, SLG: 0.449    |  | 0-0 2B                          |                              | 0-0 F6                          |                              | 0-0 6-3                         |                              | 0-0 1-3                         |                              | 4 0 1 0 0 0 1                   |  |                                 |  |                                 |                              |                                 |                              |                                 |                                  |                                    |                                  |        |
| Johnny Berardino, R (1, 4)<br>OBP: 0.304, SLG: 0.256 |  | 0-0 6-3                         |                              | 0-0 4-3                         |                              | 0-0 2B                          |                              |                                 |                              | 3 0 1 0 0 0 2                   |  |                                 |  |                                 |                              |                                 |                              |                                 |                                  |                                    |                                  |        |
| Clyde McCullough, R (1, 2)<br>OBP: 0.340, SLG: 0.406 |  |                                 | 0-0 F9                       |                                 | 0-0 6-3                      |                                 | 0-0 1-3                      |                                 |                              | 2 1 1 0 0 0 0                   |  |                                 |  |                                 |                              |                                 |                              |                                 |                                  |                                    |                                  |        |
| Tom Saffell, L (7, PH)<br>OBP: 0.269, SLG: 0.281     |  |                                 | 0-0 SH1-4                    |                                 |                              | 0-0 1-3                         |                              |                                 |                              | 1 0 0 0 0 0 1                   |  |                                 |  |                                 |                              |                                 |                              |                                 |                                  |                                    |                                  |        |
| Ray Mueller, R (7, 2)<br>OBP: 0.311, SLG: 0.415      |  |                                 | 0-0 2B                       |                                 |                              | 0-0 6-3                         |                              |                                 |                              | 0 0 0 0 0 0 0                   |  |                                 |  |                                 |                              |                                 |                              |                                 |                                  |                                    |                                  |        |
| Bill Werle, L (1, 1)<br>OBP: 0.264, SLG: 0.242       |  |                                 | 0-0 SH1-4                    |                                 |                              | 0-0 1-3                         |                              |                                 |                              | 1 0 0 0 0 0 0                   |  |                                 |  |                                 |                              |                                 |                              |                                 |                                  |                                    |                                  |        |
| Danny Murtaugh, R (7, PH)<br>OBP: 0.377, SLG: 0.392  |  |                                 | 0-0 1-2                      |                                 |                              |                                 |                              |                                 |                              | 1 0 0 0 0 0 1                   |  |                                 |  |                                 |                              |                                 |                              |                                 |                                  |                                    |                                  |        |
| Junior Walsh, R (7, 1)<br>OBP: 0.444, SLG: 0.333     |  |                                 |                              |                                 |                              |                                 |                              |                                 |                              | 0 0 0 0 0 0 0                   |  |                                 |  |                                 |                              |                                 |                              |                                 |                                  |                                    |                                  |        |
| <b>Inning Stats</b>                                  | R: 0<br>E: 0<br>K: 0<br>S: 3   | H: 0<br>LOB: 0<br>BB: 0<br>P: 3 | R: 0<br>E: 0<br>K: 0<br>S: 4 | H: 1<br>LOB: 1<br>BB: 0<br>P: 4 | R: 1<br>E: 0<br>K: 0<br>S: 5 | H: 2<br>LOB: 1<br>BB: 0<br>P: 5 | R: 0<br>E: 0<br>K: 0<br>S: 4 | H: 1<br>LOB: 1<br>BB: 0<br>P: 4 | R: 0<br>E: 0<br>K: 0<br>S: 3 | H: 0<br>LOB: 0<br>BB: 0<br>P: 3 | R: 1<br>E: 0<br>K: 0<br>S: 4   | H: 1<br>LOB: 0<br>BB: 0<br>P: 4 | R: 0<br>E: 0<br>K: 0<br>S: 4   | H: 1<br>LOB: 1<br>BB: 0<br>P: 4 | R: 0<br>E: 0<br>K: 0<br>S: 3 | H: 0<br>LOB: 0<br>BB: 0<br>P: 3 | R: 0<br>E: 0<br>K: 1<br>S: 5 | H: 0<br>LOB: 0<br>BB: 0<br>P: 5 | 1B: 2<br>2B: 4<br>3B: 0<br>HR: 0 | SF: 0<br>SAC: 1<br>DP: 0<br>HBP: 0 | WP: 0<br>PB: 0<br>SB: 0<br>CS: 0 | PA: 33 |
| <b>PITCHER</b><br>Howie Fox, R (1, 1)<br>ERA: 4.14   | IP: 9.0<br>WLS: W<br>BF: 33<br>H: 6<br>R: 2<br>ER: 2<br>SO: 1<br>BB: 0<br>IBB: 0<br>HBP: 0<br>BLK: 0<br>WP: 0<br>HR: 0<br>S: 35<br>P: 35<br>ERA: 2.00<br>WHIP: 0.667 |                                 |                              |                                 |                              |                                 |                              |                                 |                              |                                 |  | <b>PITCHER</b>                  | IP: WLS: BF: H: R: ER: SO: BB: IBB: HBP: BLK: WP: HR: S: P: ERA: WHIP: |                                 |                              |                                 |                              |                                 |                                  |                                    |                                  |        |

livebaseballscorecards.com

|     |    |
|-----|----|
| AB  | 32 |
| R   | 2  |
| H   | 6  |
| RBI | 2  |
| BB  | 0  |
| SO  | 1  |
| LOB | 8  |



| Batter   | 1                        | 2                       | 3          | 4                    | 5                   | 6             | 7                     | 8         | 9 | AB | R | H | RBI | BB | SO | LOB |
|--|--------------------------|-------------------------|------------|----------------------|---------------------|---------------|-----------------------|-----------|---|----|---|---|-----|----|----|-----|
| <b>Bobby Adams, R</b><br>OBP: 0.364, SLG: 0.413 (1, 4)     | 0-0<br>1B<br>4-3<br>1B   | 0-0<br>E4<br>1-3<br>2-H |            | 0-0<br>FC6-4<br>1-2f |                     | 0-0<br>5-3    |                       |           |   | 4  | 1 | 1 | 0   | 0  | 0  | 3   |
| <b>Bob Usher, R</b><br>OBP: 0.317, SLG: 0.369 (1, 8)       | 0-0<br>1B<br>4-3<br>1B   | 4-0<br>IBB              |            |                      | 0-0<br>FC3-6<br>1B  |               | 0-0<br>FC1-6<br>1B    |           |   | 3  | 1 | 3 | 0   | 1  | 0  | 0   |
| <b>Johnny Wyrostek, L</b><br>OBP: 0.360, SLG: 0.423 (1, 9) | 0-0<br>F5                | 0-3<br>K                |            |                      | 0-0<br>FC3-6<br>1B  |               | 0-0<br>F9             |           |   | 4  | 1 | 0 | 0   | 0  | 1  | 7   |
| <b>Ted Kluszewski, L</b><br>OBP: 0.350, SLG: 0.519 (1, 3)  | 0-0<br>4-3<br>1-2<br>3-H |                         | 0-0<br>F8  |                      | 0-0<br>1B<br>1B     |               | 0-0<br>FC1-6<br>FC6-4 |           |   | 4  | 1 | 1 | 1   | 0  | 0  | 2   |
| <b>Joe Adcock, R</b><br>OBP: 0.326, SLG: 0.401 (1, 7)      | 0-0<br>1B<br>2-H         |                         | 0-0<br>6-3 |                      | 0-0<br>1B<br>1B     |               | 0-0<br>FC6-4          |           |   | 4  | 1 | 2 | 2   | 0  | 0  | 1   |
| <b>Grady Hatton, L</b><br>OBP: 0.366, SLG: 0.383 (1, 5)    | 0-0<br>4-1               |                         | 0-3<br>K   |                      | 0-0<br>G5-4-3<br>1B |               |                       | 0-0<br>2B |   | 4  | 0 | 2 | 2   | 0  | 1  | 1   |
| <b>Johnny Pramesa, R</b><br>OBP: 0.365, SLG: 0.431 (1, 2)  |                          | 0-0<br>1B<br>E4<br>1B   |            | 0-0<br>F8            |                     | 0-0<br>G5-4-3 |                       | 0-0<br>F8 |   | 4  | 0 | 1 | 0   | 0  | 0  | 2   |
| <b>Virgil Stallcup, R</b><br>OBP: 0.277, SLG: 0.358 (1, 6) |                          | 0-0<br>F3               |            | 4-0<br>FC6-4<br>BB   |                     | 0-0<br>5-3    |                       | 0-0<br>F6 |   | 3  | 0 | 0 | 0   | 1  | 0  | 2   |
| <b>Howie Fox, R</b><br>OBP: 0.200, SLG: 0.238 (1, 1)       |                          | 0-0<br>E4<br>1B         |            | 0-0<br>F5            |                     | 0-0<br>4-3    |                       | 0-0<br>F3 |   | 4  | 0 | 1 | 0   | 0  | 0  | 2   |

| Inning Stats | R: 2 | H: 3  | E: 0 | LOB: 1 | K: 0 | P: 6 | R: 0 | H: 2 | E: 1 | LOB: 3 | K: 1 | P: 7 | R: 0 | H: 0 | E: 0 | LOB: 0 | K: 1 | P: 5 | R: 0 | H: 0 | E: 0 | LOB: 1 | K: 0 | P: 7 | R: 3 | H: 4 | E: 0 | LOB: 0 | K: 0 | P: 6 | R: 0 | H: 0 | E: 0 | LOB: 0 | K: 0 | P: 3 | R: 0 | H: 1 | E: 0 | LOB: 1 | K: 0 | P: 4 | R: 0 | H: 1 | E: 0 | LOB: 1 | K: 0 | P: 4 |
|--------------|------|-------|------|--------|------|------|------|------|------|--------|------|------|------|------|------|--------|------|------|------|------|------|--------|------|------|------|------|------|--------|------|------|------|------|------|--------|------|------|------|------|------|--------|------|------|------|------|------|--------|------|------|
|              | S: 6 | BB: 0 | S: 7 | BB: 1  | S: 5 | S: 3 | S: 5 | S: 7 | S: 5 | S: 3   | S: 6 | S: 6 | S: 3 | S: 6 | S: 3 | S: 6   | S: 4 | S: 4 | S: 4 | S: 4 | S: 4 | S: 4   | S: 4 | S: 4 | S: 4 | S: 4 | S: 4 | S: 4   | S: 4 | S: 4 | S: 4 | S: 4 | S: 4 | S: 4   | S: 4 | S: 4 | S: 4 | S: 4 | S: 4 | S: 4   | S: 4 | S: 4 | S: 4 | S: 4 | S: 4 | S: 4   | S: 4 |      |

| PITCHER                                   | IP  | WLS | BF | H | R | ER | SO | BB | IBB | HBP | BLK | WP | HR | S  | P  | ERA  | WHIP  | PITCHER | IP | WLS | BF | H | R | ER | SO | BB | IBB | HBP | BLK | WP | HR | S | P | ERA | WHIP |  |  |  |  |  |  |  |  |  |  |  |  |  |
|---|-----|-----|----|---|---|----|----|----|-----|-----|-----|----|----|----|----|------|-------|---------|----|-----|----|---|---|----|----|----|-----|-----|-----|----|----|---|---|-----|------|--|--|--|--|--|--|--|--|--|--|--|--|--|
| <b>Bill Werle, L</b><br>ERA: 4.64 (1, 1)  | 6.0 | L   | 28 | 9 | 5 | 5  | 2  | 1  | 1   | 0   | 0   | 0  | 0  | 30 | 38 | 7.50 | 1.667 |         |    |     |    |   |   |    |    |    |     |     |     |    |    |   |   |     |      |  |  |  |  |  |  |  |  |  |  |  |  |  |
| <b>Junior Walsh, R</b><br>ERA: 5.2 (7, 1) | 2.0 |     | 8  | 2 | 0 | 0  | 0  | 0  | 0   | 0   | 0   | 0  | 0  | 8  | 8  | 0.00 | 1.000 |         |    |     |    |   |   |    |    |    |     |     |     |    |    |   |   |     |      |  |  |  |  |  |  |  |  |  |  |  |  |  |

**BOTTOM**

**Pittsburgh Pirates @ Cincinnati Reds**  
Crosley Field, Cincinnati, OH

Sat Sep 30 1950, 3:33 AM EST  
Att. 1,719 - Overcast - 80 F

|            |           |
|------------|-----------|
| <b>AB</b>  | <b>34</b> |
| <b>R</b>   | <b>5</b>  |
| <b>H</b>   | <b>11</b> |
| <b>RBI</b> | <b>5</b>  |
| <b>BB</b>  | <b>2</b>  |
| <b>SO</b>  | <b>2</b>  |
| <b>LOB</b> | <b>20</b> |

[livebaseballscores.com](http://livebaseballscores.com)



| WP | PA | CS |
|----|----|----|
| 0  | 36 | 0  |

| Batter  | 1                            | 2                               | 3                            | 4                               | 5                            | 6                               | 7                            | 8                               | 9                            | AB R H RBI BB SO LOB            | TOP                          |                                 |                              |                                 |                              |                                 |                              |                                  |                                  |                                    |                                  |        |  |  |  |    |     |    |   |   |    |    |    |     |     |     |    |    |   |   |     |      |
|---|------------------------------|---------------------------------|------------------------------|---------------------------------|------------------------------|---------------------------------|------------------------------|---------------------------------|------------------------------|---------------------------------|------------------------------|---------------------------------|------------------------------|---------------------------------|------------------------------|---------------------------------|------------------------------|----------------------------------|----------------------------------|------------------------------------|----------------------------------|--------|--|--|--|----|-----|----|---|---|----|----|----|-----|-----|-----|----|----|---|---|-----|------|
| Bob Dillinger, R<br>OBP: 0.352, SLG: 0.411 (1, 5) X       | 0-0<br>6-3                   |                                 | 0-0<br>G6-4-3<br>1B          |                                 | 0-0<br>G6-4-3<br>1-2f        |                                 | 0-0<br>FC4-6<br>1-2f         |                                 |                              | 4 0 1 0 0 0 2                   |                              |                                 |                              |                                 |                              |                                 |                              |                                  |                                  |                                    |                                  |        |  |  |  |    |     |    |   |   |    |    |    |     |     |     |    |    |   |   |     |      |
| Danny O'Connell, R<br>OBP: 0.348, SLG: 0.431 (1, 6) S S S | 0-3<br>K                     |                                 | 0-0<br>G6-4-3<br>1-2f        |                                 |                              | 0-0<br>F8                       |                              | 0-0<br>6-3                      |                              | 4 0 0 0 0 1 2                   |                              |                                 |                              |                                 |                              |                                 |                              |                                  |                                  |                                    |                                  |        |  |  |  |    |     |    |   |   |    |    |    |     |     |     |    |    |   |   |     |      |
| Ralph Kiner, R<br>OBP: 0.408, SLG: 0.592 (1, 7) X         | 0-0<br>F7                    |                                 |                              | 0-0<br>F5                       |                              | 0-0<br>F6                       |                              | 0-3<br>K                        |                              | 4 0 0 0 0 1 0                   |                              |                                 |                              |                                 |                              |                                 |                              |                                  |                                  |                                    |                                  |        |  |  |  |    |     |    |   |   |    |    |    |     |     |     |    |    |   |   |     |      |
| Gus Bell, L<br>OBP: 0.336, SLG: 0.448 (1, 9) B B B B      |                              | 4-0<br>1B<br>BB                 |                              | 0-0<br>S<br>1B                  |                              | 4-0<br>S<br>BB                  |                              | 0-0<br>L3                       |                              | 2 1 1 0 2 0 0                   |                              |                                 |                              |                                 |                              |                                 |                              |                                  |                                  |                                    |                                  |        |  |  |  |    |     |    |   |   |    |    |    |     |     |     |    |    |   |   |     |      |
| Wally Westlake, R<br>OBP: 0.357, SLG: 0.488 (1, 8) S S S  |                              | 0-3<br>K                        |                              | 0-0<br>F3                       |                              | 0-0<br>HR                       |                              | 0-0<br>FC6<br>1B                |                              | 4 1 2 2 0 1 2                   |                              |                                 |                              |                                 |                              |                                 |                              |                                  |                                  |                                    |                                  |        |  |  |  |    |     |    |   |   |    |    |    |     |     |     |    |    |   |   |     |      |
| Ed Stevens, L<br>OBP: 0.260, SLG: 0.239 (1, 3)            |                              | 0-0                             |                              | 4-0                             |                              | 0-0<br>F8                       |                              | 0-0<br>FC6<br>1B                |                              | 3 0 1 0 1 0 1                   |                              |                                 |                              |                                 |                              |                                 |                              |                                  |                                  |                                    |                                  |        |  |  |  |    |     |    |   |   |    |    |    |     |     |     |    |    |   |   |     |      |
| Hank Schenz, R<br>OBP: 0.269, SLG: 0.333 (9, PR)          |                              |                                 |                              |                                 |                              |                                 |                              |                                 |                              | 0 0 0 0 0 0 0                   |                              |                                 |                              |                                 |                              |                                 |                              |                                  |                                  |                                    |                                  |        |  |  |  |    |     |    |   |   |    |    |    |     |     |     |    |    |   |   |     |      |
| Jack Phillips, R<br>OBP: 0.348, SLG: 0.449 (9, 3)         |                              | 0-0<br>G5-4-3<br>1B             |                              | 1-2<br>BB                       |                              |                                 |                              | 0-0<br>FC6<br>BB<br>1-2f        |                              | 0 0 0 0 0 0 0                   |                              |                                 |                              |                                 |                              |                                 |                              |                                  |                                  |                                    |                                  |        |  |  |  |    |     |    |   |   |    |    |    |     |     |     |    |    |   |   |     |      |
| Johnny Berardino, R<br>OBP: 0.309, SLG: 0.258 (1, 4) X    |                              | 0-0<br>G5-4-3<br>1-2f           |                              | 0-0<br>F5                       |                              |                                 |                              | 4-0<br>FC2-6<br>1B<br>1-2       |                              | 3 0 1 0 1 0 4                   |                              |                                 |                              |                                 |                              |                                 |                              |                                  |                                  |                                    |                                  |        |  |  |  |    |     |    |   |   |    |    |    |     |     |     |    |    |   |   |     |      |
| Ray Mueller, R<br>OBP: 0.311, SLG: 0.413 (1, 2)           |                              |                                 | 0-0<br>5-3                   |                                 | 0-0                          |                                 |                              | 0-3<br>K<br>S S S S             |                              | 3 0 1 0 0 0 1                   |                              |                                 |                              |                                 |                              |                                 |                              |                                  |                                  |                                    |                                  |        |  |  |  |    |     |    |   |   |    |    |    |     |     |     |    |    |   |   |     |      |
| Tom Saffell, L<br>OBP: 0.268, SLG: 0.279 (9, PH)          |                              |                                 |                              |                                 |                              |                                 |                              |                                 |                              | 1 0 0 0 0 1 2                   |                              |                                 |                              |                                 |                              |                                 |                              |                                  |                                  |                                    |                                  |        |  |  |  |    |     |    |   |   |    |    |    |     |     |     |    |    |   |   |     |      |
| Clyde McCullough, R<br>OBP: 0.340, SLG: 0.406 (9, 2)      |                              |                                 |                              |                                 |                              |                                 |                              |                                 |                              | 0 0 0 0 0 0 0                   |                              |                                 |                              |                                 |                              |                                 |                              |                                  |                                  |                                    |                                  |        |  |  |  |    |     |    |   |   |    |    |    |     |     |     |    |    |   |   |     |      |
| Murry Dickson, R<br>OBP: 0.262, SLG: 0.301 (1, 1) X       |                              |                                 | 0-0<br>1B                    |                                 | 0-0<br>F8                    |                                 |                              | 0-3<br>K<br>S S S S             |                              | 4 0 1 0 0 1 4                   |                              |                                 |                              |                                 |                              |                                 |                              |                                  |                                  |                                    |                                  |        |  |  |  |    |     |    |   |   |    |    |    |     |     |     |    |    |   |   |     |      |
| Inning Stats  | R: 0<br>E: 0<br>K: 1<br>S: 5 | H: 0<br>LOB: 0<br>BB: 0<br>P: 5 | R: 0<br>E: 0<br>K: 1<br>S: 5 | H: 1<br>LOB: 1<br>BB: 1<br>P: 9 | R: 0<br>E: 0<br>K: 0<br>S: 4 | H: 2<br>LOB: 1<br>BB: 0<br>P: 4 | R: 0<br>E: 0<br>K: 0<br>S: 4 | H: 1<br>LOB: 2<br>BB: 1<br>P: 8 | R: 0<br>E: 0<br>K: 0<br>S: 3 | H: 1<br>LOB: 0<br>BB: 0<br>P: 3 | R: 2<br>E: 0<br>K: 0<br>S: 4 | H: 1<br>LOB: 0<br>BB: 1<br>P: 8 | R: 0<br>E: 0<br>K: 0<br>S: 4 | H: 1<br>LOB: 1<br>BB: 0<br>P: 4 | R: 0<br>E: 0<br>K: 1<br>S: 5 | H: 0<br>LOB: 0<br>BB: 0<br>P: 5 | R: 0<br>E: 0<br>K: 2<br>S: 8 | H: 1<br>LOB: 2<br>BB: 1<br>P: 12 | 1B: 7<br>2B: 0<br>3B: 0<br>HR: 1 | SF: 0<br>SAC: 0<br>DP: 3<br>HBP: 0 | WP: 0<br>PB: 0<br>SB: 2<br>CS: 0 | PA: 36 |  |  |  |    |     |    |   |   |    |    |    |     |     |     |    |    |   |   |     |      |
| PITCHER   | IP                           | WLS                             | BF                           | H                               | R                            | ER                              | SO                           | BB                              | IBB                          | HBP                             | BLK                          | WP                              | HR                           | S                               | P                            | ERA                             | WHIP                         | PITCHER                          |                                  |                                    |                                  |        |  |  |  | IP | WLS | BF | H | R | ER | SO | BB | IBB | HBP | BLK | WP | HR | S | P | ERA | WHIP |
| Willie Ramsdell, R<br>ERA: 3.7 (1, 1)                     | 6.0                          |                                 | 24                           | 6                               | 2                            | 2                               | 2                            | 3                               | 0                            | 0                               | 0                            | 0                               | 1                            | 25                              | 37                           | 3.00                            | 1.500                        |                                  |                                  |                                    |                                  |        |  |  |  |    |     |    |   |   |    |    |    |     |     |     |    |    |   |   |     |      |
| Eddie Erault, R<br>ERA: 5.82 (7, 1)                       | 3.0                          | W                               | 12                           | 2                               | 0                            | 0                               | 3                            | 1                               | 0                            | 0                               | 0                            | 0                               | 0                            | 17                              | 21                           | 0.00                            | 1.000                        |                                  |                                  |                                    |                                  |        |  |  |  |    |     |    |   |   |    |    |    |     |     |     |    |    |   |   |     |      |

Pittsburgh Pirates @ Cincinnati Reds  
Crosley Field, Cincinnati, OH  
Sun Oct 01 1950, 3:33 AM EST  
Sunny - 79 F

livebaseballscorecards.com

|     |    |
|-----|----|
| AB  | 32 |
| R   | 2  |
| H   | 8  |
| RBI | 2  |
| BB  | 4  |
| SO  | 5  |
| LOB | 18 |



| Batter | 1 | 2 | 3 | 4 | 5 | 6 | 7 | 8 | 9 | AB R H RBI BB SO LOB |
|--------|---|---|---|---|---|---|---|---|---|----------------------|
|--------|---|---|---|---|---|---|---|---|---|----------------------|

|   |                |                |                       |                       |                         |                                     |                |                        |                           |               |
|---|----------------|----------------|-----------------------|-----------------------|-------------------------|-------------------------------------|----------------|------------------------|---------------------------|---------------|
| Bobby Adams, R<br><small>OBP: 0.362, SLG: 0.410</small><br>(1, 4) X         | 0-0<br>F8<br>1 |                | 0-0<br>F7<br>2        |                       | 0-0<br>L3-6 FC4<br>1B   |                                     | 0-0<br>F6<br>1 |                        | 0-0<br>SH5-4<br>1B<br>E5  | 5 1 1 0 0 0 1 |
| Grady Hatton, L<br><small>OBP: 0.365, SLG: 0.381</small><br>(1, 5) B B B B  | 4-0<br>BB      |                | 0-0<br>F9<br>3        |                       | 0-0<br>FC4<br>1-2       |                                     | 0-0<br>F9<br>2 |                        | 0-0<br>SH5-4<br>1-2<br>E5 | 3 0 0 0 1 0 2 |
| Johnny Wyrostek, L<br><small>OBP: 0.357, SLG: 0.418</small><br>(1, 9) S S S | 0-3<br>K<br>2  |                |                       | 0-0<br>F9<br>1        | 0-0<br>L3-6<br>2-3<br>3 |                                     | 0-0<br>G3<br>3 |                        | 0-0<br>F6<br>2            | 5 0 0 0 0 1 4 |
| Ted Kluszewski, L<br><small>OBP: 0.350, SLG: 0.519</small><br>(1, 3) X      | 0-0<br>F7<br>3 |                |                       | 0-0<br>1B<br>2B       |                         | 0-0<br>G3<br>1                      |                | 0-0<br>F7<br>1         | 4-0<br>1B<br>IBB          | 4 0 1 0 1 0 1 |
| Joe Adcock, R<br><small>OBP: 0.332, SLG: 0.405</small><br>(1, 7)            |                | 0-0<br>F8<br>1 |                       | 0-0<br>1B<br>2-3      |                         | 4-0<br>BB<br>1B<br>BB               |                | 0-0<br>2B<br>1B        | 0-0<br>1-2<br>2-H<br>1B   | 4 1 3 1 1 0 0 |
| Lloyd Merriman, L<br><small>OBP: 0.333, SLG: 0.353</small><br>(1, 8)        |                | 0-0<br>F8<br>2 |                       | 4-0<br>IBB            |                         | 0-0<br>BB<br>1B<br>1-2              |                | 0-0<br>1B<br>2B<br>1-H |                           | 3 1 2 1 1 0 0 |
| Johnny Pramesa, R<br><small>OBP: 0.364, SLG: 0.427</small><br>(1, 2)        |                | 0-0<br>F4<br>3 |                       | 0-0<br>F2<br>2        |                         | 4-0<br>BB<br>BB<br>1-2<br>2-3<br>BB |                | 0-0<br>F8<br>2         |                           | 2 0 0 0 1 0 3 |
| Herm Wehmeier, R<br><small>OBP: 0.161, SLG: 0.185</small><br>(6, PR)        |                |                |                       |                       |                         |                                     |                |                        |                           | 0 0 0 0 0 0 0 |
| Dixie Howell, R<br><small>OBP: 0.329, SLG: 0.303</small><br>(7, 2)          |                |                |                       |                       |                         |                                     |                |                        |                           | 1 0 0 0 0 0 1 |
| Virgil Stallcup, R<br><small>OBP: 0.277, SLG: 0.358</small><br>(1, 6)       |                |                | 0-3<br>K<br>1<br>S: 3 | 0-3<br>K<br>1<br>S: 3 |                         | 0-0<br>F6<br>2                      |                | 0-0<br>1B<br>2-H       |                           | 4 0 1 1 0 2 6 |
| Willie Ramsdell, R<br><small>OBP: 0.259, SLG: 0.189</small><br>(1, 1)       |                |                | 4-0<br>BB             |                       |                         | 0-0<br>F2<br>1                      |                | 0-3<br>K<br>3          |                           | 1 0 0 0 1 0 0 |
| Ted Tappe, L<br><small>OBP: 0.333, SLG: 0.800</small><br>(6, PH)            |                |                |                       |                       |                         | 1-3                                 |                |                        |                           | 1 0 0 0 0 0 3 |
| Eddie Erautt, R<br><small>OBP: 0.214, SLG: 0.231</small><br>(7, 1)          |                |                |                       |                       |                         |                                     |                |                        |                           | 1 0 0 0 0 1 1 |

**BOTTOM**

|  |  |   |   |
|--|--|---|---|
| <b>Pittsburgh Pirates @ Cincinnati Reds</b><br>Crosley Field, Cincinnati, OH<br>Sun Oct 01 1950, 3:33 AM EST<br>Sunny - 79 F |  | <b>AB</b> 34<br><b>R</b> 3<br><b>H</b> 8<br><b>RBI</b> 3<br><b>BB</b> 6<br><b>SO</b> 4<br><b>LOB</b> 22 |  |
|--|--|---|---|

|   |   |                        |                          |                        |                          |                        |                          |                         |                          |                        |                          |                         |                          |                        |                          |                        |                          |                        |                         |                           |                         |        |
|---|---|------------------------|--------------------------|------------------------|--------------------------|------------------------|--------------------------|-------------------------|--------------------------|------------------------|--------------------------|-------------------------|--------------------------|------------------------|--------------------------|------------------------|--------------------------|------------------------|-------------------------|---------------------------|-------------------------|--------|
| <b>Inning Stats</b>   | R: 0 H: 0 E: 0 K: 1 S: 5  | H: 0 LOB: 1 BB: 1 P: 9 | R: 0 H: 0 E: 0 K: 0 S: 3 | H: 0 LOB: 0 BB: 0 P: 3 | R: 0 H: 0 E: 0 K: 1 S: 5 | H: 0 LOB: 1 BB: 1 P: 9 | R: 0 H: 2 E: 0 K: 1 S: 7 | H: 2 LOB: 3 BB: 1 P: 11 | R: 0 H: 1 E: 0 K: 0 S: 4 | H: 1 LOB: 1 BB: 0 P: 4 | R: 0 H: 1 E: 0 K: 0 S: 4 | H: 1 LOB: 3 BB: 2 P: 12 | R: 0 H: 0 E: 0 K: 0 S: 3 | H: 0 LOB: 0 BB: 0 P: 3 | R: 2 H: 3 E: 0 K: 1 S: 8 | H: 3 LOB: 1 BB: 0 P: 8 | R: 1 H: 1 E: 1 K: 0 S: 4 | H: 1 LOB: 2 BB: 1 P: 8 | 1B: 6 2B: 3 3B: 0 HR: 0 | SF: 0 SAC: 1 DP: 1 HBP: 0 | WP: 0 PB: 0 SB: 0 CS: 0 | PA: 41 |
| <b>PITCHER</b><br>Murry Dickson, R<br><small>ERA: 3.8</small><br>(1, 1) | IP 8.2 WLS L BF 41 H 8 R 3 ER 2 SO 4 BB 4 IBB 2 HBP 0 BLK 0 WP 0 HR 0 S 43 P 67 ERA 2.08 WHIP 1.385 |                        |                          |                        |                          |                        |                          |                         |                          |                        |                          |                         |                          |                        |                          |                        |                          |                        |                         |                           |                         |        |

| Batter  | 1   | 2  | 3   | 4   | 5   | 6   | 7   | 8   | 9   | AB R H RBI BB SO LOB                                       | TOP                                     |                |   |
|---|---|--|---|---|---|---|---|---|---|--|---|----------------|---|
| Bob Dillinger, R<br>OBP: 0.352, SLG: 0.410 (1, 5) X   | 0-0 4-3 ①   |  | X 0-0 5-3 ②   |   | X 0-0 1B  |   |   | X 0-0 6-3 ②   |   | 4 0 1 0 0 0 0  |   |                |   |
| Danny O'Connell, R<br>OBP: 0.344, SLG: 0.425 (1, 6) X   | 0-0 1-3 ②   |  | X 0-0 F8 ③  |   | 0-0 K ③   |   |   | X 0-0 6-3 ③   |   | 4 0 0 0 0 1 1  |   |                |   |
| Ralph Kiner, R<br>OBP: 0.408, SLG: 0.590 (1, 7) X<br>Tom Saffell, L<br>OBP: 0.264, SLG: 0.275 (4, 8) (4, 8) | 0-0 4-3 ③   |  |   | X 0-0 G3 ①  |   | X 0-0 G3 ①  |   | X 0-0 F8 ①  |   | 1 0 0 0 0 0 0<br>3 0 0 0 0 0 0                             |   |                |   |
| Gus Bell, L<br>OBP: 0.333, SLG: 0.444 (1, 9)  |   | X 0-0 F9 ①   |   | X 0-0 F9 ②  |   | X 0-0 F8 ②  |   | X 0-0 F6 ②  |   | 4 0 0 0 0 0 0  |   |                |   |
| Wally Westlake, R<br>OBP: 0.357, SLG: 0.493 (1, 8) (4, 7)   |   | X 0-0 5-3 ②  |   | X 0-0 L7 ③  |   | X 0-0 6-3 ③   |   | X 0-0 HR  |   | 4 1 1 1 0 0 0  |   |                |   |
| Jack Phillips, R<br>OBP: 0.355, SLG: 0.457 (1, 3)   |   | BB 4-0 2B BB   |   |   | X 0-0 E 1B 1B                                       |   | X 0-0 F9 ①  |   | X 0-0 2B  | 3 1 2 0 1 0 0  |   |                |   |
| Johnny Berardino, R<br>OBP: 0.314, SLG: 0.272 (1, 4)  |   | X 0-0 1-3 2B   |   |   | X 0-0 E8 1B G4-6-3 1B                               |   | X 0-0 5-3 ②   |   | X 0-0 F5 ③  | 4 1 2 0 0 0 1  |   |                |   |
| Clyde McCullough, R<br>OBP: 0.340, SLG: 0.405 (1, 2)  |   | 0-0 K  |   |   | X 0-0 G4-6-3 1B 2-3 3-H                             |   | X 0-0 5-3 ③   |   |   | 3 0 1 1 0 1 2  |   |                |   |
| Cliff Chambers, L<br>OBP: 0.319, SLG: 0.389 (1, 1)  |   |  | X 0-0 G3 ①  |   | X 0-0 G4-6-3 ① ② 1-2f 3-H                           |   |   | X 0-0 F8 ①  |   | 3 0 0 0 0 0 1  |   |                |   |
| <b>Inning Stats</b>   | R: 0 H: 0<br>E: 0 LOB: 0<br>K: 0 BB: 0<br>S: 3 P: 3   | R: 0 H: 1<br>E: 0 LOB: 2<br>K: 1 BB: 1<br>S: 6 P: 10 | R: 0 H: 0<br>E: 0 LOB: 0<br>K: 0 BB: 0<br>S: 3 P: 3 | R: 0 H: 0<br>E: 0 LOB: 0<br>K: 0 BB: 0<br>S: 3 P: 3 | R: 2 H: 4<br>E: 1 LOB: 1<br>K: 1 BB: 0<br>S: 8 P: 8 | R: 0 H: 0<br>E: 0 LOB: 0<br>K: 0 BB: 0<br>S: 3 P: 3 | R: 0 H: 0<br>E: 0 LOB: 0<br>K: 0 BB: 0<br>S: 3 P: 3 | R: 0 H: 0<br>E: 0 LOB: 0<br>K: 0 BB: 0<br>S: 3 P: 3 | R: 1 H: 2<br>E: 0 LOB: 1<br>K: 0 BB: 0<br>S: 5 P: 5 | 1B: 4 SF: 0<br>2B: 2 SAC: 0<br>3B: 0 DP: 1<br>HR: 1 HBP: 0 | WP: 0 PA: 34<br>PB: 0<br>SB: 0<br>CS: 0 |                |   |
| <b>PITCHER</b>  | IP WLS BF H R ER SO BB IBB HBP BLK WP HR S P ERA WHIP |  |   |   |   |   |   |   |   |  |   | <b>PITCHER</b> | IP WLS BF H R ER SO BB IBB HBP BLK WP HR S P ERA WHIP |
| Bud Byerly, R<br>ERA: 2.45 (1, 1)   | 8.0 L 29 5 2 2 2 1 0 0 0 0 0 0 32 36 2.25 0.750       |  |   |   |   |   |   |   |   |  |   |                |   |
| Frank Smith, R<br>ERA: 3.89 (9, 1)  | 1.0 5 2 1 1 0 0 0 0 0 0 0 1 5 5 9.00 2.000            |  |   |   |   |   |   |   |   |  |   |                |   |

**Pittsburgh Pirates @ Cincinnati Reds**  
 Crosley Field, Cincinnati, OH  
 Sun Oct 01 1950, 3:38 AM EST  
 Att. 8,390 - Sunny - 78 F

[livebaseballscorecards.com](http://livebaseballscorecards.com)

**AB 33**  
**R 3**  
**H 7**  
**RBI 2**  
**BB 1**  
**SO 2**  
**LOB 5**





| Batter   | 1           | 2            | 3           | 4   | 5            | 6            | 7            | 8            | 9           | AB R H RBI BB SO LOB                            |
|--|-------------|--------------|-------------|---|--------------|--------------|--------------|--------------|-------------|---|
| <b>Bobby Adams, R</b> (1, 4)<br>OBP: 0.361, SLG: 0.414     | 0-3<br>K    |              |             | x 0-0<br>1B<br>3B                           | x 0-0<br>F9  |              |              | x 0-0<br>6-3 |             | 4 1 1 0 0 1 0                                   |
| <b>Grady Hatton, L</b> (1, 5)<br>OBP: 0.366, SLG: 0.381    | 0-0<br>F3   |              |             | x 0-0<br>FC6-4-5<br>1B<br>1B                |              | x 0-0<br>4-3 |              | x 0-0<br>F3  |             | 2 0 1 1 0 0 0<br>2 0 0 0 0 0 0                  |
| <b>Virgil Stallcup, R</b> (5, 6)<br>OBP: 0.276, SLG: 0.356 |             |              |             | x 0-0<br>3-H<br>1B                          |              |              |              |              |             |   |
| <b>Danny Litwhiler, R</b> (1, 9)<br>OBP: 0.371, SLG: 0.455 | 0-3<br>K2-3 |              |             | x 0-0<br>FC6-4-5<br>1B<br>1-2               |              | x 0-0<br>6-3 |              | x 0-0<br>F7  |             | 4 0 1 0 0 1 0                                   |
| <b>Ted Kluszewski, L</b> (1, 3)<br>OBP: 0.348, SLG: 0.515  |             | x 0-0<br>6-3 |             | x 0-0<br>FC6-4-5<br>HBP<br>1B<br>1-2<br>2-3 |              | x 0-0<br>G3  |              | x 0-3<br>K   |             | 4 0 0 0 0 1 2                                   |
| <b>Joe Adcock, R</b> (1, 7)<br>OBP: 0.334, SLG: 0.406      |             | x 0-0<br>F3  |             | x 0-0<br>HBP<br>1B<br>1-2                   |              |              | x 0-0<br>F8  |              | x 0-0<br>1B | 4 0 2 0 0 0 0                                   |
| <b>Lloyd Merriman, L</b> (1, 8)<br>OBP: 0.332, SLG: 0.349  |             | x 0-0<br>F8  |             | x 1-0<br>HBP<br>1-2<br>2-3                  |              |              | x 0-0<br>5-3 |              | x 0-0<br>F9 | 3 0 0 0 0 0 1                                   |
| <b>Sammy Meeks, R</b> (1, 6)<br>OBP: 0.327, SLG: 0.368     |             |              | x 0-0<br>F8 | x 0-0<br>L4                                 |              |              | x 0-0<br>1B  |              |             | 3 0 1 0 0 0 3                                   |
| <b>Dixie Howell, R</b> (1, 2)<br>OBP: 0.326, SLG: 0.299    |             |              | x 0-0<br>F6 |   | x 0-0<br>4-3 |              | x 0-0<br>F8  |              |             | 3 0 0 0 0 0 1                                   |
| <b>Bud Byerly, R</b> (1, 1)<br>OBP: 0.363, SLG: 0.425      |             |              | x 0-3<br>K  |   | x 0-0<br>1-3 |              |              | x 0-0<br>5-3 |             | 2 0 0 0 0 1 0<br>1 0 0 0 0 0 0<br>0 0 0 0 0 0 0 |
| <b>Johnny Pramesa, R</b> (8, PH)<br>OBP: 0.095, SLG: 0.095 |             |              |             |   |              |              |              |              |             |   |
| <b>Frank Smith, R</b> (9, 1)                               |             |              |             |   |              |              |              |              |             |   |

| Inning Stats                                | R: 0 | H: 0 | E: 0 | LOB: 0 | K: 2 | BB: 0 | S: 7 | P: 7 | R: 0 | H: 0 | E: 0 | LOB: 0 | K: 0 | BB: 0 | S: 3 | P: 3 | R: 0 | H: 0 | E: 0 | LOB: 0 | K: 1 | BB: 0 | S: 5 | P: 5 | R: 1 | H: 4 | E: 0 | LOB: 3 | K: 0 | BB: 0 | S: 6 | P: 7 | R: 0 | H: 0 | E: 0 | LOB: 0 | K: 0 | BB: 0 | S: 3 | P: 3 | R: 0 | H: 1 | E: 0 | LOB: 1 | K: 0 | BB: 0 | S: 4 | P: 4 | R: 0 | H: 0 | E: 0 | LOB: 0 | K: 0 | BB: 0 | S: 3 | P: 3 | R: 0 | H: 1 | E: 0 | LOB: 1 | K: 1 | BB: 0 | S: 6 | P: 6 | 1B: 5 | SF: 0 | 2B: 1 | SAC: 0 | 3B: 1 | DP: 1 | HR: 0 | HBP: 1 | WP: 0 | PA: 33 |
|---|------|------|------|--------|------|-------|------|------|------|------|------|--------|------|-------|------|------|------|------|------|--------|------|-------|------|------|------|------|------|--------|------|-------|------|------|------|------|------|--------|------|-------|------|------|------|------|------|--------|------|-------|------|------|------|------|------|--------|------|-------|------|------|------|------|------|--------|------|-------|------|------|-------|-------|-------|--------|-------|-------|-------|--------|-------|--------|
| <b>Cliff Chambers, L</b> (1, 1)<br>ERA: 4.3 | IP   | WLS  | BF   | H      | R    | ER    | SO   | BB   | IBB  | HBP  | BLK  | WP     | HR   | S     | P    | ERA  | WHIP |      |      |        |      |       |      |      |      |      |      |        |      |       |      |      |      |      |      | IP     | WLS  | BF    | H    | R    | ER   | SO   | BB   | IBB    | HBP  | BLK   | WP   | HR   | S    | P    | ERA  | WHIP   |      |       |      |      |      |      |      |        |      |       |      |      |       |       |       |        |       |       |       |        |       |        |

**BOTTOM**

**Pittsburgh Pirates @ Cincinnati Reds**  
Crosley Field, Cincinnati, OH

Sun Oct 01 1950, 3:38 AM EST  
Att. 8,390 - Sunny - 78 F

livebaseballscorecards.com

|            |           |
|------------|-----------|
| <b>AB</b>  | <b>32</b> |
| <b>R</b>   | <b>1</b>  |
| <b>H</b>   | <b>6</b>  |
| <b>RBI</b> | <b>1</b>  |
| <b>BB</b>  | <b>0</b>  |
| <b>SO</b>  | <b>4</b>  |
| <b>LOB</b> | <b>7</b>  |

