

**Kansas City Athletics - 1964**

| Batter  | 1   | 2                               | 3                            | 4                               | 5                            | 6                               | 7                            | 8                               | 9                            | AB R H RBI BB SO LOB  | TOP                          |                                 |                              |                                 |                              |                                 |                              |                                  |                                  |                                    |                                  |        |
|---|---|---------------------------------|------------------------------|---------------------------------|------------------------------|---------------------------------|------------------------------|---------------------------------|------------------------------|---|------------------------------|---------------------------------|------------------------------|---------------------------------|------------------------------|---------------------------------|------------------------------|----------------------------------|----------------------------------|------------------------------------|----------------------------------|--------|
| Nelson Mathews, R (1, 8)<br>OBP: 0.500, SLG: 0.750  | 0-0<br>6-3  |                                 |                              | 0-0<br>2-3<br>1B                |                              | 0-0<br>L9                       |                              |                                 | 0-0<br>E<br>2B               | 4 1 2 0 0 0 0   |                              |                                 |                              |                                 |                              |                                 |                              |                                  |                                  |                                    |                                  |        |
| Wayne Causey, L (1, 6)<br>OBP: 0.500, SLG: 0.333  | 0-0<br>F8   |                                 |                              | 0-0<br>L8                       |                              |                                 | 0-0<br>G6-4-3<br>1B          |                                 | 4-0<br>BB E<br>BB            | 3 0 1 0 1 0 1   |                              |                                 |                              |                                 |                              |                                 |                              |                                  |                                  |                                    |                                  |        |
| Ed Charles, R (1, 5)<br>S S S   | 0-3<br>K  |                                 |                              | 0-0<br>2-3<br>1-2               |                              |                                 | 0-0<br>G6-4-3<br>1-2f        |                                 | 0-3<br>K                     | 4 0 0 0 0 2 4   |                              |                                 |                              |                                 |                              |                                 |                              |                                  |                                  |                                    |                                  |        |
| Jim Gentile, L (1, 3)<br>OBP: 0.250, SLG: 1.000   |   | 0-0<br>F8                       |                              | 0-0<br>L8                       |                              |                                 | 0-0<br>HR                    |                                 | 0-0<br>F9                    | 4 1 1 1 0 0 3   |                              |                                 |                              |                                 |                              |                                 |                              |                                  |                                  |                                    |                                  |        |
| Rocky Colavito, R (1, 7)  |   | 0-0<br>6-3                      |                              |                                 | 0-0<br>L9                    |                                 | 0-0<br>1-3                   |                                 | 0-0<br>E6<br>1-2<br>2-H      | 4 0 0 0 0 0 1   |                              |                                 |                              |                                 |                              |                                 |                              |                                  |                                  |                                    |                                  |        |
| Doc Edwards, R (1, 2)<br>Charlie Lau, L (9, PH)   |   | 0-0<br>F4                       |                              |                                 | 0-0<br>5-3                   |                                 |                              | 0-0<br>6-3                      | 4-0<br>1-2<br>2-3<br>BB      | 3 0 0 0 0 0 0<br>0 0 0 0 1 0 0  |                              |                                 |                              |                                 |                              |                                 |                              |                                  |                                  |                                    |                                  |        |
| Gino Cimoli, R (1, 9)   |   |                                 | 0-0<br>5-3                   |                                 | 0-0<br>6-3                   |                                 |                              | 0-0<br>F8                       | 0-0<br>4-3                   | 4 0 0 0 0 0 3   |                              |                                 |                              |                                 |                              |                                 |                              |                                  |                                  |                                    |                                  |        |
| Dick Green, R (1, 4)  |   |                                 | 0-0<br>4-3                   |                                 |                              | 0-3<br>K                        |                              | 0-3<br>K                        |                              | 3 0 0 0 0 2 0   |                              |                                 |                              |                                 |                              |                                 |                              |                                  |                                  |                                    |                                  |        |
| Orlando Pena, R (1, 1)<br>Billy Bryan, L (6, PH)<br>Vern Handrahan, L (6, 1)<br>John O'Donoghue, R (7, 1)<br>Manny Jimenez, L (9, PH)<br>OBP: 1.000, SLG: 4.000 |   |                                 | 0-3<br>K                     |                                 |                              | 0-3<br>K                        |                              |                                 | 0-0<br>HR                    | 1 0 0 0 0 1 0<br>1 0 0 0 0 1 0<br>0 0 0 0 0 0 0<br>0 0 0 0 0 0 0<br>1 1 1 1 0 0 0 |                              |                                 |                              |                                 |                              |                                 |                              |                                  |                                  |                                    |                                  |        |
| <b>Inning Stats</b>   | R: 0<br>E: 0<br>K: 1<br>S: 5                          | H: 0<br>LOB: 0<br>BB: 0<br>P: 5 | R: 0<br>E: 0<br>K: 0<br>S: 3 | H: 0<br>LOB: 0<br>BB: 0<br>P: 3 | R: 0<br>E: 0<br>K: 1<br>S: 5 | H: 0<br>LOB: 0<br>BB: 0<br>P: 5 | R: 0<br>E: 0<br>K: 0<br>S: 4 | H: 1<br>LOB: 1<br>BB: 0<br>P: 4 | R: 0<br>E: 0<br>K: 0<br>S: 3 | H: 0<br>LOB: 0<br>BB: 0<br>P: 3   | R: 0<br>E: 0<br>K: 2<br>S: 7 | H: 0<br>LOB: 0<br>BB: 0<br>P: 7 | R: 1<br>E: 0<br>K: 0<br>S: 4 | H: 2<br>LOB: 0<br>BB: 0<br>P: 4 | R: 0<br>E: 0<br>K: 1<br>S: 5 | H: 0<br>LOB: 0<br>BB: 0<br>P: 5 | R: 2<br>E: 1<br>K: 1<br>S: 8 | H: 2<br>LOB: 3<br>BB: 2<br>P: 16 | 1B: 2<br>2B: 1<br>3B: 0<br>HR: 2 | SF: 0<br>SAC: 0<br>DP: 1<br>HBP: 0 | WP: 0<br>PB: 0<br>SB: 0<br>CS: 0 | PA: 34 |
| <b>PITCHER</b>  | IP WLS BF H R ER SO BB IBB HBP BLK WP HR S P ERA WHIP |                                 |                              |                                 |                              |                                 |                              |                                 |                              |   |                              |                                 |                              |                                 |                              |                                 |                              |                                  |                                  |                                    |                                  |        |
| Phil Regan, R (1, 1)<br>ERA: 2.16   | 8.1 W 30 5 3 2 6 1 0 0 0 0 2 41 45 2.16 0.720         |                                 |                              |                                 |                              |                                 |                              |                                 |                              |   |                              |                                 |                              |                                 |                              |                                 |                              |                                  |                                  |                                    |                                  |        |
| Mickey Lolich, L (9, 1)<br>ERA:   | 0.1 1 0 0 0 0 0 0 0 0 0 0 1 1 0.00 0.000              |                                 |                              |                                 |                              |                                 |                              |                                 |                              |   |                              |                                 |                              |                                 |                              |                                 |                              |                                  |                                  |                                    |                                  |        |
| Dave Wickersham, R (9, 1)<br>ERA:   | 0.1 S 3 0 0 0 0 1 0 0 0 0 0 2 6 0.00 3.000            |                                 |                              |                                 |                              |                                 |                              |                                 |                              |   |                              |                                 |                              |                                 |                              |                                 |                              |                                  |                                  |                                    |                                  |        |

**Kansas City Athletics @ Detroit Tigers**  
 Tiger Stadium, Detroit, MI  
 Tue Apr 14 1964, 3:33 AM EST  
 Att: 35,733 - Unknown

livebaseballscorecards.com

|     |    |
|-----|----|
| AB  | 32 |
| R   | 3  |
| H   | 5  |
| RBI | 2  |
| BB  | 2  |
| SO  | 6  |
| LOB | 12 |

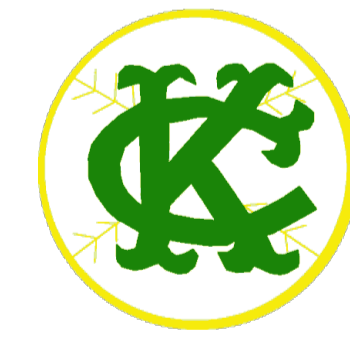

| Batter  | 1             | 2               | 3             | 4             | 5           | 6                | 7             | 8                 | 9 | AB | R | H | RBI | BB | SO | LOB |
|---|---------------|-----------------|---------------|---------------|-------------|------------------|---------------|-------------------|---|----|---|---|-----|----|----|-----|
| Bill Bruton, L<br>OBP: 0.250, SLG: 1.000 (1, 7) | 0-0<br>F6     |                 | 0-0<br>1-3    |               | 0-0<br>G3   |                  | 0-0<br>2-H HR |                   |   | 4  | 1 | 1 | 2   | 0  | 0  | 0   |
| Jerry Lumpe, L<br>OBP: 0.750, SLG: 1.500 (1, 4) | 0-0<br>4-3 3B |                 | 0-0<br>4-3 2B |               | 0-0<br>6-3  |                  | 0-0<br>1-3 1B |                   |   | 4  | 1 | 3 | 0   | 0  | 0  | 0   |
| Norm Cash, L<br>OBP: 0.250, SLG: 1.000 (1, 3)   | 0-0<br>4-3    |                 | 0-0<br>4-3    |               | 0-0<br>HR   |                  | 0-0<br>1-3    |                   |   | 4  | 1 | 1 | 2   | 0  | 0  | 2   |
| Al Kaline, R (1, 9)                             | 0-0<br>3-H F3 |                 | 0-0<br>2-3 L9 |               | 0-0<br>L5-3 |                  | 0-0<br>L9     |                   |   | 4  | 0 | 0 | 0   | 0  | 0  | 2   |
| Don Demeter, R (1, 8)                           |               | 0-0<br>F7       |               | 0-3<br>K      |             | 0-0<br>5-3       |               | 0-0<br>4-3        |   | 4  | 0 | 0 | 0   | 0  | 1  | 0   |
| Dick McAuliffe, L (1, 6)                        |               | 0-0<br>F8 3B 1B |               | 0-3<br>K      |             | 0-0<br>F6        |               | 0-0<br>1B 2B      |   | 4  | 2 | 2 | 0   | 0  | 1  | 0   |
| Don Wert, R (1, 5)                              |               | 0-0<br>F8 1-2   |               | 0-0<br>1B 3B  |             | 0-0<br>5-3       |               | 0-0<br>2-3 1B     |   | 4  | 1 | 2 | 0   | 0  | 0  | 1   |
| Bill Freehan, R (1, 2)                          |               | 0-0<br>2-H 3B   |               | 0-0<br>3-H 1B |             | 0-0<br>SH3-4 1B  |               | 0-0<br>1-2 3-H F9 |   | 4  | 1 | 3 | 2   | 0  | 0  | 1   |
| Phil Regan, R (1, 1)                            |               | 0-3<br>K        |               | 0-0<br>F4     |             | 0-0<br>SH3-4 1-2 |               | 0-0<br>6-3        |   | 3  | 0 | 0 | 0   | 0  | 1  | 3   |
| Mickey Lolich, S (9, 1)                         |               |                 |               |               |             |                  |               |                   |   | 0  | 0 | 0 | 0   | 0  | 0  | 0   |
| Dave Wickersham, R (9, 1)                       |               |                 |               |               |             |                  |               |                   |   | 0  | 0 | 0 | 0   | 0  | 0  | 0   |

| Inning Stats | R: 1 | H: 1 | E: 0 | K: 0 | S: 4 | LOB: 0 | BB: 0 | P: 4 | R: 1 | H: 2 | E: 0 | K: 1 | S: 7 | LOB: 1 | BB: 0 | P: 7 | R: 0 | H: 1 | E: 0 | K: 0 | S: 4 | LOB: 1 | BB: 0 | P: 4 | R: 1 | H: 2 | E: 0 | K: 2 | S: 9 | LOB: 0 | BB: 0 | P: 9 | R: 1 | H: 1 | E: 0 | K: 0 | S: 4 | LOB: 0 | BB: 0 | P: 4 | R: 0 | H: 0 | E: 0 | K: 0 | S: 3 | LOB: 0 | BB: 0 | P: 3 | R: 2 | H: 3 | E: 0 | K: 0 | S: 6 | LOB: 1 | BB: 0 | P: 6 | R: 1 | H: 2 | E: 0 | K: 0 | S: 5 | LOB: 1 | BB: 0 | P: 5 |
|--------------|------|------|------|------|------|--------|-------|------|------|------|------|------|------|--------|-------|------|------|------|------|------|------|--------|-------|------|------|------|------|------|------|--------|-------|------|------|------|------|------|------|--------|-------|------|------|------|------|------|------|--------|-------|------|------|------|------|------|------|--------|-------|------|------|------|------|------|------|--------|-------|------|
|--------------|------|------|------|------|------|--------|-------|------|------|------|------|------|------|--------|-------|------|------|------|------|------|------|--------|-------|------|------|------|------|------|------|--------|-------|------|------|------|------|------|------|--------|-------|------|------|------|------|------|------|--------|-------|------|------|------|------|------|------|--------|-------|------|------|------|------|------|------|--------|-------|------|

| PITCHER                               | IP  | WLS | BF | H | R | ER | SO | BB | IBB | HBP | BLK | WP | HR | S  | P  | ERA   | WHIP  |
|---------------------------------------|-----|-----|----|---|---|----|----|----|-----|-----|-----|----|----|----|----|-------|-------|
| Orlando Pena, R (1, 1)<br>ERA: 7.2    | 5.0 | L   | 22 | 7 | 4 | 4  | 3  | 0  | 0   | 0   | 0   | 0  | 1  | 28 | 28 | 7.20  | 1.400 |
| Vern Handrahan, R (6, 1)<br>ERA: 13.5 | 1.1 |     | 7  | 3 | 2 | 2  | 0  | 0  | 0   | 0   | 0   | 0  | 1  | 7  | 7  | 13.50 | 2.250 |
| John O'Donoghue, L (7, 1)<br>ERA:     | 1.2 |     | 7  | 2 | 1 | 0  | 0  | 0  | 0   | 0   | 0   | 0  | 0  | 7  | 7  | 0.00  | 1.200 |

**BOTTOM**

**Kansas City Athletics @ Detroit Tigers**  
Tiger Stadium, Detroit, MI  
Tue Apr 14 1964, 3:33 AM EST  
Att. 35,733 - Unknown

| AB  | 35 |
|-----|----|
| R   | 7  |
| H   | 12 |
| RBI | 6  |
| BB  | 0  |
| SO  | 3  |
| LOB | 9  |



| WP | PA | 36 |
|----|----|----|
| PB | 1  |    |
| SB | 0  |    |
| CS | 0  |    |

| PITCHER | IP | WLS | BF | H | R | ER | SO | BB | IBB | HBP | BLK | WP | HR | S | P | ERA | WHIP |
|---------|----|-----|----|---|---|----|----|----|-----|-----|-----|----|----|---|---|-----|------|
|---------|----|-----|----|---|---|----|----|----|-----|-----|-----|----|----|---|---|-----|------|

| Batter   | 1   | 2                                | 3                            | 4                               | 5                            | 6                                | 7                              | 8                               | 9                            | AB R H RBI BB SO LOB            | TOP   |                                 |                              |                                  |                              |                                 |                              |                                 |                                  |                                    |                                  |        |
|--|---|----------------------------------|------------------------------|---------------------------------|------------------------------|----------------------------------|--------------------------------|---------------------------------|------------------------------|---------------------------------|---|---------------------------------|------------------------------|----------------------------------|------------------------------|---------------------------------|------------------------------|---------------------------------|----------------------------------|------------------------------------|----------------------------------|--------|
| Nelson Mathews, R (1, 8)<br>OBP: 0.444, SLG: 0.750 | 0-0<br>E1<br>1B<br>G6-4-3                             |                                  | 0-0<br>3B                    |                                 | 0-3<br>K                     |                                  | 4-0<br>2B<br>1-2<br>2-3<br>BB  |                                 | 0-3<br>K                     | 4 1 1 0 1 2 1                   | <b>Kansas City Athletics @ Cleveland Indians</b><br><b>Cleveland Municipal Stadium, Cleveland, OH</b><br>Fri Apr 17 1964, 6:05 PM EST<br>Att. 9,607 - Unknown |                                 |                              |                                  |                              |                                 |                              |                                 |                                  |                                    |                                  |        |
| Wayne Causey, L (1, 6)<br>OBP: 0.667, SLG: 0.667   | 0-0<br>1B<br>G6-4-3                                   |                                  | 4-0<br>BB                    |                                 | 0-0<br>F8                    |                                  | 0-0<br>2B<br>1-3<br>2-H<br>3-H |                                 | 4-0<br>BB                    | 3 0 2 2 2 0 1                   |   |                                 |                              |                                  |                              |                                 |                              |                                 |                                  |                                    |                                  |        |
| Ed Charles, R (1, 5)<br>OBP: 0.250, SLG: 0.250     | 0-0<br>G6-4-3<br>1-2f<br>3-H                          |                                  | 0-3<br>K                     |                                 | 0-0<br>F8                    |                                  | 0-0<br>6-3                     |                                 | 0-0<br>F9                    | 5 0 0 0 0 1 6                   |   |                                 |                              |                                  |                              |                                 |                              |                                 |                                  |                                    |                                  |        |
| Rocky Colavito, R (1, 7)<br>OBP: 0.250, SLG: 0.286 | 4-0<br>BB   |                                  | 0-0<br>F8                    |                                 | 0-0<br>6-3                   |                                  | 0-0<br>2B                      |                                 | 0-0<br>1B<br>2B              | 3 1 1 0 1 0 2                   |   |                                 |                              |                                  |                              |                                 |                              |                                 |                                  |                                    |                                  |        |
| Jim Gentile, L (1, 3)<br>OBP: 0.250, SLG: 0.625    | 0-3<br>K  |                                  |                              | 0-0<br>F3                       |                              | 0-3<br>K                         |                                | 0-0<br>1B<br>2-H                | 0-0<br>1B                    | 4 0 1 1 0 2 1                   |   |                                 |                              |                                  |                              |                                 |                              |                                 |                                  |                                    |                                  |        |
| Doc Edwards, R (1, 2)<br>OBP: 0.286, SLG: 0.167    |   | 0-0<br>3-1                       |                              | 4-0<br>BB<br>G5-4-3             |                              | 0-0<br>BB<br>E<br>2B<br>1B       |                                | 0-0<br>F4                       | 0-0<br>F4                    | 3 1 1 0 1 0 1                   |   |                                 |                              |                                  |                              |                                 |                              |                                 |                                  |                                    |                                  |        |
| Gino Cimoli, R (1, 9)                              |   | 0-0<br>F9                        |                              | 0-0<br>G5-4-3<br>1-2f           |                              | 0-0<br>E5<br>BB<br>2B            |                                | 0-3<br>K                        | 0-3<br>K                     | 4 1 0 0 0 1 3                   |   |                                 |                              |                                  |                              |                                 |                              |                                 |                                  |                                    |                                  |        |
| Dick Green, R (1, 4)                               |   | 0-3<br>K                         |                              | 0-3<br>K                        |                              | 0-3<br>K                         |                                | 0-3<br>K                        | 0-3<br>K                     | 4 0 0 0 0 4 3                   |   |                                 |                              |                                  |                              |                                 |                              |                                 |                                  |                                    |                                  |        |
| Diego Segui, R (1, 1)<br>OBP: 0.500, SLG: 0.500    |   |                                  | 0-0<br>F4                    |                                 | 0-0<br>1B                    |                                  | 0-0<br>F4                      |                                 | 0-0<br>6-3                   | 2 0 1 0 0 0 0                   |   |                                 |                              |                                  |                              |                                 |                              |                                 |                                  |                                    |                                  |        |
| Tommie Reynolds, R (7, PH)                         |   |                                  |                              |                                 |                              |                                  |                                |                                 |                              | 1 0 0 0 0 0 2                   |   |                                 |                              |                                  |                              |                                 |                              |                                 |                                  |                                    |                                  |        |
| Ted Bowsfield, R (7, 1)                            |   |                                  |                              |                                 |                              |                                  |                                |                                 |                              | 0 0 0 0 0 0 0                   |   |                                 |                              |                                  |                              |                                 |                              |                                 |                                  |                                    |                                  |        |
| Manny Jimenez, L (9, PH)<br>OBP: 0.500, SLG: 2.000 |   |                                  |                              |                                 |                              |                                  |                                |                                 |                              | 1 0 0 0 0 0 0                   |   |                                 |                              |                                  |                              |                                 |                              |                                 |                                  |                                    |                                  |        |
| <b>Inning Stats</b>                                | R: 1<br>E: 1<br>K: 1<br>S: 6                          | H: 1<br>LOB: 1<br>BB: 1<br>P: 10 | R: 0<br>E: 0<br>K: 1<br>S: 5 | H: 0<br>LOB: 0<br>BB: 0<br>P: 5 | R: 0<br>E: 0<br>K: 1<br>S: 6 | H: 1<br>LOB: 2<br>BB: 1<br>P: 10 | R: 0<br>E: 0<br>K: 1<br>S: 2   | H: 0<br>LOB: 0<br>BB: 1<br>P: 6 | R: 0<br>E: 0<br>K: 2<br>S: 8 | H: 1<br>LOB: 1<br>BB: 0<br>P: 8 | R: 0<br>E: 0<br>K: 1<br>S: 5  | H: 0<br>LOB: 0<br>BB: 0<br>P: 5 | R: 2<br>E: 1<br>K: 1<br>S: 8 | H: 2<br>LOB: 2<br>BB: 1<br>P: 12 | R: 1<br>E: 0<br>K: 2<br>S: 9 | H: 2<br>LOB: 1<br>BB: 0<br>P: 9 | R: 0<br>E: 0<br>K: 1<br>S: 5 | H: 0<br>LOB: 1<br>BB: 1<br>P: 9 | 1B: 4<br>2B: 2<br>3B: 1<br>HR: 0 | SF: 0<br>SAC: 0<br>DP: 2<br>HBP: 0 | WP: 0<br>PB: 0<br>SB: 0<br>CS: 0 | PA: 39 |
| <b>PITCHER</b>                                     | IP WLS BF H R ER SO BB IBB HBP BLK WP HR S P ERA WHIP |                                  |                              |                                 |                              |                                  |                                |                                 |                              |                                 |   |                                 |                              |                                  |                              |                                 |                              |                                 |                                  |                                    |                                  |        |
| Jack Kralick, L (1, 1)<br>ERA: 3.86                | 6.2 W 29 5 3 0 7 4 0 0 0 0 0 0 39 55 0.00 1.350       |                                  |                              |                                 |                              |                                  |                                |                                 |                              |                                 |   |                                 |                              |                                  |                              |                                 |                              |                                 |                                  |                                    |                                  |        |
| Gary Bell, R (7, 1)<br>ERA: 3.86                   | 2.1 S 10 2 1 1 3 1 0 0 0 0 0 0 15 19 3.86 1.286       |                                  |                              |                                 |                              |                                  |                                |                                 |                              |                                 |   |                                 |                              |                                  |                              |                                 |                              |                                 |                                  |                                    |                                  |        |

livebaseballscorecards.com

|     |    |
|-----|----|
| AB  | 34 |
| R   | 4  |
| H   | 7  |
| RBI | 3  |
| BB  | 5  |
| SO  | 10 |
| LOB | 20 |

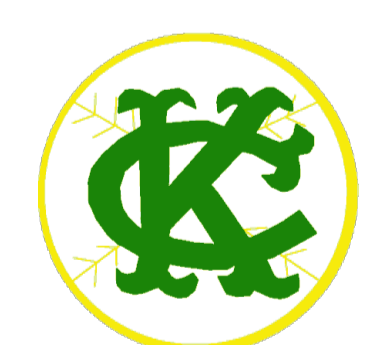



| Batter   | 1  | 2   | 3   | 4   | 5  | 6  | 7   | 8 | 9 | AB R H RBI BB SO LOB   | TOP   |         |   |   |   |   |   |     |   |    |   |    |   |     |    |
|--|--|---|---|---|--|--|---|---|---|--|---|---------|---|---|---|---|---|-----|---|----|---|----|---|-----|----|
| Nelson Mathews, R (1, 8)<br>OBP: 0.538, SLG: 0.727 | 0-0<br>L4  |   | 0-0<br>SH5-3<br>E<br>1B   |   | 4-0<br>SF7<br>BB<br>1B   | 0-0<br>BB<br>1B  |   |   |   | 3 2 2 0 1 0 0  | <p>Kansas City Athletics @ Washington Senators<br/>D.C. Stadium, Washington, DC</p> <p>Sun Apr 19 1964, 3:33 AM EST<br/>Att. 8,500 - Unknown</p> <p>livebaseballscorecards.com</p> <table border="1"> <tr><td>AB</td><td>23</td></tr> <tr><td>R</td><td>5</td></tr> <tr><td>H</td><td>7</td></tr> <tr><td>RBI</td><td>3</td></tr> <tr><td>BB</td><td>6</td></tr> <tr><td>SO</td><td>5</td></tr> <tr><td>LOB</td><td>13</td></tr> </table>  | AB      | 23  | R | 5 | H | 7 | RBI | 3 | BB | 6 | SO | 5 | LOB | 13 |
| AB   | 23   |   |   |   |  |  |   |   |   |  |   |         |   |   |   |   |   |     |   |    |   |    |   |     |    |
| R  | 5  |   |   |   |  |  |   |   |   |  |   |         |   |   |   |   |   |     |   |    |   |    |   |     |    |
| H  | 7  |   |   |   |  |  |   |   |   |  |   |         |   |   |   |   |   |     |   |    |   |    |   |     |    |
| RBI  | 3  |   |   |   |  |  |   |   |   |  |   |         |   |   |   |   |   |     |   |    |   |    |   |     |    |
| BB   | 6  |   |   |   |  |  |   |   |   |  |   |         |   |   |   |   |   |     |   |    |   |    |   |     |    |
| SO   | 5  |   |   |   |  |  |   |   |   |  |   |         |   |   |   |   |   |     |   |    |   |    |   |     |    |
| LOB  | 13   |   |   |   |  |  |   |   |   |  |   |         |   |   |   |   |   |     |   |    |   |    |   |     |    |
| Wayne Causey, L (1, 6)<br>OBP: 0.667, SLG: 0.571   | 4-0<br>BB<br>1B<br>BB  |   | 0-0<br>SH5-3<br>1-2   |   | 0-0<br>F5<br>BB  | 4-0<br>BB<br>1-2<br>BB   |   |   |   | 1 1 0 0 2 0 1  |   |         |   |   |   |   |   |     |   |    |   |    |   |     |    |
| Ed Charles, R (1, 5)<br>OBP: 0.231, SLG: 0.167     | 4-0<br>BB<br>1B<br>BB  |   | 0-0<br>E7<br>1B<br>2-H  |   | 0-0<br>SF7<br>1B<br>1-3  | 0-3<br>K<br>3  |   |   |   | 3 1 2 0 1 1 2  |   |         |   |   |   |   |   |     |   |    |   |    |   |     |    |
| Rocky Colavito, R (1, 9)<br>OBP: 0.417, SLG: 0.333 | 0-0<br>1-3<br>2-H<br>1B  |   | 0-0<br>F9<br>1-2  |   | 4-0<br>SF7<br>1B<br>BB   | 4-0<br>BB<br>BB  |   |   |   | 2 1 1 1 2 0 1  |   |         |   |   |   |   |   |     |   |    |   |    |   |     |    |
| Jim Gentile, L (1, 3)<br>OBP: 0.182, SLG: 0.500    | 0-3<br>K<br>3  |   | 0-0<br>F8<br>3  |   | 0-0<br>SF7<br>1-2<br>2-H<br>3-H                                  |  |   |   |   | 2 0 0 1 0 1 3  |   |         |   |   |   |   |   |     |   |    |   |    |   |     |    |
| Doc Edwards, R (1, 2)<br>OBP: 0.400, SLG: 0.444    | 0-3<br>K<br>3  |   |   | 0-0<br>2B   | 0-0<br>FC6-4<br>1B<br>2-H  |  |   |   |   | 3 0 2 1 0 1 2  |   |         |   |   |   |   |   |     |   |    |   |    |   |     |    |
| Tommie Reynolds, R (1, 7)                          |  | 0-0<br>F9<br>1  |   | 0-0<br>6-3<br>1   | 0-0<br>FC6-4<br>1-2f<br>3  |  |   |   |   | 3 0 0 0 0 0 2  |   |         |   |   |   |   |   |     |   |    |   |    |   |     |    |
| Dick Green, R (1, 4)                               |  | 0-3<br>K<br>2   |   | 0-0<br>1-3<br>2   |  | 0-0<br>6-3<br>1  |   |   |   | 3 0 0 0 0 1 1  |   |         |   |   |   |   |   |     |   |    |   |    |   |     |    |
| Orlando Pena, R (1, 1)                             |  | 0-0<br>5-3<br>3   |   | 0-0<br>P4<br>3  |  | 0-3<br>K<br>2  |   |   |   | 3 0 0 0 0 1 1  |   |         |   |   |   |   |   |     |   |    |   |    |   |     |    |
| Inning Stats                                       | R: 1<br>E: 0<br>K: 2<br>S: 8<br>H: 1<br>LOB: 2<br>BB: 2<br>P: 16 | R: 0<br>E: 0<br>K: 1<br>S: 5<br>H: 0<br>LOB: 0<br>BB: 0<br>P: 5 | R: 1<br>E: 1<br>K: 0<br>S: 5<br>H: 2<br>LOB: 1<br>BB: 0<br>P: 5 | R: 0<br>E: 0<br>K: 0<br>S: 4<br>H: 1<br>LOB: 1<br>BB: 0<br>P: 4 | R: 3<br>E: 0<br>K: 0<br>S: 5<br>H: 2<br>LOB: 1<br>BB: 2<br>P: 13 | R: 0<br>E: 0<br>K: 2<br>S: 8<br>H: 1<br>LOB: 2<br>BB: 1<br>P: 12 | R: 0<br>E: 0<br>K: 0<br>S: 0<br>H: 0<br>LOB: 1<br>BB: 1<br>P: 4 |   |   | 1B: 6<br>2B: 1<br>3B: 0<br>HR: 0<br>SF: 1<br>SAC: 1<br>DP: 0<br>HBP: 0 | WP: 0<br>PB: 0<br>SB: 0<br>CS: 0<br>PA: 31  |         |   |   |   |   |   |     |   |    |   |    |   |     |    |
| PITCHER  | IP WLS BF H R ER SO BB IBB HBP BLK WP HR S P ERA WHIP            |   |   |   |  |  |   |   |   |  |   | PITCHER | IP WLS BF H R ER SO BB IBB HBP BLK WP HR S P ERA WHIP |   |   |   |   |     |   |    |   |    |   |     |    |
| Claude Osteen, L (1, 1)<br>ERA: 5.4                | 4.2 L 24 6 5 4 3 4 0 0 0 0 0 0 26 42 7.71 2.143                  |   |   |   |  |  |   |   |   |  |   |         |   |   |   |   |   |     |   |    |   |    |   |     |    |
| Jim Hannan, R (5, 1)<br>ERA:                       | 1.1 6 1 0 0 2 1 0 0 0 0 0 0 9 13 0.00 1.500                      |   |   |   |  |  |   |   |   |  |   |         |   |   |   |   |   |     |   |    |   |    |   |     |    |
| Ed Roebuck, R (7, 1)<br>ERA: 9.0                   | 0.0 1 0 0 0 0 1 0 0 0 0 0 0 0 4 ∞ ∞                              |   |   |   |  |  |   |   |   |  |   |         |   |   |   |   |   |     |   |    |   |    |   |     |    |

| Batter   | 1                            | 2                               | 3                            | 4                               | 5                            | 6                               | 7                            | 8                               | 9                            | AB                              | R                            | H                               | RBI | BB | SO | LOB |  |
|--|------------------------------|---------------------------------|------------------------------|---------------------------------|------------------------------|---------------------------------|------------------------------|---------------------------------|------------------------------|---------------------------------|------------------------------|---------------------------------|-----|----|----|-----|--|
| Don Blasingame, L (1, 4)<br>OBP: 0.250, SLG: 0.364 | 0-0<br>3B                    |                                 | 0-0<br>F9                    |                                 |                              | 0-0<br>4-3                      |                              |                                 |                              | 3                               | 0                            | 1                               | 0   | 0  | 0  | 0   |  |
| Ed Brinkman, R (1, 6)<br>OBP: 0.217, SLG: 0.478    | 0-3<br>K                     |                                 |                              | 0-0<br>SF8<br>3B                |                              | 0-0<br>6-3                      |                              |                                 |                              | 3                               | 1                            | 1                               | 0   | 0  | 1  | 1   |  |
| Chuck Hinton, R (1, 7)<br>OBP: 0.391, SLG: 0.789   | 0-3<br>K                     |                                 |                              | 0-0<br>SF8                      |                              |                                 |                              |                                 |                              | 1                               | 0                            | 0                               | 1   | 0  | 1  | 1   |  |
| Ken Hunt, R (6, 7)<br>OBP: 0.286, SLG: 0.667       | 0-3<br>K                     |                                 |                              | 3-H<br>0-3<br>K                 |                              |                                 |                              |                                 |                              | 0                               | 0                            | 0                               | 0   | 0  | 0  | 0   |  |
| Bill Skowron, R (1, 3)<br>OBP: 0.217, SLG: 0.478   | 0-0<br>P4                    |                                 |                              | 0-3<br>K                        |                              |                                 |                              |                                 |                              | 2                               | 0                            | 0                               | 0   | 0  | 1  | 1   |  |
| Jim King, L (1, 9)                                 |                              | 0-3<br>K                        |                              | 0-0<br>4-1                      |                              |                                 |                              |                                 |                              | 2                               | 0                            | 0                               | 0   | 0  | 1  | 0   |  |
| Don Lock, R (1, 8)<br>OBP: 0.455, SLG: 0.438       |                              | 0-0<br>F8                       |                              |                                 | 0-3<br>K                     |                                 |                              |                                 |                              | 2                               | 0                            | 0                               | 0   | 0  | 1  | 0   |  |
| Mike Brumley, L (1, 2)                             |                              | 0-0<br>F9                       |                              |                                 | 0-3<br>K                     |                                 |                              |                                 |                              | 2                               | 0                            | 0                               | 0   | 0  | 1  | 0   |  |
| John Kennedy, R (1, 5)<br>OBP: 0.316, SLG: 0.188   |                              |                                 | 0-0<br>F8                    |                                 | 0-3<br>K                     |                                 |                              |                                 |                              | 2                               | 0                            | 0                               | 0   | 0  | 1  | 0   |  |
| Claude Osteen, L (1, 1)<br>OBP: 0.333, SLG: 0.667  |                              |                                 | 0-3<br>K                     |                                 |                              | 0-3<br>K                        |                              |                                 |                              | 1                               | 0                            | 0                               | 0   | 0  | 1  | 0   |  |
| Jim Hannan, R (5, 1)                               |                              |                                 |                              |                                 |                              |                                 |                              |                                 |                              | 0                               | 0                            | 0                               | 0   | 0  | 0  | 0   |  |
| Don Zimmer, R (6, PH)<br>OBP: 0.250, SLG: 0.500    |                              |                                 |                              |                                 |                              |                                 |                              |                                 |                              | 1                               | 0                            | 0                               | 0   | 0  | 1  | 0   |  |
| Ed Roebuck, R (7, 1)                               |                              |                                 |                              |                                 |                              |                                 |                              |                                 |                              | 0                               | 0                            | 0                               | 0   | 0  | 0  | 0   |  |
| <b>Inning Stats</b>                                | R: 0<br>E: 0<br>K: 2<br>S: 8 | H: 1<br>LOB: 1<br>BB: 0<br>P: 8 | R: 0<br>E: 0<br>K: 1<br>S: 5 | H: 0<br>LOB: 0<br>BB: 0<br>P: 5 | R: 0<br>E: 0<br>K: 1<br>S: 5 | H: 0<br>LOB: 0<br>BB: 0<br>P: 5 | R: 1<br>E: 0<br>K: 1<br>S: 6 | H: 1<br>LOB: 0<br>BB: 0<br>P: 6 | R: 0<br>E: 0<br>K: 3<br>S: 9 | H: 0<br>LOB: 0<br>BB: 0<br>P: 9 | R: 0<br>E: 0<br>K: 1<br>S: 5 | H: 0<br>LOB: 0<br>BB: 0<br>P: 5 |     |    |    |     |  |

**BOTTOM**

Kansas City Athletics @ Washington Senators  
D.C. Stadium, Washington, DC  
Sun Apr 19 1964, 3:33 AM EST  
Att. 8,500 - Unknown

[livebaseballscorecards.com](http://livebaseballscorecards.com)

|            |           |
|------------|-----------|
| <b>AB</b>  | <b>19</b> |
| <b>R</b>   | <b>1</b>  |
| <b>H</b>   | <b>2</b>  |
| <b>RBI</b> | <b>1</b>  |
| <b>BB</b>  | <b>0</b>  |
| <b>SO</b>  | <b>9</b>  |
| <b>LOB</b> | <b>3</b>  |



| PITCHER                             | IP  | WLS | BF | H | R | ER | SO | BB | IBB | HBP | BLK | WP | HR | S  | P  | ERA  | WHIP  |
|-------------------------------------|-----|-----|----|---|---|----|----|----|-----|-----|-----|----|----|----|----|------|-------|
| Orlando Pena, R (1, 1)<br>ERA: 4.09 | 6.0 | W   | 20 | 2 | 1 | 1  | 9  | 0  | 0   | 0   | 0   | 0  | 0  | 38 | 38 | 1.50 | 0.333 |

|       |        |
|-------|--------|
| WP: 0 | PA: 20 |
| PB: 0 | SB: 0  |
| CS: 0 |        |

| Batter  | 1   | 2                               | 3                            | 4                                | 5                            | 6                               | 7                            | 8                               | 9                            | AB R H RBI BB SO LOB            | TOP   |                                 |   |                                 |                              |                                 |                              |                                  |                                  |                                    |                 |
|---|---|---------------------------------|------------------------------|----------------------------------|------------------------------|---------------------------------|------------------------------|---------------------------------|------------------------------|---------------------------------|---|---------------------------------|---|---------------------------------|------------------------------|---------------------------------|------------------------------|----------------------------------|----------------------------------|------------------------------------|-----------------|
| Dick Howser, R<br>OBP: 0.286, SLG: 0.385<br>(1, 6)                        | 0-0<br>F5   |                                 | 0-0<br>FC4-6                 |                                  | 0-0<br>F3                    |                                 |                              | 0-0<br>1-3                      | 0-0<br>SF9                   | 4 0 0 1 0 0 2                   | <b>Cleveland Indians @ Kansas City Athletics</b><br>Municipal Stadium, Kansas City, MO<br>Tue Apr 21 1964, 7:05 PM EST<br>Att. 28,165 - Unknown<br><a href="http://livebaseballscorecards.com">livebaseballscorecards.com</a> |                                 |   |                                 |                              |                                 |                              |                                  |                                  |                                    |                 |
| Vic Davalillo, L<br>OBP: 0.400, SLG: 0.429<br>(1, 8)                      | 0-0<br>F6   |                                 | 0-0<br>F5                    |                                  |                              | 0-0<br>F7                       |                              | 0-0<br>HR<br>1B                 | 0-0<br>F7                    | 5 1 1 0 0 0 2                   |   |                                 |   |                                 |                              |                                 |                              |                                  |                                  |                                    |                 |
| Leon Wagner, L<br>OBP: 0.571, SLG: 1.000<br>(1, 7)                        | 0-3<br>K  |                                 |                              | 0-3<br>K                         |                              | 0-0<br>6-3<br>1B                |                              | 0-0<br>HR<br>1B                 |                              | 4 1 2 2 0 2 0                   |   |                                 |   |                                 |                              |                                 |                              |                                  |                                  |                                    |                 |
| Max Alvis, R<br>OBP: 0.154, SLG: 0.308<br>(1, 5)                          |   | 0-0<br>F7                       |                              | 0-0<br>F7                        |                              | 0-0<br>6-3<br>1B                |                              | 0-3<br>K                        |                              | 4 0 0 0 0 1 1                   |   |                                 |   |                                 |                              |                                 |                              |                                  |                                  |                                    |                 |
| Fred Whitfield, L<br>OBP: 0.182, SLG: 0.100<br>Jerry Kindall, R<br>(8, 3) |   | 0-3<br>K                        |                              | 0-0<br>F6                        |                              | 0-0<br>F3                       |                              | 0-0<br>3-1                      |                              | 4 0 0 0 0 1 1<br>0 0 0 0 0 0 0  |   |                                 |   |                                 |                              |                                 |                              |                                  |                                  |                                    |                 |
| Tito Francona, L<br>OBP: 0.667, SLG: 0.625<br>(1, 9)                      |   | 4-0<br>BB                       |                              |                                  | 0-0<br>2B<br>1B              |                                 | 0-3<br>K                     |                                 | 0-0<br>BB<br>SF9<br>1B       | 3 2 2 0 1 1 0                   |   |                                 |   |                                 |                              |                                 |                              |                                  |                                  |                                    |                 |
| John Romano, R<br>OBP: 0.417, SLG: 0.727<br>(1, 2)                        |   | 0-3<br>K                        |                              |                                  | 0-0<br>1-3<br>1-H<br>2B      |                                 | 0-0<br>1B                    |                                 | 4-0<br>SF9<br>BB<br>BB       | 3 1 2 1 1 1 1                   |   |                                 |   |                                 |                              |                                 |                              |                                  |                                  |                                    |                 |
| Woodie Held, R<br>OBP: 0.250, SLG: 0.545<br>(1, 4)                        |   |                                 | 0-0<br>5-3                   |                                  | 0-0<br>F8                    |                                 | 0-3<br>K                     |                                 | 4-0<br>1-2<br>2-3<br>BB      | 3 0 0 0 1 1 2                   |   |                                 |   |                                 |                              |                                 |                              |                                  |                                  |                                    |                 |
| Mudcat Grant, R<br>OBP: 0.333, SLG: 0.250<br>Ted Abernathy, R<br>(9, 1)   |   |                                 | 4-0<br>FC4-6<br>BB           |                                  | 0-0<br>1-3                   |                                 | 0-0<br>4-3                   |                                 | 0-0<br>SF9                   | 2 0 0 1 1 0 2<br>0 0 0 0 0 0 0  |   |                                 |   |                                 |                              |                                 |                              |                                  |                                  |                                    |                 |
| <b>Inning Stats</b>   | R: 0<br>E: 0<br>K: 1<br>S: 5                          | H: 0<br>LOB: 0<br>BB: 0<br>P: 5 | R: 0<br>E: 0<br>K: 2<br>S: 7 | H: 0<br>LOB: 1<br>BB: 1<br>P: 11 | R: 0<br>E: 0<br>K: 0<br>S: 3 | H: 0<br>LOB: 1<br>BB: 1<br>P: 7 | R: 0<br>E: 0<br>K: 1<br>S: 5 | H: 0<br>LOB: 0<br>BB: 0<br>P: 5 | R: 1<br>E: 0<br>K: 0<br>S: 5 | H: 2<br>LOB: 1<br>BB: 0<br>P: 5 | R: 0<br>E: 0<br>K: 0<br>S: 4  | H: 1<br>LOB: 1<br>BB: 0<br>P: 4 | R: 0<br>E: 0<br>K: 2<br>S: 8                          | H: 1<br>LOB: 1<br>BB: 0<br>P: 8 | R: 2<br>E: 0<br>K: 1<br>S: 7 | H: 2<br>LOB: 0<br>BB: 0<br>P: 7 | R: 2<br>E: 0<br>K: 0<br>S: 4 | H: 1<br>LOB: 1<br>BB: 2<br>P: 12 | 1B: 5<br>2B: 1<br>3B: 0<br>HR: 1 | SF: 2<br>SAC: 0<br>DP: 0<br>HBP: 0 | WP: 0<br>PA: 38 |
| <b>PITCHER</b>  | IP WLS BF H R ER SO BB IBB HBP BLK WP HR S P ERA WHIP |                                 |                              |                                  |                              |                                 |                              |                                 |                              |                                 |   |                                 | IP WLS BF H R ER SO BB IBB HBP BLK WP HR S P ERA WHIP |                                 |                              |                                 |                              |                                  |                                  |                                    |                 |
| Diego Segui, R<br>ERA: 6.43<br>(1, 1)                                     | 8.0 L 35 7 5 5 7 4 0 0 0 0 0 1 45 61 5.62 1.375       |                                 |                              |                                  |                              |                                 |                              |                                 |                              |                                 |   |                                 |   |                                 |                              |                                 |                              |                                  |                                  |                                    |                 |
| John Wyatt, R<br>ERA:<br>(9, 1)   | 1.0 3 0 0 0 0 0 0 0 0 0 0 0 3 3 0.00 0.000            |                                 |                              |                                  |                              |                                 |                              |                                 |                              |                                 |   |                                 |   |                                 |                              |                                 |                              |                                  |                                  |                                    |                 |





| Batter  | 1                     | 2                      | 3          | 4                       | 5          | 6         | 7                     | 8          | 9                                  | AB R H RBI BB SO LOB   |
|---|-----------------------|------------------------|------------|-------------------------|------------|-----------|-----------------------|------------|------------------------------------|--|
| Nelson Mathews, R (1, 8)<br>OBP: 0.389, SLG: 0.500  | 0-3<br>K              |                        | 0-0<br>4-3 |                         | 0-0<br>F3  |           | 0-0<br>F8             |            | 0-3<br>K                           | 5 0 0 0 0 2 2  |
| Wayne Causey, L (1, 6)<br>OBP: 0.706, SLG: 0.600  | 4-0<br>G1-6-3<br>BB   |                        | 0-0<br>1B  |                         | 0-3<br>K   |           | 0-0<br>G1-6-3<br>1B   |            | 4-0<br>FC1-2<br>1-2<br>BB          | 3 0 2 0 2 1 0  |
| Manny Jimenez, L (1, 7)<br>OBP: 0.333, SLG: 0.800<br>Jose Tartabull, L (8, 7)   | 0-0<br>G1-6-3<br>1-2f |                        | 0-0<br>4-3 |                         | 1-0<br>HBP |           | 0-0<br>G1-6-3<br>1-2f |            | 0-0<br>FC1-2<br>1-2<br>2-3<br>3-Hf | 3 0 0 0 0 0 3<br>1 0 0 0 0 0 3                                   |
| Jim Gentile, L (1, 3)<br>OBP: 0.125, SLG: 0.333   |                       | 0-3<br>K               |            | 0-0<br>F7               |            | 0-0<br>F8 |                       | 0-0<br>F5  | 0-0<br>F4                          | 5 0 0 0 0 1 4  |
| Rocky Colavito, R (1, 9)<br>OBP: 0.313, SLG: 0.231  |                       | 0-0<br>6-3             |            | 0-3<br>K                |            | 0-0<br>F7 |                       | 0-0<br>6-3 |                                    | 4 0 0 0 0 1 0  |
| Ed Charles, R (1, 5)<br>OBP: 0.294, SLG: 0.313  |                       | 0-0<br>WP<br>2B        |            | 0-0<br>BB<br>1B         |            | 0-3<br>K  |                       | 0-0<br>5-3 |                                    | 4 1 2 0 0 1 0  |
| Billy Bryan, L (1, 2)<br>OBP: 0.800, SLG: 2.000   |                       | 4-0<br>BB<br>2-3<br>BB |            | 4-0<br>1B<br>1-2<br>BB  |            | 4-0<br>BB |                       |            | 0-0<br>HR                          | 1 1 1 1 3 0 0  |
| Dick Green, R (1, 4)<br>OBP: 0.143, SLG: 0.143  |                       | 0-0<br>F8              |            | 0-0<br>1-2<br>2-H<br>1B |            | 0-0<br>F5 |                       |            | 0-0<br>1B<br>FC1-2<br>1B           | 4 0 2 1 0 0 3  |
| Diego Segui, R (1, 1)<br>OBP: 0.400, SLG: 1.000<br>John Wyatt, R (9, 1)<br>Charlie Lau, L (9, PH)<br>OBP: 1.000, SLG: 1.000<br>George Williams, R (9, PR) |                       |                        | 0-0<br>6-3 |                         | 0-3<br>K   |           | 0-0<br>HR             |            | 0-0<br>FC1-2<br>BB<br>1-3<br>1B    | 3 1 1 1 0 1 2<br>0 0 0 0 0 0 0<br>1 0 1 0 0 0 0<br>0 0 0 0 0 0 0 |

**BOTTOM**

**Cleveland Indians @ Kansas City Athletics**  
Municipal Stadium, Kansas City, MO

livebaseballscores.com

|            |           |
|------------|-----------|
| <b>AB</b>  | <b>34</b> |
| <b>R</b>   | <b>3</b>  |
| <b>H</b>   | <b>9</b>  |
| <b>RBI</b> | <b>3</b>  |
| <b>BB</b>  | <b>5</b>  |
| <b>SO</b>  | <b>7</b>  |
| <b>LOB</b> | <b>17</b> |

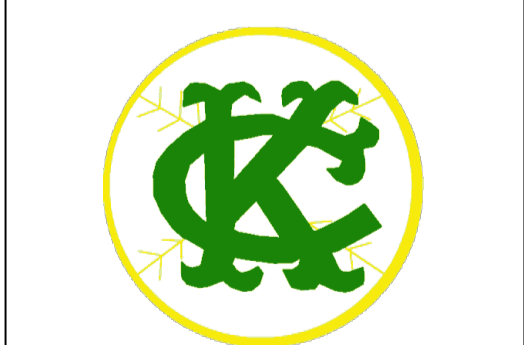

|       |        |
|-------|--------|
| WP: 1 | PA: 40 |
| PB: 0 |        |
| SB: 0 |        |
| CS: 0 |        |

| Inning Stats                        | R: 0 | H: 0 | E: 0 | K: 1 | S: 4 | H: 0 | LOB: 0 | BB: 1 | P: 8 | R: 0 | H: 1 | E: 0 | K: 1 | S: 6 | H: 1 | LOB: 2 | BB: 1 | P: 10 | R: 0 | H: 1 | E: 0 | K: 0 | S: 4 | H: 2 | LOB: 2 | BB: 1 | P: 13 | R: 0 | H: 0 | E: 0 | K: 1 | S: 5 | H: 0 | LOB: 1 | BB: 0 | P: 6 | R: 0 | H: 0 | E: 0 | K: 1 | S: 9 | H: 0 | LOB: 1 | BB: 1 | P: 9 | R: 1 | H: 2 | E: 0 | K: 0 | S: 4 | H: 2 | LOB: 0 | BB: 0 | P: 4 | R: 0 | H: 0 | E: 0 | K: 0 | S: 3 | H: 0 | LOB: 0 | BB: 0 | P: 3 | R: 1 | H: 3 | E: 0 | K: 1 | S: 8 | H: 3 | LOB: 3 | BB: 1 | P: 12 | 1B: 6 | SF: 0 | 2B: 1 | SAC: 0 | 3B: 0 | DP: 2 | HR: 2 | HBP: 1 | WP: 1 | PA: 40 |
|-------------------------------------|------|------|------|------|------|------|--------|-------|------|------|------|------|------|------|------|--------|-------|-------|------|------|------|------|------|------|--------|-------|-------|------|------|------|------|------|------|--------|-------|------|------|------|------|------|------|------|--------|-------|------|------|------|------|------|------|------|--------|-------|------|------|------|------|------|------|------|--------|-------|------|------|------|------|------|------|------|--------|-------|-------|-------|-------|-------|--------|-------|-------|-------|--------|-------|--------|
| <b>PITCHER</b>                      | IP   | WLS  | BF   | H    | R    | ER   | SO     | BB    | IBB  | HBP  | BLK  | WP   | HR   | S    | P    | ERA    | WHIP  |       |      |      |      |      |      |      |        |       |       |      |      |      |      |      |      |        |       |      |      |      |      |      |      |      |        |       |      |      |      |      |      |      |      |        |       |      |      |      |      |      |      |      |        |       |      |      |      |      |      |      |      |        |       |       |       |       |       |        |       |       |       |        |       |        |
| Mudcat Grant, R (1, 1)<br>ERA: 5.68 | 8.0  | W    | 35   | 8    | 3    | 3    | 6      | 4     | 0    | 1    | 0    | 1    | 2    | 42   | 59   | 3.38   | 1.500 |       |      |      |      |      |      |      |        |       |       |      |      |      |      |      |      |        |       |      |      |      |      |      |      |      |        |       |      |      |      |      |      |      |      |        |       |      |      |      |      |      |      |      |        |       |      |      |      |      |      |      |      |        |       |       |       |       |       |        |       |       |       |        |       |        |
| Ted Abernathy, R (9, 1)<br>ERA:     | 1.0  | S    | 5    | 1    | 0    | 0    | 1      | 1     | 0    | 0    | 0    | 0    | 0    | 6    | 10   | 0.00   | 2.000 |       |      |      |      |      |      |      |        |       |       |      |      |      |      |      |      |        |       |      |      |      |      |      |      |      |        |       |      |      |      |      |      |      |      |        |       |      |      |      |      |      |      |      |        |       |      |      |      |      |      |      |      |        |       |       |       |       |       |        |       |       |       |        |       |        |

Tue Apr 21 1964, 7:05 PM EST  
Att. 28,165 - Unknown

| Batter  | 1   | 2                               | 3                            | 4                               | 5                            | 6                               | 7                            | 8                               | 9                            | 10                              | AB                           | R                               | H                            | RBI                             | BB                           | SO                              | LOB                          | TOP                             |                               |                                  |                                  |                                    |                                  |        |
|---|---|---------------------------------|------------------------------|---------------------------------|------------------------------|---------------------------------|------------------------------|---------------------------------|------------------------------|---------------------------------|------------------------------|---------------------------------|------------------------------|---------------------------------|------------------------------|---------------------------------|------------------------------|---------------------------------|-------------------------------|----------------------------------|----------------------------------|------------------------------------|----------------------------------|--------|
| <b>Don Zimmer, R</b> (1, 5)<br><small>OBP: 0.333, SLG: 0.667</small><br><b>John Kennedy, R</b> (10, 5)<br><small>OBP: 0.318, SLG: 0.167</small> | 0-0<br>SH1-3<br>2B  |                                 | 0-0<br>HR                    |                                 |                              | 0-3<br>K                        |                              | 0-3<br>K                        |                              | 0-3<br>K                        | 5                            | 1                               | 2                            | 1                               | 0                            | 3                               | 4                            |                                 |                               |                                  |                                  |                                    |                                  |        |
| <b>Don Blasingame, L</b> (1, 4)<br><small>OBP: 0.429, SLG: 0.526</small>  | 0-0<br>SH1-3<br>2-3   |                                 | 0-0<br>F9                    |                                 |                              | 0-0<br>4-3                      |                              |                                 | 0-0<br>G5-4-3<br>1B          | 0-0<br>WP<br>1B<br>2B           | 4                            | 1                               | 2                            | 2                               | 0                            | 0                               | 0                            |                                 |                               |                                  |                                  |                                    |                                  |        |
| <b>Chuck Hinton, R</b> (1, 7)<br><small>OBP: 0.351, SLG: 0.576</small>  | 0-0<br>P4   |                                 |                              | 0-0<br>1-3                      |                              |                                 | 0-0<br>P4-3<br>1B            |                                 | 0-3<br>K                     | 0-0<br>1B<br>1B                 | 5                            | 0                               | 2                            | 1                               | 0                            | 1                               | 2                            |                                 |                               |                                  |                                  |                                    |                                  |        |
| <b>Bill Skowron, R</b> (1, 3)<br><small>OBP: 0.270, SLG: 0.541</small>  | 0-3<br>K  |                                 |                              | 0-0<br>5-3                      |                              |                                 | 0-0<br>F9                    |                                 | 0-0<br>G5-4-3<br>1-2f        | 0-0<br>1-3<br>1B                | 5                            | 0                               | 1                            | 0                               | 0                            | 1                               | 3                            |                                 |                               |                                  |                                  |                                    |                                  |        |
| <b>Jim King, L</b> (1, 9)<br><small>OBP: 0.160, SLG: 0.250</small>  |   | 0-0<br>1-3                      |                              | 0-0<br>F8                       |                              |                                 | 0-0<br>P4-3<br>1-2f          |                                 |                              | 0-0<br>F8<br>4-3                | 5                            | 0                               | 0                            | 0                               | 0                            | 0                               | 3                            |                                 |                               |                                  |                                  |                                    |                                  |        |
| <b>Don Lock, R</b> (1, 8)<br><small>OBP: 0.424, SLG: 0.333</small>  |   | 0-3<br>K                        |                              |                                 | 4-0<br>CS<br>BB              |                                 |                              | 0-0<br>1B<br>1B                 |                              | 0-0<br>E6<br>1B                 | 3                            | 1                               | 1                            | 0                               | 1                            | 1                               | 0                            |                                 |                               |                                  |                                  |                                    |                                  |        |
| <b>Mike Brumley, L</b> (1, 2)<br><b>Fred Valentine, S</b> (10, PH)<br><b>Ken Retzer, L</b> (10, 2)  |   | 0-3<br>K                        |                              |                                 | 0-3<br>K<br>1-2              |                                 |                              | 0-0<br>F8                       |                              | 4-0<br>1B<br>BB                 | 3                            | 0                               | 0                            | 0                               | 0                            | 2                               | 2                            |                                 |                               |                                  |                                  |                                    |                                  |        |
| <b>Ed Brinkman, R</b> (1, 6)<br><small>OBP: 0.250, SLG: 0.400</small>   |   |                                 | 0-0<br>F8                    |                                 | 0-0<br>1-3                   |                                 |                              | 0-0<br>1-2<br>1B                |                              | 0-0<br>1B<br>2B<br>1B           | 4                            | 1                               | 2                            | 1                               | 0                            | 0                               | 0                            |                                 |                               |                                  |                                  |                                    |                                  |        |
| <b>Claude Osteen, L</b> (1, 1)<br><small>OBP: 0.286, SLG: 0.429</small>   |   |                                 | 0-3<br>K                     |                                 |                              | 0-0<br>2-3                      |                              | 0-3<br>K                        |                              | 0-0<br>1-2<br>2-H<br>2B<br>1B   | 4                            | 1                               | 1                            | 1                               | 0                            | 2                               | 2                            |                                 |                               |                                  |                                  |                                    |                                  |        |
| <b>Inning Stats</b>   | R: 0<br>E: 0<br>K: 1<br>S: 6  | H: 1<br>LOB: 1<br>BB: 0<br>P: 6 | R: 0<br>E: 0<br>K: 2<br>S: 7 | H: 0<br>LOB: 0<br>BB: 0<br>P: 7 | R: 1<br>E: 0<br>K: 1<br>S: 6 | H: 1<br>LOB: 0<br>BB: 0<br>P: 6 | R: 0<br>E: 0<br>K: 0<br>S: 3 | H: 0<br>LOB: 0<br>BB: 0<br>P: 3 | R: 0<br>E: 0<br>K: 1<br>S: 4 | H: 0<br>LOB: 0<br>BB: 1<br>P: 8 | R: 0<br>E: 0<br>K: 1<br>S: 5 | H: 0<br>LOB: 0<br>BB: 0<br>P: 5 | R: 0<br>E: 0<br>K: 0<br>S: 3 | H: 1<br>LOB: 0<br>BB: 0<br>P: 3 | R: 0<br>E: 0<br>K: 2<br>S: 9 | H: 2<br>LOB: 2<br>BB: 0<br>P: 9 | R: 0<br>E: 0<br>K: 1<br>S: 5 | H: 1<br>LOB: 0<br>BB: 0<br>P: 5 | R: 5<br>E: 1<br>K: 1<br>S: 11 | H: 5<br>LOB: 2<br>BB: 1<br>P: 15 | 1B: 8<br>2B: 3<br>3B: 0<br>HR: 1 | SF: 0<br>SAC: 1<br>DP: 2<br>HBP: 0 | WP: 1<br>PB: 0<br>SB: 0<br>CS: 1 | PA: 41 |
| <b>PITCHER</b>  | IP<br>WLS<br>BF<br>H<br>R<br>ER<br>SO<br>BB<br>IBB<br>HBP<br>BLK<br>WP<br>HR<br>S<br>P<br>ERA<br>WHIP |                                 |                              |                                 |                              |                                 |                              |                                 |                              |                                 |                              |                                 |                              |                                 |                              |                                 |                              |                                 |                               |                                  |                                  |                                    |                                  |        |
| <b>Orlando Pena, R</b> (1, 1)<br><small>ERA: 3.1</small>  | 9.1   | L                               | 35                           | 7                               | 4                            | 2                               | 9                            | 2                               | 0                            | 0                               | 0                            | 0                               | 0                            | 0                               | 0                            | 1                               | 1                            | 1.93                            | 0.964                         |                                  |                                  |                                    |                                  |        |
| <b>Ted Bowsfield, L</b> (10, 1)<br><small>ERA: 4.5</small>  | 0.0   |                                 | 1                            | 1                               | 0                            | 0                               | 0                            | 0                               | 0                            | 0                               | 0                            | 0                               | 0                            | 0                               | 0                            | 1                               | 1                            | ∞                               | ∞                             |                                  |                                  |                                    |                                  |        |
| <b>John Wyatt, R</b> (10, 1)<br><small>ERA:</small>   | 0.1   |                                 | 4                            | 3                               | 2                            | 0                               | 1                            | 0                               | 0                            | 0                               | 0                            | 0                               | 0                            | 0                               | 0                            | 6                               | 6                            | 0.00                            | 9.000                         |                                  |                                  |                                    |                                  |        |
| <b>John O'Donoghue, L</b> (10, 1)<br><small>ERA:</small>  | 0.1   |                                 | 1                            | 0                               | 0                            | 0                               | 0                            | 0                               | 0                            | 0                               | 0                            | 0                               | 0                            | 0                               | 0                            | 1                               | 1                            | 0.00                            | 0.000                         |                                  |                                  |                                    |                                  |        |

Washington Senators @ Kansas City Athletics  
Municipal Stadium, Kansas City, MO  
Fri Apr 24 1964, 7:05 PM EST  
Att: 5,452 - Unknown

livebaseballscorecards.com

**AB** 38  
**R** 6  
**H** 11  
**RBI** 6  
**BB** 2  
**SO** 10  
**LOB** 16



| Batter  | 1                | 2          | 3                | 4          | 5          | 6                | 7                    | 8                     | 9          | 10                             | AB R H RBI BB SO LOB |
|---|------------------|------------|------------------|------------|------------|------------------|----------------------|-----------------------|------------|--------------------------------|----------------------|
| Nelson Mathews, R<br>OBP: 0.348, SLG: 0.429 (1, 8)  | 0-0<br>5-3       |            | 0-0<br>4-3       |            | 0-3<br>K   |                  | 0-0<br>F8            |                       |            | 0-0<br>FC1-6<br>1B             | 5 0 1 0 0 1 0        |
| Wayne Causey, L<br>OBP: 0.636, SLG: 0.500 (1, 6)    | 0-0<br>P3        |            | 4-0<br>2B<br>BB  |            | 0-0<br>1-3 |                  | 0-0<br>FC6-4<br>1B   |                       |            | 0-0<br>FC1-6<br>G4-6-3<br>1-2f | 4 1 1 0 1 0 1        |
| Ed Charles, R<br>OBP: 0.318, SLG: 0.350 (1, 5)      | 4-0<br>S<br>BB   |            | 0-0<br>1-H<br>2B |            | 0-0<br>6-3 |                  | 0-0<br>FC6-4<br>1-2f |                       |            | 0-0<br>G4-6-3<br>1-2f          | 4 0 1 1 1 0 2        |
| Rocky Colavito, R<br>OBP: 0.350, SLG: 0.250 (1, 9)  | 0-0<br>F7<br>1-2 |            | 4-0<br>BB        |            |            | 0-0<br>G3        |                      | 0-0<br>G3-6-1<br>1B   |            |                                | 3 0 1 0 1 0 1        |
| Jim Gentile, L<br>OBP: 0.150, SLG: 0.316 (1, 3)     |                  | 0-3<br>K   | 0-0<br>P6        |            |            | 0-0<br>1B<br>1B  |                      | 0-0<br>F7             |            |                                | 4 0 1 0 0 1 3        |
| Doc Edwards, R<br>OBP: 0.357, SLG: 0.385 (1, 2)     |                  | 0-0<br>F2  |                  | 0-0<br>4-3 |            | 0-0<br>1-2<br>1B |                      | 0-0<br>G3-6-1<br>1-2f |            |                                | 4 0 1 0 0 0 1        |
| Tommie Reynolds, R<br>OBP: 0.250, SLG: 0.143 (1, 7) |                  | 0-0<br>1B  |                  | 4-0<br>BB  |            | 0-0<br>F9        |                      | 0-0<br>F8             |            | 0-0<br>F8                      | 3 0 1 0 1 0 2        |
| Dick Green, R<br>OBP: 0.111, SLG: 0.111 (1, 4)      |                  | 0-0<br>6-3 |                  | 0-0<br>F9  |            | 0-0<br>F8        |                      | 0-0<br>F8             |            | 0-0<br>F8                      | 4 0 0 0 0 0 4        |
| Orlando Pena, R (1, 1)                              |                  |            | 0-3<br>K         |            | 0-3<br>K   |                  | 0-0<br>F9            |                       | 0-0<br>1-3 |                                | 4 0 0 0 0 2 1        |
| Ted Bowsfield, R (10, 1)                            |                  |            |                  |            |            |                  |                      |                       |            |                                | 0 0 0 0 0 0 0        |
| John Wyatt, R (10, 1)                               |                  |            |                  |            |            |                  |                      |                       |            |                                | 0 0 0 0 0 0 0        |
| John O'Donoghue, R (10, 1)                          |                  |            |                  |            |            |                  |                      |                       |            |                                | 0 0 0 0 0 0 0        |

| Inning Stats                                    | R: 0<br>E: 0<br>K: 0<br>S: 3 | H: 0<br>LOB: 1<br>BB: 1<br>P: 7 | R: 0<br>E: 0<br>K: 1<br>S: 6 | H: 1<br>LOB: 1<br>BB: 0<br>P: 6 | R: 1<br>E: 0<br>K: 1<br>S: 6 | H: 1<br>LOB: 2<br>BB: 2<br>P: 14 | R: 0<br>E: 0<br>K: 1<br>S: 5 | H: 0<br>LOB: 1<br>BB: 1<br>P: 9 | R: 0<br>E: 0<br>K: 1<br>S: 5 | H: 0<br>LOB: 0<br>BB: 0<br>P: 5 | R: 0<br>E: 0<br>K: 0<br>S: 5 | H: 2<br>LOB: 2<br>BB: 0<br>P: 5 | R: 0<br>E: 0<br>K: 0<br>S: 4 | H: 1<br>LOB: 1<br>BB: 0<br>P: 4 | R: 0<br>E: 0<br>K: 0<br>S: 3 | H: 1<br>LOB: 0<br>BB: 0<br>P: 3 | R: 0<br>E: 0<br>K: 0<br>S: 3 | H: 0<br>LOB: 0<br>BB: 0<br>P: 3 | R: 0<br>E: 0<br>K: 0<br>S: 3 | H: 1<br>LOB: 0<br>BB: 0<br>P: 3 | 1B: 6<br>2B: 1<br>3B: 0<br>HR: 0 | SF: 0<br>SAC: 0<br>DP: 2<br>HBP: 0 | WP: 0<br>PB: 0<br>SB: 1<br>CS: 0 | PA: 39 |
|---|------------------------------|---------------------------------|------------------------------|---------------------------------|------------------------------|----------------------------------|------------------------------|---------------------------------|------------------------------|---------------------------------|------------------------------|---------------------------------|------------------------------|---------------------------------|------------------------------|---------------------------------|------------------------------|---------------------------------|------------------------------|---------------------------------|----------------------------------|------------------------------------|----------------------------------|--------|
| PITCHER<br>Claude Osteen, L<br>ERA: 3.32 (1, 1) | IP: 10.0                     | WLS: W                          | BF: 39                       | H: 7                            | R: 1                         | ER: 1                            | SO: 4                        | BB: 4                           | IBB: 0                       | HBP: 0                          | BLK: 0                       | WP: 0                           | HR: 0                        | S: 43                           | P: 59                        | ERA: 0.90                       | WHIP: 1.100                  |                                 |                              |                                 |                                  |                                    |                                  |        |

**BOTTOM**

Washington Senators @ Kansas City Athletics  
Municipal Stadium, Kansas City, MO

Fri Apr 24 1964, 7:05 PM EST  
Att. 5,452 - Unknown

livebaseballscorecards.com

|            |           |
|------------|-----------|
| <b>AB</b>  | <b>35</b> |
| <b>R</b>   | <b>1</b>  |
| <b>H</b>   | <b>7</b>  |
| <b>RBI</b> | <b>1</b>  |
| <b>BB</b>  | <b>4</b>  |
| <b>SO</b>  | <b>4</b>  |
| <b>LOB</b> | <b>15</b> |

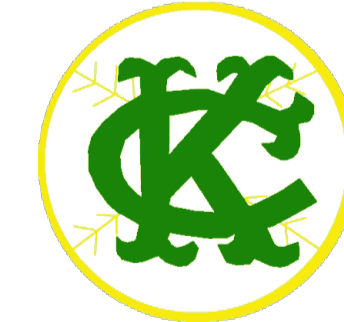

| Batter   | 1   | 2                               | 3                            | 4  | 5                            | 6                               | 7                            | 8                               | 9                            | AB R H RBI BB SO LOB   | TOP                          |                                 |                              |                                 |                              |                                 |                              |                                 |                                  |                                    |                                  |        |
|--|---|---------------------------------|------------------------------|--|------------------------------|---------------------------------|------------------------------|---------------------------------|------------------------------|--|------------------------------|---------------------------------|------------------------------|---------------------------------|------------------------------|---------------------------------|------------------------------|---------------------------------|----------------------------------|------------------------------------|----------------------------------|--------|
| Don Zimmer, R (1, 5)<br>OBP: 0.318, SLG: 0.571   | 0-0<br>6-3  |                                 | 0-3<br>K                     |  | 0-3<br>K                     |                                 |                              | 4-0<br>1B<br>BB                 |                              | 3 0 0 0 1 2 2  |                              |                                 |                              |                                 |                              |                                 |                              |                                 |                                  |                                    |                                  |        |
| Don Blasingame, L (1, 4)<br>OBP: 0.440, SLG: 0.522   | 0-0<br>CS<br>1B                                       |                                 |                              | 0-0<br>FC1-5<br>1B                         |                              | 0-0<br>F7                       |                              | 0-0<br>F8                       |                              | 4 0 2 0 0 0 1  |                              |                                 |                              |                                 |                              |                                 |                              |                                 |                                  |                                    |                                  |        |
| Chuck Hinton, R (1, 7)<br>OBP: 0.366, SLG: 0.622   | 0-3<br>K<br>1-2                                       |                                 |                              | 0-0<br>FC1-5<br>1-2<br>FC4-6<br>1B         |                              | 0-0<br>3B                       |                              | 0-0<br>F9                       |                              | 4 1 2 0 0 1 2  |                              |                                 |                              |                                 |                              |                                 |                              |                                 |                                  |                                    |                                  |        |
| Bill Skowron, R (1, 3)<br>OBP: 0.268, SLG: 0.512   |   | 0-3<br>K                        |                              | 0-0<br>FC1-5<br>1-2<br>2-3f<br>FC4-6<br>1B |                              | 0-3<br>K                        |                              | 0-0<br>1-2<br>1B                |                              | 4 0 1 0 0 2 3  |                              |                                 |                              |                                 |                              |                                 |                              |                                 |                                  |                                    |                                  |        |
| Jim King, L (1, 9)<br>OBP: 0.138, SLG: 0.214   |   | 0-0<br>F8                       |                              | 0-0<br>FC4-6<br>1-2f<br>2-H<br>FC6-4       |                              | 0-0<br>4-3                      |                              | 0-0<br>4-3                      |                              | 4 0 0 1 0 0 4  |                              |                                 |                              |                                 |                              |                                 |                              |                                 |                                  |                                    |                                  |        |
| Don Lock, R (1, 8)<br>OBP: 0.378, SLG: 0.286   |   | 0-0<br>F8                       |                              | 0-0<br>FC6-4<br>1-2f                       |                              | 0-3<br>K                        |                              | 0-0<br>1-3                      |                              | 4 0 0 0 0 1 1  |                              |                                 |                              |                                 |                              |                                 |                              |                                 |                                  |                                    |                                  |        |
| Mike Brumley, L (1, 2)<br>OBP: 0.143, SLG: 0.143   |   |                                 | 0-0<br>SH1-4<br>1B           |  | 0-0<br>4-3                   |                                 | 0-0<br>E5                    |                                 | 0-0<br>FC6-4<br>1B           | 4 0 2 0 0 0 0  |                              |                                 |                              |                                 |                              |                                 |                              |                                 |                                  |                                    |                                  |        |
| Ed Brinkman, R (1, 6)<br>OBP: 0.225, SLG: 0.359  |   |                                 | 0-3<br>K                     |  | 0-3<br>K                     |                                 | 0-3<br>K                     |                                 | 0-0<br>FC6-4<br>1-2f         | 4 0 0 0 0 3 3  |                              |                                 |                              |                                 |                              |                                 |                              |                                 |                                  |                                    |                                  |        |
| Tom Cheney, R (1, 1)<br>Dick Phillips, L (5, PH)<br>Jim Duckworth, R (5, 1)<br>Fred Valentine, S (7, PH)<br>Dave Stenhouse, R (7, 1)<br>Ken Nietzer, L (8, PH) |   |                                 | 0-0<br>SH1-4                 |  | 0-0<br>1B                    |                                 | 0-0<br>P4                    |                                 | 0-0<br>F9                    | 0 0 0 0 0 0 0<br>1 0 1 0 0 0 0<br>0 0 0 0 0 0 0<br>1 0 0 0 0 0 1<br>0 0 0 0 0 0 0<br>1 0 0 0 0 0 1 |                              |                                 |                              |                                 |                              |                                 |                              |                                 |                                  |                                    |                                  |        |
| <b>Inning Stats</b>  | R: 0<br>E: 0<br>K: 1<br>S: 5                          | H: 1<br>LOB: 0<br>BB: 0<br>P: 5 | R: 0<br>E: 0<br>K: 1<br>S: 5 | H: 0<br>LOB: 0<br>BB: 0<br>P: 5            | R: 0<br>E: 0<br>K: 2<br>S: 8 | H: 1<br>LOB: 1<br>BB: 0<br>P: 8 | R: 1<br>E: 0<br>K: 0<br>S: 5 | H: 2<br>LOB: 1<br>BB: 0<br>P: 5 | R: 0<br>E: 0<br>K: 2<br>S: 8 | H: 1<br>LOB: 1<br>BB: 0<br>P: 8  | R: 0<br>E: 0<br>K: 1<br>S: 6 | H: 1<br>LOB: 1<br>BB: 0<br>P: 6 | R: 0<br>E: 1<br>K: 2<br>S: 8 | H: 0<br>LOB: 1<br>BB: 0<br>P: 8 | R: 0<br>E: 0<br>K: 0<br>S: 4 | H: 1<br>LOB: 2<br>BB: 1<br>P: 8 | R: 0<br>E: 0<br>K: 0<br>S: 4 | H: 1<br>LOB: 1<br>BB: 0<br>P: 4 | 1B: 7<br>2B: 0<br>3B: 1<br>HR: 0 | SF: 0<br>SAC: 1<br>DP: 0<br>HBP: 0 | WP: 0<br>PB: 0<br>SB: 0<br>CS: 1 | PA: 36 |
| <b>PITCHER</b>   | IP WLS BF H R ER SO BB IBB HBP BLK WP HR S P ERA WHIP |                                 |                              |  |                              |                                 |                              |                                 |                              |  |                              |                                 |                              |                                 |                              |                                 |                              |                                 |                                  |                                    |                                  |        |
| Moe Drabowsky, R (1, 1)<br>ERA: 1.29   | 7.0 W 28 6 1 1 9 1 0 0 0 0 0 0 45 49 1.29 1.000       |                                 |                              |  |                              |                                 |                              |                                 |                              |  |                              |                                 |                              |                                 |                              |                                 |                              |                                 |                                  |                                    |                                  |        |
| John Wyatt, R (8, 1)<br>ERA:   | 2.0 S 8 2 0 0 0 0 0 0 0 0 0 0 8 8 0.00 1.000          |                                 |                              |  |                              |                                 |                              |                                 |                              |  |                              |                                 |                              |                                 |                              |                                 |                              |                                 |                                  |                                    |                                  |        |

Washington Senators @ Kansas City Athletics  
Municipal Stadium, Kansas City, MO  
Sat Apr 25 1964, 7:05 PM EST  
Att. 5,019 - Unknown

livebaseballscorecards.com

AB 34  
R 1  
H 8  
RBI 1  
BB 1  
SO 9  
LOB 18



| Batter  | 1                  | 2         | 3         | 4                | 5          | 6                     | 7          | 8          | 9 | AB R H RBI BB SO LOB           |
|---|--------------------|-----------|-----------|------------------|------------|-----------------------|------------|------------|---|--------------------------------|
| Nelson Mathews, R<br>OBP: 0.333, SLG: 0.400 (1, 8)  | 0-0<br>F3          |           | 0-0<br>P4 |                  | 0-3<br>K   |                       | 0-0<br>1B  |            |   | 4 0 1 0 0 1 0                  |
| Ed Charles, R<br>OBP: 0.308, SLG: 0.304 (1, 5)      | 4-0<br>3-1 E<br>BB |           | 0-0<br>P4 |                  | 0-0<br>6-3 |                       | 0-0<br>5-3 |            |   | 3 0 0 0 1 0 1                  |
| Wayne Causey, L<br>OBP: 0.615, SLG: 0.556 (1, 6)    | 0-0<br>3-1<br>1-3  |           | 0-0<br>1B |                  | 0-0<br>2B  |                       | 0-0<br>F8  |            |   | 4 0 2 0 0 0 1                  |
| Jim Gentile, L<br>OBP: 0.125, SLG: 0.261 (1, 3)     | 0-0<br>F8          |           | 0-3<br>K  |                  | 0-3<br>K   |                       | 0-3<br>K   |            |   | 4 0 0 0 0 3 3                  |
| Charlie Lau, L<br>OBP: 0.333, SLG: 0.200 (1, 2)     |                    | 0-3<br>K  |           | 0-0<br>F8        |            | 0-3<br>K              |            | 0-0<br>4-3 |   | 4 0 0 0 0 2 0                  |
| Rocky Colavito, R<br>OBP: 0.435, SLG: 0.500 (1, 9)  |                    | 0-0<br>HR |           | 0-0<br>HR<br>1B  |            | 4-0<br>G4-6-3<br>BB   |            |            |   | 2 2 2 1 1 0 0                  |
| Tommie Reynolds, R<br>OBP: 0.273, SLG: 0.111 (1, 7) |                    | 4-0<br>BB |           | 0-3<br>K         |            | 0-0<br>G4-6-3<br>1-2f |            |            |   | 2 0 0 0 1 1 2                  |
| Dick Green, R<br>OBP: 0.143, SLG: 0.286 (1, 4)      |                    | 0-0<br>F7 |           | 0-0<br>1-H<br>HR |            | 0-0<br>F8             |            |            |   | 3 1 1 2 0 0 1                  |
| Moe Drabowsky, R (1, 1)<br>John Wyatt, R (8, 1)     |                    | 0-3<br>K  |           | 0-0<br>F7        |            | 0-0<br>F7             |            |            |   | 3 0 0 0 0 1 1<br>0 0 0 0 0 0 0 |

| Inning Stats | R: 0<br>E: 1<br>K: 0<br>S: 3 | H: 0<br>LOB: 1<br>BB: 1<br>P: 7 | R: 1<br>E: 0<br>K: 2<br>S: 8 | H: 1<br>LOB: 1<br>BB: 1<br>P: 12 | R: 0<br>E: 0<br>K: 1<br>S: 6 | H: 1<br>LOB: 1<br>BB: 0<br>P: 6 | R: 2<br>E: 0<br>K: 1<br>S: 7 | H: 2<br>LOB: 0<br>BB: 0<br>P: 7 | R: 0<br>E: 0<br>K: 2<br>S: 8 | H: 1<br>LOB: 1<br>BB: 0<br>P: 8 | R: 0<br>E: 0<br>K: 1<br>S: 4 | H: 0<br>LOB: 0<br>BB: 1<br>P: 8 | R: 0<br>E: 0<br>K: 0<br>S: 4 | H: 1<br>LOB: 1<br>BB: 0<br>P: 4 | R: 0<br>E: 0<br>K: 1<br>S: 5 | H: 0<br>LOB: 0<br>BB: 0<br>P: 5 | 1B: 3<br>2B: 1<br>3B: 0<br>HR: 2 | SF: 0<br>SAC: 0<br>DP: 1<br>HBP: 0 | WP: 0<br>PB: 0<br>SB: 0<br>CS: 0 | PA: 32 |
|--------------|------------------------------|---------------------------------|------------------------------|----------------------------------|------------------------------|---------------------------------|------------------------------|---------------------------------|------------------------------|---------------------------------|------------------------------|---------------------------------|------------------------------|---------------------------------|------------------------------|---------------------------------|----------------------------------|------------------------------------|----------------------------------|--------|
|--------------|------------------------------|---------------------------------|------------------------------|----------------------------------|------------------------------|---------------------------------|------------------------------|---------------------------------|------------------------------|---------------------------------|------------------------------|---------------------------------|------------------------------|---------------------------------|------------------------------|---------------------------------|----------------------------------|------------------------------------|----------------------------------|--------|

| PITCHER                              | IP  | WLS | BF | H | R | ER | SO | BB | IBB | HBP | BLK | WP | HR | S  | P  | ERA  | WHIP  |
|--------------------------------------|-----|-----|----|---|---|----|----|----|-----|-----|-----|----|----|----|----|------|-------|
| Tom Cheney, R (1, 1)<br>ERA: 4.91    | 4.0 | L   | 18 | 4 | 3 | 3  | 4  | 2  | 0   | 0   | 0   | 0  | 2  | 24 | 32 | 6.75 | 1.500 |
| Jim Duckworth, R (5, 1)<br>ERA:      | 2.0 |     | 7  | 1 | 0 | 0  | 3  | 1  | 0   | 0   | 0   | 0  | 0  | 12 | 16 | 0.00 | 1.000 |
| Dave Stenhouse, R (7, 1)<br>ERA: 6.0 | 2.0 |     | 7  | 1 | 0 | 0  | 1  | 0  | 0   | 0   | 0   | 0  | 0  | 9  | 9  | 0.00 | 0.500 |

**BOTTOM**

Washington Senators @ Kansas City Athletics  
Municipal Stadium, Kansas City, MO

Sat Apr 25 1964, 7:05 PM EST  
Att. 5,019 - Unknown

|            |           |
|------------|-----------|
| <b>AB</b>  | <b>29</b> |
| <b>R</b>   | <b>3</b>  |
| <b>H</b>   | <b>6</b>  |
| <b>RBI</b> | <b>3</b>  |
| <b>BB</b>  | <b>3</b>  |
| <b>SO</b>  | <b>8</b>  |
| <b>LOB</b> | <b>9</b>  |



| Batter   | 1   | 2                                | 3                            | 4                               | 5                            | 6                               | 7                            | 8                               | 9                                    | AB R H RBI BB SO LOB            | TOP                          |                                  |                              |                                 |                              |                                 |                                  |                                    |                                  |        |
|--|---|----------------------------------|------------------------------|---------------------------------|------------------------------|---------------------------------|------------------------------|---------------------------------|--------------------------------------|---------------------------------|------------------------------|----------------------------------|------------------------------|---------------------------------|------------------------------|---------------------------------|----------------------------------|------------------------------------|----------------------------------|--------|
| Don Zimmer, R (1, 5)<br>OBP: 0.370, SLG: 0.800     | 0-0<br>HR   | 0-0<br>F7                        |                              |                                 | 0-0<br>HR                    |                                 | 4-0<br>SH1-4<br>BB           |                                 | 0-0<br>F9                            | 4 2 2 2 1 0 0                   |                              |                                  |                              |                                 |                              |                                 |                                  |                                    |                                  |        |
| Don Blasingame, L (1, 4)<br>OBP: 0.414, SLG: 0.519 | 0-0<br>1B<br>2B                                       | 0-0<br>F8                        |                              |                                 | 0-0<br>1-3                   |                                 | 0-0<br>SH1-4                 |                                 | 0-0<br>4-3                           | 4 1 1 0 0 0 0                   |                              |                                  |                              |                                 |                              |                                 |                                  |                                    |                                  |        |
| Chuck Hinton, R (1, 7)<br>OBP: 0.348, SLG: 0.571   | 0-3<br>K  |                                  |                              |                                 | 0-3<br>K                     |                                 | 0-0<br>F3                    |                                 | 0-0<br>WP<br>1B                      | 5 0 1 0 0 2 3                   |                              |                                  |                              |                                 |                              |                                 |                                  |                                    |                                  |        |
| Bill Skowron, R (1, 3)<br>OBP: 0.283, SLG: 0.556   | 4-0<br>1B<br>BB                                       |                                  |                              |                                 | 0-0<br>5-3                   |                                 | 0-0<br>HR                    |                                 | 0-0<br>6-3                           | 4 2 1 1 1 0 3                   |                              |                                  |                              |                                 |                              |                                 |                                  |                                    |                                  |        |
| Jim King, L (1, 9)<br>OBP: 0.152, SLG: 0.219       | 0-0<br>FC4-6<br>1B<br>1-3<br>2-H                      |                                  |                              |                                 | 0-0<br>L3                    |                                 | 0-0<br>3-1                   |                                 | 0-0<br>3-1                           | 4 0 1 1 0 0 0                   |                              |                                  |                              |                                 |                              |                                 |                                  |                                    |                                  |        |
| Don Lock, R (1, 8)<br>OBP: 0.390, SLG: 0.313       | 0-0<br>FC4-6<br>1B<br>1-2<br>3-H                      |                                  |                              |                                 | 0-0<br>F8                    |                                 | 0-3<br>K                     |                                 | 0-0<br>BB<br>1B                      | 4 1 2 1 0 1 0                   |                              |                                  |                              |                                 |                              |                                 |                                  |                                    |                                  |        |
| Mike Brumley, L (1, 2)<br>OBP: 0.222, SLG: 0.235   | 0-0<br>FC4-6<br>1-2<br>2-3                            |                                  |                              |                                 | 0-0<br>3-1                   |                                 | 0-0<br>2B                    |                                 | 4-0<br>1B<br>BLK<br>BB               | 3 1 1 0 1 0 2                   |                              |                                  |                              |                                 |                              |                                 |                                  |                                    |                                  |        |
| Ed Brinkman, R (1, 6)<br>OBP: 0.227, SLG: 0.349    | 0-0<br>F9   |                                  |                              |                                 | 0-0<br>F2                    |                                 | 0-0<br>P6                    |                                 | 0-0<br>BLK<br>F9<br>1B<br>1-3<br>2-H | 4 0 1 1 0 0 3                   |                              |                                  |                              |                                 |                              |                                 |                                  |                                    |                                  |        |
| Bennie Daniels, L (1, 1)<br>OBP: 0.333, SLG: 0.200 |   | 0-0<br>F9                        |                              |                                 | 0-0<br>F9                    |                                 | 4-0<br>SH1-4<br>BB           |                                 | 0-0<br>F9<br>2-H<br>3-H              | 3 0 0 0 1 0 1                   |                              |                                  |                              |                                 |                              |                                 |                                  |                                    |                                  |        |
| Ron Kline, R (9, 1)                                |   |                                  |                              |                                 |                              |                                 |                              |                                 |                                      | 0 0 0 0 0 0 0                   |                              |                                  |                              |                                 |                              |                                 |                                  |                                    |                                  |        |
| <b>Inning Stats</b>                                | R: 3<br>E: 0<br>K: 1<br>S: 9                          | H: 4<br>LOB: 2<br>BB: 1<br>P: 13 | R: 0<br>E: 0<br>K: 0<br>S: 3 | H: 0<br>LOB: 0<br>BB: 0<br>P: 3 | R: 0<br>E: 0<br>K: 0<br>S: 3 | H: 0<br>LOB: 0<br>BB: 0<br>P: 3 | R: 1<br>E: 0<br>K: 1<br>S: 6 | H: 1<br>LOB: 0<br>BB: 0<br>P: 6 | R: 1<br>E: 0<br>K: 1<br>S: 7         | H: 2<br>LOB: 1<br>BB: 0<br>P: 7 | R: 0<br>E: 0<br>K: 0<br>S: 3 | H: 0<br>LOB: 2<br>BB: 2<br>P: 11 | R: 2<br>E: 0<br>K: 0<br>S: 4 | H: 2<br>LOB: 0<br>BB: 1<br>P: 8 | R: 0<br>E: 0<br>K: 0<br>S: 4 | H: 1<br>LOB: 1<br>BB: 0<br>P: 4 | 1B: 5<br>2B: 2<br>3B: 0<br>HR: 3 | SF: 0<br>SAC: 1<br>DP: 0<br>HBP: 0 | WP: 1<br>PB: 0<br>SB: 0<br>CS: 0 | PA: 40 |
| <b>PITCHER</b>                                     | IP WLS BF H R ER SO BB IBB HBP BLK WP HR S P ERA WHIP |                                  |                              |                                 |                              |                                 |                              |                                 |                                      |                                 |                              |                                  |                              |                                 |                              |                                 |                                  |                                    |                                  |        |
| Lew Krausse, R (1, 1)<br>ERA: 81.0                 | 0.1 L 6 4 3 3 1 1 0 0 0 0 1 7 11 81.00 15.000         |                                  |                              |                                 |                              |                                 |                              |                                 |                                      |                                 |                              |                                  |                              |                                 |                              |                                 |                                  |                                    |                                  |        |
| Aurelio Monteaugudo, R (1, 1)<br>ERA: 3.18         | 5.2 20 3 2 2 2 0 0 0 0 0 2 24 24 3.18 0.529           |                                  |                              |                                 |                              |                                 |                              |                                 |                                      |                                 |                              |                                  |                              |                                 |                              |                                 |                                  |                                    |                                  |        |
| Dan Pfister, R (7, 1)<br>ERA: 13.5                 | 1.1 9 2 2 2 0 3 0 0 0 0 0 6 18 13.50 3.750            |                                  |                              |                                 |                              |                                 |                              |                                 |                                      |                                 |                              |                                  |                              |                                 |                              |                                 |                                  |                                    |                                  |        |
| Tom Sturdivant, R (8, 1)<br>ERA:                   | 0.2 1 0 0 0 0 0 0 0 0 1 0 0 1 0.00 0.000              |                                  |                              |                                 |                              |                                 |                              |                                 |                                      |                                 |                              |                                  |                              |                                 |                              |                                 |                                  |                                    |                                  |        |
| Vern Handrahan, R (9, 1)<br>ERA: 7.71              | 1.0 4 1 0 0 0 0 0 0 0 0 1 0 4 0.00 1.000              |                                  |                              |                                 |                              |                                 |                              |                                 |                                      |                                 |                              |                                  |                              |                                 |                              |                                 |                                  |                                    |                                  |        |

Washington Senators @ Kansas City Athletics  
Municipal Stadium, Kansas City, MO  
Sun Apr 26 1964, 4:33 AM EDT  
Att. 4,263 - Unknown

livebaseballscorecards.com

|     |    |
|-----|----|
| AB  | 35 |
| R   | 7  |
| H   | 10 |
| RBI | 6  |
| BB  | 4  |
| SO  | 3  |
| LOB | 12 |



| Batter  | 1                            | 2                               | 3                            | 4                               | 5                            | 6                               | 7                            | 8                               | 9                            | AB                              | R                            | H                               | RBI                          | BB                              | SO                           | LOB                             | BOTTOM  |                                  |                                  |                                    |                                  |        |
|---|------------------------------|---------------------------------|------------------------------|---------------------------------|------------------------------|---------------------------------|------------------------------|---------------------------------|------------------------------|---------------------------------|------------------------------|---------------------------------|------------------------------|---------------------------------|------------------------------|---------------------------------|---|----------------------------------|----------------------------------|------------------------------------|----------------------------------|--------|
| <b>Nelson Mathews, R</b><br>OBP: 0.313, SLG: 0.400 (1, 8)     | 0-0<br>F8                    |                                 | 0-0<br>1-3                   |                                 |                              | 0-0<br>1B 2B                    |                              | 0-0<br>P6                       | 0-3<br>K                     | 5                               | 1                            | 1                               | 0                            | 0                               | 1                            | 2                               | <b>Washington Senators @ Kansas City Athletics</b><br><b>Municipal Stadium, Kansas City, MO</b><br>Sun Apr 26 1964, 4:33 AM EDT<br>Att: 4,263 - Unknown |                                  |                                  |                                    |                                  |        |
| <b>Ed Charles, R</b><br>OBP: 0.333, SLG: 0.333 (1, 5)         | 0-0<br>F8                    |                                 |                              | 0-0<br>F7 1B                    |                              | 0-0<br>6-3                      |                              | 0-0<br>G1-6-3 1B                |                              | 4                               | 0                            | 2                               | 0                            | 0                               | 0                            | 1                               |   |                                  |                                  |                                    |                                  |        |
| <b>Wayne Causey, L</b><br>OBP: 0.567, SLG: 0.500 (1, 6)       | 0-0<br>4-3                   |                                 |                              | 0-0<br>F7 1-2                   |                              | 0-0<br>1B 1B                    |                              | 0-0<br>G1-6-3 1-2f              |                              | 4                               | 0                            | 1                               | 1                            | 0                               | 0                            | 2                               |   |                                  |                                  |                                    |                                  |        |
| <b>Jim Gentile, L</b><br>OBP: 0.179, SLG: 0.407 (1, 3)        |                              | 0-0<br>4-3                      |                              | 0-0<br>F9                       |                              | 0-0<br>1-2 1B                   |                              |                                 | 0-0<br>HR                    | 4                               | 1                            | 2                               | 1                            | 0                               | 0                            | 1                               |   |                                  |                                  |                                    |                                  |        |
| <b>Charlie Lau, L</b><br>OBP: 0.300, SLG: 0.333 (1, 2)        |                              | 0-0<br>2B                       |                              | 0-0<br>G3                       |                              | 0-0<br>F8                       |                              |                                 | 0-0<br>F8                    | 4                               | 0                            | 1                               | 0                            | 0                               | 0                            | 3                               |   |                                  |                                  |                                    |                                  |        |
| <b>Rocky Colavito, R</b><br>OBP: 0.444, SLG: 0.619 (1, 9)     |                              | 4-0<br>BB BB<br>G6-4-3 BB       |                              |                                 | 0-0<br>5-3                   |                                 | 0-0<br>F7                    |                                 | 0-0<br>HR                    | 3                               | 1                            | 1                               | 1                            | 1                               | 0                            | 0                               |   |                                  |                                  |                                    |                                  |        |
| <b>Tommie Reynolds, R</b><br>OBP: 0.267, SLG: 0.154 (1, 7)    |                              | 0-0<br>G6-4-3 1-2f              |                              |                                 | 0-0<br>P4                    |                                 | 0-0<br>F7                    |                                 | 0-0<br>BB 1B                 | 4                               | 0                            | 1                               | 0                            | 0                               | 0                            | 2                               |   |                                  |                                  |                                    |                                  |        |
| <b>Dick Green, R</b><br>OBP: 0.120, SLG: 0.240 (1, 4)         |                              |                                 | 0-3<br>K                     |                                 | 0-0<br>L5                    |                                 | 0-3<br>K2-3                  |                                 | 0-0<br>F8                    | 4                               | 0                            | 0                               | 0                            | 0                               | 2                            | 1                               |   |                                  |                                  |                                    |                                  |        |
| <b>Lew Krausse, R</b><br>OBP: 0.667, SLG: 1.333 (6, PH)       |                              |                                 | 0-3<br>K                     |                                 |                              | 0-3<br>K                        |                              | 0-0<br>HR                       | 4-0<br>1-2 BB BB             | 0                               | 0                            | 0                               | 0                            | 0                               | 0                            | 0                               |   |                                  |                                  |                                    |                                  |        |
| <b>Aurelio Montegudo, R</b><br>OBP: 0.667, SLG: 1.333 (6, PH) |                              |                                 |                              |                                 |                              |                                 |                              |                                 |                              | 1                               | 0                            | 0                               | 0                            | 0                               | 0                            | 1                               |   |                                  |                                  |                                    |                                  |        |
| <b>Billy Bryan, L</b><br>OBP: 0.667, SLG: 1.333 (6, PH)       |                              |                                 |                              |                                 |                              |                                 |                              |                                 |                              | 0                               | 0                            | 0                               | 0                            | 0                               | 1                            | 0                               |   |                                  |                                  |                                    |                                  |        |
| <b>Dan Pfister, R</b><br>OBP: 0.667, SLG: 1.333 (7, 1)        |                              |                                 |                              |                                 |                              |                                 |                              |                                 |                              | 0                               | 0                            | 0                               | 0                            | 0                               | 0                            | 0                               |   |                                  |                                  |                                    |                                  |        |
| <b>Tom Sturdivant, L</b><br>OBP: 0.429, SLG: 1.333 (8, PH)    |                              |                                 |                              |                                 |                              |                                 |                              |                                 |                              | 0                               | 0                            | 0                               | 0                            | 0                               | 0                            | 0                               |   |                                  |                                  |                                    |                                  |        |
| <b>Manny Jimenez, L</b><br>OBP: 0.429, SLG: 1.333 (8, PH)     |                              |                                 |                              |                                 |                              |                                 |                              |                                 |                              | 1                               | 1                            | 1                               | 1                            | 0                               | 0                            | 0                               |   |                                  |                                  |                                    |                                  |        |
| <b>Vern Handrahan, L</b><br>OBP: 0.429, SLG: 1.333 (9, 1)     |                              |                                 |                              |                                 |                              |                                 |                              |                                 |                              | 0                               | 0                            | 0                               | 0                            | 0                               | 0                            | 0                               |   |                                  |                                  |                                    |                                  |        |
| <b>George Alusik, R</b><br>OBP: 0.429, SLG: 1.333 (9, PH)     |                              |                                 |                              |                                 |                              |                                 |                              |                                 |                              | 0                               | 0                            | 0                               | 0                            | 1                               | 0                            | 0                               |   |                                  |                                  |                                    |                                  |        |
| <b>Inning Stats</b>   | R: 0<br>E: 0<br>K: 0<br>S: 3 | H: 0<br>LOB: 0<br>BB: 0<br>P: 3 | R: 0<br>E: 0<br>K: 0<br>S: 3 | H: 1<br>LOB: 1<br>BB: 1<br>P: 7 | R: 0<br>E: 0<br>K: 2<br>S: 7 | H: 0<br>LOB: 0<br>BB: 0<br>P: 7 | R: 0<br>E: 0<br>K: 0<br>S: 4 | H: 1<br>LOB: 1<br>BB: 0<br>P: 4 | R: 0<br>E: 0<br>K: 0<br>S: 3 | H: 0<br>LOB: 0<br>BB: 0<br>P: 3 | R: 1<br>E: 0<br>K: 1<br>S: 8 | H: 3<br>LOB: 2<br>BB: 0<br>P: 8 | R: 0<br>E: 0<br>K: 1<br>S: 5 | H: 0<br>LOB: 0<br>BB: 0<br>P: 5 | R: 1<br>E: 0<br>K: 0<br>S: 4 | H: 2<br>LOB: 0<br>BB: 0<br>P: 4 | R: 2<br>E: 0<br>K: 1<br>S: 8  | H: 3<br>LOB: 2<br>BB: 1<br>P: 12 | 1B: 5<br>2B: 2<br>3B: 0<br>HR: 3 | SF: 0<br>SAC: 0<br>DP: 2<br>HBP: 0 | WP: 0<br>PB: 0<br>SB: 0<br>CS: 0 | PA: 37 |
| <b>PITCHER</b>  | IP                           | WLS                             | BF                           | H                               | R                            | ER                              | SO                           | BB                              | IBB                          | HBP                             | BLK                          | WP                              | HR                           | S                               | P                            | ERA                             | WHIP  |                                  |                                  |                                    |                                  |        |
| <b>Bennie Daniels, R</b><br>ERA: 3.86 (1, 1)                  | 8.1                          | W                               | 33                           | 9                               | 4                            | 4                               | 4                            | 1                               | 0                            | 0                               | 0                            | 0                               | 0                            | 40                              | 44                           | 4.32                            | 1.200   |                                  |                                  |                                    |                                  |        |
| <b>Ron Kline, R</b><br>ERA: 1.35 (9, 1)                       | 0.2                          | S                               | 4                            | 1                               | 0                            | 0                               | 1                            | 1                               | 0                            | 0                               | 0                            | 0                               | 0                            | 5                               | 9                            | 0.00                            | 3.000   |                                  |                                  |                                    |                                  |        |

livebaseballscorecards.com

|     |    |
|-----|----|
| AB  | 35 |
| R   | 4  |
| H   | 10 |
| RBI | 4  |
| BB  | 2  |
| SO  | 5  |
| LOB | 12 |



| Batter  | 1   | 2  | 3   | 4   | 5   | 6   | 7   | 8   | 9   | AB R H RBI BB SO LOB  | TOP  |
|---|---|--|---|---|---|---|---|---|---|---|--|
| Bill Bruton, L (1, 7)<br>OBP: 0.261, SLG: 0.381   | 0-0<br>BB S<br>1B                                     | 0-0<br>FC5<br>1-2<br>2-3f                            |   |   | 0-0<br>4-3<br>1B<br>2B                              |   | 0-0<br>F6<br>1                                      |   |   | 4 1 2 0 0 0 2   | <p><b>Detroit Tigers @ Kansas City Athletics</b><br/>Municipal Stadium, Kansas City, MO</p> <p>Tue Apr 28 1964, 8:05 PM EDT<br/>Att. 3,142 - Unknown</p> <p>livebaseballscorecards.com</p> |
| Jerry Lumpe, L (1, 4)<br>OBP: 0.306, SLG: 0.348   | 0-3<br>K<br>1-2                                       | 0-0<br>4-1<br>3                                      |   |   | 0-0<br>4-3<br>2-3                                   |   | 0-0<br>F5<br>2                                      |   |   | 4 0 0 0 0 1 4   |  |
| Norm Cash, L (1, 3)<br>OBP: 0.327, SLG: 0.419   | 0-0<br>L8   |  |   |   | 0-0<br>L8<br>L6-3<br>1B                             |   | 0-0<br>1-3<br>3                                     |   |   | 4 0 1 1 0 0 1   |  |
| Al Kaline, R (1, 9)<br>OBP: 0.383, SLG: 0.194   | 4-0<br>BB<br>BB                                       |  |   |   | 0-0<br>L9<br>L6-3<br>1-2                            |   | 0-0<br>L8<br>1                                      |   |   | 3 0 0 0 1 0 1   |  |
| Don Demeter, R (1, 8)<br>OBP: 0.184, SLG: 0.243   | 4-0<br>BB<br>BB                                       |  |   |   | 0-0<br>F8<br>5-3                                    |   | 0-0<br>F4<br>2                                      |   |   | 3 0 0 0 1 0 1   |  |
| Dick McAuliffe, L (1, 6)<br>OBP: 0.356, SLG: 0.475  | 0-3<br>K<br>3   |  |   |   | 0-0<br>1-3<br>1B                                    |   | 0-0<br>F8<br>3                                      |   |   | 4 0 1 0 0 1 3   |  |
| Don Wert, R (1, 5)<br>OBP: 0.326, SLG: 0.439  |   | 0-0<br>6-3<br>1                                      |   |   | 0-0<br>5-3<br>2                                     |   | 0-0<br>F6<br>1                                      |   |   | 4 0 0 0 0 0 1   |  |
| Bill Freehan, R (1, 2)<br>OBP: 0.500, SLG: 0.650  |   | 4-0<br>FC5 S<br>BB                                   |   |   | 0-0<br>1B   |   | 0-0<br>F8<br>2                                      |   |   | 3 0 1 0 1 0 1   |  |
| Frank Lary, R (1, 1)<br>Ed Rakow, S (5, 1)<br>Gates Brown, L (6, PH)<br>Dick Egan, L (6, 1)<br>Willie Horton, R (9, PH)<br>OBP: 0.281, SLG: 0.286 |   | 4-0<br>FC5<br>BB                                     |   |   | 0-0<br>L8<br>3                                      |   | 0-0<br>F4<br>3                                      |   |   | 1 0 0 0 1 0 1<br>0 0 0 0 0 0 0<br>1 0 0 0 0 0 1<br>0 0 0 0 0 0 0<br>1 0 0 0 0 0 0 |  |
| <b>Inning Stats</b>   | R: 0 H: 1<br>E: 0 LOB: 3<br>K: 2 BB: 2<br>S: 8 P: 16  | R: 0 H: 0<br>E: 0 LOB: 2<br>K: 0 BB: 2<br>S: 3 P: 11 | R: 0 H: 0<br>E: 0 LOB: 0<br>K: 0 BB: 0<br>S: 3 P: 3 | R: 0 H: 1<br>E: 0 LOB: 1<br>K: 0 BB: 0<br>S: 4 P: 4 | R: 1 H: 2<br>E: 0 LOB: 1<br>K: 0 BB: 0<br>S: 5 P: 5 | R: 0 H: 1<br>E: 0 LOB: 1<br>K: 0 BB: 0<br>S: 4 P: 4 | R: 0 H: 0<br>E: 0 LOB: 0<br>K: 0 BB: 0<br>S: 3 P: 3 | R: 0 H: 0<br>E: 0 LOB: 0<br>K: 0 BB: 0<br>S: 3 P: 3 | R: 0 H: 0<br>E: 0 LOB: 0<br>K: 0 BB: 0<br>S: 3 P: 3 | 1B: 4 SF: 0<br>2B: 1 SAC: 0<br>3B: 0 DP: 0<br>HR: 0 HBP: 0                        | WP: 0 PA: 36<br>PB: 0<br>SB: 2<br>CS: 0  |
| <b>PITCHER</b><br>Diego Segui, R (1, 1)<br>ERA: 4.3   | IP WLS BF H R ER SO BB IBB HBP BLK WP HR S P ERA WHIP |  |   |   |   |   |   |   |   |   |  |



| Batter   | 1          | 2         | 3                | 4          | 5          | 6            | 7 | 8          | 9          | AB | R | H | RBI | BB | SO | LOB |
|--|------------|-----------|------------------|------------|------------|--------------|---|------------|------------|----|---|---|-----|----|----|-----|
| Nelson Mathews, R<br>OBP: 0.314, SLG: 0.394<br>(1, 8)  | 0-3<br>K   |           | 0-0<br>SH5-4     |            | 0-0<br>1B  | 0-0<br>L9    |   |            |            | 3  | 1 | 1 | 0   | 0  | 1  | 1   |
| Ed Charles, R<br>OBP: 0.382, SLG: 0.516<br>(1, 5)      | 0-0<br>HR  |           | 0-0<br>2B        |            | 0-0<br>1B  | 0-0<br>FC5-4 |   |            |            | 4  | 2 | 3 | 3   | 0  | 0  | 1   |
| Wayne Causey, L<br>OBP: 0.529, SLG: 0.440<br>(1, 6)    | 0-0<br>L9  |           | 0-0<br>FC6-5-6-2 |            | 0-0<br>F7  |              |   | 4-0<br>BB  |            | 3  | 0 | 0 | 0   | 1  | 0  | 2   |
| Jim Gentile, L<br>OBP: 0.219, SLG: 0.433<br>(1, 3)     | 0-0<br>4-3 |           | 4-0<br>BB        |            | 0-0<br>2B  |              |   | 0-0<br>F5  |            | 3  | 1 | 1 | 1   | 1  | 0  | 1   |
| Charlie Lau, L<br>OBP: 0.214, SLG: 0.231<br>(1, 2)     |            | 0-0<br>F3 | 0-0<br>FC4-6     |            | 0-0<br>F8  |              |   | 0-3<br>K   |            | 4  | 0 | 0 | 0   | 0  | 1  | 4   |
| Rocky Colavito, R<br>OBP: 0.419, SLG: 0.560<br>(1, 9)  |            | 0-0<br>F8 |                  | 0-0<br>F7  | 0-0<br>E5  |              |   | 0-0<br>F7  |            | 4  | 0 | 1 | 0   | 0  | 0  | 1   |
| Tommie Reynolds, R<br>OBP: 0.263, SLG: 0.125<br>(1, 7) |            | 4-0<br>BB |                  | 0-0<br>6-3 | 0-0<br>5-3 |              |   |            | 0-0<br>5-3 | 3  | 0 | 0 | 0   | 1  | 0  | 1   |
| Dick Green, R<br>OBP: 0.172, SLG: 0.250<br>(1, 4)      |            | 0-0<br>L9 |                  | 0-0<br>1B  |            | 4-0<br>BB    |   | 0-0<br>5-3 |            | 3  | 0 | 1 | 0   | 1  | 0  | 1   |
| Diego Segui, R<br>OBP: 0.333, SLG: 0.667<br>(1, 1)     |            |           | 0-0<br>2B        |            | 0-0<br>F8  |              |   | 0-0<br>L9  |            | 4  | 1 | 1 | 0   | 0  | 1  | 2   |

| Inning Stats | R: 1 | H: 1 | E: 0 | K: 1 | S: 6 | LOB: 0 | BB: 0 | P: 6 | R: 0 | H: 0 | E: 0 | K: 0 | S: 3 | LOB: 1 | BB: 1 | P: 7 | R: 1 | H: 2 | E: 0 | K: 0 | S: 5 | LOB: 2 | BB: 1 | P: 9 | R: 0 | H: 1 | E: 0 | K: 0 | S: 4 | LOB: 1 | BB: 0 | P: 4 | R: 3 | H: 4 | E: 1 | K: 0 | S: 7 | LOB: 1 | BB: 0 | P: 7 | R: 0 | H: 0 | E: 0 | K: 1 | S: 5 | LOB: 1 | BB: 1 | P: 9 | R: 0 | H: 0 | E: 0 | K: 1 | S: 5 | LOB: 1 | BB: 1 | P: 9 | R: 0 | H: 0 | E: 0 | K: 0 | S: 3 | LOB: 0 | BB: 0 | P: 3 |
|--------------|------|------|------|------|------|--------|-------|------|------|------|------|------|------|--------|-------|------|------|------|------|------|------|--------|-------|------|------|------|------|------|------|--------|-------|------|------|------|------|------|------|--------|-------|------|------|------|------|------|------|--------|-------|------|------|------|------|------|------|--------|-------|------|------|------|------|------|------|--------|-------|------|
|--------------|------|------|------|------|------|--------|-------|------|------|------|------|------|------|--------|-------|------|------|------|------|------|------|--------|-------|------|------|------|------|------|------|--------|-------|------|------|------|------|------|------|--------|-------|------|------|------|------|------|------|--------|-------|------|------|------|------|------|------|--------|-------|------|------|------|------|------|------|--------|-------|------|

| PITCHER                               | IP  | WLS | BF | H | R | ER | SO | BB | IBB | HBP | BLK | WP | HR | S  | P  | ERA  | WHIP  |
|---------------------------------------|-----|-----|----|---|---|----|----|----|-----|-----|-----|----|----|----|----|------|-------|
| Frank Lary, R<br>ERA: 11.57<br>(1, 1) | 4.1 | L   | 22 | 7 | 5 | 4  | 1  | 2  | 0   | 0   | 0   | 0  | 1  | 22 | 30 | 8.31 | 2.077 |
| Ed Rakow, R<br>ERA:<br>(5, 1)         | 0.2 |     | 3  | 1 | 0 | 0  | 0  | 0  | 0   | 0   | 0   | 0  | 0  | 3  | 3  | 0.00 | 1.500 |
| Dick Egan, L<br>ERA: 0.96<br>(6, 1)   | 3.0 |     | 11 | 0 | 0 | 0  | 2  | 2  | 0   | 0   | 0   | 0  | 0  | 13 | 21 | 0.00 | 0.667 |

**DETROIT TIGERS @ KANSAS CITY ATHLETICS**  
**Municipal Stadium, Kansas City, MO**  
Tue Apr 28 1964, 8:05 PM EDT  
Att. 3,142 - Unknown

|     |    |
|-----|----|
| AB  | 31 |
| R   | 5  |
| H   | 8  |
| RBI | 4  |
| BB  | 4  |
| SO  | 3  |
| LOB | 14 |



| WP | HR | S | P | ERA  | WHIP  |
|----|----|---|---|------|-------|
| 0  | 0  | 0 | 0 | 0.00 | 1.500 |
| 0  | 0  | 2 | 0 | 0.00 | 0.667 |

| Batter  | 1   | 2  | 3   | 4   | 5   | 6  | 7   | 8   | 9   | 10  | AB R H RBI BB SO LOB                                       | TOP   |
|---|---|--|---|---|---|--|---|---|---|---|--|---|
| Don Wert, R (1, 5)<br>OBP: 0.294, SLG: 0.391  | F3  |  | F8  |   | 5-3   |  | 6-3   |   | F4  |   | 5 0 0 0 0 0 0  | <b>Detroit Tigers @ Kansas City Athletics</b><br>Municipal Stadium, Kansas City, MO<br>Wed Apr 29 1964, 8:05 PM EDT<br>Att: 4,489 - Unknown<br><a href="http://livebaseballscorecards.com">livebaseballscorecards.com</a> |
| Jerry Lumpe, L (1, 4)<br>OBP: 0.315, SLG: 0.353   | 4-3   |  | 1B  |   |   | 2B 1B  | 4-3   |   | 3-1   |   | 5 1 2 0 0 0 0  |   |
| Don Demeter, R (1, 8)<br>(10, 9)<br>OBP: 0.209, SLG: 0.357  | L9  |  | 6-3   |   |   | 1B 2B  | F8  |   | HR  |   | 5 2 2 1 0 0 1  |   |
| Al Kaline, R (1, 9)<br>OBP: 0.385, SLG: 0.293<br>Bill Bruton, L (10, 8)<br>OBP: 0.261, SLG: 0.381 | L6-3  |  | HR  |   |   | L5-3   |   | G3 1B   | L5-3  |   | 5 1 2 1 0 0 2<br>0 0 0 0 0 0 0                             |   |
| Willie Horton, R (1, 7)<br>OBP: 0.297, SLG: 0.258   | K   |  | G1-6-3 BB   |   |   | 1B 1B  | 1B  | F7  | F9  |   | 3 1 0 0 2 1 1  |   |
| Norm Cash, L (1, 3)<br>OBP: 0.340, SLG: 0.413   | 1B BB   |  | G1-6-3 BB   |   |   | 1B 1B  | G3  | G3  |   |   | 3 0 1 2 1 0 2  |   |
| Bill Freehan, R (1, 2)<br>OBP: 0.536, SLG: 0.667  | 1B  |  | 6-3   |   |   | FC6-2 1B   | FC6-2   | FC6-2   | 1B  |   | 4 0 3 1 0 0 0  |   |
| Dick McAuliffe, L (1, 6)<br>OBP: 0.327, SLG: 0.432  | F5  |  | 4-3   |   |   | FC6-2 1B   | FC6-2   | FC6-2   | F7  |   | 4 0 0 0 0 0 4  |   |
| Hank Aguirre, R (1, 1)<br>Larry Sherry, R (7, 1)  | 1-3   |  | 6-3   |   |   | L7   |   |   | K   |   | 3 0 0 0 0 0 2<br>1 0 0 0 0 1 0                             |   |
| <b>Inning Stats</b>   | R: 0 H: 0<br>E: 0 LOB: 0<br>K: 0 BB: 0<br>S: 3 P: 3   | R: 0 H: 1<br>E: 0 LOB: 2<br>K: 1 BB: 1<br>S: 6 P: 10 | R: 0 H: 1<br>E: 0 LOB: 1<br>K: 0 BB: 0<br>S: 4 P: 4 | R: 1 H: 1<br>E: 0 LOB: 0<br>K: 0 BB: 1<br>S: 3 P: 7 | R: 0 H: 0<br>E: 0 LOB: 0<br>K: 0 BB: 0<br>S: 3 P: 3 | R: 3 H: 4<br>E: 0 LOB: 2<br>K: 0 BB: 1<br>S: 7 P: 11 | R: 0 H: 0<br>E: 0 LOB: 0<br>K: 0 BB: 0<br>S: 3 P: 3 | R: 0 H: 2<br>E: 0 LOB: 2<br>K: 0 BB: 0<br>S: 4 P: 4 | R: 0 H: 0<br>E: 0 LOB: 0<br>K: 1 BB: 0<br>S: 5 P: 5 | R: 1 H: 1<br>E: 0 LOB: 0<br>K: 0 BB: 0<br>S: 4 P: 4 | 1B: 7 SF: 0<br>2B: 1 SAC: 0<br>3B: 0 DP: 1<br>HR: 2 HBP: 0 |   |
| <b>PITCHER</b>  | IP WLS BF H R ER SO BB IBB HBP BLK WP HR S P ERA WHIP |  |   |   |   |  |   |   |   |   |  |   |
| John O'Donoghue, L (1, 1)<br>ERA: 4.91  | 5.1   |  |   |   |   |  |   |   |   |   |  |   |
| Tom Sturdivant, R (6, 1)<br>ERA:  | 2.2   | 10   | 3   | 0   | 0   | 0  | 0   | 0   | 0   | 0   | 0  | 0.00 1.125  |
| John Wyatt, R (9, 1)<br>ERA: 1.69   | 2.0   | L 7  | 1   | 1   | 1   | 1  | 0   | 0   | 0   | 0   | 0  | 4.50 0.500  |



**BOTTOM**

**Detroit Tigers @ Kansas City Athletics**  
**Municipal Stadium, Kansas City, MO**

Wed Apr 29 1964, 8:05 PM EDT  
 Att. 4,489 - Unknown

[livebaseballscorecards.com](http://livebaseballscorecards.com)

|            |           |
|------------|-----------|
| <b>AB</b>  | <b>37</b> |
| <b>R</b>   | <b>4</b>  |
| <b>H</b>   | <b>8</b>  |
| <b>RBI</b> | <b>3</b>  |
| <b>BB</b>  | <b>6</b>  |
| <b>SO</b>  | <b>5</b>  |
| <b>LOB</b> | <b>16</b> |



| AB | R | H | RBI | BB | SO | LOB |
|----|---|---|-----|----|----|-----|
| 3  | 0 | 0 | 0   | 0  | 1  | 0   |
| 1  | 0 | 0 | 0   | 0  | 0  | 2   |
| 1  | 0 | 0 | 0   | 0  | 0  | 0   |
| 4  | 0 | 1 | 0   | 1  | 0  | 0   |
| 5  | 1 | 2 | 2   | 0  | 0  | 1   |
| 4  | 0 | 0 | 0   | 1  | 0  | 0   |
| 4  | 0 | 0 | 0   | 1  | 0  | 4   |
| 3  | 1 | 2 | 0   | 2  | 0  | 0   |
| 0  | 0 | 0 | 0   | 0  | 0  | 0   |
| 4  | 1 | 1 | 0   | 0  | 1  | 3   |
| 1  | 0 | 0 | 0   | 0  | 1  | 1   |
| 3  | 1 | 1 | 1   | 1  | 1  | 1   |
| 2  | 0 | 0 | 0   | 0  | 1  | 3   |
| 1  | 0 | 1 | 0   | 0  | 0  | 0   |
| 1  | 0 | 0 | 0   | 0  | 0  | 1   |
| 0  | 0 | 0 | 0   | 0  | 0  | 0   |

| Batter  | 1   | 2                       | 3                        | 4                      | 5                        | 6                      | 7                                | 8                        | 9                      | 10                       |                         |                          |                         |                          |                        |                          |                        |   |  |  |  |  |  |  |  |  |  |  |
|---|---|-------------------------|--------------------------|------------------------|--------------------------|------------------------|----------------------------------|--------------------------|------------------------|--------------------------|-------------------------|--------------------------|-------------------------|--------------------------|------------------------|--------------------------|------------------------|---|--|--|--|--|--|--|--|--|--|--|
| Nelson Mathews, R (1, 8)<br>OBP: 0.289, SLG: 0.361<br>Manny Jimenez, L (7, PH)<br>OBP: 0.375, SLG: 1.143<br>Jose Tartabull, L (8, 8)                        | F8  |                         | K                        |                        |                          | L8                     | G3-6-1                           |                          | L8                     |                          |                         |                          |                         |                          |                        |                          |                        |   |  |  |  |  |  |  |  |  |  |  |
| Wayne Causey, L (1, 6)<br>OBP: 0.513, SLG: 0.414  | L7  |                         | G5-4-3<br>1B             |                        |                          | F5                     | BB<br>1B<br>BB                   |                          | L5                     |                          |                         |                          |                         |                          |                        |                          |                        |   |  |  |  |  |  |  |  |  |  |  |
| Ed Charles, R (1, 5)<br>OBP: 0.385, SLG: 0.583  | 5-3   |                         | G5-4-3<br>1-2f           |                        |                          | HR                     | 1-2<br>3-H<br>1B                 |                          | 6-3                    |                          |                         |                          |                         |                          |                        |                          |                        |   |  |  |  |  |  |  |  |  |  |  |
| Rocky Colavito, R (1, 9)<br>OBP: 0.389, SLG: 0.483  |   | F4                      |                          | F6                     |                          | E6<br>FC5-4            | 1-2<br>2-3<br>BB                 |                          | 6-3                    |                          |                         |                          |                         |                          |                        |                          |                        |   |  |  |  |  |  |  |  |  |  |  |
| Doc Edwards, R (1, 2)<br>OBP: 0.316, SLG: 0.294   |   | 2B<br>BB                |                          | L5                     |                          | FC5-4<br>1-2f          | F8                               |                          | 6-3                    |                          |                         |                          |                         |                          |                        |                          |                        |   |  |  |  |  |  |  |  |  |  |  |
| Jim Gentile, L (1, 3)<br>OBP: 0.297, SLG: 0.485<br>George Williams, R (10, PR)  |   | 1-3<br>2B               |                          | 6-3                    |                          |                        | 1B<br>1B<br>BB                   |                          | WP<br>BB               |                          |                         |                          |                         |                          |                        |                          |                        |   |  |  |  |  |  |  |  |  |  |  |
| Tommie Reynolds, R (1, 7)<br>OBP: 0.261, SLG: 0.150<br>Billy Bryan, L (10, PH)<br>OBP: 0.571, SLG: 1.000  |   | F4                      |                          | 4-3                    |                          |                        | 1B<br>1B<br>G3-6-1<br>1B         |                          | K                      |                          |                         |                          |                         |                          |                        |                          |                        |   |  |  |  |  |  |  |  |  |  |  |
| Dick Green, R (1, 4)<br>OBP: 0.212, SLG: 0.258  |   | 4-0<br>IBB              |                          | F3                     |                          |                        | G3-6-1<br>1-2<br>3-H<br>1B<br>1B |                          | K                      |                          |                         |                          |                         |                          |                        |                          |                        |   |  |  |  |  |  |  |  |  |  |  |
| John O'Donoghue, R (1, 1)<br>Tom Sturdivant, L (6, 1)<br>OBP: 1.000, SLG: 1.000<br>Charlie Lau, L (8, PH)<br>OBP: 0.200, SLG: 0.214<br>John Wyatt, R (9, 1) |   | 0-3<br>K                |                          | 5-3                    |                          |                        | 1-2<br>2-3<br>1B                 |                          | L7                     |                          |                         |                          |                         |                          |                        |                          |                        |   |  |  |  |  |  |  |  |  |  |  |
| <b>Inning Stats</b>   | R: 0 H: 0 E: 0 K: 0 S: 3                              | H: 0 LOB: 1 BB: 2 P: 14 | R: 0 H: 1 E: 0 K: 1 S: 5 | H: 1 LOB: 0 BB: 0 P: 5 | R: 0 H: 0 E: 0 K: 0 S: 3 | H: 0 LOB: 0 BB: 0 P: 3 | R: 0 H: 0 E: 0 K: 0 S: 3         | R: 1 H: 1 E: 1 K: 0 S: 5 | H: 1 LOB: 1 BB: 0 P: 5 | R: 3 H: 5 E: 0 K: 0 S: 7 | H: 5 LOB: 3 BB: 2 P: 15 | R: 0 H: 0 E: 0 K: 2 S: 7 | H: 0 LOB: 1 BB: 1 P: 11 | R: 0 H: 0 E: 0 K: 1 S: 3 | H: 0 LOB: 2 BB: 1 P: 9 | R: 0 H: 0 E: 0 K: 1 S: 5 | H: 0 LOB: 2 BB: 1 P: 9 | 1B: 6 SF: 0 2B: 1 SAC: 0 3B: 0 DP: 2 HR: 1 HBP: 0 |  |  |  |  |  |  |  |  |  |  |
| <b>PITCHER</b>  | IP WLS BF H R ER SO BB IBB HBP BLK WP HR S P ERA WHIP |                         |                          |                        |                          |                        |                                  |                          |                        |                          |                         |                          |                         |                          |                        |                          |                        |   |  |  |  |  |  |  |  |  |  |  |
| Hank Aguirre, L (1, 1)<br>ERA: 3.77   | 6.0   | 27                      | 7                        | 4                      | 4                        | 2                      | 1                                | 1                        | 0                      | 0                        | 0                       | 1                        | 29                      | 37                       | 6.00                   | 1.333                    |                        |   |  |  |  |  |  |  |  |  |  |  |
| Larry Sherry, R (7, 1)<br>ERA:  | 4.0   | W                       | 16                       | 1                      | 0                        | 0                      | 3                                | 4                        | 0                      | 0                        | 0                       | 1                        | 0                       | 18                       | 34                     | 0.00                     | 1.250                  |   |  |  |  |  |  |  |  |  |  |  |

|       |        |
|-------|--------|
| WP: 1 | PA: 43 |
| PB: 0 |        |
| SB: 0 |        |
| CS: 0 |        |

| Batter  | 1   | 2   | 3  | 4   | 5   | 6   | 7   | 8   | 9   | AB R H RBI BB SO LOB  | TOP  |  |
|---|---|---|--|---|---|---|---|---|---|---|--|--|
| <b>Bill Bruton, L</b> (1, 8)<br>OBP: 0.286, SLG: 0.385  | 0-3<br>K  |   | 0-0<br>BB<br>1-2<br>3-H<br>1B                                    |   | 0-0<br>4-3  |   | 0-0<br>G3<br>1-2<br>2-3   |   | 0-0<br>1B<br>3-H<br>1B  | 5 0 2 2 0 1 2   |  |  |
| <b>Jerry Lumpe, L</b> (1, 4)<br>OBP: 0.305, SLG: 0.339  | 0-0<br>F5   |   | 0-0<br>L8  |   |   | 0-0<br>F7   | 0-0<br>F7   |   | 0-0<br>1B<br>1-2<br>1B  | 5 0 1 0 0 0 4   |  |  |
| <b>Norm Cash, L</b> (1, 3)<br>OBP: 0.345, SLG: 0.404<br><b>Jake Wood, R</b> (3, 3)<br>OBP: 0.250, SLG: 0.250  | 0-3<br>K  |   | 4-0<br>BB<br>1-2<br>2-3<br>BB                                    |   |   | 0-0<br>FC5-4<br>1B  |   | 0-3<br>K  | 0-0<br>F2   | 1 0 0 0 1 1 0<br>3 0 1 0 0 1 2  |  |  |
| <b>Don Demeter, R</b> (1, 9)<br>OBP: 0.208, SLG: 0.362  |   | 0-0<br>F9   | 0-0<br>F9  |   |   | 0-0<br>L6   |   | 0-0<br>2B   | 0-0<br>L8   | 5 0 1 0 0 0 6   |  |  |
| <b>Willie Horton, R</b> (1, 7)<br>OBP: 0.268, SLG: 0.229  |   | 0-0<br>4-3  |  | 0-0<br>F8   |   | 0-0<br>FC5-4<br>1-2f  |   | 0-0<br>6-3  |   | 4 0 0 0 0 0 2   |  |  |
| <b>Dick McAuliffe, L</b> (1, 6)<br>OBP: 0.340, SLG: 0.447   |   | 0-0<br>F8   |  | 0-0<br>F2   |   |   | 0-0<br>F9<br>1B<br>2B   | 1-0<br>HBP  |   | 3 1 1 0 0 0 0   |  |  |
| <b>Bill Freehan, R</b> (1, 2)<br>OBP: 0.500, SLG: 0.607   |   |   | 0-0<br>FC6-4<br>1B<br>1B   | 0-0<br>5-3  |   |   | 0-0<br>F9<br>2-3  | 0-3<br>K  |   | 4 1 1 0 0 1 3   |  |  |
| <b>Don Wert, R</b> (1, 5)<br>OBP: 0.327, SLG: 0.408   |   |   | 0-0<br>FC6-4<br>1B<br>1B   |   | 0-0<br>F4   |   | 0-0<br>G3<br>1B<br>3-H<br>1B                                    | H<br>1-0<br>1B<br>HBP   |   | 3 1 2 1 0 0 0   |  |  |
| <b>Mickey Lolich, S</b> (1, 1)<br><b>Gates Brown, L</b> (3, PH)<br><b>Ed Rakow, S</b> (3, 1)<br><b>Bubba Phillips, R</b> (7, PH)<br><b>Fred Gladding, L</b> (7, 1)<br><b>Alan Koch, R</b> (8, 1)<br><b>George Thomas, R</b> (9, PH)<br>OBP: 0.667, SLG: 2.000 |   |   | 0-0<br>FC6-4<br>BB<br>1B<br>1-2f<br>2-3                          |   | 0-3<br>K  |   | 0-0<br>G3<br>1B   | 0-0<br>1B   |   | 0 0 0 0 0 0 0<br>1 0 0 0 0 0 2<br>1 0 0 0 0 1 0<br>1 0 1 0 0 0 0<br>0 0 0 0 0 0 0<br>0 0 0 0 0 0 0<br>1 0 1 0 0 0 0 |  |  |
| <b>Inning Stats</b>   | R: 0<br>E: 0<br>K: 2<br>S: 7<br>H: 0<br>LOB: 0<br>BB: 0<br>P: 7 | R: 0<br>E: 0<br>K: 0<br>S: 3<br>H: 0<br>LOB: 0<br>BB: 0<br>P: 3 | R: 1<br>E: 0<br>K: 0<br>S: 6<br>H: 3<br>LOB: 3<br>BB: 1<br>P: 10 | R: 0<br>E: 0<br>K: 0<br>S: 3<br>H: 0<br>LOB: 0<br>BB: 0<br>P: 3 | R: 0<br>E: 0<br>K: 1<br>S: 5<br>H: 0<br>LOB: 0<br>BB: 0<br>P: 5 | R: 0<br>E: 0<br>K: 0<br>S: 4<br>H: 1<br>LOB: 1<br>BB: 0<br>P: 4 | R: 1<br>E: 0<br>K: 0<br>S: 6<br>H: 3<br>LOB: 2<br>BB: 0<br>P: 6 | R: 0<br>E: 0<br>K: 2<br>S: 8<br>H: 1<br>LOB: 2<br>BB: 0<br>P: 9 | R: 1<br>E: 0<br>K: 0<br>S: 5<br>H: 3<br>LOB: 2<br>BB: 0<br>P: 6 | 1B: 9<br>2B: 2<br>3B: 0<br>HR: 0<br>SF: 0<br>SAC: 0<br>DP: 0<br>HBP: 2  | WP: 0<br>PB: 0<br>SB: 0<br>CS: 0<br>PA: 40 |  |
| <b>PITCHER</b><br><b>Orlando Pena, R</b> (1, 1)<br>ERA: 3.07  | IP WLS BF H R ER SO BB IBB HBP BLK WP HR S P ERA WHIP           |   |  |   |   |   |   |   |   |   |  |  |
|   | 9.0 W 40 11 3 3 5 1 0 2 0 0 0 47 53 3.00 1.333                  |   |  |   |   |   |   |   |   |   |  |  |

**Detroit Tigers @ Kansas City Athletics**  
Municipal Stadium, Kansas City, MO  
Thu Apr 30 1964, 4:33 AM EDT  
Att. 3,673 - Unknown

[livebaseballscorecards.com](http://livebaseballscorecards.com)

|     |    |
|-----|----|
| AB  | 37 |
| R   | 3  |
| H   | 11 |
| RBI | 3  |
| BB  | 1  |
| SO  | 5  |
| LOB | 21 |



| Batter   | 1                                   | 2          | 3                        | 4             | 5          | 6          | 7                        | 8          | 9 | AB | R | H | RBI | BB | SO | LOB |
|--|-------------------------------------|------------|--------------------------|---------------|------------|------------|--------------------------|------------|---|----|---|---|-----|----|----|-----|
| Nelson Mathews, R<br>OBP: 0.256, SLG: 0.317<br>(1, 8)  | 0-3<br>K                            | 0-0<br>L6  |                          | 0-0<br>G5-4-3 |            | 0-3<br>K   |                          | 0-0<br>F7  |   | 5  | 0 | 0 | 0   | 0  | 2  | 1   |
| Wayne Causey, L<br>OBP: 0.523, SLG: 0.406<br>(1, 6)    | 4-0<br>BB<br>1B<br>BB               | 0-3<br>K   |                          | 4-0<br>BB     |            |            | 0-0<br>SH2-3<br>HR<br>1B | 0-3<br>K   |   | 3  | 2 | 1 | 0   | 2  | 2  | 0   |
| Ed Charles, R<br>OBP: 0.395, SLG: 0.564<br>(1, 5)      | 4-0<br>1B<br>1-2<br>BB<br>BB        |            | 0-0<br>FC2-5<br>BB<br>1B | 0-3<br>K      |            |            | 0-0<br>SH2-3             | 0-0<br>F2  |   | 3  | 1 | 1 | 0   | 1  | 1  | 1   |
| Rocky Colavito, R<br>OBP: 0.400, SLG: 0.576<br>(1, 9)  | 0-0<br>1B<br>1-3<br>2-H<br>HR<br>1B |            | 0-0<br>L7                |               | 0-0<br>4-3 |            | 0-0<br>HR                |            |   | 4  | 2 | 2 | 3   | 0  | 0  | 1   |
| Jim Gentile, L<br>OBP: 0.341, SLG: 0.583<br>(1, 3)     | 0-3<br>K                            |            | 4-0<br>FC2-5<br>1B<br>BB |               | 0-0<br>HR  |            | 0-0<br>1B<br>1B          |            |   | 3  | 3 | 2 | 1   | 1  | 1  | 2   |
| Doc Edwards, R<br>OBP: 0.348, SLG: 0.333<br>(1, 2)     | 0-0<br>HR<br>1B                     |            | 0-0<br>FC2-5<br>1B       |               | 0-0<br>L6  |            | 0-0<br>1B<br>1B          |            |   | 4  | 1 | 2 | 1   | 0  | 0  | 2   |
| Tommie Reynolds, R<br>OBP: 0.296, SLG: 0.333<br>(1, 7) | 0-0<br>HR                           |            | 0-0<br>1B                |               | 0-0<br>5-3 |            | 0-3<br>K                 |            |   | 4  | 1 | 2 | 4   | 0  | 1  | 2   |
| Dick Green, R<br>OBP: 0.216, SLG: 0.257<br>(1, 4)      | 0-3<br>K                            |            | 0-3<br>K                 |               |            | 0-0<br>5-3 |                          | 0-0<br>1B  |   | 4  | 0 | 1 | 1   | 0  | 2  | 2   |
| Orlando Pena, R<br>(1, 1)                              |                                     | 0-0<br>5-3 |                          | 4-0<br>BB     |            | 0-0<br>6-3 |                          | 0-0<br>6-3 |   | 3  | 0 | 0 | 0   | 1  | 0  | 2   |

| Inning Stats | R: 5 | H: 3 | E: 0 | K: 3 | S: 12 | LOB: 0 | BB: 2 | P: 20 | R: 0 | H: 0 | E: 0 | K: 1 | S: 5 | LOB: 0 | BB: 0 | P: 5 | R: 1 | H: 2 | E: 0 | K: 1 | S: 7 | LOB: 2 | BB: 1 | P: 11 | R: 0 | H: 0 | E: 0 | K: 1 | S: 4 | LOB: 0 | BB: 0 | P: 4 | R: 1 | H: 1 | E: 0 | K: 0 | S: 5 | LOB: 0 | BB: 0 | P: 5 | R: 3 | H: 5 | E: 0 | K: 1 | S: 10 | LOB: 2 | BB: 0 | P: 10 | R: 0 | H: 0 | E: 0 | K: 1 | S: 5 | LOB: 0 | BB: 0 | P: 5 |
|--------------|------|------|------|------|-------|--------|-------|-------|------|------|------|------|------|--------|-------|------|------|------|------|------|------|--------|-------|-------|------|------|------|------|------|--------|-------|------|------|------|------|------|------|--------|-------|------|------|------|------|------|-------|--------|-------|-------|------|------|------|------|------|--------|-------|------|
|--------------|------|------|------|------|-------|--------|-------|-------|------|------|------|------|------|--------|-------|------|------|------|------|------|------|--------|-------|-------|------|------|------|------|------|--------|-------|------|------|------|------|------|------|--------|-------|------|------|------|------|------|-------|--------|-------|-------|------|------|------|------|------|--------|-------|------|

| PITCHER                                 | IP  | WLS | BF | H | R | ER | SO | BB | IBB | HBP | BLK | WP | HR | S  | P  | ERA   | WHIP  |
|---|-----|-----|----|---|---|----|----|----|-----|-----|-----|----|----|----|----|-------|-------|
| Mickey Lolich, L<br>ERA: 3.86<br>(1, 1) | 2.0 | L   | 11 | 3 | 5 | 5  | 4  | 2  | 0   | 0   | 0   | 0  | 1  | 17 | 25 | 22.50 | 2.500 |
| Ed Rakow, R<br>ERA: 3.38<br>(3, 1)      | 4.0 |     | 17 | 3 | 2 | 2  | 3  | 3  | 0   | 0   | 0   | 0  | 1  | 20 | 32 | 4.50  | 1.500 |
| Fred Gladding, R<br>ERA: 12.6<br>(7, 1) | 1.0 |     | 8  | 5 | 3 | 3  | 1  | 0  | 0   | 0   | 0   | 0  | 1  | 10 | 10 | 27.00 | 5.000 |
| Alan Koch, R<br>ERA: 6.75<br>(8, 1)     | 1.0 |     | 3  | 0 | 0 | 0  | 1  | 0  | 0   | 0   | 0   | 0  | 0  | 5  | 5  | 0.00  | 0.000 |

**DETROIT TIGERS @ KANSAS CITY ATHLETICS**  
**Municipal Stadium, Kansas City, MO**  
 Thu Apr 30 1964, 4:33 AM EDT  
 Att. 3,673 - Unknown

|     |    |
|-----|----|
| AB  | 33 |
| R   | 10 |
| H   | 11 |
| RBI | 10 |
| BB  | 5  |
| SO  | 9  |
| LOB | 13 |



|       |        |
|-------|--------|
| WP: 0 | PA: 39 |
| PB: 0 | CS: 0  |
| SB: 0 |        |
| 1B: 8 | SF: 0  |
| 2B: 0 | SAC: 1 |
| 3B: 0 | DP: 1  |
| HR: 3 | HBP: 0 |

| PITCHER | IP | WLS | BF | H | R | ER | SO | BB | IBB | HBP | BLK | WP | HR | S | P | ERA | WHIP |
|---------|----|-----|----|---|---|----|----|----|-----|-----|-----|----|----|---|---|-----|------|
|---------|----|-----|----|---|---|----|----|----|-----|-----|-----|----|----|---|---|-----|------|

| Batter   | 1  | 2   | 3   | 4   | 5   | 6   | 7   | 8  | 9   | AB R H RBI BB SO LOB   |  |
|--|--|---|---|---|---|---|---|--|---|--|--|
| Rich Rollins, R<br>OBP: 0.348, SLG: 0.500<br>(1, 5) X  | 0-0<br>F8  |   | 4-0<br>1B<br>BB   |   |   | 0-0<br>1B<br>HR   | 0-0<br>F8   | 0-0<br>1B<br>1-2<br>2-H<br>3-H                                   |   | 4 1 2 2 1 0 0  |  |
| Tony Oliva, L<br>OBP: 0.403, SLG: 0.597<br>(1, 9) X  | 0-0<br>6-3   |   | 0-0<br>1B   |   |   | 0-0<br>1B<br>HR   |   | BB<br>HBP<br>1B<br>BB<br>4-3                                     |   | 4 2 2 0 1 0 2  |  |
| Bob Allison, R<br>OBP: 0.469, SLG: 0.583<br>(1, 3) BBB   | 4-0<br>BB  |   | 0-0<br>F7   |   |   | 4-0<br>1B<br>HR<br>BB   |   | 1-0<br>BB<br>HBP<br>1B<br>HR                                     |   | 2 3 1 1 2 0 2  |  |
| Jimmie Hall, L<br>OBP: 0.422, SLG: 0.514<br>(1, 8) SSS   | 0-3<br>K   |   |   | 0-0<br>6-3  |   | 0-3<br>K  |   | 4-0<br>1B<br>FC5-2<br>BB<br>1-2<br>2-3                           | 0-0<br>4-3  | 4 0 0 0 1 2 4  |  |
| Harmon Killebrew, R<br>OBP: 0.242, SLG: 0.286<br>Lenny Green, L<br>(9, 7)                                    |  |   | 0-0<br>F7   |   | 0-0<br>F8   | 0-3<br>K  |   | 0-3<br>K<br>1-2<br>2-3<br>3-H                                    | 0-0<br>F9   | 5 0 0 0 0 2 6<br>0 0 0 0 0 0 0   |  |
| Earl Battey, R<br>OBP: 0.370, SLG: 0.436<br>Jerry Zimmerman, R<br>OBP: 0.667, SLG: 0.600<br>(1, 2)<br>(8, 2) |  |   | 0-0<br>5-3  |   | 0-0<br>F8   | 0-0<br>HR<br>1-H<br>2-H<br>3-H                                    |   | FC5-2<br>HBP<br>BB<br>1B<br>1-3<br>2-H<br>3-H                    |   | 4 2 2 6 0 0 0<br>1 0 1 0 0 0 0   |  |
| Zoilo Versalles, R<br>OBP: 0.344, SLG: 0.358<br>(1, 6)   |  |   | 0-0<br>F2   |   |   | 6-3   | 0-0<br>F5   | 1-0<br>BB<br>FC5-2<br>1B<br>HBP<br>1-2                           | 0-0<br>5-3  | 4 1 0 0 0 0 1  |  |
| Bernie Allen, L<br>OBP: 0.328, SLG: 0.404<br>(1, 4)  |  |   | 0-0<br>F9   |   |   | 0-0<br>L6   |   | 0-0<br>FC5-2<br>BB<br>1B<br>1-2<br>2-3<br>3-H                    |   | 4 1 0 0 0 0 3  |  |
| Camilo Pascual, R<br>OBP: 0.333, SLG: 0.300<br>Bill Pleis, L<br>(1, 1)<br>(8, 1)                             |  |   | 0-0<br>1-3  |   |   | 0-0<br>F5   |   | 4-0<br>1B<br>BB<br>1-2<br>2-3<br>3-H                             |   | 3 0 0 1 1 0 0<br>0 0 0 0 0 0 0   |  |
| Inning Stats   | R: 0<br>E: 0<br>K: 1<br>S: 5<br>H: 0<br>LOB: 1<br>BB: 1<br>P: 9  | R: 0<br>E: 0<br>K: 0<br>S: 3<br>H: 0<br>LOB: 0<br>BB: 0<br>P: 3 | R: 0<br>E: 0<br>K: 0<br>S: 4<br>H: 1<br>LOB: 2<br>BB: 1<br>P: 8 | R: 0<br>E: 0<br>K: 0<br>S: 3<br>H: 0<br>LOB: 0<br>BB: 0<br>P: 3 | R: 0<br>E: 0<br>K: 0<br>S: 3<br>H: 0<br>LOB: 0<br>BB: 0<br>P: 3 | R: 4<br>E: 0<br>K: 2<br>S: 10<br>H: 3<br>LOB: 0<br>BB: 1<br>P: 14 | R: 0<br>E: 0<br>K: 0<br>S: 3<br>H: 0<br>LOB: 0<br>BB: 0<br>P: 3 | R: 5<br>E: 0<br>K: 1<br>S: 7<br>H: 2<br>LOB: 2<br>BB: 3<br>P: 21 | R: 1<br>E: 0<br>K: 0<br>S: 5<br>H: 2<br>LOB: 1<br>BB: 0<br>P: 5 | 1B: 6<br>2B: 0<br>3B: 0<br>HR: 2<br>SF: 0<br>SAC: 0<br>DP: 0<br>HBP: 2 | WP: 0<br>PB: 0<br>SB: 0<br>CS: 0<br>PA: 43 |
| PITCHER<br>Moe Drabowsky, R<br>ERA: 3.86<br>(1, 1)   | IP: 7.0<br>WLS: L<br>BF: 29<br>H: 4<br>R: 5<br>ER: 5<br>SO: 3<br>BB: 4<br>IBB: 0<br>HBP: 0<br>BLK: 0<br>WP: 0<br>HR: 1<br>S: 31<br>P: 47<br>ERA: 6.43<br>WHIP: 1.143 |   |   |   |   |   |   |  |   |  |  |
| Tom Sturdivant, R<br>ERA: 9.82<br>(8, 1)   | IP: 0.1<br>WLS: L<br>BF: 5<br>H: 1<br>R: 1<br>ER: 1<br>SO: 1<br>BB: 1<br>IBB: 0<br>HBP: 2<br>BLK: 0<br>WP: 0<br>HR: 0<br>S: 4<br>P: 10<br>ERA: 27.00<br>WHIP: 6.000  |   |   |   |   |   |   |  |   |  |  |
| Ted Bowsfield, L<br>ERA: 4.91<br>(8, 1)  | IP: 1.2<br>WLS: L<br>BF: 9<br>H: 3<br>R: 4<br>ER: 4<br>SO: 0<br>BB: 1<br>IBB: 0<br>HBP: 0<br>BLK: 0<br>WP: 0<br>HR: 1<br>S: 8<br>P: 12<br>ERA: 21.60<br>WHIP: 2.400  |   |   |   |   |   |   |  |   |  |  |

Minnesota Twins @ Kansas City Athletics  
Municipal Stadium, Kansas City, MO  
Fri May 01 1964, 8:05 PM EDT  
Att. 6,047 - Unknown

|     |    |
|-----|----|
| AB  | 35 |
| R   | 10 |
| H   | 8  |
| RBI | 10 |
| BB  | 6  |
| SO  | 4  |
| LOB | 18 |



| Batter  | 1                | 2      | 3      | 4             | 5             | 6      | 7            | 8             | 9      | AB | R | H | RBI | BB | SO | LOB |
|---|------------------|--------|--------|---------------|---------------|--------|--------------|---------------|--------|----|---|---|-----|----|----|-----|
| Nelson Mathews, R<br>OBP: 0.271, SLG: 0.326<br>(1, 8) X | 0-0 SH1-3<br>1B  |        | 0-0 F9 |               | 0-0 F8        |        | 0-0 S<br>1B  |               | 0-3 K  | 5  | 0 | 2 | 0   | 0  | 1  | 1   |
| Ed Charles, R<br>OBP: 0.383, SLG: 0.524<br>(1, 5) X     | 0-0 SH1-3<br>1-2 |        | 0-0 F8 |               | 4-0 BB<br>1B  |        | 0-3 K<br>1-2 |               | 0-3 K  | 3  | 0 | 0 | 0   | 1  | 2  | 2   |
| Wayne Causey, L<br>OBP: 0.490, SLG: 0.378<br>(1, 6) X   | 0-0 F6           |        |        | 0-0 L6        | 0-0 1-2<br>1B |        | 0-0 6-3      |               | 0-0 F8 | 5  | 0 | 1 | 0   | 0  | 0  | 3   |
| Jim Gentile, L<br>OBP: 0.356, SLG: 0.641<br>(1, 3) X    | 0-0 4-3          |        |        | 4-0 HR<br>BB  | 0-0 4-3       |        |              | 0-0 HR        |        | 3  | 2 | 1 | 1   | 1  | 0  | 3   |
| Rocky Colavito, R<br>OBP: 0.386, SLG: 0.622<br>(1, 9)   |                  | 0-0 F8 |        | 0-0 HR<br>1-H |               | 0-0 F8 |              | 0-0 5-3       |        | 4  | 1 | 1 | 2   | 0  | 0  | 0   |
| Charlie Lau, L<br>OBP: 0.316, SLG: 0.500<br>(1, 2)      |                  | 0-0 1B |        | 0-0 F7        |               | 0-0 HR |              | 0-0 WP<br>1B  |        | 4  | 1 | 3 | 1   | 0  | 0  | 0   |
| Tommie Reynolds, R<br>OBP: 0.267, SLG: 0.296<br>(8, PH) |                  | 0-0 F9 |        | 0-3 K         |               | 0-3 K  |              | 0-0 F2<br>1-2 |        | 3  | 0 | 0 | 0   | 0  | 2  | 1   |
| Manny Jimenez, L<br>OBP: 0.333, SLG: 1.000<br>(9, 7)    |                  |        |        |               |               |        |              |               |        | 1  | 0 | 0 | 0   | 0  | 0  | 1   |
| Gino Cimoli, R<br>(9, 7)                                |                  |        |        |               |               |        |              |               |        | 0  | 0 | 0 | 0   | 0  | 0  | 0   |
| Dick Green, R<br>OBP: 0.220, SLG: 0.333<br>(1, 4)       |                  | 0-0 F6 |        |               | 0-0 HR        | 0-3 K  |              | 0-0 F7        |        | 4  | 1 | 1 | 1   | 0  | 1  | 2   |
| Moe Drabowsky, R<br>(1, 1)                              |                  |        | 0-3 K  |               |               | 0-3 K  |              |               | 4-0 BB | 3  | 0 | 0 | 0   | 0  | 3  | 0   |
| Tom Sturdivant, L<br>OBP: 1.000, SLG: 1.000<br>(8, 1)   |                  |        |        |               |               |        |              |               |        | 0  | 0 | 0 | 0   | 0  | 0  | 0   |
| Ted Bowsfield, R<br>(8, 1)                              |                  |        |        |               |               |        |              |               |        | 0  | 0 | 0 | 0   | 0  | 0  | 0   |
| George Alusik, R<br>(9, PH)                             |                  |        |        |               |               |        |              |               |        | 0  | 0 | 0 | 0   | 1  | 0  | 0   |

| Inning Stats | R: 0 | H: 1 | E: 0 | K: 0 | S: 4 | LOB: 1 | BB: 0 | P: 4 | R: 0 | H: 1 | E: 0 | K: 0 | S: 4 | LOB: 1 | BB: 0 | P: 4 | R: 0 | H: 0 | E: 0 | K: 1 | S: 5 | LOB: 0 | BB: 0 | P: 5 | R: 2 | H: 1 | E: 0 | K: 1 | S: 6 | LOB: 0 | BB: 1 | P: 10 | R: 1 | H: 2 | E: 0 | K: 1 | S: 7 | LOB: 2 | BB: 1 | P: 11 | R: 1 | H: 1 | E: 0 | K: 2 | S: 8 | LOB: 0 | BB: 0 | P: 8 | R: 0 | H: 1 | E: 0 | K: 2 | S: 8 | LOB: 1 | BB: 0 | P: 8 | R: 1 | H: 2 | E: 0 | K: 0 | S: 5 | LOB: 1 | BB: 0 | P: 5 | R: 0 | H: 0 | E: 0 | K: 2 | S: 7 | LOB: 1 | BB: 1 | P: 11 | 1B: 5 | SF: 0 | 2B: 0 | SAC: 1 | 3B: 0 | DP: 0 | HR: 4 | HBP: 0 | WP: 1 | PA: 39 |
|--------------|------|------|------|------|------|--------|-------|------|------|------|------|------|------|--------|-------|------|------|------|------|------|------|--------|-------|------|------|------|------|------|------|--------|-------|-------|------|------|------|------|------|--------|-------|-------|------|------|------|------|------|--------|-------|------|------|------|------|------|------|--------|-------|------|------|------|------|------|------|--------|-------|------|------|------|------|------|------|--------|-------|-------|-------|-------|-------|--------|-------|-------|-------|--------|-------|--------|
|--------------|------|------|------|------|------|--------|-------|------|------|------|------|------|------|--------|-------|------|------|------|------|------|------|--------|-------|------|------|------|------|------|------|--------|-------|-------|------|------|------|------|------|--------|-------|-------|------|------|------|------|------|--------|-------|------|------|------|------|------|------|--------|-------|------|------|------|------|------|------|--------|-------|------|------|------|------|------|------|--------|-------|-------|-------|-------|-------|--------|-------|-------|-------|--------|-------|--------|

| PITCHER                                 | IP  | WLS | BF | H | R | ER | SO | BB | IBB | HBP | BLK | WP | HR | S  | P  | ERA  | WHIP  |
|---|-----|-----|----|---|---|----|----|----|-----|-----|-----|----|----|----|----|------|-------|
| Camilo Pascual, R<br>ERA: 5.0<br>(1, 1) | 7.1 | W   | 33 | 9 | 5 | 5  | 7  | 2  | 0   | 0   | 0   | 0  | 4  | 45 | 53 | 6.14 | 1.500 |
| Bill Pleis, L<br>ERA:<br>(8, 1)         | 1.2 | S   | 6  | 0 | 0 | 0  | 2  | 1  | 0   | 0   | 0   | 1  | 0  | 9  | 13 | 0.00 | 0.600 |

BOTTOM

Minnesota Twins @ Kansas City Athletics  
Municipal Stadium, Kansas City, MO  
Fri May 01 1964, 8:05 PM EDT  
Att. 6,047 - Unknown

livebaseballscorecards.com

|     |    |
|-----|----|
| AB  | 35 |
| R   | 5  |
| H   | 9  |
| RBI | 5  |
| BB  | 3  |
| SO  | 9  |
| LOB | 13 |



| Batter   | 1   | 2   | 3   | 4  | 5                            | 6                               | 7                            | 8                               | 9                            | 10                              | 11                           | AB R H RBI BB SO LOB   | TOP  |                              |                                 |                              |                                 |                              |                                 |                                  |                                    |                                  |        |
|--|---|---|---|--|------------------------------|---------------------------------|------------------------------|---------------------------------|------------------------------|---------------------------------|------------------------------|--|--|------------------------------|---------------------------------|------------------------------|---------------------------------|------------------------------|---------------------------------|----------------------------------|------------------------------------|----------------------------------|--------|
| Rich Rollins, R<br>OBP: 0.338, SLG: 0.478<br>(1, 5)  | F3  |   | HR<br>1B  |  | K                            |                                 |                              | 6-3                             |                              | F8                              |                              | 5 1 1 0 0 1 0  | <b>Minnesota Twins @ Kansas City Athletics</b><br>Municipal Stadium, Kansas City, MO<br>Sat May 02 1964, 4:33 AM EDT<br>Att: 8,159 - Unknown |                              |                                 |                              |                                 |                              |                                 |                                  |                                    |                                  |        |
| Tony Oliva, L<br>OBP: 0.431, SLG: 0.716<br>(1, 9)  | L6  |   | HR  |  |                              |                                 | 3-4<br>2B                    | 1B                              |                              | HR                              |                              | 5 2 4 3 0 0 0  |  |                              |                                 |                              |                                 |                              |                                 |                                  |                                    |                                  |        |
| Bob Allison, R<br>OBP: 0.444, SLG: 0.610<br>(1, 3)   | F8  |   | 1-3   |  |                              |                                 | F9                           | K2-3                            |                              | HR                              |                              | 5 1 1 1 0 1 2  |  |                              |                                 |                              |                                 |                              |                                 |                                  |                                    |                                  |        |
| Jimmie Hall, L<br>OBP: 0.400, SLG: 0.548<br>(1, 8)   |   | F7  |   |  |                              |                                 | 3-4                          |                                 | 4-3                          | HR                              |                              | 5 1 1 1 0 0 1  |  |                              |                                 |                              |                                 |                              |                                 |                                  |                                    |                                  |        |
| Harmon Killebrew, R<br>OBP: 0.254, SLG: 0.393<br>Lenny Green, L<br>(11, 7)   |   | 6-3   |   |  |                              |                                 | F4                           |                                 | HR                           | HR                              |                              | 5 2 2 2 0 0 1<br>0 0 0 0 0 0 0   |  |                              |                                 |                              |                                 |                              |                                 |                                  |                                    |                                  |        |
| Earl Battey, R<br>OBP: 0.373, SLG: 0.455<br>(1, 2)   |   |   |   |  |                              |                                 |                              | F4                              | K                            | K                               |                              | 5 0 2 0 0 2 0  |  |                              |                                 |                              |                                 |                              |                                 |                                  |                                    |                                  |        |
| Zoilo Versalles, R<br>OBP: 0.318, SLG: 0.328<br>(1, 6)   |   | F3  |   |  |                              |                                 | F4                           |                                 | 6-3                          | F2                              |                              | 5 0 0 0 0 0 2  |  |                              |                                 |                              |                                 |                              |                                 |                                  |                                    |                                  |        |
| Bernie Allen, L<br>OBP: 0.317, SLG: 0.373<br>(1, 4)  |   |   | B1-6-4<br>BB  |  |                              |                                 | F4                           | F8                              |                              | 4-3                             | G3                           | 4 0 0 0 1 0 0  |  |                              |                                 |                              |                                 |                              |                                 |                                  |                                    |                                  |        |
| Lee Stange, R<br>OBP: 0.222, SLG: 0.125<br>Bill Dalley, R<br>Bill Fischer, R<br>Bill Pleis, L<br>Don Mincher, L<br>Gerry Arrigo, L |   |   | B1-6-4  |  |                              |                                 | K                            |                                 |                              | F2                              |                              | 3 0 0 0 0 2 1<br>0 0 0 0 0 0 0<br>0 0 0 0 0 0 0<br>0 0 0 0 0 0 0<br>1 0 0 0 0 0 0<br>0 0 0 0 0 0 0 |  |                              |                                 |                              |                                 |                              |                                 |                                  |                                    |                                  |        |
| <b>Inning Stats</b>  | R: 0<br>E: 0<br>K: 0<br>S: 3                          | H: 0<br>LOB: 0<br>BB: 0<br>P: 3                   | R: 0<br>E: 0<br>K: 0<br>S: 4                        | H: 1<br>LOB: 1<br>BB: 0<br>P: 4                  | R: 2<br>E: 0<br>K: 0<br>S: 4 | H: 2<br>LOB: 0<br>BB: 1<br>P: 8 | R: 0<br>E: 0<br>K: 0<br>S: 4 | H: 1<br>LOB: 1<br>BB: 0<br>P: 4 | R: 0<br>E: 0<br>K: 0<br>S: 7 | H: 0<br>LOB: 0<br>BB: 0<br>P: 7 | R: 0<br>E: 0<br>K: 2<br>S: 8 | H: 1<br>LOB: 1<br>BB: 0<br>P: 8  |  | R: 1<br>E: 0<br>K: 1<br>S: 6 | H: 1<br>LOB: 0<br>BB: 0<br>P: 6 | R: 0<br>E: 0<br>K: 0<br>S: 3 | H: 0<br>LOB: 0<br>BB: 0<br>P: 3 | R: 4<br>E: 0<br>K: 1<br>S: 9 | H: 4<br>LOB: 0<br>BB: 0<br>P: 9 | 1B: 3<br>2B: 2<br>3B: 0<br>HR: 6 | SF: 0<br>SAC: 0<br>DP: 1<br>HBP: 0 | WP: 0<br>PB: 0<br>SB: 0<br>CS: 0 | PA: 44 |
| <b>PITCHER</b>   | IP WLS BF H R ER SO BB IBB HBP BLK WP HR S P ERA WHIP |   |   |  |                              |                                 |                              |                                 |                              |                                 |                              |  |  |                              |                                 |                              |                                 |                              |                                 |                                  |                                    |                                  |        |
| Aurelio Montegudo, R<br>ERA: 2.84<br>John Wyatt, R<br>ERA: 2.45<br>Dan Pfister, R<br>ERA: 19.29<br>Vern Handrahan, R<br>ERA: 8.1   | (1, 1) 7.0 26 5 2 2 2 1 0 0 0 0 1 29 33 2.57 0.857    | (8, 1) 2.0 8 2 1 1 3 0 0 0 0 0 1 14 14 4.50 1.000 | (10, 1) 1.0 L 6 3 3 3 0 0 0 0 0 0 3 6 6 27.00 3.000 | (11, 1) 1.0 4 1 1 1 1 0 0 0 0 0 1 6 6 9.00 1.000 |                              |                                 |                              |                                 |                              |                                 |                              |  |  |                              |                                 |                              |                                 |                              |                                 |                                  |                                    |                                  |        |

|     |    |
|-----|----|
| AB  | 43 |
| R   | 7  |
| H   | 11 |
| RBI | 7  |
| BB  | 1  |
| SO  | 6  |
| LOB | 7  |





| Batter   | 1          | 2         | 3                     | 4          | 5                     | 6         | 7               | 8                  | 9                      | 10         | 11                 | AB | R | H | RBI | BB | SO | LOB |
|--|------------|-----------|-----------------------|------------|-----------------------|-----------|-----------------|--------------------|------------------------|------------|--------------------|----|---|---|-----|----|----|-----|
| Nelson Mathews, R<br>OBP: 0.245, SLG: 0.294<br>(1, 8)  | 0-0<br>1-3 |           |                       | 0-3<br>K   |                       | 0-3<br>K  |                 | 0-0<br>FC6-4       |                        | 0-3<br>K   |                    | 5  | 0 | 0 | 0   | 0  | 3  | 2   |
| Wayne Causey, L<br>OBP: 0.444, SLG: 0.333<br>(1, 6)  | 0-0<br>F7  |           |                       | 0-0<br>6-3 |                       |           | 0-0<br>F9       | 0-0<br>F7          |                        | 0-0<br>1-3 |                    | 5  | 0 | 0 | 0   | 0  | 0  | 1   |
| Ed Charles, R<br>OBP: 0.404, SLG: 0.553<br>(1, 5)  | 0-0<br>F6  |           |                       | 0-0<br>5-3 |                       |           | 0-0<br>3B<br>1B |                    | 0-0<br>4-3<br>1B<br>2B | 0-0<br>1B  |                    | 5  | 2 | 3 | 0   | 0  | 0  | 0   |
| Jim Gentile, L<br>OBP: 0.354, SLG: 0.610<br>Doc Edwards, R<br>OBP: 0.320, SLG: 0.304<br>(1, 3)<br>(8, 3)   |            | 0-0<br>F6 |                       |            | 4-0<br>G5-4-3<br>BB   |           | 0-3<br>K<br>1-2 |                    | 0-0<br>4-3             | 0-0<br>F4  |                    | 2  | 0 | 0 | 0   | 1  | 1  | 1   |
| Rocky Colavito, R<br>OBP: 0.388, SLG: 0.585<br>(1, 9)<br>(8, 7)  |            | 0-0<br>F6 |                       |            | 0-0<br>G5-4-3<br>1-2f |           | 4-0<br>3B<br>BB |                    | 0-0<br>1-3<br>PB<br>1B |            | 0-0<br>F9          | 4  | 1 | 1 | 1   | 1  | 0  | 1   |
| Charlie Lau, L<br>OBP: 0.375, SLG: 0.591<br>(1, 2)   |            | 0-0<br>F7 |                       |            | 0-0<br>1-3            |           | 0-0<br>3B       |                    | 0-0<br>1-3<br>IBB      |            | 0-0<br>FC6-4<br>1B | 4  | 0 | 2 | 2   | 1  | 0  | 0   |
| Tommie Reynolds, R<br>OBP: 0.281, SLG: 0.310<br>Manny Jimenez, L<br>OBP: 0.300, SLG: 0.889<br>Gino Cimoli, R<br>Jose Tartabull, L<br>(1, 7)<br>(7, PH)<br>(8, 9)<br>(11, 9)                              |            |           | 0-0<br>G4-6-3<br>1B   |            |                       | 0-0<br>F3 | 0-0<br>6-3      |                    | 0-0<br>1-3             |            | 0-3<br>K           | 2  | 0 | 1 | 0   | 0  | 0  | 0   |
| Dick Green, R<br>OBP: 0.205, SLG: 0.310<br>George Alusik, R<br>George Williams, R<br>(1, 4)<br>(9, PH)<br>(9, PR)<br>(10, 4)   |            |           | 0-0<br>G4-6-3<br>1-2f |            |                       | 0-0<br>F8 |                 | 0-0<br>F4          | 4-0<br>IBB             |            | 0-0<br>FC6-4       | 3  | 0 | 0 | 0   | 0  | 0  | 1   |
| Aurelio Monteagudo, R<br>OBP: 0.333, SLG: 0.333<br>John Wyatt, R<br>Billy Bryan, L<br>OBP: 0.500, SLG: 0.800<br>Dan Pfister, R<br>Vern Handrahan, L<br>(1, 1)<br>(8, 1)<br>(9, PH)<br>(10, 1)<br>(11, 1) |            |           | 0-3<br>K              |            |                       | 0-0<br>1B |                 | 4-0<br>FC6-4<br>BB | 0-3<br>K               |            |                    | 2  | 0 | 1 | 0   | 0  | 1  | 0   |

| BOTTOM   |  |    |    |   |   |   |   |     |   |    |   |    |   |     |    |
|--|--|----|----|---|---|---|---|-----|---|----|---|----|---|-----|----|
| <b>Minnesota Twins @ Kansas City Athletics</b><br>Municipal Stadium, Kansas City, MO<br>Sat May 02 1964, 4:33 AM EDT<br>Att: 8,159 - Unknown | <table border="0"> <tr><td>AB</td><td>39</td></tr> <tr><td>R</td><td>3</td></tr> <tr><td>H</td><td>8</td></tr> <tr><td>RBI</td><td>3</td></tr> <tr><td>BB</td><td>5</td></tr> <tr><td>SO</td><td>7</td></tr> <tr><td>LOB</td><td>16</td></tr> </table>  | AB | 39 | R | 3 | H | 8 | RBI | 3 | BB | 5 | SO | 7 | LOB | 16 |
| AB   | 39   |    |    |   |   |   |   |     |   |    |   |    |   |     |    |
| R  | 3  |    |    |   |   |   |   |     |   |    |   |    |   |     |    |
| H  | 8  |    |    |   |   |   |   |     |   |    |   |    |   |     |    |
| RBI  | 3  |    |    |   |   |   |   |     |   |    |   |    |   |     |    |
| BB   | 5  |    |    |   |   |   |   |     |   |    |   |    |   |     |    |
| SO   | 7  |    |    |   |   |   |   |     |   |    |   |    |   |     |    |
| LOB  | 16   |    |    |   |   |   |   |     |   |    |   |    |   |     |    |

| Inning Stats  | R: 0 | H: 0 | E: 0 | K: 0 | S: 3 | R: 0 | H: 0 | E: 0 | K: 0 | S: 3 | R: 0 | H: 1 | E: 0 | K: 1 | S: 5 | R: 0 | H: 0  | E: 0 | K: 1 | S: 5 | R: 0 | H: 0 | E: 0 | K: 0 | S: 2 | R: 0 | H: 1 | E: 0 | K: 1 | S: 6 | R: 2 | H: 2 | E: 0 | K: 1 | S: 7 | R: 0 | H: 0 | E: 0 | K: 0 | S: 3 | R: 1 | H: 2 | E: 0 | K: 1 | S: 7 | R: 0 | H: 1 | E: 0 | K: 1 | S: 6 | R: 0 | H: 1 | E: 0 | K: 1 | S: 6 |
|---|------|------|------|------|------|------|------|------|------|------|------|------|------|------|------|------|-------|------|------|------|------|------|------|------|------|------|------|------|------|------|------|------|------|------|------|------|------|------|------|------|------|------|------|------|------|------|------|------|------|------|------|------|------|------|------|
| <b>Lee Stange, R</b><br>ERA: 3.97<br><b>Bill Dailey, R</b><br>ERA: 5.0<br><b>Bill Fischer, R</b><br>ERA: 2.7<br><b>Bill Pleis, L</b><br>ERA:<br><b>Gerry Arrigo, L</b><br>ERA: 3.38 | IP   | WLS  | BF   | H    | R    | ER   | SO   | BB   | IBB  | HBP  | BLK  | WP   | HR   | S    | P    | ERA  | WHIP  |      |      |      |      |      |      |      |      |      |      |      |      |      |      |      |      |      |      |      |      |      |      |      |      |      |      |      |      |      |      |      |      |      |      |      |      |      |      |
|   | 8.0  |      | 30   | 5    | 3    | 3    | 4    | 3    | 0    | 0    | 0    | 0    | 0    | 35   | 47   | 3.38 | 1.000 |      |      |      |      |      |      |      |      |      |      |      |      |      |      |      |      |      |      |      |      |      |      |      |      |      |      |      |      |      |      |      |      |      |      |      |      |      |      |
|   | 0.1  |      | 2    | 1    | 0    | 0    | 0    | 0    | 0    | 0    | 0    | 0    | 0    | 2    | 2    | 0.00 | 3.000 |      |      |      |      |      |      |      |      |      |      |      |      |      |      |      |      |      |      |      |      |      |      |      |      |      |      |      |      |      |      |      |      |      |      |      |      |      |      |
|   | 0.1  |      | 3    | 0    | 0    | 0    | 0    | 0    | 2    | 0    | 0    | 0    | 0    | 1    | 9    | 0.00 | 0.000 |      |      |      |      |      |      |      |      |      |      |      |      |      |      |      |      |      |      |      |      |      |      |      |      |      |      |      |      |      |      |      |      |      |      |      |      |      |      |
|   | 0.1  |      | 1    | 0    | 0    | 0    | 1    | 0    | 0    | 0    | 0    | 0    | 0    | 3    | 3    | 0.00 | 0.000 |      |      |      |      |      |      |      |      |      |      |      |      |      |      |      |      |      |      |      |      |      |      |      |      |      |      |      |      |      |      |      |      |      |      |      |      |      |      |
|   | 2.0  | W    | 8    | 2    | 0    | 0    | 2    | 0    | 0    | 0    | 0    | 0    | 0    | 12   | 12   | 0.00 | 1.000 |      |      |      |      |      |      |      |      |      |      |      |      |      |      |      |      |      |      |      |      |      |      |      |      |      |      |      |      |      |      |      |      |      |      |      |      |      |      |

| BOTTOM  |  |     |   |     |    |     |   |     |   |     |   |
|---|--|-----|---|-----|----|-----|---|-----|---|-----|---|
| <b>Lee Stange, R</b><br>ERA: 3.97<br><b>Bill Dailey, R</b><br>ERA: 5.0<br><b>Bill Fischer, R</b><br>ERA: 2.7<br><b>Bill Pleis, L</b><br>ERA:<br><b>Gerry Arrigo, L</b><br>ERA: 3.38 | <table border="0"> <tr><td>WP:</td><td>0</td></tr> <tr><td>PA:</td><td>44</td></tr> <tr><td>PB:</td><td>1</td></tr> <tr><td>SB:</td><td>1</td></tr> <tr><td>CS:</td><td>0</td></tr> </table> | WP: | 0 | PA: | 44 | PB: | 1 | SB: | 1 | CS: | 0 |
| WP:   | 0  |     |   |     |    |     |   |     |   |     |   |
| PA:   | 44   |     |   |     |    |     |   |     |   |     |   |
| PB:   | 1  |     |   |     |    |     |   |     |   |     |   |
| SB:   | 1  |     |   |     |    |     |   |     |   |     |   |
| CS:   | 0  |     |   |     |    |     |   |     |   |     |   |

| Batter   | 1   | 2                               | 3                                | 4                                | 5                            | 6                                | 7                             | 8                                | 9                            | AB R H RBI BB SO LOB            | TOP                          |                                 |                              |                                  |                              |                                 |                              |                                 |                                  |                                    |                                  |        |  |  |  |  |  |
|--|---|---------------------------------|----------------------------------|----------------------------------|------------------------------|----------------------------------|-------------------------------|----------------------------------|------------------------------|---------------------------------|------------------------------|---------------------------------|------------------------------|----------------------------------|------------------------------|---------------------------------|------------------------------|---------------------------------|----------------------------------|------------------------------------|----------------------------------|--------|--|--|--|--|--|
| Rich Rollins, R (1, 5)<br>OBP: 0.342, SLG: 0.507     | 0-0<br>5-3  |                                 | 4-0<br>1B<br>FC1-2<br>BB         |                                  | 0-0<br>6-3                   |                                  | 0-0<br>HR                     |                                  | 0-0<br>F9                    | 4 1 1 1 1 0 0                   |                              |                                 |                              |                                  |                              |                                 |                              |                                 |                                  |                                    |                                  |        |  |  |  |  |  |
| Tony Oliva, L (1, 9)<br>OBP: 0.416, SLG: 0.681       | 0-3<br>K  |                                 | 0-0<br>FC1-2<br>1-3<br>S<br>1B   |                                  | 0-0<br>4-3                   |                                  | 0-0<br>4-3                    |                                  | 0-0<br>F7                    | 5 0 1 0 0 1 0                   |                              |                                 |                              |                                  |                              |                                 |                              |                                 |                                  |                                    |                                  |        |  |  |  |  |  |
| Bob Allison, R (1, 3)<br>OBP: 0.441, SLG: 0.600      | 0-3<br>K  |                                 | 4-0<br>FC5<br>FC1-2<br>1-2<br>BB |                                  | 0-0<br>2B                    |                                  | 0-3<br>K                      |                                  | 0-0<br>F8                    | 4 0 1 0 1 2 0                   |                              |                                 |                              |                                  |                              |                                 |                              |                                 |                                  |                                    |                                  |        |  |  |  |  |  |
| Jimmie Hall, L (1, 8)<br>OBP: 0.407, SLG: 0.609      |   | 0-0<br>HR                       | 0-0<br>FC1-2                     |                                  | 0-3<br>K                     |                                  | 0-0<br>BB<br>1B               |                                  |                              | 4 1 2 1 0 1 4                   |                              |                                 |                              |                                  |                              |                                 |                              |                                 |                                  |                                    |                                  |        |  |  |  |  |  |
| Harmon Killebrew, R (1, 7)<br>OBP: 0.268, SLG: 0.381 |   | 0-0<br>5-3                      | 0-0<br>FC5<br>2-3f               |                                  |                              | 4-0<br>BB                        | 4-0<br>1-2<br>BB              |                                  |                              | 2 0 0 0 2 0 3                   |                              |                                 |                              |                                  |                              |                                 |                              |                                 |                                  |                                    |                                  |        |  |  |  |  |  |
| Earl Battey, R (1, 2)<br>OBP: 0.370, SLG: 0.511      |   | 0-3<br>K                        |                                  | 0-0<br>HR                        |                              | 0-0<br>F8                        | 0-0<br>L4                     |                                  |                              | 3 1 1 1 0 1 1                   |                              |                                 |                              |                                  |                              |                                 |                              |                                 |                                  |                                    |                                  |        |  |  |  |  |  |
| Don Mincher, L (7, PH)<br>OBP: 0.360, SLG: 0.455     |   |                                 |                                  |                                  |                              |                                  |                               |                                  |                              | 0 0 0 0 0 0 0                   |                              |                                 |                              |                                  |                              |                                 |                              |                                 |                                  |                                    |                                  |        |  |  |  |  |  |
| Vic Power, R (7, PH)<br>OBP: 0.143, SLG: 0.150       |   |                                 |                                  |                                  |                              |                                  |                               |                                  |                              | 1 0 0 0 0 0 2                   |                              |                                 |                              |                                  |                              |                                 |                              |                                 |                                  |                                    |                                  |        |  |  |  |  |  |
| Jerry Zimmerman, R (7, 2)<br>OBP: 0.667, SLG: 0.600  |   |                                 |                                  |                                  |                              |                                  |                               |                                  |                              | 0 0 0 0 0 0 0                   |                              |                                 |                              |                                  |                              |                                 |                              |                                 |                                  |                                    |                                  |        |  |  |  |  |  |
| Zoilo Versalles, R (1, 6)<br>OBP: 0.314, SLG: 0.311  |   | 4-0<br>S<br>BB                  |                                  | 0-3<br>K                         |                              | 0-0<br>F8                        |                               | 0-0<br>G3                        |                              | 3 0 0 0 1 1 1                   |                              |                                 |                              |                                  |                              |                                 |                              |                                 |                                  |                                    |                                  |        |  |  |  |  |  |
| Bernie Allen, L (1, 4)<br>OBP: 0.299, SLG: 0.345     |   | 0-0<br>F8<br>1-2                |                                  | 0-3<br>K                         |                              | 0-0<br>F7                        |                               | 0-0<br>F9                        |                              | 4 0 0 0 0 1 2                   |                              |                                 |                              |                                  |                              |                                 |                              |                                 |                                  |                                    |                                  |        |  |  |  |  |  |
| Jim Kaat, L (1, 1)<br>OBP: 0.182, SLG: 0.455         |   |                                 | 0-3<br>K                         |                                  | 0-3<br>K                     |                                  | 0-0<br>HR                     |                                  | 0-3<br>K                     | 3 1 1 1 0 2 0                   |                              |                                 |                              |                                  |                              |                                 |                              |                                 |                                  |                                    |                                  |        |  |  |  |  |  |
| Bill Fischer, R (7, 1)                               |   |                                 |                                  |                                  |                              |                                  |                               |                                  |                              | 0 0 0 0 0 0 0                   |                              |                                 |                              |                                  |                              |                                 |                              |                                 |                                  |                                    |                                  |        |  |  |  |  |  |
| Lenny Green, L (8, PH)                               |   |                                 |                                  |                                  |                              |                                  |                               |                                  |                              | 1 0 0 0 0 1 0                   |                              |                                 |                              |                                  |                              |                                 |                              |                                 |                                  |                                    |                                  |        |  |  |  |  |  |
| Dwight Siebler, R (8, 1)                             |   |                                 |                                  |                                  |                              |                                  |                               |                                  |                              | 0 0 0 0 0 0 0                   |                              |                                 |                              |                                  |                              |                                 |                              |                                 |                                  |                                    |                                  |        |  |  |  |  |  |
| <b>Inning Stats</b>                                  | R: 0<br>E: 0<br>K: 2<br>S: 7                          | H: 0<br>LOB: 0<br>BB: 0<br>P: 7 | R: 1<br>E: 0<br>K: 1<br>S: 6     | H: 1<br>LOB: 1<br>BB: 1<br>P: 10 | R: 0<br>E: 0<br>K: 1<br>S: 6 | H: 1<br>LOB: 3<br>BB: 2<br>P: 14 | R: 1<br>E: 0<br>K: 3<br>S: 10 | H: 1<br>LOB: 0<br>BB: 0<br>P: 10 | R: 0<br>E: 0<br>K: 1<br>S: 6 | H: 1<br>LOB: 1<br>BB: 0<br>P: 6 | R: 0<br>E: 0<br>K: 0<br>S: 3 | H: 0<br>LOB: 1<br>BB: 1<br>P: 7 | R: 2<br>E: 0<br>K: 1<br>S: 8 | H: 3<br>LOB: 2<br>BB: 1<br>P: 12 | R: 0<br>E: 0<br>K: 1<br>S: 5 | H: 0<br>LOB: 0<br>BB: 0<br>P: 5 | R: 0<br>E: 0<br>K: 0<br>S: 3 | H: 0<br>LOB: 0<br>BB: 0<br>P: 3 | 1B: 2<br>2B: 1<br>3B: 0<br>HR: 4 | SF: 0<br>SAC: 0<br>DP: 0<br>HBP: 0 | WP: 0<br>PB: 0<br>SB: 2<br>CS: 0 | PA: 39 |  |  |  |  |  |
| <b>PITCHER</b>                                       | IP WLS BF H R ER SO BB IBB HBP BLK WP HR S P ERA WHIP |                                 |                                  |                                  |                              |                                  |                               |                                  |                              |                                 |                              |                                 |                              |                                  |                              |                                 |                              |                                 |                                  |                                    |                                  |        |  |  |  |  |  |
| Diego Segui, R (1, 1)<br>ERA: 4.55                   | 6.2   |                                 | 32                               | 7                                | 4                            | 4                                | 9                             | 5                                | 0                            | 0                               | 0                            | 0                               | 4                            | 45                               | 65                           | 5.40                            | 1.800                        |                                 |                                  |                                    |                                  |        |  |  |  |  |  |
| Ted Bowsfield, L (7, 1)<br>ERA: 4.5                  | 0.1   |                                 | 1                                | 0                                | 0                            | 0                                | 0                             | 0                                | 0                            | 0                               | 0                            | 0                               | 0                            | 1                                | 1                            | 0.00                            | 0.000                        |                                 |                                  |                                    |                                  |        |  |  |  |  |  |
| John Wyatt, R (8, 1)<br>ERA: 1.93                    | 2.0   | W                               | 6                                | 0                                | 0                            | 0                                | 1                             | 0                                | 0                            | 0                               | 0                            | 0                               | 0                            | 8                                | 8                            | 0.00                            | 0.000                        |                                 |                                  |                                    |                                  |        |  |  |  |  |  |

Minnesota Twins @ Kansas City Athletics  
Municipal Stadium, Kansas City, MO  
Sun May 03 1964, 4:33 AM EDT  
Unknown

|     |    |
|-----|----|
| AB  | 34 |
| R   | 4  |
| H   | 7  |
| RBI | 4  |
| BB  | 5  |
| SO  | 10 |
| LOB | 13 |



|       |        |
|-------|--------|
| WP: 0 | PA: 39 |
|-------|--------|

| Batter   | 1      | 2       | 3            | 4       | 5       | 6            | 7             | 8           | 9 |
|--|--------|---------|--------------|---------|---------|--------------|---------------|-------------|---|
| Wayne Causey, L (1, 6)<br>OBP: 0.448, SLG: 0.318   | 4-0 BB |         | 0-3 K        |         |         | 0-0 6-3      | 1-0 1B HBP    |             |   |
| Dick Green, R (1, 4)<br>Manny Jimenez, L (7, PH)<br>George Williams, R (7, PR)<br>(8, 4)                                       | 0-3 K  |         | 0-3 K        |         |         | 0-3 K        | 0-0 1B        |             |   |
| Ed Charles, R (1, 5)<br>OBP: 0.393, SLG: 0.529   | 0-3 K  |         |              | 0-0 F8  |         | 0-0 WP HR 1B | 0-0 G3        |             |   |
| Jim Gentile, L (1, 3)<br>OBP: 0.365, SLG: 0.659  | 0-0 G3 |         |              | 0-0 4-3 |         | 0-0 HR       |               | 4-0 HR BB   |   |
| Rocky Colavito, R (1, 9)<br>OBP: 0.377, SLG: 0.622   |        | 0-0 5-3 |              | 0-3 K   |         | 0-0 6-3      |               | 0-0 HR      |   |
| Doc Edwards, R (1, 2)<br>OBP: 0.276, SLG: 0.259  |        | 0-0 5-3 |              |         | 0-0 6-3 |              | 0-0 F6        | 0-0 E4 G4-3 |   |
| Tommie Reynolds, R (1, 7)<br>OBP: 0.278, SLG: 0.303  |        | 0-0 F3  |              |         | 0-3 K   |              | 0-0 HBP BB 1B | 0-0 G4-3    |   |
| Nelson Mathews, R (1, 8)<br>OBP: 0.281, SLG: 0.400   |        |         | 0-0 SH1-4 1B |         |         | 0-0 IHR      | 0-3 K         | 0-0 2B      |   |
| Diego Segui, R (1, 1)<br>OBP: 0.300, SLG: 0.600<br>Ted Bowsfield, R (7, 1)<br>George Alusik, R (7, PH)<br>John Wyatt, R (8, 1) |        |         | 0-0 SH1-4    |         | 0-3 K   |              | 4-0 1B HBP BB | 0-3 K       |   |

| Inning Stats | R: 0 | H: 0 | E: 0 | K: 2 | S: 7 | LOB: 1 | BB: 1 | P: 11 |
|--------------|------|------|------|------|------|--------|-------|-------|
|              | R: 0 | H: 0 | E: 0 | K: 0 | S: 3 | LOB: 0 | BB: 0 | P: 3  |
|              | R: 0 | H: 1 | E: 0 | K: 2 | S: 8 | LOB: 1 | BB: 0 | P: 8  |
|              | R: 0 | H: 0 | E: 0 | K: 1 | S: 5 | LOB: 0 | BB: 0 | P: 5  |
|              | R: 1 | H: 1 | E: 0 | K: 2 | S: 8 | LOB: 0 | BB: 0 | P: 8  |
|              | R: 2 | H: 2 | E: 0 | K: 1 | S: 7 | LOB: 0 | BB: 0 | P: 7  |
|              | R: 2 | H: 2 | E: 0 | K: 1 | S: 7 | LOB: 2 | BB: 1 | P: 12 |
|              | R: 2 | H: 2 | E: 1 | K: 1 | S: 7 | LOB: 1 | BB: 1 | P: 11 |

| PITCHER                               | IP  | WLS | BF | H | R | ER | SO | BB | IBB | HBP | BLK | WP | HR | S  | P  | ERA   | WHIP  |
|---------------------------------------|-----|-----|----|---|---|----|----|----|-----|-----|-----|----|----|----|----|-------|-------|
| Jim Kaat, L (1, 1)<br>ERA: 3.95       | 6.2 | L   | 28 | 5 | 5 | 5  | 9  | 2  | 0   | 1   | 0   | 1  | 1  | 43 | 52 | 6.75  | 1.050 |
| Bill Fischer, R (7, 1)<br>ERA: 2.45   | 0.1 |     | 2  | 1 | 0 | 0  | 0  | 0  | 0   | 0   | 0   | 0  | 0  | 2  | 2  | 0.00  | 3.000 |
| Dwight Siebler, R (8, 1)<br>ERA: 13.5 | 1.0 |     | 6  | 2 | 2 | 2  | 1  | 1  | 0   | 0   | 0   | 0  | 1  | 7  | 11 | 18.00 | 3.000 |

| AB | R | H | RBI | BB | SO | LOB |
|----|---|---|-----|----|----|-----|
| 2  | 0 | 0 | 0   | 1  | 1  | 1   |
| 3  | 0 | 0 | 0   | 0  | 3  | 2   |
| 1  | 0 | 1 | 2   | 0  | 0  | 0   |
| 0  | 0 | 0 | 0   | 0  | 0  | 0   |
| 4  | 1 | 1 | 0   | 0  | 1  | 3   |
| 3  | 2 | 1 | 2   | 1  | 0  | 1   |
| 4  | 1 | 1 | 2   | 0  | 1  | 0   |
| 4  | 0 | 0 | 0   | 0  | 0  | 0   |
| 4  | 1 | 1 | 0   | 0  | 1  | 1   |
| 4  | 1 | 3 | 1   | 0  | 1  | 1   |
| 1  | 0 | 0 | 0   | 0  | 1  | 0   |
| 0  | 0 | 0 | 0   | 0  | 0  | 0   |
| 0  | 1 | 0 | 0   | 1  | 0  | 0   |
| 1  | 0 | 0 | 0   | 0  | 1  | 1   |

| WP | PA |
|----|----|
| 1  | 36 |

**Minnesota Twins @ Kansas City Athletics**  
Municipal Stadium, Kansas City, MO  
Sun May 03 1964, 4:33 AM EDT  
Unknown

livebaseballscores.com

|     |    |
|-----|----|
| AB  | 31 |
| R   | 7  |
| H   | 8  |
| RBI | 7  |
| BB  | 3  |
| SO  | 10 |
| LOB | 10 |



| Batter   | 1                            | 2                                | 3                             | 4                                | 5                             | 6                                | 7                            | 8                               | 9                            | AB                              | R                            | H                               | RBI                          | BB                               | SO                           | LOB                              | TOP                          |                                  |                                  |                                    |                                  |        |  |  |  |
|--|------------------------------|----------------------------------|-------------------------------|----------------------------------|-------------------------------|----------------------------------|------------------------------|---------------------------------|------------------------------|---------------------------------|------------------------------|---------------------------------|------------------------------|----------------------------------|------------------------------|----------------------------------|------------------------------|----------------------------------|----------------------------------|------------------------------------|----------------------------------|--------|--|--|--|
| Johnny Goryl, R<br>OBP: 0.222, SLG: 0.222 (1, 4)     | 0-0<br>6-3                   | 0-3<br>K                         |                               | 0-0<br>6-3                       |                               |                                  | 0-0<br>5-3                   | 0-0<br>BB<br>1B                 |                              | 5                               | 0                            | 1                               | 0                            | 0                                | 1                            | 1                                |                              |                                  |                                  |                                    |                                  |        |  |  |  |
| Rich Rollins, R<br>OBP: 0.370, SLG: 0.507 (1, 5)     | 4-0<br>PB<br>HR<br>BB        |                                  | 0-0<br>1B<br>2B<br>1B         |                                  | 4-0<br>1B<br>BB               |                                  | 1-0<br>1B<br>FC<br>HBP       | 0-0<br>F9                       |                              | 2                               | 3                            | 1                               | 0                            | 2                                | 0                            | 1                                |                              |                                  |                                  |                                    |                                  |        |  |  |  |
| Tony Oliva, L<br>OBP: 0.451, SLG: 0.737 (1, 9)       | 0-0<br>1-H<br>HR             |                                  | 0-0<br>2B<br>1B               |                                  | 0-0<br>1-2<br>1B              |                                  | 0-0<br>BB<br>FC<br>1B        | 4-0<br>1-2<br>BB                |                              | 4                               | 1                            | 4                               | 2                            | 1                                | 0                            | 0                                |                              |                                  |                                  |                                    |                                  |        |  |  |  |
| Bob Allison, R<br>OBP: 0.406, SLG: 0.540 (1, 3)      | 0-0<br>1-3                   |                                  | 0-3<br>K                      |                                  | 0-0<br>F7                     |                                  | 0-0<br>FC<br>BB              | 0-3<br>K                        |                              | 5                               | 0                            | 0                               | 1                            | 0                                | 2                            | 7                                |                              |                                  |                                  |                                    |                                  |        |  |  |  |
| Harmon Killebrew, R<br>OBP: 0.250, SLG: 0.353 (1, 7) | 0-3<br>K                     |                                  | 0-3<br>K                      |                                  | 0-0<br>G6-4-3<br>1-2f         |                                  | 0-3<br>K                     |                                 | 0-3<br>K                     | 5                               | 0                            | 0                               | 0                            | 0                                | 4                            | 6                                |                              |                                  |                                  |                                    |                                  |        |  |  |  |
| Jimmie Hall, L<br>OBP: 0.424, SLG: 0.680 (1, 8)      |                              | 0-3<br>K                         | 0-0<br>1-3<br>2B              |                                  | 0-0<br>HR                     |                                  | 4-0<br>1-2<br>2-3<br>BB      | 0-3<br>K                        |                              | 4                               | 1                            | 2                               | 2                            | 1                                | 2                            | 0                                |                              |                                  |                                  |                                    |                                  |        |  |  |  |
| Zoilo Versalles, R<br>OBP: 0.320, SLG: 0.364 (1, 6)  |                              | 0-0<br>1B<br>2B                  | 0-0<br>4-3                    |                                  | 0-0<br>6-3                    |                                  | 0-0<br>5-3                   | 0-0<br>3B                       |                              | 5                               | 1                            | 2                               | 0                            | 0                                | 0                            | 5                                |                              |                                  |                                  |                                    |                                  |        |  |  |  |
| Joe McCabe, R<br>OBP: 0.111, SLG: 0.125 (1, 2)       |                              | 0-0<br>1B                        |                               | 0-0<br>F8                        |                               | 0-0<br>6-3                       |                              | 0-0<br>6-3                      | 4-0<br>BB                    | 3                               | 0                            | 1                               | 1                            | 0                                | 0                            | 0                                |                              |                                  |                                  |                                    |                                  |        |  |  |  |
| Lenny Green, L<br>(8, PH)                            |                              |                                  |                               |                                  |                               |                                  |                              |                                 |                              | 1                               | 0                            | 0                               | 0                            | 0                                | 0                            | 0                                |                              |                                  |                                  |                                    |                                  |        |  |  |  |
| Jerry Zimmerman, R<br>OBP: 0.714, SLG: 0.600 (8, 2)  |                              | 2-H<br>1B                        |                               |                                  |                               |                                  |                              |                                 |                              | 0                               | 0                            | 0                               | 0                            | 1                                | 0                            | 0                                |                              |                                  |                                  |                                    |                                  |        |  |  |  |
| Dick Stigman, R<br>(1, 1)                            |                              | 0-3<br>K                         |                               | 0-0<br>4-3                       |                               | 0-0<br>4-3                       |                              | 0-0<br>HR                       | 0-0<br>4-3                   | 2                               | 0                            | 0                               | 0                            | 0                                | 1                            | 1                                |                              |                                  |                                  |                                    |                                  |        |  |  |  |
| Jim Perry, S<br>OBP: 0.500, SLG: 0.500 (4, 1)        |                              |                                  |                               |                                  |                               |                                  |                              |                                 |                              | 0                               | 0                            | 0                               | 0                            | 0                                | 0                            | 0                                |                              |                                  |                                  |                                    |                                  |        |  |  |  |
| Gerry Arrigo, L<br>(5, 1)                            |                              |                                  |                               |                                  |                               |                                  |                              |                                 |                              | 1                               | 0                            | 0                               | 0                            | 0                                | 0                            | 0                                |                              |                                  |                                  |                                    |                                  |        |  |  |  |
| Don Mincher, L<br>OBP: 0.385, SLG: 0.609 (8, PH)     |                              |                                  |                               |                                  |                               |                                  |                              |                                 |                              | 1                               | 1                            | 1                               | 1                            | 0                                | 0                            | 0                                |                              |                                  |                                  |                                    |                                  |        |  |  |  |
| Bill Dailey, R<br>(8, 1)                             |                              |                                  |                               |                                  |                               |                                  |                              |                                 |                              | 0                               | 0                            | 0                               | 0                            | 0                                | 0                            | 0                                |                              |                                  |                                  |                                    |                                  |        |  |  |  |
| Vic Power, R<br>OBP: 0.136, SLG: 0.143 (8, PH)       |                              |                                  |                               |                                  |                               |                                  |                              |                                 |                              | 1                               | 0                            | 0                               | 0                            | 0                                | 0                            | 2                                |                              |                                  |                                  |                                    |                                  |        |  |  |  |
| Bill Pleis, L<br>(9, 1)                              |                              |                                  |                               |                                  |                               |                                  |                              |                                 |                              | 0                               | 0                            | 0                               | 0                            | 0                                | 0                            | 0                                |                              |                                  |                                  |                                    |                                  |        |  |  |  |
| <b>Inning Stats</b>                                  | R: 2<br>E: 0<br>K: 1<br>S: 6 | H: 1<br>LOB: 0<br>BB: 1<br>P: 10 | R: 1<br>E: 0<br>K: 3<br>S: 11 | H: 2<br>LOB: 1<br>BB: 0<br>P: 11 | R: 1<br>E: 0<br>K: 2<br>S: 10 | H: 3<br>LOB: 2<br>BB: 0<br>P: 10 | R: 0<br>E: 0<br>K: 0<br>S: 3 | H: 0<br>LOB: 0<br>BB: 0<br>P: 3 | R: 0<br>E: 0<br>K: 0<br>S: 3 | H: 1<br>LOB: 1<br>BB: 1<br>P: 7 | R: 1<br>E: 0<br>K: 0<br>S: 4 | H: 1<br>LOB: 0<br>BB: 0<br>P: 4 | R: 1<br>E: 0<br>K: 1<br>S: 7 | H: 1<br>LOB: 3<br>BB: 1<br>P: 12 | R: 1<br>E: 0<br>K: 1<br>S: 7 | H: 2<br>LOB: 2<br>BB: 1<br>P: 11 | R: 0<br>E: 0<br>K: 2<br>S: 8 | H: 1<br>LOB: 2<br>BB: 1<br>P: 12 | 1B: 6<br>2B: 2<br>3B: 1<br>HR: 3 | SF: 0<br>SAC: 0<br>DP: 1<br>HBP: 1 | WP: 0<br>PB: 1<br>SB: 0<br>CS: 0 | PA: 45 |  |  |  |
| <b>PITCHER</b>                                       | IP                           | WLS                              | BF                            | H                                | R                             | ER                               | SO                           | BB                              | IBB                          | HBP                             | BLK                          | WP                              | HR                           | S                                | P                            | ERA                              | WHIP                         |                                  |                                  |                                    |                                  |        |  |  |  |
| John O'Donoghue, L<br>ERA: 6.35 (1, 1)               | 4.0                          |                                  | 21                            | 7                                | 4                             | 4                                | 6                            | 2                               | 0                            | 0                               | 0                            | 0                               | 1                            | 31                               | 39                           | 9.00                             | 2.250                        |                                  |                                  |                                    |                                  |        |  |  |  |
| Jack Aker, R<br>ERA: 8.1 (5, 1)                      | 3.1                          |                                  | 16                            | 4                                | 3                             | 3                                | 1                            | 1                               | 0                            | 1                               | 0                            | 0                               | 2                            | 16                               | 21                           | 8.10                             | 1.500                        |                                  |                                  |                                    |                                  |        |  |  |  |
| John Wyatt, R<br>ERA: 1.64 (8, 1)                    | 1.2                          | W                                | 8                             | 1                                | 0                             | 0                                | 3                            | 2                               | 0                            | 0                               | 0                            | 0                               | 0                            | 12                               | 20                           | 0.00                             | 1.800                        |                                  |                                  |                                    |                                  |        |  |  |  |

Minnesota Twins @ Kansas City Athletics  
Municipal Stadium, Kansas City, MO  
Sun May 03 1964, 4:38 AM EDT  
Att. 16,787 - Unknown

|     |    |
|-----|----|
| AB  | 39 |
| R   | 7  |
| H   | 12 |
| RBI | 7  |
| BB  | 5  |
| SO  | 10 |
| LOB | 23 |



BOTTOM

Minnesota Twins @ Kansas City Athletics  
Municipal Stadium, Kansas City, MO

Sun May 03 1964, 4:38 AM EDT  
Att. 16,787 - Unknown

livebaseballscorecards.com

|     |    |
|-----|----|
| AB  | 34 |
| R   | 8  |
| H   | 10 |
| RBI | 8  |
| BB  | 5  |
| SO  | 9  |
| LOB | 10 |



|     |   |     |    |
|-----|---|-----|----|
| WP: | 0 | PA: | 40 |
| PB: | 0 |     |    |
| SB: | 0 |     |    |
| CS: | 0 |     |    |

AB R H RBI BB SO LOB

4 0 0 0 1 0 2

5 0 1 1 0 2 3

4 0 2 0 1 0 1

1 0 0 0 0 1 0  
3 1 0 1 1 1 2

3 2 2 1 1 1 0

3 1 1 1 0 2 0  
1 0 0 0 0 0 1

4 1 1 3 0 0 1

3 2 1 0 1 1 0

2 1 2 1 0 0 0  
1 0 0 0 0 1 0  
0 0 0 0 0 0 0  
0 0 0 0 0 0 0

1B: 6 SF: 0  
2B: 1 SAC: 1  
3B: 1 DP: 1  
HR: 2 HBP: 0

| Batter  | 1      | 2      | 3      | 4            | 5     | 6 | 7       | 8             | 9               |
|---|--------|--------|--------|--------------|-------|---|---------|---------------|-----------------|
| Wayne Causey, L (1, 6)<br>OBP: 0.429, SLG: 0.292    | 0-0 F7 |        | 0-0 F9 | 0-0 F5       |       |   | 0-0 4-3 |               | 4-0 BB BB       |
| Dick Green, R (1, 4)<br>OBP: 0.192, SLG: 0.320      | 0-0 F3 |        | 0-3 K  | 0-0 1-H 3B   |       |   | 0-0 F7  |               | 0-3 K           |
| Ed Charles, R (1, 5)<br>OBP: 0.410, SLG: 0.527      | 0-0 F8 |        |        | 0-0 1B       |       |   | 0-0 1B  |               | 4-0 BB BB       |
| Jim Gentile, L (1, 3)<br>OBP: 0.358, SLG: 0.644     |        | 0-3 K  |        | 0-0 FC6 E    | 0-3 K |   | 0-0 F6  |               | 4-0 BB BB       |
| George Alusik, R (3, 3)                             |        |        |        | 1-2          |       |   |         |               | 1-2 2-3 BB      |
| Rocky Colavito, R (1, 9)<br>OBP: 0.404, SLG: 0.688  |        | 0-0 HR |        | 4-0 E HR BB  | 0-3 K |   |         | 0-0 G6-4-3 1B |                 |
| Doc Edwards, R (1, 2)<br>OBP: 0.281, SLG: 0.267     |        | 0-3 K  |        | 0-0 E3 HR 1B | 0-3 K |   |         | 0-0 F5        |                 |
| Charlie Lau, L (8, PH)<br>OBP: 0.360, SLG: 0.565    |        |        |        | 1-3 2-H      |       |   |         |               |                 |
| Tommie Reynolds, R (1, 7)<br>OBP: 0.275, SLG: 0.378 |        | 0-0 F7 |        | 0-0 HR       |       |   | 0-0 F8  |               | 0-0 G6-4-3      |
| Nelson Mathews, R (1, 8)<br>OBP: 0.295, SLG: 0.414  |        |        | 0-3 K  | 0-0 E5 1B 2B |       |   | 0-0 4-3 |               | 4-0 BB SH3-4 BB |
| John O'Donoghue, R (1, 1)<br>OBP: 0.500, SLG: 0.500 |        |        | 0-0 K  | 0-0 3B 1B    |       |   | 0-3 K   |               | 0-0 SH3-4       |
| Jack Aker, R (5, 1)                                 |        |        |        |              |       |   |         |               |                 |
| John Wyatt, R (8, 1)                                |        |        |        |              |       |   |         |               |                 |
| George Williams, R (9, PH)                          |        |        |        |              |       |   |         |               |                 |

| Inning Stats | R: 0 | H: 0 | E: 0 | K: 0 | S: 3 | R: 1 | H: 1 | E: 0 | K: 2 | S: 8 | R: 0 | H: 1 | E: 0 | K: 2 | S: 8 | R: 6 | H: 6 | E: 3 | K: 0 | S: 9 | R: 0 | H: 0 | E: 0 | K: 3 | S: 9 | R: 0 | H: 1 | E: 0 | K: 0 | S: 4 | R: 0 | H: 1 | E: 0 | K: 0 | S: 3 | R: 1 | H: 0 | E: 0 | K: 1 | S: 4 | 1B: 6 | SF: 0 | 2B: 1 | SAC: 1 | 3B: 1 | DP: 1 | HR: 2 | HBP: 0 |
|--------------|------|------|------|------|------|------|------|------|------|------|------|------|------|------|------|------|------|------|------|------|------|------|------|------|------|------|------|------|------|------|------|------|------|------|------|------|------|------|------|------|-------|-------|-------|--------|-------|-------|-------|--------|
|--------------|------|------|------|------|------|------|------|------|------|------|------|------|------|------|------|------|------|------|------|------|------|------|------|------|------|------|------|------|------|------|------|------|------|------|------|------|------|------|------|------|-------|-------|-------|--------|-------|-------|-------|--------|

| PITCHER                             | IP  | WLS | BF | H | R | ER | SO | BB | IBB | HBP | BLK | WP | HR | S  | P  | ERA   | WHIP  |
|-------------------------------------|-----|-----|----|---|---|----|----|----|-----|-----|-----|----|----|----|----|-------|-------|
| Dick Stigman, L (1, 1)<br>ERA: 8.2  | 3.1 |     | 16 | 5 | 5 | 5  | 4  | 1  | 0   | 0   | 0   | 0  | 2  | 23 | 27 | 13.50 | 1.800 |
| Jim Perry, R (4, 1)<br>ERA: 5.14    | 0.2 |     | 5  | 3 | 2 | 2  | 0  | 0  | 0   | 0   | 0   | 0  | 0  | 5  | 5  | 27.00 | 4.500 |
| Gerry Arrigo, L (5, 1)<br>ERA: 2.45 | 3.0 |     | 10 | 1 | 0 | 0  | 4  | 0  | 0   | 0   | 0   | 0  | 0  | 18 | 18 | 0.00  | 0.333 |
| Bill Dailey, R (8, 1)<br>ERA: 4.5   | 1.0 |     | 3  | 1 | 0 | 0  | 0  | 0  | 0   | 0   | 0   | 0  | 0  | 3  | 3  | 0.00  | 1.000 |
| Bill Pleis, L (9, 1)<br>ERA: 1.42   | 0.2 | L   | 6  | 0 | 1 | 1  | 1  | 4  | 0   | 0   | 0   | 0  | 0  | 4  | 20 | 13.50 | 6.000 |

| Batter   | 1   | 2   | 3   | 4   | 5   | 6   | 7   | 8   | 9   | AB R H RBI BB SO LOB  | TOP   |   |
|--|---|---|---|---|---|---|---|---|---|---|---|---|
| Albie Pearson, L (1, 8)<br>OBP: 0.284, SLG: 0.258<br>Felix Torres, R (9, PH)<br>OBP: 0.125, SLG: 0.125   | 0-0<br>F6   |   | 0-0<br>F9   |   | 0-0<br>FC3-6<br>G6-4-3                              |   | 0-0<br>1-3  |   | 0-0<br>F9   | 4 0 0 0 0 0 2<br>1 0 0 0 0 0 1  |   |   |
| Billy Moran, R (1, 5)<br>OBP: 0.306, SLG: 0.300  | 4-0<br>HR<br>BB                                       |   | 0-0<br>FC6-4<br>1B                                  |   | 0-0<br>G6-4-3                                       |   |   | 0-0<br>L6   |   | 3 1 1 0 1 0 2   |   |   |
| Lee Thomas, L (1, 9)<br>OBP: 0.288, SLG: 0.348   | 0-0<br>1-H<br>HR                                      |   | 0-0<br>F8   |   |   | 0-0<br>F6   |   | 0-0<br>FC6-4<br>1B                                  |   | 4 1 2 2 0 0 1   |   |   |
| Joe Adcock, R (1, 3)<br>OBP: 0.260, SLG: 0.222<br>Charlie Dees, L (6, PR)<br>OBP: 0.188, SLG: 0.071 (6, 3)   | 0-0<br>5-3  |   | 0-0<br>FC6-4  |   |   | 0-0<br>3B<br>1B                                     |   | 0-0<br>FC6-4  |   | 3 0 1 0 0 0 1<br>1 1 0 0 0 0 1  |   |   |
| Buck Rodgers, S (1, 2)<br>OBP: 0.348, SLG: 0.328   | 0-0<br>6-3  |   |   | 4-0<br>BB<br>BB<br>BB<br>BB<br>G3-6-3<br>BB         |   | 0-0<br>F5   |   | 0-0<br>4-3  |   | 3 0 0 0 1 0 2   |   |   |
| Ed Kirkpatrick, L (1, 7)<br>OBP: 0.318, SLG: 0.333   |   | 0-0<br>FC6-4<br>1B                                  |   | 0-0<br>G3-6-3                                       |   | 0-0<br>1-H<br>3B                                    |   |   | 0-0<br>G3<br>SF8<br>2B                              | 4 1 3 1 0 0 1   |   |   |
| Bobby Knoop, R (1, 4)<br>OBP: 0.303, SLG: 0.350<br>Tom Satriano, L (9, PH)<br>OBP: 0.545, SLG: 0.444   |   | 0-3<br>K  |   | 0-0<br>5-3  |   | 0-3<br>K  |   |   | 0-0<br>G3   | 3 0 0 0 0 2 3<br>1 0 0 0 0 0 1  | AB 33<br>R 4<br>H 7<br>RBI 4<br>BB 3<br>SO 3<br>LOB 18                                |   |
| Joe Koppe, R (1, 6)<br>OBP: 0.450, SLG: 0.529<br>Jim Fregosi, R (9, PH)<br>OBP: 0.508, SLG: 0.635<br>Dick Simpson, R (9, PR)<br>OBP: 0.133, SLG: 0.200 |   | 0-0<br>FC6-4<br>FC5-4                               |   | 0-0<br>E1<br>FC3-6<br>E                             |   |   | 0-0<br>5-3  |   | 4-0<br>BB   | 3 0 0 0 0 0 1<br>0 0 0 0 1 0 0<br>0 0 0 0 0 0 0                                   |   |   |
| Bob Lee, R (1, 1)<br>Dan Osinski, R (4, 1)<br>Jack Spring, R (6, 1)<br>Art Fowler, R (6, 1)<br>Willie Smith, L (8, 1)                                  |   | 0-0<br>FC5-4  |   | 0-0<br>E5<br>FC3-6                                  |   |   | 0-3<br>K  |   | 0-0<br>SF8  | 1 0 0 0 0 0 1<br>1 0 0 0 0 0 1<br>0 0 0 0 0 0 0<br>1 0 0 0 0 1 0<br>0 0 0 1 0 0 0 |  |   |
| <b>Inning Stats</b>  | R: 2 H: 1<br>E: 0 LOB: 0<br>K: 0 BB: 1<br>S: 4 P: 8   | R: 0 H: 1<br>E: 0 LOB: 1<br>K: 1 BB: 0<br>S: 6 P: 6 | R: 0 H: 1<br>E: 0 LOB: 1<br>K: 0 BB: 0<br>S: 4 P: 4 | R: 0 H: 0<br>E: 0 LOB: 0<br>K: 0 BB: 1<br>S: 2 P: 6 | R: 0 H: 0<br>E: 2 LOB: 1<br>K: 0 BB: 0<br>S: 4 P: 4 | R: 1 H: 2<br>E: 0 LOB: 2<br>K: 1 BB: 0<br>S: 7 P: 7 | R: 0 H: 0<br>E: 0 LOB: 0<br>K: 1 BB: 0<br>S: 5 P: 5 | R: 0 H: 1<br>E: 0 LOB: 1<br>K: 0 BB: 0<br>S: 4 P: 4 | R: 1 H: 1<br>E: 0 LOB: 1<br>K: 0 BB: 1<br>S: 4 P: 8 | 1B: 4 SF: 1<br>2B: 1 SAC: 0<br>3B: 1 DP: 2<br>HR: 1 HBP: 0                        | WP: 0 PA: 37<br>PB: 0<br>SB: 0<br>CS: 0   |   |
| <b>PITCHER</b><br>Orlando Pena, R (1, 1)<br>ERA: 3.29  | IP WLS BF H R ER SO BB IBB HBP BLK WP HR S P ERA WHIP |   |   |   |   |   |   |   |   |   |   | <b>PITCHER</b><br>IP WLS BF H R ER SO BB IBB HBP BLK WP HR S P ERA WHIP |

Los Angeles Angels @ Kansas City Athletics  
Municipal Stadium, Kansas City, MO  
Mon May 04 1964, 8:05 PM EDT  
Att. 5,634 - Unknown

livebaseballscorecards.com

| Batter  | 1                 | 2                | 3                           | 4                       | 5                | 6                       | 7                | 8                | 9 |
|---|-------------------|------------------|-----------------------------|-------------------------|------------------|-------------------------|------------------|------------------|---|
| Wayne Causey, L (1, 6)<br>OBP: 0.441, SLG: 0.327    | 0-0<br>5-3<br>1B  | 0-0<br>F5        |                             | 0-0<br>1-3<br>1B<br>2B  |                  | 4-0<br>F8<br>1B<br>BB   | 0-0<br>4-3       |                  |   |
| Dick Green, R (1, 4)<br>OBP: 0.211, SLG: 0.345      | 0-3<br>K          |                  | 0-0<br>FC5-4<br>2B          | 0-0<br>2-H<br>3-H<br>1B |                  | 0-0<br>F8               |                  | 0-0<br>F8        |   |
| Ed Charles, R (1, 5)<br>OBP: 0.394, SLG: 0.500      | 0-0<br>5-3<br>1-2 |                  | 0-0<br>6-3                  | 0-0<br>F4               |                  | 0-0<br>F8<br>1-2<br>1B  |                  | 0-3<br>K         |   |
| Jim Gentile, L (1, 3)<br>OBP: 0.379, SLG: 0.617     | 4-0<br>BB         |                  | 4-0<br>FC5-4<br>BB          |                         | 0-0<br>F6        | 0-0<br>F8<br>1-2<br>2-3 |                  | 4-0<br>HR<br>BB  |   |
| Rocky Colavito, R (1, 9)<br>OBP: 0.419, SLG: 0.788  | 0-3<br>K          |                  | 0-0<br>FC5-4<br>1-2f<br>2-3 |                         | 0-0<br>HR        | 4-0<br>IBB              |                  | 0-0<br>1-H<br>HR |   |
| Charlie Lau, L (1, 2)<br>OBP: 0.357, SLG: 0.520     |                   | 4-0<br>BB<br>BB  | 0-0<br>F6                   |                         | 0-0<br>G3        | 0-3<br>K                |                  | 0-0<br>HR        |   |
| George Alusik, R (6, PH)                            |                   |                  |                             |                         |                  |                         |                  |                  |   |
| Manny Jimenez, L (6, PH)                            |                   |                  |                             |                         |                  |                         |                  |                  |   |
| Billy Bryan, L (7, 2)<br>OBP: 0.556, SLG: 1.333     |                   |                  |                             |                         |                  |                         |                  |                  |   |
| Tommie Reynolds, R (1, 7)<br>OBP: 0.289, SLG: 0.366 |                   | 0-0<br>F7        |                             | 0-0<br>F7               | 4-0<br>BB<br>BB  |                         | 0-0<br>6-3       | 0-0<br>1B        |   |
| Nelson Mathews, R (1, 8)<br>OBP: 0.333, SLG: 0.443  |                   | 4-0<br>BB<br>1-2 |                             | 0-0<br>2B<br>1B<br>1B   | 4-0<br>BB<br>1-2 |                         | 0-0<br>1B<br>2B  | 0-3<br>K         |   |
| Orlando Pena, R (1, 1)<br>OBP: 0.125, SLG: 0.067    |                   | 0-3<br>K         |                             | 0-0<br>F4               | 0-3<br>K         |                         | 0-0<br>2-H<br>1B |                  |   |

| Inning Stats | R: 0 | H: 1 | E: 0 | K: 2 | S: 8  | LOB: 2 | BB: 1 | P: 12 |
|--------------|------|------|------|------|-------|--------|-------|-------|
|              | R: 0 | H: 0 | E: 0 | K: 1 | S: 5  | LOB: 2 | BB: 2 | P: 13 |
|              | R: 0 | H: 1 | E: 0 | K: 0 | S: 4  | LOB: 2 | BB: 1 | P: 8  |
|              | R: 2 | H: 3 | E: 0 | K: 0 | S: 6  | LOB: 1 | BB: 0 | P: 6  |
|              | R: 1 | H: 1 | E: 0 | K: 1 | S: 6  | LOB: 2 | BB: 2 | P: 14 |
|              | R: 0 | H: 1 | E: 0 | K: 1 | S: 6  | LOB: 3 | BB: 2 | P: 14 |
|              | R: 1 | H: 2 | E: 0 | K: 0 | S: 4  | LOB: 0 | BB: 0 | P: 4  |
|              | R: 3 | H: 3 | E: 0 | K: 2 | S: 10 | LOB: 1 | BB: 1 | P: 14 |

| PITCHER                            |     |    |    |   |    |    |    |     |     |     |    |    |    |    | PITCHER |       |    |     |    |   |   |    |    |    |     |     |     |    |    |   |   |     |      |  |
|------------------------------------|-----|----|----|---|----|----|----|-----|-----|-----|----|----|----|----|---------|-------|----|-----|----|---|---|----|----|----|-----|-----|-----|----|----|---|---|-----|------|--|
| IP                                 | WLS | BF | H  | R | ER | SO | BB | IBB | HBP | BLK | WP | HR | S  | P  | ERA     | WHIP  | IP | WLS | BF | H | R | ER | SO | BB | IBB | HBP | BLK | WP | HR | S | P | ERA | WHIP |  |
| Bob Lee, R (1, 1)<br>ERA: 1.82     | 3.2 |    | 20 | 5 | 2  | 2  | 3  | 4   | 0   | 0   | 0  | 0  | 22 | 38 | 4.91    | 2.455 |    |     |    |   |   |    |    |    |     |     |     |    |    |   |   |     |      |  |
| Dan Osinski, R (4, 1)<br>ERA: 1.59 | 1.2 |    | 10 | 2 | 1  | 1  | 1  | 3   | 0   | 0   | 0  | 0  | 1  | 9  | 5.40    | 3.000 |    |     |    |   |   |    |    |    |     |     |     |    |    |   |   |     |      |  |
| Jack Spring, L (6, 1)<br>ERA:      | 0.1 |    | 2  | 0 | 0  | 0  | 0  | 0   | 1   | 0   | 0  | 0  | 0  | 1  | 0.00    | 0.000 |    |     |    |   |   |    |    |    |     |     |     |    |    |   |   |     |      |  |
| Art Fowler, R (6, 1)<br>ERA: 10.29 | 2.0 | L  | 10 | 4 | 4  | 4  | 2  | 1   | 0   | 0   | 0  | 0  | 2  | 13 | 18.00   | 2.500 |    |     |    |   |   |    |    |    |     |     |     |    |    |   |   |     |      |  |
| Willie Smith, L (8, 1)<br>ERA:     | 0.1 |    | 2  | 1 | 0  | 0  | 1  | 0   | 0   | 0   | 0  | 0  | 0  | 4  | 0.00    | 3.000 |    |     |    |   |   |    |    |    |     |     |     |    |    |   |   |     |      |  |

**BOTTOM**

Los Angeles Angels @ Kansas City Athletics  
Municipal Stadium, Kansas City, MO

Mon May 04 1964, 8:05 PM EDT  
Att. 5,634 - Unknown

|    |   |   |     |    |    |     |
|----|---|---|-----|----|----|-----|
| AB | R | H | RBI | BB | SO | LOB |
| 4  | 1 | 2 | 0   | 1  | 0  | 2   |
| 5  | 0 | 2 | 2   | 0  | 1  | 2   |
| 5  | 0 | 1 | 0   | 0  | 1  | 3   |
| 2  | 1 | 0 | 0   | 3  | 0  | 2   |
| 4  | 2 | 2 | 3   | 1  | 1  | 4   |
| 2  | 0 | 0 | 0   | 1  | 0  | 2   |
| 0  | 0 | 0 | 0   | 0  | 0  | 0   |
| 1  | 0 | 0 | 0   | 0  | 1  | 3   |
| 1  | 1 | 1 | 1   | 0  | 0  | 0   |
| 4  | 0 | 1 | 0   | 1  | 0  | 1   |
| 3  | 2 | 2 | 0   | 2  | 1  | 1   |
| 4  | 0 | 1 | 1   | 0  | 2  | 5   |

|     |    |
|-----|----|
| AB  | 35 |
| R   | 7  |
| H   | 12 |
| RBI | 7  |
| BB  | 9  |
| SO  | 7  |
| LOB | 25 |

WP: 0 PA: 44  
PB: 0  
SB: 0  
CS: 0



livebaseballscorecards.com

| Batter   | 1   | 2                               | 3                            | 4                                | 5                            | 6                               | 7                            | 8                               | 9                            | AB R H RBI BB SO LOB            | TOP   |                                 |                              |                                 |                              |                                 |                              |                                 |                                  |                                    |                                  |        |
|--|---|---------------------------------|------------------------------|----------------------------------|------------------------------|---------------------------------|------------------------------|---------------------------------|------------------------------|---------------------------------|---|---------------------------------|------------------------------|---------------------------------|------------------------------|---------------------------------|------------------------------|---------------------------------|----------------------------------|------------------------------------|----------------------------------|--------|
| Joe Koppe, R (1, 6)<br>OBP: 0.480, SLG: 0.500      | 0-0<br>G3   |                                 | 4-0<br>E G3<br>BB            |                                  | 0-0<br>F5                    |                                 | 0-0<br>2-H<br>1B             |                                 | 4-0<br>6-3<br>1B<br>BB       | 3 1 1 1 2 0 0                   | <p>Los Angeles Angels @ Kansas City Athletics</p> <p>Municipal Stadium, Kansas City, MO</p> <p>Tue May 05 1964, 8:05 PM EDT</p> <p>Att. 8,153 - Unknown</p> |                                 |                              |                                 |                              |                                 |                              |                                 |                                  |                                    |                                  |        |
| Billy Moran, R (1, 5)<br>OBP: 0.286, SLG: 0.280    | 0-0<br>F9   |                                 | 0-3<br>K                     |                                  | 0-3<br>K                     |                                 | 0-0<br>F7                    |                                 | 0-0<br>6-3                   | 5 0 0 0 0 2 3                   |   |                                 |                              |                                 |                              |                                 |                              |                                 |                                  |                                    |                                  |        |
| Lee Thomas, L (1, 9)<br>OBP: 0.282, SLG: 0.338     | 0-0<br>G3   |                                 | 0-0<br>G3                    |                                  |                              |                                 |                              |                                 | 0-0<br>3-1                   | 5 0 1 1 0 1 1                   |   |                                 |                              |                                 |                              |                                 |                              |                                 |                                  |                                    |                                  |        |
| Joe Adcock, R (1, 3)<br>OBP: 0.296, SLG: 0.375     |   | 4-0<br>BB<br>2B<br>BB           | 0-0<br>F7                    |                                  |                              | 0-0<br>K<br>HR                  |                              | 0-0<br>HR                       |                              | 3 3 2 2 1 0 1                   |   |                                 |                              |                                 |                              |                                 |                              |                                 |                                  |                                    |                                  |        |
| Buck Rodgers, S (1, 2)<br>OBP: 0.342, SLG: 0.313   |   | 4-0<br>1-2<br>2B<br>BB          |                              | 0-0<br>F7                        |                              | 0-0<br>F2                       |                              | 0-0<br>5-3                      |                              | 3 1 0 0 1 0 0                   |   |                                 |                              |                                 |                              |                                 |                              |                                 |                                  |                                    |                                  |        |
| Ed Kirkpatrick, L (1, 7)<br>OBP: 0.333, SLG: 0.372 |   | 0-0<br>4-3<br>1-H<br>2-H<br>2B  |                              | 0-0<br>4-3                       |                              | 0-0<br>F9                       |                              | 0-0<br>1B<br>S<br>1B            |                              | 4 1 2 2 0 0 0                   |   |                                 |                              |                                 |                              |                                 |                              |                                 |                                  |                                    |                                  |        |
| Bobby Knoop, R (1, 4)<br>OBP: 0.329, SLG: 0.422    |   | 0-0<br>4-3<br>2-3               |                              | 0-0<br>K<br>HR                   |                              |                                 | 0-0<br>FC5-4<br>1B           |                                 | 0-0<br>S<br>1B               | 4 1 3 1 0 0 1                   |   |                                 |                              |                                 |                              |                                 |                              |                                 |                                  |                                    |                                  |        |
| Dick Simpson, R (1, 8)<br>OBP: 0.105, SLG: 0.158   |   | 0-3<br>K                        |                              | 0-0<br>F3                        |                              |                                 | 0-0<br>FC5-4<br>1B<br>S      |                                 | 0-3<br>K                     | 4 1 0 0 0 2 3                   |   |                                 |                              |                                 |                              |                                 |                              |                                 |                                  |                                    |                                  |        |
| Barry Latman, R (1, 1)<br>Dean Chance, R (6, 1)    |   | 0-3<br>K                        |                              |                                  | 0-0<br>1-3                   |                                 | 0-0<br>1-3                   |                                 | 0-0<br>2-3                   | 2 0 0 0 0 1 1<br>2 0 0 0 0 0 1  |   |                                 |                              |                                 |                              |                                 |                              |                                 |                                  |                                    |                                  |        |
| <b>Inning Stats</b>                                | R: 0<br>E: 0<br>K: 0<br>S: 3                          | H: 0<br>LOB: 0<br>BB: 0<br>P: 3 | R: 2<br>E: 0<br>K: 2<br>S: 8 | H: 1<br>LOB: 1<br>BB: 2<br>P: 16 | R: 0<br>E: 1<br>K: 1<br>S: 5 | H: 0<br>LOB: 1<br>BB: 1<br>P: 9 | R: 1<br>E: 0<br>K: 0<br>S: 4 | H: 1<br>LOB: 0<br>BB: 0<br>P: 4 | R: 0<br>E: 0<br>K: 1<br>S: 5 | H: 0<br>LOB: 0<br>BB: 0<br>P: 5 | R: 1<br>E: 0<br>K: 1<br>S: 6  | H: 1<br>LOB: 0<br>BB: 0<br>P: 6 | R: 1<br>E: 0<br>K: 0<br>S: 5 | H: 2<br>LOB: 1<br>BB: 0<br>P: 5 | R: 2<br>E: 0<br>K: 1<br>S: 8 | H: 3<br>LOB: 1<br>BB: 0<br>P: 8 | R: 1<br>E: 0<br>K: 0<br>S: 3 | H: 1<br>LOB: 1<br>BB: 1<br>P: 7 | 1B: 5<br>2B: 1<br>3B: 0<br>HR: 3 | SF: 0<br>SAC: 0<br>DP: 0<br>HBP: 0 | WP: 0<br>PB: 0<br>SB: 3<br>CS: 0 | PA: 39 |
| <b>PITCHER</b>                                     | IP WLS BF H R ER SO BB IBB HBP BLK WP HR S P ERA WHIP |                                 |                              |                                  |                              |                                 |                              |                                 |                              |                                 |   |                                 |                              |                                 |                              |                                 |                              |                                 |                                  |                                    |                                  |        |
| Vern Handrahan, R (1, 1)<br>ERA: 6.75              | 6.0 L 24 3 4 4 5 3 0 0 0 0 2 31 43 6.00 1.000         |                                 |                              |                                  |                              |                                 |                              |                                 |                              |                                 |   |                                 |                              |                                 |                              |                                 |                              |                                 |                                  |                                    |                                  |        |
| Dan Pfister, R (7, 1)<br>ERA: 15.19                | 3.0 15 6 4 4 1 1 0 0 0 0 1 16 20 12.00 2.333          |                                 |                              |                                  |                              |                                 |                              |                                 |                              |                                 |   |                                 |                              |                                 |                              |                                 |                              |                                 |                                  |                                    |                                  |        |

livebaseballscorecards.com

|     |    |
|-----|----|
| AB  | 35 |
| R   | 8  |
| H   | 9  |
| RBI | 7  |
| BB  | 4  |
| SO  | 6  |
| LOB | 11 |





| Batter  | 1              | 2            | 3          | 4      | 5              | 6       | 7       | 8      | 9        | AB | R | H | RBI | BB | SO | LOB |
|---|----------------|--------------|------------|--------|----------------|---------|---------|--------|----------|----|---|---|-----|----|----|-----|
| Wayne Causey, L (1, 6)<br>OBP: 0.411, SLG: 0.298    | 0-0 F9         | 0-0 F9       |            |        | 0-0 4-3        |         | 0-0 F8  |        | 0-0 G6-3 | 5  | 0 | 0 | 0   | 0  | 0  | 2   |
| Dick Green, R (1, 4)<br>OBP: 0.213, SLG: 0.328      | 4-0 2B BB      |              | 0-0 5-3    |        | 0-3 K          |         | 0-0 F4  |        |          | 3  | 0 | 0 | 0   | 1  | 1  | 0   |
| Ed Charles, R (1, 5)<br>OBP: 0.400, SLG: 0.516      | 0-0 1-3 2B     |              | 0-0 S 1B   |        | 0-0 5-3        |         | 0-0 6-3 |        |          | 4  | 0 | 2 | 0   | 0  | 0  | 0   |
| Jim Gentile, L (1, 3)<br>OBP: 0.387, SLG: 0.600     | 0-3 K          |              | 0-0 1-2 F7 |        | 0-0 1B SF7 1B  |         | 4-0 BB  |        |          | 3  | 1 | 1 | 0   | 1  | 1  | 3   |
| Rocky Colavito, R (1, 9)<br>OBP: 0.424, SLG: 0.764  | 4-0 FC4-6 BB   |              | 0-0 5-3    |        | 0-0 1B 1B      |         | 0-3 K   |        |          | 3  | 0 | 1 | 0   | 1  | 1  | 2   |
| Charlie Lau, L (1, 2)<br>OBP: 0.375, SLG: 0.517     | 0-0 1-2f FC4-6 |              | 0-0 1B     |        | 0-0 1-2 2-3 1B |         | 0-3 K   |        |          | 4  | 0 | 2 | 0   | 0  | 1  | 4   |
| Tommie Reynolds, R (1, 7)<br>OBP: 0.277, SLG: 0.349 |                | 0-0 F6       |            | 0-3 K  |                | 0-0 SF7 |         | 0-0 F9 |          | 2  | 0 | 0 | 0   | 0  | 1  | 1   |
| Manny Jimenez, L (6, PH)<br>OBP: 0.286, SLG: 0.750  |                |              |            |        |                |         |         |        |          | 1  | 0 | 0 | 1   | 0  | 0  | 1   |
| Nelson Mathews, R (1, 8)<br>OBP: 0.329, SLG: 0.422  |                | 4-0 FC5-6 BB |            | 0-0 F7 |                | 0-3 K   |         | 0-3 K  |          | 3  | 0 | 0 | 0   | 1  | 2  | 3   |
| Vern Handrahan, L (1, 1)<br>OBP: 0.500, SLG: 1.143  |                | 0-0 FC5-6    |            | 0-3 K  |                | 0-3 K   |         | 0-0 E5 |          | 2  | 0 | 0 | 0   | 0  | 1  | 2   |
| Billy Bryan, L (6, PH)<br>OBP: 0.500, SLG: 1.143    |                |              |            |        |                |         |         |        |          | 1  | 0 | 0 | 0   | 0  | 1  | 2   |
| Dan Pfister, R (7, 1)                               |                |              |            |        |                |         |         |        |          | 0  | 0 | 0 | 0   | 0  | 0  | 0   |
| George Williams, R (9, PH)                          |                |              |            |        |                |         |         |        |          | 1  | 0 | 0 | 0   | 0  | 0  | 0   |

| Inning Stats | R: 0 | H: 1 | E: 0 | K: 1 | S: 6 | H: 1 | LOB: 3 | BB: 2 | P: 14 | R: 0 | H: 0 | E: 0 | K: 0 | S: 3 | R: 0 | H: 1 | E: 0 | K: 0 | S: 4 | R: 0 | H: 1 | E: 0 | K: 2 | S: 8 | R: 0 | H: 0 | E: 0 | K: 1 | S: 5 | R: 1 | H: 3 | E: 0 | K: 2 | S: 10 | R: 0 | H: 0 | E: 0 | K: 0 | S: 3 | R: 0 | H: 0 | E: 0 | K: 2 | S: 7 | R: 0 | H: 0 | E: 1 | K: 1 | S: 5 | 1B: 5 | SF: 1 | 2B: 1 | 3B: 0 | HR: 0 |
|--------------|------|------|------|------|------|------|--------|-------|-------|------|------|------|------|------|------|------|------|------|------|------|------|------|------|------|------|------|------|------|------|------|------|------|------|-------|------|------|------|------|------|------|------|------|------|------|------|------|------|------|------|-------|-------|-------|-------|-------|
|--------------|------|------|------|------|------|------|--------|-------|-------|------|------|------|------|------|------|------|------|------|------|------|------|------|------|------|------|------|------|------|------|------|------|------|------|-------|------|------|------|------|------|------|------|------|------|------|------|------|------|------|------|-------|-------|-------|-------|-------|

| PITCHER                             | IP  | WLS | BF | H | R | ER | SO | BB | IBB | HBP | BLK | WP | HR | S  | P  | ERA  | WHIP  |
|-------------------------------------|-----|-----|----|---|---|----|----|----|-----|-----|-----|----|----|----|----|------|-------|
| Barry Latman, R (1, 1)<br>ERA: 4.35 | 5.0 | W   | 24 | 6 | 1 | 1  | 4  | 3  | 0   | 0   | 0   | 0  | 0  | 29 | 41 | 1.80 | 1.800 |
| Dean Chance, R (6, 1)<br>ERA: 1.5   | 4.0 | S   | 13 | 0 | 0 | 0  | 5  | 1  | 0   | 0   | 0   | 0  | 0  | 22 | 26 | 0.00 | 0.250 |

**BOTTOM**

Los Angeles Angels @ Kansas City Athletics  
Municipal Stadium, Kansas City, MO

Tue May 05 1964, 8:05 PM EDT  
Att. 8,153 - Unknown

livebaseballscorecards.com

|     |    |
|-----|----|
| AB  | 32 |
| R   | 1  |
| H   | 6  |
| RBI | 1  |
| BB  | 4  |
| SO  | 9  |
| LOB | 20 |



| WP | PA | ERA | WHIP |
|----|----|-----|------|
| 0  | 37 |     |      |

| Batter   | 1          | 2          | 3         | 4             | 5             | 6              | 7                   | 8             | 9                | AB R H RBI BB SO LOB   |
|--|------------|------------|-----------|---------------|---------------|----------------|---------------------|---------------|------------------|--|
| Wayne Causey, L (1, 6)<br>OBP: 0.423, SLG: 0.311   | 0-3<br>K   |            | 0-3<br>K  |               | 4-0<br>1B BB  |                | 0-0<br>E 1B         |               | 0-0<br>G5-4-3 1B | 4 0 2 0 1 2 1  |
| Dick Green, R (1, 4)<br>OBP: 0.212, SLG: 0.317   | 0-3<br>K   |            | 0-0<br>F3 |               | 0-0<br>1B     |                | 0-0<br>E5           |               | 0-0<br>G5-4-3 1B | 5 0 1 0 0 1 4  |
| Ed Charles, R (1, 5)<br>OBP: 0.387, SLG: 0.493   | 0-0<br>5-3 |            |           |               | 0-0<br>E6 1-3 |                | 0-0<br>F8           |               | 4-0<br>BB        | 3 1 0 1 1 0 2  |
| Rocky Colavito, R (1, 9)<br>OBP: 0.408, SLG: 0.712   |            | 0-0<br>4-3 |           | 0-0<br>4-6-3  |               | 4-0<br>G6-3 BB |                     | 0-0<br>K      | 0-0<br>F5        | 4 0 0 0 1 1 4  |
| Jim Gentile, L (1, 3)<br>OBP: 0.409, SLG: 0.604  |            | 0-0<br>1B  |           | 4-0<br>1-3 BB |               | 0-3<br>K       |                     | 0-0<br>5-3 1B |                  | 3 1 2 0 1 1 1  |
| Doc Edwards, R (1, 2)<br>OBP: 0.250, SLG: 0.235  |            | 0-3<br>K   |           | 0-0<br>1-3    |               | 0-0<br>G6-3    |                     | 0-0<br>5-3    |                  | 4 0 0 1 0 1 4  |
| Tommie Reynolds, R (1, 7)<br>OBP: 0.255, SLG: 0.319  |            | 0-0<br>5-3 |           | 0-0<br>6-3    |               | 0-0<br>F7      |                     | 0-0<br>6-3    |                  | 4 0 0 0 0 0 3  |
| Nelson Mathews, R (1, 8)<br>OBP: 0.351, SLG: 0.433   |            |            | 4-0<br>BB |               | 0-0<br>F9     |                | 0-0<br>1B HBP E 1B  |               | 0-0<br>2-H 1B    | 3 1 2 1 1 0 0  |
| Moe Drabowsky, R (1, 1)<br>Ted Bowsfield, R (6, 1)<br>George Williams, R (7, PH)<br>John O'Donoghue, R (7, 1)<br>Manny Jimenez, L (8, PH)<br>Jack Aker, R (8, 1) |            |            | 0-3<br>K  |               | 0-0<br>F5     |                | 1-0<br>E 1B SF8 HBP |               | 0-0<br>G3        | 2 0 0 0 0 0 1 1<br>0 0 0 0 0 0 0 0<br>0 1 0 0 0 0 0 0<br>0 0 0 0 0 0 0 0<br>1 0 0 0 0 0 0 1<br>0 0 0 0 0 0 0 0 |

| Inning Stats | R: 0<br>E: 0<br>K: 2<br>S: 7 | H: 0<br>LOB: 0<br>BB: 0<br>P: 7 | R: 0<br>E: 0<br>K: 1<br>S: 6 | H: 1<br>LOB: 1<br>BB: 0<br>P: 6 | R: 0<br>E: 0<br>K: 2<br>S: 7 | H: 0<br>LOB: 1<br>BB: 1<br>P: 11 | R: 1<br>E: 2<br>K: 0<br>S: 4 | H: 0<br>LOB: 1<br>BB: 1<br>P: 8 | R: 0<br>E: 0<br>K: 0<br>S: 4 | H: 1<br>LOB: 2<br>BB: 1<br>P: 8 | R: 0<br>E: 0<br>K: 1<br>S: 4 | H: 0<br>LOB: 0<br>BB: 1<br>P: 8 | R: 2<br>E: 1<br>K: 1<br>S: 8 | H: 2<br>LOB: 2<br>BB: 0<br>P: 9 | R: 1<br>E: 0<br>K: 0<br>S: 5 | H: 2<br>LOB: 1<br>BB: 0<br>P: 5 | R: 0<br>E: 0<br>K: 0<br>S: 3 | H: 1<br>LOB: 1<br>BB: 1<br>P: 7 | 1B: 7<br>2B: 0<br>3B: 0<br>HR: 0 | SF: 1<br>SAC: 0<br>DP: 2<br>HBP: 1 | WP: 0<br>PB: 0<br>SB: 0<br>CS: 0 | PA: 40 |
|--------------|------------------------------|---------------------------------|------------------------------|---------------------------------|------------------------------|----------------------------------|------------------------------|---------------------------------|------------------------------|---------------------------------|------------------------------|---------------------------------|------------------------------|---------------------------------|------------------------------|---------------------------------|------------------------------|---------------------------------|----------------------------------|------------------------------------|----------------------------------|--------|
|--------------|------------------------------|---------------------------------|------------------------------|---------------------------------|------------------------------|----------------------------------|------------------------------|---------------------------------|------------------------------|---------------------------------|------------------------------|---------------------------------|------------------------------|---------------------------------|------------------------------|---------------------------------|------------------------------|---------------------------------|----------------------------------|------------------------------------|----------------------------------|--------|

| PITCHER                             | IP  | WLS | BF | H | R | ER | SO | BB | IBB | HBP | BLK | WP | HR | S  | P  | ERA  | WHIP  |
|-------------------------------------|-----|-----|----|---|---|----|----|----|-----|-----|-----|----|----|----|----|------|-------|
| Gary Peters, L (1, 1)<br>ERA: 1.82  | 6.2 | W   | 30 | 4 | 3 | 0  | 6  | 4  | 0   | 1   | 0   | 0  | 0  | 37 | 54 | 0.00 | 1.200 |
| Hoyt Wilhelm, R (7, 1)<br>ERA: 2.92 | 2.1 | S   | 10 | 3 | 1 | 1  | 1  | 1  | 0   | 0   | 0   | 0  | 0  | 11 | 15 | 3.86 | 1.714 |

**TOP**

**Kansas City Athletics @ Chicago White Sox**  
Comiskey Park, Chicago, IL  
Wed May 06 1964, 8:05 PM EDT  
Unknown

|            |           |
|------------|-----------|
| <b>AB</b>  | <b>33</b> |
| <b>R</b>   | <b>4</b>  |
| <b>H</b>   | <b>7</b>  |
| <b>RBI</b> | <b>3</b>  |
| <b>BB</b>  | <b>5</b>  |
| <b>SO</b>  | <b>7</b>  |
| <b>LOB</b> | <b>21</b> |

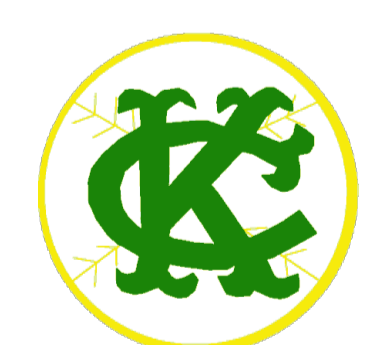

| Batter   | 1         | 2               | 3           | 4        | 5        | 6               | 7         | 8             | 9 |
|--|-----------|-----------------|-------------|----------|----------|-----------------|-----------|---------------|---|
| Mike Hershberger, R (1, 8)<br>OBP: 0.393, SLG: 0.327 | 0-3 K ①   |                 | 0-0 2-H 1B  |          |          | 0-0 6-3 ①       | 0-0 6-3 ② |               |   |
| Don Buford, S (1, 5)<br>OBP: 0.300, SLG: 0.245       | 0-0 1-3 ② |                 | 0-0 F2 ③    |          |          | 0-0 S 1B SF7 1B | 0-0 6-3 ③ |               |   |
| Floyd Robinson, L (1, 9)<br>OBP: 0.443, SLG: 0.481   | 0-3 K ③   |                 |             |          | 0-0 F9 ① | 0-0 S 1B 1-2 1B |           | 0-0 PB 1-3 1B |   |
| Ron Hansen, R (1, 6)<br>OBP: 0.390, SLG: 0.571       |           | 4-0 BB BB BB BB |             | 0-3 K ②  |          | 0-0 SF7 ②       |           | 0-0 F1 ①      |   |
| Joe Cunningham, L (1, 3)<br>OBP: 0.370, SLG: 0.340   |           | 0-0 F8 ①        |             | 0-0 F2 ③ |          | 0-0 HR ②        |           | 0-0 1-3 ②     |   |
| Dave Nicholson, R (1, 7)<br>OBP: 0.379, SLG: 0.447   |           | 0-0 G4-3 ② ③    |             |          | 0-0 HR   | 0-0 HR ①        |           | 0-3 K ③       |   |
| Al Weis, S (1, 4)<br>OBP: 0.326, SLG: 0.350          |           |                 | 0-0 4-3 ①   |          | 0-3 K ①  | 0-0 1B          |           |               |   |
| J.C. Martin, L (1, 2)<br>OBP: 0.200, SLG: 0.200      |           |                 | 0-0 G3 1B ① |          | 0-0 F8 ② | 0-0 4-3 ③       |           |               |   |
| Gary Peters, L (1, 1)<br>OBP: 0.182, SLG: 0.364      |           |                 | 0-0 G3 ②    |          | 0-3 K ③  |                 | 0-0 4-3 ① |               |   |
| Hoyt Wilhelm, R (7, 1)                               |           |                 | 1-2         |          |          |                 |           |               |   |

| Inning Stats | R: 0 | H: 0 | E: 0 | K: 2 | S: 7 | LOB: 0 | BB: 0 | P: 7 |
|--------------|------|------|------|------|------|--------|-------|------|
|              | R: 0 | H: 0 | E: 0 | K: 0 | S: 2 | LOB: 0 | BB: 1 | P: 6 |
|              | R: 1 | H: 2 | E: 0 | K: 0 | S: 5 | LOB: 1 | BB: 0 | P: 5 |
|              | R: 0 | H: 0 | E: 0 | K: 1 | S: 5 | LOB: 0 | BB: 0 | P: 5 |
|              | R: 1 | H: 1 | E: 0 | K: 2 | S: 8 | LOB: 0 | BB: 0 | P: 8 |
|              | R: 4 | H: 5 | E: 0 | K: 0 | S: 8 | LOB: 1 | BB: 0 | P: 8 |
|              | R: 0 | H: 0 | E: 0 | K: 0 | S: 3 | LOB: 0 | BB: 0 | P: 3 |
|              | R: 0 | H: 1 | E: 0 | K: 1 | S: 6 | LOB: 1 | BB: 0 | P: 6 |

| PITCHER                                | IP  | WLS | BF | H | R | ER | SO | BB | IBB | HBP | BLK | WP | HR | S  | P  | ERA  | WHIP  |
|--|-----|-----|----|---|---|----|----|----|-----|-----|-----|----|----|----|----|------|-------|
| Moe Drabowsky, R (1, 1)<br>ERA: 5.49   | 5.2 | L   | 25 | 8 | 6 | 6  | 5  | 1  | 0   | 0   | 0   | 0  | 2  | 34 | 38 | 9.53 | 1.588 |
| Ted Bowsfield, L (6, 1)<br>ERA: 4.15   | 0.1 |     | 1  | 0 | 0 | 0  | 0  | 0  | 0   | 0   | 0   | 0  | 0  | 1  | 1  | 0.00 | 0.000 |
| John O'Donoghue, L (7, 1)<br>ERA: 5.84 | 1.0 |     | 3  | 0 | 0 | 0  | 0  | 0  | 0   | 0   | 0   | 0  | 0  | 3  | 3  | 0.00 | 0.000 |
| Jack Aker, R (8, 1)<br>ERA: 6.23       | 1.0 |     | 4  | 1 | 0 | 0  | 1  | 0  | 0   | 0   | 0   | 0  | 0  | 6  | 6  | 0.00 | 1.000 |

**BOTTOM**

**Kansas City Athletics @ Chicago White Sox**  
Comiskey Park, Chicago, IL  
Wed May 06 1964, 8:05 PM EDT  
Unknown

| AB | R | H | RBI | BB | SO | LOB |
|----|---|---|-----|----|----|-----|
| 4  | 0 | 1 | 1   | 0  | 1  | 0   |
| 4  | 1 | 1 | 0   | 0  | 0  | 1   |
| 4  | 1 | 2 | 0   | 0  | 1  | 0   |
| 2  | 0 | 0 | 1   | 1  | 1  | 1   |
| 4  | 1 | 1 | 1   | 0  | 0  | 2   |
| 4  | 2 | 2 | 3   | 0  | 1  | 2   |
| 3  | 0 | 1 | 0   | 0  | 1  | 0   |
| 3  | 1 | 1 | 0   | 0  | 0  | 1   |
| 2  | 0 | 0 | 0   | 0  | 1  | 1   |
| 1  | 0 | 0 | 0   | 0  | 0  | 0   |

| AB  | 31 |
|-----|----|
| R   | 6  |
| H   | 9  |
| RBI | 6  |
| BB  | 1  |
| SO  | 6  |
| LOB | 8  |

livebaseballscorecards.com



| WP | PA |
|----|----|
| 0  | 33 |

| Batter  | 1  | 2   | 3   | 4                               | 5                            | 6                                | 7                            | 8                               | 9  | AB R H RBI BB SO LOB            | TOP   |                                  |                              |                                 |                              |                                 |                              |                                 |                                  |                                    |                                  |        |
|---|--|---|---|---------------------------------|------------------------------|----------------------------------|------------------------------|---------------------------------|--|---------------------------------|---|----------------------------------|------------------------------|---------------------------------|------------------------------|---------------------------------|------------------------------|---------------------------------|----------------------------------|------------------------------------|----------------------------------|--------|
| Wayne Causey, L (1, 6)<br>OBP: 0.422, SLG: 0.308  | 0-0<br>FC1-5<br>1B   | 0-0<br>1-3  |   | 0-0<br>F8                       |                              |                                  | 4-0<br>5-3<br>BB             | 0-0<br>FC6-4<br>1-2f            |  | 4 0 1 0 1 0 4                   | <b>Kansas City Athletics @ Chicago White Sox</b><br>Comiskey Park, Chicago, IL<br>Wed May 06 1964, 8:05 PM EDT<br>Att. 14,707 - Unknown<br><a href="http://livebaseballscorecards.com">livebaseballscorecards.com</a> |                                  |                              |                                 |                              |                                 |                              |                                 |                                  |                                    |                                  |        |
| Dick Green, R (1, 4)<br>OBP: 0.225, SLG: 0.324  | 0-0<br>FC1-5<br>1B   |   | 0-0<br>S<br>1B  |                                 | 0-0<br>6-3                   |                                  | 0-0<br>5-3                   | 0-0<br>F7                       | 5 1 2 0 0 0 1  |                                 |   |                                  |                              |                                 |                              |                                 |                              |                                 |                                  |                                    |                                  |        |
| Ed Charles, R (1, 5)<br>OBP: 0.363, SLG: 0.458  | 0-0<br>FC1-5<br>1B   |   | 0-0<br>F8   |                                 | 0-0<br>6-3                   |                                  | 0-0<br>5-3                   | 0-0<br>5-3                      | 5 1 0 0 0 0 4  |                                 |   |                                  |                              |                                 |                              |                                 |                              |                                 |                                  |                                    |                                  |        |
| Jim Gentile, L (1, 3)<br>OBP: 0.394, SLG: 0.621   | 0-0<br>1-H<br>2-H<br>HR  |   | 0-3<br>K  |                                 | 0-3<br>K                     |                                  | 0-0<br>G3                    | 0-3<br>K                        | 5 1 1 3 0 3 2  |                                 |   |                                  |                              |                                 |                              |                                 |                              |                                 |                                  |                                    |                                  |        |
| Rocky Colavito, R (1, 9)<br>OBP: 0.400, SLG: 0.677  | 0-0<br>4-3   |   | 4-0<br>BB   |                                 | 0-3<br>K                     |                                  | 0-0<br>F7                    |                                 | 3 0 0 0 1 1 0  |                                 |   |                                  |                              |                                 |                              |                                 |                              |                                 |                                  |                                    |                                  |        |
| Charlie Lau, L (1, 2)<br>OBP: 0.333, SLG: 0.455   | 0-0<br>6-3   |   | 0-0<br>F7   |                                 | 0-0<br>F4                    |                                  | 0-0<br>1-3                   |                                 | 4 0 0 0 0 0 2  |                                 |   |                                  |                              |                                 |                              |                                 |                              |                                 |                                  |                                    |                                  |        |
| Dave Duncan, R (8, 2)   |  |   |   |                                 |                              |                                  |                              |                                 | 0 0 0 0 0 0 0  |                                 |   |                                  |                              |                                 |                              |                                 |                              |                                 |                                  |                                    |                                  |        |
| Tommie Reynolds, R (1, 7)<br>OBP: 0.291, SLG: 0.327   |  | 1-0<br>FC5-4<br>HBP   |   | 0-3<br>K                        |                              | 4-0<br>BB<br>BB                  |                              | 0-0<br>3B<br>1B                 | 2 1 1 0 1 1 0  |                                 |   |                                  |                              |                                 |                              |                                 |                              |                                 |                                  |                                    |                                  |        |
| Nelson Mathews, R (1, 8)<br>OBP: 0.372, SLG: 0.486  |  | 0-0<br>F9   |   | 0-0<br>2B                       |                              | 4-0<br>BB<br>BB                  |                              | 0-0<br>1-H<br>3B                | 3 0 2 1 1 0 1  |                                 |   |                                  |                              |                                 |                              |                                 |                              |                                 |                                  |                                    |                                  |        |
| Aurelio Monteaugudo, R (1, 1)<br>OBP: 0.250, SLG: 0.250<br>John O'Donoghue, R (3, 1)<br>OBP: 0.400, SLG: 0.400<br>Manny Jimenez, L (6, PH)<br>OBP: 0.250, SLG: 0.643<br>Ted Bowsfield, R (6, 1)<br>George Alusik, R (8, PH)<br>John Wyatt, R (8, 1) |  | 0-0<br>FC5-4<br>1-2f  |   | 0-0<br>F4                       |                              | 0-0<br>F8                        |                              | 4-0<br>FC6-4<br>BB              | 1 0 0 0 0 0 0 1<br>1 0 0 0 0 0 0 1<br>1 0 0 0 0 0 0 2<br>0 0 0 0 0 0 0 0<br>0 0 0 0 0 1 0 0<br>0 0 0 0 0 0 0 0 |                                 |   |                                  |                              |                                 |                              |                                 |                              |                                 |                                  |                                    |                                  |        |
| <b>Inning Stats</b>   | R: 3<br>E: 0<br>K: 0<br>S: 6   | H: 3<br>LOB: 0<br>BB: 0<br>P: 6   | R: 0<br>E: 0<br>K: 0<br>S: 3  | H: 0<br>LOB: 1<br>BB: 0<br>P: 4 | R: 0<br>E: 0<br>K: 1<br>S: 6 | H: 1<br>LOB: 2<br>BB: 1<br>P: 10 | R: 0<br>E: 0<br>K: 1<br>S: 6 | H: 1<br>LOB: 1<br>BB: 0<br>P: 6 | R: 0<br>E: 0<br>K: 1<br>S: 5   | H: 0<br>LOB: 0<br>BB: 0<br>P: 5 | R: 0<br>E: 0<br>K: 1<br>S: 5  | H: 0<br>LOB: 2<br>BB: 2<br>P: 13 | R: 0<br>E: 0<br>K: 0<br>S: 3 | H: 0<br>LOB: 1<br>BB: 1<br>P: 7 | R: 1<br>E: 0<br>K: 0<br>S: 5 | H: 2<br>LOB: 2<br>BB: 1<br>P: 9 | R: 0<br>E: 0<br>K: 1<br>S: 5 | H: 0<br>LOB: 0<br>BB: 0<br>P: 5 | 1B: 4<br>2B: 1<br>3B: 1<br>HR: 1 | SF: 0<br>SAC: 0<br>DP: 0<br>HBP: 1 | WP: 0<br>PB: 0<br>SB: 1<br>CS: 0 | PA: 40 |
| <b>PITCHER</b><br>Ray Herbert, R (1, 1)<br>ERA: 2.7<br>Eddie Fisher, R (8, 1)<br>ERA: 3.12  | IP: 7.0<br>WLS: W<br>BF: 31<br>H: 5<br>R: 3<br>ER: 3<br>SO: 4<br>BB: 4<br>IBB: 0<br>HBP: 1<br>BLK: 0<br>WP: 0<br>HR: 1<br>S: 34<br>P: 51<br>ERA: 3.86<br>WHIP: 1.286 | IP: 2.0<br>WLS: S<br>BF: 9<br>H: 2<br>R: 1<br>ER: 1<br>SO: 1<br>BB: 1<br>IBB: 0<br>HBP: 0<br>BLK: 0<br>WP: 0<br>HR: 0<br>S: 10<br>P: 14<br>ERA: 4.50<br>WHIP: 1.500 | <b>PITCHER</b><br>IP WLS BF H R ER SO BB IBB HBP BLK WP HR S P ERA WHIP |                                 |                              |                                  |                              |                                 |  |                                 |   |                                  |                              |                                 |                              |                                 |                              |                                 |                                  |                                    |                                  |        |



| Batter  | 1                     | 2                     | 3                         | 4                | 5                      | 6               | 7                     | 8          | 9 | AB | R | H | RBI | BB | SO | LOB |
|---|-----------------------|-----------------------|---------------------------|------------------|------------------------|-----------------|-----------------------|------------|---|----|---|---|-----|----|----|-----|
| Mike Hershberger, R<br>OBP: 0.377, SLG: 0.315<br>(1, 8) | 0-0<br>HBP<br>1B      | 0-0<br>G6-4-3<br>1-2f |                           | 0-0<br>6-3       |                        | 0-0<br>6-3      | 0-0<br>F2             |            |   | 5  | 1 | 1 | 0   | 0  | 0  | 1   |
| Don Buford, S<br>OBP: 0.308, SLG: 0.263<br>(1, 5)       | 1-0<br>E<br>1B<br>HBP | 0-0<br>F6             |                           | 0-0<br>6-3<br>2B |                        | 0-0<br>5-3      | 0-0<br>1-3            |            |   | 4  | 1 | 1 | 0   | 0  | 0  | 0   |
| Floyd Robinson, L<br>OBP: 0.455, SLG: 0.544<br>(1, 9)   | 0-0<br>E<br>1B        |                       | 0-0<br>HR                 | 0-0<br>6-3       |                        | 0-0<br>1B<br>1B |                       | 0-0<br>F7  |   | 5  | 2 | 3 | 2   | 0  | 0  | 1   |
| Ron Hansen, R<br>OBP: 0.375, SLG: 0.537<br>(1, 6)       | 0-0<br>F5             |                       | 0-0<br>F5                 | 0-0<br>F3        |                        | 0-0<br>1B       |                       | 0-0<br>5-3 |   | 5  | 0 | 1 | 0   | 0  | 0  | 3   |
| Tom McCraw, L<br>OBP: 0.333, SLG: 0.333<br>(1, 3)       | 0-0<br>HR<br>1B       |                       | 0-0<br>E<br>S<br>1B<br>1B |                  | 0-3<br>K               | 0-3<br>K        |                       | 0-0<br>1B  |   | 5  | 2 | 3 | 2   | 0  | 2  | 2   |
| Dave Nicholson, R<br>OBP: 0.397, SLG: 0.510<br>(1, 7)   | 0-0<br>HR             |                       | 4-0<br>E<br>1B<br>BB      |                  | 0-3<br>K               |                 | 0-0<br>1B<br>HR<br>1B | 0-3<br>K   |   | 4  | 3 | 2 | 2   | 1  | 2  | 1   |
| Al Weis, S<br>OBP: 0.362, SLG: 0.386<br>(1, 4)          | 0-0<br>F6             |                       | 0-0<br>1B                 |                  | 0-0<br>FC5<br>BB<br>1B |                 | 0-0<br>HR<br>1B       |            |   | 4  | 1 | 3 | 2   | 0  | 0  | 0   |
| J.C. Martin, L<br>OBP: 0.241, SLG: 0.214<br>(1, 2)      | 0-0<br>1B             |                       | 0-3<br>K                  |                  | 4-0<br>BB<br>1B        |                 | 0-0<br>F2             |            |   | 3  | 0 | 1 | 0   | 1  | 1  | 3   |
| Ray Herbert, R<br>OBP: 0.200, SLG: 0.200<br>(1, 1)      |                       | 0-0<br>G6-4-3<br>1B   | 0-3<br>K                  |                  | 0-0<br>FC5             |                 | 0-0<br>HR             |            |   | 3  | 0 | 1 | 0   | 0  | 1  | 3   |
| Minnie Minoso, R<br>OBP: 0.500, SLG: 1.000<br>(7, PH)   |                       |                       |                           |                  |                        |                 |                       |            |   | 1  | 1 | 1 | 3   | 0  | 0  | 0   |
| Eddie Fisher, R<br>(8, 1)                               |                       |                       |                           |                  |                        |                 |                       |            |   | 0  | 0 | 0 | 0   | 0  | 0  | 0   |

| Inning Stats | R: 5 | H: 5 | E: 1 | LOB: 1 | K: 0 | P: 8 | R: 0 | H: 1 | E: 0 | LOB: 0 | K: 0 | P: 3 | R: 3 | H: 3 | E: 1 | LOB: 1 | K: 2 | P: 10 | R: 0 | H: 1 | E: 0 | LOB: 1 | K: 0 | P: 4 | R: 0 | H: 2 | E: 0 | LOB: 2 | K: 2 | P: 12 | R: 0 | H: 2 | E: 0 | LOB: 2 | K: 1 | P: 7 | R: 3 | H: 3 | E: 0 | LOB: 0 | K: 0 | P: 6 | R: 0 | H: 1 | E: 0 | LOB: 1 | K: 1 | P: 6 |
|--------------|------|------|------|--------|------|------|------|------|------|--------|------|------|------|------|------|--------|------|-------|------|------|------|--------|------|------|------|------|------|--------|------|-------|------|------|------|--------|------|------|------|------|------|--------|------|------|------|------|------|--------|------|------|
|--------------|------|------|------|--------|------|------|------|------|------|--------|------|------|------|------|------|--------|------|-------|------|------|------|--------|------|------|------|------|------|--------|------|-------|------|------|------|--------|------|------|------|------|------|--------|------|------|------|------|------|--------|------|------|

| PITCHER                                     | IP  | WLS | BF | H | R | ER | SO | BB | IBB | HBP | BLK | WP | HR | S  | P  | ERA   | WHIP  |
|---|-----|-----|----|---|---|----|----|----|-----|-----|-----|----|----|----|----|-------|-------|
| Aurelio Monteagudo, R<br>ERA: 6.6<br>(1, 1) | 2.1 | L   | 15 | 8 | 8 | 7  | 0  | 1  | 0   | 0   | 0   | 0  | 2  | 13 | 18 | 27.00 | 3.857 |
| John O'Donoghue, L<br>ERA: 4.8<br>(3, 1)    | 2.2 |     | 12 | 3 | 0 | 0  | 4  | 1  | 0   | 0   | 0   | 0  | 0  | 19 | 23 | 0.00  | 1.500 |
| Ted Bowsfield, L<br>ERA: 7.11<br>(6, 1)     | 2.0 |     | 11 | 5 | 3 | 3  | 1  | 0  | 0   | 0   | 0   | 0  | 1  | 13 | 13 | 13.50 | 2.500 |
| John Wyatt, R<br>ERA: 1.5<br>(8, 1)         | 1.0 |     | 4  | 1 | 0 | 0  | 1  | 0  | 0   | 0   | 0   | 0  | 0  | 6  | 6  | 0.00  | 1.000 |

**BOTTOM**

**Kansas City Athletics @ Chicago White Sox**  
Comiskey Park, Chicago, IL  
Wed May 06 1964, 8:05 PM EDT  
Att. 14,707 - Unknown

|     |    |
|-----|----|
| AB  | 39 |
| R   | 11 |
| H   | 17 |
| RBI | 11 |
| BB  | 2  |
| SO  | 6  |
| LOB | 14 |



| 1B | 2B | 3B | HR | SF | SAC | DP | HBP | WP | HR | S | P | ERA  | WHIP  |
|----|----|----|----|----|-----|----|-----|----|----|---|---|------|-------|
| 13 | 1  | 0  | 3  | 0  | 1   | 1  | 3   | 0  | 0  | 0 | 0 | 0.00 | 1.500 |
| 0  | 0  | 0  | 0  | 0  | 0   | 0  | 0   | 0  | 0  | 0 | 0 | 0.00 | 1.000 |
| 0  | 0  | 0  | 0  | 0  | 0   | 0  | 0   | 0  | 0  | 0 | 0 | 0.00 | 1.000 |

| Batter  | 1                              | 2                                 | 3                             | 4                          | 5         | 6         | 7                | 8         | 9                | 10               | AB | R | H | RBI | BB | SO | LOB |
|---|--------------------------------|-----------------------------------|-------------------------------|----------------------------|-----------|-----------|------------------|-----------|------------------|------------------|----|---|---|-----|----|----|-----|
| Wayne Causey, L (1, 6)<br>OBP: 0.432, SLG: 0.319    | 0-0<br>SH5-3<br>2B<br>1B       | 0-0<br>SH5-4<br>1-2<br>2-3        |                               | 0-0<br>FC4-6<br>1B         |           | 0-0<br>F8 |                  | 0-0<br>F8 |                  | 4-0<br>HBP<br>BB | 4  | 1 | 2 | 0   | 1  | 0  | 2   |
| Dick Green, R (1, 4)<br>OBP: 0.237, SLG: 0.319      | 0-0<br>SH5-3<br>1-2            | 0-0<br>G4-6-3<br>1B<br>2-H<br>3-H |                               | 0-0<br>FC4-6<br>CS<br>1-2f |           |           | 0-0<br>F9        |           | 0-0<br>4-3       | 1-0<br>HBP       | 4  | 0 | 1 | 2   | 0  | 0  | 1   |
| Ed Charles, R (1, 5)<br>OBP: 0.360, SLG: 0.434      | 4-0<br>BB<br>2B<br>BB          | 0-0<br>G4-6-3<br>1-2f             |                               | 0-3<br>K<br>1-2            |           |           | 0-0<br>1-3       |           | 4-0<br>2B<br>BB  | 0-0<br>F8        | 4  | 1 | 0 | 0   | 2  | 1  | 4   |
| Rocky Colavito, R (1, 9)<br>OBP: 0.400, SLG: 0.667  | 0-3<br>K                       |                                   | 0-0<br>F6                     |                            | 0-0<br>F5 |           | 4-0<br>BB<br>BB  |           | 0-0<br>2B<br>1-H |                  | 4  | 0 | 1 | 0   | 1  | 1  | 2   |
| Jim Gentile, L (1, 3)<br>OBP: 0.421, SLG: 0.610     | 4-0<br>2B<br>BB<br>1-2<br>2-3  |                                   | 4-0<br>BB<br>1B<br>BB         |                            | 0-0<br>G3 |           | 4-0<br>BB<br>1-2 |           | 4-0<br>IBB       |                  | 1  | 1 | 0 | 0   | 4  | 0  | 0   |
| Nelson Mathews, R (1, 8)<br>OBP: 0.361, SLG: 0.480  | 0-0<br>1-H<br>2-H<br>3-H<br>2B |                                   | 0-3<br>K                      |                            | 0-3<br>K  |           | 0-0<br>F2        |           | 0-3<br>K         |                  | 5  | 0 | 1 | 3   | 0  | 3  | 5   |
| Doc Edwards, R (1, 2)<br>OBP: 0.250, SLG: 0.237     | 0-0<br>6-3                     |                                   | 0-0<br>BB<br>1B<br>1-2        |                            | 0-3<br>K  |           | 0-3<br>K         |           | 0-3<br>K         |                  | 4  | 0 | 1 | 0   | 0  | 2  | 1   |
| Charlie Lau, L (10, PH)<br>OBP: 0.351, SLG: 0.559   |                                |                                   |                               |                            |           |           |                  |           |                  | 0-0<br>HR        | 1  | 1 | 1 | 1   | 0  | 0  | 0   |
| Tommy Reynolds, R (1, 7)<br>OBP: 0.317, SLG: 0.327  |                                | 4-0<br>SH5-4<br>1B<br>BB          | 4-0<br>BB<br>1B<br>1-2<br>2-3 |                            | 0-3<br>K  |           | 0-3<br>K         |           | 0-0<br>1B        | 0-0<br>F9        | 3  | 1 | 1 | 0   | 2  | 1  | 0   |
| Diego Segui, R (1, 1)<br>OBP: 0.300, SLG: 0.600     |                                | 0-0<br>SH5-4<br>1B<br>1B          | 0-3<br>K                      |                            | 0-0<br>1B |           | 0-3<br>K         |           | 0-3<br>K         | 0-3<br>K         | 0  | 0 | 0 | 0   | 0  | 0  | 0   |
| Dave Duncan, R (2, PH)<br>OBP: 1.000, SLG: 1.000    |                                |                                   |                               |                            |           |           |                  |           |                  |                  | 1  | 1 | 1 | 0   | 0  | 0  | 0   |
| Vern Handrahan, L (2, 1)                            |                                |                                   |                               |                            |           |           |                  |           |                  |                  | 1  | 0 | 0 | 0   | 0  | 1  | 3   |
| Jack Aker, R (3, 1)                                 |                                |                                   |                               |                            |           |           |                  |           |                  |                  | 0  | 0 | 0 | 0   | 0  | 0  | 0   |
| John O'Donoghue, R (4, 1)<br>OBP: 0.500, SLG: 0.500 |                                |                                   |                               |                            |           |           |                  |           |                  |                  | 1  | 0 | 1 | 0   | 0  | 0  | 0   |
| George Alusik, R (6, PH)                            |                                |                                   |                               |                            |           |           |                  |           |                  |                  | 1  | 0 | 0 | 0   | 0  | 1  | 1   |
| John Wyatt, R (8, 1)                                |                                |                                   |                               |                            |           |           |                  |           |                  |                  | 1  | 0 | 0 | 0   | 0  | 1  | 0   |

livebaseballscores.com

|     |    |
|-----|----|
| AB  | 35 |
| R   | 6  |
| H   | 10 |
| RBI | 6  |
| BB  | 10 |
| SO  | 11 |
| LOB | 19 |



| Inning Stats                         | R: 3 | H: 2 | E: 0 | LOB: 1 | K: 1 | S: 7 | P: 15 | R: 2 | H: 2 | E: 0 | LOB: 0 | K: 0 | S: 4 | P: 8 | R: 0 | H: 1  | E: 0  | LOB: 3 | K: 2 | S: 8 | P: 16 | R: 0 | H: 1 | E: 0 | LOB: 0 | K: 1 | S: 5 | P: 5 | R: 0 | H: 0 | E: 0 | LOB: 0 | K: 1 | S: 5 | P: 5 | R: 0 | H: 1 | E: 0 | LOB: 1 | K: 2 | S: 8 | P: 8 | R: 0 | H: 0 | E: 0 | LOB: 2 | K: 0 | S: 3 | P: 11 | R: 0 | H: 1 | E: 0 | LOB: 1 | K: 2 | S: 8 | P: 8 | R: 0 | H: 1 | E: 0 | LOB: 2 | K: 1 | S: 5 | P: 13 | R: 1 | H: 1 | E: 0 | LOB: 2 | K: 1 | S: 6 | P: 11 | 1B: 7 | SF: 0 | 2B: 2 | SAC: 2 | 3B: 0 | DP: 1 | HR: 1 | HBP: 1 | WP: 0 | PA: 48 |
|--------------------------------------|------|------|------|--------|------|------|-------|------|------|------|--------|------|------|------|------|-------|-------|--------|------|------|-------|------|------|------|--------|------|------|------|------|------|------|--------|------|------|------|------|------|------|--------|------|------|------|------|------|------|--------|------|------|-------|------|------|------|--------|------|------|------|------|------|------|--------|------|------|-------|------|------|------|--------|------|------|-------|-------|-------|-------|--------|-------|-------|-------|--------|-------|--------|
| PITCHER                              | IP   | WLS  | BF   | H      | R    | ER   | SO    | BB   | IBB  | HBP  | BLK    | WP   | HR   | S    | P    | ERA   | WHIP  |        |      |      |       |      |      |      |        |      |      |      |      |      |      |        |      |      |      |      |      |      |        |      |      |      |      |      |      |        |      |      |       |      |      |      |        |      |      |      |      |      |      |        |      |      |       |      |      |      |        |      |      |       |       |       |       |        |       |       |       |        |       |        |
| Gerry Arrigo, L (1, 1)<br>ERA: 5.84  | 1.1  |      | 10   | 3      | 5    | 5    | 1     | 3    | 0    | 0    | 0      | 0    | 0    | 9    | 21   | 33.75 | 4.500 |        |      |      |       |      |      |      |        |      |      |      |      |      |      |        |      |      |      |      |      |      |        |      |      |      |      |      |      |        |      |      |       |      |      |      |        |      |      |      |      |      |      |        |      |      |       |      |      |      |        |      |      |       |       |       |       |        |       |       |       |        |       |        |
| Jim Perry, R (2, 1)<br>ERA: 3.72     | 0.2  |      | 2    | 1      | 0    | 0    | 0     | 0    | 0    | 0    | 0      | 0    | 0    | 2    | 2    | 0.00  | 1.500 |        |      |      |       |      |      |      |        |      |      |      |      |      |      |        |      |      |      |      |      |      |        |      |      |      |      |      |      |        |      |      |       |      |      |      |        |      |      |      |      |      |      |        |      |      |       |      |      |      |        |      |      |       |       |       |       |        |       |       |       |        |       |        |
| Dwight Siebler, R (3, 1)<br>ERA: 9.0 | 2.0  |      | 9    | 2      | 0    | 0    | 3     | 2    | 0    | 0    | 0      | 0    | 0    | 13   | 21   | 0.00  | 2.000 |        |      |      |       |      |      |      |        |      |      |      |      |      |      |        |      |      |      |      |      |      |        |      |      |      |      |      |      |        |      |      |       |      |      |      |        |      |      |      |      |      |      |        |      |      |       |      |      |      |        |      |      |       |       |       |       |        |       |       |       |        |       |        |
| Dick Stigman, L (5, 1)<br>ERA: 6.75  | 4.0  |      | 16   | 2      | 0    | 0    | 5     | 2    | 0    | 0    | 0      | 0    | 0    | 24   | 32   | 0.00  | 1.000 |        |      |      |       |      |      |      |        |      |      |      |      |      |      |        |      |      |      |      |      |      |        |      |      |      |      |      |      |        |      |      |       |      |      |      |        |      |      |      |      |      |      |        |      |      |       |      |      |      |        |      |      |       |       |       |       |        |       |       |       |        |       |        |
| Bill Dailey, R (9, 1)<br>ERA: 4.5    | 2.0  | L    | 11   | 2      | 1    | 1    | 2     | 2    | 1    | 1    | 0      | 0    | 0    | 11   | 24   | 4.50  | 2.000 |        |      |      |       |      |      |      |        |      |      |      |      |      |      |        |      |      |      |      |      |      |        |      |      |      |      |      |      |        |      |      |       |      |      |      |        |      |      |      |      |      |      |        |      |      |       |      |      |      |        |      |      |       |       |       |       |        |       |       |       |        |       |        |

BOTTOM

Kansas City Athletics @ Minnesota Twins  
Metropolitan Stadium, Bloomington, MI

Fri May 08 1964, 8:05 PM EDT  
Att. 8,519 - Unknown

livebaseballscores.com

|     |    |
|-----|----|
| AB  | 33 |
| R   | 5  |
| H   | 5  |
| RBI | 5  |
| BB  | 11 |
| SO  | 1  |
| LOB | 20 |



|    |   |    |    |
|----|---|----|----|
| WP | 1 | PA | 45 |
| PB | 0 |    |    |
| SB | 0 |    |    |
| CS | 0 |    |    |

|    |   |   |     |    |    |     |
|----|---|---|-----|----|----|-----|
| AB | R | H | RBI | BB | SO | LOB |
| 4  | 1 | 0 | 1   | 1  | 1  | 4   |

|   |   |   |   |   |   |   |
|---|---|---|---|---|---|---|
| 4 | 0 | 2 | 1 | 0 | 0 | 0 |
|---|---|---|---|---|---|---|

|   |   |   |   |   |   |   |
|---|---|---|---|---|---|---|
| 5 | 0 | 0 | 0 | 0 | 0 | 4 |
|---|---|---|---|---|---|---|

|   |   |   |   |   |   |   |
|---|---|---|---|---|---|---|
| 3 | 1 | 1 | 3 | 2 | 0 | 0 |
|---|---|---|---|---|---|---|

|   |   |   |   |   |   |   |
|---|---|---|---|---|---|---|
| 4 | 0 | 0 | 0 | 1 | 0 | 2 |
|---|---|---|---|---|---|---|

|   |   |   |   |   |   |   |
|---|---|---|---|---|---|---|
| 4 | 0 | 0 | 0 | 1 | 0 | 3 |
|---|---|---|---|---|---|---|

|   |   |   |   |   |   |   |
|---|---|---|---|---|---|---|
| 2 | 1 | 1 | 0 | 3 | 0 | 0 |
|---|---|---|---|---|---|---|

|   |   |   |   |   |   |   |
|---|---|---|---|---|---|---|
| 1 | 0 | 0 | 0 | 0 | 0 | 2 |
| 3 | 1 | 1 | 0 | 1 | 0 | 2 |

|   |   |   |   |   |   |   |
|---|---|---|---|---|---|---|
| 0 | 0 | 0 | 0 | 0 | 0 | 0 |
| 1 | 0 | 0 | 0 | 0 | 0 | 2 |
| 0 | 0 | 0 | 0 | 0 | 0 | 0 |
| 0 | 1 | 0 | 0 | 1 | 0 | 0 |
| 0 | 0 | 0 | 0 | 0 | 1 | 0 |
| 1 | 0 | 0 | 0 | 0 | 0 | 0 |
| 0 | 0 | 0 | 0 | 0 | 0 | 0 |
| 1 | 0 | 0 | 0 | 0 | 0 | 0 |
| 0 | 0 | 0 | 0 | 0 | 0 | 1 |

|    |   |     |   |
|----|---|-----|---|
| 1B | 2 | SF  | 1 |
| 2B | 1 | SAC | 0 |
| 3B | 1 | DP  | 1 |
| HR | 1 | HBP | 0 |

| Batter   | 1        | 2   | 3            | 4         | 5   | 6           | 7 | 8   | 9 | 10 |
|--|----------|-----|--------------|-----------|-----|-------------|---|-----|---|----|
| <b>Rich Rollins, R</b><br>OBP: 0.360, SLG: 0.451 (1, 5)            | F5       | 4-3 |              | HR<br>BB  | K   |             |   | 6-3 |   |    |
| <b>Tony Oliva, L</b><br>OBP: 0.460, SLG: 0.774 (1, 9)              | WP<br>2B |     | G1-2-3<br>1B | SF7       |     | 4-3         |   | 4-3 |   |    |
| <b>Bob Allison, R</b><br>OBP: 0.427, SLG: 0.621 (1, 3)             | L3       |     | F8           | F9        |     | F9          |   | F5  |   |    |
| <b>Jimmie Hall, L</b><br>OBP: 0.408, SLG: 0.667 (1, 8)             | BB       |     | BB           | HR        |     | F7          |   | 3-1 |   |    |
| <b>Harmon Killebrew, R</b><br>OBP: 0.255, SLG: 0.321 (1, 7)        | 6-3      |     | BB           | 1-3       |     | 1-3         |   | F5  |   |    |
| <b>Earl Battey, R</b><br>OBP: 0.324, SLG: 0.393 (1, 2)             |          |     | G1-2-3       | F8        |     | F8          |   | 6-3 |   |    |
| <b>Zoilo Versalles, R</b><br>OBP: 0.341, SLG: 0.380 (1, 6)         |          |     | F7<br>BB     | BB<br>BB  | 5-3 | FC6-4<br>BB |   | 3B  |   |    |
| <b>Bud Bloomfield, R</b><br>OBP: 0.200, SLG: 0.200 (1, 4)          |          |     | F7           | BB<br>BB  | BB  | FC6-4       |   | F4  |   |    |
| <b>Johnny Goryl, R</b><br>OBP: 0.316, SLG: 0.235 (4, PH)<br>(5, 4) |          |     | 1-2<br>2-3   | SF7<br>BB | 1B  | 1-2f        |   |     |   |    |
| <b>Gerry Arrigo, L</b><br>OBP: 0.117, SLG: 0.117 (1, 1)            |          |     | F4           | HR<br>BB  | BB  |             |   | F7  |   |    |
| <b>Jim Pardy, S</b><br>OBP: 0.000, SLG: 0.000 (1, 1)               |          |     |              |           |     |             |   |     |   |    |
| <b>Don Metzger, L</b><br>OBP: 0.000, SLG: 0.000 (1, 1)             |          |     |              |           |     |             |   |     |   |    |
| <b>Dwight Gooden, R</b><br>OBP: 0.000, SLG: 0.000 (1, 1)           |          |     |              |           |     |             |   |     |   |    |
| <b>Lenny Green, L</b><br>OBP: 0.000, SLG: 0.000 (1, 1)             |          |     |              |           |     |             |   |     |   |    |
| <b>Dick Stigman, R</b><br>OBP: 0.000, SLG: 0.000 (1, 1)            |          |     |              |           |     |             |   |     |   |    |
| <b>Vic Power, R</b><br>OBP: 0.000, SLG: 0.000 (1, 1)               |          |     |              |           |     |             |   |     |   |    |
| <b>Bill Chaffin, R</b><br>OBP: 0.000, SLG: 0.000 (1, 1)            |          |     |              |           |     |             |   |     |   |    |
| <b>Bernie Allen, L</b><br>OBP: 0.000, SLG: 0.000 (1, 1)            |          |     |              |           |     |             |   |     |   |    |

| Inning Stats | R: 0 | H: 1 | E: 0 | K: 0 | S: 4 | P: 8 | R: 0 | H: 0 | E: 0 | K: 0 | S: 3 | P: 11 | R: 0 | H: 1 | E: 0 | K: 0 | S: 3 | P: 11 | R: 5 | H: 1 | E: 0 | K: 0 | S: 4 | P: 20 | R: 0 | H: 1 | E: 0 | K: 1 | S: 6 | P: 10 | R: 0 | H: 0 | E: 0 | K: 0 | S: 3 | P: 3 | R: 0 | H: 0 | E: 0 | K: 0 | S: 3 | P: 7 | R: 0 | H: 0 | E: 0 | K: 0 | S: 3 | P: 3 | R: 0 | H: 0 | E: 0 | K: 0 | S: 3 | P: 3 | R: 0 | H: 1 | E: 0 | K: 0 | S: 4 | P: 4 | 1B: 2 | SF: 1 | 2B: 1 | SAC: 0 | 3B: 1 | DP: 1 | HR: 1 | HBP: 0 | WP: 1 | PA: 45 |
|--------------|------|------|------|------|------|------|------|------|------|------|------|-------|------|------|------|------|------|-------|------|------|------|------|------|-------|------|------|------|------|------|-------|------|------|------|------|------|------|------|------|------|------|------|------|------|------|------|------|------|------|------|------|------|------|------|------|------|------|------|------|------|------|-------|-------|-------|--------|-------|-------|-------|--------|-------|--------|
|--------------|------|------|------|------|------|------|------|------|------|------|------|-------|------|------|------|------|------|-------|------|------|------|------|------|-------|------|------|------|------|------|-------|------|------|------|------|------|------|------|------|------|------|------|------|------|------|------|------|------|------|------|------|------|------|------|------|------|------|------|------|------|------|-------|-------|-------|--------|-------|-------|-------|--------|-------|--------|

| PITCHER                                       | IP  | WLS | BF | H | R | ER | SO | BB | IBB | HBP | BLK | WP | HR | S  | P  | ERA   | WHIP  |
|---|-----|-----|----|---|---|----|----|----|-----|-----|-----|----|----|----|----|-------|-------|
| <b>Diego Segui, R</b><br>ERA: 4.4 (1, 1)      | 1.0 |     | 5  | 1 | 0 | 0  | 0  | 1  | 0   | 0   | 0   | 1  | 0  | 4  | 8  | 0.00  | 2.000 |
| <b>Vern Handrahan, R</b><br>ERA: 5.91 (2, 1)  | 1.1 |     | 9  | 1 | 0 | 0  | 0  | 4  | 0   | 0   | 0   | 0  | 0  | 5  | 21 | 0.00  | 3.750 |
| <b>Jack Aker, R</b><br>ERA: 12.6 (3, 1)       | 0.2 |     | 5  | 0 | 4 | 4  | 0  | 4  | 0   | 0   | 0   | 0  | 0  | 1  | 17 | 54.00 | 6.000 |
| <b>John O'Donoghue, L</b><br>ERA: 4.26 (4, 1) | 4.0 |     | 16 | 2 | 1 | 1  | 1  | 2  | 0   | 0   | 0   | 0  | 1  | 16 | 24 | 2.25  | 1.000 |
| <b>John Wyatt, R</b><br>ERA: 1.2 (8, 1)       | 3.0 | W   | 10 | 1 | 0 | 0  | 0  | 0  | 0   | 0   | 0   | 0  | 0  | 10 | 10 | 0.00  | 0.333 |

| Batter   | 1   | 2                               | 3                                 | 4                                | 5                            | 6                                | 7                            | 8                                | 9                            | AB R H RBI BB SO LOB            | TOP                          |                                 |                              |                                 |                              |                                 |                              |                                  |                                  |                                    |                                  |        |  |  |  |
|--|---|---------------------------------|-----------------------------------|----------------------------------|------------------------------|----------------------------------|------------------------------|----------------------------------|------------------------------|---------------------------------|------------------------------|---------------------------------|------------------------------|---------------------------------|------------------------------|---------------------------------|------------------------------|----------------------------------|----------------------------------|------------------------------------|----------------------------------|--------|--|--|--|
| Wayne Causey, L (1, 6)<br>OBP: 0.430, SLG: 0.356   | 0-0<br>3-1  |                                 | 0-0<br>HR                         | 4-0<br>1B<br>BB                  | 0-0<br>4-3                   |                                  |                              | 0-0<br>G4-6-3<br>1-2f            |                              | 4 2 1 1 1 0 1                   |                              |                                 |                              |                                 |                              |                                 |                              |                                  |                                  |                                    |                                  |        |  |  |  |
| Dick Green, R (1, 4)<br>OBP: 0.238, SLG: 0.307     | 0-3<br>K2-3   |                                 | 4-0<br>FC3-6<br>HR<br>BB          | 0-0<br>SH2-4                     |                              | 0-3<br>K                         |                              | 0-0<br>F8                        |                              | 3 1 0 0 1 2 0                   |                              |                                 |                              |                                 |                              |                                 |                              |                                  |                                  |                                    |                                  |        |  |  |  |
| Ed Charles, R (1, 5)<br>OBP: 0.363, SLG: 0.418     | 0-0<br>F7   |                                 | 4-0<br>FC3-6<br>BB                | 0-0<br>6-3                       |                              | 0-3<br>K                         |                              | 4-0<br>2B<br>BB                  |                              | 3 1 0 0 2 1 1                   |                              |                                 |                              |                                 |                              |                                 |                              |                                  |                                  |                                    |                                  |        |  |  |  |
| Jim Gentile, L (1, 3)<br>OBP: 0.420, SLG: 0.587    |   | 4-0<br>BB<br>E<br>BB            | 0-0<br>FC3-6<br>HR<br>1-2f<br>2-3 | 0-0<br>HR<br>1B                  |                              | 0-3<br>K                         |                              | 0-3<br>K                         |                              | 4 2 1 1 1 2 3                   |                              |                                 |                              |                                 |                              |                                 |                              |                                  |                                  |                                    |                                  |        |  |  |  |
| Rocky Colavito, R (1, 9)<br>OBP: 0.400, SLG: 0.704 | 0-0<br>E5<br>BB<br>1-2                                |                                 | 0-3<br>K                          | 0-0<br>HR                        |                              | 0-0<br>5-3                       |                              | 0-0<br>2B<br>1-H                 |                              | 5 1 2 3 0 1 3                   |                              |                                 |                              |                                 |                              |                                 |                              |                                  |                                  |                                    |                                  |        |  |  |  |
| Manny Jimenez, L (1, 7)<br>OBP: 0.286, SLG: 0.722  | 0-0<br>F6   |                                 | 0-0<br>HR<br>1-H<br>3-H           | 4-0<br>BB                        |                              | 0-0<br>4-3                       |                              | 0-3<br>K                         |                              | 4 1 1 3 1 1 3                   |                              |                                 |                              |                                 |                              |                                 |                              |                                  |                                  |                                    |                                  |        |  |  |  |
| Charlie Lau, L (1, 2)<br>OBP: 0.341, SLG: 0.514    | 0-3<br>K  |                                 | 4-0<br>BB<br>BB                   | 0-0<br>F9                        |                              | 0-3<br>K                         |                              |                                  |                              | 3 0 0 0 1 2 3                   |                              |                                 |                              |                                 |                              |                                 |                              |                                  |                                  |                                    |                                  |        |  |  |  |
| Nelson Mathews, R (1, 8)<br>OBP: 0.368, SLG: 0.468 | 4-0<br>1-2<br>2-3<br>BB                               |                                 | 4-0<br>BB<br>BB                   |                                  | 0-0<br>F5                    |                                  | 0-3<br>K                     |                                  |                              | 2 0 0 0 2 1 0                   |                              |                                 |                              |                                 |                              |                                 |                              |                                  |                                  |                                    |                                  |        |  |  |  |
| Orlando Pena, R (1, 1)<br>OBP: 0.105, SLG: 0.056   | 0-0<br>5-3  |                                 | 0-3<br>K                          |                                  | 0-3<br>K                     |                                  | 4-0<br>G4-6-3<br>BB          |                                  |                              | 3 0 0 0 0 2 5                   |                              |                                 |                              |                                 |                              |                                 |                              |                                  |                                  |                                    |                                  |        |  |  |  |
| Jack Aker, R (6, 1)                                |   |                                 |                                   |                                  |                              |                                  |                              |                                  |                              | 0 0 0 0 0 0 0                   |                              |                                 |                              |                                 |                              |                                 |                              |                                  |                                  |                                    |                                  |        |  |  |  |
| Joe Grzenda, R (7, 1)                              |   |                                 |                                   |                                  |                              |                                  |                              |                                  |                              | 0 0 0 0 0 0 0                   |                              |                                 |                              |                                 |                              |                                 |                              |                                  |                                  |                                    |                                  |        |  |  |  |
| George Alusik, R (8, PH)                           |   |                                 |                                   |                                  |                              |                                  |                              |                                  |                              | 0 0 0 0 1 0 0                   |                              |                                 |                              |                                 |                              |                                 |                              |                                  |                                  |                                    |                                  |        |  |  |  |
| Vern Handrahan, L (8, 1)                           |   |                                 |                                   |                                  |                              |                                  |                              |                                  |                              | 0 0 0 0 0 0 0                   |                              |                                 |                              |                                 |                              |                                 |                              |                                  |                                  |                                    |                                  |        |  |  |  |
| <b>Inning Stats</b>                                | R: 0<br>E: 0<br>K: 1<br>S: 5                          | H: 0<br>LOB: 0<br>BB: 0<br>P: 5 | R: 0<br>E: 1<br>K: 1<br>S: 6      | H: 0<br>LOB: 3<br>BB: 2<br>P: 14 | R: 4<br>E: 0<br>K: 2<br>S: 9 | H: 2<br>LOB: 2<br>BB: 4<br>P: 25 | R: 3<br>E: 0<br>K: 0<br>S: 5 | H: 2<br>LOB: 1<br>BB: 2<br>P: 13 | R: 0<br>E: 0<br>K: 1<br>S: 5 | H: 0<br>LOB: 0<br>BB: 0<br>P: 5 | R: 0<br>E: 0<br>K: 3<br>S: 9 | H: 0<br>LOB: 0<br>BB: 0<br>P: 9 | R: 0<br>E: 0<br>K: 1<br>S: 5 | H: 0<br>LOB: 0<br>BB: 0<br>P: 5 | R: 0<br>E: 0<br>K: 1<br>S: 4 | H: 0<br>LOB: 0<br>BB: 1<br>P: 8 | R: 1<br>E: 0<br>K: 2<br>S: 8 | H: 1<br>LOB: 1<br>BB: 1<br>P: 12 | 1B: 1<br>2B: 1<br>3B: 0<br>HR: 3 | SF: 0<br>SAC: 1<br>DP: 1<br>HBP: 0 | WP: 0<br>PB: 0<br>SB: 0<br>CS: 0 | PA: 42 |  |  |  |
| <b>PITCHER</b>                                     | IP WLS BF H R ER SO BB IBB HBP BLK WP HR S P ERA WHIP |                                 |                                   |                                  |                              |                                  |                              |                                  |                              |                                 |                              |                                 |                              |                                 |                              |                                 |                              |                                  |                                  |                                    |                                  |        |  |  |  |
| Lee Stange, R (1, 1)<br>ERA: 6.75                  | 2.2   |                                 | 15                                | 2                                | 4                            | 4                                | 3                            | 4                                | 0                            | 0                               | 0                            | 0                               | 2                            | 17                              | 33                           | 13.50                           | 2.250                        |                                  |                                  |                                    |                                  |        |  |  |  |
| Jim Roland, L (3, 1)<br>ERA: 3.91                  | 0.0   |                                 | 2                                 | 0                                | 0                            | 0                                | 0                            | 2                                | 0                            | 0                               | 0                            | 0                               | 0                            | 0                               | 8                            | ∞                               | ∞                            |                                  |                                  |                                    |                                  |        |  |  |  |
| Bill Fischer, R (3, 1)<br>ERA: 7.11                | 2.1   |                                 | 11                                | 2                                | 3                            | 3                                | 2                            | 2                                | 0                            | 0                               | 0                            | 0                               | 1                            | 13                              | 21                           | 11.57                           | 1.714                        |                                  |                                  |                                    |                                  |        |  |  |  |
| Gerry Arrigo, L (6, 1)<br>ERA: 4.96                | 4.0   | W                               | 14                                | 1                                | 1                            | 1                                | 7                            | 2                                | 0                            | 0                               | 0                            | 0                               | 0                            | 26                              | 34                           | 2.25                            | 0.750                        |                                  |                                  |                                    |                                  |        |  |  |  |

Kansas City Athletics @ Minnesota Twins  
Metropolitan Stadium, Bloomington, MI  
Sat May 09 1964, 4:33 AM EDT  
Att. 9,219 - Unknown

|     |    |
|-----|----|
| AB  | 31 |
| R   | 8  |
| H   | 5  |
| RBI | 8  |
| BB  | 10 |
| SO  | 12 |
| LOB | 19 |



|       |        |
|-------|--------|
| WP: 0 | PA: 42 |
| PB: 0 |        |
| SB: 0 |        |
| CS: 0 |        |

| PITCHER         | IP  | WLS | BF | H | R | ER | SO | BB | IBB | HBP | BLK | WP | HR | S  | P  | ERA   | WHIP  |
|-----------------|-----|-----|----|---|---|----|----|----|-----|-----|-----|----|----|----|----|-------|-------|
| Lee Stange, R   | 2.2 |     | 15 | 2 | 4 | 4  | 3  | 4  | 0   | 0   | 0   | 0  | 2  | 17 | 33 | 13.50 | 2.250 |
| Jim Roland, L   | 0.0 |     | 2  | 0 | 0 | 0  | 0  | 2  | 0   | 0   | 0   | 0  | 0  | 0  | 8  | ∞     | ∞     |
| Bill Fischer, R | 2.1 |     | 11 | 2 | 3 | 3  | 2  | 2  | 0   | 0   | 0   | 0  | 1  | 13 | 21 | 11.57 | 1.714 |
| Gerry Arrigo, L | 4.0 | W   | 14 | 1 | 1 | 1  | 7  | 2  | 0   | 0   | 0   | 0  | 0  | 26 | 34 | 2.25  | 0.750 |



| Batter   | 1                | 2          | 3                     | 4                     | 5          | 6                     | 7                | 8                          | 9 |
|--|------------------|------------|-----------------------|-----------------------|------------|-----------------------|------------------|----------------------------|---|
| Zoilo Versalles, R<br>OBP: 0.354, SLG: 0.386<br>(1, 6)   | 0-0<br>HR<br>1B  |            | 0-0<br>G5-4-3<br>1B   |                       | 0-0<br>5-3 |                       | 4-0<br>2B<br>BB  | 0-0<br>F9                  |   |
| Rich Rollins, R<br>OBP: 0.362, SLG: 0.474<br>Bud Bloomfield, R<br>OBP: 0.200, SLG: 0.200<br>(1, 5)<br>(9, 4)   | 0-0<br>HR<br>1-2 |            | 0-0<br>G5-4-3<br>1-2f |                       | 0-0<br>F8  |                       | 0-3<br>K         | 1-0<br>FC4-8<br>HBP        |   |
| Tony Oliva, L<br>OBP: 0.457, SLG: 0.755<br>(1, 9)  | 0-0<br>BB<br>1B  |            | 0-0<br>F9             |                       |            | 0-0<br>1B<br>HR<br>1B | 0-0<br>E6<br>2B  | 0-0<br>FC4-6<br>1B<br>1-2f |   |
| Jimmie Hall, L<br>OBP: 0.420, SLG: 0.701<br>(1, 8)   | 0-3<br>K         |            |                       | 0-0<br>HR             |            | 0-0<br>F8             | 4-0<br>2B<br>IBB | 0-0<br>1B                  |   |
| Bob Allison, R<br>OBP: 0.448, SLG: 0.686<br>(1, 7)   | 4-0<br>BB        |            |                       | 0-0<br>HR             |            | 0-0<br>HR<br>1B       | 0-0<br>1B<br>2B  | 0-0<br>F6                  |   |
| Don Mincher, L<br>OBP: 0.355, SLG: 0.643<br>Vic Power, R<br>OBP: 0.160, SLG: 0.167<br>(1, 3)<br>(7, PH)<br>(8, 3)  | 0-0<br>4-3       |            |                       | 0-0<br>4-3            |            | 0-0<br>HR             | 0-0<br>F4        |                            |   |
| Earl Battey, R<br>OBP: 0.333, SLG: 0.400<br>(1, 2)   |                  | 0-0<br>F8  |                       | 0-0<br>G6-4-3<br>1B   |            | 0-0<br>5-3            | 0-0<br>WP<br>1B  |                            |   |
| Johnny Goryl, R<br>OBP: 0.348, SLG: 0.250<br>(1, 4)<br>(9, 5)  |                  | 0-0<br>6-3 |                       | 0-0<br>G6-4-3<br>1-2f |            | 0-0<br>PB<br>1B       | 4-0<br>1-2<br>BB |                            |   |
| Lee Stange, R<br>OBP: 0.273, SLG: 0.111<br>Jim Roland, R<br>OBP: 0.125, SLG: 0.125<br>Bill Fischer, R<br>Bernie Allen, L<br>OBP: 0.282, SLG: 0.322<br>Gerry Arrigo, L<br>(1, 1)<br>(3, 1)<br>(3, 1)<br>(5, PH)<br>(6, 1) |                  | 0-0<br>6-3 |                       |                       | 0-3<br>K   | 0-0<br>4-3            | 0-0<br>F6        |                            |   |

| Inning Stats | R: 1<br>E: 0<br>K: 1<br>S: 7 | H: 3<br>LOB: 2<br>BB: 1<br>P: 11 | R: 0<br>E: 0<br>K: 0<br>S: 3 | H: 0<br>LOB: 0<br>BB: 0<br>P: 3 | R: 0<br>E: 0<br>K: 0<br>S: 3 | H: 1<br>LOB: 0<br>BB: 0<br>P: 3 | R: 2<br>E: 0<br>K: 0<br>S: 5 | H: 3<br>LOB: 0<br>BB: 0<br>P: 5 | R: 0<br>E: 0<br>K: 1<br>S: 5 | H: 0<br>LOB: 0<br>BB: 0<br>P: 5 | R: 3<br>E: 0<br>K: 0<br>S: 7 | H: 4<br>LOB: 1<br>BB: 0<br>P: 7 | R: 4<br>E: 1<br>K: 1<br>S: 8 | H: 2<br>LOB: 2<br>BB: 3<br>P: 20 | R: 0<br>E: 0<br>K: 0<br>S: 4 | H: 1<br>LOB: 2<br>BB: 0<br>P: 5 |
|--------------|------------------------------|----------------------------------|------------------------------|---------------------------------|------------------------------|---------------------------------|------------------------------|---------------------------------|------------------------------|---------------------------------|------------------------------|---------------------------------|------------------------------|----------------------------------|------------------------------|---------------------------------|
|--------------|------------------------------|----------------------------------|------------------------------|---------------------------------|------------------------------|---------------------------------|------------------------------|---------------------------------|------------------------------|---------------------------------|------------------------------|---------------------------------|------------------------------|----------------------------------|------------------------------|---------------------------------|

| PITCHER                                 | IP  | WLS | BF | H  | R | ER | SO | BB | IBB | HBP | BLK | WP | HR | S  | P  | ERA   | WHIP  |
|---|-----|-----|----|----|---|----|----|----|-----|-----|-----|----|----|----|----|-------|-------|
| Orlando Pena, R<br>ERA: 4.12<br>(1, 1)  | 5.1 |     | 24 | 10 | 6 | 6  | 2  | 1  | 0   | 0   | 0   | 0  | 4  | 27 | 31 | 10.12 | 2.062 |
| Jack Aker, R<br>ERA: 13.5<br>(6, 1)     | 1.0 | L   | 8  | 2  | 4 | 2  | 1  | 1  | 1   | 0   | 0   | 0  | 0  | 8  | 16 | 18.00 | 3.000 |
| Joe Grzenda, L<br>ERA:<br>(7, 1)        | 0.2 |     | 4  | 1  | 0 | 0  | 0  | 1  | 0   | 0   | 0   | 1  | 0  | 3  | 7  | 0.00  | 3.000 |
| Vern Handrahan, R<br>ERA: 5.4<br>(8, 1) | 1.0 |     | 5  | 1  | 0 | 0  | 0  | 0  | 0   | 1   | 0   | 0  | 0  | 4  | 5  | 0.00  | 1.000 |

**BOTTOM**

| AB | R | H | RBI | BB | SO | LOB |
|----|---|---|-----|----|----|-----|
| 4  | 1 | 2 | 0   | 1  | 0  | 0   |
| 4  | 1 | 1 | 1   | 0  | 1  | 2   |
| 0  | 0 | 0 | 0   | 0  | 0  | 0   |
| 5  | 2 | 2 | 0   | 0  | 0  | 2   |
| 4  | 2 | 2 | 1   | 1  | 1  | 2   |
| 4  | 3 | 3 | 4   | 1  | 0  | 2   |
| 3  | 1 | 1 | 3   | 0  | 0  | 2   |
| 1  | 0 | 0 | 0   | 0  | 0  | 1   |
| 4  | 0 | 2 | 1   | 0  | 0  | 0   |
| 3  | 0 | 1 | 0   | 1  | 0  | 1   |
| 1  | 0 | 0 | 0   | 0  | 0  | 0   |
| 0  | 0 | 0 | 0   | 0  | 0  | 0   |
| 0  | 0 | 0 | 0   | 0  | 0  | 0   |
| 1  | 0 | 0 | 0   | 0  | 1  | 0   |
| 2  | 0 | 0 | 0   | 0  | 0  | 3   |

**AB 36**  
**R 10**  
**H 14**  
**RBI 10**  
**BB 4**  
**SO 3**  
**LOB 15**

livebaseballscorecards.com



WP: 1 PA: 41  
PB: 1  
SB: 0  
CS: 0

**Kansas City Athletics @ Minnesota Twins**  
Metropolitan Stadium, Bloomington, MI  
Sat May 09 1964, 4:33 AM EDT  
Att. 9,219 - Unknown

| Batter   | 1                            | 2                                | 3                            | 4                               | 5                            | 6                               | 7                            | 8                               | 9                            | AB R H RBI BB SO LOB            | TOP                          |                                  |                              |                                 |                              |                                  |                              |                                 |                                  |                                    |                                  |        |                |           |          |          |         |        |         |         |         |          |          |          |         |         |         |         |             |               |
|--|------------------------------|----------------------------------|------------------------------|---------------------------------|------------------------------|---------------------------------|------------------------------|---------------------------------|------------------------------|---------------------------------|------------------------------|----------------------------------|------------------------------|---------------------------------|------------------------------|----------------------------------|------------------------------|---------------------------------|----------------------------------|------------------------------------|----------------------------------|--------|----------------|-----------|----------|----------|---------|--------|---------|---------|---------|----------|----------|----------|---------|---------|---------|---------|-------------|---------------|
| Wayne Causey, L (1, 6)<br>OBP: 0.418, SLG: 0.359       | 0-0<br>BB<br>2B              | 0-0<br>F5                        |                              |                                 | 0-0<br>F9                    |                                 | 0-0<br>F7                    |                                 | 0-0<br>4-3                   | 5 0 1 0 0 0 1                   |                              |                                  |                              |                                 |                              |                                  |                              |                                 |                                  |                                    |                                  |        |                |           |          |          |         |        |         |         |         |          |          |          |         |         |         |         |             |               |
| Dick Green, R (1, 4)<br>OBP: 0.259, SLG: 0.363         | 0-3<br>K                     |                                  | 0-0<br>F7                    |                                 | 0-0<br>3B                    |                                 | 0-0<br>2B                    |                                 | 0-0<br>1B<br>1B              | 5 1 3 0 0 1 1                   |                              |                                  |                              |                                 |                              |                                  |                              |                                 |                                  |                                    |                                  |        |                |           |          |          |         |        |         |         |         |          |          |          |         |         |         |         |             |               |
| Manny Jimenez, L (1, 7)<br>OBP: 0.269, SLG: 0.609      | 0-0<br>F2                    |                                  | 0-0<br>4-1                   |                                 | 0-3<br>K                     |                                 | 0-3<br>K                     |                                 | 0-0<br>1B<br>2B<br>1B        | 5 1 1 0 0 2 3                   |                              |                                  |                              |                                 |                              |                                  |                              |                                 |                                  |                                    |                                  |        |                |           |          |          |         |        |         |         |         |          |          |          |         |         |         |         |             |               |
| Jim Gentile, L (1, 3)<br>OBP: 0.419, SLG: 0.567        | 4-0<br>BB<br>BB              |                                  | 0-0<br>F8                    |                                 |                              | 0-0<br>G3                       |                              | 0-3<br>K                        | 0-0<br>1B<br>2B<br>1B        | 4 1 1 1 1 1 0                   |                              |                                  |                              |                                 |                              |                                  |                              |                                 |                                  |                                    |                                  |        |                |           |          |          |         |        |         |         |         |          |          |          |         |         |         |         |             |               |
| Rocky Colavito, R (1, 9)<br>OBP: 0.422, SLG: 0.716     | 4-0<br>1-2<br>2-3<br>BB      |                                  |                              | 0-0<br>G6-3<br>1B               |                              | 4-0<br>1B<br>BB                 |                              | 0-0<br>5-3                      | 0-0<br>1B<br>2B              | 3 0 2 2 2 0 0                   |                              |                                  |                              |                                 |                              |                                  |                              |                                 |                                  |                                    |                                  |        |                |           |          |          |         |        |         |         |         |          |          |          |         |         |         |         |             |               |
| Charlie Lau, L (1, 2)<br>OBP: 0.356, SLG: 0.500        | 0-3<br>K                     |                                  |                              | 0-0<br>G6-3<br>1-2f             |                              | 0-0<br>1B                       |                              | 4-0<br>1B<br>BB                 |                              | 3 0 1 0 1 1 4                   |                              |                                  |                              |                                 |                              |                                  |                              |                                 |                                  |                                    |                                  |        |                |           |          |          |         |        |         |         |         |          |          |          |         |         |         |         |             |               |
| Nelson Mathews, R (1, 8)<br>OBP: 0.374, SLG: 0.469     |                              | 0-0<br>F7                        |                              | 0-0<br>1B                       |                              | 0-3<br>K                        |                              | 0-0<br>1B                       |                              | 4 0 2 0 0 1 2                   |                              |                                  |                              |                                 |                              |                                  |                              |                                 |                                  |                                    |                                  |        |                |           |          |          |         |        |         |         |         |          |          |          |         |         |         |         |             |               |
| George Williams, R (1, 5)                              |                              | 0-0<br>F7                        |                              | 0-0<br>F7                       |                              | 0-0<br>F2                       |                              | 0-3<br>K2-3                     |                              | 4 0 0 0 0 1 5                   |                              |                                  |                              |                                 |                              |                                  |                              |                                 |                                  |                                    |                                  |        |                |           |          |          |         |        |         |         |         |          |          |          |         |         |         |         |             |               |
| Aurelio Monteagudo, R (1, 1)<br>OBP: 0.400, SLG: 0.800 |                              | 0-0                              |                              |                                 | 0-0<br>1-3                   |                                 | 0-0<br>6-3                   |                                 | 0-0<br>F9                    | 1 0 1 0 0 0 0                   |                              |                                  |                              |                                 |                              |                                  |                              |                                 |                                  |                                    |                                  |        |                |           |          |          |         |        |         |         |         |          |          |          |         |         |         |         |             |               |
| Jose Tartabull, L (5, PH)                              |                              |                                  |                              |                                 |                              |                                 |                              |                                 |                              | 1 0 0 0 0 0 0                   |                              |                                  |                              |                                 |                              |                                  |                              |                                 |                                  |                                    |                                  |        |                |           |          |          |         |        |         |         |         |          |          |          |         |         |         |         |             |               |
| Joe Grzenda, R (5, 1)                                  |                              |                                  |                              |                                 |                              |                                 |                              |                                 |                              | 0 0 0 0 0 0 0                   |                              |                                  |                              |                                 |                              |                                  |                              |                                 |                                  |                                    |                                  |        |                |           |          |          |         |        |         |         |         |          |          |          |         |         |         |         |             |               |
| Billy Bryan, L (7, PH)                                 |                              |                                  |                              |                                 |                              |                                 |                              |                                 |                              | 1 0 0 0 0 0 0                   |                              |                                  |                              |                                 |                              |                                  |                              |                                 |                                  |                                    |                                  |        |                |           |          |          |         |        |         |         |         |          |          |          |         |         |         |         |             |               |
| Vern Handrahan, L (7, 1)                               |                              |                                  |                              |                                 |                              |                                 |                              |                                 |                              | 0 0 0 0 0 0 0                   |                              |                                  |                              |                                 |                              |                                  |                              |                                 |                                  |                                    |                                  |        |                |           |          |          |         |        |         |         |         |          |          |          |         |         |         |         |             |               |
| George Alusik, R (9, PH)                               |                              |                                  |                              |                                 |                              |                                 |                              |                                 |                              | 1 0 0 0 0 0 0                   |                              |                                  |                              |                                 |                              |                                  |                              |                                 |                                  |                                    |                                  |        |                |           |          |          |         |        |         |         |         |          |          |          |         |         |         |         |             |               |
| <b>Inning Stats</b>                                    | R: 0<br>E: 0<br>K: 2<br>S: 8 | H: 1<br>LOB: 3<br>BB: 2<br>P: 16 | R: 0<br>E: 0<br>K: 0<br>S: 4 | H: 1<br>LOB: 1<br>BB: 0<br>P: 4 | R: 0<br>E: 0<br>K: 0<br>S: 3 | H: 0<br>LOB: 0<br>BB: 0<br>P: 3 | R: 0<br>E: 0<br>K: 0<br>S: 4 | H: 2<br>LOB: 1<br>BB: 0<br>P: 4 | R: 0<br>E: 0<br>K: 1<br>S: 6 | H: 1<br>LOB: 1<br>BB: 0<br>P: 6 | R: 0<br>E: 0<br>K: 1<br>S: 6 | H: 1<br>LOB: 2<br>BB: 1<br>P: 10 | R: 0<br>E: 0<br>K: 1<br>S: 6 | H: 1<br>LOB: 1<br>BB: 0<br>P: 6 | R: 0<br>E: 0<br>K: 2<br>S: 8 | H: 1<br>LOB: 2<br>BB: 1<br>P: 12 | R: 3<br>E: 0<br>K: 0<br>S: 6 | H: 4<br>LOB: 1<br>BB: 0<br>P: 6 | 1B: 7<br>2B: 3<br>3B: 2<br>HR: 0 | SF: 0<br>SAC: 0<br>DP: 1<br>HBP: 0 | WP: 0<br>PB: 0<br>SB: 0<br>CS: 0 | PA: 41 |                |           |          |          |         |        |         |         |         |          |          |          |         |         |         |         |             |               |
| <b>PITCHER</b><br>Camilo Pascual, R (1, 1)<br>ERA: 4.6 | IP<br>9.0                    | WLS<br>W                         | BF<br>41                     | H<br>12                         | R<br>3                       | ER<br>3                         | SO<br>7                      | BB<br>4                         | IBB<br>0                     | HBP<br>0                        | BLK<br>0                     | WP<br>0                          | HR<br>0                      | S<br>51                         | P<br>67                      | ERA<br>3.00                      | WHIP<br>1.778                |                                 |                                  |                                    |                                  |        | <b>PITCHER</b> | IP<br>9.0 | WLS<br>W | BF<br>41 | H<br>12 | R<br>3 | ER<br>3 | SO<br>7 | BB<br>4 | IBB<br>0 | HBP<br>0 | BLK<br>0 | WP<br>0 | HR<br>0 | S<br>51 | P<br>67 | ERA<br>3.00 | WHIP<br>1.778 |

Kansas City Athletics @ Minnesota Twins  
Metropolitan Stadium, Bloomington, MI  
Sun May 10 1964, 4:33 AM EDT  
Att. 16,845 - Unknown

|     |    |
|-----|----|
| AB  | 37 |
| R   | 3  |
| H   | 12 |
| RBI | 3  |
| BB  | 4  |
| SO  | 7  |
| LOB | 16 |

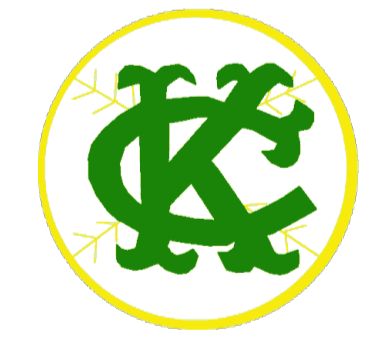

| Batter  | 1         | 2         | 3         | 4         | 5            | 6            | 7          | 8         | 9 | AB | R | H | RBI | BB | SO | LOB |
|---|-----------|-----------|-----------|-----------|--------------|--------------|------------|-----------|---|----|---|---|-----|----|----|-----|
| Zoilo Versalles, R<br>OBP: 0.340, SLG: 0.368<br>(1, 6)            | 0-0<br>F6 | 0-0<br>F8 |           |           | 0-0<br>6-3   |              | 0-0<br>F2  |           |   | 4  | 0 | 0 | 0   | 0  | 0  | 1   |
| Rich Rollins, R<br>OBP: 0.358, SLG: 0.465<br>(1, 5)               | 0-0<br>1B |           | 0-0<br>F3 |           | 0-0<br>5-3   |              | 0-0<br>F7  |           |   | 4  | 1 | 1 | 0   | 0  | 0  | 1   |
| Tony Oliva, L<br>OBP: 0.468, SLG: 0.765<br>(1, 9)                 | 0-0<br>1B |           | 0-0<br>F7 |           | 0-0<br>WP    |              | 0-0<br>2B  |           |   | 4  | 1 | 3 | 1   | 0  | 0  | 0   |
| Jimmie Hall, L<br>OBP: 0.412, SLG: 0.676<br>(1, 8)                | 0-0<br>HR |           | 0-3<br>K  |           | 0-0<br>4-3   |              | 0-0<br>6-3 |           |   | 4  | 1 | 1 | 1   | 0  | 1  | 2   |
| Bob Allison, R<br>OBP: 0.440, SLG: 0.658<br>(1, 7)                | 0-0<br>F5 |           |           | 0-0<br>F9 |              | 4-0<br>SH1-3 |            | 0-3<br>K  |   | 3  | 0 | 0 | 0   | 1  | 1  | 2   |
| Don Mincher, L<br>OBP: 0.353, SLG: 0.710<br>(1, 3)                | 0-0<br>HR |           |           | 0-0<br>F8 |              | 0-0<br>SH1-3 |            | 0-0<br>L3 |   | 3  | 1 | 1 | 3   | 0  | 0  | 0   |
| Earl Battey, R<br>OBP: 0.338, SLG: 0.448<br>(1, 2)                | 0-0<br>F9 |           |           | 0-0<br>HR |              | 0-0<br>F4    |            | 0-0<br>F7 |   | 2  | 1 | 1 | 1   | 0  | 0  | 0   |
| Jerry Zimmerman, R<br>OBP: 0.556, SLG: 0.429<br>(6, PH)<br>(7, 2) |           |           |           |           |              |              |            |           |   | 2  | 0 | 0 | 0   | 0  | 0  | 1   |
| Johnny Goryl, R<br>OBP: 0.346, SLG: 0.261<br>(1, 4)               |           |           | 0-0<br>F4 |           | 0-0<br>FC6-4 |              | 0-3<br>K   |           |   | 3  | 0 | 1 | 0   | 0  | 1  | 1   |
| Camilo Pascual, R<br>OBP: 0.353, SLG: 0.467<br>(1, 1)             |           |           | 0-3<br>K  |           | 0-0<br>FC6-4 |              | 0-0<br>2B  |           |   | 3  | 1 | 1 | 0   | 0  | 1  | 1   |

| Inning Stats | R: 4  | H: 4  | E: 0   | LOB: 0 | K: 0  | P: 7  | R: 0   | H: 0  | E: 0   | LOB: 0 | K: 1  | P: 5  | R: 0 | H: 0 | E: 0 | LOB: 0 | K: 1 | P: 5 | R: 1 | H: 2 | E: 0 | LOB: 1 | K: 0 | P: 5 | R: 0 | H: 1 | E: 0 | LOB: 1 | K: 0 | P: 4 | R: 0 | H: 0 | E: 0 | LOB: 1 | K: 1 | P: 9 | R: 1 | H: 2 | E: 0 | LOB: 1 | K: 0 | P: 5 | R: 0 | H: 0 | E: 0 | LOB: 0 | K: 1 | P: 5 |
|--------------|-------|-------|--------|--------|-------|-------|--------|-------|--------|--------|-------|-------|------|------|------|--------|------|------|------|------|------|--------|------|------|------|------|------|--------|------|------|------|------|------|--------|------|------|------|------|------|--------|------|------|------|------|------|--------|------|------|
| 1B: 5        | SF: 0 | 2B: 2 | SAC: 1 | 3B: 0  | DP: 0 | HR: 2 | HBP: 0 | WP: 1 | PA: 34 | PB: 0  | SB: 0 | CS: 0 |      |      |      |        |      |      |      |      |      |        |      |      |      |      |      |        |      |      |      |      |      |        |      |      |      |      |      |        |      |      |      |      |      |        |      |      |

| PITCHER                                      | IP  | WLS | BF | H | R | ER | SO | BB | IBB | HBP | BLK | WP | HR | S  | P  | ERA   | WHIP  |
|--|-----|-----|----|---|---|----|----|----|-----|-----|-----|----|----|----|----|-------|-------|
| Aurelio Monteagudo, R<br>ERA: 7.58<br>(1, 1) | 4.0 | L   | 18 | 6 | 5 | 5  | 2  | 0  | 0   | 0   | 0   | 0  | 2  | 22 | 22 | 11.25 | 1.500 |
| Joe Grzenda, L<br>ERA:<br>(5, 1)             | 2.0 |     | 8  | 1 | 0 | 0  | 1  | 1  | 0   | 0   | 0   | 1  | 0  | 9  | 13 | 0.00  | 1.000 |
| Vern Handrahan, R<br>ERA: 5.27<br>(7, 1)     | 2.0 |     | 8  | 2 | 1 | 1  | 1  | 0  | 0   | 0   | 0   | 0  | 0  | 10 | 10 | 4.50  | 1.000 |

**BOTTOM**

**Kansas City Athletics @ Minnesota Twins**  
Metropolitan Stadium, Bloomington, MI

Sun May 10 1964, 4:33 AM EDT  
Att. 16,845 - Unknown

[livebaseballscorecards.com](http://livebaseballscorecards.com)

|            |           |
|------------|-----------|
| <b>AB</b>  | <b>32</b> |
| <b>R</b>   | <b>6</b>  |
| <b>H</b>   | <b>9</b>  |
| <b>RBI</b> | <b>6</b>  |
| <b>BB</b>  | <b>1</b>  |
| <b>SO</b>  | <b>4</b>  |
| <b>LOB</b> | <b>9</b>  |



| Batter  | 1   | 2                               | 3                            | 4                               | 5                            | 6                               | 7                            | 8                               | 9                            | AB R H RBI BB SO LOB            | TOP  |                                 |                              |                                 |                              |                                 |                              |                                 |                                  |                                    |                                  |        |   |     |    |
|---|---|---------------------------------|------------------------------|---------------------------------|------------------------------|---------------------------------|------------------------------|---------------------------------|------------------------------|---------------------------------|--|---------------------------------|------------------------------|---------------------------------|------------------------------|---------------------------------|------------------------------|---------------------------------|----------------------------------|------------------------------------|----------------------------------|--------|---|-----|----|
| Wayne Causey, L (1, 6)<br>OBP: 0.417, SLG: 0.361    | 0-0<br>1-3  |                                 | 0-0<br>3-1                   |                                 | 0-0<br>1B                    |                                 | 0-0<br>FC5-4<br>1B           |                                 | 0-0<br>4-3                   | 5 0 2 0 0 0 0                   | <p>Kansas City Athletics @ Los Angeles Angels<br/>Dodger Stadium, Los Angeles, CA</p> <p>Mon May 11 1964, 7:05 PM PDT<br/>Att. 3,357 - Unknown</p> <p>livebaseballscorecards.com</p> <table border="1"> <tr><td>AB</td><td>38</td></tr> <tr><td>R</td><td>5</td></tr> <tr><td>H</td><td>11</td></tr> <tr><td>RBI</td><td>5</td></tr> <tr><td>BB</td><td>0</td></tr> <tr><td>SO</td><td>3</td></tr> <tr><td>LOB</td><td>13</td></tr> </table>  | AB                              | 38                           | R                               | 5                            | H                               | 11                           | RBI                             | 5                                | BB                                 | 0                                | SO     | 3 | LOB | 13 |
| AB  | 38  |                                 |                              |                                 |                              |                                 |                              |                                 |                              |                                 |  |                                 |                              |                                 |                              |                                 |                              |                                 |                                  |                                    |                                  |        |   |     |    |
| R   | 5   |                                 |                              |                                 |                              |                                 |                              |                                 |                              |                                 |  |                                 |                              |                                 |                              |                                 |                              |                                 |                                  |                                    |                                  |        |   |     |    |
| H   | 11  |                                 |                              |                                 |                              |                                 |                              |                                 |                              |                                 |  |                                 |                              |                                 |                              |                                 |                              |                                 |                                  |                                    |                                  |        |   |     |    |
| RBI   | 5   |                                 |                              |                                 |                              |                                 |                              |                                 |                              |                                 |  |                                 |                              |                                 |                              |                                 |                              |                                 |                                  |                                    |                                  |        |   |     |    |
| BB  | 0   |                                 |                              |                                 |                              |                                 |                              |                                 |                              |                                 |  |                                 |                              |                                 |                              |                                 |                              |                                 |                                  |                                    |                                  |        |   |     |    |
| SO  | 3   |                                 |                              |                                 |                              |                                 |                              |                                 |                              |                                 |  |                                 |                              |                                 |                              |                                 |                              |                                 |                                  |                                    |                                  |        |   |     |    |
| LOB   | 13  |                                 |                              |                                 |                              |                                 |                              |                                 |                              |                                 |  |                                 |                              |                                 |                              |                                 |                              |                                 |                                  |                                    |                                  |        |   |     |    |
| Dick Green, R (1, 4)<br>OBP: 0.244, SLG: 0.341      | 0-0<br>E5<br>1B                                       |                                 | 0-0<br>6-3                   |                                 | 0-0<br>F6                    |                                 | 0-0<br>FC5-4                 |                                 | 0-0<br>F9                    | 5 1 0 0 0 0 3                   |  |                                 |                              |                                 |                              |                                 |                              |                                 |                                  |                                    |                                  |        |   |     |    |
| Nelson Mathews, R (1, 8)<br>OBP: 0.385, SLG: 0.477  | 0-0<br>1B   |                                 | 0-0<br>4-3                   |                                 | 0-0<br>1B                    |                                 |                              | 0-0<br>2B<br>1B                 | 0-3<br>K                     | 5 1 3 1 0 1 0                   |  |                                 |                              |                                 |                              |                                 |                              |                                 |                                  |                                    |                                  |        |   |     |    |
| Jim Gentile, L (1, 3)<br>OBP: 0.422, SLG: 0.577     | 0-0<br>1B   |                                 |                              | 0-3<br>K                        | 0-0<br>F8                    |                                 |                              | 0-0<br>1B<br>2B                 |                              | 4 1 2 1 0 1 2                   |  |                                 |                              |                                 |                              |                                 |                              |                                 |                                  |                                    |                                  |        |   |     |    |
| Rocky Colavito, R (1, 9)<br>OBP: 0.415, SLG: 0.692  | 0-0<br>G6-4-3   |                                 |                              | 0-0<br>F8                       |                              | 0-0<br>F8                       |                              | 0-0<br>2B<br>1B                 |                              | 4 1 1 1 0 0 2                   |  |                                 |                              |                                 |                              |                                 |                              |                                 |                                  |                                    |                                  |        |   |     |    |
| Charlie Lau, L (1, 2)<br>OBP: 0.367, SLG: 0.523     |   | 0-0<br>5-3                      |                              | 0-0<br>1B                       |                              | 0-0<br>4-3                      |                              | 0-0<br>2B                       |                              | 4 0 2 2 0 0 0                   |  |                                 |                              |                                 |                              |                                 |                              |                                 |                                  |                                    |                                  |        |   |     |    |
| George Williams, R (1, 5)                           |   | 0-0<br>F8                       |                              | 0-0<br>1-3                      |                              | 0-0<br>6-3                      |                              | 0-0<br>1-3                      |                              | 4 0 0 0 0 0 2                   |  |                                 |                              |                                 |                              |                                 |                              |                                 |                                  |                                    |                                  |        |   |     |    |
| Tommie Reynolds, R (1, 7)<br>OBP: 0.333, SLG: 0.333 |   | 1-0<br>HBP                      |                              |                                 | 0-0<br>1B                    |                                 | 0-0<br>6-3                   | 0-0<br>F7                       |                              | 2 1 1 0 0 0 0                   |  |                                 |                              |                                 |                              |                                 |                              |                                 |                                  |                                    |                                  |        |   |     |    |
| Manny Jimenez, L (8, PH)<br>OBP: 0.259, SLG: 0.583  |   |                                 |                              |                                 | 0-0<br>1B                    |                                 |                              |                                 |                              | 1 0 0 0 0 0 1                   |  |                                 |                              |                                 |                              |                                 |                              |                                 |                                  |                                    |                                  |        |   |     |    |
| Moe Drabowsky, R (1, 1)                             |   | 0-0<br>4-3                      |                              |                                 | 0-3<br>K                     |                                 | 0-0<br>5-3                   | 0-0<br>F6                       |                              | 2 0 0 0 0 1 2                   |  |                                 |                              |                                 |                              |                                 |                              |                                 |                                  |                                    |                                  |        |   |     |    |
| George Alusik, R (7, PH)                            |   |                                 |                              |                                 |                              |                                 |                              |                                 |                              | 1 0 0 0 0 0 0                   |  |                                 |                              |                                 |                              |                                 |                              |                                 |                                  |                                    |                                  |        |   |     |    |
| Joe Grzenda, R (7, 1)                               |   |                                 |                              |                                 |                              |                                 |                              |                                 |                              | 0 0 0 0 0 0 0                   |  |                                 |                              |                                 |                              |                                 |                              |                                 |                                  |                                    |                                  |        |   |     |    |
| Billy Bryan, L (8, PH)<br>OBP: 0.417, SLG: 0.889    |   |                                 |                              |                                 |                              |                                 |                              |                                 |                              | 1 0 0 0 0 0 1                   |  |                                 |                              |                                 |                              |                                 |                              |                                 |                                  |                                    |                                  |        |   |     |    |
| John Wyatt, R (8, 1)                                |   |                                 |                              |                                 |                              |                                 |                              |                                 |                              | 0 0 0 0 0 0 0                   |  |                                 |                              |                                 |                              |                                 |                              |                                 |                                  |                                    |                                  |        |   |     |    |
| <b>Inning Stats</b>                                 | R: 1<br>E: 1<br>K: 0<br>S: 5                          | H: 2<br>LOB: 1<br>BB: 0<br>P: 5 | R: 0<br>E: 0<br>K: 0<br>S: 3 | H: 0<br>LOB: 1<br>BB: 0<br>P: 4 | R: 0<br>E: 0<br>K: 0<br>S: 3 | H: 0<br>LOB: 0<br>BB: 0<br>P: 3 | R: 0<br>E: 0<br>K: 1<br>S: 6 | H: 1<br>LOB: 1<br>BB: 0<br>P: 6 | R: 1<br>E: 0<br>K: 1<br>S: 8 | H: 3<br>LOB: 2<br>BB: 0<br>P: 8 | R: 0<br>E: 0<br>K: 0<br>S: 3   | H: 0<br>LOB: 0<br>BB: 0<br>P: 3 | R: 0<br>E: 0<br>K: 0<br>S: 4 | H: 1<br>LOB: 1<br>BB: 0<br>P: 4 | R: 3<br>E: 0<br>K: 0<br>S: 7 | H: 4<br>LOB: 1<br>BB: 0<br>P: 7 | R: 0<br>E: 0<br>K: 1<br>S: 5 | H: 0<br>LOB: 0<br>BB: 0<br>P: 5 | 1B: 9<br>2B: 2<br>3B: 0<br>HR: 0 | SF: 0<br>SAC: 0<br>DP: 1<br>HBP: 1 | WP: 0<br>PB: 0<br>SB: 0<br>CS: 0 | PA: 39 |   |     |    |
| <b>PITCHER</b>                                      | IP WLS BF H R ER SO BB IBB HBP BLK WP HR S P ERA WHIP |                                 |                              |                                 |                              |                                 |                              |                                 |                              |                                 |  |                                 |                              |                                 |                              |                                 |                              |                                 |                                  |                                    |                                  |        |   |     |    |
| Fred Newman, R (1, 1)<br>ERA: 2.92                  | 7.0 W 31 9 4 3 2 0 0 1 0 0 0 0 34 35 3.86 1.286       |                                 |                              |                                 |                              |                                 |                              |                                 |                              |                                 |  |                                 |                              |                                 |                              |                                 |                              |                                 |                                  |                                    |                                  |        |   |     |    |
| Dean Chance, R (8, 1)<br>ERA: 2.18                  | 0.0 2 2 1 1 0 0 0 0 0 0 0 0 2 2 ∞ ∞                   |                                 |                              |                                 |                              |                                 |                              |                                 |                              |                                 |  |                                 |                              |                                 |                              |                                 |                              |                                 |                                  |                                    |                                  |        |   |     |    |
| Barry Latman, R (8, 1)<br>ERA: 3.8                  | 2.0 S 6 0 0 0 1 0 0 0 0 0 0 0 8 8 0.00 0.000          |                                 |                              |                                 |                              |                                 |                              |                                 |                              |                                 |  |                                 |                              |                                 |                              |                                 |                              |                                 |                                  |                                    |                                  |        |   |     |    |

| Batter | 1 | 2 | 3 | 4 | 5 | 6 | 7 | 8 | 9 | AB R H RBI BB SO LOB |
|--------|---|---|---|---|---|---|---|---|---|----------------------|
|--------|---|---|---|---|---|---|---|---|---|----------------------|

|   |                          |                     |                       |              |                      |              |                       |                       |  |   |
|---|--------------------------|---------------------|-----------------------|--------------|----------------------|--------------|-----------------------|-----------------------|--|---|
| <b>Albie Pearson, L</b><br><small>OBP: 0.315, SLG: 0.369</small><br>(1, 8) X  | 0-0<br><br>X             | 0-0<br><br>1-H<br>X |                       |              | 0-0<br><br>X         |              | 0-0<br><br>X          |                       |  | 4 3 3 2 0 0 0                                   |
| <b>Billy Moran, R</b><br><small>OBP: 0.294, SLG: 0.293</small><br>(1, 5) B B B  | 4-0<br><br>X             | 0-0<br><br>X        |                       |              | 0-0<br><br>2-3<br>X  |              | 0-0<br><br>2-H<br>X   |                       |  | 3 1 2 1 1 0 0                                   |
| <b>Jim Fregosi, R</b><br><small>OBP: 0.468, SLG: 0.657</small><br>(1, 6) H  | 1-0<br><br>1-2<br>X      |                     | 0-3<br><br>S S S<br>X |              | 0-0<br><br>3-H<br>X  |              | 0-3<br><br>S S S<br>X |                       |  | 2 1 0 1 0 2 1                                   |
| <b>Lee Thomas, L</b><br><small>OBP: 0.270, SLG: 0.309</small><br>(1, 9) X   | 0-0<br><br>1-2, 2-3<br>X |                     | 0-0<br><br>X          |              | 0-0<br><br>X         |              | 0-0<br><br>X          |                       |  | 4 0 0 0 0 0 4                                   |
| <b>Buck Rodgers, S</b><br><small>OBP: 0.326, SLG: 0.306</small><br>(1, 2) X   | 0-0<br><br>2-H, 3-H<br>X |                     | 0-0<br><br>X          |              | 0-0<br><br>1-2f<br>X |              |                       | 0-0<br><br>X          |  | 4 0 2 2 0 0 1                                   |
| <b>Tom Satriano, L</b><br><small>OBP: 0.429, SLG: 0.400</small><br>(1, 3) X   | 0-0<br><br>X             |                     |                       | 0-0<br><br>X |                      | 0-0<br><br>X |                       | 0-0<br><br>1-2<br>X   |  | 4 0 1 0 0 0 2                                   |
| <b>Ed Kirkpatrick, L</b><br><small>OBP: 0.333, SLG: 0.379</small><br>(1, 7) B B B   |                          | 4-0<br><br>X        |                       | 0-0<br><br>X |                      | 0-0<br><br>X |                       | 0-0<br><br>X          |  | 3 1 0 0 1 0 2                                   |
| <b>Bobby Knoop, R</b><br><small>OBP: 0.283, SLG: 0.341</small><br>(1, 4) X  |                          | 0-0<br><br>X        |                       | 0-0<br><br>X |                      | 0-0<br><br>X |                       | 0-3<br><br>S S S<br>X |  | 4 0 0 0 0 1 3                                   |
| <b>Fred Newman, R</b><br><small>OBP: 0.182, SLG: 0.182</small><br><b>Dean Chance, R</b><br><small>OBP: 0.143, SLG: 0.143</small><br><b>Barry Latman, R</b><br><small>OBP: 0.143, SLG: 0.143</small><br>(1, 1) (8, 1) (8, 1) X |                          | 0-0<br><br>X        |                       | 0-0<br><br>X |                      |              | 0-3<br><br>S S S<br>X |                       |  | 3 0 0 0 0 1 2<br>0 0 0 0 0 0 0<br>0 0 0 0 0 0 0 |

| Inning Stats | R: 2 | H: 1 | E: 0 | LOB: 1 | K: 0 | BB: 1 | S: 4 | P: 9 | R: 2 | H: 1 | E: 0 | LOB: 0 | K: 0 | BB: 1 | S: 4 | P: 8 | R: 0 | H: 0 | E: 0 | LOB: 0 | K: 1 | BB: 0 | S: 5 | R: 0 | H: 1 | E: 0 | LOB: 1 | K: 0 | BB: 0 | S: 4 | P: 4 | R: 1 | H: 2 | E: 0 | LOB: 1 | K: 0 | BB: 0 | S: 5 | P: 5 | R: 0 | H: 0 | E: 0 | LOB: 0 | K: 0 | BB: 0 | S: 3 | P: 3 | R: 1 | H: 2 | E: 1 | LOB: 1 | K: 2 | BB: 0 | S: 9 | P: 9 | R: 0 | H: 1 | E: 0 | LOB: 1 | K: 1 | BB: 0 | S: 6 | P: 6 |
|--------------|------|------|------|--------|------|-------|------|------|------|------|------|--------|------|-------|------|------|------|------|------|--------|------|-------|------|------|------|------|--------|------|-------|------|------|------|------|------|--------|------|-------|------|------|------|------|------|--------|------|-------|------|------|------|------|------|--------|------|-------|------|------|------|------|------|--------|------|-------|------|------|
|--------------|------|------|------|--------|------|-------|------|------|------|------|------|--------|------|-------|------|------|------|------|------|--------|------|-------|------|------|------|------|--------|------|-------|------|------|------|------|------|--------|------|-------|------|------|------|------|------|--------|------|-------|------|------|------|------|------|--------|------|-------|------|------|------|------|------|--------|------|-------|------|------|

| PITCHER   | IP     | WLS | BF | H  | R | ER | SO | BB | IBB | HBP | BLK | WP | HR | S  | P  | ERA  | WHIP  |
|---|--------|-----|----|----|---|----|----|----|-----|-----|-----|----|----|----|----|------|-------|
| <b>Moe Drabowsky, R</b><br><small>ERA: 5.96</small> | (1, 1) | 6.0 | L  | 26 | 5 | 5  | 5  | 1  | 2   | 0   | 0   | 0  | 1  | 25 | 34 | 7.50 | 1.167 |
| <b>Joe Grzenda, L</b><br><small>ERA: 2.45</small>   | (7, 1) | 1.0 |    | 5  | 2 | 1  | 1  | 2  | 0   | 0   | 0   | 0  | 0  | 9  | 9  | 9.00 | 2.000 |
| <b>John Wyatt, R</b><br><small>ERA: 1.13</small>    | (8, 1) | 1.0 |    | 4  | 1 | 0  | 0  | 1  | 0   | 0   | 0   | 0  | 0  | 6  | 6  | 0.00 | 1.000 |

**BOTTOM**

|   |   |
|---|---|
| <b>Kansas City Athletics @ Los Angeles Angels</b><br><b>Dodger Stadium, Los Angeles, CA</b><br>Mon May 11 1964, 7:05 PM PDT<br>Att. 3,357 - Unknown | <b>AB 31</b><br><b>R 6</b><br><b>H 8</b><br><b>RBI 6</b><br><b>BB 2</b><br><b>SO 4</b><br><b>LOB 15</b> |
|---|---|

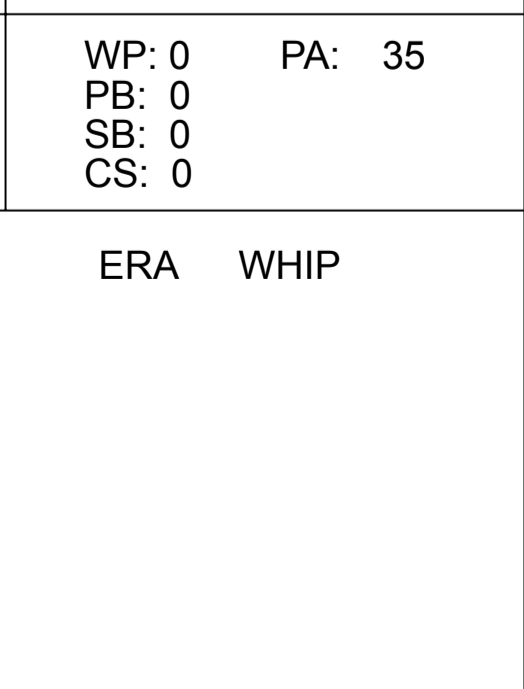

| Batter  | 1   | 2   | 3   | 4   | 5   | 6   | 7   | 8   | 9  | AB R H RBI BB SO LOB                                       | TOP  |
|---|---|---|---|---|---|---|---|---|--|--|--|
| Wayne Causey, L (1, 6)<br>OBP: 0.426, SLG: 0.368    | 0-0<br>G4-6-3 BB<br>1B                                | 0-0<br>G4-3<br>1-2f                                 |   |   | 0-0<br>F7   |   | 0-0<br>1B   |   | 4-0<br>2B<br>1-2<br>BB                               | 4 1 2 1 1 0 2  | <p>Kansas City Athletics @ Los Angeles Angels</p> <p>Dodger Stadium, Los Angeles, CA</p> <p>Tue May 12 1964, 7:05 PM PDT</p> <p>Att. 3,724 - Unknown</p> <p>livebaseballscorecards.com</p> |
| Nelson Mathews, R (1, 8)<br>OBP: 0.386, SLG: 0.478  | 4-0<br>G4-6-3<br>1-2<br>BB                            |   | 0-0<br>5-3  |   | 0-0<br>F8   |   | 0-3<br>K  | 0-0<br>2B<br>1-3<br>2-H                             | 4 1 1 1 1 1 1  |  |  |
| Manny Jimenez, L (1, 7)<br>OBP: 0.226, SLG: 0.500   | 0-0<br>G4-6-3<br>1-2f<br>2-3                          |   | 0-0<br>4-3  |   | 0-0<br>4-3  |   | 0-0<br>L4   | 0-0<br>2B<br>2-H<br>3-H                             | 4 0 0 0 0 0 3<br>1 0 1 2 0 0 0                       |  |  |
| Jose Tartabull, L (7, 7)<br>OBP: 0.200, SLG: 0.400  |   |   |   |   |   |   |   |   |  |  |  |
| Jim Gentile, L (1, 3)<br>OBP: 0.421, SLG: 0.560     | 4-0<br>BB   |   | 0-0<br>E3   |   | 0-3<br>K  |   | 0-0<br>G5-4-3<br>1B                                 | 0-0<br>F9   | 4 0 1 0 1 1 1  |  |  |
| Rocky Colavito, R (1, 9)<br>OBP: 0.408, SLG: 0.671  | 0-0<br>F7   |   | 0-0<br>F7   |   | 0-0<br>2B<br>1B                                     |   | 0-0<br>F7   |   | 4 1 1 0 0 0 4  |  |  |
| Ed Charles, R (1, 5)<br>OBP: 0.368, SLG: 0.427      |   | 4-0<br>HBP<br>1B<br>BB                              |   | 0-0<br>F9   | 0-0<br>2B   |   | 0-0<br>G5-4-3<br>1-2f                               |   | 3 1 1 1 1 0 1  |  |  |
| Charlie Lau, L (1, 2)<br>OBP: 0.358, SLG: 0.500     |   | 0-0<br>F4   |   | 0-0<br>F5   | 0-0<br>G3   |   | 0-0<br>BB<br>2B<br>1B                               |   | 4 1 1 0 0 0 2  |  |  |
| Dick Green, R (1, 4)<br>OBP: 0.255, SLG: 0.341      |   | 1-0<br>1B<br>1-2<br>HBP                             |   | 0-3<br>K  | 0-0<br>SH1-4<br>1B                                  |   | 0-0<br>F2   |   | 3 1 1 0 0 1 1  |  |  |
| John O'Donoghue, R (1, 1)<br>OBP: 0.500, SLG: 0.500 |   | 0-0<br>G4-3<br>1-2<br>2-H<br>1B                     |   | 0-3<br>K  | 0-0<br>SH1-4  |   | 0-3<br>K  |   | 2 0 1 1 0 1 0<br>1 0 0 0 0 1 1                       |  |  |
| John Wyatt, R (8, 1)                                |   |   |   |   |   |   |   |   |  |  |  |
| <b>Inning Stats</b>                                 | R: 0 H: 1<br>E: 0 LOB: 2<br>K: 0 BB: 2<br>S: 3 P: 11  | R: 1 H: 1<br>E: 0 LOB: 1<br>K: 0 BB: 1<br>S: 3 P: 8 | R: 0 H: 0<br>E: 1 LOB: 1<br>K: 0 BB: 0<br>S: 4 P: 4 | R: 0 H: 0<br>E: 0 LOB: 0<br>K: 1 BB: 0<br>S: 5 P: 5 | R: 0 H: 0<br>E: 0 LOB: 0<br>K: 1 BB: 0<br>S: 5 P: 5 | R: 1 H: 2<br>E: 0 LOB: 1<br>K: 1 BB: 0<br>S: 7 P: 7 | R: 1 H: 2<br>E: 0 LOB: 1<br>K: 1 BB: 0<br>S: 7 P: 7 | R: 0 H: 1<br>E: 0 LOB: 0<br>K: 0 BB: 0<br>S: 3 P: 3 | R: 3 H: 3<br>E: 0 LOB: 1<br>K: 1 BB: 1<br>S: 8 P: 12 | 1B: 7 SF: 0<br>2B: 3 SAC: 1<br>3B: 0 DP: 3<br>HR: 0 HBP: 1 | WP: 0 PA: 40<br>PB: 0<br>SB: 1<br>CS: 0  |
| <b>PITCHER</b>                                      | IP WLS BF H R ER SO BB IBB HBP BLK WP HR S P ERA WHIP |   |   |   |   |   |   |   |  |  |  |
| Ken McBride, R (1, 1)<br>ERA: 4.43                  | 8.2 L 38 9 6 6 5 4 0 1 0 0 0 0 43 60 6.23 1.500       |   |   |   |   |   |   |   |  |  |  |
| Willie Smith, L (9, 1)<br>ERA: 1.08                 | 0.1 2 1 0 0 0 0 0 0 0 0 0 0 2 2 0.00 3.000            |   |   |   |   |   |   |   |  |  |  |

|     |    |
|-----|----|
| AB  | 34 |
| R   | 6  |
| H   | 10 |
| RBI | 6  |
| BB  | 4  |
| SO  | 5  |
| LOB | 16 |



| Batter  | 1                            | 2                               | 3                            | 4                               | 5                                     | 6                                       | 7                            | 8                                | 9                            | AB R H RBI BB SO LOB            | BOTTOM  |   |                              |                                 |                              |                                 |                                  |                                    |                                  |                       |
|---|------------------------------|---------------------------------|------------------------------|---------------------------------|---------------------------------------|---|------------------------------|----------------------------------|------------------------------|---------------------------------|---|---|------------------------------|---------------------------------|------------------------------|---------------------------------|----------------------------------|------------------------------------|----------------------------------|-----------------------|
| <b>Albie Pearson, L</b><br>OBP: 0.309, SLG: 0.352 (1, 7)<br>S<br>S<br>S   | 0-3<br>K (1)                 |                                 | 0-0<br>F9 (2)                |                                 | 4-0<br>G5-4-3<br>1-2<br>2-3<br>BB (3) |   | 0-0<br>4-3 (1)               |                                  | 0-3<br>K (3)                 | 4 0 0 0 1 2 0                   | <b>Kansas City Athletics @ Los Angeles Angels</b><br><b>Dodger Stadium, Los Angeles, CA</b><br>Tue May 12 1964, 7:05 PM PDT<br>Att. 3,724 - Unknown |   |                              |                                 |                              |                                 |                                  |                                    |                                  |                       |
| <b>Billy Moran, R</b><br>OBP: 0.283, SLG: 0.282 (1, 5)<br>X   | 0-0<br>F4 (2)                |                                 | 0-0<br>6-3 (3)               |                                 | 0-0<br>G5-4-3<br>1-2f                 |   | 0-0<br>4-3 (2)               |                                  |                              | 4 0 0 0 0 0 3                   |   |   |                              |                                 |                              |                                 |                                  |                                    |                                  |                       |
| <b>Jim Fregosi, R</b><br>OBP: 0.458, SLG: 0.629 (1, 6)<br>X   | 0-0<br>F9 (3)                |                                 |                              | 4-0<br>S<br>BB (3)              |                                       | 0-0<br>E3<br>1B<br>FC (3)               |                              | 0-0<br>E6<br>S                   |                              | 3 1 0 0 1 0 0                   |   |   |                              |                                 |                              |                                 |                                  |                                    |                                  |                       |
| <b>Felix Torres, R</b><br>OBP: 0.313, SLG: 0.375 (1, 3)<br><b>Charlie Dees, L</b><br>OBP: 0.222, SLG: 0.188 (6, PR)<br>(7, 3)                               |                              | 0-0<br>6-3 (1)                  |                              | 0-3<br>K (1)                    |                                       | 0-0<br>FC<br>E<br>1B (3)                |                              | 0-0<br>1-3 (3)                   |                              | 3 0 1 0 0 1 1<br>1 1 0 0 0 0 1  |   |   |                              |                                 |                              |                                 |                                  |                                    |                                  |                       |
| <b>Buck Rodgers, S</b><br>OBP: 0.313, SLG: 0.292 (1, 2)<br>X  |                              | 0-0<br>E6<br>4-3                |                              | 0-3<br>K (2)                    |                                       | 0-0<br>FC<br>FC5<br>E<br>1-2<br>3-H (3) |                              | 0-0<br>F8 (1)                    |                              | 4 0 0 1 0 1 2                   |   |   |                              |                                 |                              |                                 |                                  |                                    |                                  |                       |
| <b>Lee Thomas, L</b><br>OBP: 0.269, SLG: 0.299 (1, 9)<br>X  |                              | 0-0<br>4-3 (2)                  |                              | 0-0<br>3-1 (3)                  |                                       | 0-0<br>F1 (1)                           |                              | 4-0<br>G6-4-3<br>BB (3)          |                              | 3 0 0 0 1 0 4                   |   |   |                              |                                 |                              |                                 |                                  |                                    |                                  |                       |
| <b>Dick Simpson, R</b><br>OBP: 0.129, SLG: 0.233 (1, 8)<br>B<br>B<br>B  |                              | 4-0<br>BB                       |                              |                                 | 0-0<br>F2 (1)                         |   | 0-3<br>K (2)                 |                                  | 0-0<br>G6-4-3<br>1-2f (3)    |                                 |   | 3 0 0 0 1 1 3                                   |                              |                                 |                              |                                 |                                  |                                    |                                  |                       |
| <b>Bobby Knoop, R</b><br>OBP: 0.281, SLG: 0.330 (1, 4)<br>X   |                              | 0-0<br>1-3 (3)                  |                              |                                 | 4-0<br>BB<br>1B<br>BB (3)             |   | 0-0<br>FC4 (3)               |                                  | 0-3<br>K (1)                 |                                 |   | 3 0 0 0 1 1 3                                   |                              |                                 |                              |                                 |                                  |                                    |                                  |                       |
| <b>Ken McBride, R</b><br>OBP: 0.400, SLG: 0.308 (1, 1)<br><b>Willie Smith, L</b><br>(9, 1)<br><b>Tom Satriano, L</b><br>OBP: 0.417, SLG: 0.387 (9, PH)<br>X |                              |                                 | 0-0<br>F2 (1)                |                                 | 0-0<br>BB<br>1B (3)                   |   | 0-0<br>FC5 (3)               |                                  | 0-0<br>F8 (2)                |                                 |   | 3 0 1 0 0 0 2<br>0 0 0 0 0 0 0<br>1 0 0 0 0 0 0 |                              |                                 |                              |                                 |                                  |                                    |                                  |                       |
| <b>Inning Stats</b>   | R: 0<br>E: 0<br>K: 1<br>S: 5 | H: 0<br>LOB: 0<br>BB: 0<br>P: 5 | R: 0<br>E: 1<br>K: 0<br>S: 4 | H: 0<br>LOB: 2<br>BB: 1<br>P: 8 | R: 0<br>E: 0<br>K: 0<br>S: 3          | H: 0<br>LOB: 1<br>BB: 1<br>P: 11        | R: 0<br>E: 0<br>K: 0<br>S: 3 | H: 1<br>LOB: 2<br>BB: 2<br>P: 11 | R: 2<br>E: 2<br>K: 1<br>S: 9 | H: 0<br>LOB: 2<br>BB: 0<br>P: 9 | R: 0<br>E: 1<br>K: 0<br>S: 4  | H: 0<br>LOB: 1<br>BB: 0<br>P: 4                 | R: 0<br>E: 0<br>K: 0<br>S: 2 | H: 0<br>LOB: 0<br>BB: 1<br>P: 6 | R: 0<br>E: 0<br>K: 2<br>S: 7 | H: 0<br>LOB: 0<br>BB: 0<br>P: 7 | 1B: 2<br>2B: 0<br>3B: 0<br>HR: 0 | SF: 0<br>SAC: 0<br>DP: 2<br>HBP: 0 | WP: 0<br>PB: 0<br>SB: 2<br>CS: 0 | PA: 37<br>ERA<br>WHIP |

| PITCHER                                       | IP  | WLS | BF | H | R | ER | SO | BB | IBB | HBP | BLK | WP | HR | S  | P  | ERA  | WHIP  |  |  |  |  |  |  |  |  |  |  |  |  |  |  |  |
|---|-----|-----|----|---|---|----|----|----|-----|-----|-----|----|----|----|----|------|-------|--|--|--|--|--|--|--|--|--|--|--|--|--|--|--|
| <b>John O'Donoghue, L</b><br>ERA: 3.12 (1, 1) | 7.0 | W   | 31 | 2 | 2 | 0  | 4  | 4  | 0   | 0   | 0   | 0  | 0  | 35 | 51 | 0.00 | 0.857 |  |  |  |  |  |  |  |  |  |  |  |  |  |  |  |
| <b>John Wyatt, R</b><br>ERA: 1.0 (8, 1)       | 2.0 | S   | 6  | 0 | 0 | 0  | 2  | 1  | 0   | 0   | 0   | 0  | 0  | 9  | 13 | 0.00 | 0.500 |  |  |  |  |  |  |  |  |  |  |  |  |  |  |  |

livebaseballscorecards.com

- AB** 32
- R** 2
- H** 2
- RBI** 1
- BB** 5
- SO** 6
- LOB** 19



| Batter   | 1                            | 2                               | 3                            | 4                               | 5                            | 6                               | 7                            | 8                               | 9                            | AB R H RBI BB SO LOB            | TOP   |                                 |                              |                                 |                              |                                 |                              |                                 |                                  |                                    |                                  |        |             |               |
|--|------------------------------|---------------------------------|------------------------------|---------------------------------|------------------------------|---------------------------------|------------------------------|---------------------------------|------------------------------|---------------------------------|---|---------------------------------|------------------------------|---------------------------------|------------------------------|---------------------------------|------------------------------|---------------------------------|----------------------------------|------------------------------------|----------------------------------|--------|-------------|---------------|
| Wayne Causey, L (1, 6)<br>OBP: 0.425, SLG: 0.370       | 0-0<br>1-3                   |                                 | 0-0<br>F8                    |                                 | 0-0<br>1-3<br>1B             |                                 | 0-0<br>BB<br>1B              |                                 | 0-0<br>G4-6-3<br>1-2f        | 5 0 2 0 0 0 2                   | <p>Kansas City Athletics @ Los Angeles Angels<br/>Dodger Stadium, Los Angeles, CA</p> <p>Wed May 13 1964, 7:05 PM PDT<br/>Unknown</p> |                                 |                              |                                 |                              |                                 |                              |                                 |                                  |                                    |                                  |        |             |               |
| Nelson Mathews, R (1, 8)<br>OBP: 0.390, SLG: 0.467     | 4-0<br>FC6-4<br>BB           |                                 | 0-3<br>K                     |                                 | 0-0<br>F3                    |                                 | 4-0<br>BB<br>BB              |                                 | 1-2<br>BB                    | 2 0 0 0 2 1 2                   |   |                                 |                              |                                 |                              |                                 |                              |                                 |                                  |                                    |                                  |        |             |               |
| Ed Charles, R (1, 5)<br>OBP: 0.364, SLG: 0.412         | 0-0<br>FC6-4<br>1-2f         |                                 |                              | 4-0<br>BB<br>BB                 |                              | 0-0<br>F7                       |                              | 0-0<br>F9                       |                              | 3 0 0 0 1 0 3                   |   |                                 |                              |                                 |                              |                                 |                              |                                 |                                  |                                    |                                  |        |             |               |
| Jim Gentile, L (1, 3)<br>OBP: 0.424, SLG: 0.557        | 0-0<br>4-3                   |                                 |                              | 0-0<br>BB<br>BB                 |                              | 0-0<br>F8                       |                              | 0-0<br>F8                       |                              | 4 0 2 0 0 0 1                   |   |                                 |                              |                                 |                              |                                 |                              |                                 |                                  |                                    |                                  |        |             |               |
| Rocky Colavito, R (1, 9)<br>OBP: 0.402, SLG: 0.647     |                              | 0-0<br>5-3                      |                              | 0-0<br>F3                       |                              | 4-0<br>BB<br>BB                 |                              | 0-3<br>K                        |                              | 3 0 0 0 1 1 2                   |   |                                 |                              |                                 |                              |                                 |                              |                                 |                                  |                                    |                                  |        |             |               |
| Manny Jimenez, L (1, 7)<br>OBP: 0.200, SLG: 0.438      |                              | 0-0<br>F8                       |                              | 0-0<br>G4-6-3<br>1-2f           |                              | 0-0<br>F5                       |                              | 0-0<br>F8                       |                              | 4 0 0 0 0 0 4                   |   |                                 |                              |                                 |                              |                                 |                              |                                 |                                  |                                    |                                  |        |             |               |
| Charlie Lau, L (1, 2)<br>OBP: 0.386, SLG: 0.529        |                              | 0-0<br>2B                       |                              |                                 | 0-0<br>1B<br>1B              |                                 | 0-0<br>F7                    |                                 | 4-0<br>BB<br>BB              | 3 0 2 0 1 0 2                   |   |                                 |                              |                                 |                              |                                 |                              |                                 |                                  |                                    |                                  |        |             |               |
| Dick Green, R (1, 4)<br>OBP: 0.245, SLG: 0.326         |                              | 0-3<br>K                        |                              |                                 | 0-0<br>F6                    |                                 | 0-0<br>F5                    |                                 | 0-0<br>F3                    | 4 0 0 0 0 1 3                   |   |                                 |                              |                                 |                              |                                 |                              |                                 |                                  |                                    |                                  |        |             |               |
| Aurelio Monteagudo, R (1, 1)<br>OBP: 0.400, SLG: 0.800 |                              |                                 | 0-0<br>F7                    |                                 | 0-3<br>K                     |                                 | 0-0<br>L4                    |                                 | 0-0<br>G4-6-3<br>1-2<br>1B   | 0 0 0 0 0 0 0                   |   |                                 |                              |                                 |                              |                                 |                              |                                 |                                  |                                    |                                  |        |             |               |
| Vern Handrahan, L (2, 1)                               |                              |                                 |                              |                                 |                              |                                 |                              |                                 |                              | 1 0 0 0 0 0 0                   |   |                                 |                              |                                 |                              |                                 |                              |                                 |                                  |                                    |                                  |        |             |               |
| Billy Bryan, L (5, PH)<br>OBP: 0.385, SLG: 0.800       |                              |                                 |                              |                                 |                              |                                 |                              |                                 |                              | 1 0 0 0 0 1 1                   |   |                                 |                              |                                 |                              |                                 |                              |                                 |                                  |                                    |                                  |        |             |               |
| Ted Bowsfield, R (5, 1)                                |                              |                                 |                              |                                 |                              |                                 |                              |                                 |                              | 1 0 0 0 0 0 0                   |   |                                 |                              |                                 |                              |                                 |                              |                                 |                                  |                                    |                                  |        |             |               |
| George Alusik, R (9, PH)<br>OBP: 0.571, SLG: 0.143     |                              |                                 |                              |                                 |                              |                                 |                              |                                 |                              | 1 0 1 0 0 0 0                   |   |                                 |                              |                                 |                              |                                 |                              |                                 |                                  |                                    |                                  |        |             |               |
| <b>Inning Stats</b>                                    | R: 0<br>E: 0<br>K: 0<br>S: 3 | H: 0<br>LOB: 1<br>BB: 1<br>P: 7 | R: 0<br>E: 0<br>K: 1<br>S: 6 | H: 1<br>LOB: 1<br>BB: 0<br>P: 6 | R: 0<br>E: 0<br>K: 1<br>S: 5 | H: 0<br>LOB: 0<br>BB: 0<br>P: 5 | R: 0<br>E: 0<br>K: 0<br>S: 3 | H: 1<br>LOB: 1<br>BB: 1<br>P: 7 | R: 0<br>E: 0<br>K: 0<br>S: 7 | H: 2<br>LOB: 2<br>BB: 0<br>P: 7 | R: 0<br>E: 0<br>K: 1<br>S: 4  | H: 1<br>LOB: 2<br>BB: 1<br>P: 8 | R: 0<br>E: 0<br>K: 0<br>S: 4 | H: 1<br>LOB: 2<br>BB: 1<br>P: 8 | R: 0<br>E: 0<br>K: 1<br>S: 5 | H: 0<br>LOB: 0<br>BB: 0<br>P: 5 | R: 0<br>E: 0<br>K: 0<br>S: 3 | H: 1<br>LOB: 1<br>BB: 1<br>P: 7 | 1B: 6<br>2B: 1<br>3B: 0<br>HR: 0 | SF: 0<br>SAC: 0<br>DP: 2<br>HBP: 0 | WP: 0<br>PB: 0<br>SB: 0<br>CS: 0 | PA: 37 |             |               |
| <b>PITCHER</b><br>Barry Latman, R (1, 1)<br>ERA: 2.76  | IP<br>9.0                    | WLS<br>W                        | BF<br>37                     | H<br>7                          | R<br>0                       | ER<br>0                         | SO<br>4                      | BB<br>5                         | IBB<br>0                     | HBP<br>0                        | BLK<br>0  | WP<br>0                         | HR<br>0                      | S<br>40                         | P<br>60                      | ERA<br>0.00                     | WHIP<br>1.333                |                                 |                                  |                                    |                                  |        | ERA<br>0.00 | WHIP<br>1.333 |

livebaseballscorecards.com

|            |    |
|------------|----|
| <b>AB</b>  | 32 |
| <b>R</b>   | 0  |
| <b>H</b>   | 7  |
| <b>RBI</b> | 0  |
| <b>BB</b>  | 5  |
| <b>SO</b>  | 4  |
| <b>LOB</b> | 20 |





| Batter   | 1               | 2   | 3          | 4          | 5                | 6          | 7         | 8                                      | 9 |
|--|-----------------|---|------------|------------|------------------|------------|-----------|--|---|
| Dick Simpson, R<br>OBP: 0.167, SLG: 0.212 (1, 8)   | 0-0<br>F6       | 4-0<br>1B<br>HR<br>BB                     |            | 0-0<br>5-3 |                  | 0-0<br>5-3 |           | 4-0<br>BB<br>1B<br>BB                  |   |
| Billy Moran, R<br>OBP: 0.306, SLG: 0.302 (1, 5)    | 4-0<br>CS<br>BB | 0-0<br>1-2<br>HR<br>1B                    |            | 4-0<br>BB  |                  | 0-0<br>2B  |           | 0-0<br>F9                              |   |
| Jim Fregosi, R<br>OBP: 0.466, SLG: 0.662 (1, 6)    | 0-0<br>S<br>1B  | 0-0<br>1-H<br>2-H<br>HR                   |            | 0-3<br>K   |                  | 0-0<br>L4  |           | 4-0<br>1B<br>BB                        |   |
| Lee Thomas, L<br>OBP: 0.284, SLG: 0.343 (1, 9)     | 0-0<br>F5       | 0-0<br>HR                                 |            |            | 0-0<br>1B<br>1B  |            | 0-0<br>G3 | 0-0<br>1-3<br>2-H<br>3-H<br>1B<br>BB   |   |
| Buck Rodgers, S<br>OBP: 0.308, SLG: 0.280 (1, 2)   |                 | F8<br>F5                                  |            |            | 0-0<br>F9        |            | 0-0<br>F6 | 4-0<br>1-2<br>BB                       |   |
| Tom Satriano, L<br>OBP: 0.439, SLG: 0.400 (1, 3)   |                 | 4-0<br>1B<br>BB                           | 0-0<br>G3  |            | 0-0<br>1-3<br>1B |            | 0-0<br>1B | 0-0<br>F6                              |   |
| Ed Kirkpatrick, L<br>OBP: 0.314, SLG: 0.355 (1, 7) |                 | 0-0<br>F8                                 | 0-0<br>4-3 |            | 0-0<br>F6        |            | 0-0<br>L4 |  |   |
| Bobby Knoop, R<br>OBP: 0.290, SLG: 0.337 (1, 4)    |                 | 0-0<br>E<br>1B<br>1-2<br>1B               | 0-0<br>6-3 |            | 0-0<br>5-3       |            |           | 0-0<br>FC1-6<br>1B                     |   |
| Barry Latman, R<br>OBP: 0.182, SLG: 0.182 (1, 1)   |                 | 0-0<br>E8<br>BB<br>1-3<br>2-H<br>1B<br>1B |            | 0-0<br>F4  |                  | 0-0<br>6-3 |           | 0-0<br>FC1-6<br>BB<br>BB<br>1-2f<br>1B |   |

| Inning Stats | R: 0 | H: 1 | E: 0 | LOB: 1 | K: 0 | S: 3 | P: 7 | R: 7 | H: 5 | E: 1 | LOB: 0 | K: 0 | S: 8 | P: 16 | R: 0 | H: 0 | E: 0 | LOB: 0 | K: 0 | S: 3 | R: 0 | H: 0 | E: 0 | LOB: 1 | K: 1 | S: 5 | P: 9 | R: 0 | H: 2 | E: 0 | LOB: 2 | K: 0 | S: 5 | R: 0 | H: 1 | E: 0 | LOB: 1 | K: 0 | S: 4 | R: 0 | H: 1 | E: 0 | LOB: 1 | K: 0 | S: 4 | R: 2 | H: 2 | E: 0 | LOB: 3 | K: 0 | S: 5 | P: 17 |
|--------------|------|------|------|--------|------|------|------|------|------|------|--------|------|------|-------|------|------|------|--------|------|------|------|------|------|--------|------|------|------|------|------|------|--------|------|------|------|------|------|--------|------|------|------|------|------|--------|------|------|------|------|------|--------|------|------|-------|
|--------------|------|------|------|--------|------|------|------|------|------|------|--------|------|------|-------|------|------|------|--------|------|------|------|------|------|--------|------|------|------|------|------|------|--------|------|------|------|------|------|--------|------|------|------|------|------|--------|------|------|------|------|------|--------|------|------|-------|

| PITCHER                                   | IP  | WLS | BF | H | R | ER | SO | BB | IBB | HBP | BLK | WP | HR | S  | P  | ERA   | WHIP  |
|---|-----|-----|----|---|---|----|----|----|-----|-----|-----|----|----|----|----|-------|-------|
| Aurelio Monteagudo, R<br>ERA: 9.15 (1, 1) | 1.2 | L   | 11 | 4 | 5 | 5  | 0  | 3  | 0   | 0   | 0   | 0  | 0  | 8  | 20 | 27.00 | 4.200 |
| Vern Handrahan, R<br>ERA: 5.63 (2, 1)     | 2.1 |     | 10 | 2 | 2 | 2  | 1  | 1  | 0   | 0   | 0   | 0  | 2  | 11 | 15 | 7.71  | 1.286 |
| Ted Bowsfield, L<br>ERA: 6.1 (5, 1)       | 4.0 |     | 21 | 6 | 2 | 2  | 0  | 3  | 0   | 0   | 0   | 0  | 0  | 18 | 30 | 4.50  | 2.250 |

**BOTTOM**

**Kansas City Athletics @ Los Angeles Angels**  
**Dodger Stadium, Los Angeles, CA**  
 Wed May 13 1964, 7:05 PM PDT  
 Unknown

|    |   |   |     |    |    |     |
|----|---|---|-----|----|----|-----|
| AB | R | H | RBI | BB | SO | LOB |
| 3  | 2 | 0 | 0   | 2  | 0  | 0   |
| 3  | 1 | 2 | 2   | 2  | 0  | 2   |
| 4  | 1 | 2 | 3   | 1  | 1  | 2   |
| 5  | 1 | 3 | 3   | 0  | 0  | 1   |
| 4  | 0 | 0 | 0   | 1  | 0  | 1   |
| 4  | 1 | 2 | 0   | 1  | 0  | 3   |
| 4  | 0 | 0 | 0   | 0  | 0  | 4   |
| 4  | 1 | 2 | 0   | 0  | 0  | 2   |
| 4  | 2 | 1 | 1   | 0  | 0  | 1   |

|     |    |
|-----|----|
| AB  | 35 |
| R   | 9  |
| H   | 12 |
| RBI | 9  |
| BB  | 7  |
| SO  | 1  |
| LOB | 16 |



|    |   |     |   |    |   |    |    |
|----|---|-----|---|----|---|----|----|
| 1B | 9 | SF  | 0 | WP | 0 | PA | 42 |
| 2B | 1 | SAC | 0 | PB | 0 |    |    |
| 3B | 0 | DP  | 0 | SB | 1 |    |    |
| HR | 2 | HBP | 0 | CS | 1 |    |    |

| PITCHER | IP | WLS | BF | H | R | ER | SO | BB | IBB | HBP | BLK | WP | HR | S | P | ERA | WHIP |
|---------|----|-----|----|---|---|----|----|----|-----|-----|-----|----|----|---|---|-----|------|
|---------|----|-----|----|---|---|----|----|----|-----|-----|-----|----|----|---|---|-----|------|

| Batter  | 1   | 2                                | 3                            | 4                               | 5                            | 6                               | 7                            | 8                               | 9                            | AB R H RBI BB SO LOB            | TOP  |                                 |                              |                                 |                              |                                  |                              |                                 |                                  |                                    |                                  |        |
|---|---|----------------------------------|------------------------------|---------------------------------|------------------------------|---------------------------------|------------------------------|---------------------------------|------------------------------|---------------------------------|--|---------------------------------|------------------------------|---------------------------------|------------------------------|----------------------------------|------------------------------|---------------------------------|----------------------------------|------------------------------------|----------------------------------|--------|
| Wayne Causey, L (1, 6)<br>OBP: 0.415, SLG: 0.361    | 0-0<br>F7   | 0-3<br>K                         |                              |                                 | 0-0<br>1B                    |                                 | 0-0<br>4-3                   |                                 | 0-0<br>F9                    | 5 1 1 0 0 1 1                   | <p>Kansas City Athletics @ Los Angeles Angels</p> <p>Dodger Stadium, Los Angeles, CA</p> <p>Wed May 13 1964, 7:05 PM PDT</p> <p>Att. 7,128 - Unknown</p> |                                 |                              |                                 |                              |                                  |                              |                                 |                                  |                                    |                                  |        |
| Nelson Mathews, R (1, 8)<br>OBP: 0.382, SLG: 0.454  | 0-0<br>F6   |                                  | 0-0<br>G4-3<br>1B            |                                 | 0-0<br>1-3                   |                                 | 0-3<br>K                     |                                 | 0-3<br>K                     | 5 0 1 0 0 2 1                   |  |                                 |                              |                                 |                              |                                  |                              |                                 |                                  |                                    |                                  |        |
| Ed Charles, R (1, 5)<br>OBP: 0.375, SLG: 0.409      | 4-0<br>WP<br>BB                                       |                                  | 0-0<br>G4-3<br>1-2f          |                                 | 0-0<br>BB<br>1B              |                                 | 0-0<br>F7                    |                                 | 4-0<br>S<br>BB               | 3 0 1 1 2 0 1                   |  |                                 |                              |                                 |                              |                                  |                              |                                 |                                  |                                    |                                  |        |
| Rocky Colavito, R (1, 9)<br>OBP: 0.402, SLG: 0.625  | 4-0<br>1-2<br>BB                                      |                                  | 0-3<br>K                     |                                 | 4-0<br>G3-6-1<br>1-2<br>BB   |                                 |                              | 0-0<br>F2                       | 0-0<br>L5                    | 3 0 0 0 2 1 1                   |  |                                 |                              |                                 |                              |                                  |                              |                                 |                                  |                                    |                                  |        |
| Jim Gentile, L (1, 3)<br>OBP: 0.408, SLG: 0.530     | 0-3<br>K  |                                  |                              | 0-3<br>K                        | 0-0<br>G3-6-1<br>1-2f        |                                 |                              | 0-0<br>G3                       |                              | 4 0 0 0 0 2 4                   |  |                                 |                              |                                 |                              |                                  |                              |                                 |                                  |                                    |                                  |        |
| George Alusik, R (1, 7)<br>OBP: 0.611, SLG: 0.300   |   | 0-0<br>2B<br>1B                  |                              | 0-0<br>1B<br>1B                 |                              | 0-0<br>F7                       |                              | 4-0<br>1B<br>BB                 |                              | 3 1 2 0 1 0 0                   |  |                                 |                              |                                 |                              |                                  |                              |                                 |                                  |                                    |                                  |        |
| Jose Tartabull, L (9, 7)<br>OBP: 0.200, SLG: 0.400  |   |                                  |                              |                                 |                              |                                 |                              |                                 |                              | 0 0 0 0 0 0 0                   |  |                                 |                              |                                 |                              |                                  |                              |                                 |                                  |                                    |                                  |        |
| Doc Edwards, R (1, 2)<br>OBP: 0.273, SLG: 0.286     |   | 0-0<br>1B<br>F4<br>2B            |                              | 0-0<br>F2                       |                              | 0-3<br>K                        |                              | 0-0<br>1-3<br>1B                |                              | 4 0 2 1 0 1 1                   |  |                                 |                              |                                 |                              |                                  |                              |                                 |                                  |                                    |                                  |        |
| George Williams, R (1, 4)<br>OBP: 0.267, SLG: 0.154 |   | 0-0<br>2-3<br>1B                 |                              | 0-0<br>1-2<br>1B                |                              | 0-0<br>E5                       |                              | 4-0<br>FC6-4<br>IBB             |                              | 3 0 2 0 1 0 0                   |  |                                 |                              |                                 |                              |                                  |                              |                                 |                                  |                                    |                                  |        |
| Orlando Pena, R (1, 1)<br>OBP: 0.087, SLG: 0.045    |   | 0-0<br>F4                        |                              | 0-0<br>F7                       |                              | 0-0<br>F7                       |                              | 0-0<br>FC6-4                    |                              | 4 0 0 0 0 0 8                   |  |                                 |                              |                                 |                              |                                  |                              |                                 |                                  |                                    |                                  |        |
| John Wyatt, R (9, 1)                                |   | 3-H                              |                              |                                 |                              |                                 |                              | 1-2f                            |                              | 0 0 0 0 0 0 0                   |  |                                 |                              |                                 |                              |                                  |                              |                                 |                                  |                                    |                                  |        |
| <b>Inning Stats</b>                                 | R: 0<br>E: 0<br>K: 1<br>S: 5                          | H: 0<br>LOB: 2<br>BB: 2<br>P: 13 | R: 1<br>E: 0<br>K: 1<br>S: 7 | H: 3<br>LOB: 1<br>BB: 0<br>P: 7 | R: 0<br>E: 0<br>K: 1<br>S: 5 | H: 1<br>LOB: 0<br>BB: 0<br>P: 5 | R: 0<br>E: 0<br>K: 1<br>S: 7 | H: 2<br>LOB: 2<br>BB: 0<br>P: 7 | R: 1<br>E: 0<br>K: 0<br>S: 4 | H: 2<br>LOB: 1<br>BB: 1<br>P: 8 | R: 0<br>E: 1<br>K: 1<br>S: 6   | H: 0<br>LOB: 1<br>BB: 0<br>P: 6 | R: 0<br>E: 0<br>K: 1<br>S: 5 | H: 0<br>LOB: 0<br>BB: 0<br>P: 5 | R: 0<br>E: 0<br>K: 0<br>S: 4 | H: 1<br>LOB: 3<br>BB: 2<br>P: 12 | R: 0<br>E: 0<br>K: 1<br>S: 5 | H: 0<br>LOB: 1<br>BB: 1<br>P: 9 | 1B: 8<br>2B: 1<br>3B: 0<br>HR: 0 | SF: 0<br>SAC: 0<br>DP: 2<br>HBP: 0 | WP: 1<br>PB: 0<br>SB: 1<br>CS: 0 | PA: 40 |
| <b>PITCHER</b>                                      | IP WLS BF H R ER SO BB IBB HBP BLK WP HR S P ERA WHIP |                                  |                              |                                 |                              |                                 |                              |                                 |                              |                                 |  |                                 |                              |                                 |                              |                                  |                              |                                 |                                  |                                    |                                  |        |
| Bo Belinsky, L (1, 1)<br>ERA: 3.47                  | 5.0 L 23 8 2 2 4 3 0 0 0 1 0 28 40 3.60 2.200         |                                  |                              |                                 |                              |                                 |                              |                                 |                              |                                 |  |                                 |                              |                                 |                              |                                  |                              |                                 |                                  |                                    |                                  |        |
| Don Lee, R (6, 1)<br>ERA: 2.57                      | 1.0 4 0 0 0 1 0 0 0 0 0 0 6 6 0.00 0.000              |                                  |                              |                                 |                              |                                 |                              |                                 |                              |                                 |  |                                 |                              |                                 |                              |                                  |                              |                                 |                                  |                                    |                                  |        |
| Dan Osinski, R (7, 1)<br>ERA: 1.65                  | 2.0 9 1 0 0 1 1 1 0 0 0 0 9 17 0.00 1.000             |                                  |                              |                                 |                              |                                 |                              |                                 |                              |                                 |  |                                 |                              |                                 |                              |                                  |                              |                                 |                                  |                                    |                                  |        |
| Dean Chance, R (9, 1)<br>ERA: 2.08                  | 1.0 4 0 0 0 1 1 0 0 0 0 0 5 9 0.00 1.000              |                                  |                              |                                 |                              |                                 |                              |                                 |                              |                                 |  |                                 |                              |                                 |                              |                                  |                              |                                 |                                  |                                    |                                  |        |

|     |    |
|-----|----|
| AB  | 34 |
| R   | 2  |
| H   | 9  |
| RBI | 2  |
| BB  | 6  |
| SO  | 7  |
| LOB | 17 |

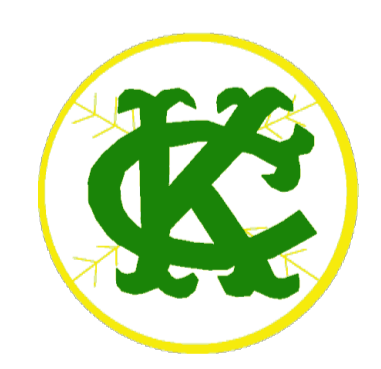

livebaseballscorecards.com

| Batter   | 1               | 2                              | 3              | 4               | 5                          | 6                       | 7                     | 8               | 9                     | AB R H RBI BB SO LOB  |
|--|-----------------|--------------------------------|----------------|-----------------|----------------------------|-------------------------|-----------------------|-----------------|-----------------------|---|
| Dick Simpson, R<br>OBP: 0.175, SLG: 0.194<br>(1, 8) X  | 0-0<br>1-3<br>① |                                | 0-3<br>K<br>②  |                 |                            | 0-0<br>FC5-4<br>①       |                       |                 | 4-0<br>1B<br>BB<br>①  | 3 0 0 0 1 1 1   |
| Billy Moran, R<br>OBP: 0.296, SLG: 0.291<br>(1, 5) X   | 0-0<br>5-3<br>② |                                | 0-3<br>K<br>③  |                 |                            | 0-0<br>G4-6-3<br>②      |                       |                 | 0-0<br>F9<br>①        | 4 0 0 0 0 1 2   |
| Jim Fregosi, R<br>OBP: 0.457, SLG: 0.654<br>(1, 6) S S   | 0-3<br>K<br>③   |                                |                | 0-0<br>6-3<br>① |                            |                         | 0-0<br>4-3<br>2B<br>① |                 | 0-0<br>F8<br>②        | 4 0 1 0 0 1 1   |
| Lee Thomas, L<br>OBP: 0.283, SLG: 0.340<br>(1, 9) S S  |                 | 0-3<br>K<br>①                  |                | 0-0<br>F6<br>②  |                            |                         | 0-0<br>4-3<br>①       |                 | 0-0<br>1-3<br>1B<br>① | 4 0 1 0 0 1 1   |
| Buck Rodgers, S<br>OBP: 0.306, SLG: 0.278<br>(1, 2) X  |                 | 0-0<br>1B<br>1B<br>①           |                | 0-0<br>2-3<br>③ |                            |                         | 0-3<br>K<br>②         |                 | 0-3<br>K<br>③         | 4 0 1 0 0 2 3   |
| Tom Satriano, L<br>OBP: 0.409, SLG: 0.368<br>(1, 3) X  |                 | 0-0<br>F8<br>②                 |                |                 | 0-3<br>K<br>①              |                         | 0-3<br>K<br>③         |                 |                       | 3 0 0 0 0 2 2   |
| Ed Kirkpatrick, L<br>OBP: 0.329, SLG: 0.359<br>(1, 7) X  |                 | 0-0<br>FC6-4<br>1-2<br>1B<br>① |                |                 | 4-0<br>G4-6-3<br>BB<br>①   |                         |                       | 0-3<br>K<br>①   |                       | 2 0 1 0 1 1 0   |
| Bobby Knoop, R<br>OBP: 0.282, SLG: 0.326<br>(1, 4) X   |                 | 0-0<br>FC6-4<br>1-2f<br>③      |                |                 | 0-0<br>G4-6-3<br>1-2f<br>③ |                         |                       | 0-0<br>L6<br>②  |                       | 3 0 0 0 0 0 3   |
| Bo Belinsky, L<br>Don Lee, R<br>Albie Pearson, L<br>Willie Smith, L<br>Dan Osinski, R<br>Charlie Dees, L<br>Dean Chance, R<br>(1, 1) X<br>(6, 1) OBP: 0.500, SLG: 0.500<br>(6, PH) OBP: 0.316, SLG: 0.352<br>(6, PR)<br>(7, 1)<br>(8, PH) OBP: 0.211, SLG: 0.176<br>(9, 1) |                 |                                | 0-0<br>F6<br>① |                 |                            | 4-0<br>FC5-4<br>BB<br>① |                       | 0-0<br>1-3<br>③ |                       | 1 0 0 0 0 0 0<br>0 0 0 0 0 0 0<br>0 0 0 0 1 0 0<br>0 0 0 0 0 0 0<br>0 0 0 0 0 0 0<br>1 0 0 0 0 0 0<br>0 0 0 0 0 0 0 |

| Inning Stats | R: 0 | H: 0 | E: 0 | K: 1 | S: 5 | LOB: 0 | BB: 0 | P: 5 | R: 0 | H: 2 | E: 0 | K: 1 | S: 7 | LOB: 2 | BB: 0 | P: 7 | R: 0 | H: 0 | E: 0 | K: 2 | S: 7 | LOB: 0 | BB: 0 | P: 7 | R: 0 | H: 0 | E: 0 | K: 0 | S: 3 | LOB: 0 | BB: 0 | P: 3 | R: 0 | H: 0 | E: 0 | K: 1 | S: 4 | LOB: 1 | BB: 1 | P: 8 | R: 0 | H: 1 | E: 0 | K: 2 | S: 8 | LOB: 1 | BB: 0 | P: 8 | R: 0 | H: 0 | E: 0 | K: 1 | S: 5 | LOB: 0 | BB: 0 | P: 5 | R: 0 | H: 1 | E: 0 | K: 1 | S: 6 | LOB: 2 | BB: 1 | P: 10 | 1B: 3 | SF: 0 | 2B: 1 | SAC: 0 | 3B: 0 | DP: 2 | HR: 0 | HBP: 0 | WP: 0 | PA: 32 |
|--------------|------|------|------|------|------|--------|-------|------|------|------|------|------|------|--------|-------|------|------|------|------|------|------|--------|-------|------|------|------|------|------|------|--------|-------|------|------|------|------|------|------|--------|-------|------|------|------|------|------|------|--------|-------|------|------|------|------|------|------|--------|-------|------|------|------|------|------|------|--------|-------|-------|-------|-------|-------|--------|-------|-------|-------|--------|-------|--------|
|--------------|------|------|------|------|------|--------|-------|------|------|------|------|------|------|--------|-------|------|------|------|------|------|------|--------|-------|------|------|------|------|------|------|--------|-------|------|------|------|------|------|------|--------|-------|------|------|------|------|------|------|--------|-------|------|------|------|------|------|------|--------|-------|------|------|------|------|------|------|--------|-------|-------|-------|-------|-------|--------|-------|-------|-------|--------|-------|--------|

| PITCHER                                | IP  | WLS | BF | H | R | ER | SO | BB | IBB | HBP | BLK | WP | HR | S  | P  | ERA  | WHIP  |
|--|-----|-----|----|---|---|----|----|----|-----|-----|-----|----|----|----|----|------|-------|
| Orlando Pena, R<br>ERA: 3.48<br>(1, 1) | 8.0 | W   | 28 | 3 | 0 | 0  | 8  | 3  | 0   | 0   | 0   | 0  | 0  | 41 | 53 | 0.00 | 0.750 |
| John Wyatt, R<br>ERA: 0.95<br>(9, 1)   | 1.0 | S   | 4  | 1 | 0 | 0  | 1  | 0  | 0   | 0   | 0   | 0  | 0  | 6  | 6  | 0.00 | 1.000 |

**BOTTOM**

Kansas City Athletics @ Los Angeles Angels  
 Dodger Stadium, Los Angeles, CA  
 Wed May 13 1964, 7:05 PM PDT  
 Att. 7,128 - Unknown

livebaseballscorecards.com

|     |    |
|-----|----|
| AB  | 29 |
| R   | 0  |
| H   | 4  |
| RBI | 0  |
| BB  | 3  |
| SO  | 9  |
| LOB | 13 |



| Batter   | 1   | 2                               | 3                            | 4                               | 5                            | 6                               | 7                            | 8                               | 9                            | AB R H RBI BB SO LOB            | TOP                          |                                  |                              |                                 |                                   |                                    |                                  |        |
|--|---|---------------------------------|------------------------------|---------------------------------|------------------------------|---------------------------------|------------------------------|---------------------------------|------------------------------|---------------------------------|------------------------------|----------------------------------|------------------------------|---------------------------------|-----------------------------------|------------------------------------|----------------------------------|--------|
| Wayne Causey, L (1, 6)<br>OBP: 0.411, SLG: 0.359   | 0-0<br>1B   |                                 | 0-3<br>K                     |                                 |                              | 0-0<br>1B                       |                              | 0-0<br>4-3                      | 0-0<br>FC1-6                 | 6 1 2 0 0 1 6                   |                              |                                  |                              |                                 |                                   |                                    |                                  |        |
| Nelson Mathews, R (1, 8)<br>OBP: 0.379, SLG: 0.456 | 0-3<br>K  |                                 | 0-3<br>K                     |                                 |                              | 0-0<br>1B                       | 0-0<br>E6                    | 0-0<br>1B                       | 0-0<br>F9                    | 6 2 2 2 0 2 2                   |                              |                                  |                              |                                 |                                   |                                    |                                  |        |
| Ed Charles, R (1, 5)<br>OBP: 0.385, SLG: 0.407     | 0-0<br>F8   |                                 |                              | 0-0<br>F5                       |                              | 0-0<br>1B                       | 4-0<br>1B                    | 4-0<br>1B                       |                              | 3 2 1 1 2 0 1                   |                              |                                  |                              |                                 |                                   |                                    |                                  |        |
| Jim Gentile, L (1, 3)<br>OBP: 0.398, SLG: 0.511    | 0-3<br>K  |                                 |                              | 0-0<br>F8                       |                              | 0-3<br>K                        | 0-0<br>1B                    | 0-0<br>E7                       |                              | 5 0 1 0 0 2 5                   |                              |                                  |                              |                                 |                                   |                                    |                                  |        |
| Rocky Colavito, R (1, 9)<br>OBP: 0.409, SLG: 0.659 |   | 0-0<br>HR                       |                              | 0-3<br>K                        |                              | 0-0<br>2B                       | 0-0<br>F5                    | 0-0<br>1B                       |                              | 3 1 2 2 0 1 0                   |                              |                                  |                              |                                 |                                   |                                    |                                  |        |
| Orlando Pena, R (6, PR)<br>OBP: 0.087, SLG: 0.045  |   |                                 |                              |                                 |                              | 1-3<br>2B                       |                              | 1-2<br>1B                       |                              | 0 1 0 0 0 0 0                   |                              |                                  |                              |                                 |                                   |                                    |                                  |        |
| Doc Edwards, R (6, 2)<br>OBP: 0.283, SLG: 0.295    |   |                                 |                              |                                 |                              | 3-H<br>1B                       |                              | 3-H<br>1B                       |                              | 2 0 1 2 0 0 2                   |                              |                                  |                              |                                 |                                   |                                    |                                  |        |
| Manny Jimenez, L (1, 7)<br>OBP: 0.225, SLG: 0.417  |   | 0-0<br>1B                       |                              |                                 | 0-0<br>F5                    | 4-0<br>2B                       | 0-0<br>F8                    | 0-0<br>5-3                      |                              | 4 1 1 0 1 0 4                   |                              |                                  |                              |                                 |                                   |                                    |                                  |        |
| Jose Tartabull, L (8, 7)<br>OBP: 0.200, SLG: 0.400 |   | G5-4-3<br>1B                    |                              |                                 |                              | 1-2<br>2B                       |                              | 1-2<br>2-3                      |                              | 0 0 0 0 0 0 0                   |                              |                                  |                              |                                 |                                   |                                    |                                  |        |
| Charlie Lau, L (1, 2)<br>OBP: 0.373, SLG: 0.509    |   |                                 | 0-0<br>F3                    |                                 | 0-0<br>F8                    | 4-0<br>2B                       |                              | 1-2<br>1B                       |                              | 2 0 0 0 0 0 1                   |                              |                                  |                              |                                 |                                   |                                    |                                  |        |
| George Alusik, R (6, PH)<br>OBP: 0.619, SLG: 0.273 |   |                                 |                              |                                 |                              | 1-2<br>2-3                      |                              | BB                              | L4                           | 1 1 0 1 2 0 2                   |                              |                                  |                              |                                 |                                   |                                    |                                  |        |
| Dick Green, R (1, 4)<br>OBP: 0.262, SLG: 0.351     |   | 0-0<br>G5-4-3                   |                              |                                 | 0-3<br>K                     | 0-0<br>2B                       |                              | 0-0<br>1B                       | 0-0<br>FC1-6                 | 5 1 3 2 0 1 1                   |                              |                                  |                              |                                 |                                   |                                    |                                  |        |
| Diego Segui, R (1, 1)<br>OBP: 0.333, SLG: 0.500    |   |                                 | 0-3<br>K                     |                                 |                              | 1-3<br>2-3                      |                              | 0-0<br>1B                       | 0-3<br>K                     | 4 1 1 1 0 2 1                   |                              |                                  |                              |                                 |                                   |                                    |                                  |        |
| <b>Inning Stats</b>                                | R: 0<br>E: 0<br>K: 2<br>S: 8                          | H: 1<br>LOB: 1<br>BB: 0<br>P: 8 | R: 1<br>E: 0<br>K: 0<br>S: 4 | H: 2<br>LOB: 0<br>BB: 0<br>P: 4 | R: 0<br>E: 0<br>K: 3<br>S: 9 | H: 0<br>LOB: 0<br>BB: 0<br>P: 9 | R: 0<br>E: 0<br>K: 1<br>S: 5 | H: 0<br>LOB: 0<br>BB: 0<br>P: 5 | R: 0<br>E: 1<br>K: 0<br>S: 4 | H: 1<br>LOB: 2<br>BB: 1<br>P: 8 | R: 5<br>E: 1<br>K: 0<br>S: 8 | H: 4<br>LOB: 2<br>BB: 2<br>P: 16 | R: 0<br>E: 0<br>K: 1<br>S: 6 | H: 1<br>LOB: 1<br>BB: 0<br>P: 6 | 1B: 11<br>2B: 2<br>3B: 0<br>HR: 1 | SF: 0<br>SAC: 0<br>DP: 1<br>HBP: 1 | WP: 0<br>PB: 0<br>SB: 0<br>CS: 1 | PA: 47 |
| <b>PITCHER</b>                                     | IP WLS BF H R ER SO BB IBB HBP BLK WP HR S P ERA WHIP |                                 |                              |                                 |                              |                                 |                              |                                 |                              |                                 |                              |                                  |                              |                                 |                                   |                                    |                                  |        |
| Ralph Terry, R (1, 1)<br>ERA: 4.79                 | 5.2 L 23 7 5 5 8 0 0 0 0 0 0 1 39 39 7.94 1.235       |                                 |                              |                                 |                              |                                 |                              |                                 |                              |                                 |                              |                                  |                              |                                 |                                   |                                    |                                  |        |
| Bud Daley, L (6, 1)<br>ERA: 3.97                   | 1.1 10 2 1 1 0 3 0 0 1 0 0 0 6 19 6.75 3.750          |                                 |                              |                                 |                              |                                 |                              |                                 |                              |                                 |                              |                                  |                              |                                 |                                   |                                    |                                  |        |
| Pete Mikkelsen, R (8, 1)<br>ERA: 9.31              | 1.0 10 4 5 4 0 2 0 0 0 0 0 0 8 16 36.00 6.000         |                                 |                              |                                 |                              |                                 |                              |                                 |                              |                                 |                              |                                  |                              |                                 |                                   |                                    |                                  |        |
| Bob Meyer, L (9, 1)<br>ERA: 5.87                   | 1.0 4 1 0 0 0 1 0 0 0 0 0 0 6 6 0.00 1.000            |                                 |                              |                                 |                              |                                 |                              |                                 |                              |                                 |                              |                                  |                              |                                 |                                   |                                    |                                  |        |

**Kansas City Athletics @ New York Yankees**  
 Yankee Stadium, Bronx, NY  
 Fri May 15 1964, 7:05 PM EDT  
 Att. 13,445 - Unknown - 62 F

|     |    |
|-----|----|
| AB  | 41 |
| R   | 11 |
| H   | 14 |
| RBI | 11 |
| BB  | 5  |
| SO  | 9  |
| LOB | 25 |



| Batter   | 1         | 2             | 3          | 4          | 5          | 6                  | 7                | 8         | 9           | AB R H RBI BB SO LOB   |
|--|-----------|---------------|------------|------------|------------|--------------------|------------------|-----------|-------------|--|
| Phil Linz, R<br>OBP: 0.232, SLG: 0.208<br>(1, 6)   | 0-3<br>K  |               | 0-0<br>6-3 |            | 0-0<br>F2  |                    | 0-0<br>F2        |           | 0-0<br>B1-3 | 5 0 0 0 0 1 5  |
| Bobby Richardson, R<br>OBP: 0.348, SLG: 0.352<br>(1, 4)  | 0-0<br>F8 |               |            | 0-0<br>F6  |            | 0-0<br>6-3         |                  | 0-0<br>1B |             | 4 0 1 0 0 0 0  |
| Roger Maris, L<br>OBP: 0.364, SLG: 0.535<br>(1, 9)   | 0-0<br>1B |               |            | 0-0<br>1B  |            | 0-3<br>K           |                  | 0-0<br>F2 |             | 4 0 2 0 0 1 1  |
| Mickey Mantle, S<br>OBP: 0.424, SLG: 0.485<br>Archie Moore, L<br>(6, PR)<br>(7, 3)   | 0-0<br>L5 |               |            | 0-0<br>F8  |            | 4-0<br>FC6-4<br>BB |                  | 0-3<br>K  |             | 2 0 0 0 1 0 2<br>1 0 0 0 0 1 1   |
| Hector Lopez, R<br>OBP: 0.310, SLG: 0.500<br>(1, 7)  |           | 0-0<br>1B     |            | 0-0<br>1B  |            | 0-0<br>FC6-4       |                  | 0-0<br>F7 |             | 4 0 2 0 0 0 2  |
| Joe Pepitone, L<br>OBP: 0.304, SLG: 0.348<br>(1, 3)<br>(7, 8)  |           | 0-0<br>G3-6-3 |            | 0-0<br>4-3 |            |                    | 0-0<br>1-3<br>1B |           | 0-0<br>L6   | 4 0 1 0 0 0 3  |
| Elston Howard, R<br>OBP: 0.348, SLG: 0.400<br>(1, 2)   |           | 0-0<br>F8     |            |            | 0-0<br>6-3 |                    | 0-0<br>1-3<br>1B |           | 0-0<br>1-3  | 4 0 1 0 0 0 0  |
| Clete Boyer, R<br>OBP: 0.232, SLG: 0.200<br>(1, 5)   |           |               | 0-0<br>F5  |            | 0-0<br>1-3 |                    | 0-0<br>1-3       |           | 0-0<br>1B   | 4 0 1 0 0 0 2  |
| Ralph Terry, R<br>OBP: 0.250, SLG: 0.286<br>Bud Daley, L<br>(6, 1)<br>Pedro Gonzalez, R<br>OBP: 0.313, SLG: 0.276<br>Pete Mikkelsen, R<br>(8, 1)<br>Bob Meyer, R<br>(9, 1)<br>Johnny Blanchard, L<br>OBP: 0.406, SLG: 0.227<br>(9, PH) |           |               | 0-0<br>6-3 |            | 4-0<br>BB  |                    | 0-0<br>F2        |           | 0-0<br>1B   | 1 0 0 0 0 1 0 0<br>0 0 0 0 0 0 0 0<br>1 0 0 0 0 0 0 2<br>0 0 0 0 0 0 0 0<br>0 0 0 0 0 0 0 0<br>1 0 1 0 0 0 0 0 |

| Inning Stats                                    | R: 0   | H: 1                                       | E: 0   | LOB: 1                                     | K: 1                                       | BB: 0                                      | S: 6   | P: 6 |
|---|--|--|--|--|--|--|--|------|
| R: 0 H: 1 E: 0 LOB: 0 K: 0 BB: 0 S: 3 P: 3      | R: 0 H: 0 E: 0 LOB: 0 K: 0 BB: 0 S: 3 P: 3   | R: 0 H: 2 E: 0 LOB: 2 K: 0 BB: 0 S: 5 P: 5 | R: 0 H: 0 E: 0 LOB: 1 K: 0 BB: 1 S: 3 P: 7                             | R: 0 H: 0 E: 0 LOB: 1 K: 1 BB: 1 S: 5 P: 9 | R: 0 H: 1 E: 0 LOB: 1 K: 1 BB: 0 S: 6 P: 6 | R: 0 H: 2 E: 0 LOB: 2 K: 0 BB: 0 S: 5 P: 5 | 1B: 9 SF: 0<br>2B: 0 SAC: 0<br>3B: 0 DP: 1<br>HR: 0 HBP: 0 |      |
| PITCHER<br>Diego Segui, R<br>ERA: 3.4<br>(1, 1) | IP: 9.0 WLS: W BF: 37 H: 9 R: 0 ER: 0 SO: 3 BB: 2 IBB: 0 HBP: 0 BLK: 0 WP: 0 HR: 0 S: 41 P: 49 ERA: 0.00 WHIP: 1.222 | PITCHER                                    | IP: WLS: BF: H: R: ER: SO: BB: IBB: HBP: BLK: WP: HR: S: P: ERA: WHIP: |  |  |  |  |      |

**BOTTOM**

**Kansas City Athletics @ New York Yankees**  
Yankee Stadium, Bronx, NY

Fri May 15 1964, 7:05 PM EDT  
Att: 13,445 - Unknown - 62 F

livebaseballscorecards.com

|     |    |
|-----|----|
| AB  | 35 |
| R   | 0  |
| H   | 9  |
| RBI | 0  |
| BB  | 2  |
| SO  | 3  |
| LOB | 18 |



|       |        |
|-------|--------|
| WP: 0 | PA: 37 |
| PB: 0 |        |
| SB: 0 |        |
| CS: 0 |        |

| Batter  | 1   | 2                               | 3                            | 4                               | 5                            | 6                                | 7                            | 8                               | 9                            | AB R H RBI BB SO LOB            | TOP                          |                                 |                              |                                 |                              |                                 |                              |                                 |                                  |                                    |                                  |        |  |  |  |  |  |  |  |  |  |  |  |  |  |  |
|---|---|---------------------------------|------------------------------|---------------------------------|------------------------------|----------------------------------|------------------------------|---------------------------------|------------------------------|---------------------------------|------------------------------|---------------------------------|------------------------------|---------------------------------|------------------------------|---------------------------------|------------------------------|---------------------------------|----------------------------------|------------------------------------|----------------------------------|--------|--|--|--|--|--|--|--|--|--|--|--|--|--|--|
| Wayne Causey, L (1, 6)<br>OBP: 0.395, SLG: 0.343        | 0-0<br>3-1  |                                 | 0-0<br>FC5-4<br>BB 1B        | 0-0<br>G4-6-3                   |                              | 0-0<br>4-3                       |                              |                                 | 0-0<br>1-3                   | 5 1 0 0 0 0 3                   |                              |                                 |                              |                                 |                              |                                 |                              |                                 |                                  |                                    |                                  |        |  |  |  |  |  |  |  |  |  |  |  |  |  |  |
| Nelson Mathews, R (1, 8)<br>OBP: 0.372, SLG: 0.444      | 0-3<br>K  |                                 | 0-0<br>1B 1B                 |                                 | 0-0<br>F8                    |                                  | 0-0<br>F7                    |                                 | 0-0<br>L9                    | 5 1 1 0 0 1 0                   |                              |                                 |                              |                                 |                              |                                 |                              |                                 |                                  |                                    |                                  |        |  |  |  |  |  |  |  |  |  |  |  |  |  |  |
| Ed Charles, R (1, 5)<br>OBP: 0.386, SLG: 0.400          | 0-0<br>6-3  |                                 | 4-0<br>1B SF9                |                                 | 0-0<br>2B HR                 |                                  | 0-3<br>K                     |                                 | 0-0<br>F9                    | 4 2 1 0 1 1 0                   |                              |                                 |                              |                                 |                              |                                 |                              |                                 |                                  |                                    |                                  |        |  |  |  |  |  |  |  |  |  |  |  |  |  |  |
| Jim Gentile, L (1, 3)<br>OBP: 0.393, SLG: 0.500         |   | 0-0<br>3-1                      | 0-0<br>1B                    |                                 | 0-3<br>K                     |                                  | 0-0<br>4-3                   |                                 |                              | 4 0 1 2 0 1 1                   |                              |                                 |                              |                                 |                              |                                 |                              |                                 |                                  |                                    |                                  |        |  |  |  |  |  |  |  |  |  |  |  |  |  |  |
| George Alusik, R (1, 7)<br>OBP: 0.600, SLG: 0.500       |   | 0-0<br>5-3                      | 0-0<br>SF9                   |                                 | 0-0<br>HR                    |                                  |                              | 0-0<br>F8                       |                              | 3 1 2 1 0 0 0                   |                              |                                 |                              |                                 |                              |                                 |                              |                                 |                                  |                                    |                                  |        |  |  |  |  |  |  |  |  |  |  |  |  |  |  |
| Manny Jimenez, L (1, 9)<br>OBP: 0.273, SLG: 0.538       |   | 0-0<br>2B                       | 0-0<br>F6                    |                                 | 0-0<br>HR                    |                                  |                              | 4-0<br>BB                       |                              | 3 1 2 3 1 0 1                   |                              |                                 |                              |                                 |                              |                                 |                              |                                 |                                  |                                    |                                  |        |  |  |  |  |  |  |  |  |  |  |  |  |  |  |
| Charlie Lau, L (1, 2)<br>OBP: 0.387, SLG: 0.509         |   | 4-0<br>FC6-4                    |                              | 0-0<br>FC5-6                    |                              | 0-0<br>L7                        |                              | 0-0<br>F8                       |                              | 2 0 1 0 1 0 0                   |                              |                                 |                              |                                 |                              |                                 |                              |                                 |                                  |                                    |                                  |        |  |  |  |  |  |  |  |  |  |  |  |  |  |  |
| Doc Edwards, R (8, PH)<br>OBP: 0.277, SLG: 0.289        |   |                                 |                              |                                 |                              |                                  |                              |                                 |                              | 1 0 0 0 0 0 2                   |                              |                                 |                              |                                 |                              |                                 |                              |                                 |                                  |                                    |                                  |        |  |  |  |  |  |  |  |  |  |  |  |  |  |  |
| Aurelio Monteaugado, R (8, 1)<br>OBP: 0.400, SLG: 0.800 |   |                                 |                              |                                 |                              |                                  |                              |                                 |                              | 0 0 0 0 0 0 0                   |                              |                                 |                              |                                 |                              |                                 |                              |                                 |                                  |                                    |                                  |        |  |  |  |  |  |  |  |  |  |  |  |  |  |  |
| Dick Green, R (1, 4)<br>OBP: 0.262, SLG: 0.340          |   | 0-0<br>FC6-4                    |                              | 4-0<br>FC5-6                    |                              | 0-0<br>1-3                       |                              | 0-0<br>F8                       |                              | 3 0 0 0 1 0 4                   |                              |                                 |                              |                                 |                              |                                 |                              |                                 |                                  |                                    |                                  |        |  |  |  |  |  |  |  |  |  |  |  |  |  |  |
| Moe Drabowsky, R (1, 1)<br>OBP: 0.091, SLG: 0.091       |   |                                 | 0-0<br>FC5-4                 |                                 | 0-0<br>FC5-6                 |                                  | 0-0<br>5-3                   |                                 | 0-0<br>L9                    | 1 0 1 0 0 0 0                   |                              |                                 |                              |                                 |                              |                                 |                              |                                 |                                  |                                    |                                  |        |  |  |  |  |  |  |  |  |  |  |  |  |  |  |
| Joe Grzenda, R (3, 1)                                   |   |                                 |                              |                                 |                              |                                  |                              |                                 |                              | 1 0 0 0 0 0 2                   |                              |                                 |                              |                                 |                              |                                 |                              |                                 |                                  |                                    |                                  |        |  |  |  |  |  |  |  |  |  |  |  |  |  |  |
| Jack Aker, R (5, 1)                                     |   |                                 |                              |                                 |                              |                                  |                              |                                 |                              | 1 0 0 0 0 0 0                   |                              |                                 |                              |                                 |                              |                                 |                              |                                 |                                  |                                    |                                  |        |  |  |  |  |  |  |  |  |  |  |  |  |  |  |
| Billy Bryan, L (8, PH)<br>OBP: 0.357, SLG: 0.727        |   |                                 | 1B                           | 1-2<br>2-3f                     |                              |                                  |                              |                                 |                              | 1 0 0 0 0 0 2                   |                              |                                 |                              |                                 |                              |                                 |                              |                                 |                                  |                                    |                                  |        |  |  |  |  |  |  |  |  |  |  |  |  |  |  |
| <b>Inning Stats</b>                                     | R: 0<br>E: 0<br>K: 1<br>S: 5                          | H: 0<br>LOB: 0<br>BB: 0<br>P: 5 | R: 0<br>E: 0<br>K: 0<br>S: 4 | H: 1<br>LOB: 2<br>BB: 1<br>P: 8 | R: 3<br>E: 0<br>K: 0<br>S: 6 | H: 3<br>LOB: 1<br>BB: 1<br>P: 10 | R: 0<br>E: 0<br>K: 0<br>S: 3 | H: 1<br>LOB: 1<br>BB: 1<br>P: 7 | R: 3<br>E: 0<br>K: 1<br>S: 8 | H: 3<br>LOB: 0<br>BB: 0<br>P: 8 | R: 0<br>E: 0<br>K: 0<br>S: 3 | H: 0<br>LOB: 0<br>BB: 0<br>P: 3 | R: 0<br>E: 0<br>K: 1<br>S: 5 | H: 0<br>LOB: 0<br>BB: 0<br>P: 5 | R: 0<br>E: 0<br>K: 0<br>S: 4 | H: 1<br>LOB: 2<br>BB: 1<br>P: 8 | R: 0<br>E: 0<br>K: 0<br>S: 3 | H: 0<br>LOB: 0<br>BB: 0<br>P: 3 | 1B: 5<br>2B: 3<br>3B: 0<br>HR: 1 | SF: 1<br>SAC: 0<br>DP: 1<br>HBP: 0 | WP: 0<br>PB: 0<br>SB: 0<br>CS: 0 | PA: 39 |  |  |  |  |  |  |  |  |  |  |  |  |  |  |
| <b>PITCHER</b>  | IP WLS BF H R ER SO BB IBB HBP BLK WP HR S P ERA WHIP |                                 |                              |                                 |                              |                                  |                              |                                 |                              |                                 |                              |                                 |                              |                                 |                              |                                 |                              |                                 |                                  |                                    |                                  |        |  |  |  |  |  |  |  |  |  |  |  |  |  |  |
| Stan Williams, R (1, 1)<br>ERA: 5.4                     | 3.0   |                                 | 15                           | 4                               | 3                            | 3                                | 1                            | 2                               | 0                            | 0                               | 0                            | 0                               | 0                            | 15                              | 23                           | 9.00                            | 2.000                        |                                 |                                  |                                    |                                  |        |  |  |  |  |  |  |  |  |  |  |  |  |  |  |
| Steve Hamilton, L (4, 1)<br>ERA: 2.08                   | 4.0   | W                               | 18                           | 5                               | 3                            | 3                                | 2                            | 2                               | 0                            | 0                               | 0                            | 0                               | 1                            | 20                              | 28                           | 6.75                            | 1.750                        |                                 |                                  |                                    |                                  |        |  |  |  |  |  |  |  |  |  |  |  |  |  |  |
| Hal Reniff, R (8, 1)<br>ERA:                            | 2.0   | S                               | 6                            | 0                               | 0                            | 0                                | 0                            | 0                               | 0                            | 0                               | 0                            | 0                               | 0                            | 6                               | 6                            | 0.00                            | 0.000                        |                                 |                                  |                                    |                                  |        |  |  |  |  |  |  |  |  |  |  |  |  |  |  |

**Kansas City Athletics @ New York Yankees**  
 Yankee Stadium, Bronx, NY  
 Sat May 16 1964, 3:33 AM EDT  
 Att. 11,145 - Unknown - 70 F

|     |    |
|-----|----|
| AB  | 34 |
| R   | 6  |
| H   | 9  |
| RBI | 6  |
| BB  | 4  |
| SO  | 3  |
| LOB | 15 |



|       |        |
|-------|--------|
| WP: 0 | PA: 39 |
| PB: 0 |        |
| SB: 0 |        |
| CS: 0 |        |

| PITCHER           | IP  | WLS | BF | H | R | ER | SO | BB | IBB | HBP | BLK | WP | HR | S  | P  | ERA  | WHIP  |
|-------------------|-----|-----|----|---|---|----|----|----|-----|-----|-----|----|----|----|----|------|-------|
| Stan Williams, R  | 3.0 |     | 15 | 4 | 3 | 3  | 1  | 2  | 0   | 0   | 0   | 0  | 0  | 15 | 23 | 9.00 | 2.000 |
| Steve Hamilton, L | 4.0 | W   | 18 | 5 | 3 | 3  | 2  | 2  | 0   | 0   | 0   | 0  | 1  | 20 | 28 | 6.75 | 1.750 |
| Hal Reniff, R     | 2.0 | S   | 6  | 0 | 0 | 0  | 0  | 0  | 0   | 0   | 0   | 0  | 0  | 6  | 6  | 0.00 | 0.000 |

| Batter   | 1         | 2               | 3                  | 4                           | 5                  | 6            | 7                | 8          | 9 |
|--|-----------|-----------------|--------------------|-----------------------------|--------------------|--------------|------------------|------------|---|
| Phil Linz, R<br>OBP: 0.230, SLG: 0.207<br>(1, 6)   | 0-0<br>F6 |                 | 0-0<br>L6          | 0-0<br>WP<br>1B<br>1B       |                    | 0-0<br>B1-3  | 0-0<br>6-3       |            |   |
| Bobby Richardson, R<br>OBP: 0.359, SLG: 0.352<br>(1, 4)  | 0-0<br>F4 |                 | 4-0<br>HR<br>BB    | 0-0<br>HR<br>1B             |                    | 4-0<br>BB    |                  | 0-0<br>L8  |   |
| Roger Maris, L<br>OBP: 0.367, SLG: 0.646<br>(1, 9)   | 0-0<br>HR |                 | 0-0<br>HR          | 0-0<br>F5                   |                    | 0-0<br>F9    |                  | 0-0<br>F2  |   |
| Mickey Mantle, S<br>OBP: 0.411, SLG: 0.507<br>Pedro Gonzalez, R<br>OBP: 0.313, SLG: 0.276<br>(1, 8)<br>(9, 3)  | 0-3<br>K  |                 | 0-0<br>F8          | 0-0<br>HR                   |                    | 0-0<br>F8    |                  | 0-0<br>4-3 |   |
| Hector Lopez, R<br>OBP: 0.320, SLG: 0.521<br>(1, 7)  |           | 0-0<br>1B<br>3B | 4-0<br>1B<br>BB    | 0-0<br>6-3                  |                    |              | 0-3<br>K         |            |   |
| Joe Pepitone, L<br>OBP: 0.330, SLG: 0.406<br>(1, 3)<br>(9, 8)  |           | 0-0<br>CS<br>1B | 0-0<br>FC6-4<br>1B |                             | 0-0<br>FC4-6<br>1B |              | 0-0<br>HR        |            |   |
| Elston Howard, R<br>OBP: 0.344, SLG: 0.386<br>(1, 2)   |           | 0-0<br>F6       | 0-0<br>FC6-4       |                             | 0-0<br>F8          |              | 1-0<br>3B<br>HBP |            |   |
| Clete Boyer, R<br>OBP: 0.242, SLG: 0.227<br>(1, 5)   |           | 4-0<br>BB       |                    | 0-0<br>F7                   |                    | 0-0<br>FC4-6 |                  | 0-0<br>3B  |   |
| Stan Williams, R<br>OBP: 0.400, SLG: 0.400<br>Steve Hamilton, L<br>Hal Reniff, R<br>(1, 1)<br>(4, 1)<br>(8, 1) |           | 0-0<br>6-3      |                    | 4-0<br>WP<br>1B<br>1B<br>BB |                    | 0-0<br>4-3   |                  | 0-0<br>4-3 |   |

| AB | R | H | RBI | BB | SO | LOB |
|----|---|---|-----|----|----|-----|
| 5  | 1 | 1 | 0   | 0  | 0  | 1   |
| 3  | 2 | 1 | 2   | 2  | 0  | 0   |
| 5  | 2 | 2 | 3   | 0  | 0  | 2   |
| 5  | 1 | 1 | 2   | 0  | 1  | 1   |
| 0  | 0 | 0 | 0   | 0  | 0  | 0   |
| 3  | 1 | 1 | 0   | 1  | 1  | 0   |
| 4  | 1 | 4 | 2   | 0  | 0  | 0   |
| 3  | 1 | 0 | 0   | 0  | 0  | 4   |
| 3  | 0 | 1 | 1   | 1  | 0  | 1   |
| 1  | 0 | 0 | 0   | 0  | 0  | 1   |
| 2  | 1 | 0 | 0   | 1  | 0  | 2   |
| 0  | 0 | 0 | 0   | 0  | 0  | 0   |

**BOTTOM**

**Kansas City Athletics @ New York Yankees**  
 Yankee Stadium, Bronx, NY  
 Sat May 16 1964, 3:33 AM EDT  
 Att. 11,145 - Unknown - 70 F

livebaseballscorecards.com

|            |           |
|------------|-----------|
| <b>AB</b>  | <b>34</b> |
| <b>R</b>   | <b>10</b> |
| <b>H</b>   | <b>11</b> |
| <b>RBI</b> | <b>10</b> |
| <b>BB</b>  | <b>5</b>  |
| <b>SO</b>  | <b>2</b>  |
| <b>LOB</b> | <b>12</b> |



|       |        |
|-------|--------|
| 1B: 5 | SF: 0  |
| 2B: 0 | SAC: 0 |
| 3B: 2 | DP: 0  |
| HR: 4 | HBP: 1 |

|       |        |
|-------|--------|
| WP: 1 | PA: 40 |
| PB: 0 |        |
| SB: 0 |        |
| CS: 1 |        |

| Inning | R | H | E | K | S  | P |
|--------|---|---|---|---|----|---|
| 1      | 1 | 1 | 0 | 1 | 6  |   |
| 2      | 1 | 2 | 0 | 0 | 8  |   |
| 3      | 2 | 2 | 0 | 0 | 13 |   |
| 4      | 4 | 3 | 0 | 0 | 10 |   |
| 5      | 0 | 1 | 0 | 0 | 4  |   |
| 6      | 0 | 0 | 0 | 0 | 7  |   |
| 7      | 2 | 2 | 0 | 1 | 8  |   |
| 8      | 0 | 0 | 0 | 0 | 3  |   |
| 9      | 0 | 0 | 0 | 0 | 3  |   |

| PITCHER                                      | IP  | WLS | BF | H | R | ER | SO | BB | IBB | HBP | BLK | WP | HR | S  | P  | ERA   | WHIP  |
|--|-----|-----|----|---|---|----|----|----|-----|-----|-----|----|----|----|----|-------|-------|
| Moe Drabowsky, R<br>ERA: 6.67<br>(1, 1)      | 2.2 | L   | 14 | 4 | 4 | 4  | 1  | 3  | 0   | 0   | 0   | 0  | 2  | 13 | 25 | 13.50 | 2.625 |
| Joe Grzenda, L<br>ERA: 9.0<br>(3, 1)         | 1.1 |     | 9  | 4 | 4 | 4  | 0  | 1  | 0   | 0   | 0   | 1  | 1  | 8  | 12 | 27.00 | 3.750 |
| Jack Aker, R<br>ERA: 11.0<br>(5, 1)          | 3.0 |     | 14 | 3 | 2 | 2  | 1  | 1  | 0   | 1   | 0   | 0  | 1  | 14 | 19 | 6.00  | 1.333 |
| Aurelio Monteagudo, R<br>ERA: 8.72<br>(8, 1) | 1.0 |     | 3  | 0 | 0 | 0  | 0  | 0  | 0   | 0   | 0   | 0  | 0  | 3  | 3  | 0.00  | 0.000 |

| Batter  | 1   | 2                               | 3                            | 4                               | 5                            | 6                               | 7                            | 8                               | 9                            | AB R H RBI BB SO LOB  | TOP  |                                  |                              |                                 |                              |                                  |                              |                                 |                                  |                                    |                                  |        |  |  |  |  |  |  |  |  |  |  |  |  |  |  |
|---|---|---------------------------------|------------------------------|---------------------------------|------------------------------|---------------------------------|------------------------------|---------------------------------|------------------------------|---|--|----------------------------------|------------------------------|---------------------------------|------------------------------|----------------------------------|------------------------------|---------------------------------|----------------------------------|------------------------------------|----------------------------------|--------|--|--|--|--|--|--|--|--|--|--|--|--|--|--|
| Wayne Causey, L (1, 6)<br>OBP: 0.403, SLG: 0.348  | 0-0<br>F8   |                                 |                              | 0-0<br>F7                       | 0-0<br>1B                    | 0-0<br>1B                       |                              | 0-0<br>FC6-4                    | 4-0<br>FC6-4<br>BB           | 4 1 2 1 1 0 0   | <b>Kansas City Athletics @ New York Yankees</b><br>Yankee Stadium, Bronx, NY<br>Sun May 17 1964, 3:33 AM EDT<br>Unknown - 76 F<br><a href="http://livebaseballscorecards.com">livebaseballscorecards.com</a> |                                  |                              |                                 |                              |                                  |                              |                                 |                                  |                                    |                                  |        |  |  |  |  |  |  |  |  |  |  |  |  |  |  |
| Nelson Mathews, R (1, 8)<br>OBP: 0.365, SLG: 0.434  | 0-3<br>K  |                                 |                              | 0-0<br>F6                       | 0-0<br>1B                    | 0-0<br>1B                       |                              | 0-0<br>FC6-4                    | 0-0<br>FC6-4                 | 5 0 1 0 0 1 2   |  |                                  |                              |                                 |                              |                                  |                              |                                 |                                  |                                    |                                  |        |  |  |  |  |  |  |  |  |  |  |  |  |  |  |
| Ed Charles, R (1, 5)<br>OBP: 0.395, SLG: 0.404  | 0-0<br>F9   |                                 |                              | 1-0<br>1B<br>3B<br>HBP          | 0-0<br>1B                    |                                 |                              | 0-0<br>G6-4-3<br>1B             | 0-0<br>F8                    | 4 1 2 1 0 0 0   |  |                                  |                              |                                 |                              |                                  |                              |                                 |                                  |                                    |                                  |        |  |  |  |  |  |  |  |  |  |  |  |  |  |  |
| Jim Gentile, L (1, 3)<br>OBP: 0.393, SLG: 0.495   |   |                                 | 0-0<br>L3                    | 0-0<br>3B<br>1B                 | 0-0<br>F8                    |                                 |                              | 0-0<br>F2                       | 0-0<br>G5-4-3<br>1B          | 5 1 2 0 0 0 3   |  |                                  |                              |                                 |                              |                                  |                              |                                 |                                  |                                    |                                  |        |  |  |  |  |  |  |  |  |  |  |  |  |  |  |
| George Alusik, R (1, 7)<br>OBP: 0.567, SLG: 0.556   |   | 4-0<br>G6-3<br>BB               |                              | 0-0<br>3B                       |                              | 0-3<br>K                        | 0-0<br>G6-4-3                |                                 | 0-0<br>G5-4-3                | 4 0 1 2 1 1 2   |  |                                  |                              |                                 |                              |                                  |                              |                                 |                                  |                                    |                                  |        |  |  |  |  |  |  |  |  |  |  |  |  |  |  |
| Manny Jimenez, L (1, 9)<br>OBP: 0.271, SLG: 0.512   |   | 0-0<br>G6-3                     |                              | 0-0<br>6-3                      |                              | 0-0<br>BB<br>3B<br>1B           |                              | 0-3<br>K                        |                              | 4 1 1 0 0 1 2   |  |                                  |                              |                                 |                              |                                  |                              |                                 |                                  |                                    |                                  |        |  |  |  |  |  |  |  |  |  |  |  |  |  |  |
| Charlie Lau, L (1, 2)<br>OBP: 0.409, SLG: 0.552   |   |                                 | 0-3<br>K                     |                                 | 0-0<br>3-1<br>1B<br>2B       | 4-0<br>3B<br>BB                 |                              | 0-0<br>3B<br>2B                 |                              | 3 3 2 0 1 1 0   |  |                                  |                              |                                 |                              |                                  |                              |                                 |                                  |                                    |                                  |        |  |  |  |  |  |  |  |  |  |  |  |  |  |  |
| Dick Green, R (1, 4)<br>OBP: 0.270, SLG: 0.385  |   |                                 | 0-0<br>5-3                   |                                 | 0-0<br>F3                    | 1-4<br>4-3<br>3B                |                              | 0-0<br>5-3<br>3B                |                              | 4 2 2 3 0 0 1   |  |                                  |                              |                                 |                              |                                  |                              |                                 |                                  |                                    |                                  |        |  |  |  |  |  |  |  |  |  |  |  |  |  |  |
| John O'Donoghue, R (1, 1)<br>OBP: 0.444, SLG: 0.444<br>Vern Handrahan, L (4, 1)<br>Joe Grzenda, R (5, 1)<br>Doc Edwards, R (6, PH)<br>Jack Aker, R (6, 1)<br>Billy Bryan, L (8, PH)<br>Aurelio Montesgudo, R (8, 1)<br>OBP: 0.333, SLG: 0.667<br>OBP: 0.400, SLG: 0.800 |   |                                 | 0-3<br>K                     |                                 | 0-0<br>3-1                   | 0-0<br>4-3                      |                              | 0-0<br>5-3                      |                              | 1 0 0 0 0 1 0<br>1 0 0 0 0 0 1<br>0 0 0 0 0 0 0<br>1 0 0 1 0 0 0<br>0 0 0 0 0 0 0<br>1 0 0 1 0 0 0<br>0 0 0 0 0 0 0 |  |                                  |                              |                                 |                              |                                  |                              |                                 |                                  |                                    |                                  |        |  |  |  |  |  |  |  |  |  |  |  |  |  |  |
| <b>Inning Stats</b>   | R: 0<br>E: 0<br>K: 1<br>S: 5                          | H: 0<br>LOB: 0<br>BB: 0<br>P: 5 | R: 0<br>E: 0<br>K: 0<br>S: 2 | H: 0<br>LOB: 0<br>BB: 1<br>P: 6 | R: 0<br>E: 0<br>K: 2<br>S: 7 | H: 0<br>LOB: 0<br>BB: 0<br>P: 7 | R: 2<br>E: 0<br>K: 0<br>S: 5 | H: 2<br>LOB: 1<br>BB: 0<br>P: 6 | R: 2<br>E: 0<br>K: 0<br>S: 7 | H: 4<br>LOB: 2<br>BB: 0<br>P: 7   | R: 3<br>E: 0<br>K: 1<br>S: 8   | H: 3<br>LOB: 1<br>BB: 1<br>P: 12 | R: 0<br>E: 0<br>K: 0<br>S: 3 | H: 1<br>LOB: 0<br>BB: 0<br>P: 3 | R: 2<br>E: 0<br>K: 1<br>S: 7 | H: 2<br>LOB: 1<br>BB: 1<br>P: 11 | R: 0<br>E: 0<br>K: 0<br>S: 3 | H: 1<br>LOB: 0<br>BB: 0<br>P: 3 | 1B: 8<br>2B: 2<br>3B: 3<br>HR: 0 | SF: 0<br>SAC: 0<br>DP: 3<br>HBP: 1 | WP: 0<br>PB: 0<br>SB: 0<br>CS: 0 | PA: 41 |  |  |  |  |  |  |  |  |  |  |  |  |  |  |
| <b>PITCHER</b>  | IP WLS BF H R ER SO BB IBB HBP BLK WP HR S P ERA WHIP |                                 |                              |                                 |                              |                                 |                              |                                 |                              |   |  |                                  |                              |                                 |                              |                                  |                              |                                 |                                  |                                    |                                  |        |  |  |  |  |  |  |  |  |  |  |  |  |  |  |
| Bill Stafford, R (1, 1)<br>ERA: 2.84  | 4.2   |                                 | 21                           | 6                               | 4                            | 4                               | 3                            | 1                               | 0                            | 1   | 0  | 0                                | 0                            | 25                              | 30                           | 7.71                             | 1.500                        |                                 |                                  |                                    |                                  |        |  |  |  |  |  |  |  |  |  |  |  |  |  |  |
| Bud Daley, L (5, 1)<br>ERA: 5.68  | 1.1   |                                 | 9                            | 4                               | 3                            | 3                               | 1                            | 1                               | 0                            | 0   | 0  | 0                                | 0                            | 10                              | 14                           | 20.25                            | 3.750                        |                                 |                                  |                                    |                                  |        |  |  |  |  |  |  |  |  |  |  |  |  |  |  |
| Pete Mikkelsen, R (7, 1)<br>ERA: 9.53   | 1.2   |                                 | 7                            | 2                               | 2                            | 2                               | 1                            | 1                               | 0                            | 0   | 0  | 0                                | 0                            | 8                               | 12                           | 10.80                            | 1.800                        |                                 |                                  |                                    |                                  |        |  |  |  |  |  |  |  |  |  |  |  |  |  |  |
| Hal Reniff, R (8, 1)<br>ERA:  | 1.1   | W                               | 4                            | 1                               | 0                            | 0                               | 0                            | 0                               | 0                            | 0   | 0  | 0                                | 0                            | 4                               | 4                            | 0.00                             | 0.750                        |                                 |                                  |                                    |                                  |        |  |  |  |  |  |  |  |  |  |  |  |  |  |  |





| Batter   | 1                      | 2          | 3                             | 4          | 5                       | 6          | 7        | 8         | 9 |
|--|------------------------|------------|-------------------------------|------------|-------------------------|------------|----------|-----------|---|
| Phil Linz, R<br>OBP: 0.242, SLG: 0.226<br>(1, 6)<br>(9, 5)   | 0-0<br>G3<br>1-3<br>2B |            | 4-0<br>1B<br>3B<br>BB         | 0-0<br>F8  | 0-0<br>6-3              |            |          | 0-3<br>K  |   |
| Bobby Richardson, R<br>OBP: 0.352, SLG: 0.345<br>(1, 4)  | 0-0<br>G3<br>2-3       |            | 0-0<br>1-3<br>3B<br>1B        |            | 0-0<br>F3               | 0-0<br>4-3 |          | 0-0<br>F8 |   |
| Hector Lopez, R<br>OBP: 0.325, SLG: 0.533<br>(1, 9)  | 0-0<br>1-3<br>3-H      |            | 0-0<br>1-H<br>3-H<br>1B<br>3B |            | 4-0<br>HR<br>BB<br>BB   | 0-0<br>4-3 |          | 0-0<br>F4 |   |
| Mickey Mantle, S<br>OBP: 0.436, SLG: 0.560<br>Pedro Gonzalez, R<br>OBP: 0.313, SLG: 0.276<br>(1, 8)<br>(9, 3)  | 0-0<br>HR              |            | 0-0<br>6-3<br>1B<br>1B        |            | 4-0<br>HR<br>BB         | 4-0<br>BB  |          |           |   |
| Tom Tresh, S<br>OBP: 0.361, SLG: 0.507<br>(1, 7)   | 0-0<br>4-3             |            | 0-0<br>6-3<br>1-2             |            | 0-0<br>HR<br>1-H<br>2-H | 0-0<br>1-3 |          |           |   |
| Elston Howard, R<br>OBP: 0.351, SLG: 0.384<br>(1, 2)   |                        | 0-0<br>F8  | 0-0<br>2-H<br>1B              |            | 4-0<br>3B<br>BB         | 0-0<br>6-3 |          |           |   |
| Joe Pepitone, L<br>OBP: 0.327, SLG: 0.420<br>(1, 3)<br>(9, 8)  |                        | 0-0<br>3-1 | 0-0<br>F6                     |            | 0-0<br>1-H<br>2B<br>3B  | 0-0<br>F9  |          |           |   |
| Clete Boyer, R<br>OBP: 0.252, SLG: 0.242<br>Tony Kubek, L<br>OBP: 0.314, SLG: 0.413<br>(1, 5)<br>(9, 6)        |                        | 0-0<br>4-3 |                               | 0-0<br>F8  | 0-0<br>2B               | 0-0<br>HBP |          |           |   |
| Bill Stafford, R<br>Bud Daley, L<br>Pete Mikkelsen, R<br>Hal Reniff, R<br>(1, 1)<br>(5, 1)<br>(7, 1)<br>(8, 1) |                        |            | 0-3<br>K                      | 0-0<br>5-3 | 0-3<br>K                |            | 0-3<br>K |           |   |

| AB | R | H | RBI | BB | SO | LOB |
|----|---|---|-----|----|----|-----|
| 4  | 2 | 1 | 0   | 1  | 1  | 1   |
| 5  | 1 | 1 | 0   | 0  | 0  | 1   |
| 4  | 2 | 1 | 3   | 1  | 0  | 0   |
| 2  | 3 | 2 | 2   | 2  | 0  | 0   |
| 0  | 0 | 0 | 0   | 0  | 0  | 0   |
| 4  | 1 | 1 | 3   | 0  | 0  | 2   |
| 3  | 1 | 1 | 1   | 1  | 0  | 0   |
| 4  | 1 | 1 | 1   | 0  | 0  | 1   |
| 3  | 0 | 1 | 1   | 0  | 0  | 0   |
| 0  | 0 | 0 | 0   | 0  | 0  | 0   |
| 2  | 0 | 0 | 0   | 0  | 1  | 0   |
| 1  | 0 | 0 | 0   | 0  | 1  | 1   |
| 1  | 0 | 0 | 0   | 0  | 1  | 1   |
| 0  | 0 | 0 | 0   | 0  | 0  | 0   |

**BOTTOM**

**Kansas City Athletics @ New York Yankees**  
 Yankee Stadium, Bronx, NY  
 Sun May 17 1964, 3:33 AM EDT  
 Unknown - 76 F

[livebaseballscorecards.com](http://livebaseballscorecards.com)

|            |           |
|------------|-----------|
| <b>AB</b>  | <b>33</b> |
| <b>R</b>   | <b>11</b> |
| <b>H</b>   | <b>9</b>  |
| <b>RBI</b> | <b>11</b> |
| <b>BB</b>  | <b>5</b>  |
| <b>SO</b>  | <b>4</b>  |
| <b>LOB</b> | <b>7</b>  |



|       |        |       |        |
|-------|--------|-------|--------|
| 1B: 3 | SF: 0  | WP: 0 | PA: 39 |
| 2B: 2 | SAC: 0 | PB: 0 |        |
| 3B: 2 | DP: 0  | SB: 0 |        |
| HR: 2 | HBP: 1 | CS: 0 |        |

| Inning Stats |   |   |   |   |     |    |   |   |    |    |    |     |     |     | PITCHER |     |    |   |   |    |    |    |     |     |     |    |    |   |    |       |       |       |       |
|--------------|---|---|---|---|-----|----|---|---|----|----|----|-----|-----|-----|---------|-----|----|---|---|----|----|----|-----|-----|-----|----|----|---|----|-------|-------|-------|-------|
| R            | H | E | K | S | WLS | BF | H | R | ER | SO | BB | IBB | HBP | BLK | IP      | WLS | BF | H | R | ER | SO | BB | IBB | HBP | BLK | WP | HR | S | P  | ERA   | WHIP  |       |       |
| 2            | 2 | 0 | 5 | 5 |     |    |   |   |    |    |    |     |     |     | 3.0     | L   | 16 | 6 | 6 | 6  | 1  | 1  | 0   | 0   | 0   | 0  | 0  | 0 | 1  | 17    | 21    | 18.00 | 2.333 |
| 0            | 0 | 0 | 0 | 0 |     | 8  | 1 | 4 | 4  | 0  | 3  | 0   | 0   | 0   | 1.1     |     | 8  | 1 | 4 | 4  | 0  | 3  | 0   | 0   | 0   | 0  | 0  | 1 | 5  | 17    | 27.00 | 3.000 |       |
| 0            | 0 | 0 | 0 | 0 |     | 4  | 2 | 1 | 1  | 1  | 0  | 0   | 0   | 0   | 0.2     |     | 4  | 2 | 1 | 1  | 1  | 0  | 0   | 0   | 0   | 0  | 0  | 6 | 6  | 13.50 | 3.000 |       |       |
| 0            | 0 | 0 | 0 | 0 |     | 8  | 0 | 0 | 0  | 1  | 1  | 0   | 1   | 0   | 2.0     |     | 8  | 0 | 0 | 0  | 1  | 1  | 0   | 1   | 0   | 0  | 0  | 8 | 13 | 0.00  | 0.500 |       |       |
| 0            | 0 | 0 | 0 | 0 |     | 3  | 0 | 0 | 0  | 1  | 0  | 0   | 0   | 0   | 1.0     |     | 3  | 0 | 0 | 0  | 1  | 0  | 0   | 0   | 0   | 0  | 0  | 5 | 5  | 0.00  | 0.000 |       |       |

| Batter   | 1  | 2   | 3   | 4   | 5   | 6   | 7   | 8   | 9   | AB R H RBI BB SO LOB   | TOP  |
|--|--|---|---|---|---|---|---|---|---|--|--|
| Wayne Causey, L (1, 6)<br>OBP: 0.391, SLG: 0.336     | 0-3<br>K   |   | 0-0<br>3-1  |   |   | 0-0<br>E7<br>FC5-4<br>1-2                                       |   |   | 0-0<br>6-3  | 4 0 0 0 0 1 1  | <b>Kansas City Athletics @ New York Yankees</b><br>Yankee Stadium, Bronx, NY<br>Sun May 17 1964, 3:38 AM EDT<br>Att. 24,007 - Unknown - 78 F<br><a href="http://livebaseballscorecards.com">livebaseballscorecards.com</a> |
| Nelson Mathews, R (1, 8)<br>OBP: 0.369, SLG: 0.436   | 0-0<br>CS<br>1B  |   |   | 0-0<br>F9   |   | 0-0<br>FC5-4<br>1-2f<br>2-3                                     |   | 0-0<br>FC5-4<br>1B  | 4 0 2 0 0 0 2   |  |  |
| Ed Charles, R (1, 5)<br>OBP: 0.390, SLG: 0.392       | 4-0<br>BB<br>1-2<br>BB   |   |   | 0-0<br>F9   |   | 0-3<br>K  |   | 0-0<br>FC5-4<br>1-2f  | 3 0 0 0 1 1 3   |  |  |
| Jim Gentile, L (1, 3)<br>OBP: 0.380, SLG: 0.475      | 0-3<br>K   |   | 0-0<br>3-1  |   |   | 0-0<br>F7   |   | 0-0<br>F8   | 4 0 0 0 0 1 2   |  |  |
| George Alusik, R (1, 7)<br>OBP: 0.545, SLG: 0.524    |  | 0-3<br>K  |   | 0-0<br>G4-6-3<br>1B   |   | 0-0<br>F4   |   |   | 3 0 1 0 0 1 0   |  |  |
| Manny Jimenez, L (1, 9)<br>OBP: 0.255, SLG: 0.478    |  | 0-0<br>F5   |   | 0-0<br>G4-6-3<br>1-2f   |   | 0-3<br>K  |   |   | 3 0 0 0 0 1 1   |  |  |
| Dick Green, R (1, 4)<br>OBP: 0.263, SLG: 0.374       |  | 0-0<br>F8   |   | 0-0<br>F7   |   |   | 0-3<br>K  |   | 3 0 0 0 0 1 0   |  |  |
| Charlie Lau, L (1, 2)<br>OBP: 0.412, SLG: 0.550      |  |   | 0-3<br>K  |   |   | 0-0<br>FC5-4<br>E<br>1B   |   | 0-0<br>6-3  | 2 0 1 0 0 1 0   |  |  |
| Dave Duncan, R (6, 2)<br>OBP: 0.500, SLG: 0.500      |  |   |   |   |   |   |   | 0-0<br>6-3  | 1 0 0 0 0 0 0   |  |  |
| Orlando Pena, R (1, 1)<br>OBP: 0.083, SLG: 0.043     |  |   | 0-0<br>6-3  |   |   | 0-0<br>F6   |   | 0-0<br>6-3  | 1 0 0 0 0 0 0   |  |  |
| George Williams, R (6, PH)<br>OBP: 0.250, SLG: 0.143 |  |   |   |   |   |   |   |   | 1 0 0 0 0 0 1   |  |  |
| Vern Handrahan, L (6, 1)                             |  |   |   |   |   |   |   |   | 0 0 0 0 0 0 0   |  |  |
| Jose Tartabull, L (8, PH)<br>OBP: 0.167, SLG: 0.333  |  |   |   |   |   |   |   |   | 1 0 0 0 0 0 0   |  |  |
| John Wyatt, R (8, 1)                                 |  |   |   |   |   |   |   |   | 0 0 0 0 0 0 0   |  |  |
| <b>Inning Stats</b>                                  | R: 0<br>E: 0<br>K: 2<br>S: 7<br>H: 1<br>LOB: 1<br>BB: 1<br>P: 11   | R: 0<br>E: 0<br>K: 1<br>S: 5<br>H: 0<br>LOB: 0<br>BB: 0<br>P: 5 | R: 0<br>E: 0<br>K: 1<br>S: 5<br>H: 0<br>LOB: 0<br>BB: 0<br>P: 5 | R: 0<br>E: 0<br>K: 0<br>S: 3<br>H: 0<br>LOB: 0<br>BB: 0<br>P: 3 | R: 0<br>E: 0<br>K: 0<br>S: 3<br>H: 1<br>LOB: 0<br>BB: 0<br>P: 3 | R: 0<br>E: 1<br>K: 1<br>S: 7<br>H: 1<br>LOB: 2<br>BB: 0<br>P: 7 | R: 0<br>E: 0<br>K: 1<br>S: 5<br>H: 0<br>LOB: 0<br>BB: 0<br>P: 5 | R: 0<br>E: 0<br>K: 1<br>S: 5<br>H: 0<br>LOB: 0<br>BB: 0<br>P: 5 | R: 0<br>E: 0<br>K: 0<br>S: 4<br>H: 1<br>LOB: 1<br>BB: 0<br>P: 4 | 1B: 4<br>2B: 0<br>3B: 0<br>HR: 0<br>SF: 0<br>SAC: 0<br>DP: 1<br>HBP: 0 | WP: 0<br>PB: 0<br>SB: 0<br>CS: 1<br>PA: 31   |
| <b>PITCHER</b><br>Whitey Ford, L (1, 1)<br>ERA: 1.66 | IP: 9.0<br>WLS: W<br>BF: 31<br>H: 4<br>R: 0<br>ER: 0<br>SO: 7<br>BB: 1<br>IBB: 0<br>HBP: 0<br>BLK: 0<br>WP: 0<br>HR: 0<br>S: 44<br>P: 48<br>ERA: 0.00<br>WHIP: 0.556 |   |   |   |   |   |   |   |   |  |  |

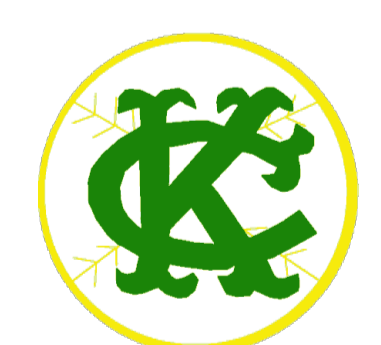

| Batter   | 1                                  | 2         | 3          | 4                                | 5                             | 6                         | 7                             | 8          | 9 |
|--|------------------------------------|-----------|------------|----------------------------------|-------------------------------|---------------------------|-------------------------------|------------|---|
| Phil Linz, R<br>OBP: 0.254, SLG: 0.227 (1, 6)        | 4-0<br>1B S<br>G4-6-3<br>BB        | 0-3<br>K  |            | 0-0<br>F9                        |                               | 0-0<br>4-3 WP<br>HR<br>1B | 0-0<br>F7                     |            |   |
| Bobby Richardson, R<br>OBP: 0.346, SLG: 0.339 (1, 4) | 0-0<br>1B<br>G4-6-3                |           | 0-0<br>6-3 | 0-0<br>FC6-4                     |                               | 0-0<br>4-3                |                               | 0-0<br>F9  |   |
| Roger Maris, L<br>OBP: 0.352, SLG: 0.596 (1, 9)      | 0-0<br>1B<br>G4-6-3<br>1-2f<br>3-H |           | 0-3<br>K   | 0-0<br>F4                        |                               | 1-0<br>HR<br>HBP          |                               | 0-0<br>F8  |   |
| Joe Pepitone, L<br>OBP: 0.348, SLG: 0.495 (1, 3)     | 0-0<br>1B<br>BB                    |           | 0-0<br>HR  |                                  | 0-0<br>4-3                    | 0-0<br>HR<br>1-H<br>3-H   |                               | 0-0<br>1B  |   |
| Tom Tresh, S<br>OBP: 0.364, SLG: 0.493 (1, 8)        | 4-0<br>1B<br>BB                    |           | 0-3<br>K   |                                  | 0-0<br>F8                     | 0-0<br>1B<br>G4-6-3       |                               | 0-0<br>6-3 |   |
| Hector Lopez, R<br>OBP: 0.333, SLG: 0.544 (1, 7)     | 0-3<br>K                           |           |            | 0-0<br>1B<br>2B                  | 0-0<br>HBP<br>BB<br>1B        | 0-0<br>G4-6-3<br>1-2f     |                               |            |   |
| Elston Howard, R<br>OBP: 0.366, SLG: 0.393 (1, 2)    |                                    | 0-3<br>K  |            | 0-0<br>1B<br>1B<br>2-H           | 4-0<br>HBP<br>BB<br>1B<br>1-2 |                           | 0-0<br>FC3-6<br>1B            |            |   |
| Pedro Gonzalez, R<br>OBP: 0.333, SLG: 0.281 (1, 5)   |                                    | 0-3<br>K  |            | 0-0<br>1B<br>1B<br>1-3           | 1-0<br>HBP<br>1-2<br>2-3      |                           | 0-0<br>FC3-6<br>SH1-3<br>1-2f |            |   |
| Whitey Ford, L<br>OBP: 0.250, SLG: 0.167 (1, 1)      |                                    | 0-0<br>1B |            | 0-0<br>1B<br>FC6-4<br>1-H<br>3-H | 0-0<br>L8                     |                           | 0-0<br>SH1-3<br>1-2           |            |   |

| AB | R | H | RBI | BB | SO | LOB |
|----|---|---|-----|----|----|-----|
| 4  | 2 | 1 | 0   | 1  | 1  | 3   |
| 5  | 0 | 1 | 0   | 0  | 0  | 2   |
| 4  | 1 | 0 | 0   | 0  | 1  | 2   |
| 5  | 2 | 4 | 4   | 0  | 0  | 0   |
| 4  | 0 | 1 | 0   | 1  | 1  | 1   |
| 4  | 1 | 2 | 0   | 0  | 1  | 3   |
| 3  | 1 | 2 | 1   | 1  | 1  | 0   |
| 3  | 1 | 1 | 0   | 0  | 1  | 1   |
| 3  | 0 | 2 | 2   | 0  | 0  | 3   |

**BOTTOM**

**Kansas City Athletics @ New York Yankees**  
 Yankee Stadium, Bronx, NY  
 Sun May 17 1964, 3:38 AM EDT  
 Att: 24,007 - Unknown - 78 F

[livebaseballscorecards.com](http://livebaseballscorecards.com)

|            |           |
|------------|-----------|
| <b>AB</b>  | <b>35</b> |
| <b>R</b>   | <b>8</b>  |
| <b>H</b>   | <b>14</b> |
| <b>RBI</b> | <b>7</b>  |
| <b>BB</b>  | <b>3</b>  |
| <b>SO</b>  | <b>6</b>  |
| <b>LOB</b> | <b>15</b> |



|        |        |       |        |
|--------|--------|-------|--------|
| 1B: 11 | SF: 0  | WP: 1 | PA: 41 |
| 2B: 1  | SAC: 1 | PB: 0 |        |
| 3B: 0  | DP: 2  | SB: 2 |        |
| HR: 2  | HBP: 2 | CS: 0 |        |

| Inning Stats             | R   | H  | E | K | S | R | H | E | K | S | R | H | E | K | S     | R     | H     | E | K | S | R | H | E | K | S |
|--------------------------|-----|----|---|---|---|---|---|---|---|---|---|---|---|---|-------|-------|-------|---|---|---|---|---|---|---|---|
| Orlando Pena, R (1, 1)   | 5.0 | 27 | 0 | 2 | 2 | 9 | 5 | 0 | 3 | 6 | 3 | 0 | 0 | 0 | 0     | 9.00  | 2.400 |   |   |   |   |   |   |   |   |
| Vern Handrahan, R (6, 1) | 2.0 | 10 | 0 | 1 | 0 | 4 | 3 | 0 | 0 | 0 | 0 | 1 | 0 | 1 | 13.50 | 2.000 |       |   |   |   |   |   |   |   |   |
| John Wyatt, R (8, 1)     | 1.0 | 4  | 0 | 1 | 0 | 1 | 0 | 0 | 0 | 0 | 0 | 0 | 0 | 0 | 0.00  | 1.000 |       |   |   |   |   |   |   |   |   |

| PITCHER                  | IP  | WLS | BF | H | R | ER | SO | BB | IBB | HBP | BLK | WP | HR | S | P     | ERA   | WHIP  |
|--------------------------|-----|-----|----|---|---|----|----|----|-----|-----|-----|----|----|---|-------|-------|-------|
| Orlando Pena, R (1, 1)   | 5.0 | 27  | 0  | 2 | 2 | 9  | 5  | 0  | 3   | 6   | 3   | 0  | 0  | 0 | 0     | 9.00  | 2.400 |
| Vern Handrahan, R (6, 1) | 2.0 | 10  | 0  | 1 | 0 | 4  | 3  | 0  | 0   | 0   | 0   | 1  | 0  | 1 | 13.50 | 2.000 |       |
| John Wyatt, R (8, 1)     | 1.0 | 4   | 0  | 1 | 0 | 1  | 0  | 0  | 0   | 0   | 0   | 0  | 0  | 0 | 0.00  | 1.000 |       |

| Batter   | 1                            | 2                               | 3                            | 4                                | 5                            | 6                               | 7                            | 8                                | 9                            | 10                              | AB                           | R                               | H                            | RBI                             | BB                           | SO                               | LOB                          | TOP                             |                                  |                                    |                                  |        |  |  |  |
|--|------------------------------|---------------------------------|------------------------------|----------------------------------|------------------------------|---------------------------------|------------------------------|----------------------------------|------------------------------|---------------------------------|------------------------------|---------------------------------|------------------------------|---------------------------------|------------------------------|----------------------------------|------------------------------|---------------------------------|----------------------------------|------------------------------------|----------------------------------|--------|--|--|--|
| <b>Wayne Causey, L</b> (1, 6)<br>OBP: 0.392, SLG: 0.333  | 0-0<br>1B 1B                 |                                 | 0-3<br>K                     |                                  | 0-3<br>K                     |                                 | 0-0<br>1-3                   |                                  | 4-0<br>IBB                   |                                 | 4                            | 1                               | 1                            | 0                               | 1                            | 2                                | 0                            |                                 |                                  |                                    |                                  |        |  |  |  |
| <b>Nelson Mathews, R</b> (1, 8)<br>OBP: 0.363, SLG: 0.426  | 0-0<br>F8                    |                                 | 0-0<br>6-3                   |                                  | 0-0<br>1B                    |                                 |                              | 0-0<br>F6                        | 0-3<br>K                     |                                 | 5                            | 0                               | 1                            | 0                               | 0                            | 1                                | 3                            |                                 |                                  |                                    |                                  |        |  |  |  |
| <b>Ed Charles, R</b> (1, 5)<br>OBP: 0.383, SLG: 0.383  | 0-0<br>F9                    |                                 | 0-0<br>6-3                   |                                  | 0-3<br>K                     |                                 |                              | 0-0<br>1B                        |                              | 0-0<br>1-3                      | 5                            | 0                               | 1                            | 0                               | 0                            | 1                                | 1                            |                                 |                                  |                                    |                                  |        |  |  |  |
| <b>Jim Gentile, L</b> (1, 3)<br>OBP: 0.381, SLG: 0.467   | 0-0<br>1B 1B                 |                                 |                              | 4-0<br>1B BB                     | 0-3<br>K                     |                                 |                              | 0-0<br>F6                        |                              | 0-3<br>K                        | 4                            | 0                               | 1                            | 0                               | 1                            | 2                                | 1                            |                                 |                                  |                                    |                                  |        |  |  |  |
| <b>George Alusik, R</b> (1, 9)<br>OBP: 0.543, SLG: 0.522<br><b>Jose Tartabull, L</b> (4, 9)<br>OBP: 0.222, SLG: 0.333  | 0-0<br>1B<br>1-2<br>3-H      |                                 | 0-3<br>K                     |                                  | 0-0<br>1B                    |                                 |                              | 0-0<br>1-3                       |                              | 0-0<br>4-3                      | 2                            | 0                               | 1                            | 1                               | 0                            | 1                                | 1                            |                                 |                                  |                                    |                                  |        |  |  |  |
|  |                              |                                 |                              |                                  |                              |                                 |                              |                                  |                              |                                 | 3                            | 0                               | 2                            | 0                               | 1                            | 0                                | 1                            |                                 |                                  |                                    |                                  |        |  |  |  |
| <b>Manny Jimenez, L</b> (1, 7)<br>OBP: 0.291, SLG: 0.510<br><b>George Williams, R</b> (9, PR)<br>OBP: 0.250, SLG: 0.143  |                              | 4-0<br>BB                       |                              | 0-0<br>F8                        | 0-3<br>FC6-4<br>1B           |                                 |                              |                                  | 0-0<br>1B<br>2B              |                                 | 0                            | 1                               | 0                            | 0                               | 0                            | 0                                | 0                            |                                 |                                  |                                    |                                  |        |  |  |  |
| <b>Charlie Lau, L</b> (1, 2)<br>OBP: 0.417, SLG: 0.547<br><b>Orlando Pena, R</b> (9, PR)<br>OBP: 0.083, SLG: 0.043<br><b>Billy Bryan, L</b> (9, 2)<br>OBP: 0.333, SLG: 0.667         |                              | 0-3<br>K                        |                              | 0-0<br>1B                        | 0-0<br>FC6-4<br>1-2          |                                 |                              | 0-0<br>F8                        | 0-0<br>2B<br>1B              |                                 | 4                            | 0                               | 2                            | 1                               | 0                            | 1                                | 3                            |                                 |                                  |                                    |                                  |        |  |  |  |
| <b>Dick Green, R</b> (1, 4)<br>OBP: 0.254, SLG: 0.360  |                              | 0-0<br>F8                       |                              | 0-0<br>F3                        |                              |                                 |                              | 0-0<br>F8                        | 0-3<br>K                     |                                 | 0                            | 0                               | 0                            | 0                               | 0                            | 1                                | 5                            |                                 |                                  |                                    |                                  |        |  |  |  |
| <b>Moe Drabowsky, R</b> (1, 1)<br>OBP: 0.071, SLG: 0.071<br><b>Rocky Colavito, R</b> (9, PH)<br>OBP: 0.414, SLG: 0.674<br><b>Jack Aker, R</b> (9, PR)<br><b>John Wyatt, R</b> (9, 1) |                              | 0-3<br>K                        |                              | 0-0<br>5-6-3                     |                              |                                 |                              | 0-0<br>1-3                       | 0-0<br>2B                    |                                 | 3                            | 0                               | 0                            | 0                               | 0                            | 1                                | 1                            |                                 |                                  |                                    |                                  |        |  |  |  |
|  |                              |                                 |                              |                                  |                              |                                 |                              |                                  |                              |                                 | 1                            | 0                               | 1                            | 0                               | 0                            | 0                                | 0                            |                                 |                                  |                                    |                                  |        |  |  |  |
|  |                              |                                 |                              |                                  |                              |                                 |                              |                                  |                              |                                 | 0                            | 0                               | 0                            | 0                               | 0                            | 0                                | 0                            |                                 |                                  |                                    |                                  |        |  |  |  |
|  |                              |                                 |                              |                                  |                              |                                 |                              |                                  |                              |                                 | 0                            | 0                               | 0                            | 0                               | 0                            | 0                                | 0                            |                                 |                                  |                                    |                                  |        |  |  |  |
| <b>Inning Stats</b>  | R: 1<br>E: 0<br>K: 0<br>S: 5 | H: 3<br>LOB: 1<br>BB: 0<br>P: 5 | R: 0<br>E: 0<br>K: 2<br>S: 7 | H: 0<br>LOB: 1<br>BB: 1<br>P: 11 | R: 0<br>E: 0<br>K: 1<br>S: 5 | H: 0<br>LOB: 0<br>BB: 0<br>P: 5 | R: 0<br>E: 0<br>K: 1<br>S: 6 | H: 1<br>LOB: 2<br>BB: 1<br>P: 10 | R: 0<br>E: 0<br>K: 1<br>S: 5 | H: 2<br>LOB: 2<br>BB: 0<br>P: 9 | R: 0<br>E: 0<br>K: 2<br>S: 9 | H: 0<br>LOB: 0<br>BB: 0<br>P: 3 | R: 0<br>E: 0<br>K: 0<br>S: 4 | H: 1<br>LOB: 1<br>BB: 0<br>P: 4 | R: 1<br>E: 0<br>K: 2<br>S: 9 | H: 3<br>LOB: 2<br>BB: 1<br>P: 13 | R: 0<br>E: 0<br>K: 1<br>S: 5 | H: 0<br>LOB: 0<br>BB: 0<br>P: 5 | 1B: 9<br>2B: 2<br>3B: 0<br>HR: 0 | SF: 0<br>SAC: 0<br>DP: 0<br>HBP: 0 | WP: 0<br>PB: 0<br>SB: 0<br>CS: 0 | PA: 41 |  |  |  |
| <b>PITCHER</b>   | IP                           | WLS                             | BF                           | H                                | R                            | ER                              | SO                           | BB                               | IBB                          | HBP                             | BLK                          | WP                              | HR                           | S                               | P                            | ERA                              | WHIP                         |                                 |                                  |                                    |                                  |        |  |  |  |
| <b>Robin Roberts, R</b> (1, 1)<br>ERA: 2.17  | 8.0                          |                                 | 34                           | 10                               | 2                            | 2                               | 7                            | 2                                | 0                            | 0                               | 0                            | 0                               | 0                            | 46                              | 54                           | 2.25                             | 1.500                        |                                 |                                  |                                    |                                  |        |  |  |  |
| <b>Stu Miller, R</b> (9, 1)<br>ERA: 2.25   | 1.0                          |                                 | 4                            | 1                                | 0                            | 0                               | 2                            | 0                                | 1                            | 0                               | 0                            | 0                               | 0                            | 7                               | 11                           | 0.00                             | 1.000                        |                                 |                                  |                                    |                                  |        |  |  |  |
| <b>Dick Hall, R</b> (10, 1)<br>ERA: 1.08   | 1.0                          | W                               | 3                            | 0                                | 0                            | 0                               | 1                            | 0                                | 0                            | 0                               | 0                            | 0                               | 0                            | 5                               | 5                            | 0.00                             | 0.000                        |                                 |                                  |                                    |                                  |        |  |  |  |

**Kansas City Athletics @ Baltimore Orioles**  
Memorial Stadium, Baltimore, MD

Tue May 19 1964, 7:05 PM EDT  
Att: 8,496 - Unknown

[livebaseballscorecards.com](http://livebaseballscorecards.com)

|     |    |
|-----|----|
| AB  | 38 |
| R   | 2  |
| H   | 11 |
| RBI | 2  |
| BB  | 3  |
| SO  | 10 |
| LOB | 17 |



| Batter  | 1                | 2           | 3            | 4           | 5            | 6           | 7            | 8                  | 9                    | 10          | AB | R | H | RBI | BB | SO | LOB |
|---|------------------|-------------|--------------|-------------|--------------|-------------|--------------|--------------------|----------------------|-------------|----|---|---|-----|----|----|-----|
| Jackie Brandt, R (1, 8)<br>OBP: 0.324, SLG: 0.352   | 0-3<br>K         |             | X 0-0<br>6-3 |             | X 0-0<br>1-3 |             | X 0-0<br>2B  |                    | X 0-0<br>SH5-4       |             | 4  | 0 | 1 | 0   | 0  | 1  | 1   |
| Luis Aparicio, R (1, 6)<br>OBP: 0.311, SLG: 0.328   | 0-0<br>WP<br>1B  |             | X 0-0<br>F8  |             | X 4-0<br>BB  |             | X 0-0<br>4-3 |                    | X 0-0<br>F8          |             | 4  | 1 | 1 | 0   | 1  | 0  | 2   |
| Bob Johnson, R (1, 4)<br>OBP: 0.242, SLG: 0.310     | 0-3<br>K         |             | X 0-0<br>4-3 |             | X 0-0<br>F9  |             |              | S 0-3<br>K         | X 0-0<br>4-3         |             | 5  | 0 | 0 | 0   | 0  | 2  | 4   |
| Norm Siebern, L (1, 3)<br>OBP: 0.427, SLG: 0.477    | 0-0<br>2-H<br>1B |             |              | X 0-0<br>1B |              | S 0-3<br>K  |              | S 4-0<br>2B<br>BB  |                      | X 0-0<br>HR | 4  | 2 | 3 | 2   | 1  | 1  | 0   |
| Brooks Robinson, R (1, 5)<br>OBP: 0.360, SLG: 0.466 | 0-3<br>K         |             |              | X 0-0<br>L8 |              | S 0-3<br>K  |              | X 0-0<br>F2        |                      |             | 4  | 0 | 0 | 0   | 0  | 2  | 2   |
| Boog Powell, L (1, 7)<br>OBP: 0.330, SLG: 0.506     |                  | S 0-3<br>K  |              | S 4-0<br>BB |              | X 0-0<br>2B |              | X 0-0<br>1-H<br>2B |                      |             | 3  | 0 | 2 | 1   | 1  | 1  | 0   |
| Russ Snyder, L (8, PR)<br>OBP: 0.391, SLG: 0.381    |                  |             |              |             |              |             |              |                    |                      |             | 0  | 0 | 0 | 0   | 0  | 0  | 0   |
| Willie Kirkland, L (1, 9)<br>OBP: 0.306, SLG: 0.236 |                  | X 0-0<br>1B |              | X 0-0<br>F7 |              | S 0-3<br>K  |              | X 4-0<br>IBB       |                      |             | 3  | 0 | 1 | 0   | 1  | 1  | 2   |
| John Orsino, R (1, 2)<br>OBP: 0.291, SLG: 0.400     |                  | S 0-3<br>K  |              |             | X 0-0<br>2B  |             | X 0-0<br>F6  | X 0-0<br>1-3       |                      |             | 4  | 0 | 1 | 0   | 0  | 1  | 3   |
| Robin Roberts, S (1, 1)<br>OBP: 0.100, SLG: 0.100   |                  | S 0-3<br>K  |              |             | X 0-0<br>F5  |             | X 0-0<br>5-3 |                    | S 4-0<br>SH5-4<br>BB |             | 3  | 0 | 0 | 0   | 0  | 1  | 2   |
| Stu Miller, R (9, 1)                                |                  |             |              |             |              |             |              |                    |                      |             | 0  | 0 | 0 | 0   | 0  | 0  | 0   |
| Joe Gaines, R (9, PH)<br>OBP: 0.300, SLG: 0.353     |                  |             |              |             |              |             |              |                    |                      |             | 0  | 0 | 0 | 0   | 1  | 0  | 0   |
| Dick Hall, R (10, 1)                                |                  |             |              |             |              |             |              |                    |                      |             | 0  | 0 | 0 | 0   | 0  | 0  | 0   |

| Inning Stats                        | R: 1 | H: 2 | E: 0 | K: 3 | S: 11 | H: 1 | LOB: 1 | BB: 0 | P: 11 | R: 0 | H: 1 | E: 0 | K: 3 | S: 10 | H: 1 | LOB: 1 | BB: 0 | P: 10 | R: 0 | H: 0 | E: 0 | K: 0 | S: 3 | H: 0 | LOB: 0 | BB: 0 | P: 3 | R: 0 | H: 1 | E: 0 | K: 0 | S: 3 | H: 0 | LOB: 1 | BB: 1 | P: 7 | R: 0 | H: 1 | E: 0 | K: 0 | S: 4 | H: 0 | LOB: 2 | BB: 1 | P: 8 | R: 0 | H: 1 | E: 0 | K: 3 | S: 10 | H: 1 | LOB: 1 | BB: 0 | P: 10 | R: 0 | H: 1 | E: 0 | K: 0 | S: 4 | H: 0 | LOB: 1 | BB: 0 | P: 4 | R: 1 | H: 1 | E: 0 | K: 1 | S: 6 | H: 1 | LOB: 2 | BB: 2 | P: 14 | R: 0 | H: 0 | E: 0 | K: 0 | S: 3 | H: 1 | LOB: 1 | BB: 1 | P: 7 | R: 1 | H: 1 | E: 0 | K: 0 | S: 1 | H: 1 | LOB: 0 | BB: 0 | P: 1 | 1B: 4 | SF: 0 | 2B: 4 | SAC: 1 | 3B: 0 | DP: 0 | HR: 1 | HBP: 0 | WP: 1 | PA: 40 |
|-------------------------------------|------|------|------|------|-------|------|--------|-------|-------|------|------|------|------|-------|------|--------|-------|-------|------|------|------|------|------|------|--------|-------|------|------|------|------|------|------|------|--------|-------|------|------|------|------|------|------|------|--------|-------|------|------|------|------|------|-------|------|--------|-------|-------|------|------|------|------|------|------|--------|-------|------|------|------|------|------|------|------|--------|-------|-------|------|------|------|------|------|------|--------|-------|------|------|------|------|------|------|------|--------|-------|------|-------|-------|-------|--------|-------|-------|-------|--------|-------|--------|
| PITCHER                             | IP   | WLS  | BF   | H    | R     | ER   | SO     | BB    | IBB   | HBP  | BLK  | WP   | HR   | S     | P    | ERA    | WHIP  |       |      |      |      |      |      |      |        |       |      |      |      |      |      |      |      |        |       |      |      |      |      |      |      |      |        |       |      |      |      |      |      |       |      |        |       |       |      |      |      |      |      |      |        |       |      |      |      |      |      |      |      |        |       |       |      |      |      |      |      |      |        |       |      |      |      |      |      |      |      |        |       |      |       |       |       |        |       |       |       |        |       |        |
| Moe Drabowsky, R (1, 1)<br>ERA: 5.7 | 8.0  |      | 35   | 8    | 2     | 2    | 10     | 3     | 1     | 0    | 0    | 1    | 0    | 51    | 67   | 2.25   | 1.375 |       |      |      |      |      |      |      |        |       |      |      |      |      |      |      |      |        |       |      |      |      |      |      |      |      |        |       |      |      |      |      |      |       |      |        |       |       |      |      |      |      |      |      |        |       |      |      |      |      |      |      |      |        |       |       |      |      |      |      |      |      |        |       |      |      |      |      |      |      |      |        |       |      |       |       |       |        |       |       |       |        |       |        |
| John Wyatt, R (9, 1)<br>ERA: 1.29   | 1.0  | L    | 5    | 1    | 1     | 1    | 0      | 1     | 0     | 0    | 0    | 0    | 1    | 4     | 8    | 9.00   | 2.000 |       |      |      |      |      |      |      |        |       |      |      |      |      |      |      |      |        |       |      |      |      |      |      |      |      |        |       |      |      |      |      |      |       |      |        |       |       |      |      |      |      |      |      |        |       |      |      |      |      |      |      |      |        |       |       |      |      |      |      |      |      |        |       |      |      |      |      |      |      |      |        |       |      |       |       |       |        |       |       |       |        |       |        |

BOTTOM

Kansas City Athletics @ Baltimore Orioles  
 Memorial Stadium, Baltimore, MD  
 Tue May 19 1964, 7:05 PM EDT  
 Att. 8,496 - Unknown

[livebaseballscorecards.com](http://livebaseballscorecards.com)

|     |    |
|-----|----|
| AB  | 34 |
| R   | 3  |
| H   | 9  |
| RBI | 3  |
| BB  | 5  |
| SO  | 10 |
| LOB | 16 |



| Batter  | 1   | 2                               | 3                            | 4                               | 5                            | 6                               | 7                            | 8                               | 9                            | AB R H RBI BB SO LOB            | TOP  |                                 |                              |                                 |                              |                                 |                              |                                 |                                  |                                    |                                  |        |
|---|---|---------------------------------|------------------------------|---------------------------------|------------------------------|---------------------------------|------------------------------|---------------------------------|------------------------------|---------------------------------|--|---------------------------------|------------------------------|---------------------------------|------------------------------|---------------------------------|------------------------------|---------------------------------|----------------------------------|------------------------------------|----------------------------------|--------|
| Wayne Causey, L (1, 6)<br>OBP: 0.381, SLG: 0.323    | 0-3<br>K  |                                 | 0-3<br>K                     |                                 |                              | x 0-0<br>F7                     |                              | x 0-0<br>F8                     |                              | 4 0 0 0 0 2 0                   | <b>Kansas City Athletics @ Baltimore Orioles</b><br><b>Memorial Stadium, Baltimore, MD</b><br>Wed May 20 1964, 7:05 PM EDT<br>Att. 6,197 - Unknown<br><a href="http://livebaseballscorecards.com">livebaseballscorecards.com</a> |                                 |                              |                                 |                              |                                 |                              |                                 |                                  |                                    |                                  |        |
| Nelson Mathews, R (1, 8)<br>OBP: 0.360, SLG: 0.437  | 0-0<br>1-3  |                                 |                              | x 0-0<br>1-3                    |                              | x 0-0<br>F8                     |                              | x 0-0<br>SF9 3B                 | 4 1 1 0 0 0 0                |                                 |  |                                 |                              |                                 |                              |                                 |                              |                                 |                                  |                                    |                                  |        |
| Ed Charles, R (1, 5)<br>OBP: 0.371, SLG: 0.369      | 0-0<br>1-3  |                                 |                              | x 0-0<br>F9                     |                              | x 0-0<br>F9                     |                              | x 0-0<br>L6                     | 4 0 0 0 0 0 1                |                                 |  |                                 |                              |                                 |                              |                                 |                              |                                 |                                  |                                    |                                  |        |
| Jim Gentile, L (1, 3)<br>OBP: 0.377, SLG: 0.472     |   | 0-3<br>K                        |                              | x 0-0<br>F6                     |                              | x 0-0<br>1B 2B                  |                              | x 0-0<br>SF9                    | 3 1 1 1 0 1 0                |                                 |  |                                 |                              |                                 |                              |                                 |                              |                                 |                                  |                                    |                                  |        |
| Rocky Colavito, R (1, 9)<br>OBP: 0.417, SLG: 0.667  |   | 0-3<br>K                        |                              | x 0-0<br>E5 1B                  |                              | x 0-0<br>2-H 1B 1-3             |                              | x 0-0<br>5-3                    | 4 0 2 1 0 1 0                |                                 |  |                                 |                              |                                 |                              |                                 |                              |                                 |                                  |                                    |                                  |        |
| Manny Jimenez, L (1, 7)<br>OBP: 0.276, SLG: 0.481   |   | 0-0<br>1-3                      |                              | x 0-0<br>K                      |                              | x 0-0<br>1-3 1-2                |                              |                                 | 3 0 0 0 0 1 2                |                                 |  |                                 |                              |                                 |                              |                                 |                              |                                 |                                  |                                    |                                  |        |
| Charlie Lau, L (1, 2)<br>OBP: 0.419, SLG: 0.561     |   |                                 | x 0-0<br>4-3 WP 2B           |                                 | x 0-0<br>L8                  |                                 | x 0-3<br>K                   |                                 | 2 1 1 0 0 0 1                |                                 |  |                                 |                              |                                 |                              |                                 |                              |                                 |                                  |                                    |                                  |        |
| Dave Duncan, R (5, 2)<br>OBP: 0.333, SLG: 0.333     |   |                                 |                              |                                 |                              |                                 |                              |                                 | 1 0 0 0 0 1 1                |                                 |  |                                 |                              |                                 |                              |                                 |                              |                                 |                                  |                                    |                                  |        |
| Dick Green, R (1, 4)<br>OBP: 0.248, SLG: 0.351      |   |                                 | x 0-0<br>4-3                 |                                 | x 0-0<br>F7                  |                                 | x 0-0<br>F4                  |                                 | 3 0 0 0 0 0 2                |                                 |  |                                 |                              |                                 |                              |                                 |                              |                                 |                                  |                                    |                                  |        |
| Diego Segui, R (1, 1)<br>OBP: 0.313, SLG: 0.467     |   |                                 | x 0-0<br>F9                  |                                 | x 0-0<br>L9                  |                                 | x 0-0<br>F5                  |                                 | 1 0 0 0 0 0 0                |                                 |  |                                 |                              |                                 |                              |                                 |                              |                                 |                                  |                                    |                                  |        |
| Jack Aker, R (5, 1)                                 |   |                                 |                              |                                 |                              |                                 |                              |                                 | 0 0 0 0 0 0 0                |                                 |  |                                 |                              |                                 |                              |                                 |                              |                                 |                                  |                                    |                                  |        |
| Jose Tartabull, L (6, PH)<br>OBP: 0.290, SLG: 0.300 |   |                                 |                              |                                 |                              |                                 |                              |                                 | 1 0 0 0 0 0 0                |                                 |  |                                 |                              |                                 |                              |                                 |                              |                                 |                                  |                                    |                                  |        |
| Vern Handrahan, L (6, 1)                            |   |                                 |                              |                                 |                              |                                 |                              |                                 | 0 0 0 0 0 0 0                |                                 |  |                                 |                              |                                 |                              |                                 |                              |                                 |                                  |                                    |                                  |        |
| George Alusik, R (8, PH)<br>OBP: 0.528, SLG: 0.500  |   |                                 |                              |                                 |                              |                                 |                              |                                 | 1 0 0 0 0 0 0                |                                 |  |                                 |                              |                                 |                              |                                 |                              |                                 |                                  |                                    |                                  |        |
| Ted Bowfield, R (8, 1)                              |   |                                 |                              |                                 |                              |                                 |                              |                                 | 0 0 0 0 0 0 0                |                                 |  |                                 |                              |                                 |                              |                                 |                              |                                 |                                  |                                    |                                  |        |
| <b>Inning Stats</b>                                 | R: 0<br>E: 0<br>K: 1<br>S: 5  | H: 0<br>LOB: 0<br>BB: 0<br>P: 5 | R: 0<br>E: 0<br>K: 2<br>S: 7 | H: 0<br>LOB: 0<br>BB: 0<br>P: 7 | R: 1<br>E: 0<br>K: 1<br>S: 6 | H: 1<br>LOB: 0<br>BB: 0<br>P: 6 | R: 0<br>E: 0<br>K: 0<br>S: 3 | H: 0<br>LOB: 0<br>BB: 0<br>P: 3 | R: 0<br>E: 1<br>K: 1<br>S: 6 | H: 1<br>LOB: 1<br>BB: 0<br>P: 6 | R: 0<br>E: 0<br>K: 0<br>S: 3   | H: 0<br>LOB: 0<br>BB: 0<br>P: 3 | R: 1<br>E: 0<br>K: 1<br>S: 7 | H: 2<br>LOB: 1<br>BB: 0<br>P: 7 | R: 0<br>E: 0<br>K: 0<br>S: 3 | H: 0<br>LOB: 0<br>BB: 0<br>P: 3 | R: 1<br>E: 0<br>K: 0<br>S: 4 | H: 1<br>LOB: 0<br>BB: 0<br>P: 4 | 1B: 2<br>2B: 2<br>3B: 1<br>HR: 0 | SF: 1<br>SAC: 0<br>DP: 0<br>HBP: 0 | WP: 1<br>PB: 0<br>SB: 0<br>CS: 0 | PA: 32 |
| <b>PITCHER</b><br>Milt Pappas, R (1, 1)<br>ERA: 2.6 | IP 9.0<br>WLS W<br>BF 32<br>H 5<br>R 3<br>ER 3<br>SO 6<br>BB 0<br>IBB 0<br>HBP 0<br>BLK 0<br>WP 1<br>HR 0<br>S 44<br>P 44<br>ERA 3.00<br>WHIP 0.556 |                                 |                              |                                 |                              |                                 |                              |                                 |                              |                                 |  |                                 |                              |                                 |                              |                                 |                              |                                 |                                  |                                    |                                  |        |

**Kansas City Athletics @ Baltimore Orioles**  
**Memorial Stadium, Baltimore, MD**  
 Wed May 20 1964, 7:05 PM EDT  
 Att. 6,197 - Unknown

|     |    |
|-----|----|
| AB  | 31 |
| R   | 3  |
| H   | 5  |
| RBI | 2  |
| BB  | 0  |
| SO  | 6  |
| LOB | 7  |



| Batter  | 1   | 2  | 3  | 4   | 5   | 6   | 7  | 8   | 9  | AB   | R | H | RBI | BB | SO | LOB | BOTTOM   |
|---|---|--|--|---|---|---|--|---|--|--|---|---|-----|----|----|-----|--|
| Jackie Brandt, R<br>OBP: 0.326, SLG: 0.362 (1, 8) X   | 0-0<br>FC6-4<br>1B  | 0-0<br>F2  |  |   |   | 0-0<br>1B<br>2B   |  | 0-3<br>K  |  | 5  | 1 | 2 | 0   | 0  | 2  | 1   | <b>Kansas City Athletics @ Baltimore Orioles</b><br><b>Memorial Stadium, Baltimore, MD</b><br>Wed May 20 1964, 7:05 PM EDT<br>Att. 6,197 - Unknown |
| Luis Aparicio, R<br>OBP: 0.321, SLG: 0.333 (1, 6) X   | 0-0<br>FC6-4<br>1-2f  |  |  |   |   | 0-0<br>6-3<br>1B  |  | 0-0<br>G1-4-3<br>1B   |  | 4  | 1 | 2 | 0   | 1  | 0  | 2   |  |
| Bob Johnson, R<br>OBP: 0.263, SLG: 0.382 (1, 4) S S   | 0-3<br>K<br>1-3   |  |  |   |   | 0-0<br>1B<br>2B<br>1B   |  | 0-0<br>G1-4-3   |  | 5  | 2 | 2 | 2   | 0  | 1  | 3   |  |
| Norm Siebern, L<br>OBP: 0.437, SLG: 0.477 (1, 3) B B B  | 4-0<br>BB   |  |  |   |   | 0-0<br>2B<br>1B   |  | 4-0<br>G6-4-3<br>BB   |  | 2  | 1 | 1 | 0   | 2  | 0  | 1   |  |
| Brooks Robinson, R<br>OBP: 0.357, SLG: 0.471 (1, 5) X   | 0-0<br>6-3  |  |  |   |   | 0-0<br>HR<br>2B   |  | 0-0<br>G6-4-3   |  | 3  | 1 | 1 | 3   | 0  | 0  | 3   |  |
| Boog Powell, L<br>OBP: 0.337, SLG: 0.533 (1, 7) X   |   | 0-0<br>6-3   |  |   |   | 0-0<br>HR   |  | 4-0<br>PB<br>1B<br>BB   |  | 3  | 1 | 1 | 2   | 1  | 0  | 0   |  |
| Willie Kirkland, L<br>OBP: 0.333, SLG: 0.288 (1, 9) X   |   | 0-0<br>1B<br>2B  |  |   |   | 0-0<br>L6<br>HBP<br>1B  |  | 0-0<br>PB<br>1B   |  | 4  | 1 | 3 | 0   | 0  | 0  | 0   |  |
| John Orsino, R<br>OBP: 0.299, SLG: 0.398 (1, 2) X   |   | 0-0<br>1B  |  |   |   | 0-0<br>F8<br>HBP  |  | 0-0<br>5-3  |  | 3  | 0 | 1 | 1   | 0  | 0  | 2   |  |
| Milt Pappas, R<br>OBP: 0.176, SLG: 0.188 (1, 1) S S S   |   | 0-3<br>K   |  |   |   | 0-0<br>6-3<br>L6-4  |  | 0-3<br>K  |  | 4  | 0 | 0 | 0   | 0  | 2  | 3   |  |
| <b>Inning Stats</b>   | R: 0<br>E: 0<br>K: 1<br>S: 6<br>H: 1<br>LOB: 2<br>BB: 1<br>P: 10  | R: 1<br>E: 0<br>K: 1<br>S: 7<br>H: 2<br>LOB: 1<br>BB: 0<br>P: 7  | R: 2<br>E: 0<br>K: 0<br>S: 4<br>H: 1<br>LOB: 0<br>BB: 1<br>P: 8  | R: 0<br>E: 0<br>K: 0<br>S: 3<br>H: 0<br>LOB: 0<br>BB: 0<br>P: 3   | R: 5<br>E: 0<br>K: 0<br>S: 8<br>H: 6<br>LOB: 1<br>BB: 0<br>P: 9 | R: 0<br>E: 0<br>K: 1<br>S: 5<br>H: 1<br>LOB: 0<br>BB: 0<br>P: 5                                       | R: 0<br>E: 0<br>K: 0<br>S: 3<br>H: 1<br>LOB: 2<br>BB: 2<br>P: 11 | R: 0<br>E: 0<br>K: 2<br>S: 8<br>H: 1<br>LOB: 1<br>BB: 0<br>P: 8 | 1B: 8<br>2B: 4<br>3B: 1<br>HR: 1<br>SF: 1<br>SAC: 0<br>DP: 3<br>HBP: 1 | WP: 0<br>PB: 1<br>SB: 3<br>CS: 0<br>PA: 39 |   |   |     |    |    |     |  |
| <b>PITCHER</b><br>Diego Segui, R<br>ERA: 4.3<br>Jack Aker, R<br>ERA: 10.03<br>Vern Handrahan, R<br>ERA: 7.17<br>Ted Bowsfield, L<br>ERA: 5.56 | IP<br>4.1<br>WLS<br>L<br>BF<br>22<br>H<br>7<br>R<br>6<br>ER<br>6<br>SO<br>2<br>BB<br>2<br>IBB<br>0<br>HBP<br>0<br>BLK<br>0<br>WP<br>0<br>HR<br>0<br>S<br>24<br>P<br>32<br>ERA<br>12.46<br>WHIP<br>2.077 | IP<br>5.1<br>WLS<br>L<br>BF<br>5<br>H<br>3<br>R<br>2<br>ER<br>2<br>SO<br>0<br>BB<br>0<br>IBB<br>0<br>HBP<br>1<br>BLK<br>0<br>WP<br>0<br>HR<br>4<br>S<br>5<br>ERA<br>27.00<br>WHIP<br>4.500 | IP<br>6.1<br>WLS<br>L<br>BF<br>8<br>H<br>2<br>R<br>0<br>ER<br>0<br>SO<br>1<br>BB<br>0<br>IBB<br>0<br>HBP<br>0<br>BLK<br>0<br>WP<br>0<br>HR<br>8<br>S<br>16<br>ERA<br>0.00<br>WHIP<br>2.000 | IP<br>8.1<br>WLS<br>L<br>BF<br>4<br>H<br>1<br>R<br>0<br>ER<br>0<br>SO<br>2<br>BB<br>0<br>IBB<br>0<br>HBP<br>0<br>BLK<br>0<br>WP<br>0<br>HR<br>8<br>S<br>8<br>ERA<br>0.00<br>WHIP<br>1.000 | <b>PITCHER</b>  | IP<br>WLS<br>BF<br>H<br>R<br>ER<br>SO<br>BB<br>IBB<br>HBP<br>BLK<br>WP<br>HR<br>S<br>P<br>ERA<br>WHIP |  |   |  |  |   |   |     |    |    |     |  |

**AB** 33  
**R** 8  
**H** 13  
**RBI** 8  
**BB** 4  
**SO** 5  
**LOB** 15

| Batter  | 1   | 2                                | 3                            | 4                               | 5                            | 6                               | 7                            | 8                                | 9                            | AB R H RBI BB SO LOB            | TOP                          |                                 |                              |                                 |                              |                                  |                              |                                 |                                  |                                    |                                  |        |
|---|---|----------------------------------|------------------------------|---------------------------------|------------------------------|---------------------------------|------------------------------|----------------------------------|------------------------------|---------------------------------|------------------------------|---------------------------------|------------------------------|---------------------------------|------------------------------|----------------------------------|------------------------------|---------------------------------|----------------------------------|------------------------------------|----------------------------------|--------|
| Wayne Causey, L (1, 6)<br>OBP: 0.382, SLG: 0.320    | 4-0<br>BB<br>1B<br>BB                                 |                                  | x 0-0<br>BB<br>1B            |                                 | x 0-0<br>L8                  |                                 | x 0-0<br>4-3                 |                                  | 0-3<br>K                     | 4 1 1 0 1 1 1                   |                              |                                 |                              |                                 |                              |                                  |                              |                                 |                                  |                                    |                                  |        |
| Nelson Mathews, R (1, 8)<br>OBP: 0.361, SLG: 0.431  | 4-0<br>1B<br>1-2<br>BB                                |                                  | x 0-0<br>F9                  |                                 | x 0-0<br>FC3-4               |                                 |                              | 0-0<br>BB<br>1B<br>HR<br>1B      | 0-0<br>F6                    | 4 1 1 0 1 0 2                   |                              |                                 |                              |                                 |                              |                                  |                              |                                 |                                  |                                    |                                  |        |
| Ed Charles, R (1, 5)<br>OBP: 0.387, SLG: 0.377      | 0-0<br>1-3<br>2-H<br>1B                               |                                  | 0-0<br>1-2<br>BB             |                                 | 4-0<br>1-2<br>BB             |                                 |                              | 0-0<br>1-2<br>HR<br>1B           | 0-0<br>1-3                   | 3 1 2 1 2 0 0                   |                              |                                 |                              |                                 |                              |                                  |                              |                                 |                                  |                                    |                                  |        |
| Jim Gentile, L (1, 3)<br>OBP: 0.373, SLG: 0.459     | 0-3<br>K  |                                  | x 0-0<br>F8                  |                                 | x 0-0<br>F8                  |                                 |                              | 4-0<br>1-2<br>2-3<br>HR<br>BB    |                              | 3 1 0 0 1 1 6                   |                              |                                 |                              |                                 |                              |                                  |                              |                                 |                                  |                                    |                                  |        |
| Rocky Colavito, R (1, 9)<br>OBP: 0.412, SLG: 0.680  | 0-0<br>1-2<br>L5-3                                    |                                  |                              | x 0-0<br>HR                     |                              | x 0-0<br>F7                     |                              | x 0-0<br>F7                      |                              | 4 1 1 1 0 0 5                   |                              |                                 |                              |                                 |                              |                                  |                              |                                 |                                  |                                    |                                  |        |
| Manny Jimenez, L (1, 7)<br>OBP: 0.274, SLG: 0.518   |   | x 0-0<br>1-3                     |                              | x 0-0<br>4-3                    |                              | x 0-0<br>L7                     |                              | x 0-0<br>1-H<br>2-H<br>3-H<br>HR |                              | 4 1 1 4 0 0 0                   |                              |                                 |                              |                                 |                              |                                  |                              |                                 |                                  |                                    |                                  |        |
| Charlie Lau, L (1, 2)<br>OBP: 0.397, SLG: 0.529     |   | x 0-0<br>F5                      |                              | x 0-0<br>L8                     |                              | x 0-0<br>6-3                    |                              | x 0-0<br>F8                      |                              | 4 0 0 0 0 0 0                   |                              |                                 |                              |                                 |                              |                                  |                              |                                 |                                  |                                    |                                  |        |
| George Williams, R (1, 4)<br>OBP: 0.211, SLG: 0.118 |   | x 0-0<br>F8                      |                              | x 0-0<br>F2                     |                              |                                 | x 0-0<br>1-3                 | x 0-0<br>2B                      |                              | 3 0 0 0 0 0 0                   |                              |                                 |                              |                                 |                              |                                  |                              |                                 |                                  |                                    |                                  |        |
| George Alusik, R (8, PH)<br>OBP: 0.541, SLG: 0.560  |   |                                  |                              |                                 |                              |                                 |                              |                                  |                              | 1 0 1 0 0 0 0                   |                              |                                 |                              |                                 |                              |                                  |                              |                                 |                                  |                                    |                                  |        |
| Dick Green, R (8, PR)<br>OBP: 0.248, SLG: 0.351     |   |                                  |                              |                                 |                              |                                 |                              |                                  |                              | 0 0 0 0 0 0 0                   |                              |                                 |                              |                                 |                              |                                  |                              |                                 |                                  |                                    |                                  |        |
| John O'Donoghue, R (1, 1)<br>OBP: 0.455, SLG: 0.455 |   |                                  | x 0-0<br>4-3                 |                                 | x 0-0<br>FC3-4<br>1B         |                                 | x 0-0<br>F7                  | x 0-3<br>K                       |                              | 2 0 1 0 0 0 0                   |                              |                                 |                              |                                 |                              |                                  |                              |                                 |                                  |                                    |                                  |        |
| Ted Bowsfield, R (5, 1)                             |   |                                  |                              |                                 |                              |                                 |                              |                                  |                              | 0 0 0 0 0 0 0                   |                              |                                 |                              |                                 |                              |                                  |                              |                                 |                                  |                                    |                                  |        |
| Vern Handrahan, L (6, 1)                            |   |                                  |                              |                                 |                              |                                 |                              |                                  |                              | 1 0 0 0 0 0 0                   |                              |                                 |                              |                                 |                              |                                  |                              |                                 |                                  |                                    |                                  |        |
| Billy Bryan, L (8, PH)<br>OBP: 0.313, SLG: 0.615    |   |                                  |                              |                                 |                              |                                 |                              |                                  |                              | 1 0 0 0 0 1 1                   |                              |                                 |                              |                                 |                              |                                  |                              |                                 |                                  |                                    |                                  |        |
| John Wyatt, R (8, 1)                                |   |                                  |                              |                                 |                              |                                 |                              |                                  |                              | 0 0 0 0 0 0 0                   |                              |                                 |                              |                                 |                              |                                  |                              |                                 |                                  |                                    |                                  |        |
| <b>Inning Stats</b>                                 | R: 1<br>E: 0<br>K: 1<br>S: 5                          | H: 1<br>LOB: 1<br>BB: 2<br>P: 13 | R: 0<br>E: 0<br>K: 0<br>S: 3 | H: 0<br>LOB: 0<br>BB: 0<br>P: 3 | R: 0<br>E: 0<br>K: 0<br>S: 4 | H: 1<br>LOB: 2<br>BB: 1<br>P: 8 | R: 1<br>E: 0<br>K: 0<br>S: 4 | H: 1<br>LOB: 0<br>BB: 0<br>P: 4  | R: 0<br>E: 0<br>K: 0<br>S: 4 | H: 1<br>LOB: 2<br>BB: 1<br>P: 8 | R: 0<br>E: 0<br>K: 0<br>S: 3 | H: 0<br>LOB: 0<br>BB: 0<br>P: 3 | R: 0<br>E: 0<br>K: 0<br>S: 3 | H: 0<br>LOB: 0<br>BB: 0<br>P: 3 | R: 4<br>E: 0<br>K: 1<br>S: 9 | H: 4<br>LOB: 1<br>BB: 1<br>P: 13 | R: 0<br>E: 0<br>K: 1<br>S: 5 | H: 0<br>LOB: 0<br>BB: 0<br>P: 5 | 1B: 5<br>2B: 2<br>3B: 0<br>HR: 2 | SF: 0<br>SAC: 0<br>DP: 1<br>HBP: 0 | WP: 0<br>PB: 0<br>SB: 1<br>CS: 0 | PA: 39 |
| <b>PITCHER</b>                                      | IP WLS BF H R ER SO BB IBB HBP BLK WP HR S P ERA WHIP |                                  |                              |                                 |                              |                                 |                              |                                  |                              |                                 |                              |                                 |                              |                                 |                              |                                  |                              |                                 |                                  |                                    |                                  |        |
| Wally Bunker, R (1, 1)<br>ERA: 1.85                 | 7.0 W 31 6 5 5 1 5 0 0 0 0 0 1 28 48 6.43 1.571       |                                  |                              |                                 |                              |                                 |                              |                                  |                              |                                 |                              |                                 |                              |                                 |                              |                                  |                              |                                 |                                  |                                    |                                  |        |
| Stu Miller, R (8, 1)<br>ERA: 2.42                   | 2.0 S 8 2 1 1 2 0 0 0 0 0 0 1 12 12 4.50 1.000        |                                  |                              |                                 |                              |                                 |                              |                                  |                              |                                 |                              |                                 |                              |                                 |                              |                                  |                              |                                 |                                  |                                    |                                  |        |

**Kansas City Athletics @ Baltimore Orioles**  
**Memorial Stadium, Baltimore, MD**  
 Thu May 21 1964, 7:05 PM EDT  
 Att. 8,996 - Unknown

|     |    |
|-----|----|
| AB  | 34 |
| R   | 6  |
| H   | 8  |
| RBI | 6  |
| BB  | 5  |
| SO  | 3  |
| LOB | 15 |



|       |        |
|-------|--------|
| WP: 0 | PA: 39 |
|-------|--------|



| Batter  | 1                  | 2                               | 3                               | 4                       | 5          | 6                      | 7                     | 8         | 9 | AB | R | H | RBI | BB | SO | LOB |
|---|--------------------|---------------------------------|---------------------------------|-------------------------|------------|------------------------|-----------------------|-----------|---|----|---|---|-----|----|----|-----|
| Jackie Brandt, R<br>OBP: 0.327, SLG: 0.363 (1, 8)   | 0-0<br>5-3         | 0-0<br>F3                       |                                 | 0-0<br>1B<br>2B         | 4-0<br>BB  | 0-3<br>K               |                       | 0-0<br>F8 |   | 5  | 1 | 1 | 0   | 1  | 1  | 7   |
| Luis Aparicio, R<br>OBP: 0.315, SLG: 0.326 (1, 6)   | 0-0<br>F8          |                                 | 0-0<br>G3<br>S<br>6-3<br>1B     | 0-0<br>F2               | 0-0<br>4-3 | 0-0<br>FC6-4           |                       | 0-0<br>L7 |   | 6  | 1 | 1 | 0   | 0  | 0  | 7   |
| Bob Johnson, R<br>OBP: 0.279, SLG: 0.368 (1, 4)     | 4-0<br>FC6-4<br>BB |                                 | 0-0<br>G3                       | 0-0<br>5-3              |            | 0-0<br>FC1-4<br>1B     | 0-3<br>K              |           |   | 4  | 0 | 1 | 0   | 1  | 1  | 2   |
| Norm Siebern, L<br>OBP: 0.436, SLG: 0.464 (1, 3)    | 0-0<br>FC6-4       |                                 | 4-0<br>6-3<br>2B<br>BB          | 4-0<br>1B<br>BB         |            | 0-0<br>FC1-4<br>3B     | 0-0<br>F6             |           |   | 3  | 2 | 0 | 0   | 2  | 0  | 2   |
| Brooks Robinson, R<br>OBP: 0.373, SLG: 0.496 (1, 5) |                    | 4-0<br>BB<br>FC5-2<br>HBP<br>BB | 0-0<br>6-3                      | 0-0<br>1-2<br>3-H<br>1B |            | 0-0<br>1-H<br>1B<br>3B | 0-0<br>2B<br>1B       |           |   | 4  | 2 | 3 | 3   | 1  | 0  | 1   |
| Boog Powell, L<br>OBP: 0.358, SLG: 0.548 (1, 7)     |                    | 1-0<br>FC5-2<br>BB<br>HBP       | 4-0<br>2B<br>BB                 | 0-3<br>K                |            | 0-0<br>E<br>BB<br>1B   | 0-0<br>1-H<br>2B      |           |   | 3  | 1 | 2 | 2   | 1  | 1  | 2   |
| Russ Snyder, L<br>OBP: 0.391, SLG: 0.381 (8, 7)     |                    | 1-2<br>HBP                      |                                 |                         |            |                        |                       |           |   | 0  | 0 | 0 | 0   | 0  | 0  | 0   |
| Sam Bowers, R<br>OBP: 0.333, SLG: 0.391 (1, 9)      |                    | 4-0<br>FC5-2<br>BB              | 0-0<br>1-2<br>2-3<br>BB         | 0-0<br>1-3<br>2-H<br>2B |            | 0-0<br>F9              | 0-0<br>E7<br>BB<br>1B | 0-0<br>F7 |   | 4  | 0 | 2 | 1   | 1  | 0  | 1   |
| Willie Kirkland, L<br>OBP: 0.333, SLG: 0.288 (8, 9) |                    |                                 |                                 |                         |            |                        |                       |           |   | 0  | 0 | 0 | 0   | 0  | 0  | 0   |
| John Orsino, R<br>OBP: 0.313, SLG: 0.406 (1, 2)     |                    | 0-0<br>FC5-2                    | 4-0<br>1-2<br>2-3<br>3-H<br>IBB |                         | 0-0<br>2B  | 4-0<br>BB<br>IBB       |                       | 0-0<br>F2 |   | 3  | 0 | 1 | 0   | 2  | 0  | 3   |
| Wally Bunker, R<br>OBP: 0.214, SLG: 0.231 (1, 1)    |                    | 0-3<br>K                        | 0-0<br>3-1                      |                         | 0-3<br>K   | 4-0<br>FC6-4<br>BB     |                       | 0-0<br>E4 |   | 3  | 0 | 0 | 1   | 1  | 2  | 7   |
| Stu Miller, R (8, 1)                                |                    |                                 |                                 |                         |            |                        |                       |           |   | 1  | 0 | 0 | 0   | 0  | 0  | 0   |

| Inning Stats | R: 0 | H: 0 | E: 0 | K: 0 | S: 3 | LOB: 1 | BB: 1 | P: 7 | R: 0 | H: 0 | E: 0 | K: 1 | S: 5 | LOB: 3 | BB: 2 | P: 14 | R: 2 | H: 2 | E: 0 | K: 0 | S: 5 | LOB: 3 | BB: 3 | P: 17 | R: 1 | H: 2 | E: 0 | K: 1 | S: 7 | LOB: 2 | BB: 1 | P: 11 | R: 0 | H: 1 | E: 0 | K: 1 | S: 6 | LOB: 2 | BB: 1 | P: 10 | R: 3 | H: 4 | E: 1 | K: 1 | S: 9 | LOB: 3 | BB: 2 | P: 17 | R: 1 | H: 2 | E: 0 | K: 1 | S: 7 | LOB: 1 | BB: 0 | P: 7 | R: 0 | H: 0 | E: 1 | K: 0 | S: 4 | LOB: 1 | BB: 0 | P: 4 |
|--------------|------|------|------|------|------|--------|-------|------|------|------|------|------|------|--------|-------|-------|------|------|------|------|------|--------|-------|-------|------|------|------|------|------|--------|-------|-------|------|------|------|------|------|--------|-------|-------|------|------|------|------|------|--------|-------|-------|------|------|------|------|------|--------|-------|------|------|------|------|------|------|--------|-------|------|
|--------------|------|------|------|------|------|--------|-------|------|------|------|------|------|------|--------|-------|-------|------|------|------|------|------|--------|-------|-------|------|------|------|------|------|--------|-------|-------|------|------|------|------|------|--------|-------|-------|------|------|------|------|------|--------|-------|-------|------|------|------|------|------|--------|-------|------|------|------|------|------|------|--------|-------|------|

|       |        |       |        |
|-------|--------|-------|--------|
| 1B: 6 | SF: 0  | WP: 0 | PA: 47 |
| 2B: 4 | SAC: 0 | PB: 0 |        |
| 3B: 1 | DP: 0  | SB: 1 |        |
| HR: 0 | HBP: 1 | CS: 0 |        |

| PITCHER                                | IP  | WLS | BF | H | R | ER | SO | BB | IBB | HBP | BLK | WP | HR | S  | P  | ERA   | WHIP  |
|--|-----|-----|----|---|---|----|----|----|-----|-----|-----|----|----|----|----|-------|-------|
| John O'Donoghue, L (1, 1)<br>ERA: 4.81 | 4.2 | L   | 28 | 5 | 3 | 3  | 3  | 7  | 1   | 1   | 0   | 0  | 0  | 25 | 58 | 5.79  | 2.571 |
| Ted Bowsfield, L (5, 1)<br>ERA: 7.5    | 0.2 |     | 8  | 4 | 3 | 3  | 0  | 1  | 1   | 0   | 0   | 0  | 0  | 6  | 14 | 40.50 | 7.500 |
| Vern Handrahan, R (6, 1)<br>ERA: 7.04  | 1.2 |     | 7  | 2 | 1 | 1  | 2  | 0  | 0   | 0   | 0   | 0  | 0  | 11 | 11 | 5.40  | 1.200 |
| John Wyatt, R (8, 1)<br>ERA: 1.23      | 1.0 |     | 4  | 0 | 0 | 0  | 0  | 0  | 0   | 0   | 0   | 0  | 0  | 4  | 4  | 0.00  | 0.000 |

BOTTOM

Kansas City Athletics @ Baltimore Orioles  
Memorial Stadium, Baltimore, MD  
Thu May 21 1964, 7:05 PM EDT  
Att. 8,996 - Unknown

livebaseballscorecards.com

|     |    |
|-----|----|
| AB  | 36 |
| R   | 7  |
| H   | 11 |
| RBI | 7  |
| BB  | 10 |
| SO  | 5  |
| LOB | 32 |



| Batter   | 1   | 2                               | 3                            | 4                                | 5                            | 6                               | 7                            | 8                               | 9                            | AB R H RBI BB SO LOB            | TOP   |                                 |                              |                                 |                              |                                 |                              |                                 |                                  |                                    |                                  |        |
|--|---|---------------------------------|------------------------------|----------------------------------|------------------------------|---------------------------------|------------------------------|---------------------------------|------------------------------|---------------------------------|---|---------------------------------|------------------------------|---------------------------------|------------------------------|---------------------------------|------------------------------|---------------------------------|----------------------------------|------------------------------------|----------------------------------|--------|
| Wayne Causey, L (1, 6)<br>OBP: 0.378, SLG: 0.318   | 0-3<br>K  |                                 | x 0-0<br>F4                  |                                  |                              | x 0-0<br>FC1-6<br>1B            |                              | x 0-0<br>F6                     |                              | 4 0 1 0 0 1 0                   | <b>Kansas City Athletics @ Boston Red Sox</b><br>Fenway Park, Boston, MA<br>Fri May 22 1964, 7:05 PM EDT<br>Att. 13,728 - Unknown<br><a href="http://livebaseballscorecards.com">livebaseballscorecards.com</a> |                                 |                              |                                 |                              |                                 |                              |                                 |                                  |                                    |                                  |        |
| Nelson Mathews, R (1, 8)<br>OBP: 0.358, SLG: 0.425 | 0-0<br>6-3  |                                 | x 0-0<br>1B                  |                                  |                              | x 0-0<br>FC1-6<br>1B<br>HR      |                              | x 0-0<br>F5                     |                              | 4 1 1 0 0 0 1                   |   |                                 |                              |                                 |                              |                                 |                              |                                 |                                  |                                    |                                  |        |
| Ed Charles, R (1, 5)<br>OBP: 0.390, SLG: 0.376     | 0-0<br>E6<br>CS                                       |                                 | x 0-0<br>L8                  |                                  |                              | x 0-0<br>1-2<br>HR<br>1B        |                              | H 1-0<br>HBP                    |                              | 3 1 1 0 0 0 1                   |   |                                 |                              |                                 |                              |                                 |                              |                                 |                                  |                                    |                                  |        |
| Rocky Colavito, R (1, 9)<br>OBP: 0.415, SLG: 0.699 | 0-0<br>CS<br>1-2                                      | 4-0<br>2B<br>SF7<br>BB          |                              | S 0-3<br>K                       |                              | x 0-0<br>1-H<br>2-H<br>HR       |                              | S 0-3<br>K                      |                              | 3 2 1 3 1 2 1                   |   |                                 |                              |                                 |                              |                                 |                              |                                 |                                  |                                    |                                  |        |
| Jim Gentile, L (1, 3)<br>OBP: 0.362, SLG: 0.443    |   | S 0-3<br>K                      |                              | x 0-0<br>F8                      |                              | x 0-0<br>3-1                    |                              | x 0-0<br>F3                     |                              | 4 0 0 0 0 1 1                   |   |                                 |                              |                                 |                              |                                 |                              |                                 |                                  |                                    |                                  |        |
| George Alusik, R (1, 7)<br>OBP: 0.512, SLG: 0.552  |   | x 0-0<br>1-3<br>2B              |                              | x 0-0<br>F7                      |                              | x 0-0<br>5-3                    |                              | S 0-3<br>K                      |                              | 4 0 1 0 0 1 0                   |   |                                 |                              |                                 |                              |                                 |                              |                                 |                                  |                                    |                                  |        |
| Charlie Lau, L (1, 2)<br>OBP: 0.390, SLG: 0.534    |   | x 0-0<br>SF7<br>3-H             |                              | x 0-0<br>2B                      |                              | x 0-0<br>4-3                    |                              | x 0-0<br>L7                     |                              | 3 0 1 1 0 0 0                   |   |                                 |                              |                                 |                              |                                 |                              |                                 |                                  |                                    |                                  |        |
| Dick Green, R (1, 4)<br>OBP: 0.242, SLG: 0.342     |   | x 0-0<br>F8                     |                              | S 0-3<br>K                       |                              | x 0-0<br>F6                     |                              | x 0-0<br>F6                     |                              | 3 0 0 0 0 1 1                   |   |                                 |                              |                                 |                              |                                 |                              |                                 |                                  |                                    |                                  |        |
| Orlando Pena, R (1, 1)<br>John Wyatt, R (7, 1)     |   |                                 | x 0-0<br>1-3                 |                                  | x 0-0<br>F9                  |                                 | S 0-3<br>K                   |                                 |                              | 3 0 0 0 0 1 0<br>0 0 0 0 0 0 0  |   |                                 |                              |                                 |                              |                                 |                              |                                 |                                  |                                    |                                  |        |
| <b>Inning Stats</b>                                | R: 0<br>E: 1<br>K: 1<br>S: 5                          | H: 0<br>LOB: 0<br>BB: 0<br>P: 5 | R: 1<br>E: 0<br>K: 1<br>S: 6 | H: 1<br>LOB: 1<br>BB: 1<br>P: 10 | R: 0<br>E: 0<br>K: 0<br>S: 4 | H: 1<br>LOB: 1<br>BB: 0<br>P: 4 | R: 0<br>E: 0<br>K: 1<br>S: 5 | H: 0<br>LOB: 0<br>BB: 0<br>P: 5 | R: 3<br>E: 0<br>K: 0<br>S: 6 | H: 3<br>LOB: 0<br>BB: 0<br>P: 6 | R: 0<br>E: 0<br>K: 1<br>S: 5  | H: 0<br>LOB: 0<br>BB: 0<br>P: 5 | R: 0<br>E: 0<br>K: 1<br>S: 5 | H: 0<br>LOB: 1<br>BB: 0<br>P: 6 | R: 0<br>E: 0<br>K: 1<br>S: 5 | H: 0<br>LOB: 0<br>BB: 0<br>P: 5 | R: 0<br>E: 0<br>K: 1<br>S: 5 | H: 0<br>LOB: 0<br>BB: 0<br>P: 5 | 1B: 3<br>2B: 2<br>3B: 0<br>HR: 1 | SF: 1<br>SAC: 0<br>DP: 0<br>HBP: 1 | WP: 0<br>PB: 0<br>SB: 0<br>CS: 1 | PA: 35 |
| <b>PITCHER</b>                                     | IP WLS BF H R ER SO BB IBB HBP BLK WP HR S P ERA WHIP |                                 |                              |                                  |                              |                                 |                              |                                 |                              |                                 |   |                                 |                              |                                 |                              |                                 |                              |                                 |                                  |                                    |                                  |        |
| Earl Wilson, R (1, 1)<br>ERA: 5.81                 | 7.0 L 27 6 4 4 5 1 0 0 0 0 0 1 36 40 5.14 1.000       |                                 |                              |                                  |                              |                                 |                              |                                 |                              |                                 |   |                                 |                              |                                 |                              |                                 |                              |                                 |                                  |                                    |                                  |        |
| Dick Radatz, R (8, 1)<br>ERA: 1.24                 | 2.0 7 0 0 0 2 0 0 1 0 0 0 0 10 11 0.00 0.000          |                                 |                              |                                  |                              |                                 |                              |                                 |                              |                                 |   |                                 |                              |                                 |                              |                                 |                              |                                 |                                  |                                    |                                  |        |

**Kansas City Athletics @ Boston Red Sox**  
 Fenway Park, Boston, MA  
 Fri May 22 1964, 7:05 PM EDT  
 Att. 13,728 - Unknown

**AB 31**  
**R 4**  
**H 6**  
**RBI 4**  
**BB 1**  
**SO 7**  
**LOB 5**



| Batter   | 1            | 2                  | 3            | 4               | 5        | 6                       | 7         | 8                             | 9         | AB | R | H | RBI | BB | SO | LOB |
|--|--------------|--------------------|--------------|-----------------|----------|-------------------------|-----------|-------------------------------|-----------|----|---|---|-----|----|----|-----|
| Dalton Jones, L (1, 4)<br>OBP: 0.355, SLG: 0.522     | 0-0<br>1-3   |                    | 0-0<br>FC4-6 |                 | 0-3<br>K |                         | 0-0<br>L7 |                               | 0-0<br>F6 | 5  | 0 | 0 | 0   | 0  | 1  | 1   |
| Eddie Bressoud, R (1, 6)<br>OBP: 0.404, SLG: 0.504   | 0-0<br>F6    |                    | 0-0<br>6-3   |                 | 0-3<br>K |                         | 0-0<br>2B |                               |           | 4  | 0 | 1 | 0   | 0  | 1  | 1   |
| Carl Yastrzemski, L (1, 8)<br>OBP: 0.346, SLG: 0.443 | 0-0<br>1-4-3 |                    |              | 0-0<br>L7       |          | 0-0<br>F7               |           | 0-0<br>6-3                    |           | 4  | 0 | 0 | 0   | 0  | 0  | 1   |
| Frank Malzone, R (1, 5)<br>OBP: 0.346, SLG: 0.426    |              | 0-0<br>F9          |              | 0-3<br>K        |          | 0-0<br>1B<br>2B         |           | 0-0<br>FC3-6<br>1B            |           | 4  | 1 | 2 | 0   | 0  | 1  | 0   |
| Dick Stuart, R (1, 3)<br>OBP: 0.275, SLG: 0.328      |              | 0-0<br>F3          |              | 0-0<br>1B       |          | 0-0<br>F6               |           | 0-0<br>FC3-6<br>FC5-4<br>1-2f |           | 4  | 0 | 1 | 0   | 0  | 0  | 2   |
| Tony Conigliaro, R (1, 7)<br>OBP: 0.331, SLG: 0.517  |              | 0-0<br>1B          |              | 0-0<br>F9       |          | 4-0<br>1B<br>BB         |           | 0-0<br>FC5-4<br>1-2f          |           | 3  | 0 | 1 | 0   | 1  | 0  | 2   |
| Bob Tillman, R (1, 2)<br>OBP: 0.345, SLG: 0.373      |              | 0-0<br>6-3         |              | 0-3<br>K        |          | 0-0<br>1-3<br>2-H<br>1B |           | 0-3<br>K                      |           | 4  | 0 | 1 | 1   | 0  | 2  | 2   |
| Roman Mejias, R (1, 9)<br>OBP: 0.306, SLG: 0.394     |              | 0-0<br>F9          |              | 0-0<br>HR<br>1B |          | 0-3<br>K                |           | 0-0<br>5-3                    |           | 4  | 1 | 1 | 0   | 0  | 1  | 2   |
| Earl Wilson, R (1, 1)<br>OBP: 0.556, SLG: 0.857      |              | 0-0<br>FC4-6<br>1B |              | 0-0<br>HR       |          | 0-3<br>K                |           | 0-0<br>4-3                    |           | 2  | 1 | 2 | 2   | 0  | 0  | 0   |
| Felix Mantilla, R (7, PH)<br>OBP: 0.167, SLG: 0.276  |              |                    |              |                 |          |                         |           |                               |           | 1  | 0 | 0 | 0   | 0  | 1  | 0   |
| Dick Radatz, R (8, 1)<br>OBP: 0.375, SLG: 0.375      |              |                    |              |                 |          |                         |           |                               |           | 0  | 0 | 0 | 0   | 0  | 0  | 0   |
| Russ Nixon, L (9, PH)<br>OBP: 0.429, SLG: 0.524      |              |                    |              |                 |          |                         |           |                               |           | 1  | 0 | 0 | 0   | 0  | 0  | 0   |

| Inning Stats | R: 0 | H: 0 | E: 0 | K: 0 | S: 3 | P: 3 | R: 0 | H: 1 | E: 0 | K: 0 | S: 4 | R: 0 | H: 1 | E: 0 | K: 0 | S: 4 | R: 0 | H: 1 | E: 0 | K: 1 | S: 6 | R: 2 | H: 2 | E: 0 | K: 3 | S: 11 | R: 1 | H: 2 | E: 0 | K: 1 | S: 7 | R: 0 | H: 1 | E: 0 | K: 1 | S: 6 | R: 0 | H: 1 | E: 0 | K: 1 | S: 6 | R: 0 | H: 0 | E: 0 | K: 0 | S: 3 | 1B: 6 | SF: 0 | 2B: 2 | SAC: 0 | 3B: 0 | DP: 0 | HR: 1 | HBP: 0 | WP: 0 | PA: 37 |
|--------------|------|------|------|------|------|------|------|------|------|------|------|------|------|------|------|------|------|------|------|------|------|------|------|------|------|-------|------|------|------|------|------|------|------|------|------|------|------|------|------|------|------|------|------|------|------|------|-------|-------|-------|--------|-------|-------|-------|--------|-------|--------|
|--------------|------|------|------|------|------|------|------|------|------|------|------|------|------|------|------|------|------|------|------|------|------|------|------|------|------|-------|------|------|------|------|------|------|------|------|------|------|------|------|------|------|------|------|------|------|------|------|-------|-------|-------|--------|-------|-------|-------|--------|-------|--------|

| PITCHER                             | IP  | WLS | BF | H | R | ER | SO | BB | IBB | HBP | BLK | WP | HR | S  | P  | ERA  | WHIP  |
|-------------------------------------|-----|-----|----|---|---|----|----|----|-----|-----|-----|----|----|----|----|------|-------|
| Orlando Pena, R (1, 1)<br>ERA: 3.98 | 6.2 | W   | 29 | 8 | 3 | 3  | 6  | 1  | 0   | 0   | 0   | 0  | 1  | 40 | 44 | 4.05 | 1.350 |
| John Wyatt, R (7, 1)<br>ERA: 1.11   | 2.1 | S   | 8  | 1 | 0 | 0  | 1  | 0  | 0   | 0   | 0   | 0  | 0  | 10 | 10 | 0.00 | 0.429 |

**BOTTOM**

**Kansas City Athletics @ Boston Red Sox**  
 Fenway Park, Boston, MA  
 Fri May 22 1964, 7:05 PM EDT  
 Att. 13,728 - Unknown

[livebaseballscorecards.com](http://livebaseballscorecards.com)

|            |           |
|------------|-----------|
| <b>AB</b>  | <b>36</b> |
| <b>R</b>   | <b>3</b>  |
| <b>H</b>   | <b>9</b>  |
| <b>RBI</b> | <b>3</b>  |
| <b>BB</b>  | <b>1</b>  |
| <b>SO</b>  | <b>7</b>  |
| <b>LOB</b> | <b>11</b> |



| Batter   | 1   | 2   | 3   | 4   | 5  | 6   | 7   | 8   | 9   | AB R H RBI BB SO LOB   | TOP  |  |
|--|---|---|---|---|--|---|---|---|---|--|--|--|
| Wayne Causey, L (1, 6)<br>OBP: 0.373, SLG: 0.321   | 0-3<br>K  |   | 0-0<br>2B   |   | 0-0<br>E4<br>SF9<br>1B   |   | 0-0<br>L7   |   | 0-3<br>K  | 5 1 1 0 0 2 2  | <b>Kansas City Athletics @ Boston Red Sox</b><br>Fenway Park, Boston, MA<br>Sat May 23 1964, 3:33 AM EDT<br>Att. 6,119 - Unknown<br><a href="http://livebaseballscorecards.com">livebaseballscorecards.com</a> |  |
| Nelson Mathews, R (1, 8)<br>OBP: 0.355, SLG: 0.420<br>Manny Jimenez, L (9, PH)<br>OBP: 0.270, SLG: 0.509<br>Jose Tartabull, L (9, 8)<br>OBP: 0.200, SLG: 0.300 | 0-3<br>K  |   | 0-3<br>K  |   | 0-0<br>E6<br>SF9<br>1B   |   | 0-3<br>K  |   | 0-0<br>F6   | 4 0 1 0 0 3 1<br>1 0 0 0 0 0 2<br>0 0 0 0 0 0 0                        |  |  |
| Ed Charles, R (1, 5)<br>OBP: 0.384, SLG: 0.369   | 0-0<br>F4   |   | 0-0<br>L6   |   | 0-3<br>K   |   | 0-0<br>L7   |   | 0-0<br>1B   | 5 0 1 1 0 1 3  |  |  |
| Rocky Colavito, R (1, 9)<br>OBP: 0.406, SLG: 0.673   |   | 0-0<br>6-3  |   | 0-0<br>F8   |  | 4-0<br>IBB  |   | 0-0<br>F5   | 0-0<br>F8   | 4 0 0 0 1 0 2  |  |  |
| Jim Gentile, L (1, 3)<br>OBP: 0.373, SLG: 0.508  |   | 0-0<br>HR   |   | 0-0<br>HR   |  | 0-0<br>SF9  |   | 0-0<br>1B   |   | 3 2 3 3 0 0 0  |  |  |
| George Alusik, R (1, 7)<br>OBP: 0.511, SLG: 0.576  |   | 0-0<br>2B   |   | 0-0<br>1B   |  | 0-3<br>K  |   | 0-0<br>F7   |   | 4 0 2 0 0 1 3  |  |  |
| Charlie Lau, L (1, 2)<br>OBP: 0.384, SLG: 0.519  |   | 0-0<br>L7   |   | 0-0<br>1B   |  | 0-0<br>6-3  |   | 0-0<br>F8   |   | 4 0 1 0 0 0 2  |  |  |
| Dick Green, R (1, 4)<br>OBP: 0.242, SLG: 0.347   |   | 0-0<br>F9   |   | 0-3<br>K  |  | 0-0<br>5-3  |   | 0-0<br>SH<br>1B<br>2B   |   | 4 1 1 0 0 1 3  |  |  |
| Aurelio Monteagudo, R (1, 1)<br>OBP: 0.286, SLG: 0.571<br>Jack Aker, R (5, 1)<br>John Wyatt, R (8, 1)  |   | 0-3<br>K  |   | 0-3<br>K  |  | 0-3<br>K  |   | 0-0<br>SH<br>1B   |   | 2 0 0 0 0 2 2<br>1 0 0 0 0 1 0<br>0 0 0 0 0 0 0                        |  |  |
| <b>Inning Stats</b>  | R: 0<br>E: 0<br>K: 2<br>S: 7<br>H: 0<br>LOB: 0<br>BB: 0<br>P: 7 | R: 1<br>E: 0<br>K: 0<br>S: 5<br>H: 2<br>LOB: 1<br>BB: 0<br>P: 5 | R: 0<br>E: 0<br>K: 2<br>S: 8<br>H: 1<br>LOB: 1<br>BB: 0<br>P: 8 | R: 1<br>E: 0<br>K: 2<br>S: 10<br>H: 3<br>LOB: 2<br>BB: 0<br>P: 10 | R: 1<br>E: 2<br>K: 2<br>S: 9<br>H: 1<br>LOB: 2<br>BB: 1<br>P: 13 | R: 0<br>E: 0<br>K: 1<br>S: 5<br>H: 0<br>LOB: 0<br>BB: 0<br>P: 5 | R: 0<br>E: 0<br>K: 1<br>S: 5<br>H: 0<br>LOB: 0<br>BB: 0<br>P: 5 | R: 0<br>E: 0<br>K: 0<br>S: 4<br>H: 1<br>LOB: 1<br>BB: 0<br>P: 4 | R: 1<br>E: 0<br>K: 1<br>S: 8<br>H: 2<br>LOB: 2<br>BB: 0<br>P: 8 | 1B: 5<br>2B: 3<br>3B: 0<br>HR: 2<br>SF: 1<br>SAC: 1<br>DP: 0<br>HBP: 0 |  | WP: 0<br>PB: 0<br>SB: 0<br>CS: 0<br>PA: 40 |
| <b>PITCHER</b><br>Bill Monbouquette, R (1, 1)<br>ERA: 3.99<br>Dick Radatz, R (9, 1)<br>ERA: 1.45   | IP WLS BF H R ER SO BB IBB HBP BLK WP HR S P ERA WHIP           |   |   |   |  |   |   |   |   |  |  |  |
|  | 8.0 34 8 3 2 10 0 1 0 0 0 2 53 57 2.25 1.000                    |   |   |   |  |   |   |   |   |  |  |  |
|  | 1.0 W 6 2 1 1 1 0 0 0 0 0 0 8 8 9.00 2.000                      |   |   |   |  |   |   |   |   |  |  |  |

**Kansas City Athletics @ Boston Red Sox**  
 Fenway Park, Boston, MA  
 Sat May 23 1964, 3:33 AM EDT  
 Att. 6,119 - Unknown

|     |    |
|-----|----|
| AB  | 37 |
| R   | 4  |
| H   | 10 |
| RBI | 4  |
| BB  | 1  |
| SO  | 11 |
| LOB | 20 |



| Batter  | 1      | 2       | 3             | 4            | 5       | 6       | 7              | 8                   | 9            | AB | R | H | RBI | BB | SO | LOB |
|---|--------|---------|---------------|--------------|---------|---------|----------------|---------------------|--------------|----|---|---|-----|----|----|-----|
| Dalton Jones, L (1, 4)<br>OBP: 0.350, SLG: 0.507      | 0-0 F9 |         | 0-0 L8        |              | 0-0 4-3 |         |                | 0-0 HBP FC3-5 BB 1B |              | 4  | 1 | 1 | 0   | 0  | 0  | 1   |
| Eddie Bressoud, R (1, 6)<br>OBP: 0.393, SLG: 0.489    | 0-3 K  |         |               | 0-3 K        | 0-0 F9  |         |                | 0-0 FC3-5 BB HBP    |              | 4  | 0 | 0 | 0   | 0  | 2  | 2   |
| Tony Conigliaro, R (1, 7)<br>OBP: 0.336, SLG: 0.512   | 0-3 K  |         |               | 0-0 BB 1B    |         | 0-0 6-3 |                | 1-0 BB HBP          |              | 3  | 0 | 1 | 0   | 0  | 1  | 0   |
| Frank Malzone, R (1, 5)<br>OBP: 0.336, SLG: 0.413     |        | 0-0 F5  |               | 0-3 K        |         | 0-0 6-3 |                | 0-0 F6              |              | 4  | 0 | 0 | 0   | 0  | 1  | 4   |
| Carl Yastrzemski, L (1, 8)<br>OBP: 0.350, SLG: 0.436  |        | 0-0 4-3 |               | 4-0 FC6-4 BB |         | 0-0 4-3 |                | 4-0 BB              |              | 2  | 0 | 0 | 1   | 2  | 0  | 0   |
| Dick Stuart, R (1, 3)<br>OBP: 0.275, SLG: 0.320       |        | 0-0 F6  |               | 0-0 FC6-4    |         |         | 1-0 HBP        | 0-0 F5              |              | 3  | 0 | 0 | 0   | 0  | 0  | 5   |
| Bob Tillman, R (1, 2)<br>OBP: 0.359, SLG: 0.410       |        |         | 0-0 G5-4-3 1B |              | 0-0 HR  |         | 0-0 G6-4-3 HBP |                     | 4-0 FC3-6 BB | 3  | 1 | 2 | 1   | 1  | 0  | 1   |
| Roman Mejias, R (1, 9)<br>OBP: 0.300, SLG: 0.459      |        |         | 0-0 G5-4-3    |              | 0-0 HR  |         | 0-3 K          |                     | 0-0 FC3-6 HR | 4  | 2 | 1 | 1   | 0  | 1  | 2   |
| Bill Monbouquette, R (1, 1)<br>OBP: 0.294, SLG: 0.143 |        |         | 0-0           |              | 0-0 1-3 |         |                | 0-0 FC3-5 1B        | 0-0 HR       | 2  | 0 | 1 | 0   | 0  | 0  | 0   |
| Russ Nixon, L (8, PH)<br>OBP: 0.453, SLG: 0.545       |        |         |               |              |         |         |                |                     |              | 1  | 0 | 1 | 0   | 0  | 0  | 0   |
| Earl Wilson, R (8, PR)<br>OBP: 0.556, SLG: 0.857      |        |         |               |              |         |         |                |                     |              | 0  | 0 | 0 | 0   | 0  | 0  | 0   |
| Dick Radatz, R (9, 1)<br>OBP: 0.375, SLG: 0.375       |        |         |               |              |         |         |                |                     |              | 0  | 0 | 0 | 0   | 0  | 0  | 0   |
| Felix Mantilla, R (9, PH)<br>OBP: 0.194, SLG: 0.400   |        |         |               |              |         |         |                |                     |              | 1  | 1 | 1 | 2   | 0  | 0  | 0   |

| Inning Stats | R: 0 | H: 0 | E: 0 | K: 2 | S: 7 | R: 0 | H: 0 | E: 0 | K: 0 | S: 3 | R: 0 | H: 2 | E: 0 | K: 0 | S: 4 | R: 0 | H: 1 | E: 0 | K: 2 | S: 8 | R: 2 | H: 2 | E: 0 | K: 0 | S: 5 | R: 0 | H: 0 | E: 0 | K: 1 | S: 4 | R: 1 | H: 2 | E: 0 | K: 0 | S: 5 | R: 2 | H: 1 | E: 0 | K: 0 | S: 2 | 1B: 5 | 2B: 0 | 3B: 0 | HR: 3 | SF: 0 | SAC: 0 | DP: 2 | HBP: 2 | WP: 0 | PB: 0 | SB: 0 | CS: 0 | PA: 36 |
|--------------|------|------|------|------|------|------|------|------|------|------|------|------|------|------|------|------|------|------|------|------|------|------|------|------|------|------|------|------|------|------|------|------|------|------|------|------|------|------|------|------|-------|-------|-------|-------|-------|--------|-------|--------|-------|-------|-------|-------|--------|
|--------------|------|------|------|------|------|------|------|------|------|------|------|------|------|------|------|------|------|------|------|------|------|------|------|------|------|------|------|------|------|------|------|------|------|------|------|------|------|------|------|------|-------|-------|-------|-------|-------|--------|-------|--------|-------|-------|-------|-------|--------|

| PITCHER                                   | IP  | WLS | BF | H | R | ER | SO | BB | IBB | HBP | BLK | WP | HR | S  | P  | ERA   | WHIP  |
|---|-----|-----|----|---|---|----|----|----|-----|-----|-----|----|----|----|----|-------|-------|
| Aurelio Monteagudo, R (1, 1)<br>ERA: 7.76 | 4.0 |     | 17 | 5 | 2 | 2  | 4  | 1  | 0   | 0   | 0   | 0  | 2  | 24 | 28 | 4.50  | 1.500 |
| Jack Aker, R (5, 1)<br>ERA: 8.4           | 3.1 |     | 13 | 2 | 1 | 1  | 1  | 0  | 0   | 2   | 0   | 0  | 0  | 13 | 15 | 2.70  | 0.600 |
| John Wyatt, R (8, 1)<br>ERA: 1.78         | 1.0 | L   | 6  | 1 | 2 | 2  | 0  | 2  | 0   | 0   | 0   | 0  | 1  | 4  | 12 | 18.00 | 3.000 |

BOTTOM

Kansas City Athletics @ Boston Red Sox  
 Fenway Park, Boston, MA  
 Sat May 23 1964, 3:33 AM EDT  
 Att: 6,119 - Unknown

livebaseballscorecards.com

|     |    |
|-----|----|
| AB  | 31 |
| R   | 5  |
| H   | 8  |
| RBI | 5  |
| BB  | 3  |
| SO  | 5  |
| LOB | 15 |



| Batter  | 1  | 2   | 3                            | 4                                | 5                            | 6                               | 7                            | 8                               | 9                            | AB R H RBI BB SO LOB            | TOP   |                                 |   |                                 |                              |                                 |                              |                                 |                                  |                                    |                                  |        |
|---|--|---|------------------------------|----------------------------------|------------------------------|---------------------------------|------------------------------|---------------------------------|------------------------------|---------------------------------|---|---------------------------------|---|---------------------------------|------------------------------|---------------------------------|------------------------------|---------------------------------|----------------------------------|------------------------------------|----------------------------------|--------|
| Wayne Causey, L (1, 6)<br>OBP: 0.370, SLG: 0.326  | 0-0<br>BB<br>BB<br>2B  | 0-3<br>K  |                              |                                  | 0-0<br>4-3                   |                                 | 0-0<br>L8                    |                                 |                              | 4 1 1 0 0 1 1                   | <b>Kansas City Athletics @ Boston Red Sox</b><br>Fenway Park, Boston, MA<br>Sun May 24 1964, 3:33 AM EDT<br>Unknown |                                 |   |                                 |                              |                                 |                              |                                 |                                  |                                    |                                  |        |
| Nelson Mathews, R (1, 8)<br>OBP: 0.346, SLG: 0.408  | 0-3<br>K   | 0-3<br>K  |                              |                                  | 0-0<br>6-3                   |                                 | 0-3<br>K                     |                                 |                              | 4 0 0 0 0 3 2                   |   |                                 |   |                                 |                              |                                 |                              |                                 |                                  |                                    |                                  |        |
| Ed Charles, R (1, 5)<br>OBP: 0.387, SLG: 0.368  | 4-0<br>BB<br>BB<br>BB  |   |                              | 0-0<br>BB<br>1B                  | 0-0<br>6-3                   |                                 |                              | 0-3<br>K                        |                              | 3 0 1 0 1 1 0                   |   |                                 |   |                                 |                              |                                 |                              |                                 |                                  |                                    |                                  |        |
| Rocky Colavito, R (1, 9)<br>OBP: 0.402, SLG: 0.658  | 0-0<br>F4  |   |                              | 0-0<br>F7                        |                              | 0-0<br>1B                       |                              | 0-0<br>F5                       |                              | 4 0 1 0 0 0 3                   |   |                                 |   |                                 |                              |                                 |                              |                                 |                                  |                                    |                                  |        |
| Jim Gentile, L (1, 3)<br>OBP: 0.390, SLG: 0.538   | 4-0<br>BB<br>BB<br>BB  |   |                              | 4-0<br>G5-4-3<br>BB              |                              | 0-0<br>HR                       |                              | 4-0<br>FC6-4<br>BB              |                              | 1 1 1 1 3 0 0                   |   |                                 |   |                                 |                              |                                 |                              |                                 |                                  |                                    |                                  |        |
| George Alusik, R (1, 7)<br>OBP: 0.510, SLG: 0.556   | 4-0<br>BB  |   |                              | 0-0<br>G5-4-3                    |                              | 0-0<br>1B                       |                              | 0-0<br>FC6-4                    |                              | 3 0 1 1 1 0 3                   |   |                                 |   |                                 |                              |                                 |                              |                                 |                                  |                                    |                                  |        |
| Charlie Lau, L (1, 2)<br>OBP: 0.367, SLG: 0.494   | 0-3<br>K   |   |                              | 0-0<br>4-3                       |                              | 0-0<br>F5                       |                              | 0-0<br>4-3                      |                              | 4 0 0 0 0 1 4                   |   |                                 |   |                                 |                              |                                 |                              |                                 |                                  |                                    |                                  |        |
| Dick Green, R (1, 4)<br>OBP: 0.242, SLG: 0.339  |  | 4-0<br>BB   |                              | 0-0<br>L7                        |                              | 0-0<br>5-3                      |                              | 0-0<br>6-3                      |                              | 3 0 0 0 1 0 1                   |   |                                 |   |                                 |                              |                                 |                              |                                 |                                  |                                    |                                  |        |
| Moe Drabowsky, R (1, 1)<br>OBP: 0.059, SLG: 0.059<br>Manny Jimenez, L (9, PH)<br>OBP: 0.266, SLG: 0.500 |  | 0-0<br>F4   |                              | 0-3<br>K                         |                              | 0-3<br>K                        |                              | 0-3<br>K                        |                              | 3 0 0 0 0 2 1<br>1 0 0 0 0 1 0  |   |                                 |   |                                 |                              |                                 |                              |                                 |                                  |                                    |                                  |        |
| <b>Inning Stats</b>   | R: 1<br>E: 0<br>K: 2<br>S: 8   | H: 1<br>LOB: 3<br>BB: 3<br>P: 20  | R: 0<br>E: 0<br>K: 2<br>S: 7 | H: 0<br>LOB: 1<br>BB: 1<br>P: 11 | R: 0<br>E: 0<br>K: 0<br>S: 3 | H: 1<br>LOB: 1<br>BB: 1<br>P: 7 | R: 0<br>E: 0<br>K: 1<br>S: 5 | H: 0<br>LOB: 0<br>BB: 0<br>P: 5 | R: 0<br>E: 0<br>K: 0<br>S: 3 | H: 0<br>LOB: 0<br>BB: 0<br>P: 3 | R: 1<br>E: 0<br>K: 0<br>S: 5  | H: 3<br>LOB: 1<br>BB: 0<br>P: 5 | R: 0<br>E: 0<br>K: 2<br>S: 7  | H: 0<br>LOB: 0<br>BB: 0<br>P: 7 | R: 0<br>E: 0<br>K: 1<br>S: 5 | H: 0<br>LOB: 1<br>BB: 1<br>P: 9 | R: 0<br>E: 0<br>K: 1<br>S: 5 | H: 0<br>LOB: 0<br>BB: 0<br>P: 5 | 1B: 3<br>2B: 1<br>3B: 0<br>HR: 1 | SF: 0<br>SAC: 0<br>DP: 1<br>HBP: 0 | WP: 0<br>PB: 0<br>SB: 0<br>CS: 0 | PA: 36 |
| <b>PITCHER</b><br>Jack Lamabe, R (1, 1)<br>ERA: 3.68<br>Bob Hefner, R (9, 1)<br>ERA: 2.28               | IP: 8.0<br>WLS: W<br>BF: 33<br>H: 5<br>R: 2<br>ER: 2<br>SO: 8<br>BB: 6<br>IBB: 0<br>HBP: 0<br>BLK: 0<br>WP: 0<br>HR: 1<br>S: 43<br>P: 67<br>ERA: 2.25<br>WHIP: 1.375 | IP: 1.0<br>WLS: S<br>BF: 3<br>H: 0<br>R: 0<br>ER: 0<br>SO: 1<br>BB: 0<br>IBB: 0<br>HBP: 0<br>BLK: 0<br>WP: 0<br>HR: 0<br>S: 5<br>P: 5<br>ERA: 0.00<br>WHIP: 0.000 |                              |                                  |                              |                                 |                              |                                 |                              |                                 |   |                                 | <b>PITCHER</b><br>IP: 1.0<br>WLS: S<br>BF: 3<br>H: 0<br>R: 0<br>ER: 0<br>SO: 1<br>BB: 0<br>IBB: 0<br>HBP: 0<br>BLK: 0<br>WP: 0<br>HR: 0<br>S: 5<br>P: 5<br>ERA: 0.00<br>WHIP: 0.000 |                                 |                              |                                 |                              |                                 |                                  |                                    |                                  |        |

livebaseballscorecards.com

|     |    |
|-----|----|
| AB  | 30 |
| R   | 2  |
| H   | 5  |
| RBI | 2  |
| BB  | 6  |
| SO  | 9  |
| LOB | 15 |



| Batter  | 1         | 2          | 3               | 4                 | 5          | 6                     | 7          | 8                                 | 9 |
|---|-----------|------------|-----------------|-------------------|------------|-----------------------|------------|-----------------------------------|---|
| <b>Dalton Jones, L</b> (1, 4)<br>OBP: 0.357, SLG: 0.513   | 0-0<br>L9 |            | 4-0<br>BB       |                   |            | 0-0<br>F9             |            | 0-0<br>1B 2B                      |   |
| <b>Eddie Bressoud, R</b> (1, 6)<br>OBP: 0.396, SLG: 0.489   | 0-0<br>L7 |            | 0-0<br>1-3      |                   |            | 0-0<br>G6-4-3<br>1B   |            | 0-0<br>FC6-4<br>HBP<br>2-H<br>1B  |   |
| <b>Tony Conigliaro, R</b> (1, 7)<br>OBP: 0.341, SLG: 0.508<br><b>Earl Wilson, R</b> (8, PR)<br>OBP: 0.556, SLG: 0.857<br><b>Lou Clinton, R</b> (9, 9)<br>OBP: 0.271, SLG: 0.329 | 0-3<br>K  |            |                 | 0-0<br>4-3<br>1B  |            | 0-0<br>G6-4-3<br>1-2f |            | 1-0<br>FC6-4<br>HBP<br>1-2        |   |
| <b>Frank Malzone, R</b> (1, 5)<br>OBP: 0.326, SLG: 0.400  |           | 0-0<br>1-3 |                 | 0-0<br>4-3<br>1-2 |            |                       | 0-0<br>6-3 | 0-0<br>FC6-4<br>HR<br>1-2f<br>2-3 |   |
| <b>Carl Yastrzemski, L</b> (1, 8)<br>OBP: 0.355, SLG: 0.458   |           | 0-0<br>4-3 |                 | 0-0<br>F7         |            |                       | 0-0<br>HR  | 4-0<br>HR<br>IBB                  |   |
| <b>Dick Stuart, R</b> (1, 3)<br>OBP: 0.274, SLG: 0.341<br><b>Dick Williams, R</b> (9, 3)<br>OBP: 0.143, SLG: 0.077  |           | 0-0<br>6-3 |                 | 0-0<br>6-3        |            |                       | 0-0<br>6-3 | 0-0<br>HR<br>1-H<br>2-H<br>3-H    |   |
| <b>Bob Tillman, R</b> (1, 2)<br>OBP: 0.364, SLG: 0.417  |           |            | 0-0<br>F9       |                   | 0-0<br>F7  |                       | 0-0<br>2B  | 4-0<br>BB<br>BB<br>BB<br>BB       |   |
| <b>Roman Mejias, R</b> (1, 9)<br>OBP: 0.273, SLG: 0.415<br>(9, 7)   |           |            | 0-0<br>F1       |                   | 0-0<br>6-3 |                       | 0-0<br>F8  | 0-0<br>F6                         |   |
| <b>Jack Lamabe, R</b> (1, 1)<br>OBP: 0.182, SLG: 0.238<br><b>Russ Nixon, L</b> (8, PH)<br>OBP: 0.435, SLG: 0.522<br><b>Bob Heffner, R</b> (9, 1)<br>OBP: 0.333, SLG: 0.833      |           |            | 4-0<br>BB<br>BB |                   | 0-3<br>K   |                       |            | 0-3<br>K                          |   |

| Inning Stats | R: 0   | H: 0  | E: 0 | K: 1   | S: 5  | R: 0   | H: 0  | E: 0   | K: 0  | S: 3 | R: 0   | H: 1  | E: 0   | K: 0  | S: 4 | R: 0   | H: 0  | E: 0   | K: 1  | S: 5 | R: 0   | H: 1  | E: 0   | K: 0  | S: 3  | R: 1   | H: 2  | E: 0 | K: 0   | S: 5  | R: 5  | H: 3  | E: 0   | K: 1  | S: 8   |
|--------------|--------|-------|------|--------|-------|--------|-------|--------|-------|------|--------|-------|--------|-------|------|--------|-------|--------|-------|------|--------|-------|--------|-------|-------|--------|-------|------|--------|-------|-------|-------|--------|-------|--------|
|              | LOB: 0 | BB: 0 | P: 5 | LOB: 0 | BB: 0 | LOB: 1 | BB: 0 | LOB: 0 | BB: 0 | P: 5 | LOB: 0 | BB: 0 | LOB: 0 | BB: 0 | P: 5 | LOB: 1 | BB: 1 | LOB: 1 | BB: 0 | P: 3 | LOB: 1 | BB: 0 | LOB: 1 | BB: 2 | P: 17 | LOB: 1 | BB: 2 | P: 5 | LOB: 1 | BB: 2 | P: 17 | SF: 0 | SAC: 0 | DP: 1 | HBP: 1 |

| PITCHER                                     | IP  | WLS | BF | H | R | ER | SO | BB | IBB | HBP | BLK | WP | HR | S  | P  | ERA  | WHIP  | PITCHER | IP | WLS | BF | H | R | ER | SO | BB | IBB | HBP | BLK | WP | HR | S | P | ERA | WHIP |  |  |
|---|-----|-----|----|---|---|----|----|----|-----|-----|-----|----|----|----|----|------|-------|---------|----|-----|----|---|---|----|----|----|-----|-----|-----|----|----|---|---|-----|------|--|--|
| <b>Moe Drabowsky, R</b> (1, 1)<br>ERA: 5.89 | 8.0 | L   | 35 | 7 | 6 | 6  | 3  | 3  | 1   | 1   | 0   | 0  | 2  | 36 | 53 | 6.75 | 1.250 |         |    |     |    |   |   |    |    |    |     |     |     |    |    |   |   |     |      |  |  |

**BOTTOM**

**Kansas City Athletics @ Boston Red Sox**  
Fenway Park, Boston, MA  
Sun May 24 1964, 3:33 AM EDT  
Unknown

|     |    |
|-----|----|
| AB  | 30 |
| R   | 6  |
| H   | 7  |
| RBI | 6  |
| BB  | 4  |
| SO  | 3  |
| LOB | 10 |



|       |        |       |        |
|-------|--------|-------|--------|
| 1B: 3 | SF: 0  | WP: 0 | PA: 35 |
| 2B: 2 | SAC: 0 | PB: 0 |        |
| 3B: 0 | DP: 1  | SB: 0 |        |
| HR: 2 | HBP: 1 | CS: 0 |        |

| Batter  | 1   | 2                                | 3                            | 4                               | 5                            | 6                               | 7                            | 8                               | 9                            | AB R H RBI BB SO LOB             | TOP                          |                                 |                              |                                 |                              |                                  |                              |                                 |                                  |                                    |                                  |        |
|---|---|----------------------------------|------------------------------|---------------------------------|------------------------------|---------------------------------|------------------------------|---------------------------------|------------------------------|----------------------------------|------------------------------|---------------------------------|------------------------------|---------------------------------|------------------------------|----------------------------------|------------------------------|---------------------------------|----------------------------------|------------------------------------|----------------------------------|--------|
| Wayne Causey, L (1, 6)<br>OBP: 0.382, SLG: 0.343    | 4-0<br>WP<br>2B<br>BB                                 |                                  | 4-0<br>G5-4-3<br>BB          |                                 | 4-0<br>BB<br>BB              |                                 | 0-0<br>FC5-2<br>3B           |                                 | 0-3<br>K                     | 2 1 1 0 3 1 0                    |                              |                                 |                              |                                 |                              |                                  |                              |                                 |                                  |                                    |                                  |        |
| Nelson Mathews, R (1, 8)<br>OBP: 0.348, SLG: 0.411  | 0-0<br>1-H<br>2B                                      |                                  | 0-0<br>G5-4-3<br>1-2f        |                                 | 4-0<br>FC6-4<br>BB           |                                 | 0-0<br>FC5-2<br>FC6-4        |                                 | 0-3<br>K                     | 4 0 1 1 1 1 2                    |                              |                                 |                              |                                 |                              |                                  |                              |                                 |                                  |                                    |                                  |        |
| Ed Charles, R (1, 5)<br>OBP: 0.377, SLG: 0.357      | 0-3<br>K  |                                  | 0-0<br>F8                    |                                 | 0-0<br>FC6-4<br>1-2f         |                                 | 0-0<br>FC6-4<br>1-2f         |                                 |                              | 4 0 0 0 0 1 5                    |                              |                                 |                              |                                 |                              |                                  |                              |                                 |                                  |                                    |                                  |        |
| Rocky Colavito, R (1, 9)<br>OBP: 0.404, SLG: 0.646  | 0-0<br>F9   |                                  |                              | 4-0<br>G5-4-3<br>BB             |                              | 0-0<br>6-3                      |                              | 4-0<br>1B<br>BB                 |                              | 2 0 0 0 2 0 1                    |                              |                                 |                              |                                 |                              |                                  |                              |                                 |                                  |                                    |                                  |        |
| George Alusik, R (1, 3)<br>OBP: 0.528, SLG: 0.553   | 4-0<br>BB   |                                  |                              | 0-0<br>L5                       |                              | 4-0<br>2B<br>BB                 |                              | 0-0<br>1-2<br>1B                |                              | 2 0 1 0 2 0 1                    |                              |                                 |                              |                                 |                              |                                  |                              |                                 |                                  |                                    |                                  |        |
| Doc Edwards, R (1, 2)<br>OBP: 0.260, SLG: 0.271     | 0-3<br>K  |                                  |                              | 0-0<br>G5-4-3<br>1-2f           |                              | 0-0<br>F9                       |                              | 0-0<br>F2                       |                              | 2 0 0 0 0 1 3                    |                              |                                 |                              |                                 |                              |                                  |                              |                                 |                                  |                                    |                                  |        |
| Charlie Lau, L (6, PH)<br>OBP: 0.359, SLG: 0.482    |   |                                  |                              |                                 |                              |                                 |                              |                                 |                              | 2 0 0 0 0 0 3                    |                              |                                 |                              |                                 |                              |                                  |                              |                                 |                                  |                                    |                                  |        |
| Manny Jimenez, L (1, 7)<br>OBP: 0.265, SLG: 0.500   |   | 0-0<br>3-1                       |                              |                                 | 0-0<br>L4                    |                                 | 0-0<br>1-3<br>2B             |                                 | 0-3<br>K                     | 4 0 1 0 0 1 2                    |                              |                                 |                              |                                 |                              |                                  |                              |                                 |                                  |                                    |                                  |        |
| Dick Green, R (1, 4)<br>OBP: 0.244, SLG: 0.339      |   | 0-3<br>K                         |                              |                                 | 0-0<br>BB<br>BB<br>1B        |                                 | 0-0<br>F4                    |                                 | 0-3<br>K                     | 3 0 1 0 0 1 2                    |                              |                                 |                              |                                 |                              |                                  |                              |                                 |                                  |                                    |                                  |        |
| Jim Gentile, L (8, PH)<br>OBP: 0.388, SLG: 0.533    |   |                                  |                              |                                 |                              |                                 |                              |                                 |                              | 1 0 0 0 0 1 2                    |                              |                                 |                              |                                 |                              |                                  |                              |                                 |                                  |                                    |                                  |        |
| George Williams, R (8, 4)<br>OBP: 0.211, SLG: 0.118 |   |                                  |                              |                                 |                              |                                 |                              |                                 |                              | 0 0 0 0 0 0 0                    |                              |                                 |                              |                                 |                              |                                  |                              |                                 |                                  |                                    |                                  |        |
| Diego Segui, R (1, 1)<br>OBP: 0.278, SLG: 0.412     |   | 0-3<br>K                         |                              |                                 | 0-3<br>K                     |                                 | 0-0<br>F7                    |                                 | 0-3<br>K                     | 2 0 0 0 0 2 1                    |                              |                                 |                              |                                 |                              |                                  |                              |                                 |                                  |                                    |                                  |        |
| Jose Tartabull, L (7, PH)<br>OBP: 0.182, SLG: 0.273 |   |                                  |                              |                                 |                              |                                 |                              |                                 |                              | 1 0 0 0 0 0 0                    |                              |                                 |                              |                                 |                              |                                  |                              |                                 |                                  |                                    |                                  |        |
| Vern Handrahan, L (7, 1)                            |   |                                  |                              |                                 |                              |                                 |                              |                                 |                              | 0 0 0 0 0 0 0                    |                              |                                 |                              |                                 |                              |                                  |                              |                                 |                                  |                                    |                                  |        |
| Billy Bryan, L (9, PH)<br>OBP: 0.294, SLG: 0.571    |   |                                  |                              |                                 |                              |                                 |                              |                                 |                              | 1 0 0 0 0 1 0                    |                              |                                 |                              |                                 |                              |                                  |                              |                                 |                                  |                                    |                                  |        |
| <b>Inning Stats</b>                                 | R: 1<br>E: 0<br>K: 2<br>S: 8                          | H: 1<br>LOB: 2<br>BB: 2<br>P: 16 | R: 0<br>E: 0<br>K: 2<br>S: 7 | H: 0<br>LOB: 0<br>BB: 0<br>P: 7 | R: 0<br>E: 0<br>K: 0<br>S: 2 | H: 0<br>LOB: 0<br>BB: 1<br>P: 6 | R: 0<br>E: 0<br>K: 0<br>S: 2 | H: 0<br>LOB: 0<br>BB: 1<br>P: 6 | R: 0<br>E: 0<br>K: 1<br>S: 6 | H: 1<br>LOB: 3<br>BB: 2<br>P: 14 | R: 0<br>E: 0<br>K: 0<br>S: 4 | H: 1<br>LOB: 2<br>BB: 1<br>P: 8 | R: 0<br>E: 0<br>K: 0<br>S: 4 | H: 1<br>LOB: 1<br>BB: 0<br>P: 4 | R: 0<br>E: 0<br>K: 2<br>S: 8 | H: 1<br>LOB: 2<br>BB: 1<br>P: 12 | R: 0<br>E: 0<br>K: 3<br>S: 9 | H: 0<br>LOB: 0<br>BB: 0<br>P: 9 | 1B: 2<br>2B: 2<br>3B: 1<br>HR: 0 | SF: 0<br>SAC: 0<br>DP: 2<br>HBP: 0 | WP: 1<br>PB: 0<br>SB: 0<br>CS: 0 | PA: 38 |
| <b>PITCHER</b>                                      | IP WLS BF H R ER SO BB IBB HBP BLK WP HR S P ERA WHIP |                                  |                              |                                 |                              |                                 |                              |                                 |                              |                                  |                              |                                 |                              |                                 |                              |                                  |                              |                                 |                                  |                                    |                                  |        |
| Ed Connolly, L (1, 1)<br>ERA: 4.05                  | 5.0 W 21 2 1 1 5 6 0 0 0 1 0 25 49 1.80 1.600         |                                  |                              |                                 |                              |                                 |                              |                                 |                              |                                  |                              |                                 |                              |                                 |                              |                                  |                              |                                 |                                  |                                    |                                  |        |
| Bob Hefner, R (6, 1)<br>ERA: 2.12                   | 2.0 11 3 0 0 0 2 0 0 0 0 0 9 17 0.00 2.500            |                                  |                              |                                 |                              |                                 |                              |                                 |                              |                                  |                              |                                 |                              |                                 |                              |                                  |                              |                                 |                                  |                                    |                                  |        |
| Dick Radatz, R (8, 1)<br>ERA: 1.37                  | 2.0 S 6 0 0 0 5 0 0 0 0 0 0 16 16 0.00 0.000          |                                  |                              |                                 |                              |                                 |                              |                                 |                              |                                  |                              |                                 |                              |                                 |                              |                                  |                              |                                 |                                  |                                    |                                  |        |

**Kansas City Athletics @ Boston Red Sox**  
**Fenway Park, Boston, MA**  
 Sun May 24 1964, 3:38 AM EDT  
 Att. 15,869 - Unknown

|     |    |
|-----|----|
| AB  | 30 |
| R   | 1  |
| H   | 5  |
| RBI | 1  |
| BB  | 8  |
| SO  | 10 |
| LOB | 22 |

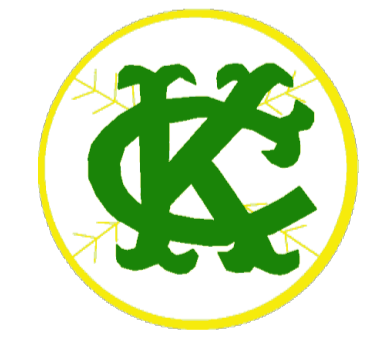



| Batter  | 1                            | 2         | 3          | 4                | 5         | 6          | 7          | 8                               | 9 |
|---|------------------------------|-----------|------------|------------------|-----------|------------|------------|---------------------------------|---|
| Roman Mejias, R<br>OBP: 0.292, SLG: 0.455<br>(1, 7)     | 0-0<br>1B<br>3B              |           | 0-0<br>5-3 |                  | 0-0<br>F7 |            |            | 4-0<br>BB<br>1-2                |   |
| Eddie Bressoud, R<br>OBP: 0.399, SLG: 0.490<br>(1, 6)   | 0-0<br>FC6-4<br>1B<br>3-H    |           | 0-0<br>L8  |                  |           | 0-0<br>1B  |            | 0-0<br>L4<br>2-3                |   |
| Dalton Jones, L<br>OBP: 0.345, SLG: 0.494<br>(1, 4)     | 0-0<br>FC6-4<br>G6-3<br>1-2f |           |            | 0-0<br>1-3       |           | 0-0<br>6-3 |            |                                 |   |
| Carl Yastrzemski, L<br>OBP: 0.354, SLG: 0.451<br>(1, 8) | 0-0<br>G6-3<br>1-2f          |           |            | 4-0<br>HR<br>BB  |           | 0-0<br>F7  |            |                                 |   |
| Dick Stuart, R<br>OBP: 0.282, SLG: 0.370<br>(1, 3)      |                              | 0-0<br>1B |            | 0-0<br>HR<br>1-H |           |            | 0-3<br>K   |                                 |   |
| Dick Williams, R<br>OBP: 0.118, SLG: 0.063<br>(1, 5)    |                              | 0-0<br>L7 |            | 0-0<br>6-3       |           |            | 0-0<br>5-3 |                                 |   |
| Russ Nixon, L<br>OBP: 0.385, SLG: 0.462<br>(1, 2)       |                              | 0-0<br>F5 |            | 0-0<br>G3        |           |            | 0-0<br>3-1 |                                 |   |
| Lou Clinton, R<br>OBP: 0.273, SLG: 0.341<br>(1, 9)      |                              | 0-3<br>K  |            |                  | 0-0<br>F7 |            |            | 0-0<br>FC2-5<br>2B              |   |
| Ed Connolly, L<br>(1, 1)                                |                              |           | 0-3<br>K   |                  |           | 0-0<br>F8  |            | 0-0<br>FC2-5<br>L4<br>BB<br>2-3 |   |
| Felix Mantilla, R<br>OBP: 0.188, SLG: 0.387<br>(5, PH)  |                              |           |            |                  |           |            |            |                                 |   |
| Bob Heffner, R<br>OBP: 0.333, SLG: 0.833<br>(6, 1)      |                              |           |            |                  |           |            |            |                                 |   |
| Dick Radatz, R<br>OBP: 0.333, SLG: 0.333<br>(8, 1)      |                              |           |            |                  |           |            |            |                                 |   |

| Inning Stats | R: 1 | H: 2 | E: 0 | K: 0 | S: 4 | LOB: 0 | BB: 0 | P: 4 | R: 0 | H: 1 | E: 0 | K: 1 | S: 6 | LOB: 1 | BB: 0 | P: 6 | R: 0 | H: 0 | E: 0 | K: 1 | S: 5 | LOB: 0 | BB: 0 | P: 5 | R: 2 | H: 1 | E: 0 | K: 0 | S: 4 | LOB: 0 | BB: 1 | P: 8 | R: 0 | H: 0 | E: 0 | K: 0 | S: 3 | LOB: 0 | BB: 0 | P: 3 | R: 0 | H: 1 | E: 0 | K: 1 | S: 5 | LOB: 0 | BB: 0 | P: 5 | R: 0 | H: 1 | E: 0 | K: 0 | S: 3 | LOB: 0 | BB: 0 | P: 3 | R: 0 | H: 0 | E: 0 | K: 1 | S: 5 | LOB: 0 | BB: 0 | P: 5 | R: 0 | H: 1 | E: 0 | K: 0 | S: 3 | LOB: 1 | BB: 1 | P: 7 |
|--------------|------|------|------|------|------|--------|-------|------|------|------|------|------|------|--------|-------|------|------|------|------|------|------|--------|-------|------|------|------|------|------|------|--------|-------|------|------|------|------|------|------|--------|-------|------|------|------|------|------|------|--------|-------|------|------|------|------|------|------|--------|-------|------|------|------|------|------|------|--------|-------|------|------|------|------|------|------|--------|-------|------|
|--------------|------|------|------|------|------|--------|-------|------|------|------|------|------|------|--------|-------|------|------|------|------|------|------|--------|-------|------|------|------|------|------|------|--------|-------|------|------|------|------|------|------|--------|-------|------|------|------|------|------|------|--------|-------|------|------|------|------|------|------|--------|-------|------|------|------|------|------|------|--------|-------|------|------|------|------|------|------|--------|-------|------|

| PITCHER                                  | IP  | WLS | BF | H | R | ER | SO | BB | IBB | HBP | BLK | WP | HR | S  | P  | ERA  | WHIP  |
|--|-----|-----|----|---|---|----|----|----|-----|-----|-----|----|----|----|----|------|-------|
| Diego Segui, R<br>ERA: 4.32<br>(1, 1)    | 6.0 | L   | 22 | 5 | 3 | 3  | 2  | 1  | 0   | 0   | 0   | 0  | 1  | 25 | 29 | 4.50 | 1.000 |
| Vern Handrahan, R<br>ERA: 6.48<br>(7, 1) | 2.0 |     | 7  | 1 | 0 | 0  | 1  | 1  | 0   | 0   | 0   | 0  | 0  | 8  | 12 | 0.00 | 1.000 |

**BOTTOM**

**Kansas City Athletics @ Boston Red Sox**  
 Fenway Park, Boston, MA  
 Sun May 24 1964, 3:38 AM EDT  
 Att. 15,869 - Unknown

| AB | R | H | RBI | BB | SO | LOB |
|----|---|---|-----|----|----|-----|
| 3  | 1 | 1 | 0   | 1  | 0  | 0   |
| 4  | 0 | 2 | 1   | 0  | 0  | 2   |
| 3  | 0 | 0 | 0   | 0  | 0  | 1   |
| 2  | 1 | 0 | 0   | 1  | 0  | 1   |
| 3  | 1 | 2 | 2   | 0  | 1  | 0   |
| 3  | 0 | 0 | 0   | 0  | 0  | 1   |
| 3  | 0 | 0 | 0   | 0  | 0  | 1   |
| 3  | 0 | 1 | 0   | 0  | 1  | 1   |
| 1  | 0 | 0 | 0   | 0  | 1  | 0   |
| 1  | 0 | 0 | 0   | 0  | 0  | 0   |
| 0  | 0 | 0 | 0   | 0  | 0  | 0   |
| 1  | 0 | 0 | 0   | 0  | 0  | 1   |

|       |        |
|-------|--------|
| 1B: 3 | SF: 0  |
| 2B: 2 | SAC: 0 |
| 3B: 1 | DP: 2  |
| HR: 1 | HBP: 0 |

| WP | PA |
|----|----|
| 0  | 29 |

livebaseballscorecards.com



| WP | PA | ERA | WHIP |
|----|----|-----|------|
| 0  | 29 |     |      |

| Batter   | 1                              | 2                               | 3                            | 4                                | 5                            | 6                               | 7                            | 8                               | 9                            | AB R H RBI BB SO LOB                            | TOP                          |                                 |                              |                                  |                              |                                       |  |                                 |                                  |                                    |                                  |        |  |  |
|--|--------------------------------|---------------------------------|------------------------------|----------------------------------|------------------------------|---------------------------------|------------------------------|---------------------------------|------------------------------|---|------------------------------|---------------------------------|------------------------------|----------------------------------|------------------------------|---------------------------------------|--|---------------------------------|----------------------------------|------------------------------------|----------------------------------|--------|--|--|
| Mike Hershberger, R<br>OBP: 0.323, SLG: 0.302<br>(1, 8)<br>BB  | 4-0<br>4-3<br>BB               |                                 | 0-0<br>6-3                   |                                  | 0-0<br>5-3                   |                                 | 0-0<br>1-3                   | 0-0<br>6-3                      |                              | 4 0 0 0 1 0 0                                   |                              |                                 |                              |                                  |                              |                                       |  |                                 |                                  |                                    |                                  |        |  |  |
| Al Weis, S<br>OBP: 0.297, SLG: 0.324<br>(1, 4)<br>1-2  | 0-0<br>4-3                     |                                 | 0-0<br>5-3                   |                                  | 0-0<br>E6                    |                                 | 0-0<br>BLK<br>1B             | 0-0<br>4-3                      |                              | 5 1 1 0 0 0 1                                   |                              |                                 |                              |                                  |                              |                                       |  |                                 |                                  |                                    |                                  |        |  |  |
| Floyd Robinson, L<br>OBP: 0.384, SLG: 0.459<br>(1, 9)<br>1-2   | 0-0<br>F5                      |                                 | 0-0<br>4-3                   |                                  | 0-0<br>F8                    |                                 | 0-0<br>1-4-3                 |                                 | 0-0<br>F7                    | 5 0 0 0 0 0 3                                   |                              |                                 |                              |                                  |                              |                                       |  |                                 |                                  |                                    |                                  |        |  |  |
| Pete Ward, L<br>OBP: 0.407, SLG: 0.478<br>Don Buford, S<br>OBP: 0.310, SLG: 0.230<br>(1, 5)<br>(9, 5)<br>SS                              | 0-3<br>K                       |                                 |                              | 0-0<br>4-3                       |                              | 0-0<br>HR                       | 0-0<br>HR<br>1B              |                                 | 0-3<br>K                     | 5 2 2 2 0 2 1<br>0 0 0 0 0 0 0                  |                              |                                 |                              |                                  |                              |                                       |  |                                 |                                  |                                    |                                  |        |  |  |
| Ron Hansen, R<br>OBP: 0.397, SLG: 0.532<br>(1, 6)  |                                |                                 |                              |                                  |                              |                                 |                              |                                 | 0-0<br>F9                    | 5 1 3 2 0 0 0                                   |                              |                                 |                              |                                  |                              |                                       |  |                                 |                                  |                                    |                                  |        |  |  |
| Dave Nicholson, R<br>OBP: 0.441, SLG: 0.539<br>(1, 7)<br>BB  |                                |                                 |                              |                                  |                              |                                 |                              |                                 | 0-0<br>F9                    | 1 1 0 0 2 0 1                                   |                              |                                 |                              |                                  |                              |                                       |  |                                 |                                  |                                    |                                  |        |  |  |
| Tom McCraw, L<br>OBP: 0.356, SLG: 0.473<br>(1, 3)<br>1-3   |                                |                                 |                              |                                  |                              |                                 |                              |                                 | 0-0<br>E9                    | 4 0 1 0 0 0 4                                   |                              |                                 |                              |                                  |                              |                                       |  |                                 |                                  |                                    |                                  |        |  |  |
| Cam Carreon, R<br>OBP: 0.125, SLG: 0.130<br>J.C. Martin, L<br>OBP: 0.250, SLG: 0.371<br>(1, 2)<br>(7, 2)                                 |                                |                                 |                              |                                  |                              |                                 |                              |                                 | 0-0<br>6-3                   | 3 0 0 1 0 0 4<br>1 1 1 1 0 0 0                  |                              |                                 |                              |                                  |                              |                                       |  |                                 |                                  |                                    |                                  |        |  |  |
| Gary Peters, L<br>OBP: 0.158, SLG: 0.263<br>Jim Landis, R<br>OBP: 0.417, SLG: 1.000<br>Hoyt Wilhelm, R<br>(7, 1)<br>3-H                  | 0-3<br>K                       |                                 |                              |                                  |                              |                                 |                              |                                 | 0-3<br>K                     | 2 0 0 0 0 1 1<br>1 1 1 1 0 0 0<br>1 0 0 0 0 1 0 |                              |                                 |                              |                                  |                              |                                       |  |                                 |                                  |                                    |                                  |        |  |  |
| Inning Stats   | R: 0<br>E: 0<br>K: 1<br>S: 5   | H: 0<br>LOB: 1<br>BB: 1<br>P: 9 | R: 1<br>E: 1<br>K: 1<br>S: 6 | H: 1<br>LOB: 1<br>BB: 1<br>P: 10 | R: 0<br>E: 0<br>K: 0<br>S: 3 | H: 0<br>LOB: 0<br>BB: 0<br>P: 3 | R: 0<br>E: 0<br>K: 0<br>S: 4 | H: 1<br>LOB: 2<br>BB: 0<br>P: 5 | R: 0<br>E: 1<br>K: 0<br>S: 4 | H: 0<br>LOB: 1<br>BB: 0<br>P: 4                 | R: 1<br>E: 0<br>K: 0<br>S: 5 | H: 2<br>LOB: 1<br>BB: 0<br>P: 5 | R: 4<br>E: 0<br>K: 0<br>S: 7 | H: 4<br>LOB: 1<br>BB: 1<br>P: 11 | R: 1<br>E: 0<br>K: 1<br>S: 6 | H: 1<br>LOB: 0<br>BB: 0<br>P: 6       | R: 0<br>E: 0<br>K: 1<br>S: 5             | H: 0<br>LOB: 0<br>BB: 0<br>P: 5 | 1B: 4<br>2B: 1<br>3B: 0<br>HR: 4 | SF: 0<br>SAC: 0<br>DP: 0<br>HBP: 1 | WP: 0<br>PB: 0<br>SB: 0<br>CS: 0 | PA: 41 |  |  |
| PITCHER<br>John O'Donoghue, L<br>ERA: 4.76<br>Joe Grzenda, L<br>ERA: 11.37<br>Jack Aker, R<br>ERA: 8.82<br>Ted Bowsfield, L<br>ERA: 6.92 | IP<br>6.0<br>0.2<br>1.1<br>1.0 | WLS<br>L                        | BF<br>27<br>4<br>7<br>3      | H<br>5<br>2<br>2<br>0            | R<br>3<br>1<br>0<br>0        | ER<br>3<br>1<br>3<br>0          | SO<br>2<br>0<br>1<br>1       | BB<br>2<br>0<br>1<br>0          | IBB<br>0<br>0<br>0<br>0      | HBP<br>1<br>0<br>0<br>0                         | BLK<br>0<br>1<br>0<br>0      | WP<br>0<br>0<br>0<br>0          | HR<br>2<br>0<br>2<br>0       | S<br>28<br>4<br>8<br>5           | P<br>37<br>4<br>12<br>5      | ERA<br>4.50<br>13.50<br>20.25<br>0.00 | WHIP<br>1.167<br>3.000<br>2.250<br>0.000 |                                 |                                  |                                    |                                  |        |  |  |

Chicago White Sox @ Kansas City Athletics  
Municipal Stadium, Kansas City, MO  
Mon May 25 1964, 8:05 PM EDT  
Att. 5,680 - Unknown

|     |    |
|-----|----|
| AB  | 37 |
| R   | 7  |
| H   | 9  |
| RBI | 7  |
| BB  | 3  |
| SO  | 4  |
| LOB | 15 |



livebaseballscorecards.com

| Batter  | 1                            | 2                    | 3         | 4          | 5                     | 6                | 7                      | 8          | 9         | AB | R | H | RBI | BB | SO | LOB |
|---|------------------------------|----------------------|-----------|------------|-----------------------|------------------|------------------------|------------|-----------|----|---|---|-----|----|----|-----|
| Wayne Causey, L (1, 6)<br>OBP: 0.394, SLG: 0.340    | 4-0<br>G1-4-3<br>BB<br>1B    | 4-0<br>FC6-4<br>BB   |           |            | 4-0<br>FC5<br>E<br>BB | 0-0<br>6-3       |                        | 4-0<br>BB  |           | 1  | 1 | 0 | 0   | 4  | 0  | 1   |
| Nelson Mathews, R (1, 8)<br>OBP: 0.343, SLG: 0.400  | 4-0<br>G1-4-3<br>1-2<br>BB   | 0-0<br>FC6-4<br>1-2f |           |            | 0-0<br>6-3<br>1-2     |                  | 0-3<br>K               | 0-0<br>F2  |           | 4  | 0 | 0 | 0   | 1  | 1  | 3   |
| Ed Charles, R (1, 5)<br>OBP: 0.371, SLG: 0.351      | 0-0<br>G1-4-3<br>1-2f<br>2-3 |                      | 0-3<br>K  |            | 0-3<br>K              |                  | 0-0<br>WP<br>5-3<br>1B |            | 0-0<br>F8 | 5  | 1 | 1 | 0   | 0  | 2  | 3   |
| Rocky Colavito, R (1, 9)<br>OBP: 0.404, SLG: 0.632  | 0-0<br>BB<br>1B              |                      | 0-3<br>K  |            | 4-0<br>IBB            |                  | 0-0<br>5-3<br>1-2      |            | 0-0<br>F7 | 4  | 1 | 1 | 1   | 1  | 1  | 1   |
| George Alusik, R (1, 3)<br>OBP: 0.552, SLG: 0.561   | 4-0<br>1B<br>BB              |                      | 4-0<br>BB |            | 0-0<br>FC5<br>2-3f    |                  | 0-0<br>1B              |            | 0-0<br>1B | 3  | 0 | 2 | 1   | 2  | 0  | 2   |
| Doc Edwards, R (1, 2)<br>OBP: 0.273, SLG: 0.283     | 0-0<br>1-2<br>2-H<br>1B      |                      | 0-0<br>F7 |            | 0-0<br>E5<br>2B       |                  | 0-0<br>1-2<br>1B       |            | 0-3<br>K  | 5  | 1 | 2 | 1   | 0  | 1  | 2   |
| Dick Green, R (1, 4)<br>OBP: 0.245, SLG: 0.344      | 0-0<br>F8                    |                      |           | 0-0<br>5-3 |                       | 0-0<br>1-H<br>2B |                        | 0-0<br>F7  |           | 4  | 0 | 1 | 1   | 0  | 0  | 4   |
| George Williams, R (1, 7)<br>OBP: 0.182, SLG: 0.100 |                              | 0-0<br>F8            |           | 0-0<br>5-3 |                       | 0-0<br>F4        |                        | 0-0<br>6-3 |           | 3  | 0 | 0 | 0   | 0  | 0  | 1   |
| Charlie Lau, L (8, PH)<br>OBP: 0.355, SLG: 0.476    |                              |                      |           |            |                       |                  |                        |            |           | 1  | 0 | 0 | 0   | 0  | 0  | 0   |
| Ted Bowsfield, R (9, 1)                             |                              |                      |           |            |                       |                  |                        |            |           | 0  | 0 | 0 | 0   | 0  | 0  | 0   |
| John O'Donoghue, R (1, 1)<br>OBP: 0.357, SLG: 0.357 |                              | 0-0<br>F8            |           | 0-0<br>F2  |                       | 0-0<br>F8        |                        | 0-3<br>K   |           | 3  | 0 | 0 | 0   | 0  | 0  | 1   |
| Joe Grzenda, R (7, 1)                               |                              |                      |           |            |                       |                  |                        |            |           | 0  | 0 | 0 | 0   | 0  | 0  | 0   |
| Jack Aker, R (7, 1)                                 |                              |                      |           |            |                       |                  |                        |            |           | 0  | 0 | 0 | 0   | 0  | 0  | 0   |
| Jose Tartabull, L (8, PH)<br>OBP: 0.167, SLG: 0.250 |                              |                      |           |            |                       |                  |                        |            |           | 1  | 0 | 0 | 0   | 0  | 1  | 0   |

| Inning Stats                        | R: 2 | H: 2 | E: 0 | K: 0 | S: 4 | LOB: 2 | BB: 3 | P: 16 | R: 0 | H: 0 | E: 0 | K: 0 | S: 3 | LOB: 1 | BB: 1 | P: 7 | R: 0  | H: 0 | E: 0 | K: 2 | S: 7 | LOB: 1 | BB: 1 | P: 11 | R: 0 | H: 0 | E: 0 | K: 0 | S: 3 | LOB: 0 | BB: 0 | P: 3 | R: 0 | H: 0 | E: 1 | K: 1 | S: 5 | LOB: 2 | BB: 2 | P: 13 | R: 1 | H: 1 | E: 1 | K: 0 | S: 5 | LOB: 1 | BB: 0 | P: 5 | R: 1 | H: 3 | E: 0 | K: 1 | S: 8 | LOB: 2 | BB: 0 | P: 8 | R: 0 | H: 0 | E: 0 | K: 1 | S: 5 | LOB: 1 | BB: 1 | P: 9 | R: 0 | H: 1 | E: 0 | K: 1 | S: 6 | LOB: 1 | BB: 0 | P: 6 | 1B: 6 | 2B: 1 | 3B: 0 | HR: 0 | SF: 0 | SAC: 0 | DP: 1 | HBP: 0 | WP: 1 | PB: 0 | SB: 0 | CS: 0 | PA: 42 |
|-------------------------------------|------|------|------|------|------|--------|-------|-------|------|------|------|------|------|--------|-------|------|-------|------|------|------|------|--------|-------|-------|------|------|------|------|------|--------|-------|------|------|------|------|------|------|--------|-------|-------|------|------|------|------|------|--------|-------|------|------|------|------|------|------|--------|-------|------|------|------|------|------|------|--------|-------|------|------|------|------|------|------|--------|-------|------|-------|-------|-------|-------|-------|--------|-------|--------|-------|-------|-------|-------|--------|
| PITCHER                             | IP   | WLS  | BF   | H    | R    | ER     | SO    | BB    | IBB  | HBP  | BLK  | WP   | HR   | S      | P     | ERA  | WHIP  |      |      |      |      |        |       |       |      |      |      |      |      |        |       |      |      |      |      |      |      |        |       |       |      |      |      |      |      |        |       |      |      |      |      |      |      |        |       |      |      |      |      |      |      |        |       |      |      |      |      |      |      |        |       |      |       |       |       |       |       |        |       |        |       |       |       |       |        |
| Gary Peters, L (1, 1)<br>ERA: 3.58  | 6.0  | W    | 28   | 3    | 3    | 2      | 3     | 6     | 1    | 0    | 0    | 0    | 0    | 27     | 55    | 3.00 | 1.500 |      |      |      |      |        |       |       |      |      |      |      |      |        |       |      |      |      |      |      |      |        |       |       |      |      |      |      |      |        |       |      |      |      |      |      |      |        |       |      |      |      |      |      |      |        |       |      |      |      |      |      |      |        |       |      |       |       |       |       |       |        |       |        |       |       |       |       |        |
| Hoyt Wilhelm, R (7, 1)<br>ERA: 1.96 | 3.0  | S    | 14   | 4    | 1    | 1      | 3     | 1     | 0    | 0    | 0    | 1    | 0    | 19     | 23    | 3.00 | 1.667 |      |      |      |      |        |       |       |      |      |      |      |      |        |       |      |      |      |      |      |      |        |       |       |      |      |      |      |      |        |       |      |      |      |      |      |      |        |       |      |      |      |      |      |      |        |       |      |      |      |      |      |      |        |       |      |       |       |       |       |       |        |       |        |       |       |       |       |        |

**BOTTOM**

**Chicago White Sox @ Kansas City Athletics**  
Municipal Stadium, Kansas City, MO

Mon May 25 1964, 8:05 PM EDT  
Att. 5,680 - Unknown

livebaseballscorecards.com

|     |    |
|-----|----|
| AB  | 34 |
| R   | 4  |
| H   | 7  |
| RBI | 4  |
| BB  | 8  |
| SO  | 6  |
| LOB | 18 |



| Batter   | 1                            | 2                               | 3                            | 4                               | 5                            | 6                               | 7                            | 8                                | 9                             | AB R H RBI BB SO LOB  | TOP  |                                 |                              |                                 |                              |                                 |                              |                                 |                                  |                                    |                                  |        |             |               |
|--|------------------------------|---------------------------------|------------------------------|---------------------------------|------------------------------|---------------------------------|------------------------------|----------------------------------|-------------------------------|---|--|---------------------------------|------------------------------|---------------------------------|------------------------------|---------------------------------|------------------------------|---------------------------------|----------------------------------|------------------------------------|----------------------------------|--------|-------------|---------------|
| Tom McCraw, L (1, 3)<br>OBP: 0.359, SLG: 0.467   | 0-3<br>K                     |                                 | 0-0<br>FC1-6<br>1B           |                                 | 0-0<br>S<br>1B               |                                 | 0-0<br>4-3                   |                                  | 0-0<br>4-3                    | 5 0 2 1 0 1 3   | <b>Chicago White Sox @ Kansas City Athletics</b><br>Municipal Stadium, Kansas City, MO<br>Thu May 28 1964, 8:05 PM EDT<br>Att. 3,150 - Unknown<br><a href="http://livebaseballscorecards.com">livebaseballscorecards.com</a> |                                 |                              |                                 |                              |                                 |                              |                                 |                                  |                                    |                                  |        |             |               |
| Al Weis, S (1, 4)<br>OBP: 0.287, SLG: 0.312  | 0-3<br>K                     |                                 | 0-0<br>FC1-6<br>1-2f         |                                 | 0-3<br>K                     |                                 |                              | 0-3<br>K                         |                               | 4 0 0 0 0 3 3   |  |                                 |                              |                                 |                              |                                 |                              |                                 |                                  |                                    |                                  |        |             |               |
| Floyd Robinson, L (1, 9)<br>OBP: 0.372, SLG: 0.442   | 0-0<br>F9                    |                                 | 0-0<br>4-3                   |                                 | 0-3<br>K                     |                                 |                              | 0-0<br>5-3                       |                               | 4 0 0 0 0 1 3   |  |                                 |                              |                                 |                              |                                 |                              |                                 |                                  |                                    |                                  |        |             |               |
| Pete Ward, L (1, 5)<br>OBP: 0.397, SLG: 0.460  |                              | 0-0<br>2B<br>1B                 |                              | 0-3<br>K                        | 0-3<br>K                     |                                 |                              | 0-0<br>L4                        |                               | 4 0 1 0 0 2 2   |  |                                 |                              |                                 |                              |                                 |                              |                                 |                                  |                                    |                                  |        |             |               |
| Ron Hansen, R (1, 6)<br>OBP: 0.400, SLG: 0.526   |                              | 0-0<br>F2                       |                              | 4-0<br>BB                       |                              | 0-0<br>F9                       |                              | 0-0<br>FC4-6<br>1B               |                               | 3 0 1 0 1 0 1   |  |                                 |                              |                                 |                              |                                 |                              |                                 |                                  |                                    |                                  |        |             |               |
| Dave Nicholson, R (1, 7)<br>OBP: 0.435, SLG: 0.528   |                              | 0-3<br>K                        |                              | 0-3<br>K                        |                              | 0-0<br>6-3                      |                              | 0-0<br>FC4-6<br>1B               |                               | 4 0 1 0 0 2 2   |  |                                 |                              |                                 |                              |                                 |                              |                                 |                                  |                                    |                                  |        |             |               |
| Mike Hershberger, R (1, 8)<br>OBP: 0.321, SLG: 0.308   |                              | 0-0<br>1-3<br>2B                |                              | 0-0<br>F8                       |                              | 0-0<br>F9                       |                              | 0-0<br>F8                        |                               | 4 0 1 0 0 0 3   |  |                                 |                              |                                 |                              |                                 |                              |                                 |                                  |                                    |                                  |        |             |               |
| J.C. Martin, L (1, 2)<br>OBP: 0.235, SLG: 0.348  |                              | 0-0<br>F6                       |                              | 0-0<br>E1<br>BB<br>1B           |                              | 0-0<br>F7                       |                              | 0-0<br>FC4-6<br>BB               |                               | 4 1 0 0 0 0 4   |  |                                 |                              |                                 |                              |                                 |                              |                                 |                                  |                                    |                                  |        |             |               |
| Juan Pizarro, L (1, 1)<br>OBP: 0.316, SLG: 0.444<br>Gene Stephens, L (5, PH)<br>OBP: 0.286, SLG: 0.167<br>Frank Kreutzer, R (5, 1)<br>OBP: 0.333, SLG: 0.667<br>Don Buford, S (7, PH)<br>OBP: 0.307, SLG: 0.227<br>Eddie Fisher, R (7, 1)<br>Joe Cunningham, L (8, PH)<br>OBP: 0.357, SLG: 0.313<br>Gary Peiers, L (9, PR)<br>OBP: 0.158, SLG: 0.263 |                              |                                 | 0-0<br>F8                    |                                 | 4-0<br>S<br>1B<br>BB         |                                 | 0-0<br>F6                    |                                  | 4-0<br>BB<br>BB<br>BB         | 1 0 0 0 0 0 0<br>0 0 0 0 0 1 0 0<br>0 0 0 0 0 0 0 0<br>1 0 0 0 0 0 0 0<br>0 0 0 0 0 0 0 0<br>0 0 0 0 0 1 0 0<br>0 0 0 0 0 0 0 0 |  |                                 |                              |                                 |                              |                                 |                              |                                 |                                  |                                    |                                  |        |             |               |
| <b>Inning Stats</b>  | R: 0<br>E: 0<br>K: 2<br>S: 7 | H: 0<br>LOB: 0<br>BB: 0<br>P: 7 | R: 0<br>E: 0<br>K: 1<br>S: 7 | H: 2<br>LOB: 2<br>BB: 0<br>P: 7 | R: 0<br>E: 0<br>K: 0<br>S: 4 | H: 1<br>LOB: 1<br>BB: 0<br>P: 4 | R: 0<br>E: 0<br>K: 2<br>S: 7 | H: 0<br>LOB: 1<br>BB: 1<br>P: 11 | R: 1<br>E: 1<br>K: 3<br>S: 11 | H: 1<br>LOB: 2<br>BB: 1<br>P: 15  | R: 0<br>E: 0<br>K: 0<br>S: 3   | H: 0<br>LOB: 0<br>BB: 0<br>P: 3 | R: 0<br>E: 0<br>K: 0<br>S: 3 | H: 0<br>LOB: 0<br>BB: 0<br>P: 3 | R: 0<br>E: 0<br>K: 1<br>S: 5 | H: 0<br>LOB: 0<br>BB: 0<br>P: 5 | R: 0<br>E: 0<br>K: 0<br>S: 5 | H: 2<br>LOB: 3<br>BB: 1<br>P: 9 | 1B: 5<br>2B: 1<br>3B: 0<br>HR: 0 | SF: 0<br>SAC: 0<br>DP: 0<br>HBP: 0 | WP: 0<br>PB: 0<br>SB: 2<br>CS: 0 | PA: 37 |             |               |
| <b>PITCHER</b><br>Orlando Pena, R (1, 1)<br>ERA: 3.53<br>John Wyatt, R (9, 1)<br>ERA: 1.71   | IP<br>8.0                    | WLS<br>W                        | BF<br>33                     | H<br>6                          | R<br>1                       | ER<br>0                         | SO<br>9                      | BB<br>2                          | IBB<br>0                      | HBP<br>0  | BLK<br>0   | WP<br>0                         | HR<br>0                      | S<br>49                         | P<br>57                      | ERA<br>0.00                     | WHIP<br>1.000                |                                 |                                  |                                    |                                  |        | ERA<br>0.00 | WHIP<br>1.000 |



| Batter   | 1      | 2           | 3      | 4       | 5       | 6          | 7      | 8      | 9 |
|--|--------|-------------|--------|---------|---------|------------|--------|--------|---|
| Wayne Causey, L (1, 6)<br>OBP: 0.400, SLG: 0.345   | 0-3 K  | 0-0 1B      |        | 0-0 1B  |         | 4-0 BB     |        | 0-0 F7 |   |
| Nelson Mathews, R (1, 8)<br>OBP: 0.335, SLG: 0.390 | 0-0 F8 |             | 0-3 K  | 0-0 1-3 |         | 0-0 L4-3   |        |        |   |
| Ed Charles, R (1, 5)<br>OBP: 0.362, SLG: 0.341     | 0-0 E6 |             | 0-0 F8 |         | 0-0 F2  |            | 0-0 F9 |        |   |
| Rocky Colavito, R (1, 9)<br>OBP: 0.400, SLG: 0.617 | 0-0 F8 |             | 4-0 BB |         | 0-0 6-3 |            | 0-0 F5 |        |   |
| George Alusik, R (1, 7)<br>OBP: 0.548, SLG: 0.535  |        | 4-0 BB      | 0-0 F8 |         | 0-0 E3  |            | 4-0 BB |        |   |
| Doc Edwards, R (1, 3)<br>OBP: 0.288, SLG: 0.316    |        | 0-0 4-3     |        | 0-0 1B  | 0-0 BB  | 1-2 1B     | 0-0 F6 |        |   |
| Dick Green, R (1, 4)<br>OBP: 0.245, SLG: 0.336     |        | 0-0 FC1-5-6 |        | 0-3 K   | 4-0 BB  | 1-2 2-3 BB | 0-3 K  |        |   |
| Charlie Lau, L (1, 2)<br>OBP: 0.351, SLG: 0.466    |        | 0-0 E5      |        | 0-0 E7  | 0-3 K   |            | 0-3 K  |        |   |
| Orlando Pena, R (1, 1)<br>John Wyatt, R (9, 1)     |        | 0-0 1B      |        | 0-3 K   |         | 0-0 1-6-3  |        | 0-0 1B |   |

| Inning Stats | R: 0   | H: 0  | E: 1 | K: 1 | S: 6 | P: 6 | R: 2   | H: 2  | E: 1 | K: 0 | S: 5 | R: 0   | H: 0  | E: 0 | K: 1 | S: 5 | R: 2   | H: 3  | E: 1 | K: 2 | S: 10 | R: 0   | H: 1  | E: 1 | K: 1   | S: 7  | R: 0 | H: 0   | E: 0  | K: 0 | S: 3   | R: 0  | H: 1 | E: 0 | K: 2 | S: 8 |
|--------------|--------|-------|------|------|------|------|--------|-------|------|------|------|--------|-------|------|------|------|--------|-------|------|------|-------|--------|-------|------|--------|-------|------|--------|-------|------|--------|-------|------|------|------|------|
|              | LOB: 1 | BB: 0 |      |      |      |      | LOB: 2 | BB: 1 |      |      |      | LOB: 1 | BB: 1 |      |      |      | LOB: 3 | BB: 1 |      |      |       | LOB: 0 | BB: 1 |      | LOB: 1 | BB: 1 |      | LOB: 1 | BB: 1 |      | LOB: 1 | BB: 0 |      |      |      |      |

| AB | R | H | RBI | BB | SO | LOB |
|----|---|---|-----|----|----|-----|
| 4  | 0 | 2 | 3   | 1  | 1  | 1   |
| 4  | 0 | 0 | 0   | 0  | 1  | 2   |
| 4  | 0 | 0 | 0   | 0  | 0  | 0   |
| 3  | 0 | 0 | 0   | 1  | 0  | 1   |
| 2  | 0 | 0 | 0   | 2  | 0  | 1   |
| 4  | 1 | 2 | 0   | 0  | 0  | 2   |
| 3  | 1 | 0 | 0   | 1  | 2  | 2   |
| 4  | 2 | 1 | 0   | 0  | 2  | 4   |
| 4  | 0 | 2 | 1   | 0  | 1  | 2   |
| 0  | 0 | 0 | 0   | 0  | 0  | 0   |

**BOTTOM**

**Chicago White Sox @ Kansas City Athletics**  
Municipal Stadium, Kansas City, MO

Thu May 28 1964, 8:05 PM EDT  
Att. 3,150 - Unknown

|     |    |
|-----|----|
| AB  | 32 |
| R   | 4  |
| H   | 7  |
| RBI | 4  |
| BB  | 5  |
| SO  | 7  |
| LOB | 15 |



| PITCHER                              | IP  | WLS | BF | H | R | ER | SO | BB | IBB | HBP | BLK | WP | HR | S  | P  | ERA  | WHIP  |
|--------------------------------------|-----|-----|----|---|---|----|----|----|-----|-----|-----|----|----|----|----|------|-------|
| Juan Pizarro, L (1, 1)<br>ERA: 1.24  | 4.0 | L   | 20 | 5 | 4 | 1  | 4  | 2  | 0   | 0   | 0   | 0  | 0  | 26 | 34 | 2.25 | 1.750 |
| Frank Kreutzer, L (5, 1)<br>ERA: 3.5 | 2.0 |     | 9  | 1 | 0 | 0  | 1  | 2  | 0   | 0   | 0   | 0  | 0  | 9  | 17 | 0.00 | 1.500 |
| Eddie Fisher, R (7, 1)<br>ERA: 4.58  | 2.0 |     | 8  | 1 | 0 | 0  | 2  | 1  | 0   | 0   | 0   | 0  | 0  | 11 | 15 | 0.00 | 1.000 |

| Batter  | 1   | 2                               | 3                            | 4                               | 5                            | 6                                | 7                            | 8                                | 9                            | AB R H RBI BB SO LOB            | TOP                          |                                 |                              |                                 |                              |                                 |                              |                                  |                                  |                                    |                                  |        |
|---|---|---------------------------------|------------------------------|---------------------------------|------------------------------|----------------------------------|------------------------------|----------------------------------|------------------------------|---------------------------------|------------------------------|---------------------------------|------------------------------|---------------------------------|------------------------------|---------------------------------|------------------------------|----------------------------------|----------------------------------|------------------------------------|----------------------------------|--------|
| Tony Kubek, L (1, 6)<br>OBP: 0.292, SLG: 0.345        | 0-0<br>F7   |                                 | 0-3<br>K                     |                                 | 0-0<br>4-3                   |                                  |                              | 0-0<br>G3                        | 4-0<br>BB                    | 4 0 0 0 1 1 2                   |                              |                                 |                              |                                 |                              |                                 |                              |                                  |                                  |                                    |                                  |        |
| Bobby Richardson, R (1, 4)<br>OBP: 0.331, SLG: 0.344  | 0-0<br>F8   |                                 | 0-0<br>F8                    |                                 |                              | 0-0<br>L4                        |                              | 0-0<br>F7                        | 0-0<br>F8                    | 5 0 0 0 0 0 5                   |                              |                                 |                              |                                 |                              |                                 |                              |                                  |                                  |                                    |                                  |        |
| Hector Lopez, R (1, 7)<br>OBP: 0.320, SLG: 0.533      | 0-3<br>K  |                                 |                              | 0-0<br>4-3                      |                              | 0-0<br>HR                        |                              | 0-0<br>1B                        |                              | 4 1 2 1 0 1 0                   |                              |                                 |                              |                                 |                              |                                 |                              |                                  |                                  |                                    |                                  |        |
| Roger Maris, L (1, 9)<br>OBP: 0.359, SLG: 0.558       |   | 0-0<br>3-1                      |                              | 0-0<br>F9                       |                              | 0-3<br>K                         |                              | 0-0<br>1B                        |                              | 4 0 1 0 0 1 0                   |                              |                                 |                              |                                 |                              |                                 |                              |                                  |                                  |                                    |                                  |        |
| Tom Tresh, S (1, 8)<br>OBP: 0.325, SLG: 0.404         |   | 0-0<br>3-1                      |                              | 4-0<br>BB                       |                              | 0-0<br>1-3                       |                              | 0-3<br>K                         |                              | 3 0 0 0 1 1 2                   |                              |                                 |                              |                                 |                              |                                 |                              |                                  |                                  |                                    |                                  |        |
| Joe Pepitone, L (1, 3)<br>OBP: 0.327, SLG: 0.430      |   | 0-0<br>4-3                      |                              | 4-0<br>BB                       |                              |                                  | 0-0<br>6-3                   |                                  | 0-0<br>1B                    | 3 0 1 0 1 0 0                   |                              |                                 |                              |                                 |                              |                                 |                              |                                  |                                  |                                    |                                  |        |
| Elston Howard, R (1, 2)<br>OBP: 0.394, SLG: 0.436     |   |                                 | 4-0<br>BB                    | 0-0<br>F9                       |                              |                                  | 0-0<br>1B                    |                                  | 0-0<br>1-3                   | 3 0 2 0 1 0 2                   |                              |                                 |                              |                                 |                              |                                 |                              |                                  |                                  |                                    |                                  |        |
| Clete Boyer, R (1, 5)<br>OBP: 0.261, SLG: 0.303       |   |                                 | 4-0<br>BB                    |                                 | 0-0<br>P5                    |                                  | 0-0<br>P3                    |                                  | 4-0<br>1-3                   | 2 0 0 0 2 0 1                   |                              |                                 |                              |                                 |                              |                                 |                              |                                  |                                  |                                    |                                  |        |
| Jim Bouton, R (1, 1)<br>OBP: 0.087, SLG: 0.045        |   |                                 | 0-3<br>K                     |                                 | 0-3<br>K                     |                                  | 0-3<br>K                     |                                  | 0-0<br>1-3                   | 2 0 0 0 0 2 2                   |                              |                                 |                              |                                 |                              |                                 |                              |                                  |                                  |                                    |                                  |        |
| Mickey Mantle, S (7, PH)<br>OBP: 0.452, SLG: 0.600    |   |                                 |                              |                                 |                              |                                  |                              |                                  | 1-2<br>2-3                   | 1 0 0 0 0 1 1                   |                              |                                 |                              |                                 |                              |                                 |                              |                                  |                                  |                                    |                                  |        |
| Stan Williams, R (7, 1)<br>OBP: 0.400, SLG: 0.400     |   |                                 |                              |                                 |                              |                                  |                              |                                  |                              | 0 0 0 0 0 0 0                   |                              |                                 |                              |                                 |                              |                                 |                              |                                  |                                  |                                    |                                  |        |
| Johnny Blanchard, L (9, PH)<br>OBP: 0.405, SLG: 0.387 |   |                                 |                              |                                 |                              |                                  |                              |                                  |                              | 1 0 0 0 0 0 2                   |                              |                                 |                              |                                 |                              |                                 |                              |                                  |                                  |                                    |                                  |        |
| <b>Inning Stats</b>                                   | R: 0<br>E: 0<br>K: 1<br>S: 5                          | H: 0<br>LOB: 0<br>BB: 0<br>P: 5 | R: 0<br>E: 0<br>K: 0<br>S: 3 | H: 0<br>LOB: 0<br>BB: 0<br>P: 3 | R: 0<br>E: 0<br>K: 2<br>S: 7 | H: 0<br>LOB: 2<br>BB: 2<br>P: 15 | R: 0<br>E: 0<br>K: 0<br>S: 3 | H: 0<br>LOB: 2<br>BB: 2<br>P: 11 | R: 0<br>E: 0<br>K: 1<br>S: 5 | H: 0<br>LOB: 0<br>BB: 0<br>P: 5 | R: 1<br>E: 0<br>K: 1<br>S: 6 | H: 1<br>LOB: 0<br>BB: 0<br>P: 6 | R: 0<br>E: 0<br>K: 1<br>S: 6 | H: 1<br>LOB: 1<br>BB: 0<br>P: 6 | R: 0<br>E: 0<br>K: 1<br>S: 7 | H: 2<br>LOB: 2<br>BB: 0<br>P: 7 | R: 0<br>E: 0<br>K: 0<br>S: 4 | H: 2<br>LOB: 3<br>BB: 2<br>P: 12 | 1B: 5<br>2B: 0<br>3B: 0<br>HR: 1 | SF: 0<br>SAC: 0<br>DP: 0<br>HBP: 0 | WP: 0<br>PB: 0<br>SB: 0<br>CS: 0 | PA: 38 |
| <b>PITCHER</b>  | IP WLS BF H R ER SO BB IBB HBP BLK WP HR S P ERA WHIP |                                 |                              |                                 |                              |                                  |                              |                                  |                              |                                 |                              |                                 |                              |                                 |                              |                                 |                              |                                  |                                  |                                    |                                  |        |
| Diego Segui, R (1, 1)<br>ERA: 3.86                    | 8.1 W 35 6 1 1 7 5 0 0 0 0 0 1 44 64 1.08 1.320       |                                 |                              |                                 |                              |                                  |                              |                                  |                              |                                 |                              |                                 |                              |                                 |                              |                                 |                              |                                  |                                  |                                    |                                  |        |
| Ted Bowsfield, L (9, 1)<br>ERA: 6.75                  | 0.1 2 0 0 0 0 1 0 0 0 0 0 0 1 5 0.00 3.000            |                                 |                              |                                 |                              |                                  |                              |                                  |                              |                                 |                              |                                 |                              |                                 |                              |                                 |                              |                                  |                                  |                                    |                                  |        |
| John Wyatt, R (9, 1)<br>ERA: 1.69                     | 0.1 S 1 0 0 0 0 0 0 0 0 0 0 0 1 1 0.00 0.000          |                                 |                              |                                 |                              |                                  |                              |                                  |                              |                                 |                              |                                 |                              |                                 |                              |                                 |                              |                                  |                                  |                                    |                                  |        |

**New York Yankees @ Kansas City Athletics**  
Municipal Stadium, Kansas City, MO  
Fri May 29 1964, 8:05 PM EDT  
Att. 16,670 - Unknown

|     |    |
|-----|----|
| AB  | 32 |
| R   | 1  |
| H   | 6  |
| RBI | 1  |
| BB  | 6  |
| SO  | 7  |
| LOB | 17 |



| Batter  | 1                       | 2                   | 3          | 4        | 5          | 6                  | 7                        | 8            | 9 | AB | R | H | RBI | BB | SO | LOB |
|---|-------------------------|---------------------|------------|----------|------------|--------------------|--------------------------|--------------|---|----|---|---|-----|----|----|-----|
| Wayne Causey, L (1, 6)<br>OBP: 0.402, SLG: 0.349              | 0-0<br>1B<br>HR<br>1B   | 0-3<br>K            |            |          | 0-0<br>P5  |                    | 0-0<br>FC6-4<br>1B       |              |   | 4  | 1 | 2 | 1   | 0  | 1  | 1   |
| Nelson Mathews, R (1, 8)<br>OBP: 0.328, SLG: 0.380            | 0-0<br>P5               |                     | 0-0<br>1-3 |          | 0-0<br>6-3 |                    | 0-0<br>FC6-4             |              |   | 4  | 0 | 0 | 0   | 0  | 0  | 2   |
| George Alusik, R (1, 7)<br>OBP: 0.530, SLG: 0.511<br>(8, 3)   | 0-0<br>1-3<br>HR<br>1B  |                     | 0-0<br>6-3 |          |            | 0-0<br>F7          |                          | 0-0<br>1-6-3 |   | 4  | 1 | 1 | 0   | 0  | 0  | 0   |
| Rocky Colavito, R (1, 9)<br>OBP: 0.409, SLG: 0.642            | 0-0<br>1-H<br>3-H<br>HR |                     | 0-0<br>1B  |          |            | 4-0<br>FC6-4<br>BB |                          | 0-0<br>F8    |   | 3  | 1 | 2 | 3   | 1  | 0  | 0   |
| Ed Charles, R (1, 5)<br>OBP: 0.353, SLG: 0.331                | 0-0<br>P2               |                     | 0-0<br>F9  |          |            | 0-0<br>FC6-4       |                          | 0-0<br>5-3   |   | 4  | 0 | 0 | 0   | 0  | 0  | 2   |
| Charlie Lau, L (1, 2)<br>OBP: 0.340, SLG: 0.451               | 0-0<br>F7               |                     |            | 0-3<br>K |            | 0-0<br>3-1         |                          |              |   | 3  | 0 | 0 | 0   | 0  | 1  | 1   |
| Doc Edwards, R (1, 3)<br>OBP: 0.306, SLG: 0.333               |                         | 0-0<br>K2-6-2<br>1B |            |          | 0-0<br>L7  |                    | 0-0<br>F8<br>SH2-4<br>1B |              |   | 3  | 0 | 2 | 0   | 0  | 0  | 0   |
| Jose Tartabull, L (7, PR)<br>OBP: 0.167, SLG: 0.250<br>(8, 7) |                         |                     |            |          |            |                    |                          |              |   | 0  | 1 | 0 | 0   | 0  | 0  | 0   |
| Dick Green, R (1, 4)<br>OBP: 0.248, SLG: 0.338                |                         | 0-0<br>1-2<br>1B    |            |          | 0-0<br>4-3 |                    | 0-0<br>SH2-4             |              |   | 2  | 0 | 1 | 0   | 0  | 0  | 0   |
| Diego Segui, R (1, 1)<br>OBP: 0.238, SLG: 0.350               |                         | 0-3<br>K2-6-2       |            |          | 0-0<br>6-3 |                    | 0-0<br>F8                |              |   | 3  | 0 | 0 | 0   | 0  | 1  | 4   |
| Ted Bowsfield, R (9, 1)                                       |                         |                     |            |          |            |                    |                          |              |   | 0  | 0 | 0 | 0   | 0  | 0  | 0   |
| John Wyatt, R (9, 1)  |                         | 2-2                 |            |          |            |                    |                          |              |   | 0  | 0 | 0 | 0   | 0  | 0  | 0   |

| Inning Stats | R: 3 | H: 3 | LOB: 3 | K: 0 | BB: 0 | S: 6 | R: 0 | H: 2 | LOB: 1 | K: 2 | BB: 0 | S: 8 | R: 0 | H: 1 | LOB: 1 | K: 0 | BB: 0 | S: 4 | R: 0 | H: 0 | LOB: 0 | K: 1 | BB: 0 | S: 5 | R: 0 | H: 0 | LOB: 0 | K: 0 | BB: 0 | S: 3 | R: 0 | H: 0 | LOB: 1 | K: 0 | BB: 1 | S: 3 | R: 1 | H: 2 | LOB: 1 | K: 0 | BB: 0 | S: 5 | R: 0 | H: 0 | LOB: 0 | K: 0 | BB: 0 | S: 3 |
|--------------|------|------|--------|------|-------|------|------|------|--------|------|-------|------|------|------|--------|------|-------|------|------|------|--------|------|-------|------|------|------|--------|------|-------|------|------|------|--------|------|-------|------|------|------|--------|------|-------|------|------|------|--------|------|-------|------|
|--------------|------|------|--------|------|-------|------|------|------|--------|------|-------|------|------|------|--------|------|-------|------|------|------|--------|------|-------|------|------|------|--------|------|-------|------|------|------|--------|------|-------|------|------|------|--------|------|-------|------|------|------|--------|------|-------|------|

| PITCHER                              | IP  | WLS | BF | H | R | ER | SO | BB | IBB | HBP | BLK | WP | HR | S  | P  | ERA  | WHIP  |
|--------------------------------------|-----|-----|----|---|---|----|----|----|-----|-----|-----|----|----|----|----|------|-------|
| Jim Bouton, R (1, 1)<br>ERA: 3.2     | 6.0 | L   | 24 | 6 | 3 | 3  | 3  | 1  | 0   | 0   | 0   | 0  | 1  | 29 | 33 | 4.50 | 1.167 |
| Stan Williams, R (7, 1)<br>ERA: 5.28 | 2.0 |     | 8  | 2 | 1 | 1  | 0  | 0  | 0   | 0   | 0   | 0  | 0  | 8  | 8  | 4.50 | 1.000 |

**BOTTOM**

**New York Yankees @ Kansas City Athletics**  
Municipal Stadium, Kansas City, MO

Fri May 29 1964, 8:05 PM EDT  
Att. 16,670 - Unknown

livebaseballscorecards.com

|            |           |
|------------|-----------|
| <b>AB</b>  | <b>30</b> |
| <b>R</b>   | <b>4</b>  |
| <b>H</b>   | <b>8</b>  |
| <b>RBI</b> | <b>4</b>  |
| <b>BB</b>  | <b>1</b>  |
| <b>SO</b>  | <b>3</b>  |
| <b>LOB</b> | <b>10</b> |



| WP | HR | S | P  | ERA | WHIP |
|----|----|---|----|-----|------|
| 0  | 0  | 0 | 32 |     |      |

| Batter   | 1   | 2                               | 3                            | 4                               | 5                            | 6                               | 7                            | 8                               | 9                            | AB R H RBI BB SO LOB            | TOP                          |                                 |                              |                                 |                              |                                  |                              |                                  |                                   |                                    |                                  |        |
|--|---|---------------------------------|------------------------------|---------------------------------|------------------------------|---------------------------------|------------------------------|---------------------------------|------------------------------|---------------------------------|------------------------------|---------------------------------|------------------------------|---------------------------------|------------------------------|----------------------------------|------------------------------|----------------------------------|-----------------------------------|------------------------------------|----------------------------------|--------|
| Tony Kubek, L (1, 6)<br>OBP: 0.300, SLG: 0.349       | 0-0<br>G3   |                                 | 0-0<br>P4                    |                                 | 0-0<br>1B                    |                                 | 0-0<br>G3                    |                                 | 0-0<br>FC3-6<br>1B           | 5 0 2 1 0 0 1                   |                              |                                 |                              |                                 |                              |                                  |                              |                                  |                                   |                                    |                                  |        |
| Bobby Richardson, R (1, 4)<br>OBP: 0.322, SLG: 0.333 | 0-0<br>P1   |                                 | 0-0<br>FC4-6<br>1-2f         |                                 | 0-0<br>1-3                   |                                 | 0-0<br>L7                    |                                 | 0-0<br>FC3-6<br>1B<br>SF9    | 5 1 0 0 0 0 3                   |                              |                                 |                              |                                 |                              |                                  |                              |                                  |                                   |                                    |                                  |        |
| Hector Lopez, R (1, 7)<br>OBP: 0.324, SLG: 0.526     | 0-3<br>K  |                                 |                              | 0-0<br>5-3                      |                              | 0-0<br>FC4-6<br>1B<br>1B        | 0-0<br>P5                    |                                 | 0-0<br>SF9<br>1B<br>BB       | 5 2 2 0 0 1 0                   |                              |                                 |                              |                                 |                              |                                  |                              |                                  |                                   |                                    |                                  |        |
| Roger Maris, L (1, 9)<br>OBP: 0.361, SLG: 0.539      |   | 0-0<br>P6                       |                              | 0-0<br>P6                       |                              | 0-3<br>K                        |                              | 1-0<br>BB<br>E<br>HBP           | 4-0<br>1B<br>1B<br>BB        | 3 2 0 0 1 1 1                   |                              |                                 |                              |                                 |                              |                                  |                              |                                  |                                   |                                    |                                  |        |
| Tom Tresh, S (1, 8)<br>OBP: 0.344, SLG: 0.409        |   | 4-0<br>FC3-6<br>BB              |                              | 4-0<br>BB                       |                              | 0-0<br>FC4-6<br>1B              |                              | 4-0<br>E<br>BB                  | 0-0<br>SF9                   | 1 0 1 1 3 0 0                   |                              |                                 |                              |                                 |                              |                                  |                              |                                  |                                   |                                    |                                  |        |
| Joe Pepitone, L (1, 3)<br>OBP: 0.323, SLG: 0.422     |   | 0-0<br>FC3-6<br>1-2f            |                              | 0-0<br>F8                       |                              | 0-0<br>FC4-6<br>1B<br>HR        |                              | 0-0<br>L6                       | 0-0<br>1B<br>1B              | 5 1 1 1 0 0 6                   |                              |                                 |                              |                                 |                              |                                  |                              |                                  |                                   |                                    |                                  |        |
| Elston Howard, R (1, 2)<br>OBP: 0.409, SLG: 0.459    |   | 0-0<br>F9                       |                              |                                 | 0-0<br>1-3<br>1B<br>2B       | 0-0<br>1-2<br>HR<br>1B          |                              | 0-0<br>E8<br>1B                 | 0-0<br>1-3<br>1B             | 5 2 4 3 0 0 1                   |                              |                                 |                              |                                 |                              |                                  |                              |                                  |                                   |                                    |                                  |        |
| Clete Boyer, R (1, 5)<br>OBP: 0.259, SLG: 0.323      |   |                                 | 0-3<br>K                     |                                 | 0-3<br>K                     | 0-0<br>1-H<br>2-H<br>HR         |                              | 0-3<br>K2-3                     | 0-0<br>P5                    | 5 1 1 3 0 3 5                   |                              |                                 |                              |                                 |                              |                                  |                              |                                  |                                   |                                    |                                  |        |
| Whitey Ford, L (1, 1)<br>OBP: 0.286, SLG: 0.240      |   |                                 | 0-0<br>FC4-6<br>1B           |                                 | 0-0<br>1-3                   | 0-0<br>5-3                      |                              | 0-0<br>L7                       |                              | 4 0 1 0 0 0 3                   |                              |                                 |                              |                                 |                              |                                  |                              |                                  |                                   |                                    |                                  |        |
| <b>Inning Stats</b>                                  | R: 0<br>E: 0<br>K: 1<br>S: 5                          | H: 0<br>LOB: 0<br>BB: 0<br>P: 5 | R: 0<br>E: 0<br>K: 0<br>S: 3 | H: 0<br>LOB: 1<br>BB: 1<br>P: 7 | R: 0<br>E: 0<br>K: 1<br>S: 6 | H: 1<br>LOB: 1<br>BB: 0<br>P: 6 | R: 0<br>E: 0<br>K: 0<br>S: 3 | H: 0<br>LOB: 1<br>BB: 1<br>P: 7 | R: 1<br>E: 0<br>K: 1<br>S: 7 | H: 2<br>LOB: 1<br>BB: 0<br>P: 7 | R: 4<br>E: 0<br>K: 1<br>S: 9 | H: 4<br>LOB: 0<br>BB: 0<br>P: 9 | R: 0<br>E: 0<br>K: 0<br>S: 3 | H: 0<br>LOB: 0<br>BB: 0<br>P: 3 | R: 1<br>E: 1<br>K: 1<br>S: 6 | H: 1<br>LOB: 2<br>BB: 1<br>P: 11 | R: 3<br>E: 0<br>K: 0<br>S: 7 | H: 4<br>LOB: 2<br>BB: 1<br>P: 11 | 1B: 10<br>2B: 1<br>3B: 0<br>HR: 1 | SF: 1<br>SAC: 0<br>DP: 0<br>HBP: 1 | WP: 0<br>PB: 0<br>SB: 0<br>CS: 0 | PA: 44 |
| <b>PITCHER</b>                                       | IP WLS BF H R ER SO BB IBB HBP BLK WP HR S P ERA WHIP |                                 |                              |                                 |                              |                                 |                              |                                 |                              |                                 |                              |                                 |                              |                                 |                              |                                  |                              |                                  |                                   |                                    |                                  |        |
| Moe Drabowsky, R (1, 1)<br>ERA: 5.96                 | 7.0 L 30 7 5 5 4 2 0 0 0 0 0 1 36 44 6.43 1.286       |                                 |                              |                                 |                              |                                 |                              |                                 |                              |                                 |                              |                                 |                              |                                 |                              |                                  |                              |                                  |                                   |                                    |                                  |        |
| Joe Grzenda, L (8, 1)<br>ERA: 11.05                  | 1.0 6 1 1 1 1 1 0 1 0 0 0 6 11 9.00 2.000             |                                 |                              |                                 |                              |                                 |                              |                                 |                              |                                 |                              |                                 |                              |                                 |                              |                                  |                              |                                  |                                   |                                    |                                  |        |
| Vern Handrahan, R (9, 1)<br>ERA: 7.27                | 1.0 8 4 3 3 0 1 0 0 0 0 0 7 11 27.00 5.000            |                                 |                              |                                 |                              |                                 |                              |                                 |                              |                                 |                              |                                 |                              |                                 |                              |                                  |                              |                                  |                                   |                                    |                                  |        |

**New York Yankees @ Kansas City Athletics**  
Municipal Stadium, Kansas City, MO

Sat May 30 1964, 8:05 PM EDT  
Att. 20,989 - Overcast - 60 F

|     |    |
|-----|----|
| AB  | 38 |
| R   | 9  |
| H   | 12 |
| RBI | 9  |
| BB  | 4  |
| SO  | 5  |
| LOB | 20 |



|       |        |
|-------|--------|
| WP: 0 | PA: 44 |
|-------|--------|



| Batter   | 1          | 2                     | 3                                       | 4          | 5          | 6          | 7          | 8                    | 9          | AB | R | H | RBI | BB | SO | LOB |
|--|------------|-----------------------|---|------------|------------|------------|------------|----------------------|------------|----|---|---|-----|----|----|-----|
| Wayne Causey, L (1, 6)<br>OBP: 0.404, SLG: 0.353   | 0-3<br>K   |                       | 0-0<br>E BB<br>1-2<br>1B                |            | 0-0<br>5-3 |            |            | 0-0<br>FC6-4<br>1B   |            | 4  | 0 | 2 | 0   | 0  | 1  | 0   |
| Nelson Mathews, R (1, 8)<br>OBP: 0.331, SLG: 0.379   | 0-0<br>5-3 |                       | 4-0<br>E<br>1-2<br>2-3<br>BB            |            |            | 0-0<br>1B  |            | 0-0<br>L5            |            | 3  | 0 | 1 | 0   | 1  | 0  | 1   |
| George Alusik, R (1, 7)<br>OBP: 0.500, SLG: 0.471  | 0-0<br>P4  |                       | 0-0<br>E5<br>FC6-4<br>1-2<br>2-3<br>3-H |            |            | 0-3<br>K   |            | 0-0<br>FC6-4<br>1-2f |            | 4  | 0 | 0 | 0   | 0  | 1  | 4   |
| Rocky Colavito, R (1, 9)<br>OBP: 0.405, SLG: 0.630   |            | 0-0<br>G5-4-3<br>1B   | 0-0<br>FC6-4<br>1-2f                    |            |            | 0-0<br>L8  |            |                      | 0-0<br>P3  | 4  | 0 | 1 | 0   | 0  | 0  | 4   |
| Ed Charles, R (1, 5)<br>OBP: 0.345, SLG: 0.322   | 0-3<br>K   |                       |   | 0-3<br>K   |            | 0-0<br>5-3 |            |                      | 0-0<br>F8  | 4  | 0 | 0 | 0   | 0  | 2  | 2   |
| Doc Edwards, R (1, 3)<br>OBP: 0.288, SLG: 0.313  |            | 0-0<br>G5-4-3<br>1-2f |   | 0-0<br>6-3 |            |            | 0-0<br>P6  |                      | 0-0<br>6-3 | 4  | 0 | 0 | 0   | 0  | 0  | 1   |
| Dick Green, R (1, 4)<br>OBP: 0.243, SLG: 0.331   |            |                       | 0-0<br>P4                               | 0-0<br>L8  |            |            | 0-0<br>2-3 |                      |            | 3  | 0 | 0 | 0   | 0  | 0  | 0   |
| Charlie Lau, L (1, 2)<br>OBP: 0.340, SLG: 0.447  |            |                       | 0-0<br>BB<br>E<br>1B<br>1B              |            | 0-0<br>L9  |            | 0-0<br>3-1 |                      |            | 3  | 1 | 1 | 0   | 0  | 0  | 0   |
| Moe Drabowsky, R (1, 1)<br>OBP: 0.053, SLG: 0.053<br>Joe Grzenda, R (8, 1)<br>George Williams, R (8, PH)<br>OBP: 0.174, SLG: 0.095<br>Vern Handrahan, L (9, 1) |            |                       | 0-3<br>K                                |            | 0-3<br>K   |            |            | 0-3<br>K             |            | 2  | 0 | 0 | 0   | 0  | 2  | 1   |

| Inning Stats | R: 0 | H: 0 | E: 0 | K: 1 | S: 5 | R: 0 | H: 1 | E: 0 | K: 1 | S: 5 | R: 0 | H: 0 | E: 0 | K: 1 | S: 5 | R: 0 | H: 0 | E: 0 | K: 1 | S: 5 | R: 0 | H: 1 | E: 0 | K: 0 | S: 3 | R: 0 | H: 0 | E: 0 | K: 1 | S: 6 | R: 0 | H: 1 | E: 0 | K: 1 | S: 6 | R: 0 | H: 0 | E: 0 | K: 0 | S: 3 | R: 0 | H: 0 | E: 0 | K: 0 | S: 3 |   |
|--------------|------|------|------|------|------|------|------|------|------|------|------|------|------|------|------|------|------|------|------|------|------|------|------|------|------|------|------|------|------|------|------|------|------|------|------|------|------|------|------|------|------|------|------|------|------|---|
|              | 0    | 0    | 0    | 1    | 5    | 0    | 1    | 0    | 1    | 5    | 0    | 0    | 0    | 1    | 5    | 0    | 1    | 0    | 0    | 1    | 5    | 0    | 1    | 0    | 0    | 3    | 0    | 0    | 0    | 1    | 6    | 0    | 1    | 0    | 0    | 6    | 0    | 0    | 0    | 0    | 3    | 0    | 0    | 0    | 0    | 3 |

**BOTTOM**

**New York Yankees @ Kansas City Athletics**  
Municipal Stadium, Kansas City, MO

Sat May 30 1964, 8:05 PM EDT  
Att. 20,989 - Overcast - 60 F

|     |    |
|-----|----|
| AB  | 32 |
| R   | 1  |
| H   | 5  |
| RBI | 0  |
| BB  | 1  |
| SO  | 7  |
| LOB | 13 |



| PITCHER                            | IP  | WLS | BF | H | R | ER | SO | BB | IBB | HBP | BLK | WP | HR | S  | P  | ERA  | WHIP  |
|------------------------------------|-----|-----|----|---|---|----|----|----|-----|-----|-----|----|----|----|----|------|-------|
| Whitey Ford, L (1, 1)<br>ERA: 1.69 | 9.0 | W   | 33 | 5 | 1 | 0  | 7  | 1  | 0   | 0   | 0   | 0  | 0  | 46 | 50 | 0.00 | 0.667 |

| Batter   | 1   | 2                               | 3                            | 4                               | 5                            | 6                               | 7                            | 8                               | 9                            | AB R H RBI BB SO LOB   | TOP                          |                                 |                              |                                 |                              |                                 |                              |                                 |                                   |                                    |                                  |        |
|--|---|---------------------------------|------------------------------|---------------------------------|------------------------------|---------------------------------|------------------------------|---------------------------------|------------------------------|--|------------------------------|---------------------------------|------------------------------|---------------------------------|------------------------------|---------------------------------|------------------------------|---------------------------------|-----------------------------------|------------------------------------|----------------------------------|--------|
| Tony Kubek, L (1, 6)<br>OBP: 0.293, SLG: 0.338   | 0-0<br>FC1-6<br>1B                                    |                                 |                              | 0-0<br>P6                       |                              | 0-0<br>F7                       | 0-0<br>F8                    |                                 | 0-0<br>F7                    | 5 0 1 0 0 0 3  |                              |                                 |                              |                                 |                              |                                 |                              |                                 |                                   |                                    |                                  |        |
| Bobby Richardson, R (1, 4)<br>OBP: 0.320, SLG: 0.331   | 0-0<br>FC1-6<br>1-2f<br>G5-4-3                        |                                 |                              | 0-0<br>6-3                      |                              | 0-0<br>F7                       |                              | 0-0<br>L4-6<br>BB<br>1B         |                              | 4 0 1 0 0 0 1  |                              |                                 |                              |                                 |                              |                                 |                              |                                 |                                   |                                    |                                  |        |
| Hector Lopez, R (1, 7)<br>OBP: 0.330, SLG: 0.525   | 0-0<br>G5-4-3<br>1-2f                                 |                                 |                              | 0-0<br>1B                       |                              | 0-0<br>1B                       |                              | 0-0<br>P6                       |                              | 4 0 2 0 0 0 2  |                              |                                 |                              |                                 |                              |                                 |                              |                                 |                                   |                                    |                                  |        |
| Roger Maris, L (1, 9)<br>OBP: 0.356, SLG: 0.522  |   | 0-0<br>4-3                      |                              | 0-0<br>P4                       |                              | 0-0<br>G3                       |                              | 4-0<br>BB<br>1-2                |                              | 3 0 0 0 1 0 2  |                              |                                 |                              |                                 |                              |                                 |                              |                                 |                                   |                                    |                                  |        |
| Tom Tresh, S (1, 8)<br>OBP: 0.333, SLG: 0.395  |   | 0-0<br>F8                       |                              |                                 | 0-0<br>L7                    |                                 | 0-0<br>L9                    | 0-0<br>L4-6<br>2-3              |                              | 4 0 0 0 0 0 2  |                              |                                 |                              |                                 |                              |                                 |                              |                                 |                                   |                                    |                                  |        |
| Elston Howard, R (1, 2)<br>OBP: 0.404, SLG: 0.452  |   | 0-0<br>F9                       |                              |                                 | 0-0<br>5-3<br>1B<br>1B       |                                 | 0-0<br>4-3                   |                                 | 0-0<br>F8                    | 4 0 1 0 0 0 0  |                              |                                 |                              |                                 |                              |                                 |                              |                                 |                                   |                                    |                                  |        |
| Joe Pepitone, L (1, 3)<br>OBP: 0.333, SLG: 0.430   |   |                                 | 0-0<br>G3                    |                                 | 0-0<br>5-3<br>1-2<br>1B      |                                 | 0-0<br>1B<br>1B              |                                 | 0-0<br>1B<br>1B              | 4 1 3 0 0 0 0  |                              |                                 |                              |                                 |                              |                                 |                              |                                 |                                   |                                    |                                  |        |
| Clete Boyer, R (1, 5)<br>OBP: 0.259, SLG: 0.320  |   |                                 | 0-0<br>6-3                   |                                 | 0-0<br>5-3<br>1-2<br>2-3     |                                 | 0-0<br>1B<br>1B              |                                 | 0-3<br>K                     | 4 1 1 0 0 1 3  |                              |                                 |                              |                                 |                              |                                 |                              |                                 |                                   |                                    |                                  |        |
| Al Downing, R (1, 1)<br>OBP: 0.235, SLG: 0.353<br>Mickey Mantle, S (7, PH)<br>Pedro Gonzalez, R (7, PR)<br>Hal Reniff, R (7, 1)<br>Johnny Blanchard, L (9, PH)<br>Phil Lutz, R (9, PR)<br>OBP: 0.419, SLG: 0.406<br>OBP: 0.268, SLG: 0.264 |   |                                 | 0-3<br>K                     |                                 | 0-3<br>K2-3                  |                                 | 0-0<br>1B<br>1-H<br>2-H      |                                 | 0-0<br>1B                    | 2 0 0 0 0 2 2<br>1 0 1 2 0 0 0<br>0 0 0 0 0 0 0<br>0 0 0 0 0 0 0<br>1 0 1 0 0 0 0<br>0 0 0 0 0 0 0 |                              |                                 |                              |                                 |                              |                                 |                              |                                 |                                   |                                    |                                  |        |
| <b>Inning Stats</b>  | R: 0<br>E: 0<br>K: 0<br>S: 3                          | H: 1<br>LOB: 0<br>BB: 0<br>P: 3 | R: 0<br>E: 0<br>K: 0<br>S: 3 | H: 0<br>LOB: 0<br>BB: 0<br>P: 3 | R: 0<br>E: 0<br>K: 1<br>S: 5 | H: 0<br>LOB: 0<br>BB: 0<br>P: 5 | R: 0<br>E: 0<br>K: 0<br>S: 4 | H: 1<br>LOB: 1<br>BB: 0<br>P: 4 | R: 0<br>E: 0<br>K: 1<br>S: 7 | H: 2<br>LOB: 2<br>BB: 0<br>P: 7  | R: 0<br>E: 0<br>K: 0<br>S: 4 | H: 1<br>LOB: 1<br>BB: 0<br>P: 4 | R: 2<br>E: 0<br>K: 0<br>S: 6 | H: 3<br>LOB: 1<br>BB: 0<br>P: 6 | R: 0<br>E: 0<br>K: 0<br>S: 3 | H: 1<br>LOB: 1<br>BB: 1<br>P: 7 | R: 0<br>E: 0<br>K: 1<br>S: 7 | H: 2<br>LOB: 2<br>BB: 0<br>P: 7 | 1B: 11<br>2B: 1<br>3B: 0<br>HR: 0 | SF: 0<br>SAC: 0<br>DP: 2<br>HBP: 0 | WP: 0<br>PB: 0<br>SB: 0<br>CS: 0 | PA: 37 |
| <b>PITCHER</b>   | IP WLS BF H R ER SO BB IBB HBP BLK WP HR S P ERA WHIP |                                 |                              |                                 |                              |                                 |                              |                                 |                              |  |                              |                                 |                              |                                 |                              |                                 |                              |                                 |                                   |                                    |                                  |        |
| John O'Donoghue, L (1, 1)<br>ERA: 4.44   | 7.0 W 28 8 2 2 2 0 0 0 0 0 0 0 32 32 2.57 1.143       |                                 |                              |                                 |                              |                                 |                              |                                 |                              |  |                              |                                 |                              |                                 |                              |                                 |                              |                                 |                                   |                                    |                                  |        |
| John Wyatt, R (8, 1)<br>ERA: 1.57  | 2.0 S 9 3 0 0 1 1 0 0 0 0 0 0 10 14 0.00 2.000        |                                 |                              |                                 |                              |                                 |                              |                                 |                              |  |                              |                                 |                              |                                 |                              |                                 |                              |                                 |                                   |                                    |                                  |        |

**New York Yankees @ Kansas City Athletics**  
Municipal Stadium, Kansas City, MO  
Sun May 31 1964, 4:33 AM EDT  
Att. 18,764 - Unknown

[livebaseballscorecards.com](http://livebaseballscorecards.com)

|     |    |
|-----|----|
| AB  | 36 |
| R   | 2  |
| H   | 11 |
| RBI | 2  |
| BB  | 1  |
| SO  | 3  |
| LOB | 15 |



| Batter | 1 | 2 | 3 | 4 | 5 | 6 | 7 | 8 | 9 | AB | R | H | RBI | BB | SO | LOB |
|--------|---|---|---|---|---|---|---|---|---|----|---|---|-----|----|----|-----|
|--------|---|---|---|---|---|---|---|---|---|----|---|---|-----|----|----|-----|

|   |                       |          |                     |                   |           |                 |                       |                     |  |   |   |   |   |   |   |   |
|---|-----------------------|----------|---------------------|-------------------|-----------|-----------------|-----------------------|---------------------|--|---|---|---|---|---|---|---|
| Wayne Causey, L<br>OBP: 0.406, SLG: 0.375<br>(1, 6)   | 0-0<br>G5-4-3<br>1B   |          | 0-0<br>4-3          |                   |           | 0-0<br>P5       | 0-0<br>HR             |                     |  | 4 | 1 | 2 | 3 | 0 | 0 | 1 |
| Nelson Mathews, R<br>OBP: 0.324, SLG: 0.370<br>(1, 8)   | 0-0<br>B2             |          |                     | 0-0<br>6-3        |           | 0-3<br>K        | 0-0<br>P4             |                     |  | 4 | 0 | 0 | 0 | 0 | 1 | 2 |
| George Alusik, R<br>OBP: 0.493, SLG: 0.463<br>Billy Bryan, L<br>OBP: 0.333, SLG: 0.600<br>(1, 7)<br>(8, 2)  | 0-0<br>G5-4-3<br>1-2f |          |                     | 0-0<br>F7         |           | 0-0<br>WP<br>1B |                       | 0-0<br>SH1-4<br>1B  |  | 3 | 1 | 1 | 0 | 0 | 0 | 1 |
| Rocky Colavito, R<br>OBP: 0.410, SLG: 0.638<br>(1, 9)   |                       | 0-3<br>K |                     | 0-0<br>WP<br>2B   |           | 0-0<br>1B       |                       | 0-0<br>SH1-4<br>1-2 |  | 3 | 0 | 2 | 1 | 0 | 1 | 0 |
| Ed Charles, R<br>OBP: 0.337, SLG: 0.313<br>(1, 5)   |                       | 0-3<br>K |                     | 0-0<br>6-3<br>2-3 |           | 0-0<br>6-3      |                       | 0-0<br>F8           |  | 4 | 0 | 0 | 0 | 0 | 1 | 3 |
| Doc Edwards, R<br>OBP: 0.271, SLG: 0.294<br>(1, 3)  |                       |          | 0-0<br>P5           |                   | 0-0<br>P6 |                 | 0-0<br>F7             | 0-0<br>6-3          |  | 4 | 0 | 0 | 0 | 0 | 0 | 1 |
| Dick Green, R<br>OBP: 0.245, SLG: 0.331<br>(1, 4)   |                       |          | 0-0<br>SH3-4<br>1B  |                   | 0-0<br>P6 |                 | 0-3<br>K              |                     |  | 3 | 0 | 1 | 0 | 0 | 1 | 0 |
| Charlie Lau, L<br>OBP: 0.349, SLG: 0.448<br>Jose Tartabull, L<br>OBP: 0.167, SLG: 0.250<br>(1, 2)<br>(7, PR)<br>(8, 7)  |                       |          | 0-3<br>K            |                   | 0-0<br>1B |                 | 4-0<br>BB<br>HR<br>BB |                     |  | 2 | 0 | 1 | 0 | 1 | 1 | 1 |
| John O'Donoghue, R<br>OBP: 0.333, SLG: 0.333<br>Jim Gentile, L<br>OBP: 0.392, SLG: 0.533<br>Moe Drabowsky, R<br>OBP: 0.053, SLG: 0.053<br>John Wyatt, R<br>(1, 1)<br>(7, PH)<br>(7, PR)<br>(8, 1) |                       |          | 0-0<br>SH3-4<br>1-2 |                   | 0-0<br>G3 |                 | 4-0<br>BB<br>HR<br>BB |                     |  | 1 | 0 | 0 | 0 | 0 | 0 | 1 |

| Inning Stats | R: 0 | H: 1 | E: 0 | K: 0 | S: 3 | R: 0 | H: 0 | E: 0 | K: 2 | S: 7 | R: 0 | H: 1 | E: 0 | K: 1 | S: 6 | R: 0 | H: 1 | E: 0 | K: 0 | S: 4 | R: 0 | H: 1 | E: 0 | K: 0 | S: 4 | R: 1 | H: 2 | E: 0 | K: 1 | S: 7 | R: 3 | H: 1 | E: 0 | K: 1 | S: 6 | R: 0 | H: 1 | E: 0 | K: 0 | S: 4 | 1B: 6 | SF: 0 | 2B: 1 | SAC: 2 | 3B: 0 | DP: 1 | HR: 1 | HBP: 0 | WP: 2 | PA: 33 |
|--------------|------|------|------|------|------|------|------|------|------|------|------|------|------|------|------|------|------|------|------|------|------|------|------|------|------|------|------|------|------|------|------|------|------|------|------|------|------|------|------|------|-------|-------|-------|--------|-------|-------|-------|--------|-------|--------|
|--------------|------|------|------|------|------|------|------|------|------|------|------|------|------|------|------|------|------|------|------|------|------|------|------|------|------|------|------|------|------|------|------|------|------|------|------|------|------|------|------|------|-------|-------|-------|--------|-------|-------|-------|--------|-------|--------|

| PITCHER                              | IP  | WLS | BF | H | R | ER | SO | BB | IBB | HBP | BLK | WP | HR | S  | P  | ERA   | WHIP  |
|--------------------------------------|-----|-----|----|---|---|----|----|----|-----|-----|-----|----|----|----|----|-------|-------|
| Al Downing, L<br>ERA: 3.12<br>(1, 1) | 6.0 |     | 23 | 6 | 1 | 1  | 4  | 0  | 0   | 0   | 0   | 2  | 0  | 31 | 31 | 1.50  | 1.000 |
| Hal Reniff, R<br>ERA: 3.42<br>(7, 1) | 2.0 | L   | 10 | 2 | 3 | 3  | 1  | 2  | 0   | 0   | 0   | 0  | 1  | 10 | 18 | 13.50 | 2.000 |

**BOTTOM**

**New York Yankees @ Kansas City Athletics**  
**Municipal Stadium, Kansas City, MO**  
 Sun May 31 1964, 4:33 AM EDT  
 Att. 18,764 - Unknown

|            |           |
|------------|-----------|
| <b>AB</b>  | <b>29</b> |
| <b>R</b>   | <b>4</b>  |
| <b>H</b>   | <b>8</b>  |
| <b>RBI</b> | <b>4</b>  |
| <b>BB</b>  | <b>2</b>  |
| <b>SO</b>  | <b>5</b>  |
| <b>LOB</b> | <b>10</b> |

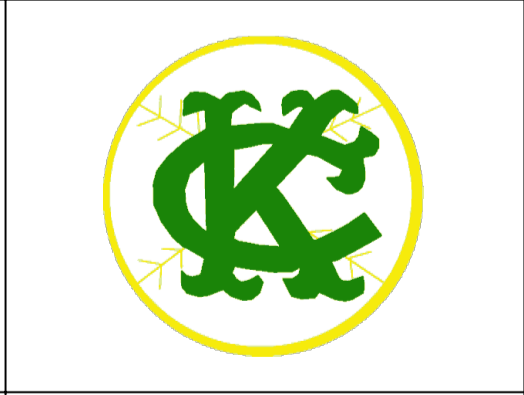

| WP | HR | S  | P  | ERA   | WHIP  |
|----|----|----|----|-------|-------|
| 2  | 1  | 14 | 14 | 13.50 | 2.000 |

| Batter   | 1   | 2                               | 3                            | 4                               | 5                            | 6                                | 7                            | 8                               | 9                            | AB R H RBI BB SO LOB             | TOP                          |                                 |                              |                                 |                              |                                 |                                  |                                    |                                  |        |
|--|---|---------------------------------|------------------------------|---------------------------------|------------------------------|----------------------------------|------------------------------|---------------------------------|------------------------------|----------------------------------|------------------------------|---------------------------------|------------------------------|---------------------------------|------------------------------|---------------------------------|----------------------------------|------------------------------------|----------------------------------|--------|
| Jerry Adair, R (1, 4)<br>OBP: 0.271, SLG: 0.280          | 0-3<br>K  |                                 | 0-0<br>BB<br>1B              | 0-0<br>FC1-6<br>4-3<br>1B       | 0-0<br>6-3                   |                                  |                              | 0-0<br>6-3                      |                              | 5 1 2 0 0 1 2                    |                              |                                 |                              |                                 |                              |                                 |                                  |                                    |                                  |        |
| Luis Aparicio, R (1, 6)<br>OBP: 0.333, SLG: 0.362        | 0-0<br>F9   |                                 | 4-0<br>1B<br>E<br>BB         | 0-0<br>4-3                      |                              | 0-0<br>F8<br>FC6-2<br>1B         |                              | 0-0<br>HR                       |                              | 4 2 2 1 1 0 1                    |                              |                                 |                              |                                 |                              |                                 |                                  |                                    |                                  |        |
| Sam Bowens, R (1, 9)<br>(9, 7)<br>OBP: 0.331, SLG: 0.438 | 0-3<br>K  |                                 | 0-3<br>K                     | 4-0<br>FC1-6<br>BB              |                              | 0-0<br>F8                        |                              | 0-0<br>5-3                      |                              | 4 0 0 0 1 2 4                    |                              |                                 |                              |                                 |                              |                                 |                                  |                                    |                                  |        |
| Norm Siebern, L (1, 3)<br>OBP: 0.408, SLG: 0.404         |   | 4-0<br>1B<br>SF7<br>BB          | 0-0<br>E9<br>WP<br>1B        | 0-0<br>FC1-6                    |                              | 0-0<br>FC6-2                     |                              | 4-0<br>1B<br>SF7-6-3<br>BB      |                              | 3 3 1 2 2 0 3                    |                              |                                 |                              |                                 |                              |                                 |                                  |                                    |                                  |        |
| Brooks Robinson, R (1, 5)<br>OBP: 0.346, SLG: 0.426      |   | 0-0<br>1B                       | 0-0<br>F4                    | 0-0<br>1-3                      |                              | 0-0<br>1-3                       |                              | 0-0<br>SF7-6-3<br>1B            |                              | 5 0 2 0 0 0 4                    |                              |                                 |                              |                                 |                              |                                 |                                  |                                    |                                  |        |
| Boog Powell, L (1, 7)<br>OBP: 0.353, SLG: 0.488          |   | 0-0<br>F2                       | 4-0<br>WP<br>1B<br>BB        |                                 | 4-0<br>WP<br>BB              |                                  | 0-0<br>6-3                   |                                 | 0-0<br>SF7-6-3               | 2 1 0 0 2 0 2                    |                              |                                 |                              |                                 |                              |                                 |                                  |                                    |                                  |        |
| Gino Cimoli, R (9, PH)<br>(9, 9)                         |   |                                 |                              |                                 |                              |                                  |                              |                                 | 1-2<br>3-H                   | 0 0 0 1 0 0 0                    |                              |                                 |                              |                                 |                              |                                 |                                  |                                    |                                  |        |
| Willie Kirkland, L (1, 8)<br>OBP: 0.313, SLG: 0.260      |   | 0-0<br>SF7                      | 4-0<br>WP<br>1B<br>IBB       |                                 | 4-0<br>WP<br>BB              |                                  | 0-3<br>K                     |                                 | 0-0<br>F6                    | 2 0 0 1 2 1 0                    |                              |                                 |                              |                                 |                              |                                 |                                  |                                    |                                  |        |
| Dick Brown, R (1, 2)<br>OBP: 0.288, SLG: 0.400           |   | 3-H<br>F7                       | 0-0<br>WP<br>1B              |                                 | 0-3<br>K                     |                                  | 0-0<br>5-3                   |                                 |                              | 4 0 1 2 0 1 3                    |                              |                                 |                              |                                 |                              |                                 |                                  |                                    |                                  |        |
| Wally Bunker, R (1, 1)<br>OBP: 0.211, SLG: 0.222         |   |                                 | 0-0<br>BB<br>1B              |                                 | 0-3<br>K                     |                                  |                              | 0-3<br>K                        |                              | 3 1 1 0 0 1 4                    |                              |                                 |                              |                                 |                              |                                 |                                  |                                    |                                  |        |
| Dick Hall, R (6, 1)<br>OBP: 0.400, SLG: 0.250            |   |                                 |                              |                                 |                              |                                  |                              |                                 |                              | 1 0 0 0 0 1 0                    |                              |                                 |                              |                                 |                              |                                 |                                  |                                    |                                  |        |
| <b>Inning Stats</b>                                      | R: 0<br>E: 0<br>K: 2<br>S: 7                          | H: 0<br>LOB: 0<br>BB: 0<br>P: 7 | R: 1<br>E: 0<br>K: 0<br>S: 4 | H: 1<br>LOB: 1<br>BB: 1<br>P: 8 | R: 5<br>E: 1<br>K: 1<br>S: 9 | H: 4<br>LOB: 2<br>BB: 3<br>P: 21 | R: 0<br>E: 0<br>K: 0<br>S: 4 | H: 1<br>LOB: 2<br>BB: 1<br>P: 8 | R: 0<br>E: 0<br>K: 2<br>S: 7 | H: 0<br>LOB: 2<br>BB: 2<br>P: 15 | R: 0<br>E: 0<br>K: 1<br>S: 5 | H: 0<br>LOB: 0<br>BB: 0<br>P: 5 | R: 1<br>E: 0<br>K: 1<br>S: 6 | H: 1<br>LOB: 0<br>BB: 0<br>P: 6 | R: 1<br>E: 0<br>K: 0<br>S: 3 | H: 1<br>LOB: 0<br>BB: 1<br>P: 7 | 1B: 8<br>2B: 1<br>3B: 0<br>HR: 1 | SF: 2<br>SAC: 0<br>DP: 1<br>HBP: 0 | WP: 3<br>PB: 0<br>SB: 1<br>CS: 0 | PA: 43 |
| <b>PITCHER</b>   | IP WLS BF H R ER SO BB IBB HBP BLK WP HR S P ERA WHIP |                                 |                              |                                 |                              |                                  |                              |                                 |                              |                                  |                              |                                 |                              |                                 |                              |                                 |                                  |                                    |                                  |        |
| Aurelio Montague, R (1, 1)<br>ERA: 8.69                  | 2.1 L 13 4 5 5 3 2 0 0 0 0 0 0 17 25 19.29 2.571      |                                 |                              |                                 |                              |                                  |                              |                                 |                              |                                  |                              |                                 |                              |                                 |                              |                                 |                                  |                                    |                                  |        |
| Moe Drabowsky, R (3, 1)<br>ERA: 6.06                     | 0.2 5 1 1 1 0 1 1 0 0 2 0 3 11 13.50 3.000            |                                 |                              |                                 |                              |                                  |                              |                                 |                              |                                  |                              |                                 |                              |                                 |                              |                                 |                                  |                                    |                                  |        |
| Vern Handrahan, R (4, 1)<br>ERA: 6.75                    | 2.0 10 1 0 0 2 3 0 0 0 1 0 11 23 0.00 2.000           |                                 |                              |                                 |                              |                                  |                              |                                 |                              |                                  |                              |                                 |                              |                                 |                              |                                 |                                  |                                    |                                  |        |
| Joe Grzenda, L (6, 1)<br>ERA: 8.68                       | 2.0 7 1 0 0 1 0 0 0 0 0 0 9 9 0.00 0.500              |                                 |                              |                                 |                              |                                  |                              |                                 |                              |                                  |                              |                                 |                              |                                 |                              |                                 |                                  |                                    |                                  |        |
| Ted Bowfield, L (8, 1)<br>ERA: 7.04                      | 2.0 8 2 2 2 1 1 0 0 0 0 1 9 13 9.00 1.500             |                                 |                              |                                 |                              |                                  |                              |                                 |                              |                                  |                              |                                 |                              |                                 |                              |                                 |                                  |                                    |                                  |        |

**Baltimore Orioles @ Kansas City Athletics**  
Municipal Stadium, Kansas City, MO  
Mon Jun 01 1964, 8:05 PM EDT  
Att. 4,310 - Unknown

[livebaseballscorecards.com](http://livebaseballscorecards.com)

|     |    |
|-----|----|
| AB  | 33 |
| R   | 8  |
| H   | 9  |
| RBI | 7  |
| BB  | 8  |
| SO  | 7  |
| LOB | 23 |



**BOTTOM**

**Baltimore Orioles @ Kansas City Athletics**  
**Municipal Stadium, Kansas City, MO**  
 Mon Jun 01 1964, 8:05 PM EDT  
 Att. 4,310 - Unknown

|     |    |
|-----|----|
| AB  | 34 |
| R   | 4  |
| H   | 6  |
| RBI | 4  |
| BB  | 2  |
| SO  | 4  |
| LOB | 13 |



|       |        |
|-------|--------|
| WP: 0 | PA: 36 |
| PB: 0 | ERA    |
| SB: 0 | WHIP   |
| CS: 0 |        |

AB R H RBI BB SO LOB

|   |   |   |   |   |   |   |
|---|---|---|---|---|---|---|
| 4 | 0 | 1 | 0 | 0 | 0 | 1 |
| 4 | 1 | 3 | 2 | 0 | 0 | 1 |
| 4 | 1 | 0 | 0 | 0 | 0 | 3 |
| 3 | 1 | 0 | 0 | 1 | 0 | 1 |
| 3 | 0 | 0 | 0 | 1 | 0 | 1 |
| 4 | 0 | 1 | 2 | 0 | 1 | 1 |
| 4 | 0 | 0 | 0 | 0 | 1 | 3 |
| 4 | 0 | 0 | 0 | 0 | 0 | 2 |
| 0 | 0 | 0 | 0 | 0 | 0 | 0 |
| 0 | 1 | 1 | 0 | 0 | 0 | 0 |
| 0 | 0 | 0 | 0 | 0 | 0 | 0 |
| 1 | 0 | 0 | 0 | 0 | 0 | 0 |
| 1 | 0 | 0 | 0 | 0 | 0 | 0 |
| 1 | 0 | 0 | 0 | 0 | 0 | 0 |
| 1 | 0 | 0 | 0 | 0 | 0 | 0 |
| 1 | 0 | 0 | 0 | 0 | 0 | 0 |
| 1 | 0 | 0 | 0 | 0 | 0 | 0 |

|       |        |
|-------|--------|
| 1B: 4 | SF: 0  |
| 2B: 1 | SAC: 0 |
| 3B: 0 | DP: 0  |
| HR: 1 | HBP: 0 |

| Batter   | 1       | 2       | 3          | 4       | 5       | 6                  | 7         | 8       | 9      |
|--|---------|---------|------------|---------|---------|--------------------|-----------|---------|--------|
| Jose Tartabull, L (1, 8)<br>OBP: 0.188, SLG: 0.250   | 0-0 4-3 |         | 0-0 F7     |         | 0-0 4-3 |                    | 0-0 E3 1B |         |        |
| Wayne Causey, L (1, 6)<br>OBP: 0.413, SLG: 0.409   | 0-0 2B  |         | 0-0 1-H HR |         |         | 0-0 FC5-4 1B       | 0-0 F7    |         |        |
| George Alusik, R (1, 7)<br>OBP: 0.468, SLG: 0.431  | 0-0 F8  |         | 0-0 F7     |         |         | 0-0 FC5-4 1B BB BB | 0-0 F5    |         |        |
| Rocky Colavito, R (1, 9)<br>OBP: 0.406, SLG: 0.624   | 0-0 2-3 |         |            | 0-0 E7  |         | 4-0 1-2 1B BB BB   |           | 0-0 L6  |        |
| Charlie Lau, L (1, 2)<br>OBP: 0.345, SLG: 0.434  |         | 0-0 F9  |            | 0-0 F7  |         | 4-0 1-2 2-3 1B BB  |           | 0-0 4-3 |        |
| Ed Charles, R (1, 5)<br>OBP: 0.335, SLG: 0.312   |         | 0-0 5-3 |            | 0-3 K   |         | 0-0 1-2 2-H 3-H 1B |           | 0-0 F8  |        |
| Doc Edwards, R (1, 3)<br>OBP: 0.257, SLG: 0.278  |         | 0-0 F8  |            | 0-0 5-3 |         | 0-0 F4             |           | 0-3 K   |        |
| Dick Green, R (1, 4)<br>OBP: 0.239, SLG: 0.322   |         |         | 0-0 6-3    |         | 0-0 1-3 | 0-0 F8             |           | 0-0 5-3 |        |
| Aurelio Monteagudo, R<br>Moe Drabowsky, R<br>Billy Bryan, L<br>Vern Harshbarger, L<br>George Williams, R<br>Joe Girlanda, R<br>Nelson Mathews, R<br>Ted Bowsfield, R<br>Jim Gentile, L |         |         | 0-0 HR 1B  |         | 0-3 K   |                    | 0-3 K     |         | 0-0 F5 |

| Inning Stats | R: 0 | H: 1 | E: 0 | LOB: 1 | K: 0 | S: 4 | P: 4 | R: 0 | H: 0 | E: 0 | LOB: 0 | K: 0 | S: 3 | P: 3 | R: 2 | H: 2 | E: 0 | LOB: 0 | K: 0 | S: 5 | P: 5 | R: 0 | H: 0 | E: 1 | LOB: 1 | K: 1 | S: 6 | P: 6 | R: 0 | H: 0 | E: 0 | LOB: 0 | K: 1 | S: 5 | P: 5 | R: 2 | H: 2 | E: 0 | LOB: 2 | K: 0 | S: 5 | P: 13 | R: 0 | H: 1 | E: 1 | LOB: 1 | K: 1 | S: 6 | P: 6 | R: 0 | H: 0 | E: 0 | LOB: 0 | K: 0 | S: 3 | P: 3 | R: 0 | H: 0 | E: 0 | LOB: 0 | K: 1 | S: 5 | P: 5 |
|--------------|------|------|------|--------|------|------|------|------|------|------|--------|------|------|------|------|------|------|--------|------|------|------|------|------|------|--------|------|------|------|------|------|------|--------|------|------|------|------|------|------|--------|------|------|-------|------|------|------|--------|------|------|------|------|------|------|--------|------|------|------|------|------|------|--------|------|------|------|
|--------------|------|------|------|--------|------|------|------|------|------|------|--------|------|------|------|------|------|------|--------|------|------|------|------|------|------|--------|------|------|------|------|------|------|--------|------|------|------|------|------|------|--------|------|------|-------|------|------|------|--------|------|------|------|------|------|------|--------|------|------|------|------|------|------|--------|------|------|------|

| PITCHER                             | IP  | WLS | BF | H | R | ER | SO | BB | IBB | HBP | BLK | WP | HR | S  | P  | ERA  | WHIP  |
|-------------------------------------|-----|-----|----|---|---|----|----|----|-----|-----|-----|----|----|----|----|------|-------|
| Wally Bunker, R (1, 1)<br>ERA: 2.33 | 5.1 | W   | 24 | 5 | 4 | 4  | 2  | 2  | 0   | 0   | 0   | 0  | 0  | 26 | 34 | 6.75 | 1.312 |
| Dick Hall, R (6, 1)<br>ERA: 1.32    | 3.2 | S   | 12 | 1 | 0 | 0  | 2  | 0  | 0   | 0   | 0   | 0  | 0  | 16 | 16 | 0.00 | 0.273 |

| PITCHER | IP | WLS | BF | H | R | ER | SO | BB | IBB | HBP | BLK | WP | HR | S | P | ERA | WHIP |
|---------|----|-----|----|---|---|----|----|----|-----|-----|-----|----|----|---|---|-----|------|
|---------|----|-----|----|---|---|----|----|----|-----|-----|-----|----|----|---|---|-----|------|

| Batter   | 1   | 2   | 3   | 4   | 5  | 6   | 7  | 8   | 9  | AB R H RBI BB SO LOB   | TOP  |          |
|--|---|---|---|---|--|---|--|---|--|--|--|----------|
| Jerry Adair, R<br>OBP: 0.283, SLG: 0.300<br>(1, 4)   | 0-0<br>E<br>WP<br>2B  |   | 0-3<br>K  |   | 0-0<br>1B<br>WP<br>1B  |   | 0-3<br>K   |   | 0-0<br>S<br>1B   | 5 2 3 0 0 2 0  |  |          |
| Luis Aparicio, R<br>OBP: 0.335, SLG: 0.360<br>(1, 6)   | 4-0<br>S<br>BB  |   | 0-0<br>6-3  |   | 0-0<br>WP<br>1B  |   | 0-0<br>F8  |   | 0-0<br>6-3   | 4 0 1 1 1 0 1  |  |          |
| Sam Bowens, R<br>OBP: 0.325, SLG: 0.427<br>(1, 9)<br>(9, 7)                                    | 0-0<br>1-3<br>1-2   |   | 0-0<br>5-3  |   | 0-0<br>4-3   |   | 0-0<br>BB<br>1B  |   | 0-0<br>6-3   | 5 0 1 0 0 0 3  |  |          |
| Norm Siebern, L<br>OBP: 0.420, SLG: 0.401<br>(1, 3)  | 4-0<br>BB   |   |   | 0-0<br>4-3  |  | 4-0<br>BB   |  | 4-0<br>FC6-4<br>BB  | 4-0<br>BB  | 1 0 0 0 4 0 0  |  |          |
| Brooks Robinson, R<br>OBP: 0.342, SLG: 0.419<br>(1, 5)   | 0-0<br>F9   |   |   | 0-0<br>1B   |  | 0-0<br>F7   |  | 0-0<br>FC6-4  | 0-3<br>K   | 5 0 1 0 0 1 8  |  |          |
| Boog Powell, L<br>OBP: 0.351, SLG: 0.504<br>Gino Cimoli, R<br>(1, 7)<br>(9, 9)                 | 0-0<br>F8   |   |   | 0-0<br>F8   |  | 0-3<br>K  |  |   |  | 4 1 1 1 0 1 3<br>0 0 0 0 0 0 0   |  |          |
| Willie Kirkland, L<br>OBP: 0.310, SLG: 0.260<br>(1, 8)   |   | 0-0<br>F4   |   | 0-0<br>G3   |  | 0-0<br>4-3<br>1B  |  | 0-0<br>4-3  |  | 4 0 1 0 0 0 1  |  |          |
| Dick Brown, R<br>OBP: 0.268, SLG: 0.370<br>(1, 2)  |   | 0-0<br>4-3  |   |   | 0-3<br>K   | 0-0<br>4-3  |  | 0-0<br>F5   |  | 4 0 0 0 0 1 1  |  |          |
| Dave McNally, R<br>OBP: 0.273, SLG: 0.250<br>(1, 1)  |   | 0-3<br>K  |   |   | 4-0<br>1B<br>BB  | 0-3<br>K  |  | 0-0<br>F8   |  | 3 1 0 0 1 2 1  |  |          |
| <b>Inning Stats</b>  | R: 1<br>E: 1<br>K: 0<br>S: 4<br>H: 1<br>LOB: 2<br>BB: 2<br>P: 12                                      | R: 0<br>E: 0<br>K: 1<br>S: 5<br>H: 0<br>LOB: 0<br>BB: 0<br>P: 5                               | R: 0<br>E: 0<br>K: 1<br>S: 5<br>H: 0<br>LOB: 0<br>BB: 0<br>P: 5                             | R: 0<br>E: 0<br>K: 1<br>S: 4<br>H: 1<br>LOB: 1<br>BB: 0<br>P: 4         | R: 2<br>E: 0<br>K: 1<br>S: 7<br>H: 2<br>LOB: 2<br>BB: 2<br>P: 15 | R: 0<br>E: 0<br>K: 2<br>S: 8<br>H: 1<br>LOB: 1<br>BB: 0<br>P: 8 | R: 0<br>E: 0<br>K: 1<br>S: 6<br>H: 1<br>LOB: 2<br>BB: 1<br>P: 10 | R: 1<br>E: 0<br>K: 0<br>S: 4<br>H: 1<br>LOB: 0<br>BB: 0<br>P: 4 | R: 0<br>E: 0<br>K: 1<br>S: 6<br>H: 1<br>LOB: 2<br>BB: 1<br>P: 10 | 1B: 6<br>2B: 1<br>3B: 0<br>HR: 1<br>SF: 0<br>SAC: 0<br>DP: 0<br>HBP: 0 | WP: 2<br>PB: 0<br>SB: 2<br>CS: 0<br>PA: 41 |          |
| <b>PITCHER</b><br>Orlando Pena, R<br>ERA: 3.52<br>(1, 1)<br>Jose Santiago, R<br>ERA:<br>(9, 1) | IP<br>WLS<br>BF<br>H<br>R<br>ER<br>SO<br>BB<br>IBB<br>HBP<br>BLK<br>WP<br>HR<br>S<br>P<br>ERA<br>WHIP | 8.0<br>L<br>36<br>7<br>4<br>3<br>6<br>5<br>0<br>0<br>0<br>2<br>1<br>43<br>63<br>3.38<br>1.500 | 1.0<br>5<br>1<br>0<br>0<br>1<br>1<br>0<br>0<br>0<br>0<br>0<br>0<br>6<br>10<br>0.00<br>2.000 | <b>PITCHER</b><br>IP WLS BF H R ER SO BB IBB HBP BLK WP HR S P ERA WHIP |  |   |  |   |  |  |  | ERA WHIP |

Baltimore Orioles @ Kansas City Athletics  
Municipal Stadium, Kansas City, MO  
Tue Jun 02 1964, 8:05 PM EDT  
Att. 5,943 - Unknown

livebaseballscorecards.com

|     |    |
|-----|----|
| AB  | 35 |
| R   | 4  |
| H   | 8  |
| RBI | 2  |
| BB  | 6  |
| SO  | 7  |
| LOB | 18 |



| Batter  | 1  | 2                               | 3                            | 4                               | 5                            | 6                               | 7                            | 8                               | 9                            | AB                               | R                            | H                               | RBI                          | BB                              | SO                           | LOB                             |                              |                                 |                                  |                                    |                                  |        |
|---|--|---------------------------------|------------------------------|---------------------------------|------------------------------|---------------------------------|------------------------------|---------------------------------|------------------------------|----------------------------------|------------------------------|---------------------------------|------------------------------|---------------------------------|------------------------------|---------------------------------|------------------------------|---------------------------------|----------------------------------|------------------------------------|----------------------------------|--------|
| Wayne Causey, L (1, 6)<br>OBP: 0.415, SLG: 0.407      | 0-0<br>G6-4-3<br>1B  |                                 | 4-0<br>BB                    |                                 | 0-0<br>4-3                   |                                 |                              | 0-0<br>F8                       |                              | 3                                | 0                            | 1                               | 0                            | 1                               | 0                            | 1                               |                              |                                 |                                  |                                    |                                  |        |
| Nelson Mathews, R (1, 8)<br>OBP: 0.316, SLG: 0.359    | 0-0<br>G6-4-3<br>1-2f  |                                 | 0-0<br>6-3                   |                                 |                              | 0-3<br>K                        |                              | 0-0<br>F6                       |                              | 4                                | 0                            | 0                               | 0                            | 0                               | 1                            | 2                               |                              |                                 |                                  |                                    |                                  |        |
| George Alusik, R (1, 7)<br>OBP: 0.457, SLG: 0.410     | 0-0<br>6-3   |                                 |                              | 0-0<br>6-3                      |                              | 1-0<br>L5-3<br>HBP              |                              | 0-0<br>F7                       |                              | 3                                | 0                            | 0                               | 0                            | 0                               | 0                            | 0                               |                              |                                 |                                  |                                    |                                  |        |
| Rocky Colavito, R (1, 9)<br>OBP: 0.409, SLG: 0.620    |  | 0-0<br>G6-4-3<br>1B             |                              | 0-0<br>1B                       |                              | 0-0<br>L5-3<br>1-2              |                              | 0-0<br>5-3                      |                              | 4                                | 0                            | 2                               | 0                            | 0                               | 0                            | 1                               |                              |                                 |                                  |                                    |                                  |        |
| Ed Charles, R (1, 5)<br>OBP: 0.333, SLG: 0.310        |  | 0-0<br>G6-4-3<br>1-2f           |                              | 0-0<br>1B                       |                              |                                 | 0-0<br>5-3                   |                                 | 0-0<br>6-3                   | 4                                | 0                            | 1                               | 0                            | 0                               | 0                            | 1                               |                              |                                 |                                  |                                    |                                  |        |
| Doc Edwards, R (1, 3)<br>OBP: 0.260, SLG: 0.280       |  | 0-0<br>1B                       |                              | 0-0<br>G6-4-3<br>1-2f           |                              |                                 | 0-0<br>F9                    |                                 |                              | 3                                | 0                            | 1                               | 0                            | 0                               | 0                            | 2                               |                              |                                 |                                  |                                    |                                  |        |
| Dick Green, R (1, 4)<br>OBP: 0.241, SLG: 0.329        |  | 0-0<br>F8                       |                              |                                 | 0-3<br>K                     |                                 | 0-0<br>2B                    |                                 |                              | 3                                | 0                            | 1                               | 0                            | 0                               | 1                            | 1                               |                              |                                 |                                  |                                    |                                  |        |
| Charlie Lau, L (1, 2)<br>OBP: 0.336, SLG: 0.422       |  |                                 | 0-0<br>3-1                   |                                 | 0-3<br>K                     |                                 | 0-0<br>1-6-3                 |                                 |                              | 3                                | 0                            | 0                               | 0                            | 0                               | 1                            | 1                               |                              |                                 |                                  |                                    |                                  |        |
| Orlando Pena, R (1, 1)<br>OBP: 0.152, SLG: 0.097      |  |                                 |                              |                                 | 0-3<br>K                     |                                 |                              | 0-0<br>F2                       |                              | 1                                | 0                            | 0                               | 0                            | 1                               | 1                            | 0                               |                              |                                 |                                  |                                    |                                  |        |
| George Williams, R (8, PH)<br>OBP: 0.160, SLG: 0.087  |  |                                 |                              |                                 |                              |                                 |                              |                                 |                              | 1                                | 0                            | 0                               | 0                            | 0                               | 0                            | 0                               |                              |                                 |                                  |                                    |                                  |        |
| Jose Santiago, R (9, 1)                               |  |                                 |                              |                                 |                              |                                 |                              |                                 |                              | 0                                | 0                            | 0                               | 0                            | 0                               | 0                            | 0                               |                              |                                 |                                  |                                    |                                  |        |
| <b>Inning Stats</b>                                   | R: 0<br>E: 0<br>K: 0<br>S: 3   | H: 1<br>LOB: 0<br>BB: 0<br>P: 3 | R: 0<br>E: 0<br>K: 0<br>S: 4 | H: 2<br>LOB: 1<br>BB: 0<br>P: 4 | R: 0<br>E: 0<br>K: 1<br>S: 5 | H: 0<br>LOB: 1<br>BB: 1<br>P: 9 | R: 0<br>E: 0<br>K: 0<br>S: 4 | H: 2<br>LOB: 1<br>BB: 0<br>P: 4 | R: 0<br>E: 0<br>K: 2<br>S: 7 | H: 0<br>LOB: 1<br>BB: 1<br>P: 11 | R: 0<br>E: 0<br>K: 1<br>S: 4 | H: 0<br>LOB: 0<br>BB: 0<br>P: 5 | R: 0<br>E: 0<br>K: 0<br>S: 4 | H: 1<br>LOB: 1<br>BB: 0<br>P: 4 | R: 0<br>E: 0<br>K: 0<br>S: 3 | H: 0<br>LOB: 0<br>BB: 0<br>P: 3 | R: 0<br>E: 0<br>K: 0<br>S: 3 | H: 0<br>LOB: 0<br>BB: 0<br>P: 3 | 1B: 5<br>2B: 2<br>3B: 0<br>HR: 0 | SF: 0<br>SAC: 0<br>DP: 4<br>HBP: 1 | WP: 0<br>PB: 0<br>SB: 0<br>CS: 0 | PA: 32 |
| <b>PITCHER</b><br>Dave McNally, L (1, 1)<br>ERA: 3.81 | IP: 9.0<br>WLS: W<br>BF: 32<br>H: 6<br>R: 0<br>ER: 0<br>SO: 4<br>BB: 2<br>IBB: 0<br>HBP: 1<br>BLK: 0<br>WP: 0<br>HR: 0<br>S: 37<br>P: 46<br>ERA: 0.00<br>WHIP: 0.889 |                                 |                              |                                 |                              |                                 |                              |                                 |                              |                                  |                              |                                 |                              |                                 |                              |                                 |                              |                                 |                                  |                                    |                                  |        |

**BOTTOM**

**Baltimore Orioles @ Kansas City Athletics**  
Municipal Stadium, Kansas City, MO

|     |    |
|-----|----|
| AB  | 29 |
| R   | 0  |
| H   | 6  |
| RBI | 0  |
| BB  | 2  |
| SO  | 4  |
| LOB | 9  |



Tue Jun 02 1964, 8:05 PM EDT  
Att. 5,943 - Unknown

|       |        |
|-------|--------|
| WP: 0 | PA: 32 |
| ERA   | WHIP   |

| Batter   | 1   | 2   | 3   | 4  | 5   | 6   | 7  | 8   | 9  | AB R H RBI BB SO LOB                                       | TOP                                     |                |   |
|--|---|---|---|--|---|---|--|---|--|--|---|----------------|---|
| Jerry Adair, R (1, 4)<br>OBP: 0.294, SLG: 0.311                          | 0-0<br>CS<br>1B                                       |   |   | 0-0<br>F8  |   | 0-0<br>1-3  |  | 0-0<br>1B<br>1B                                     | 0-0<br>1-3<br>1B                                     | 5 0 3 0 0 0 0  |   |                |   |
| Luis Aparicio, R (1, 6)<br>OBP: 0.342, SLG: 0.383                        | 0-0<br>F9<br>1-2                                      |   |   | 0-0<br>HR  |   | 0-0<br>S<br>1B                                      |  | 0-0<br>1-2<br>1B                                    | 0-0<br>F7  | 5 1 3 1 0 0 3  |   |                |   |
| Sam Bowens, R (1, 9)<br>OBP: 0.315, SLG: 0.413<br>(9, 7)                 | 0-3<br>K  |   |   | 0-0<br>F4  |   | 0-0<br>F5<br>1-2                                    |  | 0-0<br>L7   |  | 4 0 0 0 0 1 3  |   |                |   |
| Norm Siebern, L (1, 3)<br>OBP: 0.421, SLG: 0.396                         |   |   |   | 0-0<br>F8  |   | 4-0<br>BB   |  | 0-0<br>F9   |  | 2 1 0 0 2 0 2  |   |                |   |
| Brooks Robinson, R (1, 5)<br>OBP: 0.337, SLG: 0.412                      |   |   |   | 0-0<br>F4  |   | 0-3<br>K  |  | 0-0<br>SH1-4<br>1-2                                 | 0-0<br>4-3   | 3 0 0 0 0 1 1  |   |                |   |
| Boog Powell, L (1, 7)<br>OBP: 0.354, SLG: 0.549<br>Gino Cimoli, R (9, 9) |   |   |   | 0-0<br>3-1   |   | 0-3<br>K  |  | 0-0<br>2-H<br>HR                                    | 0-0<br>HR  | 4 2 2 3 0 1 0<br>0 0 0 0 0 0 0                             |   |                |   |
| Willie Kirkland, L (1, 8)<br>OBP: 0.308, SLG: 0.296                      |   |   |   | 0-3<br>K   |   | 0-3<br>K  |  | 0-3<br>K  | 0-0<br>HR  | 4 1 1 1 0 3 0  |   |                |   |
| Dick Brown, R (1, 2)<br>OBP: 0.267, SLG: 0.351                           |   |   |   | 0-0<br>L8  |   | 0-0<br>5-3  |  | 0-3<br>K  | 4-0<br>1B<br>BB                                      | 3 0 0 0 1 1 0  |   |                |   |
| Robin Roberts, S (1, 1)<br>OBP: 0.071, SLG: 0.071                        |   |   |   | 0-0<br>6-3   |   | 0-3<br>K  |  | 0-3<br>K  | 0-3<br>K   | 4 0 0 0 0 3 1  |   |                |   |
| <b>Inning Stats</b>  | R: 0 H: 1<br>E: 0 LOB: 0<br>K: 1 BB: 0<br>S: 5 P: 5   | R: 0 H: 0<br>E: 0 LOB: 0<br>K: 0 BB: 0<br>S: 3 P: 3 | R: 0 H: 0<br>E: 0 LOB: 0<br>K: 1 BB: 0<br>S: 5 P: 5 | R: 1 H: 1<br>E: 0 LOB: 1<br>K: 1 BB: 1<br>S: 6 P: 10 | R: 0 H: 0<br>E: 0 LOB: 0<br>K: 2 BB: 0<br>S: 7 P: 7 | R: 0 H: 1<br>E: 0 LOB: 1<br>K: 1 BB: 0<br>S: 6 P: 6 | R: 2 H: 1<br>E: 0 LOB: 0<br>K: 2 BB: 1<br>S: 8 P: 12 | R: 0 H: 2<br>E: 0 LOB: 2<br>K: 1 BB: 0<br>S: 7 P: 7 | R: 2 H: 3<br>E: 0 LOB: 2<br>K: 1 BB: 1<br>S: 8 P: 12 | 1B: 5 SF: 0<br>2B: 0 SAC: 1<br>3B: 0 DP: 0<br>HR: 4 HBP: 0 | WP: 0 PA: 38<br>PB: 0<br>SB: 1<br>CS: 1 |                |   |
| <b>PITCHER</b>   | IP WLS BF H R ER SO BB IBB HBP BLK WP HR S P ERA WHIP |   |   |  |   |   |  |   |  |  |   | <b>PITCHER</b> | IP WLS BF H R ER SO BB IBB HBP BLK WP HR S P ERA WHIP |
| Diego Segui, R (1, 1)<br>ERA: 3.8  | 8.0 L 31 6 3 3 9 2 0 0 0 0 0 2 47 55 3.38 1.000       |   |   |  |   |   |  |   |  |  |   |                |   |
| John Wyatt, R (9, 1)<br>ERA: 2.12  | 1.0 7 3 2 2 1 1 0 0 0 0 0 2 8 12 18.00 4.000          |   |   |  |   |   |  |   |  |  |   |                |   |

Baltimore Orioles @ Kansas City Athletics  
Municipal Stadium, Kansas City, MO  
Wed Jun 03 1964, 8:05 PM EDT  
Att. 5,906 - Unknown

|     |    |
|-----|----|
| AB  | 34 |
| R   | 5  |
| H   | 9  |
| RBI | 5  |
| BB  | 3  |
| SO  | 10 |
| LOB | 10 |





| Batter   | 1   | 2                                   | 3                                | 4                               | 5                            | 6                                | 7                            | 8                               | 9                            | AB                              | R                            | H                               | RBI                          | BB                              | SO                           | LOB                             |                                  |                                    |                                  |        |
|--|---|-------------------------------------|----------------------------------|---------------------------------|------------------------------|----------------------------------|------------------------------|---------------------------------|------------------------------|---------------------------------|------------------------------|---------------------------------|------------------------------|---------------------------------|------------------------------|---------------------------------|----------------------------------|------------------------------------|----------------------------------|--------|
| Wayne Causey, L (1, 6)<br>OBP: 0.422, SLG: 0.421       | 0-0<br>F9<br>2B   |                                     | 0-0<br>F8                        |                                 |                              | 0-0<br>SH2-4<br>1B               |                              | 0-0<br>FC3-6<br>1B              |                              | 4                               | 1                            | 3                               | 0                            | 0                               | 0                            | 0                               |                                  |                                    |                                  |        |
| Dick Green, R (1, 4)<br>OBP: 0.248, SLG: 0.331         | 0-0<br>F9<br>2-3  |                                     | 4-0<br>PB<br>BB                  |                                 |                              | 0-0<br>SH2-4<br>1-2              |                              | 0-0<br>FC3-6<br>1B              |                              | 2                               | 0                            | 1                               | 0                            | 1                               | 0                            | 1                               |                                  |                                    |                                  |        |
| George Alusik, R (1, 7)<br>OBP: 0.440, SLG: 0.391      | 0-0<br>6-3  |                                     | 0-3<br>K                         |                                 |                              | 0-0<br>F5                        |                              | 0-0<br>FC3-6<br>1-2f<br>2-3     |                              | 3                               | 0                            | 0                               | 0                            | 0                               | 1                            | 3                               |                                  |                                    |                                  |        |
| Jim Gentile, L (8, PH)<br>OBP: 0.387, SLG: 0.525       |   |                                     |                                  |                                 |                              |                                  |                              |                                 |                              | 1                               | 0                            | 0                               | 0                            | 0                               | 0                            | 2                               |                                  |                                    |                                  |        |
| Jose Tartabull, L (8, PR)<br>OBP: 0.188, SLG: 0.250    |   |                                     |                                  |                                 |                              |                                  |                              |                                 |                              | 0                               | 0                            | 0                               | 0                            | 0                               | 0                            | 0                               |                                  |                                    |                                  |        |
| Rocky Colavito, R (1, 9)<br>OBP: 0.399, SLG: 0.603     | 0-0<br>F8   |                                     |                                  |                                 | 0-0<br>6-3                   |                                  |                              | 0-0<br>F3<br>1-1<br>3-H         |                              | 4                               | 0                            | 0                               | 0                            | 0                               | 1                            | 3                               |                                  |                                    |                                  |        |
| Ed Charles, R (1, 5)<br>OBP: 0.332, SLG: 0.304         |   | 4-0<br>3-1<br>S<br>BB               |                                  |                                 | 0-0<br>6-3                   |                                  |                              | 0-0<br>F7                       |                              | 3                               | 0                            | 0                               | 0                            | 1                               | 1                            | 0                               |                                  |                                    |                                  |        |
| Doc Edwards, R (1, 3)<br>OBP: 0.247, SLG: 0.266        |   | 0-0<br>F9<br>1-2                    |                                  |                                 | 0-0<br>L8                    |                                  |                              | 0-0<br>F8                       |                              | 4                               | 0                            | 0                               | 0                            | 0                               | 0                            | 1                               |                                  |                                    |                                  |        |
| Billy Bryan, L (1, 2)<br>OBP: 0.391, SLG: 0.600        |   | 0-0<br>3-1<br>2-3                   |                                  |                                 |                              | 0-0<br>G6-4-3<br>1B              |                              | 0-0<br>1B                       |                              | 4                               | 0                            | 2                               | 0                            | 0                               | 0                            | 1                               |                                  |                                    |                                  |        |
| Nelson Mathews, R (1, 8)<br>OBP: 0.311, SLG: 0.353     |   | 0-3<br>K                            |                                  |                                 |                              | 0-0<br>G6-4-3<br>1-2f            |                              | 0-3<br>K                        |                              | 3                               | 0                            | 0                               | 0                            | 0                               | 2                            | 3                               |                                  |                                    |                                  |        |
| Diego Segui, R (1, 1)<br>OBP: 0.217, SLG: 0.318        |   |                                     | 0-3<br>K                         |                                 |                              | 0-0<br>F9                        |                              | 0-0<br>F8                       |                              | 2                               | 0                            | 0                               | 0                            | 0                               | 1                            | 0                               |                                  |                                    |                                  |        |
| Charlie Lau, L (8, PH)<br>OBP: 0.333, SLG: 0.417       |   |                                     |                                  |                                 |                              |                                  |                              |                                 |                              | 1                               | 0                            | 0                               | 0                            | 0                               | 0                            | 0                               |                                  |                                    |                                  |        |
| John Wyatt, R (9, 1)                                   |   |                                     |                                  |                                 |                              |                                  |                              |                                 |                              | 0                               | 0                            | 0                               | 0                            | 0                               | 0                            | 0                               |                                  |                                    |                                  |        |
| <b>Inning Stats</b>                                    | R: 0<br>E: 0<br>K: 0<br>S: 4                                  | H: 1<br>LOB: 1<br>BB: 0<br>P: 4     | R: 0<br>E: 0<br>K: 1<br>S: 5     | H: 0<br>LOB: 1<br>BB: 1<br>P: 9 | R: 0<br>E: 0<br>K: 2<br>S: 7 | H: 0<br>LOB: 1<br>BB: 1<br>P: 11 | R: 0<br>E: 0<br>K: 0<br>S: 3 | H: 0<br>LOB: 0<br>BB: 0<br>P: 3 | R: 0<br>E: 0<br>K: 1<br>S: 6 | H: 1<br>LOB: 1<br>BB: 0<br>P: 6 | R: 0<br>E: 0<br>K: 1<br>S: 6 | H: 1<br>LOB: 1<br>BB: 0<br>P: 6 | R: 1<br>E: 1<br>K: 0<br>S: 5 | H: 2<br>LOB: 1<br>BB: 0<br>P: 5 | R: 0<br>E: 0<br>K: 1<br>S: 5 | H: 0<br>LOB: 0<br>BB: 0<br>P: 5 | 1B: 5<br>2B: 1<br>3B: 0<br>HR: 0 | SF: 0<br>SAC: 1<br>DP: 1<br>HBP: 0 | WP: 0<br>PB: 1<br>SB: 1<br>CS: 0 | PA: 34 |
| <b>PITCHER</b><br>Robin Roberts, R (1, 1)<br>ERA: 1.72 | IP: 9.0<br>WLS: W<br>BF: 34<br>H: 6<br>R: 1<br>ER: 0<br>SO: 6 | BB: 2<br>IBB: 0<br>HBP: 0<br>BLK: 0 | WP: 0<br>HR: 0<br>S: 44<br>P: 52 | ERA: 0.00<br>WHIP: 0.889        |                              |                                  |                              |                                 |                              |                                 |                              |                                 |                              |                                 |                              |                                 |                                  |                                    |                                  |        |

**BOTTOM**

**Baltimore Orioles @ Kansas City Athletics**  
Municipal Stadium, Kansas City, MO  
Wed Jun 03 1964, 8:05 PM EDT  
Att. 5,906 - Unknown

[livebaseballscorecards.com](http://livebaseballscorecards.com)

|            |           |
|------------|-----------|
| <b>AB</b>  | <b>31</b> |
| <b>R</b>   | <b>1</b>  |
| <b>H</b>   | <b>6</b>  |
| <b>RBI</b> | <b>0</b>  |
| <b>BB</b>  | <b>2</b>  |
| <b>SO</b>  | <b>6</b>  |
| <b>LOB</b> | <b>14</b> |



| Batter   | 1   | 2                               | 3                             | 4                                | 5                            | 6                               | 7                            | 8                               | 9                              | AB R H RBI BB SO LOB             | TOP   |                                 |                              |                                  |                              |                                 |                              |                                  |                                  |                                    |                                  |        |
|--|---|---------------------------------|-------------------------------|----------------------------------|------------------------------|---------------------------------|------------------------------|---------------------------------|--------------------------------|----------------------------------|---|---------------------------------|------------------------------|----------------------------------|------------------------------|---------------------------------|------------------------------|----------------------------------|----------------------------------|------------------------------------|----------------------------------|--------|
| Dalton Jones, L (1, 4)<br>OBP: 0.341, SLG: 0.430     | 0-0<br>4-3  | 0-0<br>F7                       | 0-0<br>4-3                    |                                  | 0-0<br>F6                    |                                 | 0-0<br>1-3                   |                                 | 0-0<br>1B                      | 6 1 1 2 0 0 6                    |   |                                 |                              |                                  |                              |                                 |                              |                                  |                                  |                                    |                                  |        |
| Tony Conigliaro, R (1, 7)<br>OBP: 0.320, SLG: 0.472  | 0-0<br>F9   | 0-0<br>BB<br>HR<br>1B           | 0-0<br>F5                     |                                  |                              | 0-0<br>1B<br>WP<br>1B           | 0-0<br>F6                    |                                 | 0-0<br>1B                      | 6 2 3 2 0 0 3                    |   |                                 |                              |                                  |                              |                                 |                              |                                  |                                  |                                    |                                  |        |
| Carl Yastrzemski, L (1, 8)<br>OBP: 0.348, SLG: 0.400 | 0-0<br>6-3  | 4-0<br>HR<br>BB                 |                               | 0-0<br>F6                        |                              | 0-0<br>WP<br>1B                 |                              | 0-0<br>F7                       | 0-0<br>F7                      | 3 1 1 0 1 0 0<br>2 0 0 0 0 0 1   |   |                                 |                              |                                  |                              |                                 |                              |                                  |                                  |                                    |                                  |        |
| Felix Mantilla, R (6, 8)<br>OBP: 0.265, SLG: 0.391   |   |                                 |                               |                                  |                              |                                 |                              |                                 |                                |                                  |   |                                 |                              |                                  |                              |                                 |                              |                                  |                                  |                                    |                                  |        |
| Dick Stuart, R (1, 3)<br>OBP: 0.299, SLG: 0.459      |   | K                               |                               | 0-0<br>F8                        |                              | 0-0<br>1-3                      |                              | 0-0<br>F9                       |                                | 5 1 1 4 0 1 1                    |   |                                 |                              |                                  |                              |                                 |                              |                                  |                                  |                                    |                                  |        |
| Lee Thomas, L (1, 9)<br>OBP: 0.347, SLG: 0.390       |   | BB<br>1B                        |                               | 0-0<br>1B                        |                              | 0-0<br>1-3                      |                              | 0-3<br>K                        |                                | 5 2 3 1 0 1 1                    |   |                                 |                              |                                  |                              |                                 |                              |                                  |                                  |                                    |                                  |        |
| Frank Malzone, R (1, 5)<br>OBP: 0.324, SLG: 0.367    |   | 1B                              |                               |                                  | 0-0<br>F3                    |                                 |                              |                                 | 0-0<br>F3                      | 2 1 0 0 2 0 1                    |   |                                 |                              |                                  |                              |                                 |                              |                                  |                                  |                                    |                                  |        |
| Dick Williams, R (6, 5)<br>OBP: 0.143, SLG: 0.100    |   | BB                              |                               |                                  |                              | 0-0<br>5-3                      |                              |                                 |                                | 1 0 0 0 0 0 0                    |   |                                 |                              |                                  |                              |                                 |                              |                                  |                                  |                                    |                                  |        |
| Eddie Bressoud, R (1, 6)<br>OBP: 0.391, SLG: 0.441   |   | 1B                              |                               |                                  | 4-0<br>2B<br>BB              |                                 |                              |                                 | 0-0<br>E1<br>SH1-3<br>BB<br>2B | 3 3 1 1 2 1 1                    | AB 39<br>R 14<br>H 13<br>RBI 13<br>BB 8<br>SO 4<br>LOB 18                             |                                 |                              |                                  |                              |                                 |                              |                                  |                                  |                                    |                                  |        |
| Russ Nixon, L (1, 2)<br>OBP: 0.426, SLG: 0.452       |   | 1B                              | 4-0<br>BB                     |                                  | 0-0<br>2B                    |                                 |                              |                                 | 4-0<br>SH1-3<br>BB<br>2B       | 2 2 2 2 3 0 0                    |   |                                 |                              |                                  |                              |                                 |                              |                                  |                                  |                                    |                                  |        |
| Earl Wilson, R (1, 1)<br>OBP: 0.421, SLG: 0.500      |   | BB<br>1B                        |                               | 0-0<br>5-3                       |                              | 0-3<br>K                        |                              |                                 | 0-0<br>SH1-3                   | 4 1 1 1 0 1 4                    |  |                                 |                              |                                  |                              |                                 |                              |                                  |                                  |                                    |                                  |        |
| Arnold Earley, L (8, 1)<br>OBP: 0.143, SLG: 0.100    |   | HR<br>1B                        |                               | 0-0<br>5-3                       |                              |                                 | 0-0<br>L9                    |                                 | 1-2<br>2-3                     | 0 0 0 0 0 0 0                    |   |                                 |                              |                                  |                              |                                 |                              |                                  |                                  |                                    |                                  |        |
| <b>Inning Stats</b>                                  | R: 0<br>E: 0<br>K: 0<br>S: 3                          | H: 0<br>LOB: 0<br>BB: 0<br>P: 3 | R: 9<br>E: 0<br>K: 2<br>S: 14 | H: 7<br>LOB: 1<br>BB: 3<br>P: 26 | R: 0<br>E: 0<br>K: 0<br>S: 3 | H: 0<br>LOB: 1<br>BB: 1<br>P: 7 | R: 0<br>E: 0<br>K: 2<br>S: 3 | H: 1<br>LOB: 1<br>BB: 0<br>P: 3 | R: 1<br>E: 0<br>K: 1<br>S: 6   | H: 1<br>LOB: 1<br>BB: 1<br>P: 10 | R: 1<br>E: 0<br>K: 0<br>S: 5  | H: 2<br>LOB: 1<br>BB: 0<br>P: 5 | R: 0<br>E: 0<br>K: 0<br>S: 3 | H: 0<br>LOB: 2<br>BB: 2<br>P: 11 | R: 0<br>E: 0<br>K: 1<br>S: 5 | H: 0<br>LOB: 0<br>BB: 0<br>P: 5 | R: 3<br>E: 1<br>K: 0<br>S: 6 | H: 2<br>LOB: 1<br>BB: 1<br>P: 10 | 1B: 9<br>2B: 2<br>3B: 0<br>HR: 2 | SF: 0<br>SAC: 1<br>DP: 0<br>HBP: 0 | WP: 1<br>PB: 0<br>SB: 0<br>CS: 0 | PA: 48 |
| <b>PITCHER</b>                                       | IP WLS BF H R ER SO BB IBB HBP BLK WP HR S P ERA WHIP |                                 |                               |                                  |                              |                                 |                              |                                 |                                |                                  |   |                                 |                              |                                  |                              |                                 |                              |                                  |                                  |                                    |                                  |        |
| Moe Drabowsky, R (1, 1)<br>ERA: 6.75                 | 1.1 L 9 4 5 5 1 1 0 0 0 0 0 0 10 14 33.75 3.750       |                                 |                               |                                  |                              |                                 |                              |                                 |                                |                                  |   |                                 |                              |                                  |                              |                                 |                              |                                  |                                  |                                    |                                  |        |
| Aurelio Monteagudo, R (2, 1)<br>ERA: 9.82            | 0.1 5 3 4 4 0 1 0 0 0 0 0 2 4 8 108.00 12.000         |                                 |                               |                                  |                              |                                 |                              |                                 |                                |                                  |   |                                 |                              |                                  |                              |                                 |                              |                                  |                                  |                                    |                                  |        |
| Vern Handrahan, R (2, 1)<br>ERA: 6.32                | 3.1 14 2 1 1 2 3 0 0 0 0 0 0 15 27 2.70 1.500         |                                 |                               |                                  |                              |                                 |                              |                                 |                                |                                  |   |                                 |                              |                                  |                              |                                 |                              |                                  |                                  |                                    |                                  |        |
| Joe Grzenda, L (6, 1)<br>ERA: 7.94                   | 2.0 10 2 1 1 0 2 0 0 0 0 1 0 8 16 4.50 2.000          |                                 |                               |                                  |                              |                                 |                              |                                 |                                |                                  |   |                                 |                              |                                  |                              |                                 |                              |                                  |                                  |                                    |                                  |        |
| Jose Santiago, R (8, 1)<br>ERA:                      | 2.0 10 2 3 0 1 1 0 0 0 0 0 0 0 11 0.00 1.500          |                                 |                               |                                  |                              |                                 |                              |                                 |                                |                                  |   |                                 |                              |                                  |                              |                                 |                              |                                  |                                  |                                    |                                  |        |

**Boston Red Sox @ Kansas City Athletics**  
**Municipal Stadium, Kansas City, MO**  
 Fri Jun 05 1964, 8:05 PM EDT  
 Att. 4,295 - Unknown

[livebaseballscorecards.com](http://livebaseballscorecards.com)

| Batter  | 1                              | 2                       | 3                      | 4                                 | 5                | 6                     | 7                | 8         | 9 | AB | R | H | RBI | BB | SO | LOB |
|---|--------------------------------|-------------------------|------------------------|-----------------------------------|------------------|-----------------------|------------------|-----------|---|----|---|---|-----|----|----|-----|
| Wayne Causey, L (1, 6)<br>OBP: 0.431, SLG: 0.429      | 0-0<br>BB BB<br>BB<br>1B       | 0-0<br>1-2<br>2-H<br>1B |                        | 4-0<br>BB<br>BB<br>BB<br>BB<br>BB |                  | 0-0<br>G6-4-3<br>1B   |                  | 0-3<br>K  |   | 4  | 1 | 3 | 1   | 1  | 1  | 0   |
| George Williams, R (1, 4)<br>OBP: 0.133, SLG: 0.071   | 0-0<br>F8                      | 0-3<br>K                |                        | 0-0<br>F4                         |                  | 0-0<br>G6-4-3<br>1-2f |                  | 0-0<br>F6 |   | 5  | 0 | 0 | 0   | 0  | 1  | 5   |
| George Alusik, R (1, 7)<br>OBP: 0.427, SLG: 0.420     | 0-3<br>K                       | 0-3<br>K                |                        | 0-0<br>F3                         |                  | 0-0<br>F3             |                  | 0-0<br>HR |   | 5  | 1 | 1 | 1   | 0  | 2  | 4   |
| Rocky Colavito, R (1, 9)<br>OBP: 0.405, SLG: 0.621    | 4-0<br>BB BB<br>1-2<br>BB      | 0-0<br>1-2<br>2-H<br>1B |                        | 0-0<br>L8                         |                  |                       | 0-0<br>5-3       | 0-0<br>HR |   | 4  | 1 | 2 | 2   | 1  | 0  | 1   |
| Jim Gentile, L (1, 3)<br>OBP: 0.387, SLG: 0.516       | 4-0<br>1-2<br>2-3<br>BB<br>BB  | 0-3<br>K                |                        |                                   | 0-0<br>1B<br>1B  |                       | 0-0<br>4-3       | 0-3<br>K  |   | 4  | 0 | 1 | 0   | 1  | 2  | 2   |
| Ed Charles, R (1, 5)<br>OBP: 0.344, SLG: 0.339        | 4-0<br>1-2<br>2-3<br>3-H<br>BB |                         | 0-0<br>G3<br>6-3<br>2B |                                   | 0-0<br>1-2<br>1B |                       | 0-0<br>HR        | 0-3<br>K  |   | 4  | 2 | 3 | 2   | 1  | 1  | 0   |
| Billy Bryan, L (1, 2)<br>OBP: 0.370, SLG: 0.522       | 0-3<br>K                       |                         | 0-0<br>G3              |                                   | 0-3<br>K         |                       | 4-0<br>BB<br>BB  | 0-0<br>1B |   | 3  | 0 | 0 | 0   | 1  | 2  | 6   |
| Doc Edwards, R (9, PH)<br>OBP: 0.256, SLG: 0.275      |                                |                         | 2-3                    |                                   |                  |                       |                  |           |   | 1  | 0 | 1 | 0   | 0  | 0  | 0   |
| Nelson Mathews, R (1, 8)<br>OBP: 0.313, SLG: 0.350    |                                | 0-0<br>1B<br>1B         | 0-0<br>6-3             |                                   | 0-3<br>K         |                       | 4-0<br>1-2<br>BB | 0-3<br>K  |   | 4  | 1 | 1 | 1   | 1  | 2  | 3   |
| Moe Drabowsky, R (1, 1)<br>OBP: 0.083, SLG: 0.083     |                                | 0-0<br>1B<br>1B         | 0-3<br>K               |                                   | 0-0<br>F1        |                       | 0-0<br>F5        | 0-0<br>F9 |   | 0  | 0 | 0 | 0   | 0  | 0  | 0   |
| Aurelio Montegudo, R (2, 1)<br>OBP: 0.266, SLG: 0.571 |                                |                         |                        |                                   |                  |                       |                  |           |   | 0  | 0 | 0 | 0   | 0  | 0  | 0   |
| Vern Handrahan, L (2, 1)<br>OBP: 0.125, SLG: 0.125    |                                |                         |                        |                                   |                  |                       |                  |           |   | 2  | 1 | 1 | 0   | 0  | 1  | 0   |
| Charlie Lau, L (5, PH)<br>OBP: 0.330, SLG: 0.413      |                                |                         |                        |                                   |                  |                       |                  |           |   | 1  | 0 | 0 | 0   | 0  | 0  | 2   |
| Joe Grzenda, R (6, 1)<br>OBP: 0.196, SLG: 0.235       |                                |                         |                        |                                   |                  |                       |                  |           |   | 0  | 0 | 0 | 0   | 0  | 0  | 0   |
| Jose Tartabull, L (7, PH)<br>OBP: 0.196, SLG: 0.235   |                                |                         |                        |                                   |                  |                       |                  |           |   | 1  | 0 | 0 | 0   | 0  | 0  | 2   |
| Jose Santiago, R (8, 1)<br>OBP: 0.247, SLG: 0.329     |                                |                         |                        |                                   |                  |                       |                  |           |   | 0  | 0 | 0 | 0   | 0  | 0  | 0   |
| Dick Green, R (9, PH)                                 |                                |                         |                        |                                   |                  |                       |                  |           |   | 1  | 0 | 0 | 0   | 0  | 0  | 1   |

| Inning Stats                         | R: 1 | H: 1 | E: 0 | K: 2 | S: 8 | R: 2 | H: 4 | E: 0 | K: 3 | S: 13 | R: 1 | H: 1 | E: 0 | K: 1 | S: 6 | R: 0 | H: 0  | E: 0 | K: 0 | S: 3 | R: 0 | H: 2 | E: 0 | K: 2 | S: 9 | R: 0 | H: 1 | E: 0 | K: 0 | S: 3 | R: 1 | H: 1 | E: 0 | K: 0 | S: 4 | R: 2 | H: 2 | E: 0 | K: 2 | S: 9 | R: 0 | H: 1 | E: 0 | K: 2 | S: 8 | 1B: 9 | SF: 0 | 2B: 1 | SAC: 0 | 3B: 0 | DP: 1 | HR: 3 | HBP: 0 | WP: 0 | PA: 45 |
|--------------------------------------|------|------|------|------|------|------|------|------|------|-------|------|------|------|------|------|------|-------|------|------|------|------|------|------|------|------|------|------|------|------|------|------|------|------|------|------|------|------|------|------|------|------|------|------|------|------|-------|-------|-------|--------|-------|-------|-------|--------|-------|--------|
| PITCHER                              | IP   | WLS  | BF   | H    | R    | ER   | SO   | BB   | IBB  | HBP   | BLK  | WP   | HR   | S    | P    | ERA  | WHIP  |      |      |      |      |      |      |      |      |      |      |      |      |      |      |      |      |      |      |      |      |      |      |      |      |      |      |      |      |       |       |       |        |       |       |       |        |       |        |
| Earl Wilson, R (1, 1)<br>ERA: 5.12   | 7.2  | W    | 40   | 12   | 7    | 7    | 9    | 6    | 0    | 0     | 0    | 0    | 3    | 52   | 76   | 8.22 | 2.348 |      |      |      |      |      |      |      |      |      |      |      |      |      |      |      |      |      |      |      |      |      |      |      |      |      |      |      |      |       |       |       |        |       |       |       |        |       |        |
| Arnold Earley, L (8, 1)<br>ERA: 0.66 | 1.1  | S    | 5    | 1    | 0    | 0    | 3    | 0    | 0    | 0     | 0    | 0    | 0    | 11   | 11   | 0.00 | 0.750 |      |      |      |      |      |      |      |      |      |      |      |      |      |      |      |      |      |      |      |      |      |      |      |      |      |      |      |      |       |       |       |        |       |       |       |        |       |        |

**BOTTOM**

**Boston Red Sox @ Kansas City Athletics**  
Municipal Stadium, Kansas City, MO

Fri Jun 05 1964, 8:05 PM EDT  
Att. 4,295 - Unknown

livebaseballscorecards.com

|            |           |
|------------|-----------|
| <b>AB</b>  | <b>39</b> |
| <b>R</b>   | <b>7</b>  |
| <b>H</b>   | <b>13</b> |
| <b>RBI</b> | <b>7</b>  |
| <b>BB</b>  | <b>6</b>  |
| <b>SO</b>  | <b>12</b> |
| <b>LOB</b> | <b>26</b> |



| Batter  | 1   | 2                                | 3                            | 4                               | 5                            | 6                               | 7                            | 8                               | 9                            | AB R H RBI BB SO LOB            | TOP                          |                                 |                              |                                 |                              |                                 |                              |                                 |                                  |                                    |                                  |        |  |  |  |
|---|---|----------------------------------|------------------------------|---------------------------------|------------------------------|---------------------------------|------------------------------|---------------------------------|------------------------------|---------------------------------|------------------------------|---------------------------------|------------------------------|---------------------------------|------------------------------|---------------------------------|------------------------------|---------------------------------|----------------------------------|------------------------------------|----------------------------------|--------|--|--|--|
| <b>Chuck Schilling, R</b> (1, 4)<br>OBP: 0.269, SLG: 0.256  |   |                                  |                              |                                 |                              |                                 |                              |                                 |                              | 4 1 1 0 1 0 4                   |                              |                                 |                              |                                 |                              |                                 |                              |                                 |                                  |                                    |                                  |        |  |  |  |
| <b>Tony Conigliaro, R</b> (1, 7)<br>OBP: 0.322, SLG: 0.494  |   |                                  |                              |                                 |                              |                                 |                              |                                 |                              | 5 2 2 2 0 2 3                   |                              |                                 |                              |                                 |                              |                                 |                              |                                 |                                  |                                    |                                  |        |  |  |  |
| <b>Carl Yastrzemski, L</b> (1, 8)<br>OBP: 0.344, SLG: 0.394 |   |                                  |                              |                                 |                              |                                 |                              |                                 |                              | 5 0 1 0 0 0 1                   |                              |                                 |                              |                                 |                              |                                 |                              |                                 |                                  |                                    |                                  |        |  |  |  |
| <b>Dick Stuart, R</b> (1, 3)<br>OBP: 0.307, SLG: 0.476      |   |                                  |                              |                                 |                              |                                 |                              |                                 |                              | 4 2 2 2 1 0 1                   |                              |                                 |                              |                                 |                              |                                 |                              |                                 |                                  |                                    |                                  |        |  |  |  |
| <b>Frank Malzone, R</b> (1, 5)<br>OBP: 0.326, SLG: 0.364    |   |                                  |                              |                                 |                              |                                 |                              |                                 |                              | 4 1 1 0 1 0 2                   |                              |                                 |                              |                                 |                              |                                 |                              |                                 |                                  |                                    |                                  |        |  |  |  |
| <b>Lee Thomas, L</b> (1, 9)<br>OBP: 0.355, SLG: 0.414       |   |                                  |                              |                                 |                              |                                 |                              |                                 |                              | 4 2 3 2 0 0 2                   |                              |                                 |                              |                                 |                              |                                 |                              |                                 |                                  |                                    |                                  |        |  |  |  |
| <b>Eddie Bressoud, R</b> (1, 6)<br>OBP: 0.389, SLG: 0.437   |   |                                  |                              |                                 |                              |                                 |                              |                                 |                              | 4 0 1 1 0 0 1                   |                              |                                 |                              |                                 |                              |                                 |                              |                                 |                                  |                                    |                                  |        |  |  |  |
| <b>Bob Tillman, R</b> (1, 2)<br>OBP: 0.353, SLG: 0.404      |   |                                  |                              |                                 |                              |                                 |                              |                                 |                              | 3 0 2 0 1 0 0                   |                              |                                 |                              |                                 |                              |                                 |                              |                                 |                                  |                                    |                                  |        |  |  |  |
| <b>Jack Lamabe, R</b> (1, 1)<br>OBP: 0.138, SLG: 0.179      |   |                                  |                              |                                 |                              |                                 |                              |                                 |                              | 3 0 0 0 0 2 3                   |                              |                                 |                              |                                 |                              |                                 |                              |                                 |                                  |                                    |                                  |        |  |  |  |
| <b>Bob Heffner, R</b> (7, 1)<br>OBP: 0.286, SLG: 0.714      |   |                                  |                              |                                 |                              |                                 |                              |                                 |                              | 0 0 0 0 0 0 0                   |                              |                                 |                              |                                 |                              |                                 |                              |                                 |                                  |                                    |                                  |        |  |  |  |
| <b>Felix Mantilla, R</b> (8, PH)<br>OBP: 0.260, SLG: 0.383  |   |                                  |                              |                                 |                              |                                 |                              |                                 |                              | 1 0 0 0 0 0 1                   |                              |                                 |                              |                                 |                              |                                 |                              |                                 |                                  |                                    |                                  |        |  |  |  |
| <b>Dick Radatz, R</b> (8, 1)<br>OBP: 0.250, SLG: 0.250      |   |                                  |                              |                                 |                              |                                 |                              |                                 |                              | 0 0 0 0 0 0 0                   |                              |                                 |                              |                                 |                              |                                 |                              |                                 |                                  |                                    |                                  |        |  |  |  |
| <b>Inning Stats</b>   | R: 5<br>E: 0<br>K: 0<br>S: 7                          | H: 4<br>LOB: 2<br>BB: 3<br>P: 19 | R: 3<br>E: 0<br>K: 0<br>S: 6 | H: 3<br>LOB: 0<br>BB: 0<br>P: 6 | R: 0<br>E: 0<br>K: 2<br>S: 8 | H: 1<br>LOB: 1<br>BB: 0<br>P: 8 | R: 0<br>E: 0<br>K: 0<br>S: 4 | H: 2<br>LOB: 1<br>BB: 0<br>P: 4 | R: 0<br>E: 0<br>K: 1<br>S: 5 | H: 0<br>LOB: 0<br>BB: 0<br>P: 5 | R: 0<br>E: 0<br>K: 0<br>S: 3 | H: 1<br>LOB: 0<br>BB: 0<br>P: 3 | R: 0<br>E: 0<br>K: 0<br>S: 3 | H: 1<br>LOB: 1<br>BB: 1<br>P: 7 | R: 0<br>E: 0<br>K: 1<br>S: 6 | H: 1<br>LOB: 1<br>BB: 0<br>P: 6 | R: 0<br>E: 0<br>K: 0<br>S: 3 | H: 0<br>LOB: 0<br>BB: 0<br>P: 3 | 1B: 9<br>2B: 1<br>3B: 0<br>HR: 3 | SF: 0<br>SAC: 0<br>DP: 3<br>HBP: 0 | WP: 1<br>PB: 1<br>SB: 2<br>CS: 0 | PA: 41 |  |  |  |
| <b>PITCHER</b>  | IP WLS BF H R ER SO BB IBB HBP BLK WP HR S P ERA WHIP |                                  |                              |                                 |                              |                                 |                              |                                 |                              |                                 |                              |                                 |                              |                                 |                              |                                 |                              |                                 |                                  |                                    |                                  |        |  |  |  |
| <b>John O'Donoghue, L</b> (1, 1)<br>ERA: 5.36               | 0.1   | L                                | 8                            | 4                               | 5                            | 5                               | 0                            | 3                               | 0                            | 0                               | 0                            | 0                               | 2                            | 5                               | 17                           | 135.00                          | 21.000                       |                                 |                                  |                                    |                                  |        |  |  |  |
| <b>Ted Bowsfield, L</b> (1, 1)<br>ERA: 6.75                 | 4.2   |                                  | 19                           | 6                               | 3                            | 3                               | 3                            | 0                               | 0                            | 0                               | 0                            | 1                               | 1                            | 25                              | 25                           | 5.79                            | 1.286                        |                                 |                                  |                                    |                                  |        |  |  |  |
| <b>Aurelio Monteagudo, R</b> (6, 1)<br>ERA: 9.19            | 2.0   |                                  | 7                            | 2                               | 0                            | 0                               | 0                            | 1                               | 0                            | 0                               | 0                            | 0                               | 0                            | 6                               | 10                           | 0.00                            | 1.500                        |                                 |                                  |                                    |                                  |        |  |  |  |
| <b>Joe Grzenda, L</b> (8, 1)<br>ERA: 7.3                    | 1.0   |                                  | 4                            | 1                               | 0                            | 0                               | 1                            | 0                               | 0                            | 0                               | 0                            | 0                               | 0                            | 6                               | 6                            | 0.00                            | 1.000                        |                                 |                                  |                                    |                                  |        |  |  |  |
| <b>Vern Handrahan, R</b> (9, 1)<br>ERA: 6.12                | 1.0   |                                  | 3                            | 0                               | 0                            | 0                               | 0                            | 0                               | 0                            | 0                               | 0                            | 0                               | 0                            | 3                               | 3                            | 0.00                            | 0.000                        |                                 |                                  |                                    |                                  |        |  |  |  |

**Boston Red Sox @ Kansas City Athletics**  
 Municipal Stadium, Kansas City, MO

Sat Jun 06 1964, 4:33 AM EDT  
 Att. 4,734 - Unknown

|     |    |
|-----|----|
| AB  | 37 |
| R   | 8  |
| H   | 13 |
| RBI | 7  |
| BB  | 4  |
| SO  | 4  |
| LOB | 18 |



|    |   |    |    |
|----|---|----|----|
| WP | 1 | PA | 41 |
| PB | 1 |    |    |
| SB | 2 |    |    |
| CS | 0 |    |    |

| PITCHER               | IP  | WLS | BF | H | R | ER | SO | BB | IBB | HBP | BLK | WP | HR | S  | P  | ERA    | WHIP   |
|-----------------------|-----|-----|----|---|---|----|----|----|-----|-----|-----|----|----|----|----|--------|--------|
| John O'Donoghue, L    | 0.1 | L   | 8  | 4 | 5 | 5  | 0  | 3  | 0   | 0   | 0   | 0  | 2  | 5  | 17 | 135.00 | 21.000 |
| Ted Bowsfield, L      | 4.2 |     | 19 | 6 | 3 | 3  | 3  | 0  | 0   | 0   | 0   | 1  | 1  | 25 | 25 | 5.79   | 1.286  |
| Aurelio Monteagudo, R | 2.0 |     | 7  | 2 | 0 | 0  | 0  | 1  | 0   | 0   | 0   | 0  | 0  | 6  | 10 | 0.00   | 1.500  |
| Joe Grzenda, L        | 1.0 |     | 4  | 1 | 0 | 0  | 1  | 0  | 0   | 0   | 0   | 0  | 0  | 6  | 6  | 0.00   | 1.000  |
| Vern Handrahan, R     | 1.0 |     | 3  | 0 | 0 | 0  | 0  | 0  | 0   | 0   | 0   | 0  | 0  | 3  | 3  | 0.00   | 0.000  |

BOTTOM

Boston Red Sox @ Kansas City Athletics  
Municipal Stadium, Kansas City, MO

livebaseballscorecards.com

AB 38  
R 6  
H 12  
RBI 6  
BB 1  
SO 3  
LOB 13

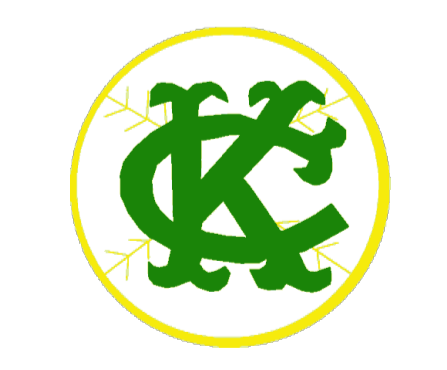

WP: 0 PA: 39  
PB: 0  
SB: 0  
CS: 0

Sat Jun 06 1964, 4:33 AM EDT  
Att. 4,734 - Unknown

AB R H RBI BB SO LOB

5 0 1 0 0 0 2

5 1 1 0 0 0 2

5 1 2 2 0 0 1

4 1 2 0 0 0 2

4 1 1 2 0 0 2

4 0 1 0 0 0 1

3 1 1 0 1 1 1

4 1 1 1 0 1 1

0 0 0 0 0 0 0  
1 0 0 0 0 0 0  
1 0 1 0 0 0 0  
0 0 0 0 0 0 0  
1 0 1 1 0 0 0  
0 0 0 0 0 0 0  
1 0 0 0 0 1 1  
0 0 0 0 0 1 1

1B: 5 SF: 0  
2B: 5 SAC: 0  
3B: 0 DP: 1  
HR: 2 HBP: 0

| Batter   | 1          | 2          | 3          | 4               | 5          | 6                  | 7                   | 8         | 9         |
|--|------------|------------|------------|-----------------|------------|--------------------|---------------------|-----------|-----------|
| Wayne Causey, L (1, 6)<br>OBP: 0.425, SLG: 0.428   | 0-0<br>2B  |            | 0-0<br>L8  |                 | 0-0<br>G1  |                    | 0-0<br>G1-6-3       |           | 0-0<br>F7 |
| Nelson Mathews, R (1, 8)<br>OBP: 0.310, SLG: 0.352   | 0-0<br>F9  |            |            | 0-0<br>1-3      | 0-0<br>F8  |                    | 0-0<br>HR<br>2B     |           | 0-0<br>F8 |
| Ed Charles, R (1, 5)<br>OBP: 0.345, SLG: 0.359   | 0-0<br>6-3 |            |            | 0-0<br>F8       |            | 0-0<br>FC6-4<br>1B | 0-0<br>HR           |           | 0-0<br>F4 |
| Rocky Colavito, R (1, 9)<br>OBP: 0.407, SLG: 0.624   | 0-0<br>L7  |            |            | 0-0<br>HR<br>1B |            | 0-0<br>F7          | 0-0<br>2B           |           |           |
| Jim Gentile, L (1, 3)<br>OBP: 0.384, SLG: 0.531  |            | 0-0<br>1-3 |            | 0-0<br>HR       |            | 0-0<br>L8          | 0-0<br>F5           |           |           |
| George Alusik, R (1, 7)<br>OBP: 0.419, SLG: 0.411  |            | 0-0<br>F5  |            | 0-0<br>1B       |            | 0-0<br>FC6-4       |                     | 0-0<br>F5 |           |
| Billy Bryan, L (1, 2)<br>OBP: 0.387, SLG: 0.538  |            | 0-0<br>4-3 |            | 0-3<br>K        |            |                    | 0-0<br>1B<br>2B     | 4-0<br>BB |           |
| George Williams, R (1, 4)<br>OBP: 0.147, SLG: 0.094  |            |            | 0-0<br>6-3 |                 | 0-0<br>6-3 |                    | 0-0<br>1B<br>1B     | 0-3<br>K  |           |
| John O'Donoghue, R (1, 1)<br>OBP: 0.333, SLG: 0.333<br>Ted Bowfield, R (1, 1)<br>Dick Green, R (5, PH)<br>Aurelio Montegudo, R (6, 1)<br>Charlie Lau, L (7, PH)<br>Joe Grzenda, R (8, 1)<br>Doc Edwards, R (8, PH)<br>Vern Handrahan, L (9, 1)<br>OBP: 0.252, SLG: 0.340<br>OBP: 0.286, SLG: 0.511<br>OBP: 0.336, SLG: 0.419<br>OBP: 0.253, SLG: 0.272<br>OBP: 0.125, SLG: 0.125 |            |            | 0-0<br>4-3 |                 | 0-0<br>2B  |                    | 0-0<br>G1-6-3<br>1B | 0-3<br>K  |           |

| Inning Stats | R: 0 | H: 1 | E: 0 | LOB: 1 | K: 0 | BB: 0 | S: 4 | P: 4 | R: 0 | H: 0 | E: 0 | LOB: 0 | K: 0 | BB: 0 | S: 3 | P: 3 | R: 0 | H: 0 | E: 0 | LOB: 0 | K: 0 | BB: 0 | S: 3 | P: 3 | R: 2 | H: 3 | E: 0 | LOB: 1 | K: 1 | BB: 0 | S: 8 | P: 8 | R: 0 | H: 1 | E: 0 | LOB: 1 | K: 0 | BB: 0 | S: 4 | P: 4 | R: 0 | H: 1 | E: 0 | LOB: 1 | K: 0 | BB: 0 | S: 4 | P: 4 | R: 4 | H: 6 | E: 0 | LOB: 1 | K: 0 | BB: 0 | S: 8 | P: 8 | R: 0 | H: 0 | E: 0 | LOB: 1 | K: 2 | BB: 1 | S: 7 | P: 11 | R: 0 | H: 0 | E: 0 | LOB: 0 | K: 0 | BB: 0 | S: 3 | P: 3 | 1B: 5 | SF: 0 | 2B: 5 | SAC: 0 | 3B: 0 | DP: 1 | HR: 2 | HBP: 0 | WP: 0 | PA: 39 |
|--------------|------|------|------|--------|------|-------|------|------|------|------|------|--------|------|-------|------|------|------|------|------|--------|------|-------|------|------|------|------|------|--------|------|-------|------|------|------|------|------|--------|------|-------|------|------|------|------|------|--------|------|-------|------|------|------|------|------|--------|------|-------|------|------|------|------|------|--------|------|-------|------|-------|------|------|------|--------|------|-------|------|------|-------|-------|-------|--------|-------|-------|-------|--------|-------|--------|
|--------------|------|------|------|--------|------|-------|------|------|------|------|------|--------|------|-------|------|------|------|------|------|--------|------|-------|------|------|------|------|------|--------|------|-------|------|------|------|------|------|--------|------|-------|------|------|------|------|------|--------|------|-------|------|------|------|------|------|--------|------|-------|------|------|------|------|------|--------|------|-------|------|-------|------|------|------|--------|------|-------|------|------|-------|-------|-------|--------|-------|-------|-------|--------|-------|--------|

| PITCHER                            | IP  | WLS | BF | H  | R | ER | SO | BB | IBB | HBP | BLK | WP | HR | S  | P    | ERA   | WHIP  |
|------------------------------------|-----|-----|----|----|---|----|----|----|-----|-----|-----|----|----|----|------|-------|-------|
| Jack Lamabe, R (1, 1)<br>ERA: 3.84 | 6.2 | W   | 30 | 11 | 6 | 6  | 1  | 0  | 0   | 0   | 0   | 0  | 2  | 32 | 32   | 8.10  | 1.650 |
| Bob Heffner, R (7, 1)<br>ERA: 2.6  | 0.1 |     | 2  | 1  | 0 | 0  | 0  | 0  | 0   | 0   | 0   | 0  | 2  | 2  | 0.00 | 3.000 |       |
| Dick Radatz, R (8, 1)<br>ERA: 1.56 | 2.0 | S   | 7  | 0  | 0 | 0  | 2  | 1  | 0   | 0   | 0   | 0  | 0  | 10 | 14   | 0.00  | 0.500 |

| Batter  | 1   | 2   | 3   | 4   | 5   | 6   | 7   | 8   | 9   | AB R H RBI BB SO LOB                                       | TOP                                     |
|---|---|---|---|---|---|---|---|---|---|--|---|
| Dalton Jones, L (1, 4)<br>OBP: 0.336, SLG: 0.421      | 0-0 F3  |   | 0-3 K   |   | 0-0 L8  |   | 0-0 HR 1B   |   | 0-0 3-1   | 5 1 1 0 0 1 1  |   |
| Tony Conigliaro, R (1, 7)<br>OBP: 0.318, SLG: 0.503   | 0-3 K   |   | 0-3 K   |   | 0-3 K   |   | 0-0 F5  |   | 0-0 HR  | 5 1 1 2 0 3 2  |   |
| Carl Yastrzemski, L (1, 8)<br>OBP: 0.351, SLG: 0.411  | 4-0 FC6-4 BB  |   | 0-3 K   |   | 4-0 1B BB   |   | 0-0 HR  |   | 0-0 4-3   | 3 2 1 3 2 1 0  |   |
| Dick Stuart, R (1, 3)<br>OBP: 0.301, SLG: 0.466       | 0-0 FC6-4   |   | 0-3 K   |   | 0-0 F7  |   | 0-3 K   |   | 0-0   | 4 0 0 0 0 2 2  |   |
| Lee Thomas, L (1, 9)<br>OBP: 0.358, SLG: 0.422        |   | 0-0 1B 1B   |   | 0-0 HR 2B   |   | 0-0 F3  |   | 0-0 F5  |   | 4 2 2 0 0 0 1  |   |
| Frank Malzone, R (1, 5)<br>OBP: 0.335, SLG: 0.390     |   | 0-0 1B 1-2 1-3 1B                                   |   | 0-0 HR  |   | 0-0   |   | 0-0 F8  |   | 4 1 3 3 0 0 0  |   |
| Eddie Bressoud, R (1, 6)<br>OBP: 0.381, SLG: 0.428    |   | 0-3 K   |   | 0-0 L7  |   | 0-0 F6  |   | 0-3 K   |   | 4 0 0 0 0 2 3  |   |
| Bob Tillman, R (1, 2)<br>OBP: 0.351, SLG: 0.400       |   | 0-0 1-3 2-H 1B                                      |   | 0-3 K   |   | 0-0 6-3   |   | 0-0 6-3   |   | 4 0 1 1 0 1 0  |   |
| Bill Monbouquette, R (1, 1)<br>OBP: 0.304, SLG: 0.158 |   | 0-0 1-3   |   | 0-3 K   |   | 0-0 K   |   | 0-0 HR 1B   |   | 3 1 1 0 0 1 2  |   |
| Dick Radatz, R (8, 1)<br>OBP: 0.308, SLG: 0.385       |   | 3-H   |   |   |   |   |   | 3-1 HR 2B   |   | 1 1 1 0 0 0 0  |   |
| <b>Inning Stats</b>                                   | R: 0 H: 0<br>E: 0 LOB: 1<br>K: 1 BB: 1<br>S: 5 P: 9   | R: 1 H: 3<br>E: 0 LOB: 1<br>K: 1 BB: 0<br>S: 7 P: 7 | R: 0 H: 0<br>E: 0 LOB: 0<br>K: 3 BB: 0<br>S: 9 P: 9 | R: 2 H: 2<br>E: 0 LOB: 0<br>K: 2 BB: 0<br>S: 9 P: 9 | R: 0 H: 0<br>E: 0 LOB: 0<br>K: 2 BB: 0<br>S: 7 P: 7 | R: 1 H: 1<br>E: 0 LOB: 1<br>K: 0 BB: 1<br>S: 4 P: 8 | R: 3 H: 3<br>E: 0 LOB: 0<br>K: 1 BB: 0<br>S: 8 P: 8 | R: 0 H: 0<br>E: 0 LOB: 0<br>K: 1 BB: 0<br>S: 5 P: 5 | R: 2 H: 2<br>E: 0 LOB: 0<br>K: 0 BB: 0<br>S: 5 P: 5 | 1B: 6 SF: 0<br>2B: 2 SAC: 0<br>3B: 0 DP: 0<br>HR: 3 HBP: 0 | WP: 0 PA: 39<br>PB: 0<br>SB: 1<br>CS: 0 |
| <b>PITCHER</b>  | IP WLS BF H R ER SO BB IBB HBP BLK WP HR S P ERA WHIP |   |   |   |   |   |   |   |   |  |   |
| Orlando Pena, R (1, 1)<br>ERA: 3.96                   | 7.0 L 31 9 7 7 10 2 0 0 0 0 0 2 49 57 9.00 1.571      |   |   |   |   |   |   |   |   |  |   |
| Jose Santiago, R (8, 1)<br>ERA: 3.6                   | 2.0 8 2 2 2 1 0 0 0 0 0 0 1 10 10 9.00 1.000          |   |   |   |   |   |   |   |   |  |   |

Boston Red Sox @ Kansas City Athletics  
Municipal Stadium, Kansas City, MO  
Sun Jun 07 1964, 8:05 PM EDT  
Unknown

|     |    |
|-----|----|
| AB  | 37 |
| R   | 9  |
| H   | 11 |
| RBI | 9  |
| BB  | 2  |
| SO  | 11 |
| LOB | 11 |



| Batter   | 1       | 2      | 3       | 4       | 5       | 6         | 7         | 8      | 9       | AB | R | H | RBI | BB | SO | LOB |
|--|---------|--------|---------|---------|---------|-----------|-----------|--------|---------|----|---|---|-----|----|----|-----|
| Wayne Causey, L (1, 6)<br>OBP: 0.422, SLG: 0.424   | 0-0 L8  |        | 0-0 4-3 |         |         | 0-0 E4 HR | 0-0 1B    |        |         | 4  | 1 | 1 | 0   | 0  | 0  | 0   |
| Nelson Mathews, R (1, 8)<br>OBP: 0.304, SLG: 0.344 | 0-0 F6  |        | 0-3 K   |         |         | 0-0 F4    | 0-0 F2    |        |         | 4  | 0 | 0 | 0   | 0  | 1  | 2   |
| Ed Charles, R (1, 5)<br>OBP: 0.348, SLG: 0.379     | 0-0 4-3 |        |         | 0-0 1B  |         | 0-0 HR    |           | 0-0 F3 |         | 4  | 1 | 2 | 2   | 0  | 0  | 0   |
| Rocky Colavito, R (1, 9)<br>OBP: 0.398, SLG: 0.608 |         | 0-3 K  |         | 0-0 F9  |         | 0-0 5-3   |           | 0-0 L7 |         | 4  | 0 | 0 | 0   | 0  | 1  | 1   |
| Jim Gentile, L (1, 3)<br>OBP: 0.374, SLG: 0.515    |         | 0-0 L9 |         | 0-0 L8  |         | 0-0 3-1   |           | 0-3 K  |         | 4  | 0 | 0 | 0   | 0  | 1  | 1   |
| George Alusik, R (1, 7)<br>OBP: 0.412, SLG: 0.403  |         | 0-0 1B |         | 0-0 1-3 |         |           | 0-0 F4    |        | 0-0 F7  | 4  | 0 | 1 | 0   | 0  | 0  | 1   |
| Charlie Lau, L (1, 2)<br>OBP: 0.333, SLG: 0.413    |         | 0-0 F8 |         |         | 0-0 6-3 |           | 0-0 HR 1B |        | 0-0 L9  | 4  | 1 | 1 | 0   | 0  | 0  | 1   |
| Dick Green, R (1, 4)<br>OBP: 0.246, SLG: 0.331     |         |        | 0-0 4-3 |         | 0-0 F4  |           | 0-0 F7    |        | 0-0 5-3 | 4  | 0 | 0 | 0   | 0  | 0  | 1   |
| Orlando Pena, R (1, 1)<br>OBP: 0.171, SLG: 0.212   |         |        | 0-0 HR  |         | 0-3 K   |           | 0-0 HR    |        |         | 2  | 1 | 1 | 1   | 0  | 1  | 0   |
| Billy Bryan, L (7, PH)<br>OBP: 0.406, SLG: 0.667   |         |        |         |         |         |           |           |        |         | 1  | 1 | 1 | 2   | 0  | 0  | 0   |
| Jose Santiago, R (8, 1)                            |         |        |         |         |         |           |           |        |         | 0  | 0 | 0 | 0   | 0  | 0  | 0   |

| Inning Stats | R: 0 | H: 0 | E: 0 | K: 0 | S: 3 | R: 0 | H: 1 | E: 0 | K: 1 | S: 6 | R: 1 | H: 1 | E: 0 | K: 1 | S: 6 | R: 0 | H: 1 | E: 0 | K: 0 | S: 4 | R: 0 | H: 0 | E: 0 | K: 1 | S: 5 | R: 2 | H: 1 | E: 1 | K: 0 | S: 5 | R: 2 | H: 3 | E: 0 | K: 0 | S: 6 | R: 0 | H: 0 | E: 0 | K: 1 | S: 5 | R: 0 | H: 0 | E: 0 | K: 0 | S: 3 | 1B: 4 | 2B: 0 | 3B: 0 | HR: 3 | SF: 0 | SAC: 0 | DP: 0 | HBP: 0 | WP: 0 | PB: 0 | SB: 0 | CS: 0 | PA: 35 |
|--------------|------|------|------|------|------|------|------|------|------|------|------|------|------|------|------|------|------|------|------|------|------|------|------|------|------|------|------|------|------|------|------|------|------|------|------|------|------|------|------|------|------|------|------|------|------|-------|-------|-------|-------|-------|--------|-------|--------|-------|-------|-------|-------|--------|
|--------------|------|------|------|------|------|------|------|------|------|------|------|------|------|------|------|------|------|------|------|------|------|------|------|------|------|------|------|------|------|------|------|------|------|------|------|------|------|------|------|------|------|------|------|------|------|-------|-------|-------|-------|-------|--------|-------|--------|-------|-------|-------|-------|--------|

| PITCHER                                  | IP  | WLS | BF | H | R | ER | SO | BB | IBB | HBP | BLK | WP | HR | S  | P  | ERA  | WHIP  |
|--|-----|-----|----|---|---|----|----|----|-----|-----|-----|----|----|----|----|------|-------|
| Bill Monbouquette, R (1, 1)<br>ERA: 4.68 | 7.0 | W   | 29 | 7 | 5 | 4  | 3  | 0  | 0   | 0   | 0   | 0  | 3  | 35 | 35 | 5.14 | 1.000 |
| Dick Radatz, R (8, 1)<br>ERA: 1.5        | 2.0 | S   | 6  | 0 | 0 | 0  | 1  | 0  | 0   | 0   | 0   | 0  | 0  | 8  | 8  | 0.00 | 0.000 |

**BOTTOM**

**Boston Red Sox @ Kansas City Athletics**  
Municipal Stadium, Kansas City, MO

Sun Jun 07 1964, 8:05 PM EDT  
Unknown

|            |           |
|------------|-----------|
| <b>AB</b>  | <b>35</b> |
| <b>R</b>   | <b>5</b>  |
| <b>H</b>   | <b>7</b>  |
| <b>RBI</b> | <b>5</b>  |
| <b>BB</b>  | <b>0</b>  |
| <b>SO</b>  | <b>4</b>  |
| <b>LOB</b> | <b>7</b>  |



[livebaseballscorecards.com](http://livebaseballscorecards.com)

| Batter   | 1   | 2                               | 3                            | 4                                | 5                            | 6                               | 7                            | 8                                | 9                            | AB R H RBI BB SO LOB            | TOP                          |                                 |                              |                                 |                              |                                 |                              |                                 |                                  |                                    |                                  |        |
|--|---|---------------------------------|------------------------------|----------------------------------|------------------------------|---------------------------------|------------------------------|----------------------------------|------------------------------|---------------------------------|------------------------------|---------------------------------|------------------------------|---------------------------------|------------------------------|---------------------------------|------------------------------|---------------------------------|----------------------------------|------------------------------------|----------------------------------|--------|
| Dalton Jones, L (1, 4)<br>OBP: 0.331, SLG: 0.412     | 0-0<br>3-1  |                                 | 0-0<br>F2                    |                                  | 0-0<br>4-1                   |                                 | 0-0<br>F7                    |                                  | 0-0<br>1B<br>1-2<br>2-H      | 5 0 1 1 0 0 0                   |                              |                                 |                              |                                 |                              |                                 |                              |                                 |                                  |                                    |                                  |        |
| Tony Conigliaro, R (1, 7)<br>OBP: 0.326, SLG: 0.503  | 0-0<br>G5-4-3<br>1B                                   |                                 | 0-0<br>L9                    |                                  | 4-0<br>G4-6-3<br>BB          |                                 |                              | 0-0<br>5-3<br>1B                 | 0-0<br>F4                    | 4 0 2 0 1 0 2                   |                              |                                 |                              |                                 |                              |                                 |                              |                                 |                                  |                                    |                                  |        |
| Carl Yastrzemski, L (1, 8)<br>OBP: 0.347, SLG: 0.423 | 0-0<br>G5-4-3<br>1-2f                                 |                                 | 0-0<br>HR                    |                                  | 0-0<br>G4-6-3<br>1-2f        |                                 |                              | 0-0<br>5-3<br>1-2                | 0-3<br>K                     | 5 1 1 1 0 1 5                   |                              |                                 |                              |                                 |                              |                                 |                              |                                 |                                  |                                    |                                  |        |
| Dick Stuart, R (1, 3)<br>OBP: 0.300, SLG: 0.458      |   | 4-0<br>BB<br>1B<br>BB           | 0-0<br>L8                    |                                  | 0-3<br>K                     |                                 |                              | 0-0<br>5-3<br>2-3                |                              | 3 1 0 0 1 1 1                   |                              |                                 |                              |                                 |                              |                                 |                              |                                 |                                  |                                    |                                  |        |
| Lee Thomas, L (1, 9)<br>OBP: 0.356, SLG: 0.415       |   | 0-0<br>F9                       |                              | 4-0<br>S<br>BB                   |                              | 0-0<br>1-3                      |                              | 0-0<br>F3                        |                              | 3 0 0 0 1 0 2                   |                              |                                 |                              |                                 |                              |                                 |                              |                                 |                                  |                                    |                                  |        |
| Dick Williams, R (1, 5)<br>OBP: 0.240, SLG: 0.435    |   | 0-3<br>K                        |                              | 4-0<br>1-2<br>FC6-4<br>BB        |                              | 0-0<br>HR                       |                              | 0-0<br>HR                        |                              | 3 2 2 2 1 1 1                   |                              |                                 |                              |                                 |                              |                                 |                              |                                 |                                  |                                    |                                  |        |
| Eddie Bressoud, R (1, 6)<br>OBP: 0.379, SLG: 0.421   |   | 4-0<br>1B<br>E<br>BB            |                              | 0-0<br>F8                        |                              | 0-0<br>6-3                      |                              | 0-0<br>F6                        |                              | 3 1 0 0 1 0 2                   |                              |                                 |                              |                                 |                              |                                 |                              |                                 |                                  |                                    |                                  |        |
| Russ Nixon, L (1, 2)<br>OBP: 0.429, SLG: 0.455       |   | 0-0<br>E2                       |                              | 0-3<br>K                         |                              | 0-0<br>F6                       |                              | 0-0<br>1B<br>1B                  |                              | 2 0 1 1 0 1 2                   |                              |                                 |                              |                                 |                              |                                 |                              |                                 |                                  |                                    |                                  |        |
| Felix Mantilla, R (7, PH)<br>OBP: 0.255, SLG: 0.375  |   | 1-H<br>2-H<br>1B                |                              | 0-0<br>K                         |                              | 0-0<br>F9                       |                              | 0-0<br>1B<br>1B                  |                              | 1 0 0 0 0 0 0                   |                              |                                 |                              |                                 |                              |                                 |                              |                                 |                                  |                                    |                                  |        |
| Bob Tillman, R (7, 2)<br>OBP: 0.355, SLG: 0.404      |   | 0-3<br>K                        |                              | 0-0<br>FC6-4                     |                              | 0-0<br>F9                       |                              | 0-0<br>1B<br>1B                  |                              | 1 1 1 0 0 0 0                   |                              |                                 |                              |                                 |                              |                                 |                              |                                 |                                  |                                    |                                  |        |
| Dave Morehead, R (1, 1)<br>OBP: 0.125, SLG: 0.045    |   | 0-0<br>K                        |                              | 0-0<br>1-2f                      |                              |                                 |                              |                                  |                              | 1 0 0 0 0 0 1 1                 |                              |                                 |                              |                                 |                              |                                 |                              |                                 |                                  |                                    |                                  |        |
| Roman Mejias, R (4, PH)<br>OBP: 0.258, SLG: 0.397    |   |                                 |                              |                                  |                              |                                 |                              |                                  |                              | 1 0 0 0 0 0 0 2                 |                              |                                 |                              |                                 |                              |                                 |                              |                                 |                                  |                                    |                                  |        |
| Bob Hetner, R (4, 1)<br>OBP: 0.256, SLG: 0.714       |   |                                 |                              |                                  |                              |                                 |                              |                                  |                              | 0 0 0 0 0 0 0 0                 |                              |                                 |                              |                                 |                              |                                 |                              |                                 |                                  |                                    |                                  |        |
| Frank Malzone, R (7, PH)<br>OBP: 0.333, SLG: 0.388   |   |                                 |                              |                                  |                              |                                 |                              |                                  |                              | 1 0 0 0 0 0 0 0                 |                              |                                 |                              |                                 |                              |                                 |                              |                                 |                                  |                                    |                                  |        |
| Arnold Earley, L (7, 1)<br>OBP: 0.333, SLG: 0.388    |   |                                 |                              |                                  |                              |                                 |                              |                                  |                              | 0 0 0 0 0 0 0 0                 |                              |                                 |                              |                                 |                              |                                 |                              |                                 |                                  |                                    |                                  |        |
| Pete Charton, L (7, 1)<br>OBP: 0.333, SLG: 0.388     |   |                                 |                              |                                  |                              |                                 |                              |                                  |                              | 0 0 0 0 0 0 0 0                 |                              |                                 |                              |                                 |                              |                                 |                              |                                 |                                  |                                    |                                  |        |
| Chuck Schilling, R (9, PH)<br>OBP: 0.277, SLG: 0.284 |   |                                 |                              |                                  |                              |                                 |                              |                                  |                              | 1 0 1 0 0 0 0 0                 |                              |                                 |                              |                                 |                              |                                 |                              |                                 |                                  |                                    |                                  |        |
| <b>Inning Stats</b>                                  | R: 0<br>E: 0<br>K: 0<br>S: 3                          | H: 1<br>LOB: 0<br>BB: 0<br>P: 3 | R: 2<br>E: 1<br>K: 2<br>S: 8 | H: 1<br>LOB: 1<br>BB: 2<br>P: 16 | R: 1<br>E: 0<br>K: 0<br>S: 4 | H: 1<br>LOB: 0<br>BB: 0<br>P: 4 | R: 0<br>E: 0<br>K: 1<br>S: 5 | H: 0<br>LOB: 2<br>BB: 2<br>P: 13 | R: 0<br>E: 0<br>K: 0<br>S: 2 | H: 0<br>LOB: 0<br>BB: 1<br>P: 6 | R: 1<br>E: 0<br>K: 1<br>S: 6 | H: 1<br>LOB: 0<br>BB: 0<br>P: 6 | R: 0<br>E: 0<br>K: 0<br>S: 3 | H: 0<br>LOB: 0<br>BB: 0<br>P: 3 | R: 0<br>E: 0<br>K: 0<br>S: 4 | H: 1<br>LOB: 1<br>BB: 0<br>P: 4 | R: 2<br>E: 0<br>K: 1<br>S: 9 | H: 4<br>LOB: 2<br>BB: 0<br>P: 9 | 1B: 6<br>2B: 0<br>3B: 0<br>HR: 3 | SF: 0<br>SAC: 0<br>DP: 2<br>HBP: 0 | WP: 0<br>PB: 0<br>SB: 1<br>CS: 0 | PA: 39 |
| <b>PITCHER</b>                                       | IP WLS BF H R ER SO BB IBB HBP BLK WP HR S P ERA WHIP |                                 |                              |                                  |                              |                                 |                              |                                  |                              |                                 |                              |                                 |                              |                                 |                              |                                 |                              |                                 |                                  |                                    |                                  |        |
| Diego Segui, R (1, 1)<br>ERA: 4.1                    | 8.1 W 35 7 6 6 4 5 0 0 0 0 0 3 38 58 6.48 1.440       |                                 |                              |                                  |                              |                                 |                              |                                  |                              |                                 |                              |                                 |                              |                                 |                              |                                 |                              |                                 |                                  |                                    |                                  |        |
| John Wyatt, R (9, 1)<br>ERA: 2.08                    | 0.2 S 4 2 0 0 1 0 0 0 0 0 0 0 6 6 0.00 3.000          |                                 |                              |                                  |                              |                                 |                              |                                  |                              |                                 |                              |                                 |                              |                                 |                              |                                 |                              |                                 |                                  |                                    |                                  |        |

**Boston Red Sox @ Kansas City Athletics**  
**Municipal Stadium, Kansas City, MO**  
 Sun Jun 07 1964, 8:05 PM EDT  
 Att. 9,061 - Unknown

|     |    |
|-----|----|
| AB  | 34 |
| R   | 6  |
| H   | 9  |
| RBI | 5  |
| BB  | 5  |
| SO  | 5  |
| LOB | 18 |





| Batter  | 1   | 2   | 3   | 4   | 5   | 6   | 7   | 8   | 9   | AB  | R   | H   | RBI   | BB  | SO  | LOB   | BOTTOM  |        |
|---|---|---|---|---|---|---|---|---|---|---|---|---|---|---|---|---|---|--------|
| Wayne Causey, L<br>OBP: 0.417, SLG: 0.418<br>(1, 6)                 | 0-3<br>K  | 0-0<br>1B   |   | 0-0<br>L8   |   | 0-0<br>F7   |   | 0-0<br>4-3  |   | 5   | 0   | 1   | 2   | 0   | 1   | 1   | <b>Boston Red Sox @ Kansas City Athletics</b><br>Municipal Stadium, Kansas City, MO<br>Sun Jun 07 1964, 8:05 PM EDT<br>Att. 9,061 - Unknown |        |
| Dick Green, R<br>OBP: 0.246, SLG: 0.325<br>(1, 4)                   | 0-0<br>G3   | 0-3<br>K  |   | 4-0<br>BB   |   |   | 0-0<br>L6   |   |   | 3   | 0   | 0   | 0   | 1   | 1   | 2   |   |        |
| Ed Charles, R<br>OBP: 0.351, SLG: 0.382<br>(1, 5)                   | 0-3<br>K  |   | 0-0<br>HR   | 0-0<br>L6   |   |   | 0-0<br>HR   |   |   | 4   | 2   | 2   | 0   | 0   | 1   | 1   |   |        |
| Rocky Colavito, R<br>OBP: 0.400, SLG: 0.605<br>(1, 9)               |   | 0-0<br>1B   | 0-0<br>F5   |   | 0-0<br>L5   |   | 0-0<br>HR   |   |   | 4   | 2   | 2   | 0   | 0   | 0   | 1   |   |        |
| Jim Gentile, L<br>OBP: 0.389, SLG: 0.569<br>(1, 3)                  |   | 0-0<br>1B   | 0-0<br>HR   |   | 1-0<br>HBP  |   | 0-0<br>HR   |   |   | 3   | 3   | 3   | 5   | 0   | 0   | 0   |   |        |
| George Alusik, R<br>OBP: 0.426, SLG: 0.413<br>(1, 7)                |   | 0-0<br>1B   | 4-0<br>BB   |   | 0-0<br>G5-4-3   |   | 0-0<br>K2-4-2   |   |   | 3   | 1   | 2   | 0   | 1   | 0   | 1   |   |        |
| Doc Edwards, R<br>OBP: 0.253, SLG: 0.271<br>(1, 2)                  |   | 0-0<br>1B   | 0-3<br>K  |   | 0-0<br>L5   |   | 0-3<br>K2-4-2   |   |   | 4   | 0   | 1   | 1   | 0   | 2   | 2   |   |        |
| Nelson Mathews, R<br>OBP: 0.303, SLG: 0.342<br>(1, 8)               |   | 0-3<br>K  | 0-0<br>F4   |   | 0-0<br>1B   |   | 0-0<br>6-3  |   |   | 4   | 0   | 1   | 0   | 0   | 1   | 4   |   |        |
| Diego Segui, R<br>OBP: 0.185, SLG: 0.269<br>John Wyatt, R<br>(9, 1) |   | 0-3<br>K  |   | 0-3<br>K  |   | 0-3<br>K  |   | 0-0<br>G3   |   | 4   | 0   | 0   | 0   | 0   | 3   | 4   |   |        |
|   |   |   |   |   |   |   |   |   |   | 0   | 0   | 0   | 0   | 0   | 0   | 0   |   |        |
| <b>Inning Stats</b>   | R: 0<br>E: 0<br>K: 2<br>S: 7  | H: 0<br>LOB: 0<br>BB: 0<br>P: 7   | R: 3<br>E: 0<br>K: 3<br>S: 14   | H: 5<br>LOB: 2<br>BB: 0<br>P: 14  | R: 2<br>E: 0<br>K: 1<br>S: 7  | H: 2<br>LOB: 1<br>BB: 1<br>P: 11  | R: 0<br>E: 0<br>K: 1<br>S: 5  | H: 0<br>LOB: 1<br>BB: 1<br>P: 9   | R: 0<br>E: 0<br>K: 1<br>S: 6  | H: 1<br>LOB: 1<br>BB: 0<br>P: 6   | R: 3<br>E: 0<br>K: 1<br>S: 8  | H: 4<br>LOB: 1<br>BB: 0<br>P: 8   | R: 0<br>E: 0<br>K: 0<br>S: 3  | H: 0<br>LOB: 0<br>BB: 0<br>P: 3   | 1B: 10<br>2B: 1<br>3B: 0<br>HR: 2   | SF: 0<br>SAC: 0<br>DP: 2<br>HBP: 1  | WP: 0<br>PB: 0<br>SB: 0<br>CS: 0  | PA: 37 |
| <b>PITCHER</b>  | IP<br>WLS<br>BF<br>H<br>R<br>ER<br>SO<br>BB<br>IBB<br>HBP<br>BLK<br>WP<br>HR<br>S<br>P<br>ERA<br>WHIP | IP<br>WLS<br>BF<br>H<br>R<br>ER<br>SO<br>BB<br>IBB<br>HBP<br>BLK<br>WP<br>HR<br>S<br>P<br>ERA<br>WHIP | IP<br>WLS<br>BF<br>H<br>R<br>ER<br>SO<br>BB<br>IBB<br>HBP<br>BLK<br>WP<br>HR<br>S<br>P<br>ERA<br>WHIP | IP<br>WLS<br>BF<br>H<br>R<br>ER<br>SO<br>BB<br>IBB<br>HBP<br>BLK<br>WP<br>HR<br>S<br>P<br>ERA<br>WHIP | IP<br>WLS<br>BF<br>H<br>R<br>ER<br>SO<br>BB<br>IBB<br>HBP<br>BLK<br>WP<br>HR<br>S<br>P<br>ERA<br>WHIP | IP<br>WLS<br>BF<br>H<br>R<br>ER<br>SO<br>BB<br>IBB<br>HBP<br>BLK<br>WP<br>HR<br>S<br>P<br>ERA<br>WHIP | IP<br>WLS<br>BF<br>H<br>R<br>ER<br>SO<br>BB<br>IBB<br>HBP<br>BLK<br>WP<br>HR<br>S<br>P<br>ERA<br>WHIP | IP<br>WLS<br>BF<br>H<br>R<br>ER<br>SO<br>BB<br>IBB<br>HBP<br>BLK<br>WP<br>HR<br>S<br>P<br>ERA<br>WHIP | IP<br>WLS<br>BF<br>H<br>R<br>ER<br>SO<br>BB<br>IBB<br>HBP<br>BLK<br>WP<br>HR<br>S<br>P<br>ERA<br>WHIP | IP<br>WLS<br>BF<br>H<br>R<br>ER<br>SO<br>BB<br>IBB<br>HBP<br>BLK<br>WP<br>HR<br>S<br>P<br>ERA<br>WHIP | IP<br>WLS<br>BF<br>H<br>R<br>ER<br>SO<br>BB<br>IBB<br>HBP<br>BLK<br>WP<br>HR<br>S<br>P<br>ERA<br>WHIP | IP<br>WLS<br>BF<br>H<br>R<br>ER<br>SO<br>BB<br>IBB<br>HBP<br>BLK<br>WP<br>HR<br>S<br>P<br>ERA<br>WHIP | IP<br>WLS<br>BF<br>H<br>R<br>ER<br>SO<br>BB<br>IBB<br>HBP<br>BLK<br>WP<br>HR<br>S<br>P<br>ERA<br>WHIP | IP<br>WLS<br>BF<br>H<br>R<br>ER<br>SO<br>BB<br>IBB<br>HBP<br>BLK<br>WP<br>HR<br>S<br>P<br>ERA<br>WHIP | IP<br>WLS<br>BF<br>H<br>R<br>ER<br>SO<br>BB<br>IBB<br>HBP<br>BLK<br>WP<br>HR<br>S<br>P<br>ERA<br>WHIP | IP<br>WLS<br>BF<br>H<br>R<br>ER<br>SO<br>BB<br>IBB<br>HBP<br>BLK<br>WP<br>HR<br>S<br>P<br>ERA<br>WHIP | IP<br>WLS<br>BF<br>H<br>R<br>ER<br>SO<br>BB<br>IBB<br>HBP<br>BLK<br>WP<br>HR<br>S<br>P<br>ERA<br>WHIP                                       |        |
| Dave Morehead, R<br>ERA: 4.41<br>(1, 1)                             | 3.0<br>L  | 17  | 7   | 5   | 5   | 6   | 1   | 0   | 0   | 0   | 0   | 0   | 0   | 0   | 0   | 0   | 15.00   | 2.667  |
| Bob Heffner, R<br>ERA: 2.39<br>(4, 1)                               | 3.0   | 11  | 1   | 0   | 0   | 2   | 1   | 0   | 1   | 0   | 0   | 0   | 0   | 0   | 0   | 0   | 0.00  | 0.667  |
| Arnold Earley, L<br>ERA: 2.57<br>(7, 1)                             | 0.1   | 5   | 4   | 3   | 3   | 0   | 0   | 0   | 0   | 0   | 0   | 0   | 0   | 0   | 0   | 0   | 81.00   | 12.000 |
| Pete Charton, R<br>ERA: 9.0<br>(7, 1)                               | 1.2   | 4   | 0   | 0   | 0   | 1   | 0   | 0   | 0   | 0   | 0   | 0   | 0   | 0   | 0   | 0   | 0.00  | 0.000  |

livebaseballscorecards.com



| Batter   | 1   | 2                               | 3                            | 4                               | 5                            | 6                               | 7                            | 8                               | 9                            | AB R H RBI BB SO LOB            | TOP  |                                 |                              |                                 |                              |                                  |                              |                                  |                                  |                                    |   |        |   |     |    |  |  |  |  |  |  |  |  |  |  |  |
|--|---|---------------------------------|------------------------------|---------------------------------|------------------------------|---------------------------------|------------------------------|---------------------------------|------------------------------|---------------------------------|--|---------------------------------|------------------------------|---------------------------------|------------------------------|----------------------------------|------------------------------|----------------------------------|----------------------------------|------------------------------------|---|--------|---|-----|----|--|--|--|--|--|--|--|--|--|--|--|
| Wayne Causey, L (1, 6)<br>OBP: 0.417, SLG: 0.420     | 0-0<br>6-3  |                                 | 0-0<br>2B                    |                                 |                              | 0-3<br>K                        |                              | 0-0<br>F7                       | 4-0<br>BB                    | 4 0 1 0 1 1 1                   | <p>Kansas City Athletics @ Washington Senators<br/>D.C. Stadium, Washington, DC</p> <p>Mon Jun 08 1964, 7:05 PM EDT<br/>Att. 3,765 - Unknown</p> <p>livebaseballscorecards.com</p> <table border="1"> <tr><td>AB</td><td>35</td></tr> <tr><td>R</td><td>5</td></tr> <tr><td>H</td><td>10</td></tr> <tr><td>RBI</td><td>5</td></tr> <tr><td>BB</td><td>3</td></tr> <tr><td>SO</td><td>8</td></tr> <tr><td>LOB</td><td>13</td></tr> </table>  | AB                              | 35                           | R                               | 5                            | H                                | 10                           | RBI                              | 5                                | BB                                 | 3   | SO     | 8 | LOB | 13 |  |  |  |  |  |  |  |  |  |  |  |
| AB   | 35  |                                 |                              |                                 |                              |                                 |                              |                                 |                              |                                 |  |                                 |                              |                                 |                              |                                  |                              |                                  |                                  |                                    |   |        |   |     |    |  |  |  |  |  |  |  |  |  |  |  |
| R  | 5   |                                 |                              |                                 |                              |                                 |                              |                                 |                              |                                 |  |                                 |                              |                                 |                              |                                  |                              |                                  |                                  |                                    |   |        |   |     |    |  |  |  |  |  |  |  |  |  |  |  |
| H  | 10  |                                 |                              |                                 |                              |                                 |                              |                                 |                              |                                 |  |                                 |                              |                                 |                              |                                  |                              |                                  |                                  |                                    |   |        |   |     |    |  |  |  |  |  |  |  |  |  |  |  |
| RBI  | 5   |                                 |                              |                                 |                              |                                 |                              |                                 |                              |                                 |  |                                 |                              |                                 |                              |                                  |                              |                                  |                                  |                                    |   |        |   |     |    |  |  |  |  |  |  |  |  |  |  |  |
| BB   | 3   |                                 |                              |                                 |                              |                                 |                              |                                 |                              |                                 |  |                                 |                              |                                 |                              |                                  |                              |                                  |                                  |                                    |   |        |   |     |    |  |  |  |  |  |  |  |  |  |  |  |
| SO   | 8   |                                 |                              |                                 |                              |                                 |                              |                                 |                              |                                 |  |                                 |                              |                                 |                              |                                  |                              |                                  |                                  |                                    |   |        |   |     |    |  |  |  |  |  |  |  |  |  |  |  |
| LOB  | 13  |                                 |                              |                                 |                              |                                 |                              |                                 |                              |                                 |  |                                 |                              |                                 |                              |                                  |                              |                                  |                                  |                                    |   |        |   |     |    |  |  |  |  |  |  |  |  |  |  |  |
| Dick Green, R (1, 4)<br>OBP: 0.239, SLG: 0.315       | 0-0<br>6-3  |                                 | 0-3<br>K                     |                                 |                              | 0-3<br>K                        |                              | 0-0<br>FC5-4<br>2B<br>1B        | 0-0<br>F3                    | 5 1 0 0 0 2 4                   |  |                                 |                              |                                 |                              |                                  |                              |                                  |                                  |                                    |   |        |   |     |    |  |  |  |  |  |  |  |  |  |  |  |
| Ed Charles, R (1, 5)<br>OBP: 0.352, SLG: 0.404       | 0-0<br>HR   |                                 | 0-0<br>4-3                   |                                 |                              | 0-0<br>6-3                      |                              | 0-0<br>1B<br>2B                 | 0-3<br>K                     | 5 2 2 1 0 1 3                   |  |                                 |                              |                                 |                              |                                  |                              |                                  |                                  |                                    |   |        |   |     |    |  |  |  |  |  |  |  |  |  |  |  |
| Rocky Colavito, R (1, 9)<br>OBP: 0.397, SLG: 0.596   | 0-3<br>K  |                                 |                              | 0-0<br>F7                       |                              |                                 | 0-0<br>P6                    | 0-0<br>HR<br>1B                 |                              | 4 1 1 2 0 1 0                   |  |                                 |                              |                                 |                              |                                  |                              |                                  |                                  |                                    |   |        |   |     |    |  |  |  |  |  |  |  |  |  |  |  |
| Jose Tartabull, L (8, 9)<br>OBP: 0.176, SLG: 0.235   |   |                                 |                              |                                 |                              |                                 |                              |                                 |                              | 0 0 0 0 0 0 0                   |  |                                 |                              |                                 |                              |                                  |                              |                                  |                                  |                                    |   |        |   |     |    |  |  |  |  |  |  |  |  |  |  |  |
| George Alusik, R (1, 3)<br>OBP: 0.429, SLG: 0.452    |   | 0-0<br>4-3<br>1B<br>1B          |                              | 0-3<br>K                        |                              |                                 | 0-0<br>4-3                   | 0-0<br>HR<br>HR                 |                              | 4 1 2 2 0 1 0                   |  |                                 |                              |                                 |                              |                                  |                              |                                  |                                  |                                    |   |        |   |     |    |  |  |  |  |  |  |  |  |  |  |  |
| Doc Edwards, R (1, 2)<br>OBP: 0.264, SLG: 0.281      |   | 0-0<br>4-3<br>1-2               |                              | 0-0<br>6-3                      |                              |                                 | 0-0<br>BB<br>1B              | 0-0<br>WP<br>1B                 |                              | 4 0 2 0 0 0 1                   |  |                                 |                              |                                 |                              |                                  |                              |                                  |                                  |                                    |   |        |   |     |    |  |  |  |  |  |  |  |  |  |  |  |
| John Wojcik, L (1, 7)<br>OBP: 0.500, SLG: 0.333      |   | 0-0<br>FC5-4<br>1B              |                              |                                 | 0-0<br>F9                    |                                 | 4-0<br>BB<br>1B              | 0-0<br>F5                       |                              | 3 0 1 0 1 0 1                   |  |                                 |                              |                                 |                              |                                  |                              |                                  |                                  |                                    |   |        |   |     |    |  |  |  |  |  |  |  |  |  |  |  |
| Nelson Mathews, R (1, 8)<br>OBP: 0.302, SLG: 0.340   |   | 0-0<br>FC5-4<br>1-2f            |                              |                                 | 0-3<br>K                     |                                 | 0-0<br>F9                    |                                 | 0-0<br>SH4<br>1B             | 4 0 1 0 0 1 3                   |  |                                 |                              |                                 |                              |                                  |                              |                                  |                                  |                                    |   |        |   |     |    |  |  |  |  |  |  |  |  |  |  |  |
| Moe Drabowsky, R (1, 1)<br>OBP: 0.048, SLG: 0.048    |   |                                 | 0-3<br>K                     |                                 |                              | 0-0<br>F8                       |                              | 4-0<br>FC5-4<br>BB              | 0-0<br>SH4                   | 2 0 0 0 0 1 0                   |  |                                 |                              |                                 |                              |                                  |                              |                                  |                                  |                                    |   |        |   |     |    |  |  |  |  |  |  |  |  |  |  |  |
| George Williams, R (8, PH)<br>OBP: 0.171, SLG: 0.094 |   |                                 |                              |                                 |                              |                                 |                              |                                 | 0-0<br>SH4                   | 0 0 0 0 1 0 0                   |  |                                 |                              |                                 |                              |                                  |                              |                                  |                                  |                                    |   |        |   |     |    |  |  |  |  |  |  |  |  |  |  |  |
| John Wyatt, R (8, 1)                                 |   |                                 |                              |                                 |                              |                                 |                              |                                 | 1-2                          | 0 0 0 0 0 0 0                   |  |                                 |                              |                                 |                              |                                  |                              |                                  |                                  |                                    |   |        |   |     |    |  |  |  |  |  |  |  |  |  |  |  |
| <b>Inning Stats</b>                                  | R: 1<br>E: 0<br>K: 1<br>S: 6  | H: 1<br>LOB: 0<br>BB: 0<br>P: 6 | R: 0<br>E: 0<br>K: 0<br>S: 4 | H: 2<br>LOB: 1<br>BB: 0<br>P: 4 | R: 0<br>E: 0<br>K: 2<br>S: 8 | H: 1<br>LOB: 1<br>BB: 0<br>P: 8 | R: 0<br>E: 0<br>K: 1<br>S: 5 | H: 0<br>LOB: 0<br>BB: 0<br>P: 5 | R: 0<br>E: 0<br>K: 1<br>S: 5 | H: 0<br>LOB: 0<br>BB: 0<br>P: 5 | R: 0<br>E: 0<br>K: 2<br>S: 7   | H: 0<br>LOB: 0<br>BB: 0<br>P: 7 | R: 0<br>E: 0<br>K: 0<br>S: 4 | H: 1<br>LOB: 2<br>BB: 1<br>P: 8 | R: 4<br>E: 0<br>K: 0<br>S: 7 | H: 4<br>LOB: 1<br>BB: 1<br>P: 11 | R: 0<br>E: 0<br>K: 1<br>S: 6 | H: 1<br>LOB: 2<br>BB: 1<br>P: 10 | 1B: 6<br>2B: 2<br>3B: 0<br>HR: 2 | SF: 0<br>SAC: 1<br>DP: 0<br>HBP: 0 | WP: 1<br>PB: 0<br>SB: 0<br>CS: 0  | PA: 39 |   |     |    |  |  |  |  |  |  |  |  |  |  |  |
| <b>PITCHER</b>                                       | IP<br>WLS<br>BF<br>H<br>R<br>ER<br>SO<br>BB<br>IBB<br>HBP<br>BLK<br>WP<br>HR<br>S<br>P<br>ERA<br>WHIP |                                 |                              |                                 |                              |                                 |                              |                                 |                              |                                 |  |                                 |                              |                                 |                              |                                  |                              |                                  |                                  |                                    | IP<br>WLS<br>BF<br>H<br>R<br>ER<br>SO<br>BB<br>IBB<br>HBP<br>BLK<br>WP<br>HR<br>S<br>P<br>ERA<br>WHIP |        |   |     |    |  |  |  |  |  |  |  |  |  |  |  |
| Claude Osteen, L (1, 1)<br>ERA: 3.21                 | 7.0   |                                 | 27                           | 5                               | 2                            | 2                               | 7                            | 2                               | 0                            | 0                               | 0  | 0                               | 1                            | 39                              | 47                           | 2.57                             | 1.000                        |                                  |                                  |                                    |   |        |   |     |    |  |  |  |  |  |  |  |  |  |  |  |
| Jim Duckworth, R (8, 1)<br>ERA: 2.89                 | 0.2   | L                               | 5                            | 3                               | 3                            | 3                               | 0                            | 0                               | 0                            | 0                               | 0  | 0                               | 1                            | 5                               | 5                            | 40.50                            | 4.500                        |                                  |                                  |                                    |   |        |   |     |    |  |  |  |  |  |  |  |  |  |  |  |
| Steve Ridzik, R (8, 1)<br>ERA: 2.91                  | 1.1   |                                 | 7                            | 2                               | 0                            | 0                               | 1                            | 1                               | 0                            | 0                               | 0  | 1                               | 0                            | 8                               | 12                           | 0.00                             | 2.250                        |                                  |                                  |                                    |   |        |   |     |    |  |  |  |  |  |  |  |  |  |  |  |

| Batter   | 1   | 2  | 3   | 4   | 5   | 6   | 7  | 8  | 9   | AB R H RBI BB SO LOB                                       | BOTTOM  |
|--|---|--|---|---|---|---|--|--|---|--|---|
| Don Blasingame, L (1, 4)<br>OBP: 0.313, SLG: 0.323     | 0-0<br>G1-4-3<br>1B                                   |  | 0-0<br>1-3  |   | 0-0<br>F7   |   | 0-0<br>BB  |  | 0-0<br>2B   | 4 0 2 0 1 0 1  | <b>Kansas City Athletics @ Washington Senators</b><br><b>D.C. Stadium, Washington, DC</b><br>Mon Jun 08 1964, 7:05 PM EDT<br>Att. 3,765 - Unknown |
| John Kennedy, R (1, 5)<br>OBP: 0.324, SLG: 0.428       | 0-0<br>G1-4-3<br>1-2f                                 |  | 0-3<br>K  |   | 0-0<br>F5   |   | 0-3<br>K   |  | 0-3<br>K  | 5 0 0 0 0 3 5  |   |
| Chuck Hinton, R (1, 7)<br>OBP: 0.391, SLG: 0.537       | 0-0<br>F8   |  | 0-0<br>2B   |   | 0-0<br>F8   |   | 0-0<br>P3  |  | 0-0<br>P3   | 5 0 1 0 0 0 1  |   |
| Jim King, L (1, 9)<br>OBP: 0.339, SLG: 0.494           |   | 0-0<br>HR  | 0-0<br>1-3  |   | 0-0<br>HR   |   | 0-0<br>HR  |  |   | 4 3 3 3 0 0 1  |   |
| Dick Phillips, L (1, 3)<br>OBP: 0.333, SLG: 0.344      |   | 4-0<br>BB  |   | 0-0<br>F9   |   | 0-0<br>F9   |  | 0-0<br>F8  |   | 3 0 0 0 1 0 0  |   |
| Mike Brumley, L (1, 2)<br>OBP: 0.326, SLG: 0.283       |   | 0-0<br>G4-6-3<br>1-2f                                |   | 0-0<br>F7   |   | 0-0<br>F5   |  | 4-0<br>BB  |   | 3 0 0 0 1 0 1  |   |
| Fred Valentine, S (1, 8)<br>OBP: 0.280, SLG: 0.303     |   | 1-0<br>WP S<br>HBP                                   |   | 0-3<br>K  |   | 0-0<br>SH3-4<br>1B                                  |  | 0-3<br>K   |   | 2 0 1 0 0 1 0  |   |
| Don Lock, R (8, PH)<br>OBP: 0.364, SLG: 0.421          |   |  |   |   |   |   |  |  |   | 1 0 0 0 0 1 1  |   |
| Ed Brinkman, R (1, 6)<br>OBP: 0.229, SLG: 0.310        |   | 4-0<br>BB  |   | 0-0<br>SH3-4<br>1B                                  |   | 0-0<br>SH3-4  |  | 0-0<br>HR  |   | 1 0 1 0 1 0 0  |   |
| Don Zimmer, R (9, PH)<br>OBP: 0.291, SLG: 0.461        |   | 1-3<br>BB  |   | 0-0<br>SH3-4<br>1B                                  |   | 1-2<br>SH3-4  |  |  |   | 1 1 1 1 0 0 0  |   |
| Claude Osteen, L (1, 1)<br>OBP: 0.176, SLG: 0.188      |   | 0-0<br>4-3   |   | 0-0<br>SH3-4  |   | 0-0<br>4-3  |  | 0-3<br>K   |   | 2 0 0 0 0 0 3  |   |
| Jim Duckworth, R (8, 1)<br>OBP: 0.333, SLG: 0.200      |   |  |   |   |   |   |  |  |   | 0 0 0 0 0 0 0  |   |
| Steve Ridzik, R (8, 1)<br>OBP: 0.375, SLG: 0.286       |   |  |   |   |   |   |  |  |   | 0 0 0 0 0 0 0  |   |
| Bill Skowron, R (9, PH)<br>OBP: 0.296, SLG: 0.482      |   |  |   |   |   |   |  |  |   | 1 0 0 0 0 1 0  |   |
| <b>Inning Stats</b>                                    | R: 0 H: 1<br>E: 0 LOB: 0<br>K: 0 BB: 0<br>S: 3 P: 3   | R: 1 H: 1<br>E: 0 LOB: 2<br>K: 0 BB: 2<br>S: 3 P: 12 | R: 0 H: 1<br>E: 0 LOB: 1<br>K: 1 BB: 0<br>S: 6 P: 6 | R: 0 H: 0<br>E: 0 LOB: 0<br>K: 1 BB: 0<br>S: 5 P: 5 | R: 0 H: 1<br>E: 0 LOB: 1<br>K: 0 BB: 0<br>S: 4 P: 4 | R: 1 H: 1<br>E: 0 LOB: 0<br>K: 0 BB: 0<br>S: 4 P: 4 | R: 0 H: 1<br>E: 0 LOB: 2<br>K: 1 BB: 1<br>S: 6 P: 10 | R: 1 H: 1<br>E: 0 LOB: 1<br>K: 1 BB: 1<br>S: 6 P: 10 | R: 1 H: 2<br>E: 0 LOB: 1<br>K: 2 BB: 0<br>S: 9 P: 9 | 1B: 3 SF: 0<br>2B: 2 SAC: 2<br>3B: 0 DP: 2<br>HR: 4 HBP: 1 | WP: 1 PA: 39<br>PB: 0<br>SB: 1<br>CS: 0   |
| <b>PITCHER</b><br>Moe Drabowsky, R (1, 1)<br>ERA: 6.27 | IP WLS BF H R ER SO BB IBB HBP BLK WP HR S P ERA WHIP | 7.0 W 29 6 2 2 3 3 0 1 0 0 1 2 31 44 2.57 1.286      |   |   |   |   |  |  |   |  |   |
| John Wyatt, R (8, 1)<br>ERA: 2.51                      | 2.0 S 10 3 2 2 3 1 0 0 0 0 0 2 15 19 9.00 2.000       |  |   |   |   |   |  |  |   |  |   |

|            |           |
|------------|-----------|
| <b>AB</b>  | <b>32</b> |
| <b>R</b>   | <b>4</b>  |
| <b>H</b>   | <b>9</b>  |
| <b>RBI</b> | <b>4</b>  |
| <b>BB</b>  | <b>4</b>  |
| <b>SO</b>  | <b>6</b>  |
| <b>LOB</b> | <b>13</b> |



livebaseballscorecards.com

| Batter  | 1   | 2                               | 3                            | 4                               | 5                            | 6                               | 7                            | 8                               | 9                            | AB R H RBI BB SO LOB            | TOP   |                                 |  |                                 |                              |                                 |                              |                                 |                                  |                                    |                                  |        |
|---|---|---------------------------------|------------------------------|---------------------------------|------------------------------|---------------------------------|------------------------------|---------------------------------|------------------------------|---------------------------------|---|---------------------------------|--|---------------------------------|------------------------------|---------------------------------|------------------------------|---------------------------------|----------------------------------|------------------------------------|----------------------------------|--------|
| Wayne Causey, L (1, 6)<br>OBP: 0.416, SLG: 0.419      | 0-0<br>HR<br>1B   | 0-0<br>F9                       |                              |                                 | 0-0<br>F8                    |                                 | 0-0<br>1B<br>1B              |                                 | 0-0<br>F2                    | 5 1 2 0 0 0 1                   | <p>Kansas City Athletics @ Washington Senators<br/>D.C. Stadium, Washington, DC</p> <p>Tue Jun 09 1964, 3:33 AM EDT<br/>Unknown</p> <p>livebaseballscorecards.com</p> |                                 |  |                                 |                              |                                 |                              |                                 |                                  |                                    |                                  |        |
| Dick Green, R (1, 4)<br>OBP: 0.250, SLG: 0.343        | 0-0<br>1-H<br>HR  |                                 | 0-0<br>5-3                   |                                 | 0-0<br>1-2<br>1B             |                                 | 0-0<br>1-2<br>1B             |                                 |                              | 4 1 3 2 0 0 0                   |   |                                 |  |                                 |                              |                                 |                              |                                 |                                  |                                    |                                  |        |
| Ed Charles, R (1, 5)<br>OBP: 0.346, SLG: 0.396        | 0-0<br>P6   |                                 | 0-0<br>6-3                   |                                 | 0-3<br>K                     |                                 | 0-0<br>F9                    |                                 |                              | 4 0 0 0 0 1 4                   |   |                                 |  |                                 |                              |                                 |                              |                                 |                                  |                                    |                                  |        |
| Rocky Colavito, R (1, 9)<br>OBP: 0.389, SLG: 0.582    | 0-0<br>F5   |                                 | 0-0<br>1-3                   |                                 | 0-0<br>6-3                   |                                 | 0-0<br>F7                    |                                 |                              | 4 0 0 0 0 0 0                   |   |                                 |  |                                 |                              |                                 |                              |                                 |                                  |                                    |                                  |        |
| Jim Gentile, L (1, 3)<br>OBP: 0.392, SLG: 0.564       | 0-3<br>K  |                                 |                              | 0-0<br>G3                       |                              | 0-0<br>1B<br>3-2<br>1B          |                              | 4-0<br>BB<br>BB<br>BB           |                              | 3 0 1 0 1 1 0                   |   |                                 |  |                                 |                              |                                 |                              |                                 |                                  |                                    |                                  |        |
| Charlie Lau, L (1, 2)<br>OBP: 0.331, SLG: 0.407       |   | 0-3<br>K                        |                              | 0-0<br>F7                       |                              | 0-0<br>1-3<br>1B                |                              | 0-0<br>P6                       |                              | 4 0 1 0 0 1 1                   |   |                                 |  |                                 |                              |                                 |                              |                                 |                                  |                                    |                                  |        |
| John Wojcik, L (1, 7)<br>OBP: 0.375, SLG: 0.286       |   | 0-0<br>HR<br>1B                 |                              | 0-0<br>4-3                      |                              | 0-0<br>3-2<br>3-H               |                              | 0-0<br>P6                       |                              | 4 1 1 0 0 0 3                   |   |                                 |  |                                 |                              |                                 |                              |                                 |                                  |                                    |                                  |        |
| Nelson Mathews, R (1, 8)<br>OBP: 0.296, SLG: 0.333    |   | 0-0<br>F7                       |                              |                                 | 0-0<br>F5                    |                                 | 0-0<br>L5                    |                                 | 0-0<br>6-3                   | 4 0 0 0 0 0 1                   |   |                                 |  |                                 |                              |                                 |                              |                                 |                                  |                                    |                                  |        |
| John O'Donoghue, R (1, 1)<br>OBP: 0.375, SLG: 0.563   |   | 0-0                             |                              |                                 | 0-0                          |                                 | 0-3<br>K                     |                                 | 0-0<br>5-3                   | 1 1 1 2 0 0 0                   |   |                                 |  |                                 |                              |                                 |                              |                                 |                                  |                                    |                                  |        |
| Vern Handrahan, L (3, 1)<br>OBP: 0.222, SLG: 0.222    |   |                                 |                              |                                 |                              |                                 |                              |                                 |                              | 1 0 1 0 0 0 0                   |   |                                 |  |                                 |                              |                                 |                              |                                 |                                  |                                    |                                  |        |
| Billy Bryan, L (7, PH)<br>OBP: 0.394, SLG: 0.643      |   |                                 |                              |                                 |                              |                                 |                              |                                 |                              | 1 0 0 0 0 1 0                   |   |                                 |  |                                 |                              |                                 |                              |                                 |                                  |                                    |                                  |        |
| Joe Grzenda, R (7, 1)                                 |   | 1-H<br>HR                       |                              |                                 |                              |                                 |                              |                                 |                              | 0 0 0 0 0 0 0                   |   |                                 |  |                                 |                              |                                 |                              |                                 |                                  |                                    |                                  |        |
| George Alusik, R (9, PH)<br>OBP: 0.425, SLG: 0.447    |   |                                 |                              |                                 |                              |                                 |                              |                                 |                              | 1 0 0 0 0 0 0                   |   |                                 |  |                                 |                              |                                 |                              |                                 |                                  |                                    |                                  |        |
| <b>Inning Stats</b>                                   | R: 2<br>E: 0<br>K: 1<br>S: 7  | H: 2<br>LOB: 0<br>BB: 0<br>P: 7 | R: 2<br>E: 0<br>K: 1<br>S: 7 | H: 2<br>LOB: 0<br>BB: 0<br>P: 7 | R: 0<br>E: 0<br>K: 0<br>S: 3 | H: 0<br>LOB: 0<br>BB: 0<br>P: 3 | R: 0<br>E: 0<br>K: 0<br>S: 3 | H: 0<br>LOB: 0<br>BB: 0<br>P: 3 | R: 0<br>E: 0<br>K: 1<br>S: 7 | H: 2<br>LOB: 2<br>BB: 0<br>P: 7 | R: 0<br>E: 0<br>K: 0<br>S: 4  | H: 2<br>LOB: 1<br>BB: 0<br>P: 4 | R: 0<br>E: 0<br>K: 1<br>S: 7   | H: 2<br>LOB: 2<br>BB: 0<br>P: 7 | R: 0<br>E: 0<br>K: 0<br>S: 3 | H: 0<br>LOB: 1<br>BB: 1<br>P: 7 | R: 0<br>E: 0<br>K: 0<br>S: 3 | H: 0<br>LOB: 0<br>BB: 0<br>P: 3 | 1B: 8<br>2B: 1<br>3B: 0<br>HR: 2 | SF: 0<br>SAC: 0<br>DP: 1<br>HBP: 0 | WP: 0<br>PB: 0<br>SB: 0<br>CS: 0 | PA: 37 |
| <b>PITCHER</b><br>Buster Narum, R (1, 1)<br>ERA: 3.45 | IP: 9.0<br>WLS: W<br>BF: 37<br>H: 10<br>R: 4<br>ER: 4<br>SO: 4<br>BB: 1<br>IBB: 0<br>HBP: 0<br>BLK: 0<br>WP: 0<br>HR: 2<br>S: 44<br>P: 48<br>ERA: 4.00<br>WHIP: 1.222 |                                 |                              |                                 |                              |                                 |                              |                                 |                              |                                 |   | <b>PITCHER</b>                  | IP: WLS: BF: H: R: ER: SO: BB: IBB: HBP: BLK: WP: HR: S: P: ERA: WHIP: |                                 |                              |                                 |                              |                                 |                                  |                                    |                                  |        |

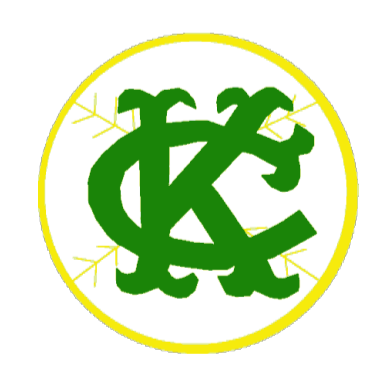

| Batter  | 1                       | 2               | 3                            | 4                          | 5               | 6                    | 7         | 8         | 9 | AB R H RBI BB SO LOB |
|---|-------------------------|-----------------|------------------------------|----------------------------|-----------------|----------------------|-----------|-----------|---|----------------------|
| Ed Brinkman, R<br>OBP: 0.248, SLG: 0.326<br>(1, 6)    | 0-0<br>1B<br>2B         | 0-0<br>E8<br>1B |                              | 4-0<br>BB<br>1B<br>BB      |                 | 4-0<br>E<br>BB<br>BB |           | 0-0<br>F8 |   | 3 2 2 0 2 0 0        |
| John Kennedy, R<br>OBP: 0.331, SLG: 0.429<br>(1, 5)   | 0-0<br>2B<br>1B         | 0-0<br>5-3      |                              | 4-0<br>1B<br>FC5-2-5<br>BB |                 | 0-0<br>F8            |           | 0-0<br>1B |   | 4 1 2 1 1 0 2        |
| Chuck Hinton, R<br>OBP: 0.396, SLG: 0.543<br>(1, 7)   | 0-0<br>1B<br>2B         |                 | 0-0<br>G6-4-3<br>1B<br>BB    | 0-0<br>1-3<br>2-H<br>1B    |                 | 0-0<br>F7            |           | 0-0<br>F8 |   | 5 2 3 2 0 0 2        |
| Bill Skowron, R<br>OBP: 0.295, SLG: 0.474<br>(1, 3)   | 0-0<br>F9               |                 | 4-0<br>1-2<br>BB             | 0-0<br>FC5-2-5             |                 | 0-0<br>L6            |           |           |   | 3 0 0 0 1 0 4        |
| Don Lock, R<br>OBP: 0.361, SLG: 0.412<br>(1, 8)       | 4-0<br>1B<br>BB         |                 | 0-0<br>G6-4-3<br>1-2f<br>2-3 | 0-0<br>F8                  |                 | 0-3<br>K             |           |           |   | 3 0 0 0 1 1 4        |
| Don Leppert, R<br>OBP: 0.239, SLG: 0.209<br>(1, 2)    | 0-0<br>1-3<br>2-H<br>1B |                 | 0-0<br>HR<br>1B              | 0-0<br>F9                  |                 | 0-0<br>6-3           |           |           |   | 4 1 2 2 0 0 2        |
| Fred Valentine, S<br>OBP: 0.304, SLG: 0.333<br>(1, 9) | 0-0<br>G6-4-3<br>1-2f   |                 | 0-0<br>HR<br>1B              |                            | 4-0<br>CS<br>BB |                      | 0-0<br>2B |           |   | 3 1 2 0 1 0 2        |
| Chuck Cottier, R<br>OBP: 0.273, SLG: 0.468<br>(1, 4)  |                         | 0-0<br>F8       | 0-0<br>1-H<br>2-H<br>HR      |                            | 0-3<br>K        |                      | 0-0<br>F8 |           |   | 4 1 1 3 0 1 2        |
| Buster Narum, R<br>(1, 1)                             |                         | 0-3<br>K        | 0-0<br>5-3                   |                            | 0-3<br>K        |                      | 0-3<br>K  |           |   | 4 0 0 0 0 3 0        |

| Inning Stats | R: 3 | H: 4 | E: 0 | LOB: 1 | K: 0 | S: 6 | P: 10 | R: 0 | H: 1 | E: 1 | LOB: 1 | K: 1 | S: 6 | P: 6 | R: 4 | H: 4 | E: 0 | LOB: 0 | K: 0 | S: 6 | P: 10 | R: 1 | H: 1 | E: 0 | LOB: 2 | K: 0 | S: 4 | R: 0 | H: 0 | E: 0 | LOB: 0 | K: 2 | S: 6 | P: 10 | R: 0 | H: 0 | E: 1 | LOB: 1 | K: 0 | S: 3 | P: 7 | R: 0 | H: 1 | E: 0 | LOB: 1 | K: 1 | S: 6 | P: 6 | R: 0 | H: 1 | E: 0 | LOB: 1 | K: 1 | S: 6 | P: 6 |
|--------------|------|------|------|--------|------|------|-------|------|------|------|--------|------|------|------|------|------|------|--------|------|------|-------|------|------|------|--------|------|------|------|------|------|--------|------|------|-------|------|------|------|--------|------|------|------|------|------|------|--------|------|------|------|------|------|------|--------|------|------|------|
|--------------|------|------|------|--------|------|------|-------|------|------|------|--------|------|------|------|------|------|------|--------|------|------|-------|------|------|------|--------|------|------|------|------|------|--------|------|------|-------|------|------|------|--------|------|------|------|------|------|------|--------|------|------|------|------|------|------|--------|------|------|------|

| PITCHER                                   | IP  | WLS | BF | H | R | ER | SO | BB | IBB | HBP | BLK | WP | HR | S  | P  | ERA   | WHIP  |
|---|-----|-----|----|---|---|----|----|----|-----|-----|-----|----|----|----|----|-------|-------|
| John O'Donoghue, L<br>ERA: 6.16<br>(1, 1) | 2.2 | L   | 16 | 8 | 6 | 6  | 1  | 2  | 0   | 0   | 0   | 0  | 0  | 16 | 24 | 20.25 | 3.750 |
| Vern Handrahan, R<br>ERA: 6.06<br>(3, 1)  | 3.1 |     | 15 | 2 | 2 | 2  | 2  | 4  | 0   | 0   | 0   | 0  | 1  | 15 | 31 | 5.40  | 1.800 |
| Joe Grzenda, L<br>ERA: 6.28<br>(7, 1)     | 2.0 |     | 8  | 2 | 0 | 0  | 2  | 0  | 0   | 0   | 0   | 0  | 0  | 12 | 12 | 0.00  | 1.000 |

**BOTTOM**

Kansas City Athletics @ Washington Senators  
D.C. Stadium, Washington, DC

Tue Jun 09 1964, 3:33 AM EDT  
Unknown

livebaseballscores.com

|     |    |
|-----|----|
| AB  | 33 |
| R   | 8  |
| H   | 12 |
| RBI | 8  |
| BB  | 6  |
| SO  | 5  |
| LOB | 18 |



|       |        |
|-------|--------|
| WP: 0 | PA: 39 |
| PB: 0 |        |
| SB: 0 |        |
| CS: 1 |        |

| Batter   | 1   | 2   | 3   | 4   | 5   | 6   | 7   | 8   | 9   | AB R H RBI BB SO LOB                                       | TOP   |
|--|---|---|---|---|---|---|---|---|---|--|---|
| Wayne Causey, L (1, 6)<br>OBP: 0.414, SLG: 0.421   | 0-0<br>4-3  |   | 0-0<br>SH3<br>2B                                    |   | 0-0<br>F9   |   |   | 0-0<br>P6   |   | 4 0 1 0 0 0 0  | <b>Kansas City Athletics @ Washington Senators</b><br><b>D.C. Stadium, Washington, DC</b><br>Tue Jun 09 1964, 7:05 PM EDT<br>Att. 6,253 - Unknown |
| Dick Green, R (1, 4)<br>OBP: 0.246, SLG: 0.337   | 0-0<br>6-3  |   | 0-0<br>SH3<br>2-3                                   |   | 0-0<br>5-3  |   |   | 0-3<br>K  |   | 3 0 0 0 0 1 0  |   |
| Ed Charles, R (1, 5)<br>OBP: 0.344, SLG: 0.408   | 0-0<br>HR   |   | 0-0<br>F3   |   | 0-0<br>5-3  |   |   | 0-0<br>6-3  |   | 4 1 1 1 0 0 1  |   |
| Rocky Colavito, R (1, 9)<br>OBP: 0.391, SLG: 0.577   | 0-0<br>1B   |   | 4-0<br>BB   |   | 0-0<br>6-3  |   |   | 0-0<br>F8   |   | 3 0 1 0 1 0 0  |   |
| George Alusik, R (1, 3)<br>OBP: 0.418, SLG: 0.438  | 0-0<br>P6   |   | 0-0<br>F7   |   | 0-0<br>G6-4-3<br>1B                                 |   |   | 0-0<br>1-3  |   | 4 0 1 0 0 0 3  |   |
| Doc Edwards, R (1, 2)<br>OBP: 0.263, SLG: 0.280  |   | 0-0<br>1B   |   | 0-0<br>P3   |   | 0-0<br>G6-4-3<br>1-2f                               |   | 0-0<br>P6   |   | 4 0 1 0 0 0 1  |   |
| John Wojcik, L (1, 7)<br>OBP: 0.273, SLG: 0.200  |   | 0-3<br>K  |   | 0-0<br>G3   |   |   | 0-0<br>F9   |   |   | 3 0 0 0 0 1 1  |   |
| Nelson Mathews, R (1, 8)<br>OBP: 0.297, SLG: 0.338   |   | 0-0<br>P6   |   | 0-0<br>2B   |   |   | 0-0<br>5-3  |   |   | 3 0 1 0 0 0 1  |   |
| Dan Pfister, R (1, 1)<br>Billy Bryan, L (7, PH)<br>Diego Segui, R (7, 1)<br>OBP: 0.185, SLG: 0.269 |   | 0-0<br>L6   |   | 0-0<br>P6   |   |   | 0-0<br>1B   |   |   | 2 0 0 0 0 0 2<br>1 0 1 0 0 0 0<br>0 0 0 0 0 0 0            |   |
| <b>Inning Stats</b>  | R: 1 H: 2<br>E: 0 LOB: 1<br>K: 0 BB: 0<br>S: 5 P: 5   | R: 0 H: 1<br>E: 0 LOB: 1<br>K: 1 BB: 0<br>S: 6 P: 6                     | R: 0 H: 1<br>E: 0 LOB: 2<br>K: 0 BB: 1<br>S: 4 P: 8 | R: 0 H: 1<br>E: 0 LOB: 1<br>K: 0 BB: 0<br>S: 4 P: 4 | R: 0 H: 0<br>E: 0 LOB: 0<br>K: 0 BB: 0<br>S: 3 P: 3 | R: 0 H: 1<br>E: 0 LOB: 0<br>K: 0 BB: 0<br>S: 3 P: 3 | R: 0 H: 1<br>E: 0 LOB: 1<br>K: 0 BB: 0<br>S: 3 P: 3 | R: 0 H: 0<br>E: 0 LOB: 0<br>K: 1 BB: 0<br>S: 5 P: 5 | R: 0 H: 0<br>E: 0 LOB: 0<br>K: 0 BB: 0<br>S: 3 P: 3 | 1B: 4 SF: 0<br>2B: 2 SAC: 1<br>3B: 0 DP: 1<br>HR: 1 HBP: 0 | WP: 0 PA: 33<br>PB: 0<br>SB: 0<br>CS: 0   |
| <b>PITCHER</b><br>Tom Cheney, R (1, 1)<br>ERA: 3.38  | IP WLS BF H R ER SO BB IBB HBP BLK WP HR S P ERA WHIP | <b>PITCHER</b><br>IP WLS BF H R ER SO BB IBB HBP BLK WP HR S P ERA WHIP |   |   |   |   |   |   |   |  |   |

livebaseballscorecards.com

|            |    |
|------------|----|
| <b>AB</b>  | 31 |
| <b>R</b>   | 1  |
| <b>H</b>   | 7  |
| <b>RBI</b> | 1  |
| <b>BB</b>  | 1  |
| <b>SO</b>  | 2  |
| <b>LOB</b> | 9  |



| Batter   | 1      | 2            | 3                       | 4      | 5      | 6       | 7      | 8               | 9 |
|--|--------|--------------|-------------------------|--------|--------|---------|--------|-----------------|---|
| Don Blasingame, L (1, 4)<br>OBP: 0.317, SLG: 0.327 | 0-0 L4 |              | 0-0 WP 1B               |        | 0-3 K  |         |        | 0-0 FC6-4 1B    |   |
| John Kennedy, R (1, 5)<br>OBP: 0.324, SLG: 0.420   | 0-3 K  |              | 0-0 FC5-2-1 WP 1B       |        | 0-0 F5 |         |        | 0-0 FC6-4 1B 3B |   |
| Chuck Hinton, R (1, 7)<br>OBP: 0.402, SLG: 0.551   | 0-0 2B |              | 0-0 WP 1B               |        |        | 0-0 6-3 |        | 0-0 3B 1B       |   |
| Jim King, L (1, 9)<br>OBP: 0.337, SLG: 0.506       |        | 0-0 P3       | 0-0 5-3                 |        |        | 0-0 HR  |        | 0-3 K           |   |
| Dick Phillips, L (1, 3)<br>OBP: 0.342, SLG: 0.344  |        | 0-0 CS BB 1B |                         | 0-3 K  |        | 0-0 F7  |        | 4-0 3B BB       |   |
| Mike Brumley, L (1, 2)<br>OBP: 0.331, SLG: 0.300   |        | 4-0 BB BB    |                         | 0-0 F7 |        | 0-0 4-3 |        | 0-0 3B          |   |
| Fred Valentine, S (1, 8)<br>OBP: 0.289, SLG: 0.315 |        | 0-3 K        |                         | 0-0 E1 |        | 0-3 K   |        | 0-0 F9          |   |
| Ed Brinkman, R (1, 6)<br>OBP: 0.250, SLG: 0.326    |        |              | 0-0 1B SH1-4 FC5-2-1 1B | 0-0 F3 |        | 0-0 F8  |        |                 |   |
| Tom Cheney, R (1, 1)<br>OBP: 0.273, SLG: 0.273     |        |              | 0-0 SH1-4               |        | 0-3 K  |         | 0-0 G3 |                 |   |

| Inning Stats | R: 0 | H: 1 | E: 0 | LOB: 1 | K: 1 | BB: 0 | S: 5 | P: 5 |
|--------------|------|------|------|--------|------|-------|------|------|
|              | 0    | 1    | 0    | 1      | 1    | 0     | 5    | 5    |

| PITCHER                            | IP  | WLS | BF | H | R | ER | SO | BB | IBB | HBP | BLK | WP | HR | S  | P  | ERA   | WHIP  |
|------------------------------------|-----|-----|----|---|---|----|----|----|-----|-----|-----|----|----|----|----|-------|-------|
| Dan Pfister, R (1, 1)<br>ERA: 8.74 | 6.0 | L   | 24 | 6 | 2 | 2  | 5  | 1  | 0   | 0   | 0   | 1  | 1  | 33 | 37 | 3.00  | 1.167 |
| Diego Segui, R (7, 1)<br>ERA: 4.34 | 2.0 |     | 10 | 3 | 3 | 3  | 2  | 1  | 0   | 0   | 0   | 0  | 0  | 13 | 17 | 13.50 | 2.000 |

**BOTTOM**

AB R H RBI BB SO LOB

4 1 2 0 0 1 0

4 1 0 0 0 1 3

4 1 3 0 0 0 0

4 1 1 1 0 1 4

3 1 1 0 1 1 0

3 0 1 3 1 0 0

4 0 0 0 0 2 3

3 0 1 0 0 0 1

2 0 0 0 0 1 0

**AB 31**  
**R 5**  
**H 9**  
**RBI 4**  
**BB 2**  
**SO 7**  
**LOB 11**



| 1B | 2B | 3B | HR | SF | SAC | DP | HBP | WP | HR | S | P | ERA  | WHIP  |
|----|----|----|----|----|-----|----|-----|----|----|---|---|------|-------|
| 6  | 2  | 1  | 1  | 0  | 1   | 1  | 0   | 1  | 1  | 1 | 1 | 3.00 | 1.167 |

Kansas City Athletics @ Washington Senators  
D.C. Stadium, Washington, DC  
Tue Jun 09 1964, 7:05 PM EDT  
Att. 6,253 - Unknown

livebaseballscorecards.com

| Batter  | 1   | 2                               | 3                            | 4                                | 5                            | 6                               | 7                            | 8                               | 9                            | AB R H RBI BB SO LOB             | TOP   |                                 |                              |                                 |                              |                                 |                                  |                                    |                                  |        |  |  |  |  |  |  |  |  |  |
|---|---|---------------------------------|------------------------------|----------------------------------|------------------------------|---------------------------------|------------------------------|---------------------------------|------------------------------|----------------------------------|---|---------------------------------|------------------------------|---------------------------------|------------------------------|---------------------------------|----------------------------------|------------------------------------|----------------------------------|--------|--|--|--|--|--|--|--|--|--|
| Wayne Causey, L (1, 6)<br>OBP: 0.409, SLG: 0.413    | 4-0<br>FC5-4<br>BB                                    | 0-0<br>F9                       |                              |                                  | 0-0<br>F7                    |                                 | 0-0<br>F8                    |                                 | 0-0<br>4-3                   | 4 0 0 0 1 0 5                    | <b>Kansas City Athletics @ Washington Senators</b><br><b>D.C. Stadium, Washington, DC</b><br>Wed Jun 10 1964, 7:05 PM EDT<br>Att. 4,160 - Unknown |                                 |                              |                                 |                              |                                 |                                  |                                    |                                  |        |  |  |  |  |  |  |  |  |  |
| Dick Green, R (1, 4)<br>OBP: 0.241, SLG: 0.330      | 0-0<br>FC5-4<br>1-2f                                  |                                 | 0-0<br>5-3                   |                                  | 0-3<br>K                     |                                 | 0-3<br>K                     |                                 |                              | 4 0 0 0 0 2 2                    |   |                                 |                              |                                 |                              |                                 |                                  |                                    |                                  |        |  |  |  |  |  |  |  |  |  |
| Ed Charles, R (1, 5)<br>OBP: 0.347, SLG: 0.404      | 0-3<br>K<br>1-2                                       |                                 | 0-0<br>5-3                   |                                  |                              | 4-0<br>1B<br>BB                 |                              | 4-0<br>BB<br>G5-4-3             |                              | 2 0 0 0 2 1 1                    |   |                                 |                              |                                 |                              |                                 |                                  |                                    |                                  |        |  |  |  |  |  |  |  |  |  |
| Rocky Colavito, R (1, 9)<br>OBP: 0.388, SLG: 0.567  | 0-0<br>F8   |                                 | 4-0<br>BB                    |                                  | 0-0<br>F8                    |                                 | 0-0<br>G5-4-3<br>1-2f        |                                 |                              | 3 0 0 0 1 0 3                    |   |                                 |                              |                                 |                              |                                 |                                  |                                    |                                  |        |  |  |  |  |  |  |  |  |  |
| George Alusik, R (1, 3)<br>OBP: 0.412, SLG: 0.424   |   | 4-0<br>BB<br>1B<br>BB           | 0-0<br>5-3                   |                                  | 0-3<br>K                     |                                 | 0-0<br>5-3                   |                                 |                              | 3 1 0 0 1 1 2                    |   |                                 |                              |                                 |                              |                                 |                                  |                                    |                                  |        |  |  |  |  |  |  |  |  |  |
| Charlie Lau, L (1, 2)<br>OBP: 0.328, SLG: 0.402     |   | 0-0<br>F9                       |                              | 0-0<br>F9                        |                              | 0-0<br>1B                       |                              | 0-0<br>3-1                      |                              | 4 0 1 0 0 0 1                    |   |                                 |                              |                                 |                              |                                 |                                  |                                    |                                  |        |  |  |  |  |  |  |  |  |  |
| John Wojcik, L (1, 7)<br>OBP: 0.333, SLG: 0.231     |   | 4-0<br>FC3-5<br>1B<br>BB<br>1-2 |                              | 0-3<br>K                         |                              | 0-0<br>F8                       |                              | 0-0<br>1B<br>1B                 |                              | 3 0 1 0 1 1 2                    |   |                                 |                              |                                 |                              |                                 |                                  |                                    |                                  |        |  |  |  |  |  |  |  |  |  |
| Nelson Mathews, R (1, 8)<br>OBP: 0.302, SLG: 0.343  |   | 0-0<br>FC3-5<br>1B              |                              | 0-3<br>K                         |                              |                                 | 0-0<br>6-3<br>1B             |                                 | 0-0<br>1B                    | 3 0 2 1 0 1 0                    |   |                                 |                              |                                 |                              |                                 |                                  |                                    |                                  |        |  |  |  |  |  |  |  |  |  |
| Jim Gentile, L (9, PH)<br>OBP: 0.395, SLG: 0.567    |   | 1-2<br>2-H                      |                              |                                  |                              |                                 |                              | 1-2<br>1B                       |                              | 1 0 1 0 0 0 0                    |   |                                 |                              |                                 |                              |                                 |                                  |                                    |                                  |        |  |  |  |  |  |  |  |  |  |
| Dan Pfister, R (9, PR)                              |   |                                 |                              |                                  |                              |                                 |                              |                                 |                              | 0 0 0 0 0 0 0                    |   |                                 |                              |                                 |                              |                                 |                                  |                                    |                                  |        |  |  |  |  |  |  |  |  |  |
| Jose Tartabull, L (9, PR)<br>OBP: 0.176, SLG: 0.235 |   |                                 |                              |                                  |                              |                                 |                              |                                 |                              | 0 0 0 0 0 0 0                    |   |                                 |                              |                                 |                              |                                 |                                  |                                    |                                  |        |  |  |  |  |  |  |  |  |  |
| Ted Bowsfield, R (1, 1)                             |   | 0-0<br>FC3-5                    |                              | 0-3<br>K                         |                              |                                 | 0-0<br>6-3                   |                                 | 0-0<br>F8                    | 3 0 0 0 0 1 3                    |   |                                 |                              |                                 |                              |                                 |                                  |                                    |                                  |        |  |  |  |  |  |  |  |  |  |
| Moe Drabowsky, R (8, 1)<br>OBP: 0.048, SLG: 0.048   |   | 1-2<br>2-3f                     |                              |                                  |                              |                                 |                              |                                 |                              | 0 0 0 0 0 0 0                    |   |                                 |                              |                                 |                              |                                 |                                  |                                    |                                  |        |  |  |  |  |  |  |  |  |  |
| Billy Bryan, L (9, PH)<br>OBP: 0.400, SLG: 0.633    |   |                                 |                              |                                  |                              |                                 |                              |                                 |                              | 1 0 0 0 0 0 2                    |   |                                 |                              |                                 |                              |                                 |                                  |                                    |                                  |        |  |  |  |  |  |  |  |  |  |
| <b>Inning Stats</b>                                 | R: 0<br>E: 0<br>K: 1<br>S: 5                          | H: 0<br>LOB: 1<br>BB: 1<br>P: 9 | R: 1<br>E: 0<br>K: 0<br>S: 4 | H: 1<br>LOB: 2<br>BB: 2<br>P: 12 | R: 0<br>E: 0<br>K: 0<br>S: 3 | H: 0<br>LOB: 1<br>BB: 1<br>P: 7 | R: 0<br>E: 0<br>K: 2<br>S: 7 | H: 0<br>LOB: 0<br>BB: 0<br>P: 7 | R: 0<br>E: 0<br>K: 1<br>S: 6 | H: 1<br>LOB: 2<br>BB: 1<br>P: 10 | R: 0<br>E: 0<br>K: 1<br>S: 6  | H: 1<br>LOB: 1<br>BB: 0<br>P: 6 | R: 0<br>E: 0<br>K: 0<br>S: 2 | H: 0<br>LOB: 0<br>BB: 1<br>P: 6 | R: 0<br>E: 0<br>K: 0<br>S: 5 | H: 2<br>LOB: 2<br>BB: 0<br>P: 5 | 1B: 5<br>2B: 0<br>3B: 0<br>HR: 0 | SF: 0<br>SAC: 0<br>DP: 1<br>HBP: 0 | WP: 0<br>PB: 0<br>SB: 1<br>CS: 0 | PA: 37 |  |  |  |  |  |  |  |  |  |
| <b>PITCHER</b>                                      | IP WLS BF H R ER SO BB IBB HBP BLK WP HR S P ERA WHIP |                                 |                              |                                  |                              |                                 |                              |                                 |                              |                                  |   |                                 |                              |                                 |                              |                                 |                                  |                                    |                                  |        |  |  |  |  |  |  |  |  |  |
| Bennie Daniels, R (1, 1)<br>ERA: 3.82               | 4.0   |                                 | 17                           | 1                                | 1                            | 1                               | 3                            | 4                               | 0                            | 0                                | 0   | 0                               | 0                            | 0                               | 19                           | 35                              | 2.25                             | 1.250                              |                                  |        |  |  |  |  |  |  |  |  |  |
| Jim Hannan, R (5, 1)<br>ERA: 4.01                   | 4.1   | W                               | 18                           | 4                                | 0                            | 0                               | 4                            | 2                               | 0                            | 0                                | 0   | 0                               | 0                            | 0                               | 24                           | 32                              | 0.00                             | 1.385                              |                                  |        |  |  |  |  |  |  |  |  |  |
| Ron Kline, R (9, 1)<br>ERA: 1.91                    | 0.2   | S                               | 2                            | 0                                | 0                            | 0                               | 0                            | 0                               | 0                            | 0                                | 0   | 0                               | 0                            | 0                               | 2                            | 2                               | 0.00                             | 0.000                              |                                  |        |  |  |  |  |  |  |  |  |  |

livebaseballscorecards.com

|            |           |
|------------|-----------|
| <b>AB</b>  | <b>31</b> |
| <b>R</b>   | <b>1</b>  |
| <b>H</b>   | <b>5</b>  |
| <b>RBI</b> | <b>1</b>  |
| <b>BB</b>  | <b>6</b>  |
| <b>SO</b>  | <b>7</b>  |
| <b>LOB</b> | <b>21</b> |





| Batter   | 1      | 2            | 3      | 4       | 5            | 6      | 7         | 8     | 9       | AB | R | H | RBI | BB | SO | LOB |
|--|--------|--------------|--------|---------|--------------|--------|-----------|-------|---------|----|---|---|-----|----|----|-----|
| Ed Brinkman, R (1, 6)<br>OBP: 0.250, SLG: 0.324    | 0-0 F9 |              | 0-0 F8 |         | 0-0 FC3-6 1B |        | 0-0 P6    |       |         | 4  | 0 | 1 | 0   | 0  | 0  | 0   |
| John Kennedy, R (1, 5)<br>OBP: 0.323, SLG: 0.427   | 0-0 P4 |              | 0-0 P6 |         | 0-0 FC3-6    |        | 0-0       |       |         | 4  | 0 | 1 | 0   | 0  | 0  | 2   |
| Chuck Hinton, R (1, 7)<br>OBP: 0.399, SLG: 0.544   | 4-0 BB |              | 0-0 E6 |         | 0-0 1-3      |        | 0-0 6-3   |       |         | 3  | 0 | 0 | 0   | 1  | 0  | 3   |
| Bill Skowron, R (1, 3)<br>OBP: 0.289, SLG: 0.463   | 0-3 K  |              | 0-0 G3 |         |              |        | 0-0 F7    |       | 0-3 K   | 4  | 0 | 0 | 0   | 0  | 2  | 2   |
| Don Lock, R (1, 8)<br>OBP: 0.358, SLG: 0.407       |        | 0-0 E 4-3 1B |        | 0-0 P6  |              | 0-0 F5 |           | 0-3 K |         | 4  | 1 | 1 | 0   | 0  | 1  | 0   |
| Don Leppert, R (1, 2)<br>OBP: 0.224, SLG: 0.196    |        | 0-0 E6       |        | 0-0 5-3 |              | 0-0 F8 |           | 0-0   |         | 3  | 0 | 0 | 0   | 0  | 0  | 1   |
| Mike Brumley, L (8, PH) (9, 2)                     |        | 4-3 1-3      |        |         |              |        |           | 1B    |         | 1  | 0 | 1 | 0   | 0  | 0  | 0   |
| Fred Valentine, S (1, 9)<br>OBP: 0.279, SLG: 0.303 |        | 0-0 4-3      |        | 0-0 P3  |              |        | 0-0 E6 SH |       | 0-0 1-3 | 3  | 1 | 0 | 1   | 0  | 0  | 1   |
| Jim King, L (8, PH) (9, 9)                         |        | 1-3 3-H      |        |         |              |        | E         |       |         | 1  | 0 | 0 | 0   | 0  | 0  | 1   |
| Chuck Cottier, R (1, 4)<br>OBP: 0.263, SLG: 0.449  |        | 0-0 F8       |        |         | 0-0 6-3      |        | SH SF9    |       |         | 2  | 1 | 0 | 0   | 0  | 0  | 1   |
| Bennie Daniels, L (1, 1)<br>OBP: 0.174, SLG: 0.238 |        | 0-0 G3       |        |         | 0-0 FC3-6 1B |        | SF9       |       |         | 1  | 0 | 0 | 0   | 0  | 0  | 1   |
| Jim Hannan, R (5, 1)<br>OBP: 0.222, SLG: 0.250     |        |              |        |         | 1B           |        |           |       |         | 1  | 0 | 1 | 1   | 0  | 0  | 0   |
| Ron Kline, R (9, 1)                                |        |              |        |         | 1B           |        |           |       |         | 0  | 0 | 0 | 0   | 0  | 0  | 0   |

| Inning Stats                         | R: 0 | H: 0 | E: 0 | K: 1 | S: 5 | LOB: 1 | BB: 1 | P: 9 | R: 1 | H: 1 | E: 1 | K: 0 | S: 5 | LOB: 1 | BB: 0 | P: 5 | R: 0  | H: 0 | E: 1 | K: 0 | S: 4 | LOB: 1 | BB: 0 | P: 4 | R: 0 | H: 0 | E: 0 | K: 0 | S: 3 | LOB: 0 | BB: 0 | P: 3 | R: 0 | H: 2 | E: 0 | K: 0 | S: 5 | LOB: 2 | BB: 0 | P: 5 | R: 0 | H: 0 | E: 0 | K: 0 | S: 3 | LOB: 0 | BB: 0 | P: 3 | R: 2 | H: 1 | E: 2 | K: 0 | S: 6 | LOB: 1 | BB: 0 | P: 6 | R: 0 | H: 1 | E: 0 | K: 2 | S: 8 | LOB: 1 | BB: 0 | P: 8 |
|--------------------------------------|------|------|------|------|------|--------|-------|------|------|------|------|------|------|--------|-------|------|-------|------|------|------|------|--------|-------|------|------|------|------|------|------|--------|-------|------|------|------|------|------|------|--------|-------|------|------|------|------|------|------|--------|-------|------|------|------|------|------|------|--------|-------|------|------|------|------|------|------|--------|-------|------|
| PITCHER                              | IP   | WLS  | BF   | H    | R    | ER     | SO    | BB   | IBB  | HBP  | BLK  | WP   | HR   | S      | P     | ERA  | WHIP  |      |      |      |      |        |       |      |      |      |      |      |      |        |       |      |      |      |      |      |      |        |       |      |      |      |      |      |      |        |       |      |      |      |      |      |      |        |       |      |      |      |      |      |      |        |       |      |
| Ted Bowsfield, L (1, 1)<br>ERA: 5.0  | 7.0  | L    | 30   | 4    | 3    | 0      | 1     | 1    | 0    | 0    | 0    | 0    | 0    | 31     | 35    | 0.00 | 0.714 |      |      |      |      |        |       |      |      |      |      |      |      |        |       |      |      |      |      |      |      |        |       |      |      |      |      |      |      |        |       |      |      |      |      |      |      |        |       |      |      |      |      |      |      |        |       |      |
| Moe Drabowsky, R (8, 1)<br>ERA: 6.16 | 1.0  |      | 4    | 1    | 0    | 0      | 2     | 0    | 0    | 0    | 0    | 0    | 0    | 8      | 8     | 0.00 | 1.000 |      |      |      |      |        |       |      |      |      |      |      |      |        |       |      |      |      |      |      |      |        |       |      |      |      |      |      |      |        |       |      |      |      |      |      |      |        |       |      |      |      |      |      |      |        |       |      |

**BOTTOM**

**Kansas City Athletics @ Washington Senators**  
**D.C. Stadium, Washington, DC**  
 Wed Jun 10 1964, 7:05 PM EDT  
 Att. 4,160 - Unknown

|     |    |
|-----|----|
| AB  | 31 |
| R   | 3  |
| H   | 5  |
| RBI | 2  |
| BB  | 1  |
| SO  | 3  |
| LOB | 12 |



|       |        |       |        |
|-------|--------|-------|--------|
| 1B: 4 | SF: 1  | WP: 0 | PA: 34 |
| 2B: 0 | SAC: 1 | PB: 0 |        |
| 3B: 1 | DP: 0  | SB: 0 |        |
| HR: 0 | HBP: 0 | CS: 0 |        |

| Batter  | 1   | 2                                | 3                            | 4                                | 5                            | 6                               | 7                            | 8                               | 9                            | AB R H RBI BB SO LOB             | TOP   |                                 |   |                                 |                              |                                 |                              |                                 |                                  |                                    |                                  |        |
|---|---|----------------------------------|------------------------------|----------------------------------|------------------------------|---------------------------------|------------------------------|---------------------------------|------------------------------|----------------------------------|---|---------------------------------|---|---------------------------------|------------------------------|---------------------------------|------------------------------|---------------------------------|----------------------------------|------------------------------------|----------------------------------|--------|
| Wayne Causey, L (1, 6)<br>OBP: 0.409, SLG: 0.412      | 0-0<br>FC4-6<br>1B  | 0-0<br>F7                        |                              |                                  | 0-0<br>F7                    |                                 | 0-0<br>2B<br>1B              |                                 | 0-0<br>1-3                   | 5 0 2 0 0 0 4                    | <b>Kansas City Athletics @ Cleveland Indians</b><br><b>Cleveland Municipal Stadium, Cleveland, OH</b><br>Fri Jun 12 1964, 7:05 PM EDT<br>Att. 9,625 - Unknown<br><a href="http://livebaseballscorecards.com">livebaseballscorecards.com</a> |                                 |   |                                 |                              |                                 |                              |                                 |                                  |                                    |                                  |        |
| Doc Edwards, R (1, 2)<br>OBP: 0.260, SLG: 0.286       | 0-0<br>F1   |                                  | 0-0<br>F7                    |                                  | 0-0<br>F5                    |                                 | 0-0<br>1-3<br>2B             | 0-3<br>K                        | 5 0 1 0 0 1 4                |                                  |   |                                 |   |                                 |                              |                                 |                              |                                 |                                  |                                    |                                  |        |
| Ed Charles, R (1, 5)<br>OBP: 0.344, SLG: 0.396        | 0-0<br>FC4-6<br>BB HBP<br>1-2f  |                                  | 0-3<br>K                     |                                  | 0-3<br>K                     |                                 | 4-0<br>BB                    | 0-0<br>4-3                      | 4 0 0 0 1 2 4                |                                  |   |                                 |   |                                 |                              |                                 |                              |                                 |                                  |                                    |                                  |        |
| Rocky Colavito, R (1, 9)<br>OBP: 0.385, SLG: 0.557    | 1-0<br>BB<br>1-2<br>HBP   |                                  | 0-0<br>3-1                   |                                  | 0-3<br>K                     |                                 | 0-0<br>1-3                   |                                 | 3 0 0 0 0 1 3                |                                  |   |                                 |   |                                 |                              |                                 |                              |                                 |                                  |                                    |                                  |        |
| Jim Gentile, L (1, 3)<br>OBP: 0.398, SLG: 0.559       | 4-0<br>1-2<br>2-3<br>BB   |                                  | 0-0<br>G3                    |                                  | 4-0<br>BB                    |                                 | 0-0<br>F5                    |                                 | 2 0 0 0 2 0 0                |                                  |   |                                 |   |                                 |                              |                                 |                              |                                 |                                  |                                    |                                  |        |
| Nelson Mathews, R (1, 8)<br>OBP: 0.301, SLG: 0.338    | 0-3<br>K  |                                  | 0-3<br>K                     |                                  | 0-0<br>F7                    |                                 | 4-0<br>BB                    |                                 | 3 0 0 0 1 2 4                |                                  |   |                                 |   |                                 |                              |                                 |                              |                                 |                                  |                                    |                                  |        |
| John Wojcik, L (1, 7)<br>OBP: 0.263, SLG: 0.176       |   | 0-3<br>K                         |                              | 0-3<br>K                         |                              | 0-0<br>F6                       |                              | 0-0<br>F9                       | 4 0 0 0 0 2 2                |                                  |   |                                 |   |                                 |                              |                                 |                              |                                 |                                  |                                    |                                  |        |
| Dick Green, R (1, 4)<br>OBP: 0.241, SLG: 0.324        |   | 0-3<br>K                         |                              | 4-0<br>1B<br>BB                  |                              | 0-0<br>F6                       |                              | 0-0<br>F2                       | 3 0 0 0 1 1 1                |                                  |   |                                 |   |                                 |                              |                                 |                              |                                 |                                  |                                    |                                  |        |
| Diego Segui, R (1, 1)<br>OBP: 0.241, SLG: 0.296       |   | 4-0<br>BB                        |                              | 0-0<br>1B                        |                              | 0-0<br>F8                       |                              | 1-0<br>1-3<br>HBP               | 1 0 1 0 1 0 0                |                                  |   |                                 |   |                                 |                              |                                 |                              |                                 |                                  |                                    |                                  |        |
| George Williams, R (7, PH)<br>OBP: 0.167, SLG: 0.091  |   |                                  |                              |                                  |                              |                                 |                              |                                 | 1 0 0 0 0 0 0                |                                  |   |                                 |   |                                 |                              |                                 |                              |                                 |                                  |                                    |                                  |        |
| John Wyatt, R (7, 1)                                  |   |                                  |                              |                                  |                              |                                 |                              |                                 | 0 0 0 0 0 0 0                |                                  |   |                                 |   |                                 |                              |                                 |                              |                                 |                                  |                                    |                                  |        |
| George Alusik, R (9, PH)<br>OBP: 0.417, SLG: 0.424    |   |                                  |                              |                                  |                              |                                 |                              |                                 | 0 0 0 0 0 0 0                |                                  |   |                                 |   |                                 |                              |                                 |                              |                                 |                                  |                                    |                                  |        |
| <b>Inning Stats</b>                                   | R: 0<br>E: 0<br>K: 1<br>S: 6  | H: 1<br>LOB: 3<br>BB: 1<br>P: 11 | R: 0<br>E: 0<br>K: 2<br>S: 7 | H: 0<br>LOB: 1<br>BB: 1<br>P: 11 | R: 0<br>E: 0<br>K: 1<br>S: 5 | H: 0<br>LOB: 0<br>BB: 0<br>P: 5 | R: 0<br>E: 0<br>K: 2<br>S: 7 | H: 0<br>LOB: 0<br>BB: 0<br>P: 7 | R: 0<br>E: 0<br>K: 1<br>S: 6 | H: 1<br>LOB: 2<br>BB: 1<br>P: 10 | R: 0<br>E: 0<br>K: 1<br>S: 5  | H: 0<br>LOB: 1<br>BB: 1<br>P: 9 | R: 0<br>E: 0<br>K: 0<br>S: 5                          | H: 2<br>LOB: 3<br>BB: 1<br>P: 9 | R: 0<br>E: 0<br>K: 0<br>S: 3 | H: 0<br>LOB: 1<br>BB: 1<br>P: 7 | R: 0<br>E: 0<br>K: 1<br>S: 5 | H: 0<br>LOB: 1<br>BB: 0<br>P: 6 | 1B: 3<br>2B: 1<br>3B: 0<br>HR: 0 | SF: 0<br>SAC: 0<br>DP: 0<br>HBP: 2 | WP: 0<br>PB: 0<br>SB: 0<br>CS: 0 | PA: 39 |
| <b>PITCHER</b><br>Sam McDowell, L (1, 1)<br>ERA: 1.55 | IP 9.0<br>WLS W<br>BF 39<br>H 4<br>R 0<br>ER 0<br>SO 9<br>BB 6<br>IBB 0<br>HBP 2<br>BLK 0<br>WP 0<br>HR 0<br>S 49<br>P 75<br>ERA 0.00<br>WHIP 1.111 |                                  |                              |                                  |                              |                                 |                              |                                 |                              |                                  |   | <b>PITCHER</b>                  | IP WLS BF H R ER SO BB IBB HBP BLK WP HR S P ERA WHIP |                                 |                              |                                 |                              |                                 |                                  |                                    |                                  |        |



| Batter  | 1                | 2               | 3                       | 4               | 5 | 6 | 7          | 8 | 9 | AB | R | H | RBI | BB | SO | LOB |
|---|------------------|-----------------|-------------------------|-----------------|---|---|------------|---|---|----|---|---|-----|----|----|-----|
| Dick Howser, R<br>OBP: 0.324, SLG: 0.306<br>(1, 6)  | 0-0<br>F6        |                 | 0-0<br>FC6-4<br>1B      | 0-0<br>E5<br>WP |   |   | 0-0<br>5-3 |   |   | 4  | 1 | 0 | 0   | 0  | 0  | 1   |
| Vic Davalillo, L<br>OBP: 0.299, SLG: 0.343<br>(1, 8)  | 4-0<br>CS<br>BB  |                 | 0-0<br>1B<br>1-3        | 0-0<br>1-3      |   |   | 0-0<br>1-3 |   |   | 3  | 1 | 1 | 0   | 1  | 0  | 1   |
| Leon Wagner, L<br>OBP: 0.375, SLG: 0.535<br>(1, 7)  | 0-0<br>1-2<br>1B |                 | 0-0<br>1-3<br>3-H<br>1B |                 |   |   | 0-0<br>4-3 |   |   | 4  | 1 | 2 | 1   | 0  | 0  | 0   |
| Bob Chance, L<br>OBP: 0.439, SLG: 0.676<br>(1, 9)<br>(9, 3)   | 0-3<br>K         |                 | 0-0<br>2-H<br>3-H<br>1B |                 |   |   | 0-0<br>4-3 |   |   | 4  | 0 | 1 | 2   | 0  | 1  | 1   |
| Fred Whitfield, L<br>OBP: 0.336, SLG: 0.464<br>Woodie Held, R<br>OBP: 0.283, SLG: 0.450<br>(1, 3)<br>(9, 9) |                  | 0-3<br>K        | 0-3<br>K                |                 |   |   | 0-0<br>F6  |   |   | 4  | 0 | 0 | 0   | 0  | 2  | 1   |
| John Romano, R<br>OBP: 0.365, SLG: 0.542<br>(1, 2)  |                  | 4-0<br>S<br>BB  | 0-0<br>1-3<br>1B        |                 |   |   | 0-0<br>1B  |   |   | 2  | 0 | 2 | 0   | 2  | 0  | 0   |
| Max Alvis, R<br>OBP: 0.305, SLG: 0.407<br>(1, 5)  |                  | 0-3<br>1-2<br>K | 0-0<br>5-3              |                 |   |   | 0-3<br>K   |   |   | 4  | 0 | 0 | 0   | 0  | 2  | 5   |
| Larry Brown, R<br>OBP: 0.283, SLG: 0.399<br>(1, 4)  |                  | 0-0<br>6-3      |                         |                 |   |   | 0-0<br>4-3 |   |   | 3  | 0 | 0 | 0   | 0  | 0  | 2   |
| Sam McDowell, L<br>OBP: 0.200, SLG: 0.111<br>(1, 1)   |                  |                 | 0-0<br>FC6-4<br>1B      |                 |   |   | 0-0<br>F1  |   |   | 3  | 0 | 1 | 0   | 0  | 0  | 1   |

| Inning Stats | R: 0 | H: 1 | E: 0 | LOB: 1 | K: 1 | BB: 1 | S: 5 | P: 9 | R: 0 | H: 0 | E: 0 | LOB: 1 | K: 2 | BB: 1 | S: 7 | P: 11 | R: 3 | H: 5 | E: 0 | LOB: 2 | K: 1 | BB: 0 | S: 10 | P: 10 | R: 0 | H: 0 | E: 1 | LOB: 1 | K: 0 | BB: 0 | S: 4 | P: 4 | R: 0 | H: 0 | E: 0 | LOB: 0 | K: 0 | BB: 0 | S: 3 | P: 3 | R: 0 | H: 1 | E: 0 | LOB: 1 | K: 1 | BB: 0 | S: 6 | P: 6 | R: 0 | H: 0 | E: 0 | LOB: 0 | K: 0 | BB: 0 | S: 3 | P: 3 | R: 0 | H: 0 | E: 0 | LOB: 1 | K: 0 | BB: 1 | S: 3 | P: 7 |
|--------------|------|------|------|--------|------|-------|------|------|------|------|------|--------|------|-------|------|-------|------|------|------|--------|------|-------|-------|-------|------|------|------|--------|------|-------|------|------|------|------|------|--------|------|-------|------|------|------|------|------|--------|------|-------|------|------|------|------|------|--------|------|-------|------|------|------|------|------|--------|------|-------|------|------|
|--------------|------|------|------|--------|------|-------|------|------|------|------|------|--------|------|-------|------|-------|------|------|------|--------|------|-------|-------|-------|------|------|------|--------|------|-------|------|------|------|------|------|--------|------|-------|------|------|------|------|------|--------|------|-------|------|------|------|------|------|--------|------|-------|------|------|------|------|------|--------|------|-------|------|------|

| PITCHER                               | IP  | WLS | BF | H | R | ER | SO | BB | IBB | HBP | BLK | WP | HR | S  | P  | ERA  | WHIP  |
|---------------------------------------|-----|-----|----|---|---|----|----|----|-----|-----|-----|----|----|----|----|------|-------|
| Diego Segui, R<br>ERA: 4.35<br>(1, 1) | 6.0 | L   | 27 | 7 | 3 | 3  | 5  | 2  | 0   | 0   | 0   | 1  | 0  | 35 | 43 | 4.50 | 1.500 |
| John Wyatt, R<br>ERA: 2.36<br>(7, 1)  | 2.0 |     | 7  | 0 | 0 | 0  | 0  | 1  | 0   | 0   | 0   | 0  | 0  | 6  | 10 | 0.00 | 0.500 |

**BOTTOM**

**Kansas City Athletics @ Cleveland Indians**  
Cleveland Municipal Stadium, Cleveland, OH

|     |    |
|-----|----|
| AB  | 31 |
| R   | 3  |
| H   | 7  |
| RBI | 3  |
| BB  | 3  |
| SO  | 5  |
| LOB | 12 |



| WP | HR | S | P  | ERA | WHIP |
|----|----|---|----|-----|------|
| 1  | 0  | 7 | 34 |     |      |

Fri Jun 12 1964, 7:05 PM EDT  
Att. 9,625 - Unknown

livebaseballscorecards.com

| Batter   | 1   | 2                                | 3                            | 4                                | 5                            | 6                                | 7                            | 8                                | 9                            | AB R H RBI BB SO LOB             | TOP   |                                 |                              |                                 |                              |                                 |                              |                                 |                                  |                                    |                                  |        |
|--|---|----------------------------------|------------------------------|----------------------------------|------------------------------|----------------------------------|------------------------------|----------------------------------|------------------------------|----------------------------------|---|---------------------------------|------------------------------|---------------------------------|------------------------------|---------------------------------|------------------------------|---------------------------------|----------------------------------|------------------------------------|----------------------------------|--------|
| Wayne Causey, L (1, 6)<br>OBP: 0.413, SLG: 0.411   | 0-0<br>1B<br>1B                                       | 4-0<br>BB                        |                              | 4-0<br>WP BB<br>BB               |                              | 0-0<br>F7                        |                              | 0-0<br>F5                        |                              | 3 1 1 0 2 0 0                    | <b>Kansas City Athletics @ Cleveland Indians</b><br><b>Cleveland Municipal Stadium, Cleveland, OH</b><br>Sat Jun 13 1964, 3:33 AM EDT<br>Att. 3,850 - Unknown<br><a href="http://livebaseballscorecards.com">livebaseballscorecards.com</a> |                                 |                              |                                 |                              |                                 |                              |                                 |                                  |                                    |                                  |        |
| John Wojcik, L (1, 7)<br>OBP: 0.208, SLG: 0.136    | 0-3<br>K  | 0-3<br>K                         |                              | 0-0<br>F4                        |                              | 0-3<br>K                         |                              | 0-3<br>K                         |                              | 5 0 0 0 0 4 4                    |   |                                 |                              |                                 |                              |                                 |                              |                                 |                                  |                                    |                                  |        |
| Ed Charles, R (1, 5)<br>OBP: 0.349, SLG: 0.395     | 0-0<br>BB 1B<br>1-2<br>1B                             |                                  | 0-0<br>F8                    | 4-0<br>WP BB<br>1-2 2-3          |                              | 1-0<br>CS<br>HBP                 |                              | 0-0<br>3-1                       |                              | 3 0 1 0 1 0 0                    |   |                                 |                              |                                 |                              |                                 |                              |                                 |                                  |                                    |                                  |        |
| Rocky Colavito, R (1, 9)<br>OBP: 0.381, SLG: 0.547 | 0-0<br>BB<br>1-2 2-H<br>1B                            |                                  | 0-0<br>6-3                   | 0-3<br>K                         |                              | 0-0<br>CS                        | 0-0<br>F8                    | 0-3<br>K                         |                              | 5 0 1 1 0 2 2                    |   |                                 |                              |                                 |                              |                                 |                              |                                 |                                  |                                    |                                  |        |
| Jim Gentile, L (1, 3)<br>OBP: 0.409, SLG: 0.556    | 4-0<br>BB<br>1-2 2-3<br>BB                            |                                  | 4-0<br>HR<br>BB              |                                  | 4-0<br>BB<br>BB              |                                  | 4-0<br>1B<br>SF7<br>BB       | 0-3<br>K                         |                              | 1 2 0 0 4 1 0                    |   |                                 |                              |                                 |                              |                                 |                              |                                 |                                  |                                    |                                  |        |
| Billy Bryan, L (1, 2)<br>OBP: 0.410, SLG: 0.706    | 0-3<br>K  |                                  | 0-0<br>1-H<br>HR             |                                  | 0-0<br>F9                    |                                  | 0-0<br>1-3<br>1B             |                                  |                              | 4 1 2 2 0 1 4                    |   |                                 |                              |                                 |                              |                                 |                              |                                 |                                  |                                    |                                  |        |
| Nelson Mathews, R (1, 8)<br>OBP: 0.296, SLG: 0.333 | 0-3<br>K  |                                  | 0-3<br>K                     |                                  | 0-0<br>F2                    |                                  | 0-0<br>SF7                   |                                  |                              | 3 0 0 1 0 2 4                    |   |                                 |                              |                                 |                              |                                 |                              |                                 |                                  |                                    |                                  |        |
| Dick Green, R (1, 4)<br>OBP: 0.246, SLG: 0.324     |   | 0-0<br>5-3                       |                              | 0-0<br>BB S<br>WP<br>1B          |                              | 4-0<br>1-2<br>BB                 | 0-0<br>3-H<br>F7             |                                  |                              | 3 1 1 0 1 0 1                    |   |                                 |                              |                                 |                              |                                 |                              |                                 |                                  |                                    |                                  |        |
| Orlando Pena, R (1, 1)<br>John Wyatt, R (7, 1)     |   | 0-3<br>K                         |                              | 0-3<br>K                         |                              | 0-3<br>K                         |                              | 0-3<br>K                         |                              | 3 0 0 0 0 3 3<br>1 0 0 0 0 1 0   |   |                                 |                              |                                 |                              |                                 |                              |                                 |                                  |                                    |                                  |        |
| <b>Inning Stats</b>                                | R: 1<br>E: 0<br>K: 3<br>S: 12                         | H: 3<br>LOB: 3<br>BB: 1<br>P: 16 | R: 0<br>E: 0<br>K: 2<br>S: 7 | H: 0<br>LOB: 1<br>BB: 1<br>P: 11 | R: 2<br>E: 0<br>K: 1<br>S: 6 | H: 1<br>LOB: 0<br>BB: 1<br>P: 10 | R: 1<br>E: 0<br>K: 2<br>S: 8 | H: 1<br>LOB: 2<br>BB: 2<br>P: 16 | R: 0<br>E: 0<br>K: 1<br>S: 5 | H: 0<br>LOB: 2<br>BB: 2<br>P: 13 | R: 0<br>E: 0<br>K: 1<br>S: 4  | H: 0<br>LOB: 0<br>BB: 0<br>P: 5 | R: 1<br>E: 0<br>K: 0<br>S: 4 | H: 1<br>LOB: 1<br>BB: 1<br>P: 8 | R: 0<br>E: 0<br>K: 2<br>S: 7 | H: 0<br>LOB: 0<br>BB: 0<br>P: 7 | R: 0<br>E: 0<br>K: 2<br>S: 7 | H: 0<br>LOB: 0<br>BB: 0<br>P: 7 | 1B: 5<br>2B: 0<br>3B: 0<br>HR: 1 | SF: 1<br>SAC: 0<br>DP: 0<br>HBP: 1 | WP: 1<br>PB: 0<br>SB: 1<br>CS: 1 | PA: 42 |
| <b>PITCHER</b>                                     | IP WLS BF H R ER SO BB IBB HBP BLK WP HR S P ERA WHIP |                                  |                              |                                  |                              |                                  |                              |                                  |                              |                                  |   |                                 |                              |                                 |                              |                                 |                              |                                 |                                  |                                    |                                  |        |
| Sonny Siebert, R (1, 1)<br>ERA: 5.67               | 3.1 L 19 5 4 4 7 4 0 0 0 0 1 29 45 10.80 2.700        |                                  |                              |                                  |                              |                                  |                              |                                  |                              |                                  |   |                                 |                              |                                 |                              |                                 |                              |                                 |                                  |                                    |                                  |        |
| Gary Bell, R (4, 1)<br>ERA: 4.29                   | 3.2 16 1 1 1 3 4 0 1 0 1 0 17 34 2.46 1.364           |                                  |                              |                                  |                              |                                  |                              |                                  |                              |                                  |   |                                 |                              |                                 |                              |                                 |                              |                                 |                                  |                                    |                                  |        |
| Don McMahon, R (8, 1)<br>ERA: 1.18                 | 2.0 6 0 0 0 4 0 0 0 0 0 0 14 14 0.00 0.000            |                                  |                              |                                  |                              |                                  |                              |                                  |                              |                                  |   |                                 |                              |                                 |                              |                                 |                              |                                 |                                  |                                    |                                  |        |



| Batter  | 1                | 2         | 3          | 4               | 5          | 6          | 7         | 8                      | 9        | AB R H RBI BB SO LOB |
|---|------------------|-----------|------------|-----------------|------------|------------|-----------|------------------------|----------|----------------------|
| Dick Howser, R<br>OBP: 0.327, SLG: 0.315<br>(1, 6)    | 0-0<br>SF8<br>3B |           | 0-0<br>F9  |                 | 0-0<br>5-3 |            |           | 4-0<br>1B<br>SF7<br>BB |          | 3 2 1 0 1 0 0        |
| Vic Davalillo, L<br>OBP: 0.291, SLG: 0.336<br>(1, 8)  | 0-0<br>SF8       |           | 0-0<br>6-3 |                 |            | 0-0<br>F9  |           | 0-0<br>F9              |          | 3 0 0 1 0 0 1        |
| Leon Wagner, L<br>OBP: 0.373, SLG: 0.529<br>(1, 7)    | 0-3<br>K         |           |            | 0-0<br>4-3      |            | 0-0<br>F2  |           | 0-0<br>1B              |          | 4 0 1 0 0 1 0        |
| Bob Chance, L<br>OBP: 0.419, SLG: 0.649<br>(1, 9)     | 0-0<br>F9        |           |            | 0-0<br>4-3      |            | 0-0<br>F5  |           | 0-0<br>SF7             |          | 3 0 0 1 0 0 0        |
| Fred Whitfield, L<br>OBP: 0.333, SLG: 0.454<br>(1, 3) |                  | 0-0<br>G3 |            | 4-0<br>2B<br>BB |            | 0-0<br>G3  |           | 0-3<br>K               |          | 3 1 0 0 1 1 1        |
| John Romano, R<br>OBP: 0.376, SLG: 0.577<br>(1, 2)    |                  | 4-0<br>BB |            | 0-0<br>2B       |            | 0-0<br>HR  |           | 0-0<br>F7              |          | 3 1 2 2 1 0 0        |
| Max Alvis, R<br>OBP: 0.300, SLG: 0.399<br>(1, 5)      |                  | 0-0<br>L5 |            | 0-3<br>K        |            | 0-0<br>5-3 |           | 0-0<br>F3              |          | 4 0 0 0 0 1 2        |
| Larry Brown, R<br>OBP: 0.279, SLG: 0.393<br>(1, 4)    |                  | 0-3<br>K  |            |                 | 0-3<br>K   |            | 0-0<br>2B |                        | 0-3<br>K | 2 0 0 0 0 2 1        |
| Tito Francona, L<br>OBP: 0.372, SLG: 0.307<br>(7, PH) |                  |           |            |                 |            |            |           |                        |          | 1 0 1 0 0 0 0        |
| Woodie Held, R<br>OBP: 0.281, SLG: 0.447<br>(8, 4)    |                  |           |            |                 |            |            |           |                        |          | 1 0 0 0 0 1 0        |
| Sonny Siebert, R<br>OBP: 0.364, SLG: 0.500<br>(1, 1)  |                  |           | 0-0<br>F9  |                 | 0-0<br>F8  |            | 0-0<br>F5 |                        |          | 1 0 0 0 0 0 0        |
| Gary Bell, R<br>OBP: 0.429, SLG: 0.429<br>(4, 1)      |                  |           |            |                 |            |            |           |                        |          | 1 0 0 0 0 0 0        |
| Billy Moran, R<br>OBP: 0.319, SLG: 0.330<br>(7, PH)   |                  |           |            |                 |            |            |           |                        |          | 1 0 0 0 0 0 1        |
| Don McMahon, R<br>OBP: 0.200, SLG: 0.200<br>(8, 1)    |                  |           |            |                 |            |            |           |                        |          | 0 0 0 0 0 0 0        |

| Inning Stats | R: 1 | H: 1 | E: 0 | K: 1 | S: 6 | R: 0 | H: 0 | E: 0 | K: 1 | S: 5 | R: 0 | H: 0 | E: 0 | K: 0 | S: 3 | R: 1 | H: 1 | E: 0 | K: 1 | S: 6 | R: 0 | H: 0 | E: 0 | K: 1 | S: 5 | R: 0 | H: 0 | E: 0 | K: 0 | S: 5 | R: 1 | H: 2 | E: 0 | K: 0 | S: 5 | R: 1 | H: 1 | E: 0 | K: 1 | S: 6 | R: 0 | H: 0 | E: 0 | K: 1 | S: 5 | 1B: 1 | 2B: 2 | 3B: 1 | SF: 2 | SAC: 0 | DP: 0 | HBP: 0 | WP: 0 | PB: 0 | SB: 0 | CS: 0 | PA: 35 |
|--------------|------|------|------|------|------|------|------|------|------|------|------|------|------|------|------|------|------|------|------|------|------|------|------|------|------|------|------|------|------|------|------|------|------|------|------|------|------|------|------|------|------|------|------|------|------|-------|-------|-------|-------|--------|-------|--------|-------|-------|-------|-------|--------|
|--------------|------|------|------|------|------|------|------|------|------|------|------|------|------|------|------|------|------|------|------|------|------|------|------|------|------|------|------|------|------|------|------|------|------|------|------|------|------|------|------|------|------|------|------|------|------|-------|-------|-------|-------|--------|-------|--------|-------|-------|-------|-------|--------|

| PITCHER                                | IP  | WLS | BF | H | R | ER | SO | BB | IBB | HBP | BLK | WP | HR | S  | P  | ERA  | WHIP  |
|--|-----|-----|----|---|---|----|----|----|-----|-----|-----|----|----|----|----|------|-------|
| Orlando Pena, R<br>ERA: 3.97<br>(1, 1) | 6.2 | W   | 26 | 4 | 3 | 3  | 4  | 2  | 0   | 0   | 0   | 0  | 1  | 32 | 40 | 4.05 | 0.900 |
| John Wyatt, R<br>ERA: 2.45<br>(7, 1)   | 2.1 | S   | 9  | 1 | 1 | 1  | 2  | 1  | 0   | 0   | 0   | 0  | 0  | 12 | 16 | 3.86 | 0.857 |

BOTTOM

Kansas City Athletics @ Cleveland Indians  
Cleveland Municipal Stadium, Cleveland, OH

livebaseballscorecards.com

|     |    |
|-----|----|
| AB  | 30 |
| R   | 4  |
| H   | 5  |
| RBI | 4  |
| BB  | 3  |
| SO  | 6  |
| LOB | 6  |



|       |        |
|-------|--------|
| WP: 0 | PA: 35 |
| PB: 0 |        |
| SB: 0 |        |
| CS: 0 |        |

Sat Jun 13 1964, 3:33 AM EDT  
Att. 3,850 - Unknown

| Batter  | 1                            | 2                               | 3                            | 4                               | 5                            | 6                               | 7                            | 8                               | 9                            | 10                              | AB R H RBI BB SO LOB         | TOP   |                              |                                 |                              |                                 |                              |                                 |                              |                                 |                                  |                                    |                                  |        |
|---|------------------------------|---------------------------------|------------------------------|---------------------------------|------------------------------|---------------------------------|------------------------------|---------------------------------|------------------------------|---------------------------------|------------------------------|---|------------------------------|---------------------------------|------------------------------|---------------------------------|------------------------------|---------------------------------|------------------------------|---------------------------------|----------------------------------|------------------------------------|----------------------------------|--------|
| Wayne Causey, L (1, 6)<br>OBP: 0.416, SLG: 0.416      | 0-0<br>SH1-3<br>1B           | 0-0<br>4-3                      |                              |                                 | 0-0<br>F6                    |                                 | 0-0<br>1B                    |                                 | 0-0<br>E7<br>1B              |                                 | 5 1 3 1 0 0 1                | <b>Kansas City Athletics @ Cleveland Indians</b><br>Cleveland Municipal Stadium, Cleveland, OH<br>Sun Jun 14 1964, 3:33 AM EDT<br>Unknown<br><a href="http://livebaseballscorecards.com">livebaseballscorecards.com</a> |                              |                                 |                              |                                 |                              |                                 |                              |                                 |                                  |                                    |                                  |        |
| Nelson Mathews, R (1, 8)<br>OBP: 0.291, SLG: 0.327    | 0-0<br>SH1-3<br>1-2          | 0-3<br>K                        |                              |                                 | 0-0<br>6-3                   |                                 | 0-0<br>5-3                   |                                 | 0-0<br>F7<br>2-H             |                                 | 4 0 0 0 0 1 3                |   |                              |                                 |                              |                                 |                              |                                 |                              |                                 |                                  |                                    |                                  |        |
| Ed Charles, R (1, 5)<br>OBP: 0.354, SLG: 0.397        | 0-0<br>HBP<br>1B             |                                 |                              |                                 | 4-0<br>S<br>BB               |                                 |                              | 0-0<br>6-3                      | 0-0<br>6-3                   |                                 | 4 1 2 0 1 0 1                |   |                              |                                 |                              |                                 |                              |                                 |                              |                                 |                                  |                                    |                                  |        |
| Rocky Colavito, R (1, 9)<br>OBP: 0.377, SLG: 0.536    | 1-0<br>1B<br>FC4-6<br>HBP    |                                 |                              |                                 | 0-0<br>F2<br>1-2             |                                 |                              | 0-0<br>E6<br>WP<br>4-3          |                              | 0-0<br>F5                       | 4 2 0 0 0 0 2                |   |                              |                                 |                              |                                 |                              |                                 |                              |                                 |                                  |                                    |                                  |        |
| Jim Gentile, L (1, 3)<br>OBP: 0.409, SLG: 0.570       | 0-0<br>FC4-6<br>1B           |                                 |                              |                                 | 0-0<br>4-3                   |                                 |                              | 0-0<br>4-3                      |                              | 0-0<br>HR                       | 5 1 2 4 0 0 1                |   |                              |                                 |                              |                                 |                              |                                 |                              |                                 |                                  |                                    |                                  |        |
| Billy Bryan, L (1, 2)<br>OBP: 0.395, SLG: 0.658       | 0-0<br>FC4-6                 |                                 |                              |                                 | 0-0<br>F5                    |                                 |                              | 0-0<br>FC6-4<br>1B              |                              | 0-0<br>5-3                      | 4 0 1 1 0 1 2                |   |                              |                                 |                              |                                 |                              |                                 |                              |                                 |                                  |                                    |                                  |        |
| Jose Tartabull, L (8, PR)<br>OBP: 0.176, SLG: 0.235   |                              |                                 |                              |                                 |                              |                                 |                              |                                 |                              |                                 | 0 0 0 0 0 0 0                |   |                              |                                 |                              |                                 |                              |                                 |                              |                                 |                                  |                                    |                                  |        |
| Doc Edwards, R (8, 2)<br>OBP: 0.257, SLG: 0.283       | 1-2f<br>3-H                  |                                 |                              |                                 |                              |                                 |                              |                                 |                              |                                 | 1 0 0 0 0 0 0                |   |                              |                                 |                              |                                 |                              |                                 |                              |                                 |                                  |                                    |                                  |        |
| George Alusik, R (1, 7)<br>OBP: 0.400, SLG: 0.402     | 0-0<br>1-3                   |                                 |                              |                                 | 0-0<br>6-3                   |                                 |                              | 0-0<br>F8                       |                              | 0-0<br>FC6-4<br>1-2f            | 5 0 0 0 0 1 2                |   |                              |                                 |                              |                                 |                              |                                 |                              |                                 |                                  |                                    |                                  |        |
| Dick Green, R (1, 4)<br>OBP: 0.251, SLG: 0.328        |                              | 0-0<br>SH2-4<br>1B              |                              |                                 | 0-0<br>F6                    |                                 |                              | 0-0<br>F8                       |                              | 0-0<br>E1<br>E<br>1B            | 4 1 2 0 0 0 0                |   |                              |                                 |                              |                                 |                              |                                 |                              |                                 |                                  |                                    |                                  |        |
| Moe Drabowsky, R (1, 1)<br>OBP: 0.045, SLG: 0.045     |                              | 0-0<br>SH2-4                    |                              |                                 | 0-3<br>K                     |                                 |                              | 0-0<br>F7                       |                              | 0-3<br>K                        | 1 0 0 0 0 1 0                |   |                              |                                 |                              |                                 |                              |                                 |                              |                                 |                                  |                                    |                                  |        |
| Dan Pfister, R (6, 1)                                 |                              |                                 |                              |                                 |                              |                                 |                              |                                 |                              |                                 | 1 0 0 0 0 0 0                |   |                              |                                 |                              |                                 |                              |                                 |                              |                                 |                                  |                                    |                                  |        |
| Joe Grzenda, R (7, 1)                                 |                              |                                 |                              |                                 |                              |                                 |                              |                                 |                              |                                 | 0 0 0 0 0 0 0                |   |                              |                                 |                              |                                 |                              |                                 |                              |                                 |                                  |                                    |                                  |        |
| Jose Santiago, R (7, 1)                               |                              |                                 |                              |                                 |                              |                                 |                              |                                 |                              |                                 | 0 0 0 0 0 0 0                |   |                              |                                 |                              |                                 |                              |                                 |                              |                                 |                                  |                                    |                                  |        |
| Charlie Lau, L (9, PH)<br>OBP: 0.326, SLG: 0.398      |                              |                                 |                              |                                 |                              |                                 |                              |                                 |                              |                                 | 1 0 0 0 0 1 1                |   |                              |                                 |                              |                                 |                              |                                 |                              |                                 |                                  |                                    |                                  |        |
| John Wight, R (9, 1)                                  |                              |                                 |                              |                                 |                              |                                 |                              |                                 |                              |                                 | 0 0 0 0 0 0 0                |   |                              |                                 |                              |                                 |                              |                                 |                              |                                 |                                  |                                    |                                  |        |
| <b>Inning Stats</b>                                   | R: 3<br>E: 0<br>K: 0<br>S: 6 | H: 3<br>LOB: 1<br>BB: 0<br>P: 7 | R: 0<br>E: 0<br>K: 1<br>S: 6 | H: 1<br>LOB: 1<br>BB: 0<br>P: 6 | R: 0<br>E: 0<br>K: 0<br>S: 4 | H: 1<br>LOB: 1<br>BB: 0<br>P: 4 | R: 0<br>E: 0<br>K: 1<br>S: 5 | H: 0<br>LOB: 0<br>BB: 0<br>P: 5 | R: 0<br>E: 0<br>K: 0<br>S: 3 | H: 0<br>LOB: 0<br>BB: 1<br>P: 7 | R: 0<br>E: 0<br>K: 1<br>S: 5 | H: 0<br>LOB: 0<br>BB: 0<br>P: 5   | R: 0<br>E: 0<br>K: 0<br>S: 5 | H: 1<br>LOB: 1<br>BB: 0<br>P: 4 | R: 1<br>E: 1<br>K: 0<br>S: 5 | H: 1<br>LOB: 1<br>BB: 0<br>P: 5 | R: 1<br>E: 2<br>K: 1<br>S: 7 | H: 2<br>LOB: 1<br>BB: 0<br>P: 7 | R: 1<br>E: 0<br>K: 1<br>S: 6 | H: 1<br>LOB: 0<br>BB: 0<br>P: 6 | 1B: 9<br>2B: 0<br>3B: 0<br>HR: 1 | SF: 0<br>SAC: 2<br>DP: 0<br>HBP: 1 | WP: 1<br>PB: 0<br>SB: 1<br>CS: 0 | PA: 43 |
| <b>PITCHER</b><br>Dick Donovan, R (1, 1)<br>ERA: 5.53 | IP: 8.0                      | WLS: 35                         | H: 8                         | R: 5                            | ER: 3                        | SO: 3                           | BB: 1                        | IBB: 0                          | HBP: 1                       | BLK: 0                          | WP: 1                        | HR: 0   | S: 39                        | P: 44                           | ERA: 3.38                    | WHIP: 1.125                     |                              |                                 |                              |                                 |                                  |                                    |                                  |        |
| Ted Abernathy, R (9, 1)<br>ERA: 2.77                  | IP: 2.0                      | WLS: 8                          | H: 2                         | R: 1                            | ER: 1                        | SO: 2                           | BB: 0                        | IBB: 0                          | HBP: 0                       | BLK: 0                          | WP: 0                        | HR: 1   | S: 12                        | P: 12                           | ERA: 4.50                    | WHIP: 1.000                     |                              |                                 |                              |                                 |                                  |                                    |                                  |        |

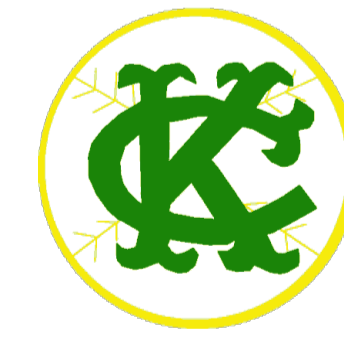

| Batter   | 1             | 2               | 3          | 4         | 5                | 6               | 7             | 8         | 9          | 10             | AB | R | H | RBI | BB | SO | LOB |
|--|---------------|-----------------|------------|-----------|------------------|-----------------|---------------|-----------|------------|----------------|----|---|---|-----|----|----|-----|
| Dick Howser, R<br>OBP: 0.336, SLG: 0.332 (1, 6)    | 0-0<br>3-1 1B | 0-0<br>FC1-4 1B |            |           | 0-0<br>1-H 1B 3B |                 | 4-0<br>SH BB  |           | 0-3<br>K   |                | 4  | 2 | 3 | 1   | 1  | 1  | 0   |
| Vic Davaillo, L<br>OBP: 0.296, SLG: 0.340 (1, 8)   | 0-0<br>3-1 1B | 0-0<br>FC1-4    |            |           | 0-0<br>G4-6-3 1B |                 | 0-0<br>SH 1B  |           | 0-0<br>6-3 |                | 4  | 1 | 2 | 1   | 0  | 0  | 1   |
| Leon Wagner, L<br>OBP: 0.365, SLG: 0.517 (1, 7)    | 0-0<br>3-1    |                 | 0-0<br>F9  |           | 0-0<br>G4-6-3    |                 | 0-0<br>4-3    |           | 0-0<br>G3  |                | 5  | 0 | 0 | 0   | 0  | 0  | 4   |
| John Romano, R<br>OBP: 0.390, SLG: 0.576 (1, 2)    | 4-0<br>BB     |                 | 0-0<br>F7  |           | 4-0<br>CS BB     |                 | 4-0<br>1B IBB |           |            | 0-0<br>G6-3 1B | 2  | 0 | 1 | 0   | 3  | 0  | 0   |
| Mudcat Grant, R<br>OBP: 0.320, SLG: 0.591 (10, PR) |               |                 |            |           |                  |                 |               |           |            |                | 0  | 0 | 0 | 0   | 0  | 0  | 0   |
| Bob Chance, L<br>OBP: 0.418, SLG: 0.628 (1, 9)     | 0-3<br>K      |                 | 0-0<br>3-1 |           | 0-0<br>CS        | 4-0<br>FC6-4 BB | 0-0<br>1-2 1B |           |            | 0-0<br>G6-3    | 4  | 0 | 1 | 1   | 1  | 1  | 4   |
| Fred Whitfield, L<br>OBP: 0.327, SLG: 0.444 (1, 3) | 0-0<br>F7     |                 |            | 0-0<br>F4 |                  | 0-0<br>F6       | 0-3<br>K      |           | 0-3<br>K   |                | 3  | 0 | 0 | 0   | 0  | 0  | 4   |
| Billy Moran, R<br>OBP: 0.319, SLG: 0.330 (7, PH)   |               |                 |            |           |                  |                 |               |           |            | 0-3<br>K       | 0  | 0 | 0 | 0   | 0  | 0  | 0   |
| Tito Francona, L<br>OBP: 0.370, SLG: 0.304 (7, PH) |               |                 |            |           |                  |                 |               |           |            |                | 1  | 0 | 0 | 0   | 0  | 1  | 2   |
| Al Smith, R<br>OBP: 0.158, SLG: 0.218 (8, 9)       |               |                 |            |           |                  |                 |               |           |            |                | 1  | 0 | 0 | 0   | 0  | 1  | 1   |
| Max Alvis, R<br>OBP: 0.299, SLG: 0.411 (1, 5)      |               | 0-0<br>HR       |            | 0-0<br>F6 |                  | 0-3<br>K        |               | 0-0<br>F7 |            |                | 4  | 1 | 1 | 1   | 0  | 1  | 1   |
| Larry Brown, R<br>OBP: 0.272, SLG: 0.382 (1, 4)    |               | 0-0<br>F6       |            | 0-3<br>K  |                  | 0-0<br>FC6-4    |               | 0-0<br>F8 |            |                | 4  | 0 | 0 | 0   | 0  | 1  | 1   |
| Dick Donovan, L<br>OBP: 0.250, SLG: 0.077 (1, 1)   |               | 0-3<br>K        |            |           | 4-0<br>3B BB     |                 | 0-3<br>K      |           | 0-0<br>4-3 |                | 3  | 1 | 0 | 0   | 1  | 2  | 0   |
| Ted Abernathy, R<br>(9, 1)                         |               |                 |            |           |                  |                 |               |           |            |                | 0  | 0 | 0 | 0   | 0  | 0  | 0   |

| Inning Stats | R: 0 | H: 2 | E: 0 | LOB: 3 | K: 1 | S: 7 | P: 11 | R: 1 | H: 2 | E: 0 | LOB: 1 | K: 1 | S: 7 | P: 7 | R: 0 | H: 0 | E: 0 | LOB: 0 | K: 0 | S: 3 | P: 3 | R: 0 | H: 0 | E: 0 | LOB: 0 | K: 1 | S: 5 | P: 5 | R: 2 | H: 2 | E: 0 | LOB: 0 | K: 0 | S: 3 | P: 11 | R: 0 | H: 0 | E: 0 | LOB: 1 | K: 1 | S: 5 | P: 9 | R: 2 | H: 1 | E: 1 | LOB: 2 | K: 2 | S: 9 | P: 17 | R: 0 | H: 0 | E: 0 | LOB: 0 | K: 0 | S: 3 | P: 3 | R: 0 | H: 0 | E: 0 | LOB: 0 | K: 1 | S: 5 | P: 5 | R: 0 | H: 1 | E: 0 | LOB: 1 | K: 1 | S: 5 | P: 5 | R: 0 | H: 1 | E: 0 | LOB: 1 | K: 1 | S: 5 | P: 5 | 1B: 6 | SF: 0 | 2B: 0 | SAC: 1 | 3B: 1 | DP: 2 | HR: 1 | HBP: 0 | WP: 0 | PA: 43 |
|--------------|------|------|------|--------|------|------|-------|------|------|------|--------|------|------|------|------|------|------|--------|------|------|------|------|------|------|--------|------|------|------|------|------|------|--------|------|------|-------|------|------|------|--------|------|------|------|------|------|------|--------|------|------|-------|------|------|------|--------|------|------|------|------|------|------|--------|------|------|------|------|------|------|--------|------|------|------|------|------|------|--------|------|------|------|-------|-------|-------|--------|-------|-------|-------|--------|-------|--------|
|--------------|------|------|------|--------|------|------|-------|------|------|------|--------|------|------|------|------|------|------|--------|------|------|------|------|------|------|--------|------|------|------|------|------|------|--------|------|------|-------|------|------|------|--------|------|------|------|------|------|------|--------|------|------|-------|------|------|------|--------|------|------|------|------|------|------|--------|------|------|------|------|------|------|--------|------|------|------|------|------|------|--------|------|------|------|-------|-------|-------|--------|-------|-------|-------|--------|-------|--------|

| PITCHER                              | IP  | WLS | BF | H | R | ER | SO | BB | IBB | HBP | BLK | WP | HR | S  | P  | ERA  | WHIP  |
|--------------------------------------|-----|-----|----|---|---|----|----|----|-----|-----|-----|----|----|----|----|------|-------|
| Moe Drabowsky, R<br>ERA: 6.2 (1, 1)  | 4.0 |     | 20 | 6 | 3 | 3  | 3  | 2  | 0   | 0   | 0   | 0  | 1  | 24 | 32 | 6.75 | 2.000 |
| Dan Pfister, R<br>ERA: 7.24 (5, 1)   | 2.1 |     | 9  | 0 | 2 | 0  | 2  | 3  | 0   | 0   | 0   | 0  | 0  | 10 | 22 | 0.00 | 1.286 |
| Joe Grzenda, L<br>ERA: 6.14 (7, 1)   | 0.1 |     | 3  | 1 | 0 | 0  | 0  | 0  | 1   | 0   | 0   | 0  | 0  | 2  | 6  | 0.00 | 3.000 |
| Jose Santiago, R<br>ERA: 2.84 (7, 1) | 1.1 |     | 4  | 0 | 0 | 0  | 1  | 0  | 0   | 0   | 0   | 0  | 0  | 6  | 6  | 0.00 | 0.000 |
| John Wyatt, R<br>ERA: 2.33 (9, 1)    | 2.0 | W   | 6  | 1 | 0 | 0  | 2  | 0  | 0   | 0   | 0   | 0  | 0  | 10 | 10 | 0.00 | 0.500 |

**BOTTOM**

**Kansas City Athletics @ Cleveland Indians**  
Cleveland Municipal Stadium, Cleveland, OH

Sun Jun 14 1964, 3:33 AM EDT  
Unknown

livebaseballscorecards.com

|            |    |
|------------|----|
| <b>AB</b>  | 35 |
| <b>R</b>   | 5  |
| <b>H</b>   | 8  |
| <b>RBI</b> | 4  |
| <b>BB</b>  | 6  |
| <b>SO</b>  | 8  |
| <b>LOB</b> | 18 |



| Batter  | 1  | 2   | 3   | 4   | 5   | 6   | 7  | 8  | 9   | AB R H RBI BB SO LOB   | TOP   |  |  |
|---|--|---|---|---|---|---|--|--|---|--|---|--|--|
| Wayne Causey, L<br>OBP: 0.416, SLG: 0.413<br>(1, 6) X   | 0-0<br>6-3<br>1B   |   | 0-0<br>1B   |   | 0-0<br>6-3  |   | 4-0<br>WP<br>BB  |  | 0-0<br>F7   | 4 0 1 0 1 0 0  |   |  |  |
| Nelson Mathews, R<br>OBP: 0.294, SLG: 0.330<br>(1, 8) X   | 0-0<br>2B<br>1B  |   | 0-0<br>F9   |   |   | 0-0<br>WP<br>1B<br>SF7<br>1B                                    | 0-0<br>F3  |  |   | 4 1 2 0 0 0 2  |   |  |  |
| Ed Charles, R<br>OBP: 0.353, SLG: 0.394<br>(1, 5) S S S   | 0-3<br>K   |   | 0-3<br>K  |   |   | 0-0<br>WP<br>1B   | 0-3<br>K   |  |   | 4 0 1 0 0 3 3  |   |  |  |
| Rocky Colavito, R<br>OBP: 0.374, SLG: 0.535<br>(1, 9) X   | 0-0<br>1-3<br>2B   |   | 0-0<br>4-3  |   |   | 0-0<br>F2<br>1-2<br>2-3   |  | 0-0<br>F4  |   | 4 0 1 0 0 0 3  |   |  |  |
| Jim Gentile, L<br>OBP: 0.411, SLG: 0.567<br>(1, 3) B B B  | 4-0<br>FC6-4<br>BB   |   |   | 0-0<br>4-3  |   | 0-0<br>SF7  |  | 4-0<br>BB  |   | 1 0 0 1 2 0 0  |   |  |  |
| Doc Edwards, R<br>OBP: 0.250, SLG: 0.275<br>(1, 2) X<br>Billy Bryan, L<br>OBP: 0.386, SLG: 0.641<br>(8, PH)<br>(8, 2) | 0-0<br>FC6-4<br>1-2f   |   |   | 0-0<br>F7   |   | 0-0<br>F7<br>3-H  |  | 0-3<br>K   |   | 3 0 0 0 0 0 4<br>1 0 0 0 0 1 1   |   |  |  |
| George Alusik, R<br>OBP: 0.403, SLG: 0.400<br>(1, 7) X  |  | 0-0<br>G5-4-3<br>1B   |   |   | 0-0<br>6-3  |   | 4-0<br>HR<br>BB  |  | 0-3<br>K  | 3 1 1 0 1 1 1  | AB 32<br>R 3<br>H 7<br>RBI 3<br>BB 4<br>SO 8<br>LOB 15                                |  |  |
| Dick Green, R<br>OBP: 0.251, SLG: 0.342<br>(1, 4) X   |  | 0-0<br>G5-4-3<br>1-2f   |   |   | 0-0<br>5-3  |   | 0-0<br>1-H<br>HR   |  | 0-3<br>K  | 4 1 1 2 0 1 1  |   |  |  |
| John O'Donoghue, R<br>OBP: 0.300, SLG: 0.450<br>(1, 1)<br>John Wyatt, R<br>(9, 1)                                     |  | 0-3<br>K  |   |   | 0-3<br>K  |   | 0-0<br>F3  |  | 0-0<br>G3   | 4 0 0 0 0 2 0<br>0 0 0 0 0 0 0   |  |  |  |
| <b>Inning Stats</b>   | R: 0<br>E: 0<br>K: 1<br>S: 7<br>H: 2<br>LOB: 3<br>BB: 1<br>P: 11 | R: 0<br>E: 0<br>K: 1<br>S: 5<br>H: 1<br>LOB: 0<br>BB: 0<br>P: 5 | R: 0<br>E: 0<br>K: 1<br>S: 6<br>H: 1<br>LOB: 1<br>BB: 0<br>P: 6 | R: 0<br>E: 0<br>K: 0<br>S: 3<br>H: 0<br>LOB: 0<br>BB: 0<br>P: 3 | R: 0<br>E: 0<br>K: 1<br>S: 5<br>H: 0<br>LOB: 0<br>BB: 0<br>P: 5         | R: 1<br>E: 0<br>K: 0<br>S: 5<br>H: 2<br>LOB: 1<br>BB: 0<br>P: 5 | R: 2<br>E: 0<br>K: 1<br>S: 6<br>H: 1<br>LOB: 1<br>BB: 2<br>P: 14 | R: 0<br>E: 0<br>K: 2<br>S: 7<br>H: 0<br>LOB: 1<br>BB: 1<br>P: 11 | R: 0<br>E: 0<br>K: 1<br>S: 5<br>H: 0<br>LOB: 0<br>BB: 0<br>P: 5 | 1B: 5<br>2B: 1<br>3B: 0<br>HR: 1<br>SF: 1<br>SAC: 0<br>DP: 1<br>HBP: 0 | WP: 2<br>PB: 0<br>SB: 0<br>CS: 0<br>PA: 37  |  |  |
| <b>PITCHER</b><br>Tommy John, L<br>ERA: 3.52<br>Sam McDowell, L<br>ERA: 1.52<br>Don McMahon, R<br>ERA: 1.13           | IP WLS BF H R ER SO BB IBB HBP BLK WP HR S P ERA WHIP            | 6.1 L 28 7 3 3 4 3 0 0 0 1 1 33 45 4.26 1.579                   | 0.2 2 0 0 0 1 0 0 0 0 1 0 4 4 0.00 0.000                        | 2.0 7 0 0 0 3 1 0 0 0 0 0 12 16 0.00 0.500                      | <b>PITCHER</b><br>IP WLS BF H R ER SO BB IBB HBP BLK WP HR S P ERA WHIP |   |  |  |   |  |   |  |  |

**Kansas City Athletics @ Cleveland Indians**  
Cleveland Municipal Stadium, Cleveland, OH  
Sun Jun 14 1964, 3:38 AM EDT  
Att: 30,013 - Unknown

|     |    |
|-----|----|
| AB  | 32 |
| R   | 3  |
| H   | 7  |
| RBI | 3  |
| BB  | 4  |
| SO  | 8  |
| LOB | 15 |



| Batter  | 1                   | 2                                   | 3          | 4          | 5                        | 6          | 7                         | 8         | 9 | AB | R | H | RBI | BB | SO | LOB |
|---|---------------------|-------------------------------------|------------|------------|--------------------------|------------|---------------------------|-----------|---|----|---|---|-----|----|----|-----|
| Dick Howser, R<br>OBP: 0.335, SLG: 0.330 (1, 6)     | 0-0<br>G6-3<br>1B   | 0-0<br>F8                           |            |            | 0-0<br>G3                |            | 0-0<br>FC5                |           |   | 4  | 0 | 1 | 0   | 0  | 0  | 5   |
| Vic Davalillo, L<br>OBP: 0.289, SLG: 0.331 (1, 8)   | 0-0<br>G6-3<br>1-2f |                                     | 0-0<br>6-3 |            | 0-0<br>1-3               |            |                           | 0-3<br>K  |   | 4  | 0 | 0 | 0   | 0  | 1  | 2   |
| Leon Wagner, L<br>OBP: 0.359, SLG: 0.507 (1, 7)     | 0-0<br>4-3          |                                     | 0-3<br>K   |            |                          | 0-0<br>F9  |                           | 0-0<br>F6 |   | 4  | 0 | 0 | 0   | 0  | 1  | 0   |
| John Romano, R<br>OBP: 0.387, SLG: 0.589 (1, 2)     |                     | 0-0<br>F6                           | 0-0<br>5-3 |            |                          | 0-0<br>HR  |                           | 0-3<br>K  |   | 4  | 1 | 1 | 1   | 0  | 1  | 0   |
| Max Alvis, R<br>OBP: 0.298, SLG: 0.405 (1, 5)       |                     | 1-0<br>BB<br>1B<br>HBP              |            | 0-3<br>K   |                          | 0-0<br>5-3 |                           | 0-0<br>F7 |   | 3  | 1 | 0 | 0   | 0  | 1  | 0   |
| Bob Chance, L<br>OBP: 0.421, SLG: 0.622 (1, 3)      |                     | 0-0<br>1B<br>BB<br>1-2<br>1B        |            | 0-0<br>4-3 |                          | 0-0<br>G3  |                           | 0-0<br>1B |   | 4  | 0 | 2 | 0   | 0  | 0  | 0   |
| Mudcat Grant, R<br>OBP: 0.320, SLG: 0.591 (9, PR)   |                     |                                     |            |            |                          |            |                           | 1B        |   | 0  | 0 | 0 | 0   | 0  | 0  | 0   |
| Al Smith, R<br>OBP: 0.183, SLG: 0.228 (1, 9)        |                     | 4-0<br>1B<br>BB<br>1-2<br>2-3<br>BB |            | 0-0<br>F8  |                          |            | 0-0<br>FC5<br>SH5-3<br>1B | 0-0<br>1B |   | 2  | 0 | 1 | 0   | 1  | 0  | 0   |
| Tito Francona, L<br>OBP: 0.374, SLG: 0.310 (9, PH)  |                     |                                     |            |            |                          |            |                           | 1-2<br>1B |   | 1  | 0 | 1 | 0   | 0  | 0  | 0   |
| Larry Brown, R<br>OBP: 0.275, SLG: 0.384 (1, 4)     |                     | 0-0<br>F9                           |            |            | 0-0<br>G3<br>SH1-4<br>1B |            | 0-0<br>SH5-3              | 0-3<br>K  |   | 2  | 0 | 1 | 0   | 0  | 0  | 3   |
| Fred Whitfield, L<br>OBP: 0.325, SLG: 0.441 (9, PH) |                     |                                     |            |            |                          |            |                           | 1-2<br>1B |   | 1  | 0 | 0 | 0   | 0  | 1  | 2   |
| Tommy John, R<br>OBP: 0.250, SLG: 0.250 (1, 1)      |                     | 0-0<br>1B                           |            |            | 0-0<br>SH1-4             |            | 0-0<br>F9                 | 0-3<br>K  |   | 1  | 0 | 1 | 1   | 0  | 0  | 0   |
| Sam McDowell, L<br>OBP: 0.200, SLG: 0.111 (7, 1)    |                     |                                     |            |            |                          |            |                           | 1-2<br>1B |   | 0  | 0 | 0 | 0   | 0  | 0  | 0   |
| Billy Moran, R<br>OBP: 0.318, SLG: 0.328 (7, PH)    |                     |                                     |            |            |                          |            |                           |           |   | 1  | 0 | 0 | 0   | 0  | 0  | 1   |
| Don McMahon, R<br>OBP: 0.200, SLG: 0.200 (8, 1)     |                     |                                     |            |            |                          |            |                           |           |   | 0  | 0 | 0 | 0   | 0  | 0  | 0   |
| Joe Azcue, R<br>OBP: 0.303, SLG: 0.386 (9, PH)      |                     | 1-2<br>2-3<br>3-H<br>1B             |            |            |                          |            |                           |           |   | 1  | 0 | 0 | 0   | 0  | 1  | 2   |

| Inning Stats | R: 0 | H: 1 | E: 0 | LOB: 0 | K: 0 | BB: 0 | S: 3 | P: 3  |
|--------------|------|------|------|--------|------|-------|------|-------|
|              | R: 1 | H: 2 | E: 0 | LOB: 3 | K: 0 | BB: 1 | S: 5 | P: 10 |
|              | R: 0 | H: 0 | E: 0 | LOB: 0 | K: 1 | BB: 0 | S: 5 | P: 5  |
|              | R: 0 | H: 0 | E: 0 | LOB: 0 | K: 1 | BB: 0 | S: 5 | P: 5  |
|              | R: 0 | H: 1 | E: 0 | LOB: 1 | K: 0 | BB: 0 | S: 4 | P: 4  |
|              | R: 1 | H: 1 | E: 0 | LOB: 0 | K: 0 | BB: 0 | S: 4 | P: 4  |
|              | R: 0 | H: 1 | E: 0 | LOB: 1 | K: 0 | BB: 0 | S: 4 | P: 4  |
|              | R: 0 | H: 0 | E: 0 | LOB: 0 | K: 2 | BB: 0 | S: 7 | P: 7  |
|              | R: 0 | H: 2 | E: 0 | LOB: 2 | K: 2 | BB: 0 | S: 9 | P: 9  |
|              | R: 0 | H: 1 | E: 0 | LOB: 0 | K: 0 | BB: 0 | S: 9 | P: 9  |
|              | R: 0 | H: 2 | E: 0 | LOB: 2 | K: 2 | BB: 0 | S: 9 | P: 9  |

| PITCHER                                | IP  | WLS | BF | H | R | ER | SO | BB | IBB | HBP | BLK | WP | HR | S  | P  | ERA  | WHIP  |
|--|-----|-----|----|---|---|----|----|----|-----|-----|-----|----|----|----|----|------|-------|
| John O'Donoghue, L<br>ERA: 5.59 (1, 1) | 8.1 | W   | 33 | 7 | 2 | 2  | 4  | 1  | 0   | 0   | 0   | 0  | 0  | 39 | 44 | 2.16 | 0.960 |
| John Wyatt, R<br>ERA: 2.29 (9, 1)      | 0.2 | S   | 3  | 1 | 0 | 0  | 2  | 0  | 0   | 0   | 0   | 0  | 0  | 7  | 7  | 0.00 | 1.500 |

**BOTTOM**

**Kansas City Athletics @ Cleveland Indians**  
Cleveland Municipal Stadium, Cleveland, OH

Sun Jun 14 1964, 3:38 AM EDT  
Att. 30,013 - Unknown

|     |    |
|-----|----|
| AB  | 32 |
| R   | 2  |
| H   | 8  |
| RBI | 2  |
| BB  | 1  |
| SO  | 6  |
| LOB | 15 |

**C**

|       |        |
|-------|--------|
| WP: 0 | PA: 36 |
| PB: 0 |        |
| SB: 0 |        |
| CS: 0 |        |

livebaseballscorecards.com

| Batter   | 1   | 2                               | 3                            | 4                               | 5                            | 6                               | 7                            | 8                                | 9                            | AB R H RBI BB SO LOB            | TOP  |                                 |                              |                                 |                              |                                  |                              |                                 |                                  |                                    |                                  |        |   |     |    |
|--|---|---------------------------------|------------------------------|---------------------------------|------------------------------|---------------------------------|------------------------------|----------------------------------|------------------------------|---------------------------------|--|---------------------------------|------------------------------|---------------------------------|------------------------------|----------------------------------|------------------------------|---------------------------------|----------------------------------|------------------------------------|----------------------------------|--------|---|-----|----|
| Wayne Causey, L (1, 6)<br>OBP: 0.416, SLG: 0.414   | 4-0<br>FC5-4<br>BB                                    |                                 | 0-0<br>F7                    | 0-0<br>2B                       |                              | 0-0<br>6-3                      |                              |                                  | 0-0<br>2-3                   | 4 1 1 1 1 0 0                   | <p><b>Kansas City Athletics @ Detroit Tigers</b><br/>Tiger Stadium, Detroit, MI<br/>Tue Jun 16 1964, 7:05 PM EDT<br/>Unknown</p> <p>livebaseballscorecards.com</p> <table> <tr><td>AB</td><td>33</td></tr> <tr><td>R</td><td>7</td></tr> <tr><td>H</td><td>7</td></tr> <tr><td>RBI</td><td>7</td></tr> <tr><td>BB</td><td>7</td></tr> <tr><td>SO</td><td>6</td></tr> <tr><td>LOB</td><td>13</td></tr> </table>  | AB                              | 33                           | R                               | 7                            | H                                | 7                            | RBI                             | 7                                | BB                                 | 7                                | SO     | 6 | LOB | 13 |
| AB   | 33  |                                 |                              |                                 |                              |                                 |                              |                                  |                              |                                 |  |                                 |                              |                                 |                              |                                  |                              |                                 |                                  |                                    |                                  |        |   |     |    |
| R  | 7   |                                 |                              |                                 |                              |                                 |                              |                                  |                              |                                 |  |                                 |                              |                                 |                              |                                  |                              |                                 |                                  |                                    |                                  |        |   |     |    |
| H  | 7   |                                 |                              |                                 |                              |                                 |                              |                                  |                              |                                 |  |                                 |                              |                                 |                              |                                  |                              |                                 |                                  |                                    |                                  |        |   |     |    |
| RBI  | 7   |                                 |                              |                                 |                              |                                 |                              |                                  |                              |                                 |  |                                 |                              |                                 |                              |                                  |                              |                                 |                                  |                                    |                                  |        |   |     |    |
| BB   | 7   |                                 |                              |                                 |                              |                                 |                              |                                  |                              |                                 |  |                                 |                              |                                 |                              |                                  |                              |                                 |                                  |                                    |                                  |        |   |     |    |
| SO   | 6   |                                 |                              |                                 |                              |                                 |                              |                                  |                              |                                 |  |                                 |                              |                                 |                              |                                  |                              |                                 |                                  |                                    |                                  |        |   |     |    |
| LOB  | 13  |                                 |                              |                                 |                              |                                 |                              |                                  |                              |                                 |  |                                 |                              |                                 |                              |                                  |                              |                                 |                                  |                                    |                                  |        |   |     |    |
| Doc Edwards, R (1, 2)<br>OBP: 0.248, SLG: 0.264    | 0-0<br>F6   |                                 | 0-0<br>F7                    | 4-0<br>2B<br>BB                 |                              | 0-3<br>K                        |                              | 0-0<br>1-3                       | 4 1 0 0 1 1 1                |                                 |  |                                 |                              |                                 |                              |                                  |                              |                                 |                                  |                                    |                                  |        |   |     |    |
| Ed Charles, R (1, 5)<br>OBP: 0.354, SLG: 0.396     | 0-3<br>K  |                                 | 0-0<br>F2                    | 0-0<br>2B                       |                              | 0-0<br>5-3                      |                              | 4-0<br>BB                        | 4 0 1 2 1 1 1                |                                 |  |                                 |                              |                                 |                              |                                  |                              |                                 |                                  |                                    |                                  |        |   |     |    |
| Rocky Colavito, R (1, 9)<br>OBP: 0.366, SLG: 0.521 | 0-0<br>FC5-4<br>1-2f                                  |                                 |                              | 6-3<br>1-3                      |                              | 0-0<br>F8                       |                              | 0-0<br>6-3                       | 5 0 0 0 0 0 3                |                                 |  |                                 |                              |                                 |                              |                                  |                              |                                 |                                  |                                    |                                  |        |   |     |    |
| Jim Gentile, L (1, 3)<br>OBP: 0.412, SLG: 0.582    |   | 0-0<br>G3                       |                              | 4-0<br>2B<br>BB                 | 0-3<br>K                     |                                 | 0-0<br>HR                    |                                  | 3 2 1 1 1 1 0                |                                 |  |                                 |                              |                                 |                              |                                  |                              |                                 |                                  |                                    |                                  |        |   |     |    |
| George Alusik, R (1, 7)<br>OBP: 0.406, SLG: 0.398  |   | 4-0<br>1B<br>BB                 |                              | 0-0<br>L5                       | 0-0<br>1B                    |                                 | 0-0<br>L7                    |                                  | 3 0 1 0 1 0 1                |                                 |  |                                 |                              |                                 |                              |                                  |                              |                                 |                                  |                                    |                                  |        |   |     |    |
| Nelson Mathews, R (1, 8)<br>OBP: 0.302, SLG: 0.339 |   | 0-0<br>1B                       |                              | 0-0<br>2B                       | 0-0<br>G4-6-3                |                                 | 4-0<br>BB                    |                                  | 3 1 2 0 1 0 1                |                                 |  |                                 |                              |                                 |                              |                                  |                              |                                 |                                  |                                    |                                  |        |   |     |    |
| Dick Green, R (1, 4)<br>OBP: 0.251, SLG: 0.337     |   | 0-0<br>F7                       |                              | 4-0<br>2B<br>IBB                |                              | 0-3<br>K2-3                     |                              | 0-3<br>K                         | 3 1 0 0 1 2 3                |                                 |  |                                 |                              |                                 |                              |                                  |                              |                                 |                                  |                                    |                                  |        |   |     |    |
| Diego Segui, R (1, 1)<br>OBP: 0.242, SLG: 0.323    |   | 0-0<br>F7                       |                              | 0-0<br>2B                       |                              | 0-3<br>K                        |                              | 0-0<br>F2                        | 4 1 1 3 0 1 3                |                                 |  |                                 |                              |                                 |                              |                                  |                              |                                 |                                  |                                    |                                  |        |   |     |    |
| Wes Stock, R (9, 1)                                |   |                                 |                              | 1-H<br>2-H<br>3-H               |                              |                                 |                              |                                  | 0 0 0 0 0 0 0                |                                 |  |                                 |                              |                                 |                              |                                  |                              |                                 |                                  |                                    |                                  |        |   |     |    |
| <b>Inning Stats</b>                                | R: 0<br>E: 0<br>K: 1<br>S: 5                          | H: 0<br>LOB: 1<br>BB: 1<br>P: 9 | R: 0<br>E: 0<br>K: 0<br>S: 4 | H: 1<br>LOB: 2<br>BB: 1<br>P: 8 | R: 0<br>E: 0<br>K: 0<br>S: 3 | H: 0<br>LOB: 0<br>BB: 0<br>P: 3 | R: 6<br>E: 0<br>K: 0<br>S: 7 | H: 4<br>LOB: 1<br>BB: 3<br>P: 19 | R: 0<br>E: 0<br>K: 1<br>S: 5 | H: 1<br>LOB: 0<br>BB: 0<br>P: 5 | R: 0<br>E: 0<br>K: 2<br>S: 7   | H: 0<br>LOB: 0<br>BB: 0<br>P: 7 | R: 0<br>E: 0<br>K: 1<br>S: 5 | H: 0<br>LOB: 0<br>BB: 0<br>P: 5 | R: 1<br>E: 0<br>K: 1<br>S: 6 | H: 1<br>LOB: 1<br>BB: 1<br>P: 10 | R: 0<br>E: 0<br>K: 0<br>S: 3 | H: 0<br>LOB: 1<br>BB: 1<br>P: 7 | 1B: 2<br>2B: 4<br>3B: 0<br>HR: 1 | SF: 0<br>SAC: 0<br>DP: 1<br>HBP: 0 | WP: 0<br>PB: 0<br>SB: 0<br>CS: 0 | PA: 40 |   |     |    |
| <b>PITCHER</b>                                     | IP WLS BF H R ER SO BB IBB HBP BLK WP HR S P ERA WHIP |                                 |                              |                                 |                              |                                 |                              |                                  |                              |                                 |  |                                 |                              |                                 |                              |                                  |                              |                                 |                                  |                                    |                                  |        |   |     |    |
| Hank Aguirre, L (1, 1)<br>ERA: 3.84                | 3.2 L 20 4 6 6 1 4 1 0 0 0 0 0 17 37 14.73 2.182      |                                 |                              |                                 |                              |                                 |                              |                                  |                              |                                 |  |                                 |                              |                                 |                              |                                  |                              |                                 |                                  |                                    |                                  |        |   |     |    |
| Fred Gladding, R (4, 1)<br>ERA: 7.36               | 1.1 5 2 0 0 1 0 0 0 0 0 0 0 7 7 0.00 1.500            |                                 |                              |                                 |                              |                                 |                              |                                  |                              |                                 |  |                                 |                              |                                 |                              |                                  |                              |                                 |                                  |                                    |                                  |        |   |     |    |
| Joe Sparma, R (6, 1)<br>ERA:                       | 2.0 6 0 0 0 3 0 0 0 0 0 0 0 12 12 0.00 0.000          |                                 |                              |                                 |                              |                                 |                              |                                  |                              |                                 |  |                                 |                              |                                 |                              |                                  |                              |                                 |                                  |                                    |                                  |        |   |     |    |
| Dick Egan, L (8, 1)<br>ERA: 3.18                   | 2.0 9 1 1 1 1 2 0 0 0 0 0 1 9 17 4.50 1.500           |                                 |                              |                                 |                              |                                 |                              |                                  |                              |                                 |  |                                 |                              |                                 |                              |                                  |                              |                                 |                                  |                                    |                                  |        |   |     |    |

| Batter   | 1                           | 2          | 3                                | 4         | 5          | 6          | 7          | 8                    | 9                      | AB R H RBI BB SO LOB  |
|--|-----------------------------|------------|----------------------------------|-----------|------------|------------|------------|----------------------|------------------------|---|
| Jerry Lumpe, L<br>OBP: 0.288, SLG: 0.332<br>(1, 4)   | 0-0<br>FC4-6<br>2B          |            | 4-0<br>FC3-6<br>BB               |           | 0-0<br>4-3 |            |            | 4-0<br>FC4-6<br>BB   | 0-0<br>1-H<br>2B       | 3 0 2 1 2 0 0   |
| Bill Bruton, L<br>OBP: 0.289, SLG: 0.357<br>(1, 8)   | 0-0<br>F7                   |            | 0-0<br>FC3-6<br>CS<br>BB<br>1-2f |           | 0-3<br>K   |            |            | 0-0<br>F9            | 0-0<br>4-3             | 5 0 0 0 0 1 4   |
| Al Kaline, R<br>OBP: 0.387, SLG: 0.453<br>(1, 9)   | 4-0<br>FC4-6<br>BB          |            | 4-0<br>1-2<br>BB                 |           |            | 0-3<br>K   |            | 0-0<br>FC4-6<br>1-2f |                        | 2 0 0 0 2 1 1   |
| Norm Cash, L<br>OBP: 0.316, SLG: 0.419<br>(1, 3)   | 0-0<br>FC4-6<br>1-2f<br>2-3 |            | 0-3<br>K<br>2-3                  |           |            | 0-0<br>3-1 |            | 0-3<br>K             |                        | 4 0 0 0 0 2 5   |
| Don Demeter, R<br>OBP: 0.294, SLG: 0.436<br>(1, 7)   | 0-0<br>F7                   |            |                                  | 0-0<br>F6 |            | 4-0<br>BB  |            |                      | 0-0<br>2B<br>1B        | 3 1 1 0 1 0 2   |
| Dick McAuliffe, L<br>OBP: 0.333, SLG: 0.468<br>(1, 6)  |                             | 0-0<br>1-3 |                                  | 0-0<br>L8 |            | 0-0<br>3-1 |            |                      | 0-0<br>1-3<br>1B<br>2B | 4 1 1 0 0 0 1   |
| Bill Freehan, R<br>OBP: 0.363, SLG: 0.516<br>(1, 2)  |                             | 0-0<br>6-3 |                                  | 0-0<br>HR |            |            | 0-0<br>4-3 |                      | 0-0<br>2B<br>1B        | 4 2 2 3 0 0 0   |
| Don Wert, R<br>OBP: 0.312, SLG: 0.339<br>(1, 5)  |                             | 4-0<br>BB  |                                  | 0-0<br>F3 |            |            | 0-0<br>F3  |                      | 0-3<br>K<br>2-H<br>3-H | 3 0 0 0 1 1 1   |
| Hank Aguirre, R<br>Fred Gladding, L<br>Bubba Phillips, R<br>Joe Sparrma, R<br>Gates Brown, L<br>Dick Egan, L<br>George Thomas, R |                             | 0-3<br>K   |                                  |           | 0-3<br>K   |            | 0-3<br>K   |                      | 0-3<br>K               | 1 0 0 0 0 0 1 1<br>0 0 0 0 0 0 0 0<br>1 0 0 0 0 0 1 0<br>0 0 0 0 0 0 0 0<br>1 0 0 0 0 0 1 0<br>0 0 0 0 0 0 0 0<br>1 0 0 0 0 0 1 1 |

BOTTOM

Kansas City Athletics @ Detroit Tigers  
Tiger Stadium, Detroit, MI  
Tue Jun 16 1964, 7:05 PM EDT  
Unknown

livebaseballscorecards.com

|     |    |
|-----|----|
| AB  | 32 |
| R   | 4  |
| H   | 6  |
| RBI | 4  |
| BB  | 6  |
| SO  | 9  |
| LOB | 16 |



| Inning Stats                | R: 0   | H: 1 | E: 0 | K: 0 | S: 4 | LOB: 2 | BB: 1 | P: 8 | R: 0 | H: 0 | E: 0 | K: 1 | S: 5 | LOB: 1 | BB: 1 | P: 9 | R: 0  | H: 0 | E: 0 | K: 1 | S: 4 | LOB: 2 | BB: 2 | P: 12 | R: 1 | H: 1 | E: 0 | K: 0 | S: 4 | LOB: 0 | BB: 0 | P: 4 | R: 0 | H: 0 | E: 0 | K: 2 | S: 7 | LOB: 0 | BB: 0 | P: 7 | R: 0 | H: 0 | E: 0 | K: 1 | S: 5 | LOB: 1 | BB: 1 | P: 9 | R: 0 | H: 0 | E: 0 | K: 1 | S: 5 | LOB: 0 | BB: 0 | P: 5 | R: 0 | H: 0 | E: 0 | K: 1 | S: 5 | LOB: 1 | BB: 1 | P: 9 | R: 3 | H: 4 | E: 0 | K: 2 | S: 11 | LOB: 1 | BB: 0 | P: 11 | 1B: 2 | SF: 0 | 2B: 4 | SAC: 0 | 3B: 0 | DP: 1 | HR: 1 | HBP: 0 | WP: 0 | PA: 38 |
|-----------------------------|--------|------|------|------|------|--------|-------|------|------|------|------|------|------|--------|-------|------|-------|------|------|------|------|--------|-------|-------|------|------|------|------|------|--------|-------|------|------|------|------|------|------|--------|-------|------|------|------|------|------|------|--------|-------|------|------|------|------|------|------|--------|-------|------|------|------|------|------|------|--------|-------|------|------|------|------|------|-------|--------|-------|-------|-------|-------|-------|--------|-------|-------|-------|--------|-------|--------|
| PITCHER                     | IP     | WLS  | BF   | H    | R    | ER     | SO    | BB   | IBB  | HBP  | BLK  | WP   | HR   | S      | P     | ERA  | WHIP  |      |      |      |      |        |       |       |      |      |      |      |      |        |       |      |      |      |      |      |      |        |       |      |      |      |      |      |      |        |       |      |      |      |      |      |      |        |       |      |      |      |      |      |      |        |       |      |      |      |      |      |       |        |       |       |       |       |       |        |       |       |       |        |       |        |
| Diego Segui, R<br>ERA: 4.37 | (1, 1) | 8.0  | W    | 34   | 5    | 4      | 4     | 7    | 6    | 0    | 0    | 0    | 0    | 42     | 66    | 4.50 | 1.375 |      |      |      |      |        |       |       |      |      |      |      |      |        |       |      |      |      |      |      |      |        |       |      |      |      |      |      |      |        |       |      |      |      |      |      |      |        |       |      |      |      |      |      |      |        |       |      |      |      |      |      |       |        |       |       |       |       |       |        |       |       |       |        |       |        |
| Wes Stock, R<br>ERA: 3.74   | (9, 1) | 1.0  | S    | 4    | 1    | 0      | 0     | 2    | 0    | 0    | 0    | 0    | 0    | 8      | 8     | 0.00 | 1.000 |      |      |      |      |        |       |       |      |      |      |      |      |        |       |      |      |      |      |      |      |        |       |      |      |      |      |      |      |        |       |      |      |      |      |      |      |        |       |      |      |      |      |      |      |        |       |      |      |      |      |      |       |        |       |       |       |       |       |        |       |       |       |        |       |        |

| Batter   | 1   | 2                                | 3                            | 4                               | 5                            | 6                               | 7                             | 8                                | 9                            | AB R H RBI BB SO LOB            | TOP                          |                                 |                              |                                 |                              |                                 |                              |                                  |                                  |                                    |                                  |        |
|--|---|----------------------------------|------------------------------|---------------------------------|------------------------------|---------------------------------|-------------------------------|----------------------------------|------------------------------|---------------------------------|------------------------------|---------------------------------|------------------------------|---------------------------------|------------------------------|---------------------------------|------------------------------|----------------------------------|----------------------------------|------------------------------------|----------------------------------|--------|
| Wayne Causey, L (1, 6)<br>OBP: 0.413, SLG: 0.420   | 0-0<br>1B<br>3B                                       |                                  | 0-3<br>K                     |                                 | 0-0<br>6-3                   |                                 |                               | 0-0<br>F6                        |                              | 4 1 1 0 0 1 0                   |                              |                                 |                              |                                 |                              |                                 |                              |                                  |                                  |                                    |                                  |        |
| Nelson Mathews, R (1, 8)<br>OBP: 0.301, SLG: 0.338 | 0-3<br>K  |                                  | 0-3<br>K                     |                                 | 0-3<br>K                     |                                 |                               | 0-0<br>CS<br>1B                  |                              | 4 0 1 0 0 3 1                   |                              |                                 |                              |                                 |                              |                                 |                              |                                  |                                  |                                    |                                  |        |
| Ed Charles, R (1, 5)<br>OBP: 0.356, SLG: 0.398     | 0-0<br>1B<br>1B                                       |                                  | 0-0<br>5-3                   |                                 | 0-3<br>K                     |                                 |                               | 0-0<br>CS<br>1-2                 | 0-0<br>1B<br>HR<br>1B        | 4 1 2 1 0 1 0                   |                              |                                 |                              |                                 |                              |                                 |                              |                                  |                                  |                                    |                                  |        |
| Rocky Colavito, R (1, 9)<br>OBP: 0.368, SLG: 0.520 | 0-0<br>1-2<br>1B                                      |                                  | 0-3<br>K                     |                                 | 0-0<br>L6                    |                                 |                               | 0-0<br>1-2<br>HR<br>1B           |                              | 4 1 2 0 0 1 0                   |                              |                                 |                              |                                 |                              |                                 |                              |                                  |                                  |                                    |                                  |        |
| Jim Gentile, L (1, 3)<br>OBP: 0.409, SLG: 0.571    | 0-0<br>F5   |                                  | 4-0<br>HR<br>BB              |                                 | 0-3<br>K                     |                                 |                               | 0-0<br>F5                        |                              | 3 1 0 0 1 1 4                   |                              |                                 |                              |                                 |                              |                                 |                              |                                  |                                  |                                    |                                  |        |
| Billy Bryan, L (1, 2)<br>OBP: 0.396, SLG: 0.767    | 0-3<br>K  |                                  | 0-0<br>1-H<br>HR             |                                 | 0-3<br>K                     |                                 |                               | 0-0<br>1-H<br>2-H<br>HR          |                              | 4 2 2 5 0 2 2                   |                              |                                 |                              |                                 |                              |                                 |                              |                                  |                                  |                                    |                                  |        |
| George Alusik, R (1, 7)<br>OBP: 0.394, SLG: 0.383  |   | 0-3<br>K                         | 0-3<br>K                     |                                 | 0-0<br>F6                    |                                 |                               | 0-0<br>5-3                       |                              | 4 0 0 0 0 2 0                   |                              |                                 |                              |                                 |                              |                                 |                              |                                  |                                  |                                    |                                  |        |
| Dick Green, R (1, 4)<br>OBP: 0.251, SLG: 0.332     |   | 0-3<br>K                         | 0-3<br>K                     |                                 | 0-0<br>5-3                   |                                 |                               | 4-0<br>BB                        |                              | 3 0 0 0 1 2 0                   |                              |                                 |                              |                                 |                              |                                 |                              |                                  |                                  |                                    |                                  |        |
| Ted Bowsfield, R (1, 1)                            |   | 0-0<br>1-3                       |                              | 0-0<br>6-3                      |                              |                                 |                               | 0-0<br>6-3                       | 0-3<br>K                     | 4 0 0 0 0 1 1                   |                              |                                 |                              |                                 |                              |                                 |                              |                                  |                                  |                                    |                                  |        |
| <b>Inning Stats</b>                                | R: 1<br>E: 0<br>K: 2<br>S: 10                         | H: 3<br>LOB: 2<br>BB: 0<br>P: 10 | R: 0<br>E: 0<br>K: 2<br>S: 7 | H: 0<br>LOB: 0<br>BB: 0<br>P: 7 | R: 0<br>E: 0<br>K: 2<br>S: 7 | H: 0<br>LOB: 0<br>BB: 0<br>P: 7 | R: 2<br>E: 0<br>K: 3<br>S: 10 | H: 1<br>LOB: 0<br>BB: 1<br>P: 14 | R: 0<br>E: 0<br>K: 1<br>S: 5 | H: 0<br>LOB: 0<br>BB: 0<br>P: 5 | R: 0<br>E: 0<br>K: 2<br>S: 7 | H: 0<br>LOB: 0<br>BB: 0<br>P: 7 | R: 0<br>E: 0<br>K: 1<br>S: 5 | H: 0<br>LOB: 0<br>BB: 0<br>P: 5 | R: 0<br>E: 0<br>K: 0<br>S: 3 | H: 1<br>LOB: 0<br>BB: 0<br>P: 3 | R: 3<br>E: 0<br>K: 1<br>S: 8 | H: 3<br>LOB: 1<br>BB: 1<br>P: 12 | 1B: 5<br>2B: 0<br>3B: 1<br>HR: 2 | SF: 0<br>SAC: 0<br>DP: 0<br>HBP: 0 | WP: 0<br>PB: 0<br>SB: 0<br>CS: 1 | PA: 37 |
| <b>PITCHER</b>                                     | IP WLS BF H R ER SO BB IBB HBP BLK WP HR S P ERA WHIP |                                  |                              |                                 |                              |                                 |                               |                                  |                              |                                 |                              |                                 |                              |                                 |                              |                                 |                              |                                  |                                  |                                    |                                  |        |
| Phil Regan, R (1, 1)<br>ERA: 4.92                  | 8.0 L 29 5 3 3 13 1 0 0 0 0 1 54 58 3.38 0.750        |                                  |                              |                                 |                              |                                 |                               |                                  |                              |                                 |                              |                                 |                              |                                 |                              |                                 |                              |                                  |                                  |                                    |                                  |        |
| Larry Sherry, R (9, 1)<br>ERA: 3.58                | 1.0 7 3 3 3 1 1 0 0 0 0 1 8 12 27.00 4.000            |                                  |                              |                                 |                              |                                 |                               |                                  |                              |                                 |                              |                                 |                              |                                 |                              |                                 |                              |                                  |                                  |                                    |                                  |        |

**Kansas City Athletics @ Detroit Tigers**  
 Tiger Stadium, Detroit, MI  
 Tue Jun 16 1964, 7:05 PM EDT  
 Att. 15,338 - Unknown

|     |    |
|-----|----|
| AB  | 34 |
| R   | 6  |
| H   | 8  |
| RBI | 6  |
| BB  | 2  |
| SO  | 14 |
| LOB | 8  |

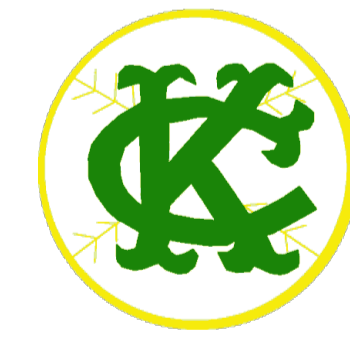

| Batter | 1 | 2 | 3 | 4 | 5 | 6 | 7 | 8 | 9 | AB | R | H | RBI | BB | SO | LOB |
|--------|---|---|---|---|---|---|---|---|---|----|---|---|-----|----|----|-----|
|--------|---|---|---|---|---|---|---|---|---|----|---|---|-----|----|----|-----|

|  |  |  |  |  |  |  |  |  |  |   |   |   |   |   |   |   |   |
|--|--|--|--|--|--|--|--|--|--|---|---|---|---|---|---|---|---|
| <b>Jerry Lumpe, L</b><br><small>(1, 4)</small><br><small>OBP: 0.288, SLG: 0.330</small>    |  |  |  |  |  |  |  |  |  | 4 | 0 | 1 | 0 | 0 | 0 | 2 |   |
| <b>Don Wert, R</b><br><small>(1, 5)</small><br><small>OBP: 0.321, SLG: 0.348</small>       |  |  |  |  |  |  |  |  |  | 4 | 0 | 3 | 0 | 0 | 0 | 2 |   |
| <b>George Thomas, R</b><br><small>(1, 9)</small><br><small>OBP: 0.371, SLG: 0.542</small>  |  |  |  |  |  |  |  |  |  | 4 | 0 | 0 | 0 | 0 | 1 | 3 |   |
| <b>Don Demeter, R</b><br><small>(1, 8)</small><br><small>OBP: 0.293, SLG: 0.432</small>    |  |  |  |  |  |  |  |  |  | 4 | 0 | 1 | 0 | 0 | 1 | 1 |   |
| <b>Bill Freehan, R</b><br><small>(1, 3)</small><br><small>OBP: 0.354, SLG: 0.503</small>   |  |  |  |  |  |  |  |  |  |   | 4 | 0 | 0 | 0 | 0 | 1 | 1 |
| <b>Dick McAuliffe, L</b><br><small>(1, 6)</small><br><small>OBP: 0.333, SLG: 0.466</small> |  |  |  |  |  |  |  |  |  | 3 | 0 | 1 | 0 | 0 | 0 | 0 |   |
| <b>Bubba Phillips, R</b><br><small>(1, 7)</small><br><small>OBP: 0.400, SLG: 0.333</small> |  |  |  |  |  |  |  |  |  | 3 | 0 | 1 | 0 | 0 | 0 | 0 |   |
| <b>Mike Roarke, R</b><br><small>(1, 2)</small><br><small>OBP: 0.229, SLG: 0.196</small>    |  |  |  |  |  |  |  |  |  | 2 | 0 | 0 | 0 | 1 | 0 | 0 |   |
| <b>Phil Regan, R</b><br><small>(1, 1)</small><br><small>OBP: 0.478, SLG: 0.368</small>     |  |  |  |  |  |  |  |  |  | 2 | 0 | 1 | 0 | 0 | 0 | 3 |   |
| <b>Jake Wood, R</b><br><small>(8, PH)</small><br><small>OBP: 0.173, SLG: 0.160</small>     |  |  |  |  |  |  |  |  |  | 1 | 0 | 0 | 0 | 0 | 0 | 0 |   |
| <b>Larry Sherry, R</b><br><small>(9, 1)</small>  |  |  |  |  |  |  |  |  |  | 0 | 0 | 0 | 0 | 0 | 0 | 0 |   |

| Inning Stats | R: 0 | H: 1 | E: 0 | LOB: 1 | K: 1 | BB: 0 | S: 6 | P: 6 | R: 0 | H: 0 | E: 0 | LOB: 0 | K: 0 | BB: 0 | S: 3 | P: 3 | R: 0 | H: 2 | E: 0 | LOB: 1 | K: 0 | BB: 0 | S: 4 | P: 4 | R: 0 | H: 0 | E: 0 | LOB: 0 | K: 1 | BB: 0 | S: 5 | P: 5 | R: 0 | H: 1 | E: 0 | LOB: 0 | K: 1 | BB: 0 | S: 5 | P: 5 | R: 0 | H: 0 | E: 0 | LOB: 0 | K: 0 | BB: 0 | S: 3 | P: 3 | R: 0 | H: 0 | E: 0 | LOB: 0 | K: 0 | BB: 0 | S: 3 | P: 3 | R: 0 | H: 2 | E: 0 | LOB: 1 | K: 0 | BB: 0 | S: 4 | P: 4 | R: 0 | H: 0 | E: 0 | LOB: 0 | K: 0 | BB: 0 | S: 3 | P: 3 | R: 0 | H: 0 | E: 0 | LOB: 0 | K: 0 | BB: 0 | S: 3 | P: 3 |
|--------------|------|------|------|--------|------|-------|------|------|------|------|------|--------|------|-------|------|------|------|------|------|--------|------|-------|------|------|------|------|------|--------|------|-------|------|------|------|------|------|--------|------|-------|------|------|------|------|------|--------|------|-------|------|------|------|------|------|--------|------|-------|------|------|------|------|------|--------|------|-------|------|------|------|------|------|--------|------|-------|------|------|------|------|------|--------|------|-------|------|------|
|--------------|------|------|------|--------|------|-------|------|------|------|------|------|--------|------|-------|------|------|------|------|------|--------|------|-------|------|------|------|------|------|--------|------|-------|------|------|------|------|------|--------|------|-------|------|------|------|------|------|--------|------|-------|------|------|------|------|------|--------|------|-------|------|------|------|------|------|--------|------|-------|------|------|------|------|------|--------|------|-------|------|------|------|------|------|--------|------|-------|------|------|

| PITCHER  | IP  | WLS | BF | H | R | ER | SO | BB | IBB | HBP | BLK | WP | HR | S  | P  | ERA  | WHIP  |
|--|-----|-----|----|---|---|----|----|----|-----|-----|-----|----|----|----|----|------|-------|
| <b>Ted Bowsfield, L</b><br><small>(1, 1)</small><br><small>ERA: 3.75</small> | 9.0 | W   | 32 | 8 | 0 | 0  | 3  | 1  | 0   | 0   | 0   | 0  | 0  | 37 | 41 | 0.00 | 1.000 |

**BOTTOM**

**Kansas City Athletics @ Detroit Tigers**  
**Tiger Stadium, Detroit, MI**  
 Tue Jun 16 1964, 7:05 PM EDT  
 Att. 15,338 - Unknown

|     |    |
|-----|----|
| AB  | 31 |
| R   | 0  |
| H   | 8  |
| RBI | 0  |
| BB  | 1  |
| SO  | 3  |
| LOB | 12 |



| WP | PA | ERA | WHIP |
|----|----|-----|------|
| 0  | 32 |     |      |

| Batter   | 1   | 2                               | 3                            | 4                                | 5                            | 6                               | 7                            | 8                               | 9                            | 10                              | AB R H RBI BB SO LOB          | TOP   |                              |                                 |                              |                                 |                              |                                 |                              |                                 |                                  |                                    |                                  |        |  |  |  |
|--|---|---------------------------------|------------------------------|----------------------------------|------------------------------|---------------------------------|------------------------------|---------------------------------|------------------------------|---------------------------------|-------------------------------|---|------------------------------|---------------------------------|------------------------------|---------------------------------|------------------------------|---------------------------------|------------------------------|---------------------------------|----------------------------------|------------------------------------|----------------------------------|--------|--|--|--|
| Wayne Causey, L (1, 6)<br>OBP: 0.413, SLG: 0.421   | 0-0 L9  |                                 | 0-3 K                        |                                  |                              | 0-0 HR 2B                       |                              | 4-0 FC5-4 BB                    |                              | 0-0 F8                          | 4 1 1 0 1 1 1                 | <b>Kansas City Athletics @ Detroit Tigers</b><br>Tiger Stadium, Detroit, MI<br>Wed Jun 17 1964, 7:05 PM EDT<br>Att: 8,510 - Unknown |                              |                                 |                              |                                 |                              |                                 |                              |                                 |                                  |                                    |                                  |        |  |  |  |
| Nelson Mathews, R (1, 8)<br>OBP: 0.300, SLG: 0.349 | 0-3 K   |                                 |                              | 0-0 L8                           |                              | 0-0 HR 2H                       |                              | 0-0 FC5-4                       |                              |                                 | 4 1 1 2 0 1 2                 |   |                              |                                 |                              |                                 |                              |                                 |                              |                                 |                                  |                                    |                                  |        |  |  |  |
| Ed Charles, R (1, 5)<br>OBP: 0.350, SLG: 0.391     | 0-0 1-3   |                                 |                              | 0-0 E6                           |                              | 0-3 K                           |                              |                                 | 0-0 F8                       |                                 | 4 0 0 0 0 1 0                 |   |                              |                                 |                              |                                 |                              |                                 |                              |                                 |                                  |                                    |                                  |        |  |  |  |
| Rocky Colavito, R (1, 9)<br>OBP: 0.366, SLG: 0.513 |   | 0-3 K                           |                              | 0-0 G5-4-3                       |                              |                                 | 0-3 K                        |                                 | 4-0 BB                       |                                 | 3 0 0 0 1 2 1                 |   |                              |                                 |                              |                                 |                              |                                 |                              |                                 |                                  |                                    |                                  |        |  |  |  |
| Jim Gentile, L (1, 3)<br>OBP: 0.411, SLG: 0.563    |   | 4-0 FC5-4 BB                    |                              |                                  | 4-0 G3-6-3 BB                |                                 | 0-3 K                        |                                 | 0-0 F8                       |                                 | 2 0 0 0 2 1 1                 |   |                              |                                 |                              |                                 |                              |                                 |                              |                                 |                                  |                                    |                                  |        |  |  |  |
| Billy Bryan, L (1, 2)<br>OBP: 0.385, SLG: 0.717    |   | 4-0 FC5-4 BB                    |                              | 0-0 G3-6-3                       |                              | 0-0 4-3                         |                              | 0-0 K                           |                              |                                 | 3 0 0 0 1 1 2                 |   |                              |                                 |                              |                                 |                              |                                 |                              |                                 |                                  |                                    |                                  |        |  |  |  |
| George Alusik, R (1, 7)<br>OBP: 0.385, SLG: 0.373  |   | 0-0 FC5-4                       |                              | 0-3 K                            |                              |                                 | 0-0 G3                       |                                 | 0-0 L9                       |                                 | 3 0 0 0 0 1 2                 |   |                              |                                 |                              |                                 |                              |                                 |                              |                                 |                                  |                                    |                                  |        |  |  |  |
| Jose Tartabull, L (8, 7)<br>OBP: 0.167, SLG: 0.222 |   | 1-2 2-3 FC5-4                   |                              |                                  |                              |                                 |                              |                                 |                              | 0-0 L9                          | 1 0 0 0 0 0 0                 |   |                              |                                 |                              |                                 |                              |                                 |                              |                                 |                                  |                                    |                                  |        |  |  |  |
| Dick Green, R (1, 4)<br>OBP: 0.256, SLG: 0.335     |   | 0-3 K                           |                              | 0-3 K                            |                              | 0-3 K                           |                              | 0-0 FC6-4 1B                    |                              | 0-0 SH1-4 1B                    | 4 0 2 0 0 2 0                 |   |                              |                                 |                              |                                 |                              |                                 |                              |                                 |                                  |                                    |                                  |        |  |  |  |
| Orlando Pena, R (1, 1)<br>OBP: 0.146, SLG: 0.179   |   | 0-3 K                           |                              | 0-3 K                            |                              | 0-3 K                           |                              | 0-0 FC6-4 WP                    |                              | 0-0 SH1-4                       | 3 0 0 0 0 2 1                 |   |                              |                                 |                              |                                 |                              |                                 |                              |                                 |                                  |                                    |                                  |        |  |  |  |
| John Wyatt, R (8, 1)                               |   |                                 |                              |                                  |                              |                                 |                              |                                 |                              | 1-2                             | 0 0 0 0 0 0 0                 |   |                              |                                 |                              |                                 |                              |                                 |                              |                                 |                                  |                                    |                                  |        |  |  |  |
| <b>Inning Stats</b>                                | R: 0<br>E: 0<br>K: 1<br>S: 5                          | H: 0<br>LOB: 0<br>BB: 0<br>P: 5 | R: 0<br>E: 0<br>K: 1<br>S: 4 | H: 0<br>LOB: 1<br>BB: 2<br>P: 12 | R: 0<br>E: 0<br>K: 3<br>S: 9 | H: 0<br>LOB: 0<br>BB: 0<br>P: 9 | R: 0<br>E: 1<br>K: 0<br>S: 3 | H: 0<br>LOB: 0<br>BB: 0<br>P: 3 | R: 0<br>E: 0<br>K: 1<br>S: 4 | H: 0<br>LOB: 0<br>BB: 1<br>P: 8 | R: 2<br>E: 0<br>K: 3<br>S: 11 | H: 2<br>LOB: 0<br>BB: 0<br>P: 11  | R: 0<br>E: 0<br>K: 2<br>S: 7 | H: 0<br>LOB: 0<br>BB: 0<br>P: 7 | R: 0<br>E: 0<br>K: 0<br>S: 4 | H: 1<br>LOB: 2<br>BB: 1<br>P: 8 | R: 0<br>E: 0<br>K: 1<br>S: 5 | H: 0<br>LOB: 1<br>BB: 1<br>P: 9 | R: 0<br>E: 0<br>K: 0<br>S: 4 | H: 1<br>LOB: 1<br>BB: 0<br>P: 4 | 1B: 2<br>2B: 2<br>3B: 0<br>HR: 1 | SF: 0<br>SAC: 1<br>DP: 3<br>HBP: 0 | WP: 1<br>PB: 0<br>SB: 0<br>CS: 0 | PA: 37 |  |  |  |
| <b>PITCHER</b>                                     | IP WLS BF H R ER SO BB IBB HBP BLK WP HR S P ERA WHIP |                                 |                              |                                  |                              |                                 |                              |                                 |                              |                                 |                               |   |                              |                                 |                              |                                 |                              |                                 |                              |                                 |                                  |                                    |                                  |        |  |  |  |
| Dave Wickersham, R (1, 1)<br>ERA: 3.29             | 8.0   |                                 |                              |                                  |                              |                                 |                              |                                 |                              |                                 |                               |   |                              |                                 |                              |                                 |                              |                                 |                              |                                 |                                  |                                    |                                  |        |  |  |  |
| Terry Fox, R (9, 1)<br>ERA:                        | 2.0   | W 8                             | H 1                          | R 0                              | ER 0                         | SO 1                            | BB 1                         | IBB 0                           | HBP 0                        | BLK 0                           | WP 0                          | HR 0  | S 9                          | P 13                            | 0.00                         | 1.000                           |                              |                                 |                              |                                 |                                  |                                    |                                  |        |  |  |  |

livebaseballscorecards.com

|     |    |
|-----|----|
| AB  | 31 |
| R   | 2  |
| H   | 4  |
| RBI | 2  |
| BB  | 5  |
| SO  | 12 |
| LOB | 10 |



| Batter   | 1         | 2   | 3   | 4   | 5              | 6   | 7   | 8            | 9   | 10                | AB | R | H | RBI | BB | SO | LOB |
|--|-----------|-----|-----|-----|----------------|-----|-----|--------------|-----|-------------------|----|---|---|-----|----|----|-----|
| Jerry Lumpe, L (1, 4)<br>OBP: 0.286, SLG: 0.328  | G3        |     | F8  |     | F9             |     |     | SH1-4<br>1B  | K   |                   | 5  | 0 | 1 | 1   | 0  | 1  | 2   |
| Bill Bruton, L (1, 8)<br>OBP: 0.296, SLG: 0.351  | BB<br>BB  |     | 4-3 |     |                | 6-3 |     | SH1-4<br>1-2 |     | SH1-4<br>1B<br>BB | 2  | 1 | 0 | 0   | 2  | 0  | 0   |
| Gates Brown, L (1, 7)<br>OBP: 0.310, SLG: 0.492  | F6        |     | 3-1 |     |                | F5  |     | 3-1          |     | SH1-4<br>1-2      | 4  | 0 | 0 | 0   | 0  | 0  | 2   |
| Norm Cash, L (1, 3)<br>OBP: 0.322, SLG: 0.415  | 1-2<br>BB |     |     | L8  |                | 4-3 |     | BB<br>IBB    |     | 1B<br>BB          | 2  | 0 | 0 | 0   | 3  | 0  | 0   |
| Don Demeter, R (1, 9)<br>OBP: 0.291, SLG: 0.422  | K         |     |     | 5-3 |                |     | 5-3 | 1-2<br>BB    |     | K                 | 4  | 0 | 0 | 0   | 1  | 2  | 4   |
| Dick McAuliffe, L (1, 6)<br>OBP: 0.335, SLG: 0.480   |           | HR  |     | F9  |                |     | K   | 4-3          |     | 1-2<br>2-H<br>1B  | 5  | 1 | 2 | 2   | 0  | 1  | 3   |
| Bill Freehan, R (1, 2)<br>OBP: 0.358, SLG: 0.500   |           | L7  |     |     | G1-4-3<br>BB   |     | 1B  |              | F4  |                   | 3  | 0 | 1 | 0   | 1  | 0  | 0   |
| Don Wert, R (1, 5)<br>OBP: 0.315, SLG: 0.340   |           | 6-3 |     |     | G1-4-3<br>1-2f |     | 5-3 |              | 6-3 |                   | 4  | 0 | 0 | 0   | 0  | 0  | 2   |
| Dave Wickersham, R (1, 1)<br>OBP: 0.118, SLG: 0.147<br>Jake Wood, R (8, PH)<br>OBP: 0.189, SLG: 0.216<br>Terry Fox, R (9, 1)<br>OBP: 1.000, SLG: 1.500 |           | 4-3 |     |     |                |     |     | 1B<br>3B     | 2B  |                   | 2  | 0 | 1 | 0   | 0  | 0  | 0   |

| Inning Stats | R: 0 | H: 0 | E: 0 | K: 1 | S: 5 | P: 13 | R: 1 | H: 1 | E: 0 | K: 0 | S: 4 | P: 4 | R: 0 | H: 0 | E: 0 | K: 0 | S: 3 | P: 3 | R: 0 | H: 0 | E: 0 | K: 0 | S: 3 | P: 3 | R: 0 | H: 1 | E: 0 | K: 0 | S: 3 | P: 7 | R: 0 | H: 0 | E: 0 | K: 1 | S: 6 | P: 6 | R: 1 | H: 2 | E: 0 | K: 0 | S: 5 | P: 13 | R: 0 | H: 1 | E: 0 | K: 1 | S: 6 | P: 6 | R: 1 | H: 1 | E: 0 | K: 1 | S: 5 | P: 13 | R: 0 | H: 1 | E: 0 | K: 1 | S: 5 | P: 13 | 1B: 3 | SF: 0 | 2B: 2 | SAC: 2 | 3B: 1 | DP: 1 | HR: 1 | HBP: 0 | WP: 0 | PA: 42 |
|--------------|------|------|------|------|------|-------|------|------|------|------|------|------|------|------|------|------|------|------|------|------|------|------|------|------|------|------|------|------|------|------|------|------|------|------|------|------|------|------|------|------|------|-------|------|------|------|------|------|------|------|------|------|------|------|-------|------|------|------|------|------|-------|-------|-------|-------|--------|-------|-------|-------|--------|-------|--------|
|--------------|------|------|------|------|------|-------|------|------|------|------|------|------|------|------|------|------|------|------|------|------|------|------|------|------|------|------|------|------|------|------|------|------|------|------|------|------|------|------|------|------|------|-------|------|------|------|------|------|------|------|------|------|------|------|-------|------|------|------|------|------|-------|-------|-------|-------|--------|-------|-------|-------|--------|-------|--------|

| PITCHER                             | IP  | WLS | BF | H | R | ER | SO | BB | IBB | HBP | BLK | WP | HR | S  | P  | ERA  | WHIP  |
|-------------------------------------|-----|-----|----|---|---|----|----|----|-----|-----|-----|----|----|----|----|------|-------|
| Orlando Pena, R (1, 1)<br>ERA: 3.87 | 7.0 |     | 27 | 4 | 2 | 2  | 2  | 3  | 0   | 0   | 0   | 0  | 1  | 28 | 40 | 2.57 | 1.000 |
| John Wyatt, R (8, 1)<br>ERA: 2.36   | 2.2 | L   | 15 | 3 | 1 | 1  | 2  | 3  | 1   | 0   | 0   | 0  | 0  | 15 | 31 | 3.38 | 2.250 |

**BOTTOM**

**Kansas City Athletics @ Detroit Tigers**  
Tiger Stadium, Detroit, MI  
Wed Jun 17 1964, 7:05 PM EDT  
Att. 8,510 - Unknown

|            |           |
|------------|-----------|
| <b>AB</b>  | <b>33</b> |
| <b>R</b>   | <b>3</b>  |
| <b>H</b>   | <b>7</b>  |
| <b>RBI</b> | <b>3</b>  |
| <b>BB</b>  | <b>7</b>  |
| <b>SO</b>  | <b>4</b>  |
| <b>LOB</b> | <b>13</b> |



| Batter  | 1   | 2   | 3   | 4   | 5   | 6   | 7   | 8   | 9   | AB R H RBI BB SO LOB  | TOP   |  |
|---|---|---|---|---|---|---|---|---|---|---|---|--|
| Wayne Causey, L (1, 6)<br>OBP: 0.414, SLG: 0.420    | 0-0<br>G6-4-3<br>1B                                   |   | 0-0<br>G3   |   | 4-0<br>CS<br>BB                                     |   |   | 0-0<br>F3   |   | 3 0 1 0 1 0 0   |   |  |
| Nelson Mathews, R (1, 8)<br>OBP: 0.295, SLG: 0.343  | 0-0<br>G6-4-3<br>1-2f                                 |   |   | 0-0<br>F4   | 0-0<br>5-3  |   |   | 0-0<br>F7   |   | 4 0 0 0 0 0 2   |   |  |
| Ed Charles, R (1, 5)<br>OBP: 0.357, SLG: 0.411      | 0-3<br>K  |   |   | 0-0<br>1B<br>SF                                     |   |   | 0-0<br>G5-4-3<br>1B                                 |   | 0-0<br>HR   | 4 2 3 1 0 1 0   |   |  |
| Rocky Colavito, R (1, 9)<br>OBP: 0.373, SLG: 0.515  |   | 4-0<br>BB   |   | 0-0<br>1B<br>SF                                     |   | 0-0<br>G5-4-3<br>1-2f                               |   | 0-0<br>1B   | 0-0<br>1B   | 3 1 2 0 1 0 1   |   |  |
| Jim Gentile, L (1, 3)<br>OBP: 0.408, SLG: 0.559     |   | 0-0<br>G3-6<br>1-2f                                 |   | 0-0<br>SF<br>1B                                     |   | 0-0<br>F8   |   | 0-0<br>FC6-4<br>1B                                  | 0-0<br>FC6-4<br>1B                                  | 3 0 1 1 0 0 1   |   |  |
| Billy Bryan, L (1, 2)<br>OBP: 0.393, SLG: 0.700     |   | 0-0<br>1B   |   | 0-0<br>FC6-4<br>1B                                  |   |   | 0-3<br>K  |   | 0-3<br>K  | 4 0 2 1 0 2 1   |   |  |
| George Alusik, R (1, 7)<br>OBP: 0.381, SLG: 0.368   |   | 0-0<br>F9   |   | 0-3<br>K  |   |   | 0-0<br>G6-4-3<br>1B                                 |   | 0-0<br>FC6-4  | 4 0 1 0 0 1 4   |   |  |
| Jose Tartabull, L (9, 7)<br>OBP: 0.167, SLG: 0.222  |   |   |   |   |   |   |   |   | 0-0<br>FC6-4  | 0 0 0 0 0 0 0   | AB 31<br>R 3<br>H 11<br>RBI 3<br>BB 2<br>SO 5<br>LOB 13 |  |
| Dick Green, R (1, 4)<br>OBP: 0.257, SLG: 0.335      |   |   | 0-0<br>G6-4-3<br>1B                                 |   | 0-0<br>FC6-4  |   | 0-0<br>G6-4-3                                       |   | 0-0<br>G6-4-3                                       | 3 0 1 0 0 0 3   |   |  |
| John O'Donoghue, R (1, 1)<br>OBP: 0.273, SLG: 0.409 |   |   | 0-0<br>G6-4-3                                       |   | 0-3<br>K  |   |   | 0-0<br>4-3  |   | 2 0 0 0 0 1 1   |   |  |
| Wes Stock, R (6, 1)                                 |   |   |   |   |   |   |   |   |   | 0 0 0 0 0 0 0   |   |  |
| Rick Joseph, R (8, PH)                              |   |   |   |   |   |   |   |   |   | 1 0 0 0 0 0 0   |   |  |
| Dan Pfister, R (8, 1)                               |   |   |   |   |   |   |   |   |   | 0 0 0 0 0 0 0   |   |  |
| <b>Inning Stats</b>                                 | R: 0 H: 1<br>E: 0 LOB: 0<br>K: 1 BB: 0<br>S: 5 P: 5   | R: 0 H: 1<br>E: 0 LOB: 1<br>K: 0 BB: 1<br>S: 3 P: 7 | R: 0 H: 1<br>E: 0 LOB: 0<br>K: 0 BB: 0<br>S: 3 P: 3 | R: 2 H: 3<br>E: 1 LOB: 2<br>K: 1 BB: 0<br>S: 9 P: 9 | R: 0 H: 0<br>E: 0 LOB: 0<br>K: 1 BB: 1<br>S: 4 P: 8 | R: 0 H: 1<br>E: 0 LOB: 0<br>K: 0 BB: 0<br>S: 3 P: 3 | R: 0 H: 1<br>E: 0 LOB: 0<br>K: 1 BB: 0<br>S: 5 P: 5 | R: 0 H: 0<br>E: 0 LOB: 0<br>K: 0 BB: 0<br>S: 3 P: 3 | R: 1 H: 3<br>E: 0 LOB: 1<br>K: 1 BB: 0<br>S: 7 P: 7 | 1B: 10 SF: 1<br>2B: 0 SAC: 0<br>3B: 0 DP: 5<br>HR: 1 HBP: 0 | WP: 0 PA: 34<br>PB: 0<br>SB: 0<br>CS: 1                 |  |
| <b>PITCHER</b>                                      | IP WLS BF H R ER SO BB IBB HBP BLK WP HR S P ERA WHIP |   |   |   |   |   |   |   |   |   |   |  |
| Ed Rakow, R (1, 1)<br>ERA: 3.6                      | 8.1 L 31 10 3 2 4 2 0 0 0 0 0 1 37 45 2.16 1.440      |   |   |   |   |   |   |   |   |   |   |  |
| Fred Gladding, R (9, 1)<br>ERA: 6.94                | 0.2 3 1 0 0 1 0 0 0 0 0 0 0 5 5 0.00 1.500            |   |   |   |   |   |   |   |   |   |   |  |

**Kansas City Athletics @ Detroit Tigers**  
 Tiger Stadium, Detroit, MI  
 Thu Jun 18 1964, 4:33 AM EDT  
 Att. 4,658 - Unknown

[livebaseballscorecards.com](http://livebaseballscorecards.com)





BOTTOM

Kansas City Athletics @ Detroit Tigers  
Tiger Stadium, Detroit, MI  
Thu Jun 18 1964, 4:33 AM EDT  
Att. 4,658 - Unknown

|     |    |
|-----|----|
| AB  | 31 |
| R   | 2  |
| H   | 5  |
| RBI | 2  |
| BB  | 1  |
| SO  | 1  |
| LOB | 6  |



|     |   |     |    |
|-----|---|-----|----|
| WP: | 0 | PA: | 33 |
| PB: | 0 |     |    |
| SB: | 0 |     |    |
| CS: | 0 |     |    |

AB R H RBI BB SO LOB

|   |   |   |   |   |   |   |
|---|---|---|---|---|---|---|
| 4 | 0 | 1 | 1 | 0 | 1 | 0 |
| 3 | 0 | 0 | 0 | 0 | 0 | 1 |
| 0 | 0 | 0 | 0 | 1 | 0 | 0 |
| 4 | 0 | 0 | 0 | 0 | 0 | 2 |
| 4 | 1 | 1 | 1 | 0 | 0 | 1 |
| 4 | 0 | 0 | 0 | 0 | 0 | 0 |
| 3 | 0 | 0 | 0 | 0 | 0 | 0 |
| 1 | 0 | 0 | 0 | 0 | 0 | 0 |
| 3 | 0 | 1 | 0 | 0 | 0 | 0 |
| 3 | 1 | 2 | 0 | 0 | 0 | 1 |
| 2 | 0 | 0 | 0 | 0 | 0 | 1 |
| 0 | 0 | 0 | 0 | 0 | 0 | 0 |

| Batter  | 1               | 2              | 3                     | 4               | 5               | 6                           | 7              | 8                         | 9               |
|---|-----------------|----------------|-----------------------|-----------------|-----------------|-----------------------------|----------------|---------------------------|-----------------|
| Jerry Lumpe, L<br>OBP: 0.285, SLG: 0.330<br>(1, 4)  | 0-3<br>K<br>①   |                | 0-0<br>G3<br>③        |                 |                 | 0-0<br>L9<br>2-H<br>2B<br>② |                | 0-0<br>1-3<br>②           |                 |
| Jake Wood, R<br>OBP: 0.179, SLG: 0.204<br>Bill Bruton, L<br>OBP: 0.302, SLG: 0.351<br>(8, PH)<br>(9, 7) | 0-0<br>4-3<br>② |                |                       | 0-0<br>6-3<br>① |                 | 0-0<br>L9<br>2-3<br>②       |                | 4-0<br>FC6-4<br>BB<br>③   |                 |
| Don Demeter, R<br>OBP: 0.285, SLG: 0.413<br>(1, 8)  | 0-0<br>E5       |                |                       | 0-0<br>5-3<br>② |                 | 0-0<br>F4<br>③              |                | 0-0<br>FC6-4<br>1-2f<br>③ |                 |
| Bill Freehan, R<br>OBP: 0.355, SLG: 0.512<br>(1, 2)   | 0-0<br>L7<br>③  |                |                       | 0-0<br>F3<br>③  |                 |                             | 0-0<br>HR      |                           | 0-0<br>5-3<br>① |
| Norm Cash, L<br>OBP: 0.317, SLG: 0.407<br>(1, 3)  |                 | 0-0<br>L8<br>① |                       |                 | 0-0<br>G3<br>①  |                             | 0-0<br>L7<br>① |                           | 0-0<br>4-3<br>② |
| George Thomas, R<br>OBP: 0.359, SLG: 0.523<br>Al Kaline, R<br>OBP: 0.385, SLG: 0.451<br>(9, PH)         |                 | 0-0<br>F8<br>② |                       |                 | 0-0<br>F9<br>②  |                             | 0-0<br>F5<br>② |                           | 0-0<br>L4<br>③  |
| Dick McAuliffe, L<br>OBP: 0.335, SLG: 0.478<br>(1, 6)   |                 | 0-0<br>F8<br>③ |                       |                 | 0-0<br>4-3<br>③ |                             | 0-0<br>1B      |                           |                 |
| Bubba Phillips, R<br>OBP: 0.435, SLG: 0.381<br>(1, 5)   |                 |                | 0-0<br>G6-4-3<br>1B   |                 |                 | 0-0<br>SH1-3<br>2B<br>1B    |                | 0-0<br>F6<br>③            |                 |
| Ed Rakow, S<br>Fred Gladding, L<br>(9, 1)   |                 |                | 0-0<br>G6-4-3<br>1-2f |                 |                 | 0-0<br>SH1-3<br>1-2         |                | 0-0<br>6-3<br>①           |                 |

| Inning Stats | R: 0 | H: 0 | E: 1 | LOB: 1 | K: 1 | S: 6 | R: 0 | H: 0 | E: 0 | LOB: 0 | K: 0 | S: 3 | R: 0 | H: 1 | E: 0 | LOB: 0 | K: 0 | S: 3 | R: 0 | H: 0 | E: 0 | LOB: 0 | K: 0 | S: 3 | R: 0 | H: 0 | E: 0 | LOB: 0 | K: 0 | S: 3 | R: 1 | H: 2 | E: 0 | LOB: 1 | K: 0 | S: 5 | R: 1 | H: 2 | E: 0 | LOB: 1 | K: 0 | S: 5 | R: 0 | H: 0 | E: 0 | LOB: 1 | K: 0 | S: 3 | R: 0 | H: 0 | E: 0 | LOB: 0 | K: 0 | S: 3 | 1B: 3 | SF: 0 | 2B: 1 | SAC: 1 | 3B: 0 | DP: 1 | HR: 1 | HBP: 0 |
|--------------|------|------|------|--------|------|------|------|------|------|--------|------|------|------|------|------|--------|------|------|------|------|------|--------|------|------|------|------|------|--------|------|------|------|------|------|--------|------|------|------|------|------|--------|------|------|------|------|------|--------|------|------|------|------|------|--------|------|------|-------|-------|-------|--------|-------|-------|-------|--------|
|--------------|------|------|------|--------|------|------|------|------|------|--------|------|------|------|------|------|--------|------|------|------|------|------|--------|------|------|------|------|------|--------|------|------|------|------|------|--------|------|------|------|------|------|--------|------|------|------|------|------|--------|------|------|------|------|------|--------|------|------|-------|-------|-------|--------|-------|-------|-------|--------|

| PITCHER                                   | IP  | WLS | BF | H | R | ER | SO | BB | IBB | HBP | BLK | WP | HR | S  | P  | ERA  | WHIP  |
|---|-----|-----|----|---|---|----|----|----|-----|-----|-----|----|----|----|----|------|-------|
| John O'Donoghue, L<br>ERA: 5.26<br>(1, 1) | 5.1 |     | 19 | 3 | 1 | 1  | 1  | 0  | 0   | 0   | 0   | 0  | 0  | 21 | 21 | 1.69 | 0.562 |
| Wes Stock, R<br>ERA: 3.86<br>(6, 1)       | 1.2 |     | 7  | 2 | 1 | 1  | 0  | 0  | 0   | 0   | 0   | 0  | 1  | 7  | 7  | 5.40 | 1.200 |
| Dan Pfister, R<br>ERA: 6.32<br>(8, 1)     | 2.0 | W   | 7  | 0 | 0 | 0  | 0  | 1  | 0   | 0   | 0   | 0  | 0  | 6  | 10 | 0.00 | 0.500 |

| Batter   | 1   | 2                                | 3                            | 4                                | 5                            | 6                               | 7                            | 8                               | 9                             | AB R H RBI BB SO LOB            | TOP                          |                                 |                              |                                 |                              |                                 |                              |                                  |                                  |                                    |                                  |        |  |  |  |  |  |  |  |  |  |  |  |  |  |  |
|--|---|----------------------------------|------------------------------|----------------------------------|------------------------------|---------------------------------|------------------------------|---------------------------------|-------------------------------|---------------------------------|------------------------------|---------------------------------|------------------------------|---------------------------------|------------------------------|---------------------------------|------------------------------|----------------------------------|----------------------------------|------------------------------------|----------------------------------|--------|--|--|--|--|--|--|--|--|--|--|--|--|--|--|
| Don Blasingame, L (1, 4)<br>OBP: 0.315, SLG: 0.326 | 0-0<br>2B   | 4-0<br>BB                        |                              |                                  | 0-0<br>G2-3<br>BB<br>1B      |                                 | 0-0<br>F7                    |                                 | 0-0<br>F5                     | 4 2 2 0 1 0 2                   |                              |                                 |                              |                                 |                              |                                 |                              |                                  |                                  |                                    |                                  |        |  |  |  |  |  |  |  |  |  |  |  |  |  |  |
| John Kennedy, R (1, 5)<br>OBP: 0.335, SLG: 0.448   | 0-3<br>K  | 0-0<br>F8                        |                              |                                  | 0-0<br>F3                    |                                 | 0-0<br>1B                    |                                 | 0-0<br>E7<br>1-3<br>3-H<br>1B | 5 0 2 1 0 1 4                   |                              |                                 |                              |                                 |                              |                                 |                              |                                  |                                  |                                    |                                  |        |  |  |  |  |  |  |  |  |  |  |  |  |  |  |
| Chuck Hinton, R (1, 7)<br>OBP: 0.385, SLG: 0.506   | 0-0<br>1B<br>2B<br>2-H                                |                                  |                              |                                  | 4-0<br>G2-3<br>1-2<br>BB     |                                 | 0-3<br>K                     |                                 | 4-0<br>BB                     | 3 1 1 1 2 2 1                   |                              |                                 |                              |                                 |                              |                                 |                              |                                  |                                  |                                    |                                  |        |  |  |  |  |  |  |  |  |  |  |  |  |  |  |
| Jim King, L (1, 9)<br>OBP: 0.347, SLG: 0.474       | 4-0<br>1B<br>FC8-2<br>BB                              |                                  |                              |                                  | 0-0<br>G2-3                  |                                 | 0-0<br>P5                    |                                 | 0-0<br>P6                     | 3 0 0 1 2 0 5                   |                              |                                 |                              |                                 |                              |                                 |                              |                                  |                                  |                                    |                                  |        |  |  |  |  |  |  |  |  |  |  |  |  |  |  |
| Dick Phillips, L (1, 3)<br>OBP: 0.308, SLG: 0.313  | 0-0<br>1-3<br>2-H<br>1B                               |                                  |                              |                                  | 0-0<br>4-3<br>BB             |                                 | 0-0<br>P4                    |                                 | 0-3<br>K                      | 5 0 1 1 0 1 5                   |                              |                                 |                              |                                 |                              |                                 |                              |                                  |                                  |                                    |                                  |        |  |  |  |  |  |  |  |  |  |  |  |  |  |  |
| Mike Brumley, L (1, 2)<br>OBP: 0.333, SLG: 0.305   | 0-0<br>FC8-2  |                                  |                              |                                  | 0-0<br>4-3                   |                                 | 0-0<br>1B<br>2B              |                                 | 0-3<br>K                      | 4 0 1 0 0 1 3                   |                              |                                 |                              |                                 |                              |                                 |                              |                                  |                                  |                                    |                                  |        |  |  |  |  |  |  |  |  |  |  |  |  |  |  |
| Don Lock, R (1, 8)<br>OBP: 0.364, SLG: 0.414       |   |                                  |                              |                                  | 0-0<br>1-3                   |                                 | 0-0<br>P4                    |                                 | 0-3<br>K                      | 4 0 0 0 0 2 1                   |                              |                                 |                              |                                 |                              |                                 |                              |                                  |                                  |                                    |                                  |        |  |  |  |  |  |  |  |  |  |  |  |  |  |  |
| Ed Brinkman, R (1, 6)<br>OBP: 0.296, SLG: 0.388    |   |                                  |                              |                                  | 0-0<br>L6                    |                                 | 0-0<br>P6                    |                                 | 0-0<br>1B<br>E<br>2B          | 4 1 2 0 0 0 1                   |                              |                                 |                              |                                 |                              |                                 |                              |                                  |                                  |                                    |                                  |        |  |  |  |  |  |  |  |  |  |  |  |  |  |  |
| Bennie Daniels, L (1, 1)<br>OBP: 0.200, SLG: 0.261 |   |                                  |                              |                                  | 0-0<br>SH1-3                 |                                 | 0-0<br>1B                    |                                 | 0-0<br>E<br>2B                | 2 0 1 0 0 1 0                   |                              |                                 |                              |                                 |                              |                                 |                              |                                  |                                  |                                    |                                  |        |  |  |  |  |  |  |  |  |  |  |  |  |  |  |
| Steve Ridzik, R (6, 1)<br>OBP: 0.375, SLG: 0.286   |   |                                  |                              |                                  | 0-3<br>K                     |                                 | 0-0<br>1B                    |                                 | 0-0<br>E<br>1B                | 0 0 0 0 0 0 0                   |                              |                                 |                              |                                 |                              |                                 |                              |                                  |                                  |                                    |                                  |        |  |  |  |  |  |  |  |  |  |  |  |  |  |  |
| Don Zimmer, R (9, PH)<br>OBP: 0.291, SLG: 0.438    |   |                                  |                              |                                  |                              |                                 |                              |                                 |                               | 1 0 1 0 0 0 0                   |                              |                                 |                              |                                 |                              |                                 |                              |                                  |                                  |                                    |                                  |        |  |  |  |  |  |  |  |  |  |  |  |  |  |  |
| Chuck Cottier, R (9, PR)<br>OBP: 0.296, SLG: 0.424 |   |                                  |                              |                                  |                              |                                 |                              |                                 |                               | 0 0 0 0 0 0 0                   |                              |                                 |                              |                                 |                              |                                 |                              |                                  |                                  |                                    |                                  |        |  |  |  |  |  |  |  |  |  |  |  |  |  |  |
| <b>Inning Stats</b>                                | R: 2<br>E: 0<br>K: 1<br>S: 7                          | H: 3<br>LOB: 1<br>BB: 1<br>P: 11 | R: 0<br>E: 0<br>K: 1<br>S: 6 | H: 1<br>LOB: 2<br>BB: 1<br>P: 10 | R: 0<br>E: 0<br>K: 1<br>S: 5 | H: 0<br>LOB: 1<br>BB: 1<br>P: 9 | R: 0<br>E: 0<br>K: 1<br>S: 5 | H: 0<br>LOB: 0<br>BB: 0<br>P: 5 | R: 1<br>E: 0<br>K: 0<br>S: 4  | H: 1<br>LOB: 1<br>BB: 1<br>P: 8 | R: 0<br>E: 0<br>K: 0<br>S: 4 | H: 2<br>LOB: 2<br>BB: 0<br>P: 4 | R: 0<br>E: 0<br>K: 1<br>S: 6 | H: 1<br>LOB: 1<br>BB: 0<br>P: 6 | R: 0<br>E: 0<br>K: 3<br>S: 9 | H: 0<br>LOB: 0<br>BB: 0<br>P: 9 | R: 1<br>E: 1<br>K: 0<br>S: 6 | H: 3<br>LOB: 3<br>BB: 1<br>P: 10 | 1B: 7<br>2B: 5<br>3B: 0<br>HR: 0 | SF: 0<br>SAC: 1<br>DP: 1<br>HBP: 0 | WP: 0<br>PB: 0<br>SB: 0<br>CS: 0 | PA: 41 |  |  |  |  |  |  |  |  |  |  |  |  |  |  |
| <b>PITCHER</b>                                     | IP WLS BF H R ER SO BB IBB HBP BLK WP HR S P ERA WHIP |                                  |                              |                                  |                              |                                 |                              |                                 |                               |                                 |                              |                                 |                              |                                 |                              |                                 |                              |                                  |                                  |                                    |                                  |        |  |  |  |  |  |  |  |  |  |  |  |  |  |  |
| Moe Drabowsky, R (1, 1)<br>ERA: 6.31               | 1.2   |                                  | 10                           | 4                                | 2                            | 2                               | 2                            | 2                               | 0                             | 0                               | 0                            | 0                               | 0                            | 12                              | 20                           | 10.80                           | 3.600                        |                                  |                                  |                                    |                                  |        |  |  |  |  |  |  |  |  |  |  |  |  |  |  |
| Jose Santiago, R (2, 1)<br>ERA: 2.79               | 3.1   |                                  | 13                           | 1                                | 1                            | 1                               | 2                            | 2                               | 0                             | 0                               | 0                            | 0                               | 0                            | 15                              | 23                           | 2.70                            | 0.900                        |                                  |                                  |                                    |                                  |        |  |  |  |  |  |  |  |  |  |  |  |  |  |  |
| Wes Stock, R (6, 1)<br>ERA: 3.76                   | 3.0   | W                                | 12                           | 4                                | 1                            | 1                               | 4                            | 0                               | 0                             | 0                               | 0                            | 0                               | 0                            | 20                              | 20                           | 3.00                            | 1.333                        |                                  |                                  |                                    |                                  |        |  |  |  |  |  |  |  |  |  |  |  |  |  |  |
| John Wyatt, R (9, 1)<br>ERA: 2.3                   | 1.0   | S                                | 6                            | 2                                | 0                            | 0                               | 0                            | 1                               | 0                             | 0                               | 0                            | 0                               | 0                            | 5                               | 9                            | 0.00                            | 3.000                        |                                  |                                  |                                    |                                  |        |  |  |  |  |  |  |  |  |  |  |  |  |  |  |

Washington Senators @ Kansas City Athletics  
Municipal Stadium, Kansas City, MO  
Fri Jun 19 1964, 8:05 PM EDT  
Att. 7,975 - Unknown

|     |    |
|-----|----|
| AB  | 35 |
| R   | 4  |
| H   | 11 |
| RBI | 4  |
| BB  | 5  |
| SO  | 8  |
| LOB | 22 |



|    |   |    |    |
|----|---|----|----|
| WP | 0 | PA | 41 |
| PB | 0 |    |    |
| SB | 0 |    |    |
| CS | 0 |    |    |

livebaseballscorecards.com

| Batter  | 1       | 2          | 3       | 4                 | 5       | 6                  | 7               | 8 | 9 |
|---|---------|------------|---------|-------------------|---------|--------------------|-----------------|---|---|
| Wayne Causey, L (1, 6)<br>OBP: 0.408, SLG: 0.413    | 0-0 4-3 |            | 0-0 4-3 |                   | 0-0 6-3 |                    | 0-0 1-3         |   |   |
| Dick Green, R (1, 4)<br>OBP: 0.257, SLG: 0.333      | 0-3 K   |            | 0-0 F8  |                   |         | 0-0 SH2-4 HR 1B    | 0-3 K           |   |   |
| Ed Charles, R (1, 5)<br>OBP: 0.352, SLG: 0.405      | 0-0 P6  |            | 0-0 5-3 |                   |         | 0-0 SH2-4 1-2      | 0-0 F7          |   |   |
| Rocky Colavito, R (1, 9)<br>OBP: 0.375, SLG: 0.529  |         | 0-0 P4     |         | 0-0 BB 1B         |         | 0-0 HR 2-H         | 0-0 F8          |   |   |
| Jim Gentile, L (1, 3)<br>OBP: 0.419, SLG: 0.562     |         | 4-0 HR BB  |         | 4-0 G4-6-3 BB 1-2 |         | 4-0 HBP 1B BB      | 0-0 G4-6-3 1B   |   |   |
| Billy Bryan, L (1, 2)<br>OBP: 0.383, SLG: 0.722     |         | 0-0 HR 1-H |         | 0-0 F9            |         | 0-0 F5             | 0-0 G4-6-3 1-2f |   |   |
| Manny Jimenez, L (1, 7)<br>OBP: 0.268, SLG: 0.492   |         | 0-0 3-1    |         | 0-0 G4-6-3 1-2f   |         | 0-0 1B HBP 1-2 1B  |                 |   |   |
| Jose Tartabull, L (6, PR)<br>OBP: 0.167, SLG: 0.222 |         |            |         |                   |         |                    |                 |   |   |
| Nelson Mathews, R (1, 8)<br>OBP: 0.300, SLG: 0.349  |         | 0-0 2B     |         |                   | 0-0 F8  | 1-0 1B 1-2 2-3 HBP |                 |   |   |
| Moe Drabowsky, R (1, 1)<br>OBP: 0.045, SLG: 0.045   |         | 0-0 4-3    |         |                   | 0-0 P3  | 0-0 1B 1-3 2-3 3-H |                 |   |   |
| Jose Santiago, R (2, 1)                             |         |            |         |                   |         |                    |                 |   |   |
| Rick Joseph, R (5, PH)                              |         |            |         |                   |         |                    |                 |   |   |
| Wes Stock, R (6, 1)<br>OBP: 0.200, SLG: 0.200       |         |            |         |                   |         |                    |                 |   |   |
| John Wyatt, R (9, 1)                                |         |            |         |                   |         |                    |                 |   |   |

| AB    | R      | H     | RBI    | BB    | SO    | LOB   |
|-------|--------|-------|--------|-------|-------|-------|
| 4     | 0      | 0     | 0      | 0     | 0     | 0     |
| 4     | 1      | 1     | 0      | 0     | 2     | 0     |
| 3     | 0      | 0     | 0      | 0     | 0     | 0     |
| 4     | 1      | 2     | 2      | 0     | 0     | 0     |
| 1     | 2      | 1     | 0      | 3     | 0     | 0     |
| 4     | 1      | 1     | 2      | 0     | 0     | 4     |
| 3     | 0      | 1     | 0      | 0     | 0     | 2     |
| 0     | 0      | 0     | 0      | 0     | 0     | 0     |
| 2     | 0      | 1     | 0      | 0     | 0     | 0     |
| 0     | 0      | 0     | 0      | 0     | 0     | 0     |
| 1     | 0      | 0     | 0      | 0     | 0     | 1     |
| 1     | 0      | 0     | 0      | 0     | 0     | 0     |
| 1     | 0      | 1     | 1      | 0     | 0     | 0     |
| 0     | 0      | 0     | 0      | 0     | 0     | 0     |
| 1B: 5 | SF: 0  | 2B: 1 | SAC: 1 | 3B: 0 | DP: 2 | HR: 2 |
|       | HBP: 1 |       |        |       |       |       |

**BOTTOM**

Washington Senators @ Kansas City Athletics  
Municipal Stadium, Kansas City, MO  
Fri Jun 19 1964, 8:05 PM EDT  
Att. 7,975 - Unknown

livebaseballscorecards.com

|     |    |
|-----|----|
| AB  | 28 |
| R   | 5  |
| H   | 8  |
| RBI | 5  |
| BB  | 3  |
| SO  | 2  |
| LOB | 7  |



| Inning Stats | R | H | E | K | S | IP  | WLS | BF | H | R | ER | SO | BB | IBB | HBP | BLK | WP | HR | S  | P  | ERA  | WHIP  |
|--------------|---|---|---|---|---|-----|-----|----|---|---|----|----|----|-----|-----|-----|----|----|----|----|------|-------|
|              | 0 | 0 | 0 | 1 | 5 | 5.1 | L   | 23 | 5 | 5 | 5  | 1  | 3  | 0   | 0   | 0   | 0  | 2  | 22 | 34 | 8.44 | 1.500 |
|              | 2 | 2 | 0 | 0 | 5 | 2.2 |     | 10 | 3 | 0 | 0  | 1  | 0  | 0   | 1   | 0   | 0  | 0  | 11 | 12 | 0.00 | 1.125 |

| PITCHER                               | IP  | WLS | BF | H | R | ER | SO | BB | IBB | HBP | BLK | WP | HR | S  | P  | ERA  | WHIP  |
|---------------------------------------|-----|-----|----|---|---|----|----|----|-----|-----|-----|----|----|----|----|------|-------|
| Bennie Daniels, R (1, 1)<br>ERA: 4.54 | 5.1 | L   | 23 | 5 | 5 | 5  | 1  | 3  | 0   | 0   | 0   | 0  | 2  | 22 | 34 | 8.44 | 1.500 |
| Steve Ridzik, R (6, 1)<br>ERA: 2.66   | 2.2 |     | 10 | 3 | 0 | 0  | 1  | 0  | 0   | 1   | 0   | 0  | 0  | 11 | 12 | 0.00 | 1.125 |

| WP | PA | ERA | WHIP |
|----|----|-----|------|
| 0  | 33 |     |      |
| 0  |    |     |      |
| 0  |    |     |      |

| Batter   | 1                            | 2                               | 3                            | 4                               | 5                            | 6                                | 7                            | 8                               | 9                            | AB R H RBI BB SO LOB            | TOP                          |                                 |                              |                                 |                              |                                 |                              |                                 |                                  |                                    |                                  |        |    |    |   |   |     |      |  |  |  |
|--|------------------------------|---------------------------------|------------------------------|---------------------------------|------------------------------|----------------------------------|------------------------------|---------------------------------|------------------------------|---------------------------------|------------------------------|---------------------------------|------------------------------|---------------------------------|------------------------------|---------------------------------|------------------------------|---------------------------------|----------------------------------|------------------------------------|----------------------------------|--------|----|----|---|---|-----|------|--|--|--|
| Don Blasingame, L (1, 4)<br>OBP: 0.314, SLG: 0.321   | 0-0<br>1-3                   |                                 | 4-0<br>G6-4-3<br>BB          |                                 | 0-0<br>P6                    |                                  |                              | 0-0<br>4-3                      |                              | 3 0 0 0 1 0 0                   |                              |                                 |                              |                                 |                              |                                 |                              |                                 |                                  |                                    |                                  |        |    |    |   |   |     |      |  |  |  |
| John Kennedy, R (1, 5)<br>OBP: 0.329, SLG: 0.440     | 0-3<br>K                     |                                 | 0-0<br>G6-4-3                |                                 |                              | 0-0<br>F7                        |                              | 0-0<br>F2                       |                              | 4 0 0 0 0 1 3                   |                              |                                 |                              |                                 |                              |                                 |                              |                                 |                                  |                                    |                                  |        |    |    |   |   |     |      |  |  |  |
| Steve Ridzik, R (8, 1)<br>OBP: 0.375, SLG: 0.286     |                              |                                 |                              |                                 |                              |                                  |                              |                                 |                              | 0 0 0 0 0 0 0                   |                              |                                 |                              |                                 |                              |                                 |                              |                                 |                                  |                                    |                                  |        |    |    |   |   |     |      |  |  |  |
| Chuck Hinton, R (1, 7)<br>OBP: 0.383, SLG: 0.502     | 0-0<br>F8                    |                                 |                              |                                 |                              |                                  |                              |                                 |                              | 2 0 0 0 0 1 0                   |                              |                                 |                              |                                 |                              |                                 |                              |                                 |                                  |                                    |                                  |        |    |    |   |   |     |      |  |  |  |
| Fred Valentine, S (4, 7)<br>OBP: 0.295, SLG: 0.337   |                              |                                 |                              |                                 |                              |                                  |                              |                                 |                              | 2 0 1 0 0 0 0                   |                              |                                 |                              |                                 |                              |                                 |                              |                                 |                                  |                                    |                                  |        |    |    |   |   |     |      |  |  |  |
| Jim King, L (1, 9)<br>OBP: 0.350, SLG: 0.472         |                              | 4-0<br>G4-6-3<br>BB             |                              | 0-0<br>K                        |                              | 0-0<br>K                         |                              | 0-0<br>1-3<br>1B                |                              | 3 1 1 0 1 1 1                   |                              |                                 |                              |                                 |                              |                                 |                              |                                 |                                  |                                    |                                  |        |    |    |   |   |     |      |  |  |  |
| Bill Skowron, R (1, 3)<br>OBP: 0.299, SLG: 0.465     |                              | 0-0<br>F9                       |                              | 0-0<br>HR                       |                              | 0-3<br>K                         |                              | 0-0<br>F7                       |                              | 4 1 1 2 0 1 2                   |                              |                                 |                              |                                 |                              |                                 |                              |                                 |                                  |                                    |                                  |        |    |    |   |   |     |      |  |  |  |
| Mike Brumley, L (1, 2)<br>OBP: 0.326, SLG: 0.297     |                              | 0-0<br>G4-6-3                   |                              | 0-0<br>F8                       |                              | 0-0<br>4-3                       |                              | 0-3<br>K                        |                              | 4 0 0 0 0 1 2                   |                              |                                 |                              |                                 |                              |                                 |                              |                                 |                                  |                                    |                                  |        |    |    |   |   |     |      |  |  |  |
| Don Lock, R (1, 8)<br>OBP: 0.368, SLG: 0.412         |                              |                                 | 4-0<br>BB<br>5-3<br>BB       |                                 | 0-0<br>P4                    |                                  | 4-0<br>E<br>BB               |                                 |                              | 1 0 0 0 2 0 0                   |                              |                                 |                              |                                 |                              |                                 |                              |                                 |                                  |                                    |                                  |        |    |    |   |   |     |      |  |  |  |
| Ed Brinkman, R (1, 6)<br>OBP: 0.291, SLG: 0.382      |                              |                                 | 0-0<br>5-3                   |                                 | 0-0<br>F7                    |                                  | 0-0<br>F9                    |                                 |                              | 3 0 0 0 0 0 2                   |                              |                                 |                              |                                 |                              |                                 |                              |                                 |                                  |                                    |                                  |        |    |    |   |   |     |      |  |  |  |
| Jim Hannan, R (1, 1)<br>OBP: 0.300, SLG: 0.333       |                              |                                 | 4-0<br>BB<br>BB              |                                 | 0-0<br>4-1                   |                                  | 0-3<br>K                     |                                 |                              | 0 0 0 0 0 0 0                   |                              |                                 |                              |                                 |                              |                                 |                              |                                 |                                  |                                    |                                  |        |    |    |   |   |     |      |  |  |  |
| Marshall Bridges, S (1, 1)<br>OBP: 0.304, SLG: 0.309 |                              |                                 |                              |                                 |                              |                                  |                              |                                 |                              | 0 0 0 0 0 1 0 0                 |                              |                                 |                              |                                 |                              |                                 |                              |                                 |                                  |                                    |                                  |        |    |    |   |   |     |      |  |  |  |
| Dick Phillips, L (5, PH)<br>OBP: 0.286, SLG: 0.167   |                              |                                 |                              |                                 |                              |                                  |                              |                                 |                              | 1 0 0 0 0 0 0 0                 |                              |                                 |                              |                                 |                              |                                 |                              |                                 |                                  |                                    |                                  |        |    |    |   |   |     |      |  |  |  |
| Jim Duckworth, R (5, 1)<br>OBP: 0.286, SLG: 0.167    |                              |                                 |                              |                                 |                              |                                  |                              |                                 |                              | 0 0 0 0 0 0 0 0                 |                              |                                 |                              |                                 |                              |                                 |                              |                                 |                                  |                                    |                                  |        |    |    |   |   |     |      |  |  |  |
| Don Zimmer, R (8, PH)<br>OBP: 0.289, SLG: 0.435      |                              |                                 |                              |                                 |                              |                                  |                              |                                 |                              | 1 0 0 0 0 1 0 0                 |                              |                                 |                              |                                 |                              |                                 |                              |                                 |                                  |                                    |                                  |        |    |    |   |   |     |      |  |  |  |
|  |                              |                                 |                              |                                 |                              |                                  |                              |                                 |                              |                                 |                              |                                 |                              |                                 |                              |                                 |                              |                                 |                                  |                                    |                                  |        |    |    |   |   |     |      |  |  |  |
| <b>Inning Stats</b>                                  | R: 0<br>E: 0<br>K: 1<br>S: 5 | H: 0<br>LOB: 0<br>BB: 0<br>P: 5 | R: 0<br>E: 0<br>K: 0<br>S: 2 | H: 0<br>LOB: 0<br>BB: 1<br>P: 6 | R: 0<br>E: 0<br>K: 0<br>S: 2 | H: 0<br>LOB: 2<br>BB: 3<br>P: 14 | R: 2<br>E: 0<br>K: 1<br>S: 7 | H: 2<br>LOB: 0<br>BB: 0<br>P: 7 | R: 0<br>E: 0<br>K: 0<br>S: 3 | H: 0<br>LOB: 0<br>BB: 0<br>P: 3 | R: 0<br>E: 0<br>K: 1<br>S: 5 | H: 0<br>LOB: 0<br>BB: 0<br>P: 5 | R: 0<br>E: 1<br>K: 1<br>S: 5 | H: 0<br>LOB: 1<br>BB: 1<br>P: 9 | R: 0<br>E: 0<br>K: 1<br>S: 5 | H: 0<br>LOB: 0<br>BB: 0<br>P: 5 | R: 0<br>E: 0<br>K: 1<br>S: 6 | H: 1<br>LOB: 1<br>BB: 0<br>P: 6 | 1B: 2<br>2B: 0<br>3B: 0<br>HR: 1 | SF: 0<br>SAC: 0<br>DP: 2<br>HBP: 0 | WP: 0<br>PB: 0<br>SB: 0<br>CS: 0 | PA: 33 |    |    |   |   |     |      |  |  |  |
| <b>PITCHER</b><br>Diego Segui, R (1, 1)<br>ERA: 4.15 | IP<br>9.0                    | WLS<br>W                        | BF<br>33                     | H<br>3                          | R<br>2                       | ER<br>2                          | SO<br>6                      | BB<br>5                         | IBB<br>0                     | HBP<br>0                        | BLK<br>0                     | WP<br>0                         | HR<br>1                      | S<br>40                         | P<br>60                      | ERA<br>2.00                     | WHIP<br>0.889                |                                 |                                  |                                    |                                  |        |    |    |   |   |     |      |  |  |  |
|  |                              |                                 |                              |                                 |                              |                                  |                              |                                 |                              |                                 | <b>PITCHER</b>               | IP                              | WLS                          | BF                              | H                            | R                               | ER                           | SO                              | BB                               | IBB                                | HBP                              | BLK    | WP | HR | S | P | ERA | WHIP |  |  |  |

Washington Senators @ Kansas City Athletics  
Municipal Stadium, Kansas City, MO  
Sat Jun 20 1964, 8:05 PM EDT  
Att. 25,182 - Unknown

|     |    |
|-----|----|
| AB  | 28 |
| R   | 2  |
| H   | 3  |
| RBI | 2  |
| BB  | 5  |
| SO  | 6  |
| LOB | 10 |



| Batter   | 1  | 2          | 3                                    | 4 | 5          | 6         | 7                      | 8        | 9 | AB | R | H | RBI | BB | SO | LOB |
|--|--|------------|--------------------------------------|---|------------|-----------|------------------------|----------|---|----|---|---|-----|----|----|-----|
| Wayne Causey, L (1, 6)<br>OBP: 0.406, SLG: 0.415   | 0-0<br>1B<br>FC5-4<br>2B                       | 0-0<br>F8  | 0-3<br>K                             |   |            | 0-0<br>F8 |                        |          |   | 4  | 1 | 1 | 0   | 0  | 1  | 2   |
| Dick Green, R (1, 4)<br>OBP: 0.257, SLG: 0.332     | 0-0<br>FC5-4<br>2-3<br>1B                      | 0-3<br>K   |                                      |   | 0-0<br>F9  | 0-3<br>K  |                        |          |   | 4  | 0 | 1 | 0   | 0  | 2  | 0   |
| Ed Charles, R (1, 5)<br>OBP: 0.355, SLG: 0.409     | 0-0<br>FC5-4<br>BB<br>1B<br>SF9<br>1-2f<br>3-H | 0-0<br>6-3 |                                      |   | 0-0<br>2B  |           | 4-0<br>G3<br>5-3<br>BB |          |   | 3  | 1 | 1 | 1   | 1  | 0  | 1   |
| Rocky Colavito, R (1, 9)<br>OBP: 0.377, SLG: 0.533 | 0-0<br>SF9<br>BB<br>HR<br>1-2<br>1B            |            | 0-0<br>E<br>BLK<br>2B                |   | 0-0<br>F7  |           | 0-0<br>5-3<br>1-2      |          |   | 4  | 2 | 2 | 0   | 0  | 0  | 2   |
| Jim Gentile, L (1, 3)<br>OBP: 0.421, SLG: 0.555    | 4-0<br>SF9<br>HR<br>BB<br>1-2<br>2-3           |            | 4-0<br>BLK<br>E<br>1B<br>BB          |   | 0-3<br>K   |           | 0-0<br>G3<br>2-3       |          |   | 2  | 2 | 0 | 0   | 2  | 1  | 2   |
| Billy Bryan, L (1, 2)<br>OBP: 0.365, SLG: 0.696    | 0-0<br>SF9                                     |            | 0-0<br>E4<br>1B<br>BLK<br>1-2<br>2-3 |   | 0-0<br>F5  |           | 0-3<br>K               |          |   | 2  | 0 | 0 | 1   | 0  | 0  | 2   |
| Doc Edwards, R (6, 2)<br>OBP: 0.245, SLG: 0.262    |  |            |                                      |   |            |           |                        |          |   | 1  | 0 | 0 | 0   | 0  | 1  | 1   |
| Manny Jimenez, L (1, 7)<br>OBP: 0.270, SLG: 0.478  | 4-0<br>HR<br>BB                                |            | 0-0<br>P6<br>1-2<br>2-3<br>3-H       |   | 0-0<br>6-3 |           | 0-0<br>4-3             |          |   | 2  | 1 | 0 | 0   | 1  | 0  | 2   |
| Jose Tartabull, L (8, 7)<br>OBP: 0.158, SLG: 0.211 |  |            |                                      |   |            |           |                        |          |   | 1  | 0 | 0 | 0   | 0  | 0  | 0   |
| Nelson Mathews, R (1, 8)<br>OBP: 0.303, SLG: 0.361 | 0-0<br>1-H<br>2-H<br>3-H<br>HR                 |            | 4-0<br>1B<br>IBB                     |   | 0-0<br>F5  |           | 0-3<br>K               |          |   | 3  | 1 | 1 | 4   | 1  | 1  | 0   |
| Diego Segui, R (1, 1)<br>OBP: 0.243, SLG: 0.314    | 0-3<br>K                                       |            | 0-0<br>1-2<br>2-3<br>3-H<br>1B       |   |            | 0-3<br>K  |                        | 0-3<br>K |   | 4  | 0 | 1 | 1   | 0  | 3  | 0   |

| Inning Stats | R: 6  | H: 4  | LOB: 0 | BB: 2 | P: 17 | R: 0  | H: 0   | LOB: 0 | BB: 0  | P: 5  | R: 2  | H: 2  | LOB: 2 | BB: 2 | P: 15 | R: 0 | H: 1 | LOB: 1 | BB: 0 | P: 6 | R: 0 | H: 0 | LOB: 0 | BB: 0 | P: 3 | R: 0 | H: 0 | LOB: 0 | BB: 0 | P: 7 | R: 0 | H: 0 | LOB: 1 | BB: 1 | P: 9 | R: 0 | H: 0 | LOB: 0 | BB: 0 | P: 7 | R: 0 | H: 0 | LOB: 0 | BB: 0 | P: 7 |
|--------------|-------|-------|--------|-------|-------|-------|--------|--------|--------|-------|-------|-------|--------|-------|-------|------|------|--------|-------|------|------|------|--------|-------|------|------|------|--------|-------|------|------|------|--------|-------|------|------|------|--------|-------|------|------|------|--------|-------|------|
| 1B: 3        | SF: 1 | 2B: 3 | SAC: 0 | 3B: 0 | DP: 0 | HR: 1 | HBP: 0 | WP: 0  | PA: 36 | PB: 0 | SB: 0 | CS: 0 |        |       |       |      |      |        |       |      |      |      |        |       |      |      |      |        |       |      |      |      |        |       |      |      |      |        |       |      |      |      |        |       |      |

| PITCHER                                | IP  | WLS | BF | H | R | ER | SO | BB | IBB | HBP | BLK | WP | HR | S  | P  | ERA    | WHIP   |
|--|-----|-----|----|---|---|----|----|----|-----|-----|-----|----|----|----|----|--------|--------|
| Jim Hannan, R (1, 1)<br>ERA: 4.2       | 0.1 | L   | 5  | 3 | 4 | 4  | 0  | 1  | 0   | 0   | 0   | 0  | 0  | 4  | 8  | 108.00 | 12.000 |
| Marshall Bridges, L (1, 1)<br>ERA: 5.7 | 3.2 |     | 18 | 4 | 4 | 4  | 4  | 2  | 1   | 0   | 1   | 0  | 1  | 23 | 35 | 9.82   | 1.636  |
| Jim Duckworth, R (5, 1)<br>ERA: 3.41   | 3.0 |     | 10 | 0 | 0 | 0  | 3  | 1  | 0   | 0   | 0   | 0  | 0  | 15 | 19 | 0.00   | 0.333  |
| Steve Ritzik, R (8, 1)<br>ERA: 2.59    | 1.0 |     | 3  | 0 | 0 | 0  | 2  | 0  | 0   | 0   | 0   | 0  | 0  | 7  | 7  | 0.00   | 0.000  |

**BOTTOM**

Washington Senators @ Kansas City Athletics  
Municipal Stadium, Kansas City, MO  
Sat Jun 20 1964, 8:05 PM EDT  
Att. 25,182 - Unknown

livebaseballscorecards.com

|            |           |
|------------|-----------|
| <b>AB</b>  | <b>30</b> |
| <b>R</b>   | <b>8</b>  |
| <b>H</b>   | <b>7</b>  |
| <b>RBI</b> | <b>7</b>  |
| <b>BB</b>  | <b>5</b>  |
| <b>SO</b>  | <b>9</b>  |
| <b>LOB</b> | <b>12</b> |



| Batter   | 1   | 2                                | 3                            | 4                               | 5                            | 6                               | 7                            | 8                                | 9                            | AB R H RBI BB SO LOB            | TOP   |                                 |                              |                                 |                              |                                  |                              |                                  |                                  |                                    |                                  |        |
|--|---|----------------------------------|------------------------------|---------------------------------|------------------------------|---------------------------------|------------------------------|----------------------------------|------------------------------|---------------------------------|---|---------------------------------|------------------------------|---------------------------------|------------------------------|----------------------------------|------------------------------|----------------------------------|----------------------------------|------------------------------------|----------------------------------|--------|
| Don Blasingame, L (1, 4)<br>OBP: 0.319, SLG: 0.328 | 0-0<br>4-3  | 0-0<br>F5                        |                              | 4-0<br>S<br>2B<br>BB            |                              | 0-3<br>K                        |                              | 0-0<br>S<br>E<br>2B              | 0-0<br>BB<br>WP<br>1B        | 5 3 2 0 1 1 1                   |   |                                 |                              |                                 |                              |                                  |                              |                                  |                                  |                                    |                                  |        |
| Chuck Hinton, R (1, 7)<br>OBP: 0.387, SLG: 0.508   | 0-3<br>K  |                                  | 0-0<br>2B<br>1B              | 0-0<br>1B<br>2B                 |                              | 0-0<br>1B<br>1B                 |                              | 0-0<br>6-3                       | 0-0<br>P3                    | 5 2 3 1 0 1 1<br>1 0 0 0 0 0 1  |   |                                 |                              |                                 |                              |                                  |                              |                                  |                                  |                                    |                                  |        |
| Ken Hunt, R (8, 7)<br>OBP: 0.243, SLG: 0.234       |   |                                  |                              |                                 |                              |                                 |                              |                                  |                              |                                 |   |                                 |                              |                                 |                              |                                  |                              |                                  |                                  |                                    |                                  |        |
| Jim King, L (1, 9)<br>OBP: 0.365, SLG: 0.494       | 0-0<br>BB<br>BB<br>1B                                 |                                  | 0-0<br>1B<br>2B              | 0-0<br>2B                       |                              | 0-0<br>1B<br>1B                 |                              | 1-0<br>S<br>S<br>HBP             | 4-0<br>WP<br>BB<br>BB        | 4 3 4 2 0 0 0<br>0 0 0 0 1 0 0  |   |                                 |                              |                                 |                              |                                  |                              |                                  |                                  |                                    |                                  |        |
| Fred Valentine, S (8, 9)<br>OBP: 0.302, SLG: 0.337 |   |                                  |                              |                                 |                              |                                 |                              |                                  |                              |                                 |   |                                 |                              |                                 |                              |                                  |                              |                                  |                                  |                                    |                                  |        |
| Bill Skowron, R (1, 3)<br>OBP: 0.306, SLG: 0.465   | 4-0<br>BLK<br>BB<br>1-2                               |                                  | 0-0<br>HR<br>1B              | 0-3<br>K                        |                              | 0-0<br>1-3                      |                              | 0-0<br>HR<br>1B                  | 4-0<br>WP<br>BB              | 4 1 2 1 1 1 3<br>0 1 0 0 1 0 0  |   |                                 |                              |                                 |                              |                                  |                              |                                  |                                  |                                    |                                  |        |
| Dick Phillips, L (8, PR)<br>OBP: 0.312, SLG: 0.309 |   |                                  |                              |                                 |                              |                                 |                              |                                  |                              |                                 |   |                                 |                              |                                 |                              |                                  |                              |                                  |                                  |                                    |                                  |        |
| Don Lock, R (1, 8)<br>OBP: 0.372, SLG: 0.446       | 4-0<br>BLK<br>BB<br>1-2<br>2-3                        |                                  | 0-0<br>HR                    | 0-0<br>6-3                      |                              |                                 |                              | 0-0<br>6-3                       | 0-0<br>HR                    | 0-3<br>K                        | 5 2 2 4 1 1 3   |                                 |                              |                                 |                              |                                  |                              |                                  |                                  |                                    |                                  |        |
| Mike Brumley, L (1, 2)<br>OBP: 0.328, SLG: 0.292   | 0-0<br>F8   |                                  | 0-0<br>4-3                   |                                 | 4-0<br>CS<br>BB              |                                 | 0-3<br>K                     | 4-0<br>CS<br>1B<br>BB            |                              | 3 0 0 0 2 1 2                   |   |                                 |                              |                                 |                              |                                  |                              |                                  |                                  |                                    |                                  |        |
| Don Zimmer, R (1, 5)<br>OBP: 0.298, SLG: 0.465     |   | 0-0<br>6-3<br>2B                 | 0-0<br>F8                    |                                 | 0-0<br>5-3                   |                                 | 0-0<br>HR                    | 0-0<br>1B                        |                              | 5 1 3 1 0 0 1<br>0 0 0 0 0 0 0  | AB 42<br>R 13<br>H 17<br>RBI 9<br>BB 7<br>SO 9<br>LOB 17                              |                                 |                              |                                 |                              |                                  |                              |                                  |                                  |                                    |                                  |        |
| John Kennedy, R (8, PR)<br>OBP: 0.329, SLG: 0.440  |   |                                  |                              |                                 |                              |                                 |                              |                                  |                              |                                 |   |                                 |                              |                                 |                              |                                  |                              |                                  |                                  |                                    |                                  |        |
| Ed Brinkman, R (1, 6)<br>OBP: 0.289, SLG: 0.376    |   | 0-0<br>6-3                       | 0-0<br>5-3                   |                                 | 0-0<br>P2                    |                                 | 0-0<br>1B                    | 0-3<br>K                         |                              | 5 0 1 0 0 1 3                   |   |                                 |                              |                                 |                              |                                  |                              |                                  |                                  |                                    |                                  |        |
| Buster Narum, R (1, 1)<br>OBP: 0.033, SLG: 0.033   |   | 0-3<br>K                         |                              | 0-0<br>5-3                      |                              | 0-3<br>K                        | 0-3<br>K                     |                                  | 0-0<br>F8                    | 5 0 0 0 0 3 2                   |  |                                 |                              |                                 |                              |                                  |                              |                                  |                                  |                                    |                                  |        |
|  |   |                                  |                              |                                 |                              |                                 |                              |                                  |                              |                                 |   |                                 |                              |                                 |                              |                                  |                              |                                  |                                  |                                    |                                  |        |
| Inning Stats                                       | R: 1<br>E: 0<br>K: 1<br>S: 6                          | H: 1<br>LOB: 2<br>BB: 2<br>P: 14 | R: 0<br>E: 0<br>K: 1<br>S: 6 | H: 1<br>LOB: 1<br>BB: 0<br>P: 6 | R: 4<br>E: 0<br>K: 0<br>S: 7 | H: 4<br>LOB: 0<br>BB: 0<br>P: 7 | R: 2<br>E: 0<br>K: 1<br>S: 7 | H: 2<br>LOB: 1<br>BB: 1<br>P: 11 | R: 0<br>E: 0<br>K: 0<br>S: 2 | H: 0<br>LOB: 0<br>BB: 1<br>P: 6 | R: 0<br>E: 0<br>K: 2<br>S: 9  | H: 2<br>LOB: 2<br>BB: 0<br>P: 9 | R: 1<br>E: 0<br>K: 2<br>S: 9 | H: 2<br>LOB: 1<br>BB: 0<br>P: 9 | R: 4<br>E: 0<br>K: 1<br>S: 8 | H: 4<br>LOB: 2<br>BB: 1<br>P: 13 | R: 1<br>E: 0<br>K: 1<br>S: 6 | H: 1<br>LOB: 2<br>BB: 2<br>P: 14 | 1B: 9<br>2B: 6<br>3B: 0<br>HR: 3 | SF: 0<br>SAC: 0<br>DP: 1<br>HBP: 1 | WP: 1<br>PB: 0<br>SB: 4<br>CS: 2 | PA: 50 |
| PITCHER  | IP WLS BF H R ER SO BB IBB HBP BLK WP HR S P ERA WHIP |                                  |                              |                                 |                              |                                 |                              |                                  |                              |                                 |   |                                 |                              |                                 |                              |                                  |                              |                                  |                                  |                                    |                                  |        |
| Orlando Pena, R (1, 1)<br>ERA: 4.24                | 2.0 L 14 6 5 5 2 2 0 0 0 1 0 1 16 24 22.50 4.000      |                                  |                              |                                 |                              |                                 |                              |                                  |                              |                                 |   |                                 |                              |                                 |                              |                                  |                              |                                  |                                  |                                    |                                  |        |
| Jose Santiago, R (3, 1)<br>ERA: 4.09               | 1.1 7 2 2 2 0 1 0 0 0 0 0 0 6 10 13.50 2.250          |                                  |                              |                                 |                              |                                 |                              |                                  |                              |                                 |   |                                 |                              |                                 |                              |                                  |                              |                                  |                                  |                                    |                                  |        |
| Wes Stock, R (4, 1)<br>ERA: 3.67                   | 0.2 2 0 0 0 1 0 0 0 0 0 0 0 4 4 0.00 0.000            |                                  |                              |                                 |                              |                                 |                              |                                  |                              |                                 |   |                                 |                              |                                 |                              |                                  |                              |                                  |                                  |                                    |                                  |        |
| Moe Drabowsky, R (5, 1)<br>ERA: 6.65               | 3.1 18 7 5 5 4 1 0 1 0 0 2 24 29 13.50 2.400          |                                  |                              |                                 |                              |                                 |                              |                                  |                              |                                 |   |                                 |                              |                                 |                              |                                  |                              |                                  |                                  |                                    |                                  |        |
| Joe Grzenda, L (8, 1)<br>ERA: 6.06                 | 1.2 9 2 1 1 2 3 0 0 0 1 0 10 22 5.40 3.000            |                                  |                              |                                 |                              |                                 |                              |                                  |                              |                                 |   |                                 |                              |                                 |                              |                                  |                              |                                  |                                  |                                    |                                  |        |

Washington Senators @ Kansas City Athletics  
Municipal Stadium, Kansas City, MO  
Sun Jun 21 1964, 4:33 AM EDT  
Unknown

livebaseballscorecards.com

| Batter   | 1                     | 2                       | 3                      | 4       | 5       | 6      | 7       | 8      | 9       | AB | R | H | RBI | BB | SO | LOB |
|--|-----------------------|-------------------------|------------------------|---------|---------|--------|---------|--------|---------|----|---|---|-----|----|----|-----|
| Wayne Causey, L (1, 6)<br>OBP: 0.408, SLG: 0.414<br>George Williams, R (9, 6)<br>OBP: 0.167, SLG: 0.091  | 4-0 SH1-3<br>1B<br>BB | 0-0 G3                  |                        |         | 0-0 P6  |        | 0-0 1B  |        |         | 3  | 1 | 1 | 0   | 1  | 0  | 1   |
| Dick Green, R (1, 4)<br>OBP: 0.258, SLG: 0.346   | 0-0 SH1-3<br>1-2      |                         | 0-0 HR                 |         | 0-3 K   |        | 0-0 4-3 |        |         | 3  | 1 | 1 | 1   | 0  | 1  | 1   |
| Ed Charles, R (1, 5)<br>OBP: 0.353, SLG: 0.406   | 0-3 K                 |                         | 0-0 1B<br>1B           |         | 0-0 5-3 |        |         | 0-0 F7 |         | 4  | 0 | 1 | 0   | 0  | 1  | 1   |
| Rocky Colavito, R (1, 9)<br>OBP: 0.379, SLG: 0.531<br>Jose Tartabull, L (9, 9)<br>OBP: 0.158, SLG: 0.211   | 4-0 1B<br>BB          |                         | 0-0 1B<br>G4-6-3<br>1B |         | 0-0 F7  |        |         | 0-3 K  |         | 3  | 0 | 1 | 0   | 1  | 1  | 0   |
| Jim Gentile, L (1, 3)<br>OBP: 0.417, SLG: 0.548<br>George Alusik, R (9, 3)<br>OBP: 0.381, SLG: 0.368   | 0-0 1B<br>1-3<br>2-H  |                         | 0-0 G4-6-3<br>1-2f     |         | 0-0 4-3 |        |         | 0-0 L4 |         | 4  | 0 | 1 | 1   | 0  | 0  | 1   |
| Billy Bryan, L (1, 2)<br>OBP: 0.364, SLG: 0.678<br>Dave Duncan, R (7, 2)<br>OBP: 0.250, SLG: 0.250   | 0-0 F7                |                         |                        | 0-3 K   |         | 0-0 1B |         |        | 0-3 K   | 3  | 0 | 1 | 0   | 0  | 1  | 2   |
| Manny Jimenez, L (1, 7)<br>OBP: 0.282, SLG: 0.486  |                       | 1-0 FC5-4<br>HBP        |                        | 0-0 2B  |         | 0-0 F2 |         |        | 0-0 4-3 | 3  | 0 | 1 | 0   | 0  | 0  | 1   |
| Nelson Mathews, R (1, 8)<br>OBP: 0.298, SLG: 0.355   |                       | 0-0 FC5-4<br>PB<br>1-2f |                        | 0-0 F7  |         | 0-3 K  |         |        | 0-0 F5  | 4  | 0 | 0 | 0   | 0  | 1  | 2   |
| Orlando Pena, R (1, 1)<br>OBP: 0.143, SLG: 0.175<br>Jose Santiago, R (3, 1)<br>Wes Stock, R (4, 1)<br>OBP: 0.200, SLG: 0.200<br>Rick Joseph, R (4, PH)<br>Moe Drabowsky, R (5, 1)<br>OBP: 0.043, SLG: 0.043<br>Joe Grzenda, R (8, 1) |                       | 0-0 F7<br>1-2           |                        | 0-0 6-3 |         | 0-3 K  |         |        | 0-3 K   | 1  | 0 | 0 | 0   | 0  | 0  | 1   |

| Inning Stats                                   | R: 1    | H: 1   | E: 0   | K: 1 | S: 6 | R: 0   | H: 0  | E: 0  | K: 0   | S: 3   | R: 0   | H: 3  | E: 0  | K: 0  | S: 4  | R: 0      | H: 0        | E: 0 | K: 1 | S: 6 | R: 0   | H: 1  | E: 0 | K: 1 | S: 5 | R: 0   | H: 1  | E: 0 | K: 0 | S: 4 | R: 0   | H: 0  | E: 0 | K: 2 | S: 8 | R: 0   | H: 0  | E: 0 | K: 1 | S: 5 | R: 0   | H: 0  | E: 0 | K: 1 | S: 5 |  |  |
|--|---------|--------|--------|------|------|--------|-------|-------|--------|--------|--------|-------|-------|-------|-------|-----------|-------------|------|------|------|--------|-------|------|------|------|--------|-------|------|------|------|--------|-------|------|------|------|--------|-------|------|------|------|--------|-------|------|------|------|--|--|
|  | LOB: 2  | BB: 2  | P: 14  |      |      | LOB: 1 | BB: 0 | P: 4  |        |        | LOB: 1 | BB: 0 | P: 6  |       |       | LOB: 1    | BB: 0       | P: 4 |      |      | LOB: 0 | BB: 0 | P: 5 |      |      | LOB: 1 | BB: 0 | P: 4 |      |      | LOB: 1 | BB: 0 | P: 8 |      |      | LOB: 0 | BB: 0 | P: 5 |      |      | LOB: 0 | BB: 0 | P: 5 |      |      |  |  |
| PITCHER<br>Buster Narum, R (1, 1)<br>ERA: 3.99 | IP: 9.0 | WLS: W | BF: 35 | H: 7 | R: 2 | ER: 2  | SO: 7 | BB: 2 | IBB: 0 | HBP: 1 | BLK: 0 | WP: 0 | HR: 1 | S: 46 | P: 55 | ERA: 2.00 | WHIP: 1.000 |      |      |      |        |       |      |      |      |        |       |      |      |      |        |       |      |      |      |        |       |      |      |      |        |       |      |      |      |  |  |

**BOTTOM**

Washington Senators @ Kansas City Athletics  
Municipal Stadium, Kansas City, MO

Sun Jun 21 1964, 4:33 AM EDT  
Unknown

|     |    |
|-----|----|
| AB  | 31 |
| R   | 2  |
| H   | 7  |
| RBI | 2  |
| BB  | 2  |
| SO  | 7  |
| LOB | 11 |



|       |        |
|-------|--------|
| WP: 0 | PA: 35 |
| PB: 1 | SB: 0  |
| CS: 0 |        |

livebaseballscorecards.com

| Batter   | 1   | 2                                | 3                            | 4                               | 5                            | 6                               | 7                            | 8                               | 9                            | AB R H RBI BB SO LOB            | TOP                          |                                 |                              |                                 |                              |                                  |                              |                                 |                                  |                                    |                                  |        |
|--|---|----------------------------------|------------------------------|---------------------------------|------------------------------|---------------------------------|------------------------------|---------------------------------|------------------------------|---------------------------------|------------------------------|---------------------------------|------------------------------|---------------------------------|------------------------------|----------------------------------|------------------------------|---------------------------------|----------------------------------|------------------------------------|----------------------------------|--------|
| Ed Brinkman, R (1, 6)<br>OBP: 0.291, SLG: 0.379    | 0-0<br>1B<br>FC6-4<br>2B                              | 0-0<br>6-3                       |                              | 0-0<br>F8                       |                              | 0-0<br>E6<br>1-2                |                              | 4-0<br>BB                       |                              | 4 1 1 0 1 0 2                   |                              |                                 |                              |                                 |                              |                                  |                              |                                 |                                  |                                    |                                  |        |
| John Kennedy, R (1, 5)<br>OBP: 0.326, SLG: 0.434   | 0-0<br>FC6-4<br>2B<br>2-3<br>1B                       | 0-0<br>P5                        |                              | 0-3<br>K                        |                              | 0-0<br>F7                       |                              | 0-0<br>F8                       |                              | 5 1 1 0 0 1 4                   |                              |                                 |                              |                                 |                              |                                  |                              |                                 |                                  |                                    |                                  |        |
| Chuck Hinton, R (1, 7)<br>OBP: 0.387, SLG: 0.508   | 4-0<br>FC6-4<br>1-2<br>BB                             |                                  | 0-0<br>F8                    |                                 | 0-0<br>2B<br>2B              |                                 | 0-0<br>F9                    |                                 | 0-0<br>F8                    | 4 1 1 0 1 0 0                   |                              |                                 |                              |                                 |                              |                                  |                              |                                 |                                  |                                    |                                  |        |
| Bill Skowron, R (1, 3)<br>OBP: 0.312, SLG: 0.478   | 0-0<br>FC6-4<br>2B<br>1-2f<br>2-3<br>3-H              |                                  | 0-0<br>2B                    |                                 | 0-0<br>2B<br>2-H             |                                 | 0-0<br>4-3                   |                                 | 0-0<br>1B                    | 5 0 3 2 0 0 2                   |                              |                                 |                              |                                 |                              |                                  |                              |                                 |                                  |                                    |                                  |        |
| Don Lock, R (1, 8)<br>OBP: 0.373, SLG: 0.456       | 0-0<br>1-3<br>3-H<br>2B                               |                                  | 0-0<br>6-3                   |                                 | 0-0<br>5-3                   |                                 | 0-0<br>2B                    |                                 | 0-3<br>K                     | 5 0 2 1 0 1 2                   |                              |                                 |                              |                                 |                              |                                  |                              |                                 |                                  |                                    |                                  |        |
| Don Zimmer, R (1, 9)<br>OBP: 0.291, SLG: 0.454     | 0-3<br>K  |                                  | 0-3<br>K                     |                                 | 0-0<br>P5                    |                                 | 0-0<br>F7                    |                                 | 0-0<br>F7                    | 4 0 0 0 0 2 4                   |                              |                                 |                              |                                 |                              |                                  |                              |                                 |                                  |                                    |                                  |        |
| Fred Valentine, S (7, 9)<br>OBP: 0.299, SLG: 0.333 |   |                                  |                              |                                 |                              |                                 |                              |                                 |                              | 1 0 0 0 0 0 1                   |                              |                                 |                              |                                 |                              |                                  |                              |                                 |                                  |                                    |                                  |        |
| Don Leppert, R (1, 2)<br>OBP: 0.230, SLG: 0.232    | 4-0<br>BB   |                                  |                              | 0-3<br>K                        |                              | 0-0<br>E6<br>E                  |                              | 0-0<br>HR                       |                              | 3 1 1 1 1 1 0                   |                              |                                 |                              |                                 |                              |                                  |                              |                                 |                                  |                                    |                                  |        |
| Chuck Cottier, R (1, 4)<br>OBP: 0.293, SLG: 0.444  | 0-3<br>K  |                                  |                              | 0-0<br>1B<br>3B                 |                              | 0-0<br>F9                       |                              | 0-0<br>F5                       |                              | 4 1 1 0 0 1 4                   |                              |                                 |                              |                                 |                              |                                  |                              |                                 |                                  |                                    |                                  |        |
| Alan Koch, R (1, 1)<br>OBP: 0.222, SLG: 0.333      |   |                                  |                              | 0-0<br>F3                       |                              | 0-0<br>P4                       |                              | 0-3<br>K                        |                              | 4 0 1 1 0 1 1                   |                              |                                 |                              |                                 |                              |                                  |                              |                                 |                                  |                                    |                                  |        |
| Ron Kline, R (9, 1)                                |   |                                  |                              | 3-H<br>1B                       |                              |                                 |                              |                                 |                              | 0 0 0 0 0 0 0                   |                              |                                 |                              |                                 |                              |                                  |                              |                                 |                                  |                                    |                                  |        |
| <b>Inning Stats</b>                                | R: 2<br>E: 0<br>K: 2<br>S: 10                         | H: 3<br>LOB: 3<br>BB: 2<br>P: 18 | R: 0<br>E: 0<br>K: 0<br>S: 3 | H: 0<br>LOB: 0<br>BB: 0<br>P: 3 | R: 0<br>E: 0<br>K: 1<br>S: 6 | H: 1<br>LOB: 1<br>BB: 0<br>P: 6 | R: 1<br>E: 0<br>K: 2<br>S: 9 | H: 2<br>LOB: 1<br>BB: 0<br>P: 9 | R: 1<br>E: 0<br>K: 0<br>S: 4 | H: 2<br>LOB: 0<br>BB: 0<br>P: 4 | R: 0<br>E: 2<br>K: 0<br>S: 5 | H: 0<br>LOB: 2<br>BB: 0<br>P: 5 | R: 0<br>E: 0<br>K: 0<br>S: 4 | H: 1<br>LOB: 1<br>BB: 0<br>P: 4 | R: 1<br>E: 0<br>K: 1<br>S: 6 | H: 1<br>LOB: 1<br>BB: 1<br>P: 10 | R: 0<br>E: 0<br>K: 1<br>S: 6 | H: 1<br>LOB: 1<br>BB: 0<br>P: 6 | 1B: 3<br>2B: 6<br>3B: 1<br>HR: 1 | SF: 0<br>SAC: 0<br>DP: 0<br>HBP: 0 | WP: 0<br>PB: 0<br>SB: 0<br>CS: 0 | PA: 42 |
| <b>PITCHER</b>                                     | IP WLS BF H R ER SO BB IBB HBP BLK WP HR S P ERA WHIP |                                  |                              |                                 |                              |                                 |                              |                                 |                              |                                 |                              |                                 |                              |                                 |                              |                                  |                              |                                 |                                  |                                    |                                  |        |
| Ted Bowsfield, L (1, 1)<br>ERA: 4.28               | 4.0 L 21 7 4 4 5 2 0 0 0 0 0 0 29 37 9.00 2.250       |                                  |                              |                                 |                              |                                 |                              |                                 |                              |                                 |                              |                                 |                              |                                 |                              |                                  |                              |                                 |                                  |                                    |                                  |        |
| John Wyatt, R (5, 1)<br>ERA: 2.3                   | 4.0 17 3 1 1 1 1 0 0 0 0 0 1 18 22 2.25 1.000         |                                  |                              |                                 |                              |                                 |                              |                                 |                              |                                 |                              |                                 |                              |                                 |                              |                                  |                              |                                 |                                  |                                    |                                  |        |
| Wes Stock, R (9, 1)<br>ERA: 3.54                   | 1.0 4 1 0 0 0 1 0 0 0 0 0 0 6 6 0.00 1.000            |                                  |                              |                                 |                              |                                 |                              |                                 |                              |                                 |                              |                                 |                              |                                 |                              |                                  |                              |                                 |                                  |                                    |                                  |        |

Washington Senators @ Kansas City Athletics  
Municipal Stadium, Kansas City, MO  
Sun Jun 21 1964, 4:38 AM EDT  
Att. 13,995 - Unknown

|     |    |
|-----|----|
| AB  | 39 |
| R   | 5  |
| H   | 11 |
| RBI | 5  |
| BB  | 3  |
| SO  | 7  |
| LOB | 20 |





| Batter   | 1      | 2      | 3       | 4       | 5 | 6      | 7       | 8      | 9       | AB | R | H | RBI | BB | SO | LOB |
|--|--------|--------|---------|---------|---|--------|---------|--------|---------|----|---|---|-----|----|----|-----|
| Wayne Causey, L (1, 6)<br>OBP: 0.412, SLG: 0.421   | 4-0 BB |        | 0-0 2B  |         |   | 0-0 1B |         | 0-0 L3 |         | 3  | 0 | 2 | 1   | 1  | 0  | 0   |
| Dick Green, R (1, 4)<br>OBP: 0.253, SLG: 0.339     | 0-0 F7 |        | 0-0 6-3 |         |   | 0-3 K  |         |        | 0-3 K   | 4  | 0 | 0 | 0   | 0  | 2  | 3   |
| Ed Charles, R (1, 5)<br>OBP: 0.352, SLG: 0.416     | 0-0 P4 |        | 0-0 5-3 |         |   | 0-0 F9 |         |        | 0-0 HR  | 4  | 1 | 1 | 1   | 0  | 0  | 3   |
| Rocky Colavito, R (1, 9)<br>OBP: 0.373, SLG: 0.521 | 0-0 P4 |        |         | 0-0 P6  |   | 0-0 L5 |         |        | 0-0 F2  | 4  | 0 | 0 | 0   | 0  | 0  | 2   |
| George Alusik, R (1, 7)<br>OBP: 0.373, SLG: 0.359  |        | 0-0 F2 |         | 0-0 5-3 |   |        | 0-0 5-3 |        | 0-0 WP  | 3  | 0 | 0 | 0   | 0  | 0  | 0   |
| Billy Bryan, L (9, PH)<br>OBP: 0.373, SLG: 0.700   |        |        |         |         |   |        |         |        | 0-0 2B  | 1  | 0 | 1 | 0   | 0  | 0  | 0   |
| Doc Edwards, R (1, 2)<br>OBP: 0.237, SLG: 0.252    |        | 0-3 K  |         | 0-0 F8  |   |        | 0-0 F2  |        | 0-0 F7  | 4  | 0 | 0 | 0   | 0  | 1  | 1   |
| Rick Joseph, R (1, 3)                              |        | 0-3 K  |         |         |   | 0-0 F8 |         |        | 0-0 F3  | 3  | 0 | 0 | 0   | 0  | 1  | 0   |
| Nelson Mathews, R (1, 8)<br>OBP: 0.299, SLG: 0.359 |        |        | 0-0 2B  |         |   | 0-0 F7 |         |        | 0-0 5-3 | 3  | 1 | 1 | 0   | 0  | 0  | 0   |
| Ted Bowsfield, R (1, 1)                            |        |        | 0-3 K   |         |   |        |         |        | 0-0 F9  | 1  | 0 | 0 | 0   | 0  | 1  | 1   |
| John Wyatt, R (5, 1)                               |        |        |         |         |   |        |         |        |         | 1  | 0 | 0 | 0   | 0  | 1  | 0   |
| Manny Jimenez, L (8, PH)<br>OBP: 0.278, SLG: 0.479 |        |        |         |         |   |        |         |        |         | 1  | 0 | 0 | 0   | 0  | 0  | 0   |
| Wes Stock, R (9, 1)<br>OBP: 0.200, SLG: 0.200      |        |        |         |         |   |        |         |        |         | 0  | 0 | 0 | 0   | 0  | 0  | 0   |

| Inning Stats                     | R: 0 | H: 0 | E: 0 | K: 0 | S: 3 | R: 0 | H: 0 | E: 0 | K: 2 | S: 7 | R: 1 | H: 2 | E: 0 | K: 1 | S: 7 | R: 0 | H: 0  | E: 0 | K: 0 | S: 3 | R: 0 | H: 0 | E: 0 | K: 1 | S: 5 | R: 0 | H: 1 | E: 0 | K: 1 | S: 6 | R: 0 | H: 0 | E: 0 | K: 0 | S: 3 | R: 0 | H: 0 | E: 0 | K: 0 | S: 3 | R: 1 | H: 2 | E: 0 | K: 1 | S: 7 | 1B: 1 | 2B: 3 | 3B: 0 | HR: 1 | SF: 0 | SAC: 0 | DP: 0 | HBP: 0 | WP: 1 | PA: 33 |
|----------------------------------|------|------|------|------|------|------|------|------|------|------|------|------|------|------|------|------|-------|------|------|------|------|------|------|------|------|------|------|------|------|------|------|------|------|------|------|------|------|------|------|------|------|------|------|------|------|-------|-------|-------|-------|-------|--------|-------|--------|-------|--------|
| PITCHER                          | IP   | WLS  | BF   | H    | R    | ER   | SO   | BB   | IBB  | HBP  | BLK  | WP   | HR   | S    | P    | ERA  | WHIP  |      |      |      |      |      |      |      |      |      |      |      |      | IP   | WLS  | BF   | H    | R    | ER   | SO   | BB   | IBB  | HBP  | BLK  | WP   | HR   | S    | P    | ERA  | WHIP  |       |       |       |       |        |       |        |       |        |
| Alan Koch, R (1, 1)<br>ERA: 4.2  | 8.1  | W    | 30   | 4    | 2    | 2    | 6    | 1    | 0    | 0    | 0    | 0    | 1    | 41   | 45   | 2.16 | 0.600 |      |      |      |      |      |      |      |      |      |      |      |      |      |      |      |      |      |      |      |      |      |      |      |      |      |      |      |      |       |       |       |       |       |        |       |        |       |        |
| Ron Kline, R (9, 1)<br>ERA: 1.89 | 0.2  | S    | 3    | 1    | 0    | 0    | 0    | 0    | 0    | 0    | 0    | 1    | 0    | 3    | 3    | 0.00 | 1.500 |      |      |      |      |      |      |      |      |      |      |      |      |      |      |      |      |      |      |      |      |      |      |      |      |      |      |      |      |       |       |       |       |       |        |       |        |       |        |

**BOTTOM**

Washington Senators @ Kansas City Athletics  
Municipal Stadium, Kansas City, MO

Sun Jun 21 1964, 4:38 AM EDT  
Att. 13,995 - Unknown

|     |    |
|-----|----|
| AB  | 32 |
| R   | 2  |
| H   | 5  |
| RBI | 2  |
| BB  | 1  |
| SO  | 6  |
| LOB | 10 |



livebaseballscores.com

| Batter   | 1                            | 2                               | 3                            | 4                               | 5                            | 6                               | 7                            | 8                               | 9                            | AB                              | R                            | H                               | RBI                          | BB                              | SO                           | LOB                             | TOP   |                              |   |                                  |                                    |                                  |
|--|------------------------------|---------------------------------|------------------------------|---------------------------------|------------------------------|---------------------------------|------------------------------|---------------------------------|------------------------------|---------------------------------|------------------------------|---------------------------------|------------------------------|---------------------------------|------------------------------|---------------------------------|---|------------------------------|---|----------------------------------|------------------------------------|----------------------------------|
| Jerry Lumpe, L (1, 4)<br>OBP: 0.288, SLG: 0.324  | 0-3<br>K                     |                                 | x 0-0<br>4-3                 |                                 | x 0-0<br>F7                  |                                 | x 0-0<br>F8                  |                                 |                              | 4                               | 0                            | 0                               | 0                            | 0                               | 1                            | 3                               | <p><b>Detroit Tigers @ Kansas City Athletics</b></p> <p>Municipal Stadium, Kansas City, MO</p> <p>Tue Jun 23 1964, 8:05 PM EDT</p> <p>Unknown</p> |                              |   |                                  |                                    |                                  |
| Jake Wood, R (1, 3)<br>Norm Cash, L (8, PH)<br>OBP: 0.190, SLG: 0.230<br>OBP: 0.313, SLG: 0.395  | 0-3<br>K2-3                  |                                 | x 0-0<br>F8                  |                                 | x 0-0<br>F9                  |                                 |                              | BB                              |                              | 3                               | 0                            | 0                               | 0                            | 0                               | 1                            | 2                               |   |                              |   |                                  |                                    |                                  |
| Al Kaline, R (1, 9)<br>OBP: 0.390, SLG: 0.449  | 0-0<br>L4-3                  |                                 |                              | x 0-0<br>1B                     |                              | x 0-0<br>L5-3                   |                              | BB                              |                              | 4                               | 0                            | 1                               | 0                            | 0                               | 0                            | 1                               |   |                              |   |                                  |                                    |                                  |
| Bill Freehan, R (1, 2)<br>OBP: 0.343, SLG: 0.505   |                              | x 0-0<br>4-3                    |                              | x 0-0<br>L7                     |                              | x 0-0<br>L8                     |                              | BB                              |                              | 4                               | 0                            | 0                               | 0                            | 0                               | 0                            | 2                               |   |                              |   |                                  |                                    |                                  |
| Don Demeter, R (1, 7)<br>OBP: 0.284, SLG: 0.409  |                              | x 0-0<br>E 1B<br>1B             |                              | x 0-0<br>L9                     |                              | x 0-0<br>5-3                    |                              | BB                              |                              | 4                               | 0                            | 1                               | 0                            | 0                               | 1                            | 2                               |   |                              |   |                                  |                                    |                                  |
| George Thomas, R (1, 8)<br>OBP: 0.367, SLG: 0.510  |                              | x 0-0<br>E8<br>FC5 1B           |                              | x 0-0<br>L8                     |                              |                                 | x 0-0<br>4-1<br>1B           |                                 | BB                           | 4                               | 1                            | 2                               | 0                            | 0                               | 1                            | 1                               |   |                              |   |                                  |                                    |                                  |
| Dick McAuliffe, L (1, 6)<br>OBP: 0.344, SLG: 0.467   |                              | 0-3<br>K                        |                              |                                 | x 0-0<br>1B<br>1B            |                                 | x 0-0<br>4-1                 |                                 | BB                           | 4                               | 0                            | 1                               | 0                            | 0                               | 1                            | 3                               |   |                              |   |                                  |                                    |                                  |
| Bubba Phillips, R (1, 5)<br>Don Wert, R (5, 5)<br>OBP: 0.359, SLG: 0.432<br>OBP: 0.312, SLG: 0.337   |                              | x 0-0<br>FC5                    |                              |                                 | x 0-0<br>1B                  |                                 | 0-3<br>K                     |                                 | BB                           | 2                               | 0                            | 1                               | 0                            | 0                               | 0                            | 2                               |   |                              |   |                                  |                                    |                                  |
| Joe Sparma, R (1, 1)<br>Mike Roarke, R (7, PH)<br>Phil Regan, R (7, PR)<br>Fred Gladding, L (7, 1)<br>OBP: 0.245, SLG: 0.213<br>OBP: 0.520, SLG: 0.476 |                              |                                 | x 0-0<br>5-3                 |                                 | x 0-0<br>F5                  |                                 | x 0-0<br>PB<br>1B            |                                 |                              | 1                               | 0                            | 1                               | 1                            | 0                               | 0                            | 0                               |   |                              |   |                                  |                                    |                                  |
| <b>Inning Stats</b>  | R: 0<br>E: 0<br>K: 2<br>S: 7 | H: 0<br>LOB: 0<br>BB: 0<br>P: 7 | R: 0<br>E: 1<br>K: 1<br>S: 7 | H: 2<br>LOB: 2<br>BB: 0<br>P: 7 | R: 0<br>E: 0<br>K: 0<br>S: 3 | H: 0<br>LOB: 0<br>BB: 0<br>P: 3 | R: 0<br>E: 0<br>K: 0<br>S: 4 | H: 1<br>LOB: 1<br>BB: 0<br>P: 4 | R: 0<br>E: 0<br>K: 0<br>S: 5 | H: 2<br>LOB: 2<br>BB: 0<br>P: 5 | R: 0<br>E: 0<br>K: 0<br>S: 3 | H: 0<br>LOB: 0<br>BB: 0<br>P: 3 | R: 1<br>E: 0<br>K: 1<br>S: 7 | H: 2<br>LOB: 2<br>BB: 0<br>P: 7 | R: 0<br>E: 0<br>K: 1<br>S: 5 | H: 0<br>LOB: 1<br>BB: 1<br>P: 9 |   | R: 0<br>E: 0<br>K: 1<br>S: 5 | H: 0<br>LOB: 0<br>BB: 0<br>P: 5   | 1B: 7<br>2B: 0<br>3B: 0<br>HR: 0 | SF: 0<br>SAC: 0<br>DP: 0<br>HBP: 0 | WP: 0<br>PB: 1<br>SB: 0<br>CS: 0 |
| <b>PITCHER</b><br>John O'Donoghue, L (1, 1)<br>Wes Stock, R (7, 1)<br>John Wyatt, R (9, 1)<br>ERA: 4.89<br>ERA: 3.38<br>ERA: 2.25                      | IP<br>6.2<br>1.1<br>1.0      | WLS<br>W<br>S                   | BF<br>27<br>5<br>3           | H<br>7<br>0<br>0                | R<br>1<br>0<br>0             | ER<br>1<br>0<br>0               | SO<br>4<br>1<br>1            | BB<br>0<br>1<br>0               | IBB<br>0<br>0<br>0           | HBP<br>0<br>0<br>0              | BLK<br>0<br>0<br>0           | WP<br>0<br>0<br>0               | HR<br>0<br>0<br>0            | S<br>35<br>6<br>5               | P<br>35<br>10<br>5           | ERA<br>1.35<br>0.00<br>0.00     | WHIP<br>1.050<br>0.750<br>0.000   | <b>PITCHER</b>               | IP<br>WLS<br>BF<br>H<br>R<br>ER<br>SO<br>BB<br>IBB<br>HBP<br>BLK<br>WP<br>HR<br>S<br>P<br>ERA<br>WHIP |                                  |                                    |                                  |

[livebaseballscorecards.com](http://livebaseballscorecards.com)

|            |    |
|------------|----|
| <b>AB</b>  | 34 |
| <b>R</b>   | 1  |
| <b>H</b>   | 7  |
| <b>RBI</b> | 1  |
| <b>BB</b>  | 1  |
| <b>SO</b>  | 6  |
| <b>LOB</b> | 19 |



| Batter  | 1   | 2   | 3  | 4   | 5  | 6   | 7   | 8   | 9 | AB   | R                                       | H | RBI | BB | SO | LOB |
|---|---|---|--|---|--|---|---|---|---|--|---|---|-----|----|----|-----|
| Wayne Causey, L (1, 6)<br>OBP: 0.417, SLG: 0.421    | 4-0<br>6-3 BB   |   | 0-3<br>K   |   | 4-0<br>FC1-2 BB<br>1B                                |   | 0-0<br>F8 SH3-4<br>1B                               |   |   | 2  | 1                                       | 1 | 0   | 2  | 1  | 0   |
| Dick Green, R (1, 4)<br>OBP: 0.258, SLG: 0.338      | 0-0<br>6-3  |   | 4-0<br>BB  |   | 4-0<br>FC1-2 BB<br>1B                                |   | 0-0<br>SH3-4  |   |   | 1  | 1                                       | 0 | 0   | 2  | 0  | 1   |
| Ed Charles, R (1, 5)<br>OBP: 0.347, SLG: 0.409      | 0-0<br>6-3  |   | 0-3<br>K   |   | 0-0<br>FC1-2<br>1B                                   |   | 0-0<br>F8   |   |   | 4  | 0                                       | 0 | 0   | 0  | 1  | 6   |
| Rocky Colavito, R (1, 9)<br>OBP: 0.379, SLG: 0.521  | 4-0<br>BB   |   |  | 4-0<br>BB   | 0-0<br>1B  |   | 0-3<br>K  |   |   | 2  | 0                                       | 1 | 2   | 2  | 1  | 1   |
| Manny Jimenez, L (1, 7)<br>OBP: 0.277, SLG: 0.467   | 0-0<br>4-3  |   | 0-3<br>K   | 0-3<br>K  | 0-3<br>K   |   |   | 0-0<br>6-3 SH1-3<br>1B                              |   | 4  | 0                                       | 1 | 0   | 0  | 2  | 5   |
| Jose Tartabull, L (8, PR)<br>OBP: 0.158, SLG: 0.211 |   |   |  |   |  |   |   |   |   | 0  | 0                                       | 0 | 0   | 0  | 0  | 0   |
| Billy Bryan, L (1, 2)<br>OBP: 0.357, SLG: 0.667     |   | 0-0<br>4-3  |  | 0-0<br>F8   |  | 0-0<br>F4   |   | 0-0<br>SH1-3  |   | 3  | 0                                       | 0 | 0   | 0  | 0  | 1   |
| Rick Joseph, R (1, 3)                               |   | 0-0<br>L9   |  | 0-0<br>F6   |  | 0-0<br>L9   |   | 0-0<br>6-3  |   | 4  | 0                                       | 0 | 0   | 0  | 0  | 3   |
| Nelson Mathews, R (1, 8)<br>OBP: 0.305, SLG: 0.363  |   | 0-0<br>3-1  |  |   | 0-0<br>BB SH1-4<br>FC1-2<br>1B                       | 0-0<br>FC6-4<br>1B                                  |   | 4-0<br>FC6-4<br>IBB                                 |   | 3  | 0                                       | 2 | 0   | 1  | 0  | 0   |
| John O'Donoghue, R (1, 1)<br>OBP: 0.250, SLG: 0.375 |   |   | 0-3<br>K   |   | 0-0<br>SH1-4   | 0-0<br>FC6-4  |   | 0-0<br>FC6-4  |   | 2  | 0                                       | 0 | 0   | 0  | 1  | 1   |
| Wes Stock, R (7, 1)<br>OBP: 0.200, SLG: 0.200       |   |   |  |   | 1-2  | 1-2f  |   | 1-2f  |   | 0  | 0                                       | 0 | 0   | 0  | 0  | 0   |
| George Alusik, R (8, PH)<br>OBP: 0.371, SLG: 0.356  |   |   |  |   |  |   |   |   |   | 1  | 0                                       | 0 | 0   | 0  | 0  | 2   |
| John Wyatt, R (9, 1)                                |   |   |  |   |  |   |   |   |   | 0  | 0                                       | 0 | 0   | 0  | 0  | 0   |
| <b>Inning Stats</b>                                 | R: 0 H: 0<br>E: 0 LOB: 2<br>K: 0 BB: 2<br>S: 3 P: 11  | R: 0 H: 0<br>E: 0 LOB: 0<br>K: 0 BB: 0<br>S: 3 P: 3 | R: 0 H: 0<br>E: 0 LOB: 1<br>K: 3 BB: 1<br>S: 9 P: 13 | R: 0 H: 0<br>E: 0 LOB: 1<br>K: 1 BB: 1<br>S: 5 P: 9 | R: 2 H: 2<br>E: 0 LOB: 2<br>K: 1 BB: 2<br>S: 7 P: 15 | R: 0 H: 1<br>E: 0 LOB: 1<br>K: 0 BB: 0<br>S: 4 P: 4 | R: 0 H: 1<br>E: 0 LOB: 1<br>K: 1 BB: 0<br>S: 6 P: 6 | R: 0 H: 1<br>E: 0 LOB: 2<br>K: 0 BB: 1<br>S: 4 P: 8 |   | 1B: 5 SF: 0<br>2B: 0 SAC: 3<br>3B: 0 DP: 0<br>HR: 0 HBP: 0 | WP: 0 PA: 36<br>PB: 0<br>SB: 0<br>CS: 0 |   |     |    |    |     |
| <b>PITCHER</b>                                      | IP WLS BF H R ER SO BB IBB HBP BLK WP HR S P ERA WHIP |   |  |   |  |   |   |   |   |  |   |   |     |    |    |     |
| Joe Sparna, R (1, 1)<br>ERA: 1.69                   | 6.0 L 27 3 2 2 5 6 0 0 0 0 0 0 31 55 3.00 1.500       |   |  |   |  |   |   |   |   |  |   |   |     |    |    |     |
| Fred Gladding, R (7, 1)<br>ERA: 5.4                 | 2.0 9 2 0 0 1 0 1 0 0 0 0 0 10 14 0.00 1.000          |   |  |   |  |   |   |   |   |  |   |   |     |    |    |     |

**BOTTOM**

**Detroit Tigers @ Kansas City Athletics**  
Municipal Stadium, Kansas City, MO  
Tue Jun 23 1964, 8:05 PM EDT  
Unknown

[livebaseballscorecards.com](http://livebaseballscorecards.com)

|            |           |
|------------|-----------|
| <b>AB</b>  | <b>26</b> |
| <b>R</b>   | <b>2</b>  |
| <b>H</b>   | <b>5</b>  |
| <b>RBI</b> | <b>2</b>  |
| <b>BB</b>  | <b>7</b>  |
| <b>SO</b>  | <b>6</b>  |
| <b>LOB</b> | <b>20</b> |



| Batter   | 1   | 2                               | 3                            | 4                                | 5                            | 6                               | 7                            | 8                               | 9                            | AB R H RBI BB SO LOB            | TOP   |                                 |                              |                                  |                              |                                  |                              |                                 |                                  |                                    |                                  |        |
|--|---|---------------------------------|------------------------------|----------------------------------|------------------------------|---------------------------------|------------------------------|---------------------------------|------------------------------|---------------------------------|---|---------------------------------|------------------------------|----------------------------------|------------------------------|----------------------------------|------------------------------|---------------------------------|----------------------------------|------------------------------------|----------------------------------|--------|
| Jerry Lumpe, L (1, 4)<br>OBP: 0.295, SLG: 0.336    | 0-0<br>1B   | 4-0<br>2B<br>1B<br>BB           |                              | 0-0<br>E6<br>3B                  |                              | 0-0<br>F9                       |                              | 0-0<br>SH<br>BB<br>HR           |                              | 3 3 2 0 1 0 1                   |   |                                 |                              |                                  |                              |                                  |                              |                                 |                                  |                                    |                                  |        |
| Gates Brown, L (1, 7)<br>OBP: 0.354, SLG: 0.521    | 0-0<br>1B<br>BB                                       | 0-0<br>1B<br>2B                 |                              | 0-0<br>1-3                       |                              |                                 | 0-0<br>1B<br>BB              | 0-0<br>F8                       |                              | 5 1 3 1 0 0 3                   |   |                                 |                              |                                  |                              |                                  |                              |                                 |                                  |                                    |                                  |        |
| Al Kaline, R (1, 9)<br>OBP: 0.394, SLG: 0.450      | 0-0<br>L6   | 0-0<br>1B                       |                              | 0-3<br>K                         |                              |                                 | 0-0<br>1B<br>BB              | 4-0<br>HR<br>BB                 |                              | 4 1 2 3 1 1 2                   |   |                                 |                              |                                  |                              |                                  |                              |                                 |                                  |                                    |                                  |        |
| Norm Cash, L (1, 3)<br>OBP: 0.311, SLG: 0.388      | 4-0<br>1B<br>BB                                       | 0-3<br>K                        |                              |                                  | 0-0<br>F6                    |                                 | 0-0<br>F6                    | 0-0<br>F7                       |                              | 4 0 0 0 1 1 6                   |   |                                 |                              |                                  |                              |                                  |                              |                                 |                                  |                                    |                                  |        |
| Dick McAuliffe, L (1, 6)<br>OBP: 0.350, SLG: 0.479 | 0-0<br>F4   |                                 |                              | 4-0<br>SH5-4<br>BB               |                              | 0-0<br>4-3                      |                              | 0-0<br>HR                       |                              | 3 1 1 4 2 0 3                   |   |                                 |                              |                                  |                              |                                  |                              |                                 |                                  |                                    |                                  |        |
| George Thomas, R (1, 8)<br>OBP: 0.354, SLG: 0.491  | 0-0<br>F2   |                                 |                              | 0-0<br>SH5-4                     |                              | 0-0<br>5-3                      |                              | 0-0<br>5-3                      |                              | 4 0 0 0 0 1 6                   |   |                                 |                              |                                  |                              |                                  |                              |                                 |                                  |                                    |                                  |        |
| Don Wert, R (1, 5)<br>OBP: 0.305, SLG: 0.328       |   | 0-0<br>4-3                      |                              | 0-0<br>5-3                       |                              | 0-3<br>K                        | 0-3<br>K                     |                                 | 0-3<br>K                     | 5 0 0 0 0 3 4                   | AB 33<br>R 9<br>H 8<br>RBI 8<br>BB 9<br>SO 8<br>LOB 26                                |                                 |                              |                                  |                              |                                  |                              |                                 |                                  |                                    |                                  |        |
| Mike Roarke, R (1, 2)<br>OBP: 0.259, SLG: 0.200    |   | 0-3<br>K                        |                              | 0-0<br>6-3                       |                              | 4-0<br>SH1-4<br>BB              |                              | 4-0<br>SH<br>BB<br>BB           | 0-0<br>6-3                   | 3 1 0 0 2 1 1                   |   |                                 |                              |                                  |                              |                                  |                              |                                 |                                  |                                    |                                  |        |
| Mickey Lolich, S (1, 1)<br>OBP: 0.250, SLG: 0.087  |   | 4-0<br>2B<br>BB                 |                              | 0-3<br>K                         |                              | 0-0<br>SH1-4                    |                              | 4-0<br>BB<br>SH<br>HR<br>BB     | 0-0<br>3-1                   | 2 2 0 0 2 1 0                   |  |                                 |                              |                                  |                              |                                  |                              |                                 |                                  |                                    |                                  |        |
| <b>Inning Stats</b>                                | R: 0<br>E: 0<br>K: 0<br>S: 5                          | H: 2<br>LOB: 3<br>BB: 1<br>P: 9 | R: 3<br>E: 0<br>K: 2<br>S: 9 | H: 2<br>LOB: 1<br>BB: 2<br>P: 17 | R: 0<br>E: 0<br>K: 0<br>S: 3 | H: 0<br>LOB: 1<br>BB: 1<br>P: 7 | R: 1<br>E: 1<br>K: 2<br>S: 8 | H: 1<br>LOB: 0<br>BB: 0<br>P: 8 | R: 0<br>E: 0<br>K: 0<br>S: 3 | H: 0<br>LOB: 0<br>BB: 0<br>P: 3 | R: 0<br>E: 0<br>K: 1<br>S: 5  | H: 0<br>LOB: 1<br>BB: 1<br>P: 9 | R: 0<br>E: 0<br>K: 2<br>S: 9 | H: 2<br>LOB: 3<br>BB: 1<br>P: 13 | R: 5<br>E: 0<br>K: 0<br>S: 5 | H: 1<br>LOB: 0<br>BB: 3<br>P: 17 | R: 0<br>E: 0<br>K: 1<br>S: 5 | H: 0<br>LOB: 0<br>BB: 0<br>P: 5 | 1B: 5<br>2B: 1<br>3B: 1<br>HR: 1 | SF: 0<br>SAC: 3<br>DP: 0<br>HBP: 0 | WP: 0<br>PB: 0<br>SB: 0<br>CS: 0 | PA: 45 |
| <b>PITCHER</b>                                     | IP WLS BF H R ER SO BB IBB HBP BLK WP HR S P ERA WHIP |                                 |                              |                                  |                              |                                 |                              |                                 |                              |                                 |   |                                 |                              |                                  |                              |                                  |                              |                                 |                                  |                                    |                                  |        |
| Dan Pfister, R (1, 1)<br>ERA: 7.27                 | 1.2 L 11 3 3 3 1 3 0 0 0 0 0 0 10 22 16.20 3.600      |                                 |                              |                                  |                              |                                 |                              |                                 |                              |                                 |   |                                 |                              |                                  |                              |                                  |                              |                                 |                                  |                                    |                                  |        |
| Orlando Pena, R (2, 1)<br>ERA: 4.18                | 1.1 6 1 0 0 1 1 0 0 0 0 0 0 7 11 0.00 1.500           |                                 |                              |                                  |                              |                                 |                              |                                 |                              |                                 |   |                                 |                              |                                  |                              |                                  |                              |                                 |                                  |                                    |                                  |        |
| Moe Drabowsky, R (4, 1)<br>ERA: 6.48               | 3.1 15 3 1 1 3 2 0 0 0 0 0 0 19 27 2.70 1.500         |                                 |                              |                                  |                              |                                 |                              |                                 |                              |                                 |   |                                 |                              |                                  |                              |                                  |                              |                                 |                                  |                                    |                                  |        |
| Wes Stock, R (7, 1)<br>ERA: 3.9                    | 0.2 4 0 2 2 2 2 0 0 0 0 0 0 6 14 27.00 3.000          |                                 |                              |                                  |                              |                                 |                              |                                 |                              |                                 |   |                                 |                              |                                  |                              |                                  |                              |                                 |                                  |                                    |                                  |        |
| Jose Santiago, R (8, 1)<br>ERA: 5.54               | 2.0 9 1 3 3 1 1 0 0 0 0 0 1 10 14 13.50 1.000         |                                 |                              |                                  |                              |                                 |                              |                                 |                              |                                 |   |                                 |                              |                                  |                              |                                  |                              |                                 |                                  |                                    |                                  |        |

**Detroit Tigers @ Kansas City Athletics**  
 Municipal Stadium, Kansas City, MO  
 Tue Jun 23 1964, 8:05 PM EDT  
 Att. 11,957 - Unknown

[livebaseballscorecards.com](http://livebaseballscorecards.com)

| Batter  | 1         | 2          | 3         | 4               | 5          | 6 | 7 | 8               | 9 | AB | R | H | RBI | BB | SO | LOB |
|---|-----------|------------|-----------|-----------------|------------|---|---|-----------------|---|----|---|---|-----|----|----|-----|
| Dick Green, R<br>OBP: 0.258, SLG: 0.336<br>(1, 4)   | 0-0<br>F4 |            | 0-0<br>1B |                 | 0-3<br>K   |   |   | 0-0<br>F8       |   | 4  | 0 | 1 | 0   | 0  | 1  | 0   |
| George Williams, R<br>OBP: 0.150, SLG: 0.081<br>(1, 6)  | 0-0<br>F5 |            | 0-0<br>F8 |                 | 0-0<br>F7  |   |   | 0-0<br>F9       |   | 4  | 0 | 0 | 0   | 0  | 0  | 2   |
| Ed Charles, R<br>OBP: 0.345, SLG: 0.411<br>(1, 5)   | 0-0<br>2B |            | 0-0<br>L9 |                 | 0-0<br>6-3 |   |   | 0-0<br>4-3      |   | 4  | 0 | 1 | 0   | 0  | 0  | 2   |
| Rocky Colavito, R<br>OBP: 0.377, SLG: 0.520<br>(1, 9)   | 0-0<br>F4 |            |           | 0-0<br>L9       |            |   |   | 0-0<br>WP<br>2B |   | 4  | 1 | 1 | 0   | 0  | 0  | 1   |
| George Alusik, R<br>OBP: 0.361, SLG: 0.344<br>(1, 7)  |           | 0-0<br>F5  |           | 0-0<br>F5       |            |   |   | 0-0<br>5-3      |   | 4  | 0 | 0 | 0   | 0  | 1  | 1   |
| Doc Edwards, R<br>OBP: 0.237, SLG: 0.252<br>(1, 2)  |           | 0-0<br>4-3 |           | 0-0<br>2B<br>1B |            |   |   | 0-0<br>6-3      |   | 4  | 1 | 1 | 0   | 0  | 0  | 1   |
| Rick Joseph, R<br>OBP: 0.143, SLG: 0.154<br>(1, 3)  |           | 0-0<br>F3  |           | 0-0<br>2B<br>2B |            |   |   | 4-0<br>BB       |   | 3  | 1 | 1 | 0   | 1  | 0  | 0   |
| Nelson Mathews, R<br>OBP: 0.304, SLG: 0.365<br>(1, 8)   |           |            | 0-0<br>F5 |                 | 0-0<br>2B  |   |   | 0-0<br>L8       |   | 4  | 0 | 1 | 2   | 0  | 0  | 1   |
| Dan Pfister, R<br>OBP: 0.143, SLG: 0.175<br>Orlando Pena, R<br>OBP: 0.042, SLG: 0.042<br>Manny Jimenez, L<br>OBP: 0.286, SLG: 0.474<br>Moe Drabowsky, R<br>OBP: 0.167, SLG: 0.167<br>Wes Stock, R<br>OBP: 0.167, SLG: 0.167<br>Jose Santiago, R<br>(8, 1) |           |            | 0-0<br>1B |                 | 0-3<br>K   |   |   | 0-0<br>L6       |   | 0  | 0 | 0 | 0   | 0  | 0  | 0   |

|   |                              |                                 |                              |                                 |                              |                                 |                              |                                 |                              |                                 |                              |                                 |                              |                                 |                              |                                 |                                  |                                    |                                  |        |   |   |    |    |    |     |     |     |    |    |   |   |     |      |
|---|------------------------------|---------------------------------|------------------------------|---------------------------------|------------------------------|---------------------------------|------------------------------|---------------------------------|------------------------------|---------------------------------|------------------------------|---------------------------------|------------------------------|---------------------------------|------------------------------|---------------------------------|----------------------------------|------------------------------------|----------------------------------|--------|---|---|----|----|----|-----|-----|-----|----|----|---|---|-----|------|
| <b>Inning Stats</b>                                       | R: 0<br>E: 0<br>K: 0<br>S: 4 | H: 1<br>LOB: 1<br>BB: 0<br>P: 4 | R: 0<br>E: 0<br>K: 0<br>S: 3 | H: 0<br>LOB: 0<br>BB: 0<br>P: 3 | R: 0<br>E: 0<br>K: 0<br>S: 5 | H: 2<br>LOB: 2<br>BB: 0<br>P: 5 | R: 2<br>E: 0<br>K: 1<br>S: 8 | H: 3<br>LOB: 1<br>BB: 0<br>P: 8 | R: 0<br>E: 0<br>K: 1<br>S: 5 | H: 0<br>LOB: 0<br>BB: 0<br>P: 5 | R: 0<br>E: 0<br>K: 0<br>S: 3 | H: 0<br>LOB: 0<br>BB: 0<br>P: 3 | R: 0<br>E: 0<br>K: 0<br>S: 3 | H: 0<br>LOB: 0<br>BB: 0<br>P: 3 | R: 1<br>E: 0<br>K: 0<br>S: 4 | H: 1<br>LOB: 1<br>BB: 1<br>P: 8 | 1B: 3<br>2B: 4<br>3B: 0<br>HR: 0 | SF: 0<br>SAC: 0<br>DP: 0<br>HBP: 0 | WP: 1<br>PB: 0<br>SB: 0<br>CS: 0 | PA: 35 |   |   |    |    |    |     |     |     |    |    |   |   |     |      |
| <b>PITCHER</b><br>Mickey Lolich, L<br>ERA: 3.86<br>(1, 1) | IP<br>9.0                    | WLS<br>W                        | BF<br>35                     | H<br>7                          | R<br>3                       | ER<br>3                         | SO<br>3                      | BB<br>1                         | IBB<br>0                     | HBP<br>0                        | BLK<br>0                     | WP<br>1                         | HR<br>0                      | S<br>40                         | P<br>44                      | ERA<br>3.00                     | WHIP<br>0.889                    |                                    |                                  |        |   |   |    |    |    |     |     |     |    |    |   |   |     |      |
|   |                              |                                 |                              |                                 |                              |                                 |                              |                                 |                              |                                 |                              |                                 |                              |                                 |                              |                                 | <b>PITCHER</b>                   | IP                                 | WLS                              | BF     | H | R | ER | SO | BB | IBB | HBP | BLK | WP | HR | S | P | ERA | WHIP |

**DETROIT TIGERS @ KANSAS CITY ATHLETICS**  
Municipal Stadium, Kansas City, MO  
Tue Jun 23 1964, 8:05 PM EDT  
Att. 11,957 - Unknown

|     |    |
|-----|----|
| AB  | 34 |
| R   | 3  |
| H   | 7  |
| RBI | 2  |
| BB  | 1  |
| SO  | 3  |
| LOB | 9  |



| Batter   | 1   | 2                                | 3                            | 4                               | 5                            | 6                               | 7                            | 8                               | 9                            | AB                              | R                            | H                                | RBI                          | BB                              | SO                           | LOB                             | TOP   |                                 |                                   |                                    |                                  |        |  |  |  |  |  |  |  |  |  |
|--|---|----------------------------------|------------------------------|---------------------------------|------------------------------|---------------------------------|------------------------------|---------------------------------|------------------------------|---------------------------------|------------------------------|----------------------------------|------------------------------|---------------------------------|------------------------------|---------------------------------|---|---------------------------------|-----------------------------------|------------------------------------|----------------------------------|--------|--|--|--|--|--|--|--|--|--|
| Jerry Lumpe, L (1, 4)<br>OBP: 0.301, SLG: 0.339    | 4-0<br>FC4<br>1B<br>BB  | 0-0<br>4-3                       |                              | 0-0<br>FC4-2<br>1B              |                              | 0-0<br>HR<br>1B                 | 0-0<br>4-3                   |                                 |                              | 4                               | 2                            | 2                                | 0                            | 1                               | 0                            | 0                               |   |                                 |                                   |                                    |                                  |        |  |  |  |  |  |  |  |  |  |
| Gates Brown, L (1, 7)<br>OBP: 0.357, SLG: 0.592    | 0-3<br>K  | 0-0<br>HR                        |                              | 0-0<br>FC4-2                    |                              | 0-0<br>HR                       |                              | 0-0<br>F7                       |                              | 5                               | 2                            | 2                                | 3                            | 0                               | 1                            | 3                               |   |                                 |                                   |                                    |                                  |        |  |  |  |  |  |  |  |  |  |
| Al Kaline, R (1, 9)<br>OBP: 0.394, SLG: 0.446      | 0-0<br>FC4<br>1B  | 0-0<br>L8                        |                              | 0-0<br>L8                       |                              | 4-0<br>G6-4-3<br>S<br>BB        |                              | 0-0<br>L5-3                     |                              | 4                               | 0                            | 1                                | 0                            | 1                               | 0                            | 2                               |   |                                 |                                   |                                    |                                  |        |  |  |  |  |  |  |  |  |  |
| Norm Cash, L (1, 3)<br>OBP: 0.309, SLG: 0.382      | 0-0<br>FC4<br>1B  |                                  | 0-0<br>3-1                   |                                 | 0-0<br>6-3                   | 4-0<br>G6-4-3<br>BB             |                              | 0-0<br>6-3                      |                              | 4                               | 1                            | 0                                | 0                            | 1                               | 0                            | 1                               |   |                                 |                                   |                                    |                                  |        |  |  |  |  |  |  |  |  |  |
| Bill Freehan, R (1, 2)<br>OBP: 0.340, SLG: 0.497   | 0-0<br>1B<br>1B   |                                  | 0-0<br>1-3                   |                                 | 0-0<br>L5                    | 0-0<br>G6-4-3                   |                              | 0-0<br>6-3                      |                              | 5                               | 1                            | 1                                | 0                            | 0                               | 0                            | 2                               |   |                                 |                                   |                                    |                                  |        |  |  |  |  |  |  |  |  |  |
| Don Demeter, R (1, 8)<br>OBP: 0.291, SLG: 0.419    | 0-0<br>1B<br>1B   |                                  | 0-3<br>K                     |                                 | 0-0<br>1B<br>2B              | 0-3<br>K                        |                              | 0-0<br>1B<br>1B                 |                              | 5                               | 1                            | 3                                | 1                            | 0                               | 2                            | 1                               |   |                                 |                                   |                                    |                                  |        |  |  |  |  |  |  |  |  |  |
| Dick McAuliffe, L (1, 6)<br>OBP: 0.355, SLG: 0.495 | 0-0<br>1-3<br>3-H<br>1B   |                                  |                              | 0-0<br>6-3                      |                              | 0-0<br>1B<br>1B                 |                              | 0-0<br>HR                       |                              | 5                               | 1                            | 3                                | 3                            | 0                               | 0                            | 1                               |   |                                 |                                   |                                    |                                  |        |  |  |  |  |  |  |  |  |  |
| Don Wert, R (1, 5)<br>OBP: 0.311, SLG: 0.350       | 0-0<br>F9   |                                  |                              | 0-0<br>HR                       |                              | 0-0<br>1B                       |                              | 0-0<br>F6                       |                              | 5                               | 1                            | 3                                | 1                            | 0                               | 0                            | 2                               |   |                                 |                                   |                                    |                                  |        |  |  |  |  |  |  |  |  |  |
| Ed Rakow, S (1, 1)<br>Larry Sherry, R (4, 1)       |   | 0-0<br>5-3                       |                              | 4-0<br>1B<br>FC4-2<br>BB        |                              | 0-3<br>K                        |                              | 0-0<br>F4                       |                              | 1                               | 0                            | 0                                | 0                            | 1                               | 0                            | 0                               |   |                                 |                                   |                                    |                                  |        |  |  |  |  |  |  |  |  |  |
|  |   |                                  |                              |                                 |                              |                                 |                              |                                 |                              | 3                               | 0                            | 0                                | 0                            | 0                               | 1                            | 4                               |   |                                 |                                   |                                    |                                  |        |  |  |  |  |  |  |  |  |  |
| <b>Inning Stats</b>                                | R: 3<br>E: 1<br>K: 1<br>S: 9  | H: 4<br>LOB: 2<br>BB: 1<br>P: 13 | R: 1<br>E: 0<br>K: 0<br>S: 4 | H: 1<br>LOB: 0<br>BB: 0<br>P: 4 | R: 0<br>E: 0<br>K: 1<br>S: 5 | H: 0<br>LOB: 0<br>BB: 0<br>P: 5 | R: 1<br>E: 0<br>K: 0<br>S: 5 | H: 2<br>LOB: 2<br>BB: 1<br>P: 9 | R: 1<br>E: 0<br>K: 1<br>S: 8 | H: 3<br>LOB: 2<br>BB: 0<br>P: 8 | R: 2<br>E: 0<br>K: 1<br>S: 6 | H: 2<br>LOB: 1<br>BB: 2<br>P: 14 | R: 1<br>E: 0<br>K: 0<br>S: 4 | H: 1<br>LOB: 0<br>BB: 0<br>P: 4 | R: 0<br>E: 0<br>K: 0<br>S: 3 | H: 0<br>LOB: 0<br>BB: 0<br>P: 3 | R: 0<br>E: 0<br>K: 0<br>S: 5  | H: 2<br>LOB: 2<br>BB: 0<br>P: 5 | 1B: 10<br>2B: 1<br>3B: 0<br>HR: 4 | SF: 0<br>SAC: 0<br>DP: 1<br>HBP: 0 | WP: 0<br>PB: 0<br>SB: 1<br>CS: 0 | PA: 45 |  |  |  |  |  |  |  |  |  |
| <b>PITCHER</b>                                     | IP<br>WLS<br>BF<br>H<br>R<br>ER<br>SO<br>BB<br>IBB<br>HBP<br>BLK<br>WP<br>HR<br>S<br>P<br>ERA<br>WHIP |                                  |                              |                                 |                              |                                 |                              |                                 |                              |                                 |                              |                                  |                              |                                 |                              | <b>PITCHER</b>                  | IP<br>WLS<br>BF<br>H<br>R<br>ER<br>SO<br>BB<br>IBB<br>HBP<br>BLK<br>WP<br>HR<br>S<br>P<br>ERA<br>WHIP |                                 |                                   |                                    |                                  |        |  |  |  |  |  |  |  |  |  |
| Diego Segui, R (1, 1)<br>ERA: 4.19                 | 3.1   |                                  | 19                           | 7                               | 5                            | 2                               | 2                            | 2                               | 0                            | 0                               | 0                            | 0                                | 2                            | 21                              | 29                           | 5.40                            | 2.700   |                                 |                                   |                                    |                                  |        |  |  |  |  |  |  |  |  |  |
| Dan Pfister, R (4, 1)<br>ERA: 7.23                 | 1.1   | L                                | 7                            | 3                               | 1                            | 1                               | 0                            | 0                               | 0                            | 0                               | 0                            | 0                                | 0                            | 7                               | 7                            | 6.75                            | 2.250   |                                 |                                   |                                    |                                  |        |  |  |  |  |  |  |  |  |  |
| John Wyatt, R (5, 1)<br>ERA: 2.63                  | 3.1   |                                  | 14                           | 3                               | 3                            | 3                               | 2                            | 2                               | 0                            | 0                               | 0                            | 0                                | 2                            | 16                              | 24                           | 8.10                            | 1.500   |                                 |                                   |                                    |                                  |        |  |  |  |  |  |  |  |  |  |
| Joe Grzenda, L (9, 1)<br>ERA: 5.71                 | 1.0   |                                  | 5                            | 2                               | 0                            | 0                               | 0                            | 0                               | 0                            | 0                               | 0                            | 0                                | 0                            | 5                               | 5                            | 0.00                            | 2.000   |                                 |                                   |                                    |                                  |        |  |  |  |  |  |  |  |  |  |

**Detroit Tigers @ Kansas City Athletics**  
**Municipal Stadium, Kansas City, MO**  
 Wed Jun 24 1964, 8:05 PM EDT  
 Att. 8,411 - Unknown

|     |    |
|-----|----|
| AB  | 41 |
| R   | 9  |
| H   | 15 |
| RBI | 8  |
| BB  | 4  |
| SO  | 4  |
| LOB | 16 |



livebaseballscorecards.com

| Batter   | 1                     | 2         | 3         | 4        | 5   | 6          | 7  | 8          | 9         | AB R H RBI BB SO LOB  |
|--|-----------------------|-----------|-----------|----------|-----|------------|----|------------|-----------|---|
| Wayne Causey, L (1, 6)<br>OBP: 0.423, SLG: 0.424   | 4-0<br>BB<br>G6-4-3   |           |           | 1B<br>E  |     |            | L8 |            | 1B<br>1-3 | 3 1 2 0 2 0 0   |
| George Williams, R (1, 4)<br>OBP: 0.159, SLG: 0.098<br>George Alusik, R (9, PH)<br>OBP: 0.358, SLG: 0.341  | 0-3<br>K              |           |           | 1B<br>HR |     |            | L9 |            | L7        | 4 1 1 0 0 1 4<br>1 0 0 0 0 0 2  |
| Ed Charles, R (1, 5)<br>OBP: 0.344, SLG: 0.408   | 0-0<br>G6-4-3<br>1-2f |           |           | 1B<br>HR | K   |            | L9 |            |           | 4 1 1 0 0 1 1   |
| Rocky Colavito, R (1, 9)<br>OBP: 0.375, SLG: 0.529   |                       | 0-0<br>F5 |           | 1B<br>HR | K   |            |    | 0-0<br>5-3 |           | 4 1 1 3 0 1 0   |
| Jim Gentile, L (1, 3)<br>OBP: 0.419, SLG: 0.541  |                       | 0-0<br>F8 |           | 1B<br>E  | HBP |            |    | 0-3<br>K   |           | 2 1 0 0 1 1 0   |
| Billy Bryan, L (1, 2)<br>OBP: 0.351, SLG: 0.642  |                       | 0-0<br>F8 |           | 1B<br>E  | K   |            |    | 0-0<br>F5  |           | 4 0 1 0 0 1 1   |
| Manny Jimenez, L (1, 7)<br>OBP: 0.284, SLG: 0.463<br>Dick Green, R (9, PR)<br>OBP: 0.258, SLG: 0.336   |                       |           | 0-3<br>K  | 1B<br>F7 |     | 0-0<br>L7  |    |            | 1B<br>FC6 | 4 0 1 0 0 1 2<br>0 0 0 0 0 0 0  |
| Nelson Mathews, R (1, 8)<br>OBP: 0.300, SLG: 0.359   |                       |           | 0-0<br>L8 | 1B<br>K  |     | 0-0<br>5-3 |    |            | L9        | 4 0 0 0 0 1 3   |
| Diego Segui, R (1, 1)<br>OBP: 0.237, SLG: 0.306<br>Dan Pfister, R (4, 1)<br>John Wyatt, R (5, 1)<br>Joe Grzenda, R (9, 1)<br>Jose Tartabull, L (9, PH)<br>OBP: 0.150, SLG: 0.200 |                       |           | 0-0<br>L9 | 1B<br>E1 |     | 0-3<br>K   |    |            | 1B<br>FC6 | 1 0 0 0 0 0 0<br>1 0 0 0 0 0 1<br>1 0 0 0 0 1 0<br>0 0 0 0 0 0 0<br>1 0 0 0 0 0 1 |

| Inning Stats | R: 0<br>E: 0<br>K: 1<br>S: 4 | H: 0<br>LOB: 0<br>BB: 1<br>P: 8 | R: 0<br>E: 0<br>K: 0<br>S: 3 | H: 0<br>LOB: 0<br>BB: 0<br>P: 3 | R: 0<br>E: 0<br>K: 1<br>S: 5 | H: 0<br>LOB: 0<br>BB: 0<br>P: 5 | R: 5<br>E: 2<br>K: 1<br>S: 11 | H: 5<br>LOB: 3<br>BB: 2<br>P: 19 | R: 0<br>E: 0<br>K: 3<br>S: 9 | H: 0<br>LOB: 1<br>BB: 0<br>P: 10 | R: 0<br>E: 0<br>K: 1<br>S: 5 | H: 0<br>LOB: 0<br>BB: 0<br>P: 5 | R: 0<br>E: 0<br>K: 0<br>S: 3 | H: 0<br>LOB: 0<br>BB: 0<br>P: 3 | R: 0<br>E: 0<br>K: 1<br>S: 5 | H: 2<br>LOB: 2<br>BB: 0<br>P: 5 | 1B: 6<br>2B: 0<br>3B: 0<br>HR: 1 | SF: 0<br>SAC: 0<br>DP: 1<br>HBP: 1 |
|--------------|------------------------------|---------------------------------|------------------------------|---------------------------------|------------------------------|---------------------------------|-------------------------------|----------------------------------|------------------------------|----------------------------------|------------------------------|---------------------------------|------------------------------|---------------------------------|------------------------------|---------------------------------|----------------------------------|------------------------------------|
|--------------|------------------------------|---------------------------------|------------------------------|---------------------------------|------------------------------|---------------------------------|-------------------------------|----------------------------------|------------------------------|----------------------------------|------------------------------|---------------------------------|------------------------------|---------------------------------|------------------------------|---------------------------------|----------------------------------|------------------------------------|

| PITCHER                             | IP  | WLS | BF | H | R | ER | SO | BB | IBB | HBP | BLK | WP | HR | S  | P  | ERA   | WHIP  |
|-------------------------------------|-----|-----|----|---|---|----|----|----|-----|-----|-----|----|----|----|----|-------|-------|
| Ed Rakow, R (1, 1)<br>ERA: 3.91     | 3.0 |     | 15 | 5 | 5 | 4  | 2  | 2  | 0   | 0   | 0   | 0  | 1  | 17 | 25 | 12.00 | 2.333 |
| Larry Sherry, R (4, 1)<br>ERA: 3.63 | 6.0 | W   | 23 | 2 | 0 | 0  | 6  | 1  | 0   | 1   | 0   | 0  | 0  | 33 | 38 | 0.00  | 0.500 |

**BOTTOM**

**Detroit Tigers @ Kansas City Athletics**  
**Municipal Stadium, Kansas City, MO**  
 Wed Jun 24 1964, 8:05 PM EDT  
 Att: 8,411 - Unknown

|     |    |
|-----|----|
| AB  | 34 |
| R   | 5  |
| H   | 7  |
| RBI | 3  |
| BB  | 3  |
| SO  | 8  |
| LOB | 15 |

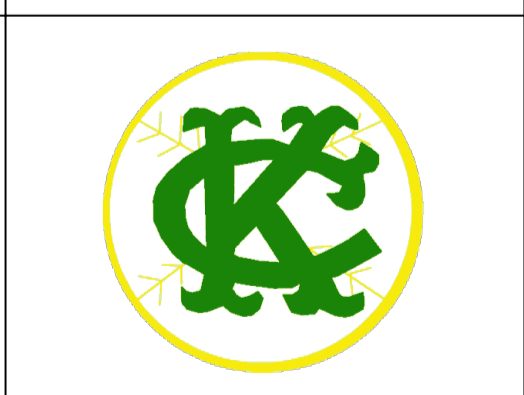

| WP    | PA |
|-------|----|
| 0     | 38 |
| PB: 0 |    |
| SB: 0 |    |
| CS: 0 |    |

livebaseballscores.com

| Batter  | 1   | 2                               | 3                            | 4                               | 5                            | 6                               | 7                            | 8                               | 9                            | AB R H RBI BB SO LOB             | TOP  |                                 |                              |                                 |                              |                                  |                              |                                 |                                  |                                    |                                  |        |
|---|---|---------------------------------|------------------------------|---------------------------------|------------------------------|---------------------------------|------------------------------|---------------------------------|------------------------------|----------------------------------|--|---------------------------------|------------------------------|---------------------------------|------------------------------|----------------------------------|------------------------------|---------------------------------|----------------------------------|------------------------------------|----------------------------------|--------|
| Wayne Causey, L (1, 6)<br>OBP: 0.419, SLG: 0.420    | 0-3<br>K  |                                 | 0-0<br>F7                    |                                 |                              | 0-0<br>2B<br>6-3<br>1B          | 0-0<br>4-3                   |                                 | 0-0<br>F8                    | 5 1 1 0 0 1 3                    | <p>Kansas City Athletics @ Los Angeles Angels</p> <p>Dodger Stadium, Los Angeles, CA</p> <p>Thu Jun 25 1964, 7:05 PM PDT</p> <p>Att. 4,610 - Unknown</p> <p>livebaseballscorecards.com</p> |                                 |                              |                                 |                              |                                  |                              |                                 |                                  |                                    |                                  |        |
| George Williams, R (1, 4)<br>OBP: 0.167, SLG: 0.133 | 0-0<br>5-3  |                                 |                              |                                 | 0-0<br>F8                    | 0-0<br>6-3<br>1B                | 0-0<br>6-3                   |                                 |                              | 4 1 1 0 0 0 1                    |  |                                 |                              |                                 |                              |                                  |                              |                                 |                                  |                                    |                                  |        |
| Ed Charles, R (1, 5)<br>OBP: 0.339, SLG: 0.402      | 0-0<br>6-3  |                                 |                              |                                 | 0-0<br>F9                    | 0-0<br>6-3                      |                              |                                 |                              | 4 0 0 1 0 1 1                    |  |                                 |                              |                                 |                              |                                  |                              |                                 |                                  |                                    |                                  |        |
| Rocky Colavito, R (1, 9)<br>OBP: 0.377, SLG: 0.526  |   | 0-0<br>F8                       |                              |                                 | 0-0<br>1-3                   | 0-0<br>FC4-6<br>1B              |                              | 0-3<br>K                        |                              | 3 0 1 1 1 0 0                    |  |                                 |                              |                                 |                              |                                  |                              |                                 |                                  |                                    |                                  |        |
| Jim Gentile, L (1, 3)<br>OBP: 0.416, SLG: 0.534     |   | 0-0<br>F8                       |                              |                                 | 0-0<br>G6-4-3<br>1B          | 0-0<br>FC4-6<br>1B              |                              | 0-3<br>K                        |                              | 4 0 1 0 0 1 2                    |  |                                 |                              |                                 |                              |                                  |                              |                                 |                                  |                                    |                                  |        |
| Billy Bryan, L (1, 2)<br>OBP: 0.372, SLG: 0.690     |   | 0-0<br>HR                       |                              |                                 | 0-0<br>G6-4-3<br>1B          | 0-0<br>1-2<br>1B                |                              | 0-0<br>FC3-6                    |                              | 4 1 3 1 0 0 1                    |  |                                 |                              |                                 |                              |                                  |                              |                                 |                                  |                                    |                                  |        |
| Manny Jimenez, L (1, 7)<br>OBP: 0.283, SLG: 0.446   |   | 0-0<br>4-3                      |                              |                                 | 0-0<br>G6-4-3<br>1-2f<br>2-3 | 0-0<br>1-3                      |                              |                                 | 4-0<br>S<br>BB               | 3 0 0 0 1 0 4                    |  |                                 |                              |                                 |                              |                                  |                              |                                 |                                  |                                    |                                  |        |
| Jose Tartabull, L (9, PR)<br>OBP: 0.150, SLG: 0.200 |   |                                 |                              |                                 |                              |                                 |                              |                                 | 0 0 0 0 0 0 0                | 0 0 0 0 0 0 0                    |  |                                 |                              |                                 |                              |                                  |                              |                                 |                                  |                                    |                                  |        |
| Nelson Mathews, R (1, 8)<br>OBP: 0.303, SLG: 0.359  |   |                                 | 0-0<br>5-3                   |                                 | 4-0<br>IBB                   |                                 | 0-0<br>4-3<br>SH3-4<br>1B    |                                 | 0-3<br>K                     | 3 0 1 0 1 1 1                    |  |                                 |                              |                                 |                              |                                  |                              |                                 |                                  |                                    |                                  |        |
| Ted Bowsfield, R (1, 1)                             |   |                                 | 0-3<br>K                     |                                 | 0-3<br>K                     |                                 | 0-0<br>SH3-4                 |                                 | 0-0<br>5-3                   | 2 0 0 0 0 2 2                    |  |                                 |                              |                                 |                              |                                  |                              |                                 |                                  |                                    |                                  |        |
| Wes Stock, R (6, 1)<br>OBP: 0.167, SLG: 0.167       |   |                                 |                              |                                 |                              |                                 |                              |                                 |                              | 0 0 0 0 0 0 0                    |  |                                 |                              |                                 |                              |                                  |                              |                                 |                                  |                                    |                                  |        |
| George Alusik, R (9, PH)<br>OBP: 0.356, SLG: 0.339  |   |                                 |                              |                                 |                              |                                 |                              |                                 |                              | 1 0 0 0 0 0 2                    |  |                                 |                              |                                 |                              |                                  |                              |                                 |                                  |                                    |                                  |        |
| <b>Inning Stats</b>                                 | R: 0<br>E: 0<br>K: 1<br>S: 5                          | H: 0<br>LOB: 0<br>BB: 0<br>P: 5 | R: 1<br>E: 0<br>K: 0<br>S: 4 | H: 1<br>LOB: 0<br>BB: 0<br>P: 4 | R: 0<br>E: 0<br>K: 1<br>S: 5 | H: 0<br>LOB: 0<br>BB: 0<br>P: 5 | R: 0<br>E: 0<br>K: 0<br>S: 3 | H: 0<br>LOB: 0<br>BB: 0<br>P: 3 | R: 0<br>E: 0<br>K: 1<br>S: 6 | H: 2<br>LOB: 2<br>BB: 1<br>P: 10 | R: 2<br>E: 0<br>K: 0<br>S: 7   | H: 4<br>LOB: 2<br>BB: 0<br>P: 7 | R: 0<br>E: 0<br>K: 0<br>S: 4 | H: 1<br>LOB: 1<br>BB: 0<br>P: 4 | R: 0<br>E: 0<br>K: 2<br>S: 7 | H: 0<br>LOB: 1<br>BB: 1<br>P: 11 | R: 0<br>E: 0<br>K: 1<br>S: 5 | H: 0<br>LOB: 2<br>BB: 1<br>P: 9 | 1B: 6<br>2B: 1<br>3B: 0<br>HR: 1 | SF: 0<br>SAC: 1<br>DP: 1<br>HBP: 0 | WP: 0<br>PB: 0<br>SB: 1<br>CS: 0 | PA: 37 |
| <b>PITCHER</b>                                      | IP WLS BF H R ER SO BB IBB HBP BLK WP HR S P ERA WHIP |                                 |                              |                                 |                              |                                 |                              |                                 |                              |                                  |  |                                 |                              |                                 |                              |                                  |                              |                                 |                                  |                                    |                                  |        |
| Fred Newman, R (1, 1)<br>ERA: 2.82                  | 6.0 W 25 7 3 3 3 0 1 0 0 0 1 30 34 4.50 1.167         |                                 |                              |                                 |                              |                                 |                              |                                 |                              |                                  |  |                                 |                              |                                 |                              |                                  |                              |                                 |                                  |                                    |                                  |        |
| Dan Osinski, R (7, 1)<br>ERA: 4.27                  | 3.0 S 12 1 0 0 3 2 0 0 0 0 0 0 16 24 0.00 1.000       |                                 |                              |                                 |                              |                                 |                              |                                 |                              |                                  |  |                                 |                              |                                 |                              |                                  |                              |                                 |                                  |                                    |                                  |        |

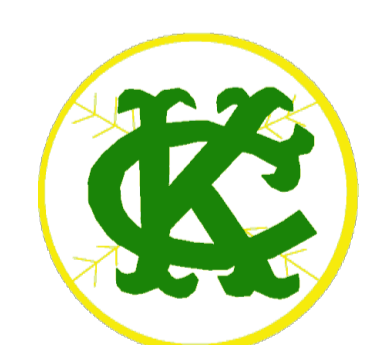



| Batter   | 1          | 2                 | 3         | 4         | 5                     | 6                      | 7         | 8          | 9 |
|--|------------|-------------------|-----------|-----------|-----------------------|------------------------|-----------|------------|---|
| <b>Jim Piersall, R</b><br>OBP: 0.436, SLG: 0.479 (1, 7)  | 0-0<br>6-3 |                   | 0-0<br>1B |           | 0-0<br>2B 1B          |                        | 0-3<br>K  |            |   |
| <b>Vic Power, R</b><br>OBP: 0.275, SLG: 0.326 (1, 5)<br>(7, 3)   | 0-0<br>G3  |                   | 0-0<br>F4 |           | 0-0<br>2B             |                        | 0-0<br>F6 |            |   |
| <b>Jim Fregosi, R</b><br>OBP: 0.396, SLG: 0.552 (1, 6)   | 0-0<br>6-3 |                   |           | 0-3<br>K  | 0-0<br>F3             |                        | 0-0<br>F8 |            |   |
| <b>Willie Smith, L</b><br>OBP: 0.339, SLG: 0.593 (1, 9)  |            | 0-0<br>5-3<br>1B  |           | 0-3<br>K  |                       | 0-0<br>3-1             |           | 0-0<br>F5  |   |
| <b>Bob Perry, R</b><br>OBP: 0.391, SLG: 0.450 (1, 8)   |            | 0-0<br>5-3<br>1-2 |           | 0-0<br>F8 |                       | 4-0<br>1B<br>BB        |           | 0-0<br>4-3 |   |
| <b>Joe Adcock, R</b><br>OBP: 0.337, SLG: 0.479 (1, 3)<br><b>Albie Pearson, L</b><br>OBP: 0.303, SLG: 0.267 (6, PR)<br><b>Dan Osinski, R</b><br>OBP: 0.125, SLG: 0.125 (7, 1) |            | 0-0<br>F8         |           |           | 0-0<br>5-3            | 0-0<br>1B<br>1-3<br>1B |           | 0-3<br>K   |   |
| <b>Buck Rodgers, S</b><br>OBP: 0.303, SLG: 0.289 (1, 2)  |            | 0-0<br>4-3        |           |           | 0-0<br>1B<br>E<br>1B  | 0-0<br>1-2<br>1B       |           |            |   |
| <b>Bobby Knoop, R</b><br>OBP: 0.297, SLG: 0.306 (1, 4)   |            |                   | 0-3<br>K  |           | 0-3<br>K              | 0-3<br>K               |           |            |   |
| <b>Fred Newman, R</b><br>OBP: 0.308, SLG: 0.217 (1, 1)<br><b>Tom Satriano, L</b><br>OBP: 0.327, SLG: 0.256 (6, PH)<br>(7, 5)   |            |                   | 0-0<br>F8 |           | 0-0<br>E8<br>1B<br>1B | 0-3<br>K               |           |            |   |

| Inning Stats | R: 0 | H: 0 | E: 0 | K: 0 | S: 3 | R: 0 | H: 1 | E: 0 | K: 0 | S: 4 | R: 0 | H: 1 | E: 0 | K: 1 | S: 6 | R: 0 | H: 0 | E: 0 | K: 2 | S: 7 | R: 3 | H: 4 | E: 1 | K: 1 | S: 9 | R: 1 | H: 2 | E: 0 | K: 2 | S: 9 | R: 0 | H: 0 | E: 0 | K: 1 | S: 5 | R: 0 | H: 0 | E: 0 | K: 1 | S: 5 |
|--------------|------|------|------|------|------|------|------|------|------|------|------|------|------|------|------|------|------|------|------|------|------|------|------|------|------|------|------|------|------|------|------|------|------|------|------|------|------|------|------|------|
|              | 0    | 0    | 0    | 0    | 3    | 0    | 1    | 0    | 0    | 4    | 0    | 0    | 0    | 1    | 6    | 0    | 0    | 0    | 2    | 7    | 1    | 2    | 0    | 1    | 9    | 0    | 2    | 0    | 2    | 13   | 0    | 0    | 0    | 1    | 5    | 0    | 0    | 0    | 1    | 5    |

|  |  |  |  |  |  |  |  |  |  | PITCHER  |     |    |   |   |    |    |    |     |     | PITCHER |    |    |   |    |     |      |       |  |  | PITCHER |  |  |  |  |  |  |    |     |    |   |   |    |    |    |     |     |     |    |    |   |   |     |      |   |   |   |   |
|--|--|--|--|--|--|--|--|--|--|--|-----|----|---|---|----|----|----|-----|-----|---------|----|----|---|----|-----|------|-------|--|--|---------|--|--|--|--|--|--|----|-----|----|---|---|----|----|----|-----|-----|-----|----|----|---|---|-----|------|---|---|---|---|
|  |  |  |  |  |  |  |  |  |  | IP   | WLS | BF | H | R | ER | SO | BB | IBB | HBP | BLK     | WP | HR | S | P  | ERA | WHIP |       |  |  |         |  |  |  |  |  |  | IP | WLS | BF | H | R | ER | SO | BB | IBB | HBP | BLK | WP | HR | S | P | ERA | WHIP |   |   |   |   |
|  |  |  |  |  |  |  |  |  |  | 5.1  | L   | 25 | 8 | 4 | 4  | 4  | 1  | 0   | 0   | 0       | 0  | 0  | 0 | 32 | 36  | 6.75 | 1.688 |  |  |         |  |  |  |  |  |  |    | 2.2 |    | 8 | 0 | 0  | 0  | 4  | 0   | 0   | 0   | 0  | 0  | 0 | 0 | 0   | 0    | 0 | 0 | 0 | 0 |
|  |  |  |  |  |  |  |  |  |  | <b>Ted Bowsfield, L</b><br>ERA: 4.57<br><b>Wes Stock, R</b><br>ERA: 3.58 |     |    |   |   |    |    |    |     |     |         |    |    |   |    |     |      |       |  |  |         |  |  |  |  |  |  |    |     |    |   |   |    |    |    |     |     |     |    |    |   |   |     |      |   |   |   |   |

**BOTTOM**

| AB | R | H | RBI | BB | SO | LOB |
|----|---|---|-----|----|----|-----|
| 4  | 1 | 2 | 1   | 0  | 1  | 0   |
| 4  | 0 | 1 | 1   | 0  | 0  | 1   |
| 4  | 0 | 0 | 0   | 0  | 1  | 1   |
| 4  | 0 | 1 | 0   | 0  | 1  | 0   |
| 3  | 1 | 0 | 0   | 1  | 0  | 1   |
| 3  | 0 | 1 | 0   | 0  | 0  | 1   |
| 0  | 0 | 0 | 0   | 0  | 0  | 0   |
| 1  | 0 | 0 | 0   | 0  | 1  | 0   |
| 3  | 1 | 2 | 1   | 0  | 0  | 1   |
| 3  | 0 | 0 | 0   | 0  | 3  | 3   |
| 2  | 1 | 1 | 0   | 0  | 0  | 0   |
| 1  | 0 | 0 | 0   | 0  | 1  | 2   |

|            |           |
|------------|-----------|
| <b>AB</b>  | <b>32</b> |
| <b>R</b>   | <b>4</b>  |
| <b>H</b>   | <b>8</b>  |
| <b>RBI</b> | <b>3</b>  |
| <b>BB</b>  | <b>1</b>  |
| <b>SO</b>  | <b>8</b>  |
| <b>LOB</b> | <b>10</b> |



|              |               |
|--------------|---------------|
| <b>WP:</b> 0 | <b>PA:</b> 33 |
| <b>PB:</b> 0 |               |
| <b>SB:</b> 0 |               |
| <b>CS:</b> 0 |               |

**Kansas City Athletics @ Los Angeles Angels**  
**Dodger Stadium, Los Angeles, CA**  
 Thu Jun 25 1964, 7:05 PM PDT  
 Att. 4,610 - Unknown

[livebaseballscorecards.com](http://livebaseballscorecards.com)

| Batter  | 1   | 2   | 3   | 4   | 5   | 6   | 7   | 8   | 9  | AB R H RBI BB SO LOB                                       | TOP  |                |   |
|---|---|---|---|---|---|---|---|---|--|--|--|----------------|---|
| Wayne Causey, L (1, 6)<br>OBP: 0.417, SLG: 0.417  | 0-0<br>G1-6-3<br>1B                                   |   | 0-0<br>F9   |   |   | 0-0<br>F9   |   | 0-0<br>F7   |  | 4 0 1 0 0 0 1  | <b>Kansas City Athletics @ Los Angeles Angels</b><br><b>Dodger Stadium, Los Angeles, CA</b><br>Fri Jun 26 1964, 7:05 PM PDT<br>Unknown<br><a href="http://livebaseballscorecards.com">livebaseballscorecards.com</a> |                |   |
| George Williams, R (1, 4)<br>OBP: 0.154, SLG: 0.122   | 0-3<br>K  |   | 0-0<br>F2   |   | 0-0<br>5-3  |   | 0-0<br>5-3  |   | 4 0 0 0 0 1 1  |  |  |                |   |
| Ed Charles, R (1, 5)<br>OBP: 0.338, SLG: 0.399  | 0-0<br>G1-6-3<br>1-2f                                 |   | 0-3<br>K  |   | 0-0<br>6-3  |   |   | 0-0<br>BB<br>1B                                     | 4 0 1 0 0 1 1  |  |  |                |   |
| Rocky Colavito, R (1, 9)<br>OBP: 0.379, SLG: 0.524  |   | 0-0<br>4-3  |   | 0-0<br>FC5-4<br>1B                                  |   | 0-0<br>F8   |   | 4-0<br>1-2<br>BB                                    | 3 0 1 0 1 0 0  |  |  |                |   |
| George Alusik, R (1, 7)<br>OBP: 0.346, SLG: 0.328   |   | 0-0<br>5-3  |   | 0-0<br>FC5-4<br>1-2f                                |   | 0-0<br>E5<br>1B                                     |   | 0-3<br>K  | 4 0 0 0 0 1 3  |  |  |                |   |
| Billy Bryan, L (1, 2)<br>OBP: 0.354, SLG: 0.653   |   | 0-3<br>K  |   | 0-0<br>4-3  |   | 0-3<br>K  |   | 0-0<br>F5   | 4 0 0 0 0 2 3  |  |  |                |   |
| Rick Joseph, R (1, 3)<br>OBP: 0.235, SLG: 0.250<br>Manny Jimenez, L (9, PH)<br>OBP: 0.280, SLG: 0.440                         |   |   | 0-0<br>F9   |   | 0-0<br>1B   |   | 0-0<br>1-2<br>1B                                    | 0-0<br>F8   | 3 0 2 0 0 0 0<br>1 0 0 0 0 0 2                       |  |  |                |   |
| Nelson Mathews, R (1, 8)<br>OBP: 0.303, SLG: 0.359  |   |   | 0-0<br>1B   |   | 0-0<br>L6   |   | 0-0<br>4-3  |   | 3 0 1 0 0 0 3  |  |  |                |   |
| Moe Drabowsky, R (1, 1)<br>OBP: 0.038, SLG: 0.038<br>Doc Edwards, R (8, PH)<br>OBP: 0.235, SLG: 0.250<br>John Wyatt, R (8, 1) |   |   | 0-3<br>K  |   | 0-0<br>F4   |   | 0-0<br>F8   |   | 2 0 0 0 0 1 2<br>1 0 0 0 0 0 0<br>0 0 0 0 0 0 0      |  |  |                |   |
| <b>Inning Stats</b>   | R: 0 H: 1<br>E: 0 LOB: 0<br>K: 1 BB: 0<br>S: 5 P: 5   | R: 0 H: 0<br>E: 0 LOB: 0<br>K: 1 BB: 0<br>S: 5 P: 5 | R: 0 H: 1<br>E: 0 LOB: 1<br>K: 1 BB: 0<br>S: 6 P: 6 | R: 0 H: 1<br>E: 0 LOB: 1<br>K: 1 BB: 0<br>S: 6 P: 6 | R: 0 H: 1<br>E: 0 LOB: 1<br>K: 0 BB: 0<br>S: 4 P: 4 | R: 0 H: 0<br>E: 0 LOB: 0<br>K: 0 BB: 0<br>S: 3 P: 3 | R: 0 H: 1<br>E: 1 LOB: 2<br>K: 1 BB: 0<br>S: 7 P: 7 | R: 0 H: 0<br>E: 0 LOB: 0<br>K: 0 BB: 0<br>S: 3 P: 3 | R: 0 H: 1<br>E: 0 LOB: 2<br>K: 1 BB: 1<br>S: 6 P: 10 | 1B: 6 SF: 0<br>2B: 0 SAC: 0<br>3B: 0 DP: 1<br>HR: 0 HBP: 0 | WP: 0 PA: 34<br>PB: 0<br>SB: 0<br>CS: 0  |                |   |
| <b>PITCHER</b>  | IP WLS BF H R ER SO BB IBB HBP BLK WP HR S P ERA WHIP |   |   |   |   |   |   |   |  |  |  | <b>PITCHER</b> | IP WLS BF H R ER SO BB IBB HBP BLK WP HR S P ERA WHIP |
| Bo Belinsky, L (1, 1)<br>ERA: 2.81  | 8.0 W 31 6 0 0 5 1 0 0 0 0 0 0 40 44 0.00 0.875       |   |   |   |   |   |   |   |  |  |  |                |   |
| Bob Duliba, R (9, 1)<br>ERA: 1.95   | 1.0 S 3 0 0 0 1 0 0 0 0 0 0 0 5 5 0.00 0.000          |   |   |   |   |   |   |   |  |  |  |                |   |

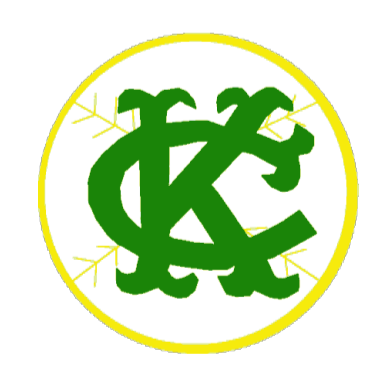

| Batter  | 1                     | 2          | 3                 | 4                     | 5                     | 6                | 7          | 8                         | 9 |
|---|-----------------------|------------|-------------------|-----------------------|-----------------------|------------------|------------|---------------------------|---|
| Lenny Green, L (1, 8)<br>OBP: 0.256, SLG: 0.135                         | 0-0<br>4-3            |            | 0-0<br>L1-3       |                       |                       | 0-0<br>3-1       |            | 0-0<br>S<br>1B            |   |
| Vic Power, R (1, 3)<br>OBP: 0.284, SLG: 0.333                           | 0-0<br>G5-4-3<br>1B   |            |                   | 0-0<br>G5-4-3<br>1B   |                       | 0-0<br>6-3       |            | 0-3<br>S<br>S<br>1-2<br>K |   |
| Jim Fregosi, R (1, 6)<br>OBP: 0.393, SLG: 0.543                         | 0-0<br>G5-4-3<br>1-2f |            |                   | 0-0<br>G5-4-3<br>1-2f |                       | 4-0<br>1B<br>BB  |            | 0-0<br>F7                 |   |
| Willie Smith, L (1, 9)<br>OBP: 0.339, SLG: 0.579                        |                       | 0-0<br>4-3 |                   | 0-0<br>F2             |                       | 0-0<br>1-3<br>1B |            |                           |   |
| Buck Rodgers, S (1, 2)<br>OBP: 0.304, SLG: 0.290                        |                       | 0-0<br>F9  |                   |                       | 0-0<br>E<br>SF8<br>1B |                  | 0-0<br>F8  |                           |   |
| Ed Kirkpatrick, L (1, 7)<br>OBP: 0.338, SLG: 0.394                      |                       | 4-0<br>BB  |                   |                       | 0-0<br>1-3<br>E4      |                  | 0-0<br>4-3 |                           |   |
| Tom Satriano, L (1, 5)<br>OBP: 0.320, SLG: 0.250                        |                       | 0-0<br>F8  |                   |                       | 0-0<br>L4             |                  | 0-0<br>F6  |                           |   |
| Bobby Knoop, R (1, 4)<br>OBP: 0.294, SLG: 0.304                         |                       |            | 0-0<br>F8         |                       | 0-0<br>SF8            |                  | 0-0<br>4-3 |                           |   |
| Bo Belinsky, L (1, 1)<br>OBP: 0.143, SLG: 0.115<br>Bob Duliba, R (9, 1) |                       |            | 4-0<br>L1-3<br>BB |                       | 0-0<br>3-H<br>6-3     |                  | 0-0<br>4-3 |                           |   |

| Inning Stats | R: 0 | H: 1 | E: 0 | LOB: 0 | K: 0 | S: 3 | P: 3 | R: 0 | H: 0 | E: 0 | LOB: 1 | K: 0 | S: 3 | P: 7 | R: 0 | H: 0 | E: 0 | LOB: 0 | K: 0 | S: 2 | P: 6 | R: 0 | H: 1 | E: 0 | LOB: 0 | K: 0 | S: 3 | P: 3 | R: 1 | H: 1 | E: 1 | LOB: 1 | K: 0 | S: 5 | P: 5 | R: 0 | H: 1 | E: 0 | LOB: 2 | K: 0 | S: 4 | P: 8 | R: 0 | H: 0 | E: 0 | LOB: 0 | K: 0 | S: 3 | P: 3 | R: 0 | H: 1 | E: 0 | LOB: 1 | K: 1 | S: 6 | P: 6 |
|--------------|------|------|------|--------|------|------|------|------|------|------|--------|------|------|------|------|------|------|--------|------|------|------|------|------|------|--------|------|------|------|------|------|------|--------|------|------|------|------|------|------|--------|------|------|------|------|------|------|--------|------|------|------|------|------|------|--------|------|------|------|
|--------------|------|------|------|--------|------|------|------|------|------|------|--------|------|------|------|------|------|------|--------|------|------|------|------|------|------|--------|------|------|------|------|------|------|--------|------|------|------|------|------|------|--------|------|------|------|------|------|------|--------|------|------|------|------|------|------|--------|------|------|------|

| PITCHER                              | IP  | WLS | BF | H | R | ER | SO | BB | IBB | HBP | BLK | WP | HR | S  | P  | ERA  | WHIP  |
|--------------------------------------|-----|-----|----|---|---|----|----|----|-----|-----|-----|----|----|----|----|------|-------|
| Moe Drabowsky, R (1, 1)<br>ERA: 5.91 | 7.0 | L   | 26 | 4 | 1 | 0  | 0  | 3  | 0   | 0   | 0   | 0  | 0  | 23 | 35 | 0.00 | 1.000 |
| John Wyatt, R (8, 1)<br>ERA: 2.58    | 1.0 |     | 4  | 1 | 0 | 0  | 1  | 0  | 0   | 0   | 0   | 0  | 0  | 6  | 6  | 0.00 | 1.000 |

**BOTTOM**

| AB | R | H | RBI | BB | SO | LOB |
|----|---|---|-----|----|----|-----|
| 4  | 0 | 1 | 0   | 0  | 0  | 1   |
| 4  | 0 | 2 | 0   | 0  | 1  | 1   |
| 3  | 0 | 0 | 0   | 1  | 0  | 3   |
| 3  | 0 | 1 | 0   | 0  | 0  | 0   |
| 3  | 1 | 1 | 0   | 0  | 0  | 2   |
| 2  | 0 | 0 | 0   | 1  | 0  | 1   |
| 3  | 0 | 0 | 0   | 0  | 0  | 3   |
| 2  | 0 | 0 | 1   | 0  | 0  | 0   |
| 2  | 0 | 0 | 0   | 1  | 0  | 1   |
| 0  | 0 | 0 | 0   | 0  | 0  | 0   |

|            |           |
|------------|-----------|
| <b>AB</b>  | <b>26</b> |
| <b>R</b>   | <b>1</b>  |
| <b>H</b>   | <b>5</b>  |
| <b>RBI</b> | <b>1</b>  |
| <b>BB</b>  | <b>3</b>  |
| <b>SO</b>  | <b>1</b>  |
| <b>LOB</b> | <b>12</b> |



| WP | PA | 3B | DP | HR | S | P | ERA | WHIP |
|----|----|----|----|----|---|---|-----|------|
| 0  | 30 | 0  | 3  | 0  |   |   |     |      |

**Kansas City Athletics @ Los Angeles Angels**  
**Dodger Stadium, Los Angeles, CA**  
 Fri Jun 26 1964, 7:05 PM PDT  
 Unknown

[livebaseballscorecards.com](http://livebaseballscorecards.com)

| Batter  | 1   | 2   | 3   | 4   | 5   | 6   | 7   | 8  | 9   | AB R H RBI BB SO LOB                                       | TOP  |                |   |
|---|---|---|---|---|---|---|---|--|---|--|--|----------------|---|
| Wayne Causey, L (1, 6)<br>OBP: 0.418, SLG: 0.414    | 4-0<br>BB<br>BB                                       |   | 0-0<br>1-3  |   | 0-0<br>4-3  |   |   | 4-0<br>G6-4-3<br>BB<br>BB                            |   | 2 0 0 0 2 0 0  | <p>Kansas City Athletics @ Los Angeles Angels</p> <p>Dodger Stadium, Los Angeles, CA</p> <p>Fri Jun 26 1964, 7:05 PM PDT</p> <p>Att. 9,977 - Unknown</p> |                |   |
| George Williams, R (1, 4)<br>OBP: 0.179, SLG: 0.135 | 0-3<br>K  |   | 0-0<br>1B   |   | 0-0<br>L4   |   |   | 4-0<br>1-2<br>G6-4-3<br>BB                           |   | 3 0 1 0 1 1 1  |  |                |   |
| Ed Charles, R (1, 5)<br>OBP: 0.337, SLG: 0.397      | 0-0<br>F9   |   | 0-3<br>K  |   |   |   |   | 0-0<br>G6-4-3<br>1-2f<br>2-3                         |   | 4 0 1 0 0 1 4  |  |                |   |
| Rocky Colavito, R (1, 9)<br>OBP: 0.377, SLG: 0.517  | 4-0<br>1-2<br>BB                                      |   |   |   | 0-0<br>F6   |   |   | 0-0<br>G5-4-3<br>1B<br>1-2f                          |   | 3 0 0 0 1 0 2  |  |                |   |
| Rick Joseph, R (1, 3)<br>OBP: 0.286, SLG: 0.263     | 0-3<br>K  |   |   |   | 0-0<br>CS<br>1B                                     |   |   | 4-0<br>BB  |   | 3 0 1 0 1 1 2  |  |                |   |
| Doc Edwards, R (1, 2)<br>OBP: 0.238, SLG: 0.252     |   |   | 0-0<br>5-3  |   | 0-0<br>1B<br>1B                                     |   |   | 0-0<br>4-3   |   | 3 0 1 0 0 0 1  |  |                |   |
| Dave Duncan, R (8, 2)<br>OBP: 0.200, SLG: 0.200     |   |   |   |   | 1-2<br>1B   |   |   | 0-0<br>K   |   | 1 0 0 0 0 1 0  |  |                |   |
| Nelson Mathews, R (1, 8)<br>OBP: 0.302, SLG: 0.357  |   |   | 0-3<br>K  |   | 0-0<br>1-2<br>1B                                    |   |   | 0-0<br>F4  |   | 4 0 1 0 0 1 0  |  |                |   |
| Manny Jimenez, L (1, 7)<br>OBP: 0.271, SLG: 0.425   |   |   | 0-0<br>6-3  |   | 0-0<br>3-1  |   |   | 0-0<br>G3  |   | 3 0 0 0 0 0 2  |  |                |   |
| Orlando Pena, R (1, 1)<br>OBP: 0.140, SLG: 0.171    |   |   | 0-3<br>K  |   | 0-0<br>4-3  |   |   | 0-3<br>K   |   | 1 0 0 0 0 1 0  |  |                |   |
| Jose Tartabull, L (5, PH)<br>OBP: 0.143, SLG: 0.190 |   |   |   |   |   |   |   |  |   | 1 0 0 0 0 0 0  |  |                |   |
| Dan Pfister, R (5, 1)                               |   |   |   |   |   |   |   |  |   | 0 0 0 0 0 0 0  |  |                |   |
| Jose Santiago, R (6, 1)                             |   |   |   |   |   |   |   |  |   | 1 0 0 0 0 1 0  |  |                |   |
| <b>Inning Stats</b>                                 | R: 0 H: 0<br>E: 0 LOB: 2<br>K: 2 BB: 2<br>S: 7 P: 15  | R: 0 H: 0<br>E: 0 LOB: 0<br>K: 1 BB: 0<br>S: 5 P: 5 | R: 0 H: 1<br>E: 0 LOB: 1<br>K: 2 BB: 0<br>S: 8 P: 8 | R: 0 H: 3<br>E: 0 LOB: 2<br>K: 0 BB: 0<br>S: 5 P: 5 | R: 0 H: 0<br>E: 0 LOB: 0<br>K: 0 BB: 0<br>S: 3 P: 3 | R: 0 H: 1<br>E: 0 LOB: 1<br>K: 0 BB: 1<br>S: 3 P: 7 | R: 0 H: 0<br>E: 0 LOB: 0<br>K: 1 BB: 0<br>S: 5 P: 5 | R: 0 H: 0<br>E: 0 LOB: 1<br>K: 0 BB: 2<br>S: 2 P: 10 | R: 0 H: 0<br>E: 0 LOB: 0<br>K: 1 BB: 0<br>S: 5 P: 5 | 1B: 5 SF: 0<br>2B: 0 SAC: 0<br>3B: 0 DP: 2<br>HR: 0 HBP: 0 | WP: 0 PA: 34<br>PB: 0<br>SB: 0<br>CS: 1  |                |   |
| <b>PITCHER</b>                                      | IP WLS BF H R ER SO BB IBB HBP BLK WP HR S P ERA WHIP |   |   |   |   |   |   |  |   |  |  | <b>PITCHER</b> | IP WLS BF H R ER SO BB IBB HBP BLK WP HR S P ERA WHIP |
| Bob Meyer, L (1, 1)<br>ERA: 4.01                    | 6.0 W 24 5 0 0 5 3 0 0 0 0 0 0 31 43 0.00 1.333       |   |   |   |   |   |   |  |   |  |  |                |   |
| Bob Lee, R (7, 1)<br>ERA: 2.06                      | 3.0 S 10 0 0 0 2 2 0 0 0 0 0 0 12 20 0.00 0.667       |   |   |   |   |   |   |  |   |  |  |                |   |

livebaseballscorecards.com

AB 29  
R 0  
H 5  
RBI 0  
BB 5  
SO 7  
LOB 12



| Batter  | 1             | 2                | 3       | 4      | 5                 | 6                      | 7      | 8       | 9 |
|---|---------------|------------------|---------|--------|-------------------|------------------------|--------|---------|---|
| Lenny Green, L (1, 8)<br>OBP: 0.271, SLG: 0.125   | 0-0 F9        | 4-0 1B E BB      |         | 0-0 F7 |                   | 1-0 BB 1B BB HBP       |        | 0-0 4-3 |   |
| Vic Power, R (1, 3)<br>OBP: 0.290, SLG: 0.337   | 0-0 1-3       | 0-0 S 1B 1-3 2-H |         |        | 0-0 F8            | 0-0 BB BB 1B 1-2 2-3   |        | 0-0 G3  |   |
| Jim Fregosi, R (1, 6)<br>OBP: 0.407, SLG: 0.548   | 0-0 E 1B      | 4-0 1-3 BB 3-H   |         |        | 4-0 FC5-4 BB      | 4-0 BB BB 1-2 2-3 3-H  |        | 0-0 1B  |   |
| Willie Smith, L (1, 9)<br>OBP: 0.344, SLG: 0.557  | 0-0 E7 1B 1-H | 0-0 F5           |         |        | 0-0 FC5-4 1B 1-2f | 4-0 1-2 2-3 3-H BB 0-3 |        | 0-0 4-3 |   |
| Buck Rodgers, S (1, 2)<br>OBP: 0.307, SLG: 0.294  | 0-0 1B 3-H    |                  | 0-0 L5  |        | 0-0 1B 1-3        | 0-0 K                  |        |         |   |
| Ed Kirkpatrick, L (1, 7)<br>OBP: 0.332, SLG: 0.386  | 0-3 K         |                  | 0-0 6-3 |        | 0-0 F7            |                        | 0-0 F7 |         |   |
| Tom Satriano, L (1, 5)<br>OBP: 0.312, SLG: 0.242  |               | 0-0 F9           | 0-0 5-3 |        |                   | 0-0 4-3                | 0-3 K  |         |   |
| Bobby Knoop, R (1, 4)<br>OBP: 0.301, SLG: 0.311   |               | 0-0 SH5-3 1B     |         | 0-3 K  |                   | 0-0 CS 1B              | 0-0 1B |         |   |
| Bob Meyer, R (1, 1)<br>Felix Torres, R (6, PH)<br>Fred Newman, R (6, PR)<br>Bob Lee, R (7, 1) |               | 0-0 SH5-3 1-2    |         | 0-3 K  |                   | 4-0 1B BB HBP 1-2 BB   | 0-3 K  |         |   |

| Inning Stats | R: 2 | H: 3 | E: 1 | K: 1 | S: 8 | LOB: 1 | BB: 0 | P: 8  |
|--------------|------|------|------|------|------|--------|-------|-------|
|              | R: 2 | H: 2 | E: 0 | K: 0 | S: 5 | LOB: 2 | BB: 2 | P: 13 |
|              | R: 0 | H: 0 | E: 0 | K: 0 | S: 3 | LOB: 0 | BB: 0 | P: 3  |
|              | R: 0 | H: 0 | E: 0 | K: 2 | S: 7 | LOB: 0 | BB: 0 | P: 7  |
|              | R: 0 | H: 1 | E: 0 | K: 0 | S: 4 | LOB: 2 | BB: 1 | P: 8  |
|              | R: 2 | H: 2 | E: 0 | K: 1 | S: 6 | LOB: 3 | BB: 3 | P: 19 |
|              | R: 0 | H: 1 | E: 0 | K: 2 | S: 8 | LOB: 1 | BB: 0 | P: 8  |
|              | R: 0 | H: 1 | E: 0 | K: 0 | S: 4 | LOB: 1 | BB: 0 | P: 4  |

| PITCHER                             | IP  | WLS | BF | H | R | ER | SO | BB | IBB | HBP | BLK | WP | HR | S  | P  | ERA   | WHIP  |
|-------------------------------------|-----|-----|----|---|---|----|----|----|-----|-----|-----|----|----|----|----|-------|-------|
| Orlando Pena, R (1, 1)<br>ERA: 4.19 | 4.0 | L   | 19 | 5 | 4 | 2  | 3  | 2  | 0   | 0   | 0   | 0  | 0  | 23 | 31 | 4.50  | 1.750 |
| Dan Pfister, R (5, 1)<br>ERA: 7.52  | 1.2 |     | 12 | 3 | 2 | 2  | 0  | 4  | 0   | 1   | 0   | 0  | 0  | 7  | 24 | 10.80 | 4.200 |
| Jose Santiago, R (6, 1)<br>ERA: 4.7 | 2.1 |     | 9  | 2 | 0 | 0  | 3  | 0  | 0   | 0   | 0   | 0  | 0  | 15 | 15 | 0.00  | 0.857 |

**BOTTOM**

**Kansas City Athletics @ Los Angeles Angels**  
**Dodger Stadium, Los Angeles, CA**  
 Fri Jun 26 1964, 7:05 PM PDT  
 Att. 9,977 - Unknown

| AB | R | H | RBI | BB | SO | LOB |
|----|---|---|-----|----|----|-----|
| 3  | 2 | 0 | 0   | 1  | 0  | 0   |
| 5  | 0 | 2 | 1   | 0  | 0  | 0   |
| 2  | 1 | 2 | 1   | 3  | 0  | 0   |
| 4  | 1 | 1 | 2   | 1  | 0  | 4   |
| 4  | 0 | 2 | 1   | 0  | 1  | 3   |
| 4  | 0 | 0 | 0   | 0  | 1  | 3   |
| 4  | 0 | 0 | 0   | 0  | 1  | 0   |
| 4  | 1 | 3 | 0   | 0  | 1  | 0   |
| 1  | 0 | 0 | 0   | 0  | 1  | 0   |
| 0  | 0 | 0 | 0   | 1  | 0  | 0   |
| 0  | 1 | 0 | 0   | 0  | 0  | 0   |
| 1  | 0 | 0 | 0   | 0  | 1  | 1   |

| AB  | 32 |
|-----|----|
| R   | 6  |
| H   | 10 |
| RBI | 5  |
| BB  | 6  |
| SO  | 6  |
| LOB | 11 |



| WP | PA |
|----|----|
| 0  | 40 |
| PB | 0  |
| SB | 2  |
| CS | 1  |

| WP | PA | ERA | WHIP |
|----|----|-----|------|
| 0  | 40 |     |      |
| PB | 0  |     |      |
| SB | 2  |     |      |
| CS | 1  |     |      |

| Batter  | 1   | 2                               | 3                            | 4                               | 5                              | 6                               | 7                            | 8   | 9                            | AB R H RBI BB SO LOB             | TOP   |                                 |                              |                                 |                              |                                 |                               |                                  |                                  |                                    |   |        |
|---|---|---------------------------------|------------------------------|---------------------------------|--------------------------------|---------------------------------|------------------------------|---|------------------------------|----------------------------------|---|---------------------------------|------------------------------|---------------------------------|------------------------------|---------------------------------|-------------------------------|----------------------------------|----------------------------------|------------------------------------|---|--------|
| Wayne Causey, L (1, 6)<br>OBP: 0.412, SLG: 0.407    | 0-3<br>K  |                                 | 0-0<br>G6-4-3<br>1-2f        |                                 | 0-0<br>FC4<br>1-2f             |                                 |                              | 0-0<br>G3                                       | 0-3<br>K                     | 5 0 0 0 0 2 6                    | <p>Kansas City Athletics @ Los Angeles Angels</p> <p>Dodger Stadium, Los Angeles, CA</p> <p>Sat Jun 27 1964, 7:05 PM PDT</p> <p>Att: 17,745 - Unknown</p> |                                 |                              |                                 |                              |                                 |                               |                                  |                                  |                                    |   |        |
| Nelson Mathews, R (1, 8)<br>OBP: 0.298, SLG: 0.352  | 0-3<br>K  |                                 |                              | 0-3<br>K                        |                                | 0-0<br>E6<br>G6-4-3 BB          |                              | 0-0<br>5-3                                      |                              | 4 0 0 0 0 2 0                    |   |                                 |                              |                                 |                              |                                 |                               |                                  |                                  |                                    |   |        |
| Rocky Colavito, R (1, 9)<br>OBP: 0.375, SLG: 0.510  | 0-0<br>5-3  |                                 |                              | 0-0<br>F7                       |                                | 4-0<br>BB<br>1-2<br>G6-4-3 BB   |                              | 0-0<br>5-3                                      |                              | 3 0 0 0 1 0 0                    |   |                                 |                              |                                 |                              |                                 |                               |                                  |                                  |                                    |   |        |
| Manny Jimenez, L (1, 7)<br>OBP: 0.263, SLG: 0.411   |   | 0-0<br>4-3                      |                              | 0-0<br>F4                       |                                | 0-0<br>G6-4-3<br>1-2f<br>2-3    |                              | 4-0<br>BB<br>BB<br>BB<br>S<br>SH3-4<br>WP<br>BB |                              | 3 0 0 0 0 0 2<br>0 1 0 0 1 0 0   |   |                                 |                              |                                 |                              |                                 |                               |                                  |                                  |                                    |   |        |
| Jose Tartabull, L (8, 7)<br>OBP: 0.182, SLG: 0.190  |   |                                 |                              |                                 |                                |                                 |                              |   |                              |                                  |   |                                 |                              |                                 |                              |                                 |                               |                                  |                                  |                                    |   |        |
| Billy Bryan, L (1, 2)<br>OBP: 0.341, SLG: 0.628     | 0-3<br>K  |                                 |                              |                                 | 0-0<br>F3                      | 0-0<br>4-3                      |                              | 0-0<br>SH3-4<br>1-2                             |                              | 3 0 0 0 0 1 1                    |   |                                 |                              |                                 |                              |                                 |                               |                                  |                                  |                                    |   |        |
| Ed Charles, R (1, 5)<br>OBP: 0.342, SLG: 0.398      |   | 0-0<br>1B                       |                              |                                 | 0-3<br>K                       |                                 | 4-0<br>BB<br>S<br>BB         | 4-0<br>WP<br>S<br>IBB                           |                              | 2 0 1 0 2 1 0                    |   |                                 |                              |                                 |                              |                                 |                               |                                  |                                  |                                    |   |        |
| Rick Joseph, R (1, 3)<br>OBP: 0.280, SLG: 0.227     |   | 0-0<br>F7                       |                              |                                 | 4-0<br>1B<br>1B<br>BB          |                                 | 0-3<br>K<br>1-2              | 0-3<br>K<br>1-2<br>2-3                          |                              | 3 1 0 0 1 2 4                    |   |                                 |                              |                                 |                              |                                 |                               |                                  |                                  |                                    |   |        |
| George Williams, R (1, 4)<br>OBP: 0.217, SLG: 0.164 |   |                                 | 0-0<br>G6-4-3<br>1B          |                                 | 0-0<br>1B<br>1-2<br>1B         |                                 | 0-0<br>F8                    | 4-0<br>WP<br>IBB                                |                              | 3 0 2 0 1 0 1                    |   |                                 |                              |                                 |                              |                                 |                               |                                  |                                  |                                    |   |        |
| John O'Donoghue, R (1, 1)<br>OBP: 0.250, SLG: 0.357 |   |                                 | 0-3<br>K                     |                                 | 0-0<br>FC4<br>1B<br>1-3<br>2-H |                                 | 0-0<br>F2                    | 0-3<br>K<br>1-2<br>2-3<br>3-H                   |                              | 4 0 1 1 0 2 4<br>0 0 0 0 0 0 0   |   |                                 |                              |                                 |                              |                                 |                               |                                  |                                  |                                    |   |        |
| John Wyatt, R (9, 1)                                |   |                                 |                              |                                 |                                |                                 |                              |   |                              |                                  |   |                                 |                              |                                 |                              |                                 |                               |                                  |                                  |                                    |   |        |
| <b>Inning Stats</b>                                 | R: 0<br>E: 0<br>K: 2<br>S: 7  | H: 0<br>LOB: 0<br>BB: 0<br>P: 7 | R: 0<br>E: 0<br>K: 1<br>S: 6 | H: 1<br>LOB: 1<br>BB: 0<br>P: 6 | R: 0<br>E: 0<br>K: 1<br>S: 5   | H: 1<br>LOB: 0<br>BB: 0<br>P: 5 | R: 0<br>E: 0<br>K: 1<br>S: 5 | H: 0<br>LOB: 0<br>BB: 0<br>P: 5                 | R: 1<br>E: 0<br>K: 1<br>S: 7 | H: 2<br>LOB: 2<br>BB: 1<br>P: 11 | R: 0<br>E: 1<br>K: 0<br>S: 3  | H: 0<br>LOB: 1<br>BB: 1<br>P: 7 | R: 0<br>E: 0<br>K: 1<br>S: 5 | H: 0<br>LOB: 1<br>BB: 1<br>P: 9 | R: 0<br>E: 0<br>K: 0<br>S: 3 | H: 0<br>LOB: 0<br>BB: 0<br>P: 3 | R: 1<br>E: 0<br>K: 3<br>S: 10 | H: 0<br>LOB: 3<br>BB: 3<br>P: 22 | 1B: 4<br>2B: 0<br>3B: 0<br>HR: 0 | SF: 0<br>SAC: 1<br>DP: 2<br>HBP: 0 | WP: 1<br>PB: 0<br>SB: 3<br>CS: 0  | PA: 37 |
| <b>PITCHER</b>                                      | IP<br>WLS<br>BF<br>H<br>R<br>ER<br>SO<br>BB<br>IBB<br>HBP<br>BLK<br>WP<br>HR<br>S<br>P<br>ERA<br>WHIP |                                 |                              |                                 |                                |                                 |                              |   |                              |                                  |   |                                 |                              |                                 |                              |                                 |                               |                                  |                                  |                                    | IP<br>WLS<br>BF<br>H<br>R<br>ER<br>SO<br>BB<br>IBB<br>HBP<br>BLK<br>WP<br>HR<br>S<br>P<br>ERA<br>WHIP |        |
| Dean Chance, R (1, 1)<br>ERA: 1.85                  | 8.0<br>L<br>30<br>4<br>1<br>1<br>7<br>3<br>0<br>0<br>0<br>0<br>0<br>41<br>53<br>1.12<br>0.875         |                                 |                              |                                 |                                |                                 |                              |   |                              |                                  |   |                                 |                              |                                 |                              |                                 |                               |                                  |                                  |                                    |   |        |
| Dan Osinski, R (9, 1)<br>ERA: 4.37                  | 1.0<br>7<br>0<br>1<br>1<br>3<br>1<br>2<br>0<br>0<br>1<br>0<br>10<br>22<br>9.00<br>1.000               |                                 |                              |                                 |                                |                                 |                              |   |                              |                                  |   |                                 |                              |                                 |                              |                                 |                               |                                  |                                  |                                    |   |        |

livebaseballscorecards.com

|     |    |
|-----|----|
| AB  | 30 |
| R   | 2  |
| H   | 4  |
| RBI | 1  |
| BB  | 6  |
| SO  | 10 |
| LOB | 18 |



Batter 1 2 3 4 5 6 7 8 9 AB R H RBI BB SO LOB

|  |  |                   |                   |                |                |                |                  |                   |                |   |
|--|--|-------------------|-------------------|----------------|----------------|----------------|------------------|-------------------|----------------|---|
| <p><b>Jim Piersall, R</b> (1, 7)<br/>OBP: 0.427, SLG: 0.468</p> <p>0-3 K</p>   |  |                   | <p>0-3 K</p>      |                |                | <p>0-0 5-3</p> |                  |                   | <p>0-0 E</p>   | 4 1 1 0 0 2 2                                   |
| <p><b>Vic Power, R</b> (1, 5)<br/>OBP: 0.279, SLG: 0.323</p> <p>0-0 6-3</p>  |  |                   | <p>0-0 FC6-4</p>  |                |                | <p>0-0 F4</p>  |                  |                   | <p>0-0 1-3</p> | 4 0 0 0 0 0 3                                   |
| <p><b>Jim Fregosi, R</b> (1, 6)<br/>OBP: 0.409, SLG: 0.545</p> <p>0-0 F8</p>   |  |                   |                   | <p>0-3 K</p>   |                |                |                  | <p>0-0 SH1-4</p>  | <p>4-0 E</p>   | 3 0 1 0 1 1 0                                   |
| <p><b>Lou Clinton, R</b> (1, 9)<br/>OBP: 0.286, SLG: 0.363</p> <p><b>Willie Smith, L</b> (9, PH)<br/>OBP: 0.338, SLG: 0.548</p>  |  | <p>0-0 F9</p>     |                   | <p>0-0 5-3</p> |                |                | <p>0-0 SH1-4</p> | <p>0-0 F9</p>     | <p>0-0 BB</p>  | 2 0 0 0 0 0 0<br>1 0 0 0 0 0 2                  |
| <p><b>Joe Adcock, R</b> (1, 3)<br/>OBP: 0.335, SLG: 0.473</p> <p><b>Albie Pearson, L</b> (9, PR)<br/>OBP: 0.303, SLG: 0.267</p>  |  |                   | <p>0-0 G6-4-3</p> |                | <p>0-0 F9</p>  |                | <p>0-0 6-3</p>   | <p>0-0 E5</p>     | <p>1-3 2-H</p> | 4 0 1 0 0 0 2<br>0 0 0 0 0 0 0                  |
| <p><b>Bob Perry, R</b> (1, 8)<br/>OBP: 0.373, SLG: 0.429</p> <p><b>Lenny Green, L</b> (9, PH)<br/>OBP: 0.265, SLG: 0.122</p>   |  | <p>0-0 G6-4-3</p> |                   |                | <p>0-0 F7</p>  |                | <p>0-0 F9</p>    | <p>0-0 4-3</p>    | <p>0-0</p>     | 3 0 0 0 0 0 2<br>1 0 0 0 0 0 2                  |
| <p><b>Buck Rodgers, S</b> (1, 2)<br/>OBP: 0.307, SLG: 0.294</p>  |  |                   | <p>0-0 BB</p>     |                | <p>0-0 6-3</p> |                |                  | <p>0-0 F6</p>     |                | 3 0 1 0 0 0 0                                   |
| <p><b>Bobby Knoop, R</b> (1, 4)<br/>OBP: 0.305, SLG: 0.313</p>   |  |                   | <p>4-0 FC6-4</p>  |                | <p>0-0 L6</p>  |                |                  | <p>0-0 G4-6-3</p> |                | 2 0 1 0 1 0 0                                   |
| <p><b>Dean Chance, R</b> (1, 1)<br/>OBP: 0.097, SLG: 0.067</p> <p><b>Felix Torres, R</b> (8, PH)<br/>OBP: 0.267, SLG: 0.400</p> <p><b>Dan Osinski, R</b> (9, 1)<br/>OBP: 0.125, SLG: 0.125</p> |  |                   | <p>0-3 K</p>      |                |                | <p>0-3 K</p>   |                  | <p>0-0 G4-6-3</p> |                | 2 0 0 0 0 2 2<br>1 0 0 0 0 0 1<br>0 0 0 0 0 0 0 |

| Inning Stats | R: 0 | H: 0 | E: 0 | K: 1 | S: 5 | H: 0 | LOB: 0 | BB: 0 | P: 5 | R: 0 | H: 1 | E: 0 | K: 0 | S: 3 | R: 0 | H: 1 | E: 0 | K: 2 | S: 8 | R: 0 | H: 0 | E: 0 | K: 1 | S: 5 | R: 0 | H: 0 | E: 0 | K: 0 | S: 3 | R: 0 | H: 1 | E: 0 | K: 0 | S: 4 | R: 0 | H: 1 | E: 0 | K: 0 | S: 3 | R: 1 | H: 1 | E: 1 | K: 0 | S: 5 | 1B: 5 | 2B: 0 | 3B: 0 | HR: 0 | SF: 0 | SAC: 1 | DP: 2 | HBP: 0 | WP: 0 | PB: 0 | SB: 0 | CS: 0 | PA: 33 |
|--------------|------|------|------|------|------|------|--------|-------|------|------|------|------|------|------|------|------|------|------|------|------|------|------|------|------|------|------|------|------|------|------|------|------|------|------|------|------|------|------|------|------|------|------|------|------|-------|-------|-------|-------|-------|--------|-------|--------|-------|-------|-------|-------|--------|
|--------------|------|------|------|------|------|------|--------|-------|------|------|------|------|------|------|------|------|------|------|------|------|------|------|------|------|------|------|------|------|------|------|------|------|------|------|------|------|------|------|------|------|------|------|------|------|-------|-------|-------|-------|-------|--------|-------|--------|-------|-------|-------|-------|--------|

| PITCHER                                | IP  | WLS | BF | H | R | ER | SO | BB | IBB | HBP | BLK | WP | HR | S  | P  | ERA  | WHIP  |
|--|-----|-----|----|---|---|----|----|----|-----|-----|-----|----|----|----|----|------|-------|
| John O'Donoghue, L (1, 1)<br>ERA: 4.37 | 8.1 | W   | 30 | 5 | 1 | 0  | 5  | 2  | 0   | 0   | 0   | 0  | 0  | 38 | 46 | 0.00 | 0.840 |
| John Wyatt, R (9, 1)<br>ERA: 2.55      | 0.2 | S   | 3  | 0 | 0 | 0  | 0  | 0  | 0   | 0   | 0   | 0  | 0  | 3  | 3  | 0.00 | 0.000 |

**BOTTOM**

Kansas City Athletics @ Los Angeles Angels  
Dodger Stadium, Los Angeles, CA

Sat Jun 27 1964, 7:05 PM PDT  
Att. 17,745 - Unknown

|            |           |
|------------|-----------|
| <b>AB</b>  | <b>30</b> |
| <b>R</b>   | <b>1</b>  |
| <b>H</b>   | <b>5</b>  |
| <b>RBI</b> | <b>0</b>  |
| <b>BB</b>  | <b>2</b>  |
| <b>SO</b>  | <b>5</b>  |
| <b>LOB</b> | <b>16</b> |



| Batter  | 1   | 2                               | 3                            | 4                                | 5                            | 6                               | 7                            | 8                               | 9                            | AB R H RBI BB SO LOB            | TOP  |                                 |                              |                                 |                              |                                 |                                  |                                    |                                  |        |
|---|---|---------------------------------|------------------------------|----------------------------------|------------------------------|---------------------------------|------------------------------|---------------------------------|------------------------------|---------------------------------|--|---------------------------------|------------------------------|---------------------------------|------------------------------|---------------------------------|----------------------------------|------------------------------------|----------------------------------|--------|
| Wayne Causey, L (1, 6)<br>OBP: 0.407, SLG: 0.402    | 0-0<br>4-3  | 0-0<br>G3                       |                              |                                  | 0-0<br>4-3                   |                                 | 0-0<br>SF8                   |                                 |                              | 3 0 0 1 0 0 1                   | <p>Kansas City Athletics @ Los Angeles Angels</p> <p>Dodger Stadium, Los Angeles, CA</p> <p>Sun Jun 28 1964, 3:33 AM PDT</p> <p>Att. 6,133 - Unknown</p> |                                 |                              |                                 |                              |                                 |                                  |                                    |                                  |        |
| Nelson Mathews, R (1, 8)<br>OBP: 0.298, SLG: 0.361  | 0-0<br>E8<br>2B                                       |                                 | 0-0<br>HR                    |                                  | 0-0<br>F9                    |                                 | 0-0<br>G6-4-3                |                                 |                              | 4 2 1 1 0 0 1                   |  |                                 |                              |                                 |                              |                                 |                                  |                                    |                                  |        |
| Rocky Colavito, R (1, 9)<br>OBP: 0.373, SLG: 0.510  | 0-0<br>F6   |                                 | 0-0<br>4-3<br>2B             |                                  | 0-0<br>F8                    |                                 |                              | 0-0<br>6-3                      |                              | 4 0 1 0 0 0 1                   |  |                                 |                              |                                 |                              |                                 |                                  |                                    |                                  |        |
| Manny Jimenez, L (1, 7)<br>OBP: 0.272, SLG: 0.426   | 0-0<br>1-H<br>3B<br>2B                                |                                 | 0-0<br>4-3                   |                                  | 0-0<br>1B<br>1B              |                                 |                              | 0-3<br>K                        |                              | 4 1 2 1 0 1 1                   |  |                                 |                              |                                 |                              |                                 |                                  |                                    |                                  |        |
| Jose Tartabull, L (9, 7)<br>OBP: 0.182, SLG: 0.190  |   |                                 | 2-3                          |                                  |                              |                                 |                              |                                 |                              | 0 0 0 0 0 0 0                   |  |                                 |                              |                                 |                              |                                 |                                  |                                    |                                  |        |
| Billy Bryan, L (1, 2)<br>OBP: 0.348, SLG: 0.646     | 0-0<br>2-H<br>3B                                      |                                 | 0-0<br>G3                    |                                  | 0-0<br>1-2<br>1B             |                                 |                              | 0-0<br>3-1                      |                              | 4 0 2 1 0 0 1                   |  |                                 |                              |                                 |                              |                                 |                                  |                                    |                                  |        |
| Ed Charles, R (1, 5)<br>OBP: 0.338, SLG: 0.392      | 0-0<br>F9   |                                 | 0-3<br>K                     |                                  | 0-0<br>1-2<br>L1-3<br>1B     |                                 |                              | 0-0<br>F8                       |                              | 4 0 0 0 0 1 4                   |  |                                 |                              |                                 |                              |                                 |                                  |                                    |                                  |        |
| Rick Joseph, R (1, 3)<br>OBP: 0.241, SLG: 0.192     |   | 0-3<br>K                        |                              | 0-3<br>K                         |                              | 0-0<br>3-1                      |                              | 0-0<br>5-3                      |                              | 4 0 0 0 0 2 1                   |  |                                 |                              |                                 |                              |                                 |                                  |                                    |                                  |        |
| George Williams, R (1, 4)<br>OBP: 0.250, SLG: 0.193 |   | BB                              | 4-0<br>BB                    |                                  | 0-0<br>6-3                   |                                 | 0-0<br>SH<br>SF8<br>2B       |                                 | 4-0<br>BB                    | 2 1 1 0 2 0 0                   |  |                                 |                              |                                 |                              |                                 |                                  |                                    |                                  |        |
| Diego Segui, R (1, 1)<br>OBP: 0.220, SLG: 0.282     |   | BB                              | 0-3<br>K                     |                                  | 0-0<br>3-1                   |                                 | 0-0<br>SH<br>G6-4-3          |                                 | 0-3<br>K                     | 3 0 0 0 0 2 2                   |  |                                 |                              |                                 |                              |                                 |                                  |                                    |                                  |        |
| <b>Inning Stats</b>                                 | R: 2<br>E: 1<br>K: 0<br>S: 6                          | H: 2<br>LOB: 1<br>BB: 0<br>P: 6 | R: 0<br>E: 0<br>K: 2<br>S: 7 | H: 0<br>LOB: 1<br>BB: 1<br>P: 11 | R: 1<br>E: 0<br>K: 1<br>S: 7 | H: 2<br>LOB: 1<br>BB: 0<br>P: 7 | R: 0<br>E: 0<br>K: 1<br>S: 5 | H: 0<br>LOB: 0<br>BB: 0<br>P: 5 | R: 0<br>E: 0<br>K: 0<br>S: 4 | H: 2<br>LOB: 1<br>BB: 0<br>P: 4 | R: 1<br>E: 1<br>K: 0<br>S: 4   | H: 1<br>LOB: 0<br>BB: 0<br>P: 4 | R: 0<br>E: 0<br>K: 1<br>S: 5 | H: 0<br>LOB: 0<br>BB: 0<br>P: 5 | R: 0<br>E: 0<br>K: 1<br>S: 5 | H: 0<br>LOB: 1<br>BB: 1<br>P: 9 | 1B: 2<br>2B: 4<br>3B: 1<br>HR: 1 | SF: 1<br>SAC: 1<br>DP: 2<br>HBP: 0 | WP: 0<br>PB: 0<br>SB: 0<br>CS: 0 | PA: 36 |
| <b>PITCHER</b>                                      | IP WLS BF H R ER SO BB IBB HBP BLK WP HR S P ERA WHIP |                                 |                              |                                  |                              |                                 |                              |                                 |                              |                                 |  |                                 |                              |                                 |                              |                                 |                                  |                                    |                                  |        |
| Barry Latman, R (1, 1)<br>ERA: 3.84                 | 6.0 L 25 6 3 1 4 1 0 0 0 0 0 1 32 36 1.50 1.167       |                                 |                              |                                  |                              |                                 |                              |                                 |                              |                                 |  |                                 |                              |                                 |                              |                                 |                                  |                                    |                                  |        |
| Don Lee, R (7, 1)<br>ERA: 2.96                      | 2.0 7 1 1 1 1 0 0 0 0 0 0 0 9 9 4.50 0.500            |                                 |                              |                                  |                              |                                 |                              |                                 |                              |                                 |  |                                 |                              |                                 |                              |                                 |                                  |                                    |                                  |        |
| Bob Lee, R (9, 1)<br>ERA: 2.03                      | 1.0 4 0 0 0 1 1 0 0 0 0 0 0 5 9 0.00 1.000            |                                 |                              |                                  |                              |                                 |                              |                                 |                              |                                 |  |                                 |                              |                                 |                              |                                 |                                  |                                    |                                  |        |

livebaseballscorecards.com

|     |    |
|-----|----|
| AB  | 32 |
| R   | 4  |
| H   | 7  |
| RBI | 4  |
| BB  | 2  |
| SO  | 6  |
| LOB | 12 |





| Batter   | 1          | 2                   | 3         | 4           | 5                 | 6                     | 7 | 8                   | 9             | AB | R | H | RBI | BB | SO | LOB |
|--|------------|---------------------|-----------|-------------|-------------------|-----------------------|---|---------------------|---------------|----|---|---|-----|----|----|-----|
| Lenny Green, L<br>OBP: 0.245, SLG: 0.111<br>(1, 8)     | 0-3<br>K   |                     |           | 0-0<br>4-3  |                   | 0-0<br>L3             |   |                     | 0-0<br>F8     | 4  | 0 | 0 | 0   | 0  | 1  | 2   |
| Vic Power, R<br>OBP: 0.278, SLG: 0.320<br>(1, 3)       | 0-0<br>1-3 |                     |           | 0-0<br>L4   |                   | 0-0<br>F9             |   |                     | 0-0<br>1B     | 4  | 0 | 1 | 0   | 0  | 0  | 1   |
| Jim Fregosi, R<br>OBP: 0.406, SLG: 0.539<br>(1, 6)     | 0-0<br>F8  |                     |           | 0-0<br>E3   |                   |                       |   | 0-0<br>FC6-4<br>1B  | 0-0<br>F7     | 4  | 0 | 1 | 0   | 0  | 0  | 1   |
| Willie Smith, L<br>OBP: 0.319, SLG: 0.515<br>(1, 7)    |            | 0-0<br>F6           |           | 0-3<br>K2-3 |                   |                       |   | 0-0<br>F5           | 0-0<br>4-3    | 4  | 0 | 0 | 0   | 0  | 1  | 3   |
| Buck Rodgers, S<br>OBP: 0.307, SLG: 0.295<br>(1, 2)    |            | 0-0<br>G4-6-3<br>1B |           |             | 0-0<br>F9         |                       |   | 0-0<br>F3           |               | 3  | 0 | 1 | 0   | 0  | 0  | 1   |
| Lou Clinton, R<br>OBP: 0.286, SLG: 0.359<br>(1, 9)     |            | 0-0<br>G4-6-3       |           |             | 4-0<br>G4-3<br>BB |                       |   | 0-0<br>FC6-4        |               | 2  | 0 | 0 | 0   | 1  | 0  | 2   |
| Tom Satriano, L<br>OBP: 0.306, SLG: 0.237<br>(1, 5)    |            |                     | 0-3<br>K  |             | 0-0<br>G4-3       |                       |   | 0-0<br>1-3          |               | 3  | 0 | 0 | 0   | 0  | 1  | 1   |
| Bobby Knoop, R<br>OBP: 0.309, SLG: 0.314<br>(1, 4)     |            |                     | 0-0<br>F9 |             |                   | 0-0<br>PB<br>1B<br>1B |   | 4-0<br>G4-6-3<br>BB |               | 2  | 0 | 1 | 0   | 1  | 0  | 0   |
| Barry Latman, R<br>OBP: 0.136, SLG: 0.136<br>(1, 1)    |            |                     | 0-0<br>G3 |             |                   | 0-0<br>L3<br>1B       |   | 0-0<br>G4-6-3       |               | 1  | 0 | 0 | 0   | 0  | 0  | 0   |
| Albie Pearson, L<br>OBP: 0.307, SLG: 0.271<br>(6, PH)  |            |                     |           |             |                   |                       |   |                     | 0-0<br>G4-6-3 | 1  | 0 | 1 | 0   | 0  | 0  | 0   |
| Don Lee, R<br>OBP: 0.333, SLG: 0.250<br>(7, 1)         |            |                     |           |             |                   |                       |   |                     | 0-0<br>G4-6-3 | 0  | 0 | 0 | 0   | 0  | 0  | 0   |
| Ed Kirkpatrick, L<br>OBP: 0.330, SLG: 0.384<br>(8, PH) |            |                     |           |             |                   |                       |   |                     | 0-0<br>G4-6-3 | 1  | 0 | 0 | 0   | 0  | 0  | 1   |
| Bob Lee, R<br>(9, 1)                                   |            |                     |           |             |                   |                       |   |                     | 0-0<br>G4-6-3 | 0  | 0 | 0 | 0   | 0  | 0  | 0   |

| Inning Stats | R: 0 | H: 0   | R: 0 | H: 1   | R: 0 | H: 0   | R: 0 | H: 0   | R: 0 | H: 2   | R: 0 | H: 1   | R: 0 | H: 0   | R: 0 | H: 1   | 1B: 5 | SF: 0  | WP: 0 | PA: 31 |
|--------------|------|--------|------|--------|------|--------|------|--------|------|--------|------|--------|------|--------|------|--------|-------|--------|-------|--------|
|              | E: 0 | LOB: 0 | E: 0 | LOB: 0 | E: 0 | LOB: 0 | E: 0 | LOB: 0 | E: 0 | LOB: 1 | E: 0 | LOB: 1 | E: 0 | LOB: 0 | E: 0 | LOB: 1 | 2B: 1 | SAC: 0 | PB: 1 |        |
|              | K: 1 | BB: 0  | K: 0 | BB: 0  | K: 1 | BB: 0  | K: 0 | BB: 1  | K: 0 | BB: 0  | K: 0 | BB: 0  | K: 0 | BB: 1  | K: 0 | BB: 0  | 3B: 0 | DP: 4  | SB: 0 |        |
|              | S: 5 | P: 5   | S: 3 | P: 3   | S: 5 | P: 5   | S: 2 | P: 6   | S: 4 | P: 4   | S: 4 | P: 4   | S: 2 | P: 6   | S: 4 | P: 4   | HR: 0 | HBP: 0 | CS: 0 |        |

| PITCHER                               | IP  | WLS | BF | H | R | ER | SO | BB | IBB | HBP | BLK | WP | HR | S  | P  | ERA  | WHIP  | IP | WLS | BF | H | R | ER | SO | BB | IBB | HBP | BLK | WP | HR | S | P | ERA | WHIP |  |
|---------------------------------------|-----|-----|----|---|---|----|----|----|-----|-----|-----|----|----|----|----|------|-------|----|-----|----|---|---|----|----|----|-----|-----|-----|----|----|---|---|-----|------|--|
| Diego Segui, R<br>ERA: 3.86<br>(1, 1) | 9.0 | W   | 31 | 5 | 0 | 0  | 3  | 2  | 0   | 0   | 0   | 0  | 0  | 35 | 43 | 0.00 | 0.778 |    |     |    |   |   |    |    |    |     |     |     |    |    |   |   |     |      |  |

**BOTTOM**

**Kansas City Athletics @ Los Angeles Angels**  
**Dodger Stadium, Los Angeles, CA**  
 Sun Jun 28 1964, 3:33 AM PDT  
 Att. 6,133 - Unknown

livebaseballscorecards.com

|            |           |
|------------|-----------|
| <b>AB</b>  | <b>29</b> |
| <b>R</b>   | <b>0</b>  |
| <b>H</b>   | <b>5</b>  |
| <b>RBI</b> | <b>0</b>  |
| <b>BB</b>  | <b>2</b>  |
| <b>SO</b>  | <b>3</b>  |
| <b>LOB</b> | <b>12</b> |



| Batter   | 1   | 2  | 3   | 4   | 5   | 6  | 7  | 8   | 9   | AB R H RBI BB SO LOB   | TOP                                     |
|--|---|--|---|---|---|--|--|---|---|--|---|
| Wayne Causey, L (1, 6)<br>OBP: 0.407, SLG: 0.400                           | 4-0<br>1B<br>BB                                       |  | 0-0<br>F6   |   |   | 0-3<br>K   | 0-0<br>G4-6-3  |   | 0-0<br>1B   | 4 0 1 0 1 1 3  |   |
| Nelson Mathews, R (1, 8)<br>OBP: 0.303, SLG: 0.366                         | 0-0<br>1B   |  | 0-0<br>4-3  |   |   | 0-0<br>2B<br>SF8                                     | 0-0<br>HBP<br>BB                                     |   | 0-0<br>L9   | 5 1 3 1 0 0 2  |   |
| Rocky Colavito, R (1, 9)<br>OBP: 0.374, SLG: 0.510                         | 0-0<br>F3   |  |   |   |   | 0-0<br>SF8   | 4-0<br>HBP<br>BB                                     |   | 0-0<br>F3   | 4 0 1 0 1 0 3  |   |
| Manny Jimenez, L (1, 7)<br>Dick Green, R (7, PR)<br>John Wyatt, R (7, 1)   | 0-0<br>G4-6-3   |  |   |   |   | 0-0<br>FC6-4<br>1B                                   | 1-0<br>HBP   |   |   | 2 0 1 0 1 0 2<br>0 0 0 0 0 0 0<br>0 0 0 0 0 0 0                  |   |
| Billy Bryan, L (1, 2)<br>Doc Edwards, R (7, PH)                            |   |  |   |   |   | 0-0<br>K   | 0-0<br>SF8   |   | 0-0<br>F8   | 2 0 0 1 0 2 1<br>1 0 0 0 0 0 3                                   |   |
| Ed Charles, R (1, 5)   |   |  |   |   |   | 0-0<br>FC6-4   |  |   | 0-3<br>K  | 3 0 0 0 1 2 3  |   |
| George Alusik, R (1, 3)  |   |  |   |   |   | 0-3<br>K   |  |   | 0-0<br>K  | 3 1 1 0 1 2 1  |   |
| George Williams, R (1, 4)  |   |  |   |   |   | 0-0<br>F5  |  |   | 0-0<br>G6-4-3                                       | 4 1 2 0 0 0 1  |   |
| Ted Bowsfield, R (1, 1)  |   |  |   |   |   | 0-0<br>F2  |  |   | 0-3<br>K  | 1 0 0 0 0 0 1<br>1 0 0 0 0 0 0<br>0 0 0 0 0 0 0<br>2 0 1 0 0 1 0 |   |
| Jose Tartabull, L (5, PH)<br>Wes Stock, R (5, 1)<br>Rick Joseph, R (7, PH) |   |  |   |   |   | 0-0<br>6-3   |  |   |   |  |   |
| <b>Inning Stats</b>  | R: 0 H: 1<br>E: 0 LOB: 1<br>K: 0 BB: 1<br>S: 3 P: 7   | R: 0 H: 0<br>E: 0 LOB: 0<br>K: 2 BB: 1<br>S: 6 P: 10 | R: 0 H: 1<br>E: 0 LOB: 1<br>K: 0 BB: 0<br>S: 4 P: 4 | R: 0 H: 1<br>E: 0 LOB: 1<br>K: 1 BB: 0<br>S: 6 P: 6 | R: 0 H: 0<br>E: 0 LOB: 0<br>K: 1 BB: 0<br>S: 5 P: 5 | R: 1 H: 2<br>E: 0 LOB: 2<br>K: 2 BB: 1<br>S: 9 P: 13 | R: 2 H: 3<br>E: 0 LOB: 3<br>K: 0 BB: 2<br>S: 5 P: 14 | R: 0 H: 1<br>E: 0 LOB: 0<br>K: 1 BB: 0<br>S: 5 P: 5 | R: 0 H: 1<br>E: 0 LOB: 1<br>K: 1 BB: 0<br>S: 6 P: 6 | 1B: 8 SF: 1<br>2B: 2 SAC: 0<br>3B: 0 DP: 3<br>HR: 0 HBP: 1       | WP: 0 PA: 39<br>PB: 0<br>SB: 0<br>CS: 1 |
| <b>PITCHER</b>   | IP WLS BF H R ER SO BB IBB HBP BLK WP HR S P ERA WHIP |  |   |   |   |  |  |   |   |  |   |
| Earl Wilson, R (1, 1)<br>ERA: 4.64   | 6.0 W 27 7 3 3 6 4 0 0 0 0 0 0 35 51 4.50 1.833       |  |   |   |   |  |  |   |   |  |   |
| Arnold Earley, L (7, 1)<br>ERA: 2.1  | 0.2 4 1 0 0 0 1 0 1 0 0 0 0 2 7 0.00 3.000            |  |   |   |   |  |  |   |   |  |   |
| Dick Radatz, R (7, 1)<br>ERA: 1.62   | 2.1 S 8 2 0 0 2 0 0 0 0 0 0 0 12 12 0.00 0.857        |  |   |   |   |  |  |   |   |  |   |

**Kansas City Athletics @ Boston Red Sox**  
**Fenway Park, Boston, MA**  
 Mon Jun 29 1964, 7:05 PM EDT  
 Att. 21,096 - Unknown

|     |    |
|-----|----|
| AB  | 32 |
| R   | 3  |
| H   | 10 |
| RBI | 2  |
| BB  | 5  |
| SO  | 8  |
| LOB | 20 |



|       |        |
|-------|--------|
| WP: 0 | PA: 39 |
| PB: 0 |        |
| SB: 0 |        |
| CS: 1 |        |

| Batter   | 1                      | 2                      | 3                       | 4                    | 5                        | 6         | 7         | 8                        | 9 | AB | R | H | RBI | BB | SO | LOB |
|--|------------------------|------------------------|-------------------------|----------------------|--------------------------|-----------|-----------|--------------------------|---|----|---|---|-----|----|----|-----|
| Chuck Schilling, R<br>OBP: 0.269, SLG: 0.225<br>(1, 4)   | 0-0<br>5-3             | 0-0<br>SF8             |                         | 0-0<br>L8            |                          | 0-0<br>F8 |           |                          |   | 3  | 0 | 0 | 1   | 0  | 0  | 1   |
| Felix Mantilla, R<br>OBP: 0.368, SLG: 0.604<br>(1, 7)  | 0-0<br>4-3<br>WP<br>2B | 0-0<br>F8              |                         | 4-0<br>FC6-4<br>BB   |                          |           | 4-0<br>BB |                          |   | 2  | 1 | 1 | 0   | 2  | 0  | 1   |
| Carl Yastrzemski, L<br>OBP: 0.368, SLG: 0.458<br>(1, 8)  | 0-0<br>4-3<br>2-3      |                        | 0-0<br>4-3              | 0-0<br>FC6-4<br>1-2f |                          |           | 0-3<br>K  |                          |   | 4  | 0 | 0 | 0   | 0  | 1  | 3   |
| Dick Stuart, R<br>OBP: 0.309, SLG: 0.459<br>(1, 3)   | 4-0<br>1B<br>BB        |                        | 0-0<br>6-3              |                      | 0-0<br>F8                |           | 0-3<br>K  |                          |   | 3  | 0 | 0 | 0   | 1  | 1  | 1   |
| Frank Malzone, R<br>OBP: 0.342, SLG: 0.423<br>(1, 5)   | 0-0<br>1-2<br>1B       |                        | 0-0<br>BB<br>3B<br>1B   |                      | 4-0<br>BB<br>3-6-4<br>BB |           | 0-0<br>F7 |                          |   | 3  | 1 | 2 | 0   | 1  | 0  | 1   |
| Lee Thomas, L<br>OBP: 0.330, SLG: 0.380<br>(1, 9)  | 0-0<br>F9              |                        | 4-0<br>1-2<br>3B<br>BB  |                      | 0-0<br>4-3-6-4<br>1-2f   |           |           | 0-0<br>F8                |   | 3  | 1 | 0 | 0   | 1  | 0  | 3   |
| Eddie Bressoud, R<br>OBP: 0.371, SLG: 0.442<br>(1, 6)  |                        | 4-0<br>2B<br>SF8<br>BB | 0-0<br>1-H<br>2-H<br>3B |                      | 0-0<br>2B                |           |           | 4-0<br>BB<br>3-6-4<br>BB |   | 2  | 1 | 2 | 2   | 2  | 0  | 0   |
| Bob Tillman, R<br>OBP: 0.370, SLG: 0.433<br>(1, 2)   |                        | 0-0<br>1-3<br>2B       | 0-0<br>6-3              |                      | 0-0<br>F3                |           |           | 0-0<br>4-3-6-4<br>1-2f   |   | 4  | 0 | 1 | 0   | 0  | 0  | 3   |
| Earl Wilson, R<br>OBP: 0.324, SLG: 0.467<br>Arnold Earley, L<br>Dick Radatz, R<br>OBP: 0.250, SLG: 0.300<br>(1, 1)<br>(7, 1)<br>(7, 1) |                        | 0-3<br>K               |                         | 0-0<br>6-3           |                          | 0-3<br>K  |           |                          |   | 3  | 0 | 0 | 0   | 0  | 2  | 3   |

| Inning Stats | R: 1 | H: 2 | E: 0 | K: 0 | S: 5 | LOB: 2 | BB: 1 | P: 9 | R: 1 | H: 1 | E: 0 | K: 1 | S: 6 | LOB: 1 | BB: 1 | P: 10 | R: 2 | H: 2 | E: 0 | K: 0 | S: 5 | LOB: 1 | BB: 1 | P: 9 | R: 0 | H: 0 | E: 0 | K: 0 | S: 3 | LOB: 0 | BB: 1 | P: 6 | R: 0 | H: 1 | E: 0 | K: 1 | S: 6 | LOB: 1 | BB: 0 | P: 6 | R: 0 | H: 0 | E: 0 | K: 2 | S: 7 | LOB: 1 | BB: 1 | P: 11 | R: 0 | H: 0 | E: 0 | K: 0 | S: 2 | LOB: 0 | BB: 1 | P: 6 |
|--------------|------|------|------|------|------|--------|-------|------|------|------|------|------|------|--------|-------|-------|------|------|------|------|------|--------|-------|------|------|------|------|------|------|--------|-------|------|------|------|------|------|------|--------|-------|------|------|------|------|------|------|--------|-------|-------|------|------|------|------|------|--------|-------|------|
|--------------|------|------|------|------|------|--------|-------|------|------|------|------|------|------|--------|-------|-------|------|------|------|------|------|--------|-------|------|------|------|------|------|------|--------|-------|------|------|------|------|------|------|--------|-------|------|------|------|------|------|------|--------|-------|-------|------|------|------|------|------|--------|-------|------|

| PITCHER                                 | IP  | WLS | BF | H | R | ER | SO | BB | IBB | HBP | BLK | WP | HR | S  | P  | ERA  | WHIP  |
|---|-----|-----|----|---|---|----|----|----|-----|-----|-----|----|----|----|----|------|-------|
| Ted Bowsfield, L<br>ERA: 4.93<br>(1, 1) | 4.0 | L   | 21 | 5 | 4 | 4  | 1  | 4  | 0   | 0   | 0   | 1  | 0  | 19 | 35 | 9.00 | 2.250 |
| Wes Stock, R<br>ERA: 3.38<br>(5, 1)     | 2.0 |     | 7  | 1 | 0 | 0  | 1  | 1  | 0   | 0   | 0   | 0  | 0  | 8  | 12 | 0.00 | 1.000 |
| John Wyatt, R<br>ERA: 2.45<br>(7, 1)    | 2.0 |     | 7  | 0 | 0 | 0  | 2  | 2  | 0   | 0   | 0   | 0  | 0  | 9  | 17 | 0.00 | 1.000 |

**BOTTOM**

**Kansas City Athletics @ Boston Red Sox**  
 Fenway Park, Boston, MA  
 Mon Jun 29 1964, 7:05 PM EDT  
 Att. 21,096 - Unknown

|     |    |
|-----|----|
| AB  | 27 |
| R   | 4  |
| H   | 6  |
| RBI | 3  |
| BB  | 7  |
| SO  | 4  |
| LOB | 16 |



| 1B | 2B | 3B | HR | SF | SAC | DP | HBP | WP | HR | S | P | ERA  | WHIP  |
|----|----|----|----|----|-----|----|-----|----|----|---|---|------|-------|
| 2  | 5  | 1  | 0  | 1  | 2   | 0  | 0   | 1  | 0  | 0 | 0 | 9.00 | 2.250 |
| 0  | 0  | 0  | 0  | 0  | 0   | 0  | 0   | 0  | 0  | 0 | 0 | 0.00 | 1.000 |
| 0  | 0  | 0  | 0  | 0  | 0   | 0  | 0   | 0  | 0  | 0 | 0 | 0.00 | 1.000 |

| Batter  | 1   | 2                                | 3                            | 4                               | 5                            | 6                                | 7                            | 8                               | 9                            | AB R H RBI BB SO LOB            | TOP                          |                                 |                              |                                 |                              |                                 |                              |                                 |                                  |                                    |                                  |        |
|---|---|----------------------------------|------------------------------|---------------------------------|------------------------------|----------------------------------|------------------------------|---------------------------------|------------------------------|---------------------------------|------------------------------|---------------------------------|------------------------------|---------------------------------|------------------------------|---------------------------------|------------------------------|---------------------------------|----------------------------------|------------------------------------|----------------------------------|--------|
| Wayne Causey, L (1, 6)<br>OBP: 0.405, SLG: 0.398    | 0-0<br>1B<br>2B<br>1B                                 | 0-3<br>K                         |                              | 0-0<br>G3                       |                              |                                  | 0-0<br>F7                    |                                 |                              | 4 1 1 0 0 1 2                   |                              |                                 |                              |                                 |                              |                                 |                              |                                 |                                  |                                    |                                  |        |
| George Williams, R (1, 4)<br>OBP: 0.278, SLG: 0.277 | 0-3<br>K  |                                  | 0-0<br>2B                    |                                 | 0-0<br>4-3                   |                                  | 0-0<br>2B                    |                                 |                              | 4 0 2 0 0 1 1                   |                              |                                 |                              |                                 |                              |                                 |                              |                                 |                                  |                                    |                                  |        |
| Nelson Mathews, R (1, 8)<br>OBP: 0.302, SLG: 0.364  | 0-0<br>2B<br>1-2<br>1B                                |                                  | 0-3<br>K                     |                                 | 0-0<br>F2                    |                                  | 0-0<br>F3                    |                                 |                              | 4 0 1 0 0 1 2                   |                              |                                 |                              |                                 |                              |                                 |                              |                                 |                                  |                                    |                                  |        |
| Rocky Colavito, R (1, 9)<br>OBP: 0.379, SLG: 0.528  | 0-0<br>2B<br>1-3<br>2-H                               |                                  | 4-0<br>FC6-4<br>BB           |                                 | 0-0<br>HR                    |                                  | 0-0<br>F8                    |                                 |                              | 3 1 2 2 1 0 0                   |                              |                                 |                              |                                 |                              |                                 |                              |                                 |                                  |                                    |                                  |        |
| Billy Bryan, L (1, 2)<br>OBP: 0.333, SLG: 0.614     | 0-3<br>K  |                                  | 0-3<br>K                     |                                 | 0-0<br>1B                    |                                  | 0-0<br>K                     |                                 |                              | 4 0 1 0 0 3 4                   |                              |                                 |                              |                                 |                              |                                 |                              |                                 |                                  |                                    |                                  |        |
| Ed Charles, R (1, 5)<br>OBP: 0.332, SLG: 0.382      | 0-0<br>F8   |                                  | 0-0<br>FC6-4<br>1-2f         |                                 | 0-0<br>F9                    |                                  | 0-0<br>1-3                   |                                 |                              | 4 0 0 0 0 0 4                   |                              |                                 |                              |                                 |                              |                                 |                              |                                 |                                  |                                    |                                  |        |
| George Alusik, R (1, 7)<br>OBP: 0.354, SLG: 0.336   |   | 0-0<br>G3<br>2B                  |                              | 4-0<br>5-3<br>BB                |                              | 0-0<br>5-3                       |                              | 0-0<br>F5                       |                              | 3 0 1 0 1 0 0                   |                              |                                 |                              |                                 |                              |                                 |                              |                                 |                                  |                                    |                                  |        |
| Jose Tartabull, L (9, 7)<br>OBP: 0.174, SLG: 0.182  |   |                                  |                              |                                 |                              |                                  |                              |                                 |                              | 0 0 0 0 0 0 0                   |                              |                                 |                              |                                 |                              |                                 |                              |                                 |                                  |                                    |                                  |        |
| Rick Joseph, R (1, 3)<br>OBP: 0.229, SLG: 0.188     |   | 0-0<br>G3                        |                              | 0-0<br>5-3<br>1-2               |                              | 0-3<br>K                         |                              | 0-0<br>6-3                      |                              | 4 0 0 0 0 1 2                   |                              |                                 |                              |                                 |                              |                                 |                              |                                 |                                  |                                    |                                  |        |
| Moe Drabowsky, R (1, 1)<br>OBP: 0.036, SLG: 0.036   |   | 0-3<br>K                         |                              | 0-3<br>K                        |                              |                                  | 0-0<br>F8                    |                                 |                              | 2 0 0 0 0 2 2                   |                              |                                 |                              |                                 |                              |                                 |                              |                                 |                                  |                                    |                                  |        |
| Wes Stock, R (6, 1)<br>OBP: 0.125, SLG: 0.125       |   |                                  |                              |                                 |                              |                                  |                              |                                 |                              | 2 0 0 0 0 1 0                   |                              |                                 |                              |                                 |                              |                                 |                              |                                 |                                  |                                    |                                  |        |
| John Wyatt, R (9, 1)<br>OBP: 0.125, SLG: 0.125      |   |                                  |                              |                                 |                              |                                  |                              |                                 |                              | 0 0 0 0 0 0 0                   |                              |                                 |                              |                                 |                              |                                 |                              |                                 |                                  |                                    |                                  |        |
| <b>Inning Stats</b>                                 | R: 1<br>E: 0<br>K: 2<br>S: 10                         | H: 3<br>LOB: 2<br>BB: 0<br>P: 10 | R: 0<br>E: 0<br>K: 2<br>S: 8 | H: 1<br>LOB: 1<br>BB: 0<br>P: 8 | R: 0<br>E: 0<br>K: 2<br>S: 8 | H: 1<br>LOB: 2<br>BB: 1<br>P: 12 | R: 0<br>E: 0<br>K: 1<br>S: 5 | H: 0<br>LOB: 1<br>BB: 1<br>P: 9 | R: 1<br>E: 0<br>K: 0<br>S: 4 | H: 2<br>LOB: 1<br>BB: 0<br>P: 4 | R: 0<br>E: 0<br>K: 1<br>S: 5 | H: 0<br>LOB: 0<br>BB: 0<br>P: 5 | R: 0<br>E: 0<br>K: 0<br>S: 4 | H: 1<br>LOB: 1<br>BB: 0<br>P: 4 | R: 0<br>E: 0<br>K: 1<br>S: 5 | H: 0<br>LOB: 0<br>BB: 0<br>P: 5 | R: 0<br>E: 0<br>K: 1<br>S: 5 | H: 0<br>LOB: 0<br>BB: 0<br>P: 5 | 1B: 3<br>2B: 4<br>3B: 0<br>HR: 1 | SF: 0<br>SAC: 0<br>DP: 0<br>HBP: 0 | WP: 0<br>PB: 0<br>SB: 0<br>CS: 0 | PA: 36 |
| <b>PITCHER</b>                                      | IP WLS BF H R ER SO BB IBB HBP BLK WP HR S P ERA WHIP |                                  |                              |                                 |                              |                                  |                              |                                 |                              |                                 |                              |                                 |                              |                                 |                              |                                 |                              |                                 |                                  |                                    |                                  |        |
| Dave Morehead, R (1, 1)<br>ERA: 4.56                | 7.0 L 30 8 2 2 8 2 0 0 0 0 0 1 44 52 2.57 1.429       |                                  |                              |                                 |                              |                                  |                              |                                 |                              |                                 |                              |                                 |                              |                                 |                              |                                 |                              |                                 |                                  |                                    |                                  |        |
| Bill Spanswick, L (8, 1)<br>ERA: 7.29               | 1.0 3 0 0 0 1 0 0 0 0 0 0 0 5 5 0.00 0.000            |                                  |                              |                                 |                              |                                  |                              |                                 |                              |                                 |                              |                                 |                              |                                 |                              |                                 |                              |                                 |                                  |                                    |                                  |        |
| Bob Heffner, R (9, 1)<br>ERA: 2.54                  | 1.0 3 0 0 0 1 0 0 0 0 0 0 0 5 5 0.00 0.000            |                                  |                              |                                 |                              |                                  |                              |                                 |                              |                                 |                              |                                 |                              |                                 |                              |                                 |                              |                                 |                                  |                                    |                                  |        |

**Kansas City Athletics @ Boston Red Sox**  
 Fenway Park, Boston, MA  
 Tue Jun 30 1964, 3:33 AM EDT  
 Att. 4,326 - Unknown

**AB 34**  
**R 2**  
**H 8**  
**RBI 2**  
**BB 2**  
**SO 10**  
**LOB 17**



WP: 0 PA: 36  
 PB: 0  
 SB: 0  
 CS: 0

ERA WHIP  
 ERA: 2.57 WHIP: 1.429  
 ERA: 7.29 WHIP: 0.000  
 ERA: 2.54 WHIP: 0.000

| Batter   | 1                   | 2         | 3          | 4         | 5               | 6                | 7 | 8          | 9          | AB | R | H | RBI | BB | SO | LOB |
|--|---------------------|-----------|------------|-----------|-----------------|------------------|---|------------|------------|----|---|---|-----|----|----|-----|
| Dalton Jones, L (1, 4)<br>OBP: 0.304, SLG: 0.396     | 0-0<br>G3           |           |            | 0-0<br>F7 |                 | 4-0<br>BB<br>BB  |   | 0-0<br>F7  |            | 3  | 0 | 0 | 0   | 1  | 0  | 0   |
| Felix Mantilla, R (1, 7)<br>OBP: 0.382, SLG: 0.602   | 1-0<br>G6-3<br>HBP  |           |            | 0-0<br>1B |                 | 4-0<br>1-2<br>BB |   |            | 0-0<br>6-3 | 2  | 0 | 1 | 0   | 1  | 0  | 0   |
| Carl Yastrzemski, L (1, 8)<br>OBP: 0.366, SLG: 0.467 | 0-0<br>G6-3<br>1-2f |           |            | 0-0<br>F7 |                 | 0-3<br>K         |   |            | 0-0<br>HR  | 4  | 1 | 1 | 1   | 0  | 1  | 4   |
| Dick Stuart, R (1, 3)<br>OBP: 0.305, SLG: 0.453      |                     | 0-0<br>F2 |            | 0-0<br>F5 |                 | 0-0<br>5-3       |   |            | 0-0<br>F5  | 4  | 0 | 0 | 0   | 0  | 0  | 3   |
| Lee Thomas, L (1, 9)<br>OBP: 0.329, SLG: 0.375       |                     | 0-0<br>G3 |            |           | 4-0<br>BB<br>BB |                  |   | 0-0<br>F7  | 0-0<br>F5  | 3  | 0 | 0 | 0   | 1  | 0  | 0   |
| Frank Malzone, R (1, 5)<br>OBP: 0.338, SLG: 0.418    |                     | 0-0<br>F3 |            |           | 0-0<br>L7       |                  |   | 0-0<br>F6  |            | 3  | 0 | 0 | 0   | 0  | 0  | 1   |
| Eddie Bressoud, R (1, 6)<br>OBP: 0.368, SLG: 0.437   |                     |           | 0-0<br>F9  |           | 0-0<br>F6       |                  |   | 0-0<br>6-3 |            | 3  | 0 | 0 | 0   | 0  | 0  | 1   |
| Bob Tillman, R (1, 2)<br>OBP: 0.365, SLG: 0.427      |                     |           | 0-0<br>6-3 |           | 0-0<br>4-3      |                  |   | 0-0<br>F6  |            | 3  | 0 | 0 | 0   | 0  | 0  | 1   |
| Dave Morehead, R (1, 1)<br>OBP: 0.118, SLG: 0.063    |                     |           | 0-3<br>K   |           | 0-0<br>F4       |                  |   | 0-0<br>F2  |            | 2  | 0 | 0 | 0   | 0  | 1  | 0   |
| Bill Spanswick, L (8, 1)<br>OBP: 0.429, SLG: 0.333   |                     |           |            |           |                 |                  |   |            |            | 0  | 0 | 0 | 0   | 0  | 0  | 0   |
| Russ Nixon, L (8, PH)<br>OBP: 0.411, SLG: 0.462      |                     |           |            |           |                 |                  |   |            |            | 1  | 0 | 0 | 0   | 0  | 0  | 0   |
| Bob Heffner, R (9, 1)<br>OBP: 0.273, SLG: 0.545      |                     |           |            |           |                 |                  |   |            |            | 0  | 0 | 0 | 0   | 0  | 0  | 0   |

| Inning Stats | R: 0 | H: 0 | E: 0 | K: 0 | S: 2 | R: 0 | H: 0 | E: 0 | K: 0 | S: 3 | R: 0 | H: 0 | E: 0 | K: 1 | S: 5 | R: 0 | H: 1 | E: 0 | K: 0 | S: 4 | R: 0 | H: 0 | E: 0 | K: 0 | S: 3 | R: 0 | H: 0 | E: 0 | K: 0 | S: 3 | R: 0 | H: 0 | E: 0 | K: 0 | S: 3 | R: 1 | H: 1 | E: 0 | K: 0 | S: 4 | R: 0 | H: 0 | E: 0 | K: 0 | S: 4 | 1B: 1 | SF: 0 | 2B: 0 | SAC: 0 | 3B: 0 | DP: 1 | HR: 1 | HBP: 1 | WP: 0 | PA: 32 |
|--------------|------|------|------|------|------|------|------|------|------|------|------|------|------|------|------|------|------|------|------|------|------|------|------|------|------|------|------|------|------|------|------|------|------|------|------|------|------|------|------|------|------|------|------|------|------|-------|-------|-------|--------|-------|-------|-------|--------|-------|--------|
|--------------|------|------|------|------|------|------|------|------|------|------|------|------|------|------|------|------|------|------|------|------|------|------|------|------|------|------|------|------|------|------|------|------|------|------|------|------|------|------|------|------|------|------|------|------|------|-------|-------|-------|--------|-------|-------|-------|--------|-------|--------|

| PITCHER                              | IP  | WLS | BF | H | R | ER | SO | BB | IBB | HBP | BLK | WP | HR | S  | P  | ERA  | WHIP  |
|--------------------------------------|-----|-----|----|---|---|----|----|----|-----|-----|-----|----|----|----|----|------|-------|
| Moe Drabowsky, R (1, 1)<br>ERA: 5.55 | 5.1 | W   | 20 | 1 | 0 | 0  | 1  | 3  | 0   | 1   | 0   | 0  | 0  | 18 | 31 | 0.00 | 0.750 |
| Wes Stock, R (6, 1)<br>ERA: 3.35     | 3.0 |     | 10 | 1 | 1 | 1  | 1  | 0  | 0   | 0   | 0   | 0  | 1  | 12 | 12 | 3.00 | 0.333 |
| John Wyatt, R (9, 1)<br>ERA: 2.43    | 0.2 | S   | 2  | 0 | 0 | 0  | 0  | 0  | 0   | 0   | 0   | 0  | 0  | 2  | 2  | 0.00 | 0.000 |

**BOTTOM**

**Kansas City Athletics @ Boston Red Sox**  
 Fenway Park, Boston, MA  
 Tue Jun 30 1964, 3:33 AM EDT  
 Att. 4,326 - Unknown

|            |           |
|------------|-----------|
| <b>AB</b>  | <b>28</b> |
| <b>R</b>   | <b>1</b>  |
| <b>H</b>   | <b>2</b>  |
| <b>RBI</b> | <b>1</b>  |
| <b>BB</b>  | <b>3</b>  |
| <b>SO</b>  | <b>2</b>  |
| <b>LOB</b> | <b>10</b> |



| PITCHER | IP | WLS | BF | H | R | ER | SO | BB | IBB | HBP | BLK | WP | HR | S | P | ERA | WHIP |
|---------|----|-----|----|---|---|----|----|----|-----|-----|-----|----|----|---|---|-----|------|
|---------|----|-----|----|---|---|----|----|----|-----|-----|-----|----|----|---|---|-----|------|

| Batter  | 1   | 2  | 3  | 4  | 5  | 6  | 7  | 8  | 9  | 10   | 11   | AB R H RBI BB SO LOB                               | TOP   |
|---|---|--|--|--|--|--|--|--|--|--|--|--|---|
| Wayne Causey, L (1, 6)<br>OBP: 0.408, SLG: 0.403  | 0-0 1-3   |  | 0-0 G3                                     |  | 0-0 1B                                     |  | 0-0 1B                                     |  | 0-0 1B                                       |  | 0-0 1B                                     | 6 0 4 1 0 0 0                                      | <p>Kansas City Athletics @ New York Yankees</p> <p>Yankee Stadium, Bronx, NY</p> <p>Wed Jul 01 1964, 3:33 AM EDT</p> <p>Att. 7,588 - Unknown - 94 F</p> |
| George Williams, R (1, 4)<br>OBP: 0.282, SLG: 0.282   | 0-0 6-3   |  | 0-3 K                                      |  | 0-0 F7                                     |  | 0-0 L7                                     |  | 0-0 1B                                       |  | 0-0 1B                                     | 6 0 2 1 0 1 4                                      |   |
| Nelson Mathews, R (1, 8)<br>OBP: 0.299, SLG: 0.363  | 0-0 2B  |  | 0-0 6-3                                    |  | 0-0 F9                                     |  | 0-0 F9                                     |  | 0-0 FC6-4                                    |  | 0-0 G6-4-3                                 | 6 1 1 0 0 0 4                                      |   |
| Rocky Colavito, R (1, 9)<br>OBP: 0.383, SLG: 0.531  | 0-0 1B  |  |  | 1-0 1B                                     |  | 0-0 P3                                     |  | 0-0 P4                                     |  | 0-0 FC3-6                                  |  | 4 1 2 1 0 0 0                                      |   |
| George Alusik, R (1, 7)<br>John Wyatt, R (9, 1)   | 0-0 1B  |  |  | 0-0 HBP                                    |  | 0-0 F3                                     |  | 0-0 5-3                                    |  | 0-0 FC3-6                                  |  | 4 0 2 1 0 0 0                                      |   |
| Doc Edwards, R (1, 2)<br>Jose Tartabull, L (9, PR)  | 0-3 K   |  |  | 0-0 F7                                     |  | 0-0 F9                                     |  | 0-0 1B                                     |  | 0-0 P4                                     |  | 4 0 1 0 0 1 3                                      |   |
| Ed Charles, R (1, 5)  |   | 0-3 K                                      |  | 0-0 F3                                     |  | 0-0 F7                                     |  | 0-3 K                                      |  | 0-0 FC6-4                                  |  | 5 0 0 0 0 2 3                                      |   |
| Rick Joseph, R (1, 3)   |   | 0-0 L5                                     |  |  | 0-0 5-3                                    |  | 0-0 1B                                     |  | 0-0 1B                                       |  | 0-0 5-3                                    | 5 1 2 0 0 0 0                                      |   |
| John O'Donoghue, R (1, 1)<br>Jose Santiago, R (1, 1)  |   | 0-3 K                                      |  |  | 0-0 5-3                                    |  | 4-0 1B                                     |  | 0-3 K  |  | 0-0 HR                                     | 0 0 0 0 0 0 0                                      |   |
| Manny Jimenez, L (7, PH)<br>Dick Green, R (7, PR)<br>Orlando Pena, R (7, 1)<br>Billy Bryan, L (9, PH) |   |  |  |  |  |  |  |  |  |  |  | 2 0 0 0 0 1 0                                      |   |
| Inning Stats  | R: 2 H: 3 E: 0 LOB: 1 K: 1 BB: 0 S: 8 P: 8            | R: 0 H: 0 E: 0 LOB: 0 K: 2 BB: 0 S: 7 P: 7 | R: 0 H: 0 E: 0 LOB: 0 K: 1 BB: 0 S: 5 P: 5 | R: 0 H: 1 E: 0 LOB: 1 K: 0 BB: 0 S: 3 P: 4 | R: 0 H: 1 E: 0 LOB: 1 K: 0 BB: 0 S: 4 P: 4 | R: 0 H: 0 E: 0 LOB: 0 K: 0 BB: 0 S: 3 P: 3 | R: 0 H: 2 E: 0 LOB: 3 K: 0 BB: 1 S: 5 P: 9 | R: 0 H: 0 E: 0 LOB: 0 K: 0 BB: 0 S: 3 P: 3 | R: 2 H: 4 E: 0 LOB: 2 K: 2 BB: 0 S: 11 P: 11 | R: 0 H: 1 E: 0 LOB: 1 K: 0 BB: 0 S: 4 P: 4 | R: 1 H: 3 E: 0 LOB: 1 K: 0 BB: 0 S: 5 P: 5 | 1B: 12 SF: 0 2B: 2 SAC: 0 3B: 0 DP: 1 HR: 1 HBP: 1 |   |
| PITCHER   | IP WLS BF H R ER SO BB IBB HBP BLK WP HR S P ERA WHIP |  |  |  |  |  |  |  |  |  |  |  |   |
| Whitey Ford, L (1, 1)<br>ERA: 1.99  | 7.0   |  |  |  |  |  |  |  |  |  |  |  | 2.57 1.143  |
| Bill Stafford, R (8, 1)<br>ERA: 2.55  | 1.1   |  |  |  |  |  |  |  |  |  |  |  | 13.50 1.500   |
| Steve Hamilton, L (9, 1)<br>ERA: 2.34   | 0.1   |  |  |  |  |  |  |  |  |  |  |  | 0.00 6.000  |
| Pete Mikkelsen, R (9, 1)<br>ERA: 4.4  | 0.1   |  |  |  |  |  |  |  |  |  |  |  | 0.00 0.000  |
| Ralph Terry, R (10, 1)<br>ERA: 6.8  | 2.0   | L  |  |  |  |  |  |  |  |  |  |  | 4.50 2.000  |

|     |    |
|-----|----|
| AB  | 46 |
| R   | 5  |
| H   | 15 |
| RBI | 5  |
| BB  | 1  |
| SO  | 6  |
| LOB | 18 |

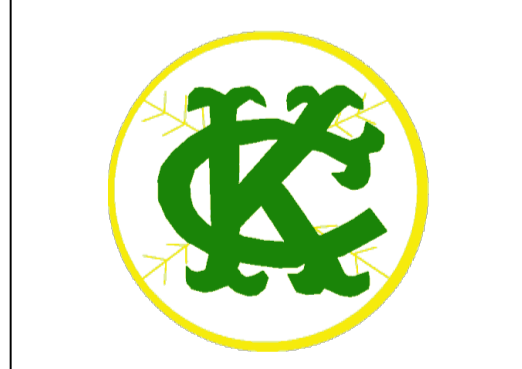

|       |        |
|-------|--------|
| WP: 0 | PA: 48 |
| PB: 0 |        |
| SB: 0 |        |
| CS: 0 |        |

|        |        |
|--------|--------|
| 1B: 12 | SF: 0  |
| 2B: 2  | SAC: 0 |
| 3B: 0  | DP: 1  |
| HR: 1  | HBP: 1 |

|                            |
|----------------------------|
| livebaseballscorecards.com |
|----------------------------|

| Batter   | 1                        | 2         | 3          | 4                | 5         | 6           | 7         | 8                    | 9                        | 10               | 11                    | AB R H RBI BB SO LOB  |
|--|--------------------------|-----------|------------|------------------|-----------|-------------|-----------|----------------------|--------------------------|------------------|-----------------------|---|
| Phil Linz, R<br>OBP: 0.302, SLG: 0.347<br>(1, 5)<br>(10, 6)  | 0-0<br>2B<br>1B          | 0-3<br>K  |            | 0-0<br>P4<br>1-2 |           |             | 0-0<br>P6 |                      | 0-0<br>5-3               |                  |                       | 5 1 1 0 0 1 3   |
| Bobby Richardson, R<br>OBP: 0.282, SLG: 0.318<br>(1, 4)  | 0-0<br>HR<br>2B          | 0-0<br>1B |            |                  | 0-0<br>F5 |             |           | 0-0<br>F8            |                          | 0-3<br>K         |                       | 5 1 2 1 0 1 0   |
| Roger Maris, L<br>OBP: 0.362, SLG: 0.495<br>(1, 9)   | 0-0<br>L9                | 0-0<br>L9 |            |                  | 0-0<br>F9 |             |           | 4-0<br>FC4-6<br>BB   |                          | 0-0<br>F7        |                       | 4 0 0 0 1 0 2   |
| Mickey Mantle, S<br>OBP: 0.441, SLG: 0.626<br>Pedro Gonzalez, R<br>OBP: 0.306, SLG: 0.328<br>(1, 8)<br>(8, PR)<br>(9, 3)<br>(10, 5)  | 0-0<br>HR                |           | 0-0<br>4-3 |                  | 0-3<br>K  |             |           | 0-0<br>FC4-6<br>1-2f |                          | 0-0<br>1B        |                       | 4 1 1 2 0 1 1<br>1 0 1 0 0 0 0  |
| Elston Howard, R<br>OBP: 0.362, SLG: 0.455<br>(1, 2)   | 4-0<br>4-3<br>1B<br>BB   |           | 0-0<br>5-3 |                  |           | 0-0<br>F8   |           | 0-3<br>K             |                          | 0-0<br>P6<br>1-2 |                       | 4 0 0 0 1 1 2   |
| Hector Lopez, R<br>OBP: 0.351, SLG: 0.484<br>(1, 7)  | 0-0<br>4-3<br>1B         |           | 0-0<br>F9  |                  |           | 0-0<br>4-3  |           |                      | 0-0<br>F8                |                  | 0-0<br>G3-6-3<br>1B   | 5 0 2 0 0 0 0   |
| Joe Pepitone, L<br>OBP: 0.299, SLG: 0.387<br>(1, 3)<br>(9, 8)  | 0-0<br>4-3<br>1-2<br>2-3 |           | 0-3<br>K   |                  |           | 0-0<br>G6-3 |           |                      | 0-0<br>2B<br>SF7<br>1B   |                  | 0-0<br>G3-6-3<br>1-2f | 5 1 1 0 0 1 3   |
| Clete Boyer, R<br>OBP: 0.278, SLG: 0.311<br>Johnny Blanchard, L<br>OBP: 0.418, SLG: 0.403<br>Al Downing, R<br>OBP: 0.219, SLG: 0.313<br>Archie Moore, L<br>OBP: 0.300, SLG: 0.250<br>(1, 6)<br>(9, PH)<br>(9, PR)<br>(10, 3)   | 0-3<br>K                 |           | 0-0<br>F9  |                  |           | 0-3<br>K    |           | 0-3<br>K             | 0-0<br>SF7<br>2B         |                  | 0-0<br>L6             | 3 0 0 0 0 2 2<br>1 0 1 0 0 0 0<br>0 0 0 0 0 0 0<br>1 0 0 0 0 0 0  |
| Whitey Ford, L<br>OBP: 0.311, SLG: 0.211<br>Tom Fresh, S<br>OBP: 0.288, SLG: 0.420<br>Bill Stafford, R<br>OBP: 0.091, SLG: 0.182<br>Steve Hamilton, L<br>OBP: 0.235, SLG: 0.133<br>Pete Mikkelsen, R<br>OBP: 0.266, SLG: 0.371<br>Tony Kubek, L<br>OBP: 0.250, SLG: 0.214<br>(1, 1)<br>(7, PH)<br>(8, 1)<br>(9, 1)<br>(9, 1)<br>(9, PH)<br>(10, 1) |                          | 0-0<br>L7 |            | 4-0<br>PB<br>BB  |           |             | 0-0<br>P6 |                      | 0-0<br>SF7<br>2-3<br>3-H |                  |                       | 1 0 0 0 0 1 0 0<br>1 0 0 0 0 0 0 0<br>0 0 0 0 0 0 0 0<br>0 0 0 0 0 0 0 0<br>0 0 0 0 0 0 0 0<br>0 0 0 0 1 0 0 0<br>0 0 0 0 0 0 0 0 |

| Inning Stats | R: 3 | H: 4 | E: 0 | K: 1 | S: 9 | LOB: 2 | BB: 1 | P: 13 | R: 0 | H: 1 | E: 0 | K: 1 | S: 6 | LOB: 1 | BB: 0 | P: 6 | R: 0 | H: 0 | E: 0 | K: 0 | S: 3 | LOB: 0 | BB: 0 | P: 3 | R: 0 | H: 0 | E: 0 | K: 1 | S: 5 | LOB: 1 | BB: 1 | P: 9 | R: 0 | H: 0 | E: 0 | K: 0 | S: 5 | LOB: 0 | BB: 0 | P: 5 | R: 0 | H: 0 | E: 0 | K: 0 | S: 3 | LOB: 0 | BB: 0 | P: 3 | R: 0 | H: 0 | E: 0 | K: 1 | S: 5 | LOB: 0 | BB: 0 | P: 5 | R: 0 | H: 0 | E: 0 | K: 1 | S: 5 | LOB: 1 | BB: 1 | P: 9 | R: 1 | H: 2 | E: 0 | K: 0 | S: 5 | LOB: 2 | BB: 0 | P: 5 | R: 0 | H: 1 | E: 0 | K: 1 | S: 6 | LOB: 1 | BB: 0 | P: 6 | R: 0 | H: 1 | E: 0 | K: 0 | S: 3 | LOB: 0 | BB: 0 | P: 3 | 1B: 6 | SF: 1 | 2B: 2 | SAC: 0 | 3B: 0 | DP: 1 | HR: 1 | HBP: 0 | WP: 0 | PA: 44 |
|--------------|------|------|------|------|------|--------|-------|-------|------|------|------|------|------|--------|-------|------|------|------|------|------|------|--------|-------|------|------|------|------|------|------|--------|-------|------|------|------|------|------|------|--------|-------|------|------|------|------|------|------|--------|-------|------|------|------|------|------|------|--------|-------|------|------|------|------|------|------|--------|-------|------|------|------|------|------|------|--------|-------|------|------|------|------|------|------|--------|-------|------|------|------|------|------|------|--------|-------|------|-------|-------|-------|--------|-------|-------|-------|--------|-------|--------|
|--------------|------|------|------|------|------|--------|-------|-------|------|------|------|------|------|--------|-------|------|------|------|------|------|------|--------|-------|------|------|------|------|------|------|--------|-------|------|------|------|------|------|------|--------|-------|------|------|------|------|------|------|--------|-------|------|------|------|------|------|------|--------|-------|------|------|------|------|------|------|--------|-------|------|------|------|------|------|------|--------|-------|------|------|------|------|------|------|--------|-------|------|------|------|------|------|------|--------|-------|------|-------|-------|-------|--------|-------|-------|-------|--------|-------|--------|

| PITCHER                                   | IP  | WLS | BF | H | R | ER | SO | BB | IBB | HBP | BLK | WP | HR | S  | P  | ERA   | WHIP   |
|---|-----|-----|----|---|---|----|----|----|-----|-----|-----|----|----|----|----|-------|--------|
| John O'Donoghue, L<br>ERA: 4.69<br>(1, 1) | 0.1 |     | 5  | 3 | 3 | 3  | 0  | 1  | 0   | 0   | 0   | 0  | 1  | 4  | 8  | 81.00 | 12.000 |
| Jose Santiago, R<br>ERA: 3.43<br>(1, 1)   | 5.2 |     | 20 | 2 | 0 | 0  | 4  | 1  | 0   | 0   | 0   | 0  | 0  | 27 | 31 | 0.00  | 0.529  |
| Orlando Pena, R<br>ERA: 4.12<br>(7, 1)    | 2.0 |     | 7  | 0 | 0 | 0  | 2  | 1  | 0   | 0   | 0   | 0  | 0  | 10 | 14 | 0.00  | 0.500  |
| John Wyatt, R<br>ERA: 2.45<br>(9, 1)      | 3.0 | W   | 12 | 4 | 1 | 1  | 1  | 0  | 0   | 0   | 0   | 0  | 0  | 14 | 14 | 3.00  | 1.333  |

**BOTTOM**

**Kansas City Athletics @ New York Yankees**  
 Yankee Stadium, Bronx, NY

Wed Jul 01 1964, 3:33 AM EDT  
 Att. 7,588 - Unknown - 94 F

|     |    |
|-----|----|
| AB  | 40 |
| R   | 4  |
| H   | 9  |
| RBI | 4  |
| BB  | 3  |
| SO  | 7  |
| LOB | 13 |



| Batter                                       | 1   | 2                               | 3                            | 4                               | 5                            | 6                               | 7                            | 8                               | 9                            | 10                               | 11                           | 12                              | 13                           | 14                              | 15                           | AB R H RBI BB SO LOB            | TOP   |                              |                                 |                              |                                 |                              |                                 |                              |                                 |                                  |                                    |                                  |        |
|--|---|---------------------------------|------------------------------|---------------------------------|------------------------------|---------------------------------|------------------------------|---------------------------------|------------------------------|----------------------------------|------------------------------|---------------------------------|------------------------------|---------------------------------|------------------------------|---------------------------------|---|------------------------------|---------------------------------|------------------------------|---------------------------------|------------------------------|---------------------------------|------------------------------|---------------------------------|----------------------------------|------------------------------------|----------------------------------|--------|
| Wayne Causey, L<br>OBP: 0.407, SLG: 0.399    | L6  |                                 | E4<br>3B<br>1B               |                                 | L9                           |                                 | 6-3                          |                                 | FC5-4<br>IBB                 |                                  |                              | L4                              |                              | K                               |                              | 6 1 1 0 1 1 0                   | <b>Kansas City Athletics @ New York Yankees</b><br>Yankee Stadium, Bronx, NY<br>Thu Jul 02 1964, 7:05 PM EDT<br>Att. 9,606 - Unknown - 84 F |                              |                                 |                              |                                 |                              |                                 |                              |                                 |                                  |                                    |                                  |        |
| George Williams, R<br>OBP: 0.271, SLG: 0.269 | 5-3   |                                 | F7                           |                                 | 5-3                          |                                 |                              |                                 | FC5-4<br>1-2f                |                                  |                              | F9                              |                              |                                 | P4                           | 7 0 1 0 0 0 3                   |   |                              |                                 |                              |                                 |                              |                                 |                              |                                 |                                  |                                    |                                  |        |
| Nelson Mathews, R<br>OBP: 0.296, SLG: 0.356  | 4-3   |                                 | P6                           |                                 |                              |                                 |                              |                                 |                              |                                  |                              | P6                              |                              |                                 | K                            | 6 0 0 0 1 1 2                   |   |                              |                                 |                              |                                 |                              |                                 |                              |                                 |                                  |                                    |                                  |        |
| Rocky Colavito, R<br>OBP: 0.384, SLG: 0.535  |   | 1B<br>FC1-6-4<br>HBP            |                              |                                 |                              |                                 |                              |                                 |                              |                                  |                              |                                 |                              |                                 | F3                           | 6 1 2 1 0 0 1                   |   |                              |                                 |                              |                                 |                              |                                 |                              |                                 |                                  |                                    |                                  |        |
| Billy Bryan, L<br>OBP: 0.317, SLG: 0.604     |   | K                               |                              |                                 |                              |                                 |                              |                                 |                              |                                  |                              |                                 |                              |                                 |                              | 6 0 0 0 0 3 5                   |   |                              |                                 |                              |                                 |                              |                                 |                              |                                 |                                  |                                    |                                  |        |
| George Alusik, R<br>OBP: 0.367, SLG: 0.348   |   |                                 |                              |                                 |                              |                                 |                              |                                 |                              |                                  |                              |                                 |                              |                                 |                              | 3 0 2 0 1 0 0                   |   |                              |                                 |                              |                                 |                              |                                 |                              |                                 |                                  |                                    |                                  |        |
| Jose Tartabull, L<br>OBP: 0.192, SLG: 0.200  |   |                                 |                              |                                 |                              |                                 |                              |                                 |                              |                                  |                              |                                 |                              |                                 |                              | 2 0 1 0 0 0 0                   |   |                              |                                 |                              |                                 |                              |                                 |                              |                                 |                                  |                                    |                                  |        |
| Ed Charles, R<br>OBP: 0.321, SLG: 0.367      |   | FC1-6-4<br>2B                   |                              |                                 |                              |                                 |                              |                                 |                              |                                  |                              |                                 |                              |                                 |                              | 6 1 0 1 0 1 6                   |   |                              |                                 |                              |                                 |                              |                                 |                              |                                 |                                  |                                    |                                  |        |
| Rick Joseph, R<br>OBP: 0.283, SLG: 0.279     |   |                                 |                              |                                 |                              |                                 |                              |                                 |                              |                                  |                              |                                 |                              |                                 |                              | 6 0 3 1 0 0 4                   |   |                              |                                 |                              |                                 |                              |                                 |                              |                                 |                                  |                                    |                                  |        |
| Diego Segui, R<br>OBP: 0.205, SLG: 0.262     |   |                                 |                              |                                 |                              |                                 |                              |                                 |                              |                                  |                              |                                 |                              |                                 |                              | 3 0 0 0 0 1 1                   |   |                              |                                 |                              |                                 |                              |                                 |                              |                                 |                                  |                                    |                                  |        |
| Ted Bowsfield, R                             |   |                                 |                              |                                 |                              |                                 |                              |                                 |                              |                                  |                              |                                 |                              |                                 |                              | 0 0 0 0 0 0 0                   |   |                              |                                 |                              |                                 |                              |                                 |                              |                                 |                                  |                                    |                                  |        |
| Wes Stock, R<br>OBP: 0.125, SLG: 0.125       |   |                                 |                              |                                 |                              |                                 |                              |                                 |                              |                                  |                              |                                 |                              |                                 |                              | 0 0 0 0 0 0 0                   |   |                              |                                 |                              |                                 |                              |                                 |                              |                                 |                                  |                                    |                                  |        |
| Manny Jimenez, L<br>OBP: 0.294, SLG: 0.423   |   |                                 |                              |                                 |                              |                                 |                              |                                 |                              |                                  |                              |                                 |                              |                                 |                              | 1 0 0 0 0 0 1                   |   |                              |                                 |                              |                                 |                              |                                 |                              |                                 |                                  |                                    |                                  |        |
| Dan Pfister, R                               |   |                                 |                              |                                 |                              |                                 |                              |                                 |                              |                                  |                              |                                 |                              |                                 |                              | 1 0 0 0 0 0 0                   |   |                              |                                 |                              |                                 |                              |                                 |                              |                                 |                                  |                                    |                                  |        |
| <b>Inning Stats</b>                          | R: 0<br>E: 0<br>K: 0<br>S: 3                          | H: 0<br>LOB: 0<br>BB: 0<br>P: 3 | R: 2<br>E: 1<br>K: 1<br>S: 7 | H: 2<br>LOB: 1<br>BB: 0<br>P: 8 | R: 1<br>E: 1<br>K: 1<br>S: 7 | H: 2<br>LOB: 1<br>BB: 0<br>P: 7 | R: 0<br>E: 0<br>K: 1<br>S: 5 | H: 1<br>LOB: 0<br>BB: 0<br>P: 5 | R: 0<br>E: 0<br>K: 1<br>S: 6 | H: 1<br>LOB: 3<br>BB: 2<br>P: 14 | R: 0<br>E: 0<br>K: 1<br>S: 6 | H: 1<br>LOB: 1<br>BB: 0<br>P: 6 | R: 0<br>E: 0<br>K: 0<br>S: 3 | H: 0<br>LOB: 0<br>BB: 0<br>P: 3 | R: 0<br>E: 1<br>K: 0<br>S: 3 | H: 1<br>LOB: 0<br>BB: 0<br>P: 4 |   | R: 0<br>E: 0<br>K: 0<br>S: 3 | H: 1<br>LOB: 1<br>BB: 0<br>P: 4 | R: 0<br>E: 0<br>K: 1<br>S: 5 | H: 0<br>LOB: 0<br>BB: 0<br>P: 5 | R: 0<br>E: 0<br>K: 1<br>S: 5 | H: 0<br>LOB: 0<br>BB: 0<br>P: 5 | R: 0<br>E: 0<br>K: 1<br>S: 5 | H: 0<br>LOB: 0<br>BB: 0<br>P: 5 | 1B: 8<br>2B: 1<br>3B: 1<br>HR: 0 | SF: 0<br>SAC: 1<br>DP: 2<br>HBP: 1 | WP: 0<br>PB: 0<br>SB: 1<br>CS: 0 | PA: 58 |
| <b>PITCHER</b>                               | IP WLS BF H R ER SO BB IBB HBP BLK WP HR S P ERA WHIP |                                 |                              |                                 |                              |                                 |                              |                                 |                              |                                  |                              |                                 |                              |                                 |                              |                                 |   |                              |                                 |                              |                                 |                              |                                 |                              |                                 |                                  |                                    |                                  |        |
| Rollie Sheldon, R<br>ERA: 3.75               | (1, 1) 5.0  |                                 |                              |                                 |                              |                                 |                              |                                 |                              |                                  |                              |                                 |                              |                                 |                              |                                 |   |                              |                                 |                              |                                 |                              |                                 |                              |                                 |                                  |                                    |                                  |        |
| Bud Daley, L<br>ERA: 4.33                    | (6, 1) 0.1  |                                 |                              |                                 |                              |                                 |                              |                                 |                              |                                  |                              |                                 |                              |                                 |                              |                                 |   |                              |                                 |                              |                                 |                              |                                 |                              |                                 |                                  |                                    |                                  |        |
| Bill Stafford, R<br>ERA: 2.43                | (6, 1) 1.2  |                                 |                              |                                 |                              |                                 |                              |                                 |                              |                                  |                              |                                 |                              |                                 |                              |                                 |   |                              |                                 |                              |                                 |                              |                                 |                              |                                 |                                  |                                    |                                  |        |
| Pete Mikkelsen, R<br>ERA: 3.88               | (8, 1) 6.0  |                                 |                              |                                 |                              |                                 |                              |                                 |                              |                                  |                              |                                 |                              |                                 |                              |                                 |   |                              |                                 |                              |                                 |                              |                                 |                              |                                 |                                  |                                    |                                  |        |
| Steve Hamilton, L<br>ERA: 2.23               | (14, 1) 2.0 W   |                                 |                              |                                 |                              |                                 |                              |                                 |                              |                                  |                              |                                 |                              |                                 |                              |                                 |   |                              |                                 |                              |                                 |                              |                                 |                              |                                 |                                  |                                    |                                  |        |

AB 53  
R 3  
H 10  
RBI 3  
BB 3  
SO 7  
LOB 23





| Batter  | 1   | 2   | 3   | 4   | 5  | 6   | 7   | 8   | 9   | 10  | 11  | 12  | 13  | 14  | 15   | AB   | R                                       | H | RBI | BB | SO | LOB | BOTTOM  |  |  |  |
|---|---|---|---|---|--|---|---|---|---|---|---|---|---|---|--|--|---|---|-----|----|----|-----|---|--|--|--|
| Phil Linz, R<br>OBP: 0.304, SLG: 0.345 (1, 5)<br>Tony Kubek, L<br>OBP: 0.290, SLG: 0.371 (11, PH)<br>Pedro Gonzalez, R<br>OBP: 0.302, SLG: 0.322 (11, PR)<br>(12, 5)  | 0-0<br>5-3  |   | 0-0<br>1B   |   | 4-0<br>2B<br>BB                                      |   | 0-0<br>P3   |   | 0-3<br>K  |   | 4-0<br>IBB  |   |   | 0-3<br>K  |  | 4  | 1                                       | 1 | 0   | 1  | 1  | 2   | <b>Kansas City Athletics @ New York Yankees</b><br>Yankee Stadium, Bronx, NY<br>Thu Jul 02 1964, 7:05 PM EDT<br>Att. 9,606 - Unknown - 84 F<br><a href="http://livebaseballscorecards.com">livebaseballscorecards.com</a> |  |  |  |
| Bobby Richardson, R<br>OBP: 0.289, SLG: 0.323 (1, 4)  | 0-0<br>6-3  |   | 0-0<br>F2   |   | 0-0<br>F8  |   | 0-0<br>P6   |   | 0-0<br>P6   |   | 0-0<br>PO   |   | 0-0<br>5-3  |   | 0-0<br>6-3   | 7  | 1                                       | 1 | 1   | 0  | 0  | 5   |   |  |  |  |
| Mickey Mantle, S<br>OBP: 0.440, SLG: 0.632 (1, 8)   | 0-0<br>1-3  |   | 0-3<br>K  |   | 0-0<br>2B  |   | 0-3<br>K  |   | 0-0<br>K  |   | 4-0<br>L6<br>1B<br>BB                               |   | 0-0<br>F2   |   | 0-0<br>F2  | 6  | 1                                       | 2 | 2   | 1  | 2  | 1   |   |  |  |  |
| Roger Maris, L<br>OBP: 0.363, SLG: 0.498 (1, 9)<br>Tom Tresh, S<br>OBP: 0.359, SLG: 0.418 (13, 7)   |   | 0-3<br>K  | 0-0<br>4-3  |   | 0-0<br>F2  |   | 0-0<br>2B   |   | 0-0<br>2B   |   | 0-0<br>1B   |   | 0-0<br>L6   |   | 4-0<br>1B<br>IBB<br>IBB                              | 5  | 0                                       | 2 | 0   | 0  | 1  | 2   |   |  |  |  |
| Joe Pepitone, L<br>OBP: 0.302, SLG: 0.388 (1, 3)  |   | 0-0<br>1B<br>2B                                       |   | 4-0<br>G6-4-3<br>BB                                 |  | 0-0<br>3-1  |   | 0-0<br>4-3  |   | 0-3<br>K  |   |   | 0-0<br>6-3  |   | 4-0<br>1B<br>IBB                                     | 5  | 0                                       | 1 | 0   | 2  | 1  | 3   |   |  |  |  |
| Hector Lopez, R<br>OBP: 0.348, SLG: 0.476 (13, 9)   |   | 0-0<br>1B<br>1B                                       |   | 0-0<br>G6-4-3<br>1-2                                |  | 0-0<br>F8   |   | 0-0<br>F7   |   | 0-0<br>L6   |   |   | 0-0<br>5-3  |   | 0-0<br>1B  | 7  | 0                                       | 2 | 1   | 0  | 0  | 4   |   |  |  |  |
| Elston Howard, R<br>OBP: 0.357, SLG: 0.448 (1, 2)   |   | 0-0<br>F3   |   | 0-3<br>K  |  | 0-0<br>4-3  |   |   | 0-0<br>SH3-4<br>1B                                  |   |   |   | 0-0<br>4-3  |   |  | 6  | 0                                       | 1 | 0   | 0  | 2  | 2   |   |  |  |  |
| Clete Boyer, R<br>OBP: 0.283, SLG: 0.316 (1, 6)   |   | 0-0<br>1-2<br>2-3<br>1B                               |   | 0-3<br>K  |  | 0-0<br>4-3  |   |   | 0-0<br>SH3-4<br>1B                                  |   |   |   |   | 0-0<br>F9   |  | 6  | 0                                       | 3 | 0   | 0  | 1  | 0   |   |  |  |  |
| Rollie Sheldon, R<br>OBP: 0.182, SLG: 0.182 (5, PH)<br>Archie Moore, L<br>OBP: 0.394, SLG: 0.333 (6, 1)<br>Bud Lilly, L<br>OBP: 0.429, SLG: 0.333 (6, 1)<br>Bill Stafford, R<br>OBP: 0.091, SLG: 0.182 (7, PH)<br>Johnny Blanchard, L<br>OBP: 0.413, SLG: 0.397 (8, 1)<br>Pete Mikkelsen, R<br>OBP: 0.222, SLG: 0.125 (14, 1) |   | 0-3<br>K2-3   |   | 0-0<br>BB<br>2B<br>1B                               |  | 0-0<br>G3   |   |   | 0-0<br>SH3-4  |   |   |   | 0-0<br>SH1-4  |   | 0-0<br>F7  | 1  | 0                                       | 0 | 0   | 0  | 1  | 3   |   |  |  |  |
| <b>Inning Stats</b>   | R: 0 H: 0<br>E: 0 LOB: 0<br>K: 0 BB: 0<br>S: 3 P: 3   | R: 0 H: 3<br>E: 0 LOB: 3<br>K: 2 BB: 0<br>S: 10 P: 10 | R: 0 H: 1<br>E: 0 LOB: 1<br>K: 1 BB: 0<br>S: 6 P: 6 | R: 0 H: 0<br>E: 0 LOB: 0<br>K: 1 BB: 1<br>S: 4 P: 8 | R: 2 H: 2<br>E: 0 LOB: 1<br>K: 1 BB: 1<br>S: 7 P: 11 | R: 0 H: 0<br>E: 0 LOB: 0<br>K: 0 BB: 0<br>S: 3 P: 3 | R: 0 H: 0<br>E: 0 LOB: 0<br>K: 0 BB: 0<br>S: 3 P: 3 | R: 1 H: 2<br>E: 0 LOB: 1<br>K: 1 BB: 0<br>S: 7 P: 7 | R: 0 H: 2<br>E: 0 LOB: 2<br>K: 1 BB: 0<br>S: 7 P: 7 | R: 0 H: 1<br>E: 0 LOB: 1<br>K: 1 BB: 1<br>S: 5 P: 9 | R: 0 H: 1<br>E: 0 LOB: 1<br>K: 1 BB: 1<br>S: 5 P: 9 | R: 0 H: 0<br>E: 0 LOB: 0<br>K: 0 BB: 0<br>S: 3 P: 3 | R: 0 H: 0<br>E: 0 LOB: 0<br>K: 0 BB: 0<br>S: 3 P: 3 | R: 0 H: 0<br>E: 0 LOB: 0<br>K: 1 BB: 0<br>S: 5 P: 5 | R: 1 H: 2<br>E: 0 LOB: 3<br>K: 0 BB: 2<br>S: 3 P: 11 | 1B: 9 SF: 0<br>2B: 4 SAC: 2<br>3B: 1 DP: 2<br>HR: 1 HBP: 0 | WP: 0 PA: 61<br>PB: 0<br>SB: 0<br>CS: 0 |   |     |    |    |     |   |  |  |  |
| <b>PITCHER</b>  | IP WLS BF H R ER SO BB IBB HBP BLK WP HR S P ERA WHIP |   |   |   |  |   |   |   |   |   |   |   |   |   |  |  |   |   |     |    |    |     |   |  |  |  |
| Diego Segui, R<br>ERA: 3.86 (1, 1)  | 7.0   | 29  | 7   | 3   | 3  | 5   | 2   | 0   | 0   | 0   | 0   | 0   | 0   | 0   | 0  | 3.86   | 1.286                                   |   |     |    |    |     |   |  |  |  |
| Ted Bowsfield, L<br>ERA: 4.8 (8, 1)   | 1.1   | 7   | 3   | 0   | 0  | 1   | 0   | 0   | 0   | 0   | 0   | 0   | 0   | 0   | 0  | 0.00   | 2.250                                   |   |     |    |    |     |   |  |  |  |
| Wes Stock, R<br>ERA: 3.2 (9, 1)   | 1.2   | 6   | 1   | 0   | 0  | 2   | 1   | 0   | 0   | 0   | 0   | 0   | 0   | 0   | 0  | 0.00   | 1.200                                   |   |     |    |    |     |   |  |  |  |
| Dan Pfister, R<br>ERA: 6.57 (11, 1)   | 4.1   | 18  | 3   | 1   | 1  | 2   | 0   | 3   | 0   | 0   | 0   | 0   | 0   | 0   | 0  | 2.08   | 0.692                                   |   |     |    |    |     |   |  |  |  |

**Kansas City Athletics @ New York Yankees**  
 Yankee Stadium, Bronx, NY  
 Thu Jul 02 1964, 7:05 PM EDT  
 Att. 9,606 - Unknown - 84 F

|     |    |
|-----|----|
| AB  | 52 |
| R   | 4  |
| H   | 14 |
| RBI | 4  |
| BB  | 6  |
| SO  | 10 |
| LOB | 22 |



| Batter  | 1   | 2                               | 3                            | 4                               | 5                            | 6                               | 7                            | 8                               | 9                            | AB R H RBI BB SO LOB            | TOP   |                                 |                              |                                 |                                  |                                    |                                  |        |  |
|---|---|---------------------------------|------------------------------|---------------------------------|------------------------------|---------------------------------|------------------------------|---------------------------------|------------------------------|---------------------------------|---|---------------------------------|------------------------------|---------------------------------|----------------------------------|------------------------------------|----------------------------------|--------|--|
| Wayne Causey, L (1, 6)<br>OBP: 0.405, SLG: 0.395      | 0-0<br>4-3  |                                 |                              | 0-0<br>1-3                      |                              | 0-0<br>F9                       |                              |                                 | 4-0<br>BB                    | 3 0 0 0 1 0 0                   |   |                                 |                              |                                 |                                  |                                    |                                  |        |  |
| George Williams, R (1, 4)<br>OBP: 0.258, SLG: 0.256   | 0-0<br>F3   |                                 |                              | 0-0<br>4-3                      |                              |                                 | 0-0<br>F8                    |                                 | 0-0<br>F9                    | 4 0 0 0 0 0 1                   |   |                                 |                              |                                 |                                  |                                    |                                  |        |  |
| Nelson Mathews, R (1, 8)<br>OBP: 0.293, SLG: 0.352    | 0-3<br>K  |                                 |                              | 0-3<br>K                        |                              |                                 | 0-0<br>4-3                   |                                 |                              | 3 0 0 0 0 2 0                   |   |                                 |                              |                                 |                                  |                                    |                                  |        |  |
| Rocky Colavito, R (1, 9)<br>OBP: 0.383, SLG: 0.536    |   | 0-0<br>F7                       |                              |                                 | 0-0<br>4-3<br>2B             |                                 | 0-0<br>G3                    |                                 |                              | 3 0 1 0 0 0 0                   |   |                                 |                              |                                 |                                  |                                    |                                  |        |  |
| Manny Jimenez, L (1, 7)<br>OBP: 0.286, SLG: 0.410     |   | 0-0<br>3-1                      |                              |                                 | 0-0<br>4-3<br>2-3            |                                 |                              | 0-0<br>6-3                      |                              | 3 0 0 0 0 0 1                   |   |                                 |                              |                                 |                                  |                                    |                                  |        |  |
| Billy Bryan, L (1, 2)<br>OBP: 0.308, SLG: 0.586       |   | 0-0<br>F9                       |                              |                                 | 0-3<br>K                     |                                 |                              | 0-0<br>L9                       |                              | 3 0 0 0 0 1 1                   |   |                                 |                              |                                 |                                  |                                    |                                  |        |  |
| Ed Charles, R (1, 5)<br>OBP: 0.319, SLG: 0.365        |   |                                 | 0-0<br>F9                    |                                 | 0-0<br>F4                    |                                 |                              | 0-0<br>F8                       |                              | 2 0 0 0 0 0 1                   |   |                                 |                              |                                 |                                  |                                    |                                  |        |  |
| George Alusik, R (8, PH)<br>OBP: 0.365, SLG: 0.345    |   |                                 |                              |                                 |                              |                                 |                              |                                 |                              | 1 0 0 0 0 0 0                   | AB 28<br>R 0<br>H 1<br>RBI 0<br>BB 1<br>SO 5<br>LOB 4 |                                 |                              |                                 |                                  |                                    |                                  |        |  |
| Rick Joseph, R (1, 3)<br>OBP: 0.265, SLG: 0.261       |   |                                 | 0-0<br>F3                    |                                 | 0-0<br>F3                    |                                 |                              | 0-0<br>F6                       |                              | 3 0 0 0 0 0 0                   |   |                                 |                              |                                 |                                  |                                    |                                  |        |  |
| Orlando Pena, R (1, 1)<br>OBP: 0.133, SLG: 0.163      |   |                                 | 0-3<br>K                     |                                 | 0-0<br>F8                    |                                 |                              | 0-3<br>K                        |                              | 2 0 0 0 0 1 0                   |   |                                 |                              |                                 |                                  |                                    |                                  |        |  |
| Ted Bowsfield, R (6, 1)                               |   |                                 |                              |                                 |                              |                                 |                              |                                 |                              | 0 0 0 0 0 0 0                   |   |                                 |                              |                                 |                                  |                                    |                                  |        |  |
| Wes Stock, R (8, 1)<br>OBP: 0.125, SLG: 0.125         |   |                                 |                              |                                 |                              |                                 |                              |                                 |                              | 0 0 0 0 0 0 0                   |   |                                 |                              |                                 |                                  |                                    |                                  |        |  |
| Jose Tartabull, L (9, PH)<br>OBP: 0.185, SLG: 0.192   |   |                                 |                              |                                 |                              |                                 |                              |                                 |                              | 1 0 0 0 0 1 0                   |   |                                 |                              |                                 |                                  |                                    |                                  |        |  |
| <b>Inning Stats</b>                                   | R: 0<br>E: 0<br>K: 1<br>S: 5  | H: 0<br>LOB: 0<br>BB: 0<br>P: 5 | R: 0<br>E: 0<br>K: 0<br>S: 3 | H: 0<br>LOB: 0<br>BB: 0<br>P: 3 | R: 0<br>E: 0<br>K: 1<br>S: 5 | H: 0<br>LOB: 0<br>BB: 0<br>P: 5 | R: 0<br>E: 0<br>K: 1<br>S: 5 | H: 1<br>LOB: 1<br>BB: 0<br>P: 6 | R: 0<br>E: 0<br>K: 0<br>S: 3 | H: 0<br>LOB: 0<br>BB: 0<br>P: 3 | R: 0<br>E: 0<br>K: 0<br>S: 3                          | H: 0<br>LOB: 0<br>BB: 0<br>P: 3 | R: 0<br>E: 0<br>K: 1<br>S: 5 | H: 0<br>LOB: 1<br>BB: 1<br>P: 9 | 1B: 0<br>2B: 1<br>3B: 0<br>HR: 0 | SF: 0<br>SAC: 0<br>DP: 0<br>HBP: 0 | WP: 0<br>PB: 0<br>SB: 0<br>CS: 0 | PA: 29 |  |
| <b>PITCHER</b><br>Wally Bunker, R (1, 1)<br>ERA: 3.12 | IP 9.0<br>WLS W<br>BF 29<br>H 1<br>R 0<br>ER 0<br>SO 5<br>BB 1<br>IBB 0<br>HBP 0<br>BLK 0<br>WP 0<br>HR 0<br>S 38<br>P 42<br>ERA 0.00<br>WHIP 0.222 |                                 |                              |                                 |                              |                                 |                              |                                 |                              |                                 |   |                                 |                              |                                 |                                  |                                    |                                  |        |  |

**Kansas City Athletics @ Baltimore Orioles**  
 Memorial Stadium, Baltimore, MD  
 Fri Jul 03 1964, 7:05 PM EDT  
 Att. 11,035 - Unknown

|     |    |
|-----|----|
| AB  | 28 |
| R   | 0  |
| H   | 1  |
| RBI | 0  |
| BB  | 1  |
| SO  | 5  |
| LOB | 4  |

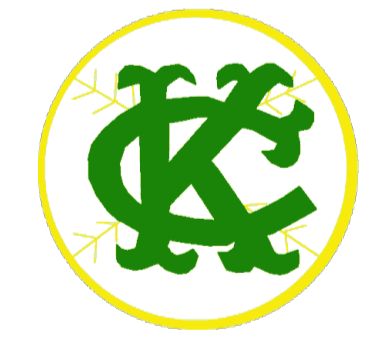

| Batter  | 1                     | 2                                 | 3          | 4         | 5          | 6               | 7          | 8                     | 9 | AB | R | H | RBI | BB | SO | LOB |
|---|-----------------------|-----------------------------------|------------|-----------|------------|-----------------|------------|-----------------------|---|----|---|---|-----|----|----|-----|
| Jackie Brandt, R<br>OBP: 0.322, SLG: 0.415 (1, 8)   | 0-0<br>F5             |                                   | 0-3<br>K   |           | 0-3<br>K   |                 |            | 0-0<br>F7             |   | 4  | 0 | 0 | 0   | 0  | 2  | 0   |
| Bob Johnson, R<br>OBP: 0.342, SLG: 0.438<br>Bob Saverine, S<br>OBP: 0.243, SLG: 0.182 (1, 6)<br>(9, 6)          | 0-0<br>G4-6-3<br>1B   |                                   | 1-0<br>HBP |           |            | 0-0<br>F5       |            | 0-0<br>HR             |   | 3  | 1 | 2 | 1   | 0  | 0  | 0   |
| Boog Powell, L<br>OBP: 0.367, SLG: 0.598<br>Gino Cimoli, R<br>OBP: 0.167, SLG: 0.222 (1, 7)<br>(9, 7)           | 0-0<br>G4-6-3<br>1-2f |                                   | 0-3<br>K   |           |            | 0-3<br>K        |            | 0-0<br>4-3            |   | 4  | 0 | 0 | 0   | 0  | 2  | 2   |
| Norm Siebern, L<br>OBP: 0.415, SLG: 0.379 (1, 3)  |                       | 4-0<br>1B<br>E<br>BB              |            | 0-0<br>L8 |            | 4-0<br>1B<br>BB |            | 0-0<br>E4<br>1B<br>1B |   | 2  | 2 | 0 | 0   | 2  | 0  | 0   |
| Brooks Robinson, R<br>OBP: 0.369, SLG: 0.486 (1, 5)   |                       | 0-3<br>K                          |            | 0-0<br>HR |            | 0-0<br>1B       |            | 0-0<br>1B<br>1B       |   | 4  | 1 | 3 | 1   | 0  | 1  | 1   |
| Charlie Lau, L<br>OBP: 0.335, SLG: 0.413<br>Dick Brown, R<br>OBP: 0.248, SLG: 0.306 (1, 2)<br>(6, PH)<br>(7, 2) |                       | 0-0<br>E<br>1B                    |            | 0-3<br>K  |            | 0-0<br>F8       |            | 0-0<br>1B<br>1B       |   | 2  | 0 | 1 | 0   | 0  | 1  | 0   |
| Willie Kirkland, L<br>OBP: 0.290, SLG: 0.309 (1, 9)   |                       | 0-0<br>E3<br>G6-4-3<br>1-2<br>3-H |            | 0-0<br>F7 |            |                 | 0-0<br>5-3 | 0-0<br>F3             |   | 4  | 0 | 0 | 1   | 0  | 0  | 3   |
| Jerry Adair, R<br>OBP: 0.291, SLG: 0.319 (1, 4)   |                       | 0-0<br>G6-4-3<br>1-2f             |            | 0-3<br>K  |            | 0-0<br>K        |            | 0-0<br>F9             |   | 3  | 0 | 0 | 0   | 0  | 1  | 2   |
| Wally Bunker, R<br>OBP: 0.125, SLG: 0.129 (1, 1)  |                       |                                   | 0-3<br>K   |           | 0-0<br>5-3 |                 | 0-3<br>K   |                       |   | 3  | 0 | 0 | 0   | 0  | 2  | 0   |

| Inning Stats | R: 0  | H: 1   | E: 0  | K: 0 | S: 3   | R: 1  | H: 1  | E: 1   | K: 1  | S: 6  | R: 0   | H: 0  | E: 0 | K: 3   | S: 9  | R: 1   | H: 1  | E: 0 | K: 1   | S: 6  | R: 0 | H: 0  | E: 0   | K: 2  | S: 7   | R: 0  | H: 1   | E: 0 | K: 1 | S: 6 | R: 0 | H: 0 | E: 0 | K: 1 | S: 5 | R: 2 | H: 3 | E: 1 | K: 0 | S: 7 |
|--------------|-------|--------|-------|------|--------|-------|-------|--------|-------|-------|--------|-------|------|--------|-------|--------|-------|------|--------|-------|------|-------|--------|-------|--------|-------|--------|------|------|------|------|------|------|------|------|------|------|------|------|------|
| LOB: 0       | BB: 0 | LOB: 1 | BB: 1 | P: 3 | LOB: 1 | BB: 1 | P: 10 | LOB: 0 | BB: 0 | P: 10 | LOB: 0 | BB: 0 | P: 7 | LOB: 2 | BB: 1 | LOB: 0 | BB: 0 | P: 5 | LOB: 2 | BB: 0 | P: 7 | SF: 0 | SAC: 0 | DP: 2 | HBP: 1 | WP: 0 | PA: 34 |      |      |      |      |      |      |      |      |      |      |      |      |      |

| PITCHER                              | IP  | WLS | BF | H | R | ER | SO | BB | IBB | HBP | BLK | WP | HR | S  | P  | ERA  | WHIP  |
|--------------------------------------|-----|-----|----|---|---|----|----|----|-----|-----|-----|----|----|----|----|------|-------|
| Orlando Pena, R<br>ERA: 4.07 (1, 1)  | 5.2 | L   | 23 | 4 | 2 | 2  | 8  | 2  | 0   | 1   | 0   | 0  | 1  | 36 | 45 | 3.18 | 1.059 |
| Ted Bowsfield, L<br>ERA: 4.78 (6, 1) | 2.0 |     | 9  | 2 | 2 | 1  | 1  | 0  | 0   | 0   | 0   | 0  | 1  | 11 | 11 | 4.50 | 1.000 |
| Wes Stock, R<br>ERA: 3.18 (8, 1)     | 0.1 |     | 2  | 1 | 0 | 0  | 0  | 0  | 0   | 0   | 0   | 0  | 0  | 2  | 2  | 0.00 | 3.000 |

| PITCHER | IP | WLS | BF | H | R | ER | SO | BB | IBB | HBP | BLK | WP | HR | S | P | ERA | WHIP |
|---------|----|-----|----|---|---|----|----|----|-----|-----|-----|----|----|---|---|-----|------|
|         |    |     |    |   |   |    |    |    |     |     |     |    |    |   |   |     |      |

**Kansas City Athletics @ Baltimore Orioles**  
**Memorial Stadium, Baltimore, MD**  
 Fri Jul 03 1964, 7:05 PM EDT  
 Att. 11,035 - Unknown

livebaseballscorecards.com

|     |    |
|-----|----|
| AB  | 31 |
| R   | 4  |
| H   | 7  |
| RBI | 4  |
| BB  | 2  |
| SO  | 9  |
| LOB | 10 |



| Batter  | 1   | 2                                | 3                            | 4                               | 5                            | 6                               | 7                            | 8                               | 9                            | AB R H RBI BB SO LOB            | TOP                          |                                 |                              |                                 |                              |                                 |                              |                                 |                                  |                                    |   |        |
|---|---|----------------------------------|------------------------------|---------------------------------|------------------------------|---------------------------------|------------------------------|---------------------------------|------------------------------|---------------------------------|------------------------------|---------------------------------|------------------------------|---------------------------------|------------------------------|---------------------------------|------------------------------|---------------------------------|----------------------------------|------------------------------------|---|--------|
| Wayne Causey, L (1, 6)<br>OBP: 0.402, SLG: 0.391    | 0-0<br>3-1<br>1B<br>1B  | 0-0<br>F8                        |                              |                                 | 0-0<br>F7                    | 0-0<br>6-3                      |                              | 0-0<br>F8                       |                              | 5 1 1 0 0 0 3                   |                              |                                 |                              |                                 |                              |                                 |                              |                                 |                                  |                                    |   |        |
| George Williams, R (1, 4)<br>OBP: 0.266, SLG: 0.276 | 0-3<br>K  | 0-0<br>F4                        |                              |                                 | 0-0<br>HR<br>2B              |                                 | 0-0<br>HR<br>1B              | 0-0<br>F2                       |                              | 5 2 2 0 0 1 3                   |                              |                                 |                              |                                 |                              |                                 |                              |                                 |                                  |                                    |   |        |
| Manny Jimenez, L (1, 7)<br>OBP: 0.310, SLG: 0.519   | 0-0<br>1B<br>3-1<br>1-2<br>1B   |                                  | 0-0<br>HR                    |                                 | 0-0<br>HR                    |                                 | 0-0<br>HR                    |                                 | 0-0<br>F9                    | 4 3 4 5 0 0 0                   |                              |                                 |                              |                                 |                              |                                 |                              |                                 |                                  |                                    |   |        |
| Jose Tartabull, L (8, 7)<br>OBP: 0.179, SLG: 0.185  |   |                                  |                              |                                 | 2-H                          |                                 | 1-H                          |                                 |                              | 1 0 0 0 0 0 0                   |                              |                                 |                              |                                 |                              |                                 |                              |                                 |                                  |                                    |   |        |
| Rocky Colavito, R (1, 9)<br>OBP: 0.377, SLG: 0.526  | 0-0<br>3-1<br>1-2<br>2-3  |                                  | 0-0<br>F9                    |                                 | 0-3<br>K                     |                                 | 0-0<br>F7                    |                                 | 0-0<br>6-3                   | 5 0 0 0 0 1 2                   |                              |                                 |                              |                                 |                              |                                 |                              |                                 |                                  |                                    |   |        |
| Billy Bryan, L (1, 2)<br>OBP: 0.313, SLG: 0.577     | 0-0<br>BB<br>2-3<br>3-H<br>1B   |                                  | 0-0<br>1-3                   |                                 | 0-0<br>1B                    |                                 | 0-0<br>F4                    |                                 | 0-3<br>K                     | 5 0 2 1 0 1 0                   |                              |                                 |                              |                                 |                              |                                 |                              |                                 |                                  |                                    |   |        |
| George Alusik, R (1, 3)<br>OBP: 0.368, SLG: 0.352   | 4-0<br>1-2<br>BB  |                                  | 0-0<br>6-3                   |                                 | 0-0<br>F9                    |                                 | 0-0<br>2B                    |                                 |                              | 3 0 1 0 1 0 1                   |                              |                                 |                              |                                 |                              |                                 |                              |                                 |                                  |                                    |   |        |
| Nelson Mathews, R (1, 8)<br>OBP: 0.290, SLG: 0.348  | 0-3<br>K  |                                  |                              | 0-0<br>F8                       |                              | 0-0<br>1-3                      | 0-0<br>4-3                   |                                 |                              | 4 0 0 0 0 1 4                   |                              |                                 |                              |                                 |                              |                                 |                              |                                 |                                  |                                    |   |        |
| Rick Joseph, R (1, 5)<br>OBP: 0.283, SLG: 0.280     |   | 0-0<br>SH2-4<br>1B               |                              | 0-3<br>K                        |                              | 0-0<br>F8                       |                              | 0-0<br>1B                       |                              | 4 0 2 0 0 1 0                   |                              |                                 |                              |                                 |                              |                                 |                              |                                 |                                  |                                    |   |        |
| Moe Drabowsky, R (1, 1)<br>OBP: 0.036, SLG: 0.036   |   | 0-0<br>SH2-4                     |                              | 0-3<br>K                        |                              | 4-0<br>BB                       |                              | 0-3<br>K                        |                              | 0 0 0 0 0 0 0                   |                              |                                 |                              |                                 |                              |                                 |                              |                                 |                                  |                                    |   |        |
| Jose Santiago, R (1, 1)<br>OBP: 0.036, SLG: 0.036   |   |                                  |                              |                                 |                              |                                 |                              |                                 |                              | 1 0 0 0 0 0 1 0                 |                              |                                 |                              |                                 |                              |                                 |                              |                                 |                                  |                                    |   |        |
| Ted Bowsfield, R (5, 1)<br>OBP: 0.419, SLG: 0.534   |   |                                  |                              |                                 |                              |                                 |                              |                                 |                              | 0 0 0 0 0 0 0                   |                              |                                 |                              |                                 |                              |                                 |                              |                                 |                                  |                                    |   |        |
| Jim Gentile, L (6, PH)<br>OBP: 0.258, SLG: 0.336    |   |                                  |                              |                                 |                              |                                 |                              |                                 |                              | 0 0 0 0 0 1 0 0                 |                              |                                 |                              |                                 |                              |                                 |                              |                                 |                                  |                                    |   |        |
| Dick Green, R (6, PR)<br>OBP: 0.258, SLG: 0.336     |   |                                  |                              |                                 |                              |                                 |                              |                                 |                              | 0 0 0 0 0 0 0 0                 |                              |                                 |                              |                                 |                              |                                 |                              |                                 |                                  |                                    |   |        |
| Dan Fister, R (6, 1)<br>OBP: 0.258, SLG: 0.336      |   |                                  |                              |                                 |                              |                                 |                              |                                 |                              | 0 0 0 0 0 0 0 0                 |                              |                                 |                              |                                 |                              |                                 |                              |                                 |                                  |                                    |   |        |
| John Wyatt, R (7, 1)<br>OBP: 0.258, SLG: 0.336      |   | 1-2                              |                              |                                 |                              |                                 |                              |                                 |                              | 1 0 0 0 0 0 1 1                 |                              |                                 |                              |                                 |                              |                                 |                              |                                 |                                  |                                    |   |        |
| <b>Inning Stats</b>                                 | R: 1<br>E: 0<br>K: 2<br>S: 10   | H: 3<br>LOB: 3<br>BB: 1<br>P: 14 | R: 0<br>E: 0<br>K: 0<br>S: 4 | H: 1<br>LOB: 1<br>BB: 0<br>P: 4 | R: 1<br>E: 0<br>K: 0<br>S: 4 | H: 1<br>LOB: 0<br>BB: 0<br>P: 4 | R: 0<br>E: 0<br>K: 2<br>S: 7 | H: 0<br>LOB: 0<br>BB: 0<br>P: 7 | R: 2<br>E: 0<br>K: 1<br>S: 8 | H: 3<br>LOB: 1<br>BB: 0<br>P: 8 | R: 0<br>E: 0<br>K: 0<br>S: 3 | H: 0<br>LOB: 1<br>BB: 1<br>P: 7 | R: 2<br>E: 0<br>K: 0<br>S: 6 | H: 3<br>LOB: 1<br>BB: 0<br>P: 6 | R: 0<br>E: 0<br>K: 1<br>S: 6 | H: 1<br>LOB: 1<br>BB: 0<br>P: 6 | R: 0<br>E: 0<br>K: 1<br>S: 5 | H: 0<br>LOB: 0<br>BB: 0<br>P: 5 | 1B: 7<br>2B: 2<br>3B: 0<br>HR: 3 | SF: 0<br>SAC: 1<br>DP: 0<br>HBP: 0 | WP: 0<br>PB: 0<br>SB: 0<br>CS: 0  | PA: 41 |
| <b>PITCHER</b>                                      | IP<br>WLS<br>BF<br>H<br>R<br>ER<br>SO<br>BB<br>IBB<br>HBP<br>BLK<br>WP<br>HR<br>S<br>P<br>ERA<br>WHIP |                                  |                              |                                 |                              |                                 |                              |                                 |                              |                                 |                              |                                 |                              |                                 |                              |                                 |                              |                                 |                                  |                                    | IP<br>WLS<br>BF<br>H<br>R<br>ER<br>SO<br>BB<br>IBB<br>HBP<br>BLK<br>WP<br>HR<br>S<br>P<br>ERA<br>WHIP |        |
| Robin Roberts, R (1, 1)<br>ERA: 2.83                | 4.2<br>5<br>23<br>8<br>4<br>4<br>5<br>1<br>0<br>0<br>0<br>0<br>2<br>32<br>36<br>7.71<br>1.929         |                                  |                              |                                 |                              |                                 |                              |                                 |                              |                                 |                              |                                 |                              |                                 |                              |                                 |                              |                                 |                                  |                                    |   |        |
| Harvey Haddix, L (5, 1)<br>ERA: 2.37                | 1.1<br>5<br>0<br>0<br>0<br>0<br>0<br>1<br>0<br>0<br>0<br>0<br>0<br>4<br>8<br>0.00<br>0.750            |                                  |                              |                                 |                              |                                 |                              |                                 |                              |                                 |                              |                                 |                              |                                 |                              |                                 |                              |                                 |                                  |                                    |   |        |
| Dick Hall, R (7, 1)<br>ERA: 2.78                    | 2.0<br>10<br>4<br>2<br>2<br>1<br>0<br>0<br>0<br>0<br>0<br>0<br>1<br>12<br>12<br>9.00<br>2.000         |                                  |                              |                                 |                              |                                 |                              |                                 |                              |                                 |                              |                                 |                              |                                 |                              |                                 |                              |                                 |                                  |                                    |   |        |
| Stu Miller, R (9, 1)<br>ERA: 1.99                   | 1.0<br>3<br>0<br>0<br>0<br>0<br>1<br>0<br>0<br>0<br>0<br>0<br>0<br>5<br>5<br>0.00<br>0.000            |                                  |                              |                                 |                              |                                 |                              |                                 |                              |                                 |                              |                                 |                              |                                 |                              |                                 |                              |                                 |                                  |                                    |   |        |

Kansas City Athletics @ Baltimore Orioles  
 Memorial Stadium, Baltimore, MD  
 Sat Jul 04 1964, 7:05 PM EDT  
 Att: 37,922 - Unknown

|     |    |
|-----|----|
| AB  | 38 |
| R   | 6  |
| H   | 12 |
| RBI | 6  |
| BB  | 2  |
| SO  | 7  |
| LOB | 14 |



Batter 1 2 3 4 5 6 7 8 9 AB R H RBI BB SO LOB BOTTOM

|   |  |                         |            |                     |               |                 |            |                       |           |  |
|---|--|-------------------------|------------|---------------------|---------------|-----------------|------------|-----------------------|-----------|--|
| Jackie Brandt, R<br>OBP: 0.324, SLG: 0.413 (1, 8) X   | 0-0<br>6-3<br>1B                       | 0-0<br>BB<br>1B         |            | 0-0<br>6-3          |               | 4-0<br>BB<br>BB |            | 0-0<br>F9             |           | 4 0 1 0 1 0 1  |
| Bob Johnson, R<br>OBP: 0.344, SLG: 0.436 (1, 6) X     | 0-0<br>BB<br>1B                        | 0-0<br>F3               |            | 0-3<br>K            |               | 0-3<br>K        |            | 0-0<br>3-H<br>1B      |           | 5 1 2 1 0 2 2  |
| Boog Powell, L<br>OBP: 0.376, SLG: 0.615 (1, 7) B     | 4-0<br>1B<br>1-2<br>E<br>BB            | 0-0<br>BB<br>1B         |            |                     |               | 0-0<br>HR       |            | 0-0<br>4-3<br>1B      |           | 4 3 3 1 1 0 1  |
| Norm Siebern, L<br>OBP: 0.418, SLG: 0.379 (1, 3) X    | 0-0<br>FC6-4<br>1-3<br>2-H<br>2B<br>1B | 4-0<br>1-2<br>2-3<br>BB |            | 4-0<br>G5-4-3<br>BB |               | 0-0<br>4-3      |            | 0-0<br>F8             |           | 3 1 1 1 2 0 3  |
| Brooks Robinson, R<br>OBP: 0.366, SLG: 0.481 (1, 5) X | 0-0<br>E5<br>FC6-4<br>1-2<br>3-H       | 0-0<br>F8               |            | 0-0<br>G5-4-3<br>1B |               | 0-0<br>F9       |            | 0-0<br>5-3            |           | 5 0 1 1 0 0 5  |
| Charlie Lau, L<br>OBP: 0.331, SLG: 0.407 (5, PH)      | 0-0<br>FC6-4                           |                         | 0-0<br>6-3 |                     | 0-0<br>G5-4-3 |                 | 0-0        | 0-0                   |           | 2 0 0 0 0 0 2<br>2 0 1 1 0 0 2   |
| John Ciriano, R<br>OBP: 0.306, SLG: 0.394 (6, 2)      | 1-2<br>2-3<br>2B                       |                         |            | 1-2<br>2-3          |               | 2-H<br>1B       |            | 1B                    |           | 0 0 0 0 0 0 0<br>1 0 1 0 0 0 0<br>0 0 0 0 0 0 0  |
| Bob Saverine, S<br>OBP: 0.243, SLG: 0.182 (7, PR)     |  |                         |            |                     |               |                 |            |                       |           |  |
| Dick Brown, R<br>OBP: 0.254, SLG: 0.312 (8, 2)        |  |                         |            |                     |               |                 |            |                       |           |  |
| Chuck Estrada, R<br>OBP: 0.154, SLG: 0.154 (9, PR)    |  |                         |            |                     |               |                 |            |                       |           |  |
| Willie Kirkland, L<br>OBP: 0.288, SLG: 0.312 (1, 9) X | 0-0<br>1-3<br>3-H<br>2B                |                         | 0-0<br>3-1 |                     | 0-0<br>4-3    |                 | 0-0<br>F7  |                       | 0-0<br>F7 | 5 0 1 1 0 0 3  |
| Jerry Adair, R<br>OBP: 0.286, SLG: 0.313 (1, 4) X     | 0-0<br>5-3                             |                         | 0-0<br>6-3 |                     | 0-0<br>F5     |                 | 0-0<br>6-3 |                       | 0-0<br>F8 | 5 0 0 0 0 0 3  |
| Robin Roberts, S<br>OBP: 0.379, SLG: 0.111 (5, 1)     |  | 0-0<br>4-3              |            | 0-3<br>K            |               | 0-0<br>F3       |            | 0-0<br>PB<br>1B<br>2B |           | 2 0 0 0 0 0 1 0<br>0 0 0 0 0 0 0 0<br>1 0 0 0 0 0 0 0<br>0 0 0 0 0 0 0 0<br>1 1 1 0 0 0 0 0<br>0 0 0 0 0 0 0 0 |
| Harvey Haddix, L<br>OBP: 0.310, SLG: 0.420 (6, PH)    |  |                         |            |                     |               |                 |            |                       |           |  |
| Sam Bowers, R<br>OBP: 0.375, SLG: 0.286 (7, 1)        |  |                         |            |                     |               |                 |            |                       |           |  |
| Dick Hall, R<br>OBP: 0.194, SLG: 0.261 (8, PH)        |  |                         |            |                     |               |                 |            |                       |           |  |
| Gino Cimoli, R<br>OBP: 0.154, SLG: 0.261 (9, 1)       |  |                         |            |                     |               |                 |            |                       |           |  |
| Stu Miller, R<br>OBP: 0.154, SLG: 0.261 (9, 1)        |  |                         |            |                     |               |                 |            |                       |           |  |

Kansas City Athletics @ Baltimore Orioles  
Memorial Stadium, Baltimore, MD  
Sat Jul 04 1964, 7:05 PM EDT  
Att. 37,922 - Unknown

|     |    |
|-----|----|
| AB  | 40 |
| R   | 6  |
| H   | 12 |
| RBI | 6  |
| BB  | 4  |
| SO  | 3  |
| LOB | 22 |



|              |                              |                                  |                              |                                 |                              |                                 |                              |                                 |                              |                                 |                              |                                 |                              |                                 |                              |                                 |                              |                                 |                                  |                                    |                                  |        |
|--------------|------------------------------|----------------------------------|------------------------------|---------------------------------|------------------------------|---------------------------------|------------------------------|---------------------------------|------------------------------|---------------------------------|------------------------------|---------------------------------|------------------------------|---------------------------------|------------------------------|---------------------------------|------------------------------|---------------------------------|----------------------------------|------------------------------------|----------------------------------|--------|
| Inning Stats | R: 3<br>E: 1<br>K: 0<br>S: 7 | H: 3<br>LOB: 2<br>BB: 1<br>P: 11 | R: 0<br>E: 0<br>K: 0<br>S: 5 | H: 2<br>LOB: 3<br>BB: 1<br>P: 9 | R: 0<br>E: 0<br>K: 0<br>S: 3 | H: 0<br>LOB: 0<br>BB: 0<br>P: 3 | R: 0<br>E: 0<br>K: 2<br>S: 7 | H: 0<br>LOB: 0<br>BB: 0<br>P: 7 | R: 1<br>E: 0<br>K: 0<br>S: 4 | H: 2<br>LOB: 1<br>BB: 1<br>P: 8 | R: 0<br>E: 0<br>K: 1<br>S: 5 | H: 0<br>LOB: 1<br>BB: 1<br>P: 9 | R: 1<br>E: 0<br>K: 0<br>S: 5 | H: 2<br>LOB: 1<br>BB: 0<br>P: 5 | R: 1<br>E: 1<br>K: 0<br>S: 6 | H: 2<br>LOB: 2<br>BB: 0<br>P: 6 | R: 0<br>E: 0<br>K: 0<br>S: 4 | H: 1<br>LOB: 1<br>BB: 0<br>P: 4 | 1B: 9<br>2B: 2<br>3B: 0<br>HR: 1 | SF: 0<br>SAC: 0<br>DP: 1<br>HBP: 0 | WP: 0<br>PB: 1<br>SB: 0<br>CS: 0 | PA: 44 |
|--------------|------------------------------|----------------------------------|------------------------------|---------------------------------|------------------------------|---------------------------------|------------------------------|---------------------------------|------------------------------|---------------------------------|------------------------------|---------------------------------|------------------------------|---------------------------------|------------------------------|---------------------------------|------------------------------|---------------------------------|----------------------------------|------------------------------------|----------------------------------|--------|

| PITCHER                              | IP  | WLS | BF | H | R | ER | SO | BB | IBB | HBP | BLK | WP | HR | S  | P  | ERA   | WHIP  |
|--------------------------------------|-----|-----|----|---|---|----|----|----|-----|-----|-----|----|----|----|----|-------|-------|
| Moe Drabowsky, R<br>ERA: 5.71 (1, 1) | 0.2 |     | 7  | 3 | 3 | 2  | 0  | 1  | 0   | 0   | 0   | 0  | 0  | 6  | 10 | 27.00 | 6.000 |
| Jose Santiago, R<br>ERA: 3.33 (1, 1) | 3.1 |     | 16 | 4 | 1 | 1  | 2  | 2  | 0   | 0   | 0   | 0  | 1  | 18 | 26 | 2.70  | 1.800 |
| Ted Bowsfield, L<br>ERA: 4.7 (5, 1)  | 1.0 |     | 2  | 0 | 0 | 0  | 0  | 0  | 0   | 0   | 0   | 0  | 0  | 2  | 2  | 0.00  | 0.000 |
| Dan Pfister, R<br>ERA: 6.66 (6, 1)   | 1.0 |     | 5  | 1 | 1 | 1  | 1  | 1  | 0   | 0   | 0   | 0  | 0  | 6  | 10 | 9.00  | 2.000 |
| John Wyatt, R<br>ERA: 2.48 (7, 1)    | 3.0 |     | 14 | 4 | 1 | 1  | 0  | 0  | 0   | 0   | 0   | 0  | 0  | 14 | 14 | 3.00  | 1.333 |

| Batter  | 1                            | 2                               | 3                             | 4                               | 5                            | 6                               | 7                              | 8                                | 9                            | AB R H RBI BB SO LOB            |                              |                                 |                              |                                 |                              |                                 |                              |                                 |                                  |                                    |                                  |        |  |
|---|------------------------------|---------------------------------|-------------------------------|---------------------------------|------------------------------|---------------------------------|--------------------------------|----------------------------------|------------------------------|---------------------------------|------------------------------|---------------------------------|------------------------------|---------------------------------|------------------------------|---------------------------------|------------------------------|---------------------------------|----------------------------------|------------------------------------|----------------------------------|--------|--|
| <b>Wayne Causey, L</b><br>OBP: 0.402, SLG: 0.393<br>(1, 6) X  | 0-0<br>1-3<br>①              |                                 | 0-0<br>F5<br>②                | 4-0<br>IBB                      |                              |                                 | 0-0<br>SH<br>FC4-2-5<br>2B     |                                  | 0-0<br>F8<br>②               | 4 0 1 0 1 0 1                   |                              |                                 |                              |                                 |                              |                                 |                              |                                 |                                  |                                    |                                  |        |  |
| <b>George Williams, R</b><br>OBP: 0.265, SLG: 0.275<br>(1, 4) X   | 0-3<br>K<br>②                |                                 | 0-0<br>2B<br>1B               | 0-0<br>F8<br>③                  |                              |                                 | 0-0<br>SH<br>FC4-2-5<br>2-3    |                                  | 0-0<br>2-3<br>③              | 4 1 1 0 0 1 2                   |                              |                                 |                              |                                 |                              |                                 |                              |                                 |                                  |                                    |                                  |        |  |
| <b>Manny Jimenez, L</b><br>OBP: 0.308, SLG: 0.519<br><b>Jose Tartabull, L</b><br>OBP: 0.179, SLG: 0.185<br>(1, 7) X<br>(7, 7) X | 0-0<br>F9<br>③               |                                 | 0-0<br>1B<br>2B<br>1-H<br>2-H |                                 | 0-0<br>4-3<br>①              |                                 | 0-0<br>FC4-2-5<br>FC5-4<br>1-2 |                                  | 0-0<br>FC4-2-5<br>①          | 4 1 1 2 0 0 2<br>0 0 0 0 0 0 0  |                              |                                 |                              |                                 |                              |                                 |                              |                                 |                                  |                                    |                                  |        |  |
| <b>Rocky Colavito, R</b><br>OBP: 0.375, SLG: 0.522<br>(1, 9) X  |                              | 0-3<br>K<br>①                   | 0-0<br>1B<br>1B<br>2-H        |                                 | 0-0<br>F7<br>②               |                                 | 0-0<br>F5<br>②                 |                                  | 0-0<br>F5<br>②               | 4 0 1 1 0 1 2                   |                              |                                 |                              |                                 |                              |                                 |                              |                                 |                                  |                                    |                                  |        |  |
| <b>George Alusik, R</b><br>OBP: 0.371, SLG: 0.362<br>(1, 3) X   |                              | 0-0<br>F9<br>2B                 | 0-0<br>1B<br>1B<br>1-2        |                                 | 0-0<br>4-3<br>③              |                                 | 0-0<br>FC5-4<br>1-2f           |                                  | 0-0<br>FC5-4<br>③            | 4 0 2 0 0 0 2                   |                              |                                 |                              |                                 |                              |                                 |                              |                                 |                                  |                                    |                                  |        |  |
| <b>Doc Edwards, R</b><br>OBP: 0.229, SLG: 0.242<br>(1, 2) X   |                              | 0-0<br>F9<br>2-3                | 0-0<br>F6<br>③                |                                 |                              | 0-0<br>F7<br>①                  |                                | 0-0<br>5-3<br>①                  |                              | 4 0 0 0 0 0 3                   |                              |                                 |                              |                                 |                              |                                 |                              |                                 |                                  |                                    |                                  |        |  |
| <b>Nelson Mathews, R</b><br>OBP: 0.289, SLG: 0.346<br>(1, 8) X  |                              | 0-0<br>F8<br>③                  |                               | 0-0<br>E6<br>SH3<br>1B          |                              | 0-0<br>1B                       |                                | 0-0<br>5-3<br>②                  |                              | 4 0 1 0 0 0 1                   |                              |                                 |                              |                                 |                              |                                 |                              |                                 |                                  |                                    |                                  |        |  |
| <b>Rick Joseph, R</b><br>OBP: 0.263, SLG: 0.259<br>(1, 5) X   |                              |                                 | 0-0<br>6-3<br>①               | 0-3<br>K<br>①                   |                              | 0-3<br>K<br>②                   |                                | 0-0<br>1-3<br>③                  |                              | 4 0 0 0 0 2 2                   |                              |                                 |                              |                                 |                              |                                 |                              |                                 |                                  |                                    |                                  |        |  |
| <b>John O'Donoghue, R</b><br>OBP: 0.258, SLG: 0.355<br><b>Wes Stock, R</b><br>OBP: 0.125, SLG: 0.125<br>(1, 1) X<br>(9, 1) X    |                              |                                 | 0-0<br>1B<br>2B<br>1B<br>1-2  |                                 | 0-0<br>SH3<br>②              |                                 | 0-0<br>6-3<br>③                |                                  | 0-0<br>4-3<br>①              | 3 1 1 0 0 0 1<br>0 0 0 0 0 0 0  |                              |                                 |                              |                                 |                              |                                 |                              |                                 |                                  |                                    |                                  |        |  |
| <b>Inning Stats</b>   | R: 0<br>E: 0<br>K: 1<br>S: 5 | H: 0<br>LOB: 0<br>BB: 0<br>P: 5 | R: 0<br>E: 0<br>K: 1<br>S: 6  | H: 1<br>LOB: 1<br>BB: 0<br>P: 6 | R: 3<br>E: 0<br>K: 0<br>S: 8 | H: 5<br>LOB: 2<br>BB: 0<br>P: 8 | R: 0<br>E: 1<br>K: 1<br>S: 6   | H: 0<br>LOB: 2<br>BB: 1<br>P: 10 | R: 0<br>E: 0<br>K: 0<br>S: 3 | H: 0<br>LOB: 0<br>BB: 0<br>P: 3 | R: 0<br>E: 0<br>K: 1<br>S: 6 | H: 1<br>LOB: 1<br>BB: 0<br>P: 6 | R: 0<br>E: 0<br>K: 0<br>S: 5 | H: 1<br>LOB: 2<br>BB: 0<br>P: 5 | R: 0<br>E: 0<br>K: 0<br>S: 3 | H: 0<br>LOB: 0<br>BB: 0<br>P: 3 | R: 0<br>E: 0<br>K: 0<br>S: 3 | H: 0<br>LOB: 0<br>BB: 0<br>P: 3 | 1B: 5<br>2B: 3<br>3B: 0<br>HR: 0 | SF: 0<br>SAC: 2<br>DP: 0<br>HBP: 0 | WP: 0<br>PB: 0<br>SB: 0<br>CS: 0 | PA: 38 |  |
| <b>PITCHER</b>  | IP                           | WLS                             | BF                            | H                               | R                            | ER                              | SO                             | BB                               | IBB                          | HBP                             | BLK                          | WP                              | HR                           | S                               | P                            | ERA                             | WHIP                         |                                 |                                  |                                    |                                  |        |  |
| <b>Steve Barber, L</b><br>ERA: 4.05<br>(1, 1)   | 2.2                          | L                               | 14                            | 6                               | 3                            | 3                               | 2                              | 0                                | 0                            | 0                               | 0                            | 0                               | 0                            | 18                              | 18                           | 10.12                           | 2.250                        |                                 |                                  |                                    |                                  |        |  |
| <b>Chuck Estrada, R</b><br>ERA: 5.06<br>(3, 1)  | 2.1                          |                                 | 9                             | 0                               | 0                            | 0                               | 1                              | 0                                | 1                            | 0                               | 0                            | 0                               | 0                            | 10                              | 14                           | 0.00                            | 0.000                        |                                 |                                  |                                    |                                  |        |  |
| <b>Milt Pappas, R</b><br>ERA: 3.32<br>(6, 1)  | 3.0                          |                                 | 12                            | 2                               | 0                            | 0                               | 1                              | 0                                | 0                            | 0                               | 0                            | 0                               | 0                            | 14                              | 14                           | 0.00                            | 0.667                        |                                 |                                  |                                    |                                  |        |  |
| <b>Stu Miller, R</b><br>ERA: 1.95<br>(9, 1)   | 1.0                          |                                 | 3                             | 0                               | 0                            | 0                               | 0                              | 0                                | 0                            | 0                               | 0                            | 0                               | 0                            | 3                               | 3                            | 0.00                            | 0.000                        |                                 |                                  |                                    |                                  |        |  |

**Kansas City Athletics @ Baltimore Orioles**  
 Memorial Stadium, Baltimore, MD  
 Sun Jul 05 1964, 3:33 AM EDT  
 Att. 7,653 - Unknown

|     |    |
|-----|----|
| AB  | 35 |
| R   | 3  |
| H   | 8  |
| RBI | 3  |
| BB  | 1  |
| SO  | 4  |
| LOB | 16 |



| Batter  | 1       | 2      | 3             | 4              | 5       | 6 | 7 | 8               | 9 | AB | R | H | RBI | BB | SO | LOB |
|---|---------|--------|---------------|----------------|---------|---|---|-----------------|---|----|---|---|-----|----|----|-----|
| Jackie Brandt, R<br>OBP: 0.326, SLG: 0.418 (1, 8)   | 0-0 F8  |        | 0-0 5-3       |                | 0-0 1B  |   |   | 0-0 2B          |   | 4  | 0 | 2 | 0   | 0  | 0  | 0   |
| Bob Johnson, R<br>OBP: 0.341, SLG: 0.455 (1, 6)     | 0-0 G3  |        | 0-0 HR        |                | 0-0 1-3 |   |   | 0-0 F8          |   | 4  | 1 | 1 | 1   | 0  | 0  | 2   |
| Sam Bowens, R<br>OBP: 0.304, SLG: 0.411 (1, 7)      | 0-0 E5  |        | 0-0 E5 G4-3   |                |         |   |   | 0-0 L8          |   | 4  | 0 | 0 | 0   | 0  | 0  | 1   |
| Norm Siebern, L<br>OBP: 0.416, SLG: 0.374 (1, 3)    | 0-0 6-3 |        | 0-0 G4-3 1-2f |                |         |   |   | 0-0 BB          |   | 3  | 0 | 0 | 0   | 1  | 1  | 2   |
| Brooks Robinson, R<br>OBP: 0.365, SLG: 0.477 (1, 5) |         | 0-0 1B |               | 0-0 E4 FC6-4   |         |   |   | 0-0 F9          |   | 4  | 0 | 1 | 0   | 0  | 0  | 1   |
| Gino Cimoli, R<br>OBP: 0.173, SLG: 0.245 (1, 9)     |         | 0-0 F8 |               | 0-0 FC6-4 1-2f |         |   |   | 0-3 K           |   | 3  | 0 | 0 | 0   | 0  | 0  | 2   |
| Boog Powell, L (9, PH)<br>OBP: 0.375, SLG: 0.612    |         |        |               |                |         |   |   |                 |   | 1  | 0 | 0 | 0   | 0  | 1  | 1   |
| Jerry Adair, R<br>OBP: 0.286, SLG: 0.313 (1, 4)     |         | 0-0 F8 |               | 0-0 G6-3 1-2f  |         |   |   | 0-0 F7          |   | 3  | 0 | 1 | 0   | 0  | 0  | 2   |
| Charlie Lau, L (9, PH)<br>OBP: 0.329, SLG: 0.404    |         |        |               |                |         |   |   |                 |   | 1  | 0 | 0 | 0   | 0  | 0  | 1   |
| Dick Brown, R<br>OBP: 0.256, SLG: 0.313 (1, 2)      |         | 0-0 1B |               | 0-0 1-3        |         |   |   | 0-0 G6-4-3 1-2f |   | 3  | 0 | 1 | 0   | 0  | 0  | 1   |
| Steve Barber, L (1, 1)<br>OBP: 0.236, SLG: 0.200    |         | 0-0 F5 |               | 0-0 F9         |         |   |   | 0-0 F4          |   | 1  | 0 | 0 | 0   | 0  | 0  | 2   |
| Chuck Estrada, R (3, 1)<br>OBP: 0.154, SLG: 0.154   |         |        |               |                |         |   |   |                 |   | 0  | 0 | 0 | 0   | 0  | 0  | 0   |
| Luis Aparicio, R (5, PH)<br>OBP: 0.340, SLG: 0.397  |         |        |               |                |         |   |   |                 |   | 1  | 0 | 0 | 0   | 0  | 0  | 0   |
| Mill Pappas, R (6, 1)<br>OBP: 0.154, SLG: 0.111     |         |        |               |                |         |   |   |                 |   | 0  | 0 | 0 | 0   | 0  | 0  | 0   |
| John Orsino, R (8, PH)<br>OBP: 0.394, SLG: 0.391    |         |        |               |                |         |   |   |                 |   | 1  | 0 | 0 | 0   | 0  | 0  | 0   |
| Stu Miller, R (9, 1)                                |         |        |               |                |         |   |   |                 |   | 0  | 0 | 0 | 0   | 0  | 0  | 0   |

**BOTTOM**

**Kansas City Athletics @ Baltimore Orioles**  
**Memorial Stadium, Baltimore, MD**

Sun Jul 05 1964, 3:33 AM EDT  
 Att. 7,653 - Unknown

livebaseballscorecards.com

|            |           |
|------------|-----------|
| <b>AB</b>  | <b>33</b> |
| <b>R</b>   | <b>1</b>  |
| <b>H</b>   | <b>6</b>  |
| <b>RBI</b> | <b>1</b>  |
| <b>BB</b>  | <b>1</b>  |
| <b>SO</b>  | <b>2</b>  |
| <b>LOB</b> | <b>15</b> |



| Inning Stats | R: 0 | H: 0 | E: 1 | K: 0 | S: 4 | LOB: 1 | BB: 0 | P: 4 |
|--------------|------|------|------|------|------|--------|-------|------|
|              | R: 0 | H: 2 | E: 0 | K: 0 | S: 5 | LOB: 2 | BB: 0 | P: 5 |
|              | R: 1 | H: 1 | E: 1 | K: 0 | S: 4 | LOB: 0 | BB: 0 | P: 4 |
|              | R: 0 | H: 0 | E: 1 | K: 0 | S: 3 | LOB: 0 | BB: 0 | P: 3 |
|              | R: 0 | H: 1 | E: 0 | K: 0 | S: 4 | LOB: 1 | BB: 0 | P: 4 |
|              | R: 0 | H: 0 | E: 0 | K: 1 | S: 5 | LOB: 0 | BB: 0 | P: 5 |
|              | R: 0 | H: 1 | E: 0 | K: 0 | S: 3 | LOB: 0 | BB: 0 | P: 3 |
|              | R: 0 | H: 1 | E: 0 | K: 0 | S: 4 | LOB: 1 | BB: 0 | P: 4 |
|              | R: 0 | H: 0 | E: 0 | K: 1 | S: 5 | LOB: 1 | BB: 1 | P: 9 |

| PITCHER                                | IP  | WLS | BF | H | R | ER | SO | BB | IBB | HBP | BLK | WP | HR | S  | P  | ERA  | WHIP  |
|--|-----|-----|----|---|---|----|----|----|-----|-----|-----|----|----|----|----|------|-------|
| John O'Donoghue, L (1, 1)<br>ERA: 4.36 | 8.0 | W   | 30 | 6 | 1 | 1  | 1  | 0  | 0   | 0   | 0   | 0  | 1  | 32 | 32 | 1.12 | 0.750 |
| Wes Stock, R (9, 1)<br>ERA: 3.1        | 1.0 | S   | 4  | 0 | 0 | 0  | 1  | 1  | 0   | 0   | 0   | 0  | 0  | 5  | 9  | 0.00 | 1.000 |

|              |               |
|--------------|---------------|
| <b>WP: 0</b> | <b>PA: 34</b> |
| <b>PB: 0</b> |               |
| <b>SB: 0</b> |               |
| <b>CS: 0</b> |               |

| WP    | HR     | S | P | ERA | WHIP |
|-------|--------|---|---|-----|------|
| 1B: 4 | SF: 0  |   |   |     |      |
| 2B: 1 | SAC: 0 |   |   |     |      |
| 3B: 0 | DP: 3  |   |   |     |      |
| HR: 1 | HBP: 0 |   |   |     |      |

| Batter   | 1   | 2                                | 3                            | 4                               | 5                            | 6                               | 7                            | 8                               | 9                             | AB R H RBI BB SO LOB             | TOP                          |                                 |                              |                                 |                              |                                 |                                  |                                    |                                  |        |
|--|---|----------------------------------|------------------------------|---------------------------------|------------------------------|---------------------------------|------------------------------|---------------------------------|-------------------------------|----------------------------------|------------------------------|---------------------------------|------------------------------|---------------------------------|------------------------------|---------------------------------|----------------------------------|------------------------------------|----------------------------------|--------|
| Zoilo Versalles, R (1, 6)<br>OBP: 0.321, SLG: 0.428  | 0-3<br>K  |                                  | 0-0<br>5-3                   |                                 | 0-0<br>F3                    | 0-3<br>K                        |                              |                                 | 0-0<br>F3                     | 5 0 0 0 0 2 1                    |                              |                                 |                              |                                 |                              |                                 |                                  |                                    |                                  |        |
| Rich Rollins, R (1, 5)<br>OBP: 0.344, SLG: 0.434     | 0-0<br>6-3  |                                  | 0-0<br>3-1                   |                                 | 0-0<br>1-6-3<br>2B           |                                 |                              | 0-3<br>K                        |                               | 4 0 1 0 0 1 0                    |                              |                                 |                              |                                 |                              |                                 |                                  |                                    |                                  |        |
| Tony Oliva, L (1, 9)<br>OBP: 0.368, SLG: 0.587       | 0-0<br>2B   |                                  | 0-0<br>2B                    |                                 | 0-0<br>1-6-3<br>2-3          |                                 |                              | 0-0<br>1-3                      |                               | 4 0 2 0 0 0 1                    |                              |                                 |                              |                                 |                              |                                 |                                  |                                    |                                  |        |
| Harmon Killebrew, R (1, 7)<br>OBP: 0.390, SLG: 0.622 | 4-0<br>BB   |                                  | 0-3<br>K                     |                                 | 0-3<br>K                     |                                 |                              | 0-3<br>K                        |                               | 3 0 0 0 1 3 2                    |                              |                                 |                              |                                 |                              |                                 |                                  |                                    |                                  |        |
| Bob Allison, R (1, 8)<br>OBP: 0.437, SLG: 0.662      | 0-3<br>K  |                                  |                              | 0-3<br>K                        |                              | 0-0<br>HR                       |                              | 0-3<br>K                        |                               | 4 1 1 1 0 3 2                    |                              |                                 |                              |                                 |                              |                                 |                                  |                                    |                                  |        |
| Don Mincher, L (1, 3)<br>OBP: 0.353, SLG: 0.664      |   | 0-0<br>F5                        |                              | 0-0<br>6-3<br>2B                |                              | 0-0<br>HR                       |                              | 0-0<br>L4                       |                               | 4 1 2 1 0 0 0                    |                              |                                 |                              |                                 |                              |                                 |                                  |                                    |                                  |        |
| Earl Battey, R (1, 2)<br>OBP: 0.326, SLG: 0.391      |   | 0-0<br>F9                        |                              | 4-0<br>6-3<br>BB                |                              | 0-0<br>2B                       |                              | 0-0<br>F9                       |                               | 3 0 1 0 1 0 0                    |                              |                                 |                              |                                 |                              |                                 |                                  |                                    |                                  |        |
| Jim Snyder, R (1, 4)<br>OBP: 0.333, SLG: 0.324       |   | 0-0<br>1B                        |                              | 0-0<br>6-3<br>1-2<br>2-3        |                              | 0-3<br>K                        |                              |                                 | 0-3<br>K                      | 4 0 1 0 0 2 3                    |                              |                                 |                              |                                 |                              |                                 |                                  |                                    |                                  |        |
| Jim Kaat, L (1, 1)<br>OBP: 0.306, SLG: 0.349         |   | 0-0<br>F7                        |                              | 0-3<br>K                        |                              | 0-3<br>K                        |                              |                                 | 0-0<br>3-1                    | 4 0 0 0 0 2 4                    |                              |                                 |                              |                                 |                              |                                 |                                  |                                    |                                  |        |
| <b>Inning Stats</b>                                  | R: 0<br>E: 0<br>K: 2<br>S: 8                          | H: 1<br>LOB: 2<br>BB: 1<br>P: 12 | R: 0<br>E: 0<br>K: 0<br>S: 4 | H: 1<br>LOB: 1<br>BB: 0<br>P: 4 | R: 0<br>E: 0<br>K: 1<br>S: 6 | H: 1<br>LOB: 1<br>BB: 0<br>P: 6 | R: 0<br>E: 0<br>K: 1<br>S: 6 | H: 1<br>LOB: 1<br>BB: 0<br>P: 6 | R: 2<br>E: 0<br>K: 3<br>S: 12 | H: 3<br>LOB: 1<br>BB: 0<br>P: 12 | R: 0<br>E: 0<br>K: 2<br>S: 7 | H: 0<br>LOB: 0<br>BB: 0<br>P: 7 | R: 0<br>E: 0<br>K: 1<br>S: 5 | H: 0<br>LOB: 0<br>BB: 0<br>P: 5 | R: 0<br>E: 0<br>K: 1<br>S: 5 | H: 0<br>LOB: 0<br>BB: 0<br>P: 5 | 1B: 1<br>2B: 5<br>3B: 0<br>HR: 2 | SF: 0<br>SAC: 0<br>DP: 0<br>HBP: 0 | WP: 0<br>PB: 0<br>SB: 0<br>CS: 0 | PA: 37 |
| <b>PITCHER</b>                                       | IP WLS BF H R ER SO BB IBB HBP BLK WP HR S P ERA WHIP |                                  |                              |                                 |                              |                                 |                              |                                 |                               |                                  |                              |                                 |                              |                                 |                              |                                 |                                  |                                    |                                  |        |
| Jose Santiago, R (1, 1)<br>ERA: 3.38                 | 5.0 L 24 7 2 2 6 2 0 0 0 0 0 2 34 42 3.60 1.800       |                                  |                              |                                 |                              |                                 |                              |                                 |                               |                                  |                              |                                 |                              |                                 |                              |                                 |                                  |                                    |                                  |        |
| Wes Stock, R (6, 1)<br>ERA: 2.89                     | 3.0 10 1 0 0 6 0 0 0 0 0 0 0 22 22 0.00 0.333         |                                  |                              |                                 |                              |                                 |                              |                                 |                               |                                  |                              |                                 |                              |                                 |                              |                                 |                                  |                                    |                                  |        |
| John Wyatt, R (9, 1)<br>ERA: 2.44                    | 1.0 3 0 0 0 1 0 0 0 0 0 0 0 5 5 0.00 0.000            |                                  |                              |                                 |                              |                                 |                              |                                 |                               |                                  |                              |                                 |                              |                                 |                              |                                 |                                  |                                    |                                  |        |

Minnesota Twins @ Kansas City Athletics  
Municipal Stadium, Kansas City, MO  
Thu Jul 09 1964, 8:05 PM EDT  
Att. 10,316 - Unknown

livebaseballscorecards.com

|     |    |
|-----|----|
| AB  | 35 |
| R   | 2  |
| H   | 8  |
| RBI | 2  |
| BB  | 2  |
| SO  | 13 |
| LOB | 13 |





| Batter  | 1   | 2                                   | 3                                | 4                               | 5                            | 6                               | 7                            | 8                               | 9                            | AB                              | R                            | H                               | RBI                          | BB                              | SO                           | LOB                              |                              |                                 |                                  |                                    |                                  |        |
|---|---|-------------------------------------|----------------------------------|---------------------------------|------------------------------|---------------------------------|------------------------------|---------------------------------|------------------------------|---------------------------------|------------------------------|---------------------------------|------------------------------|---------------------------------|------------------------------|----------------------------------|------------------------------|---------------------------------|----------------------------------|------------------------------------|----------------------------------|--------|
| Wayne Causey, L (1, 6)<br>OBP: 0.398, SLG: 0.388  | 0-3<br>K  |                                     | 0-0<br>F8                        |                                 |                              | 0-0<br>F2                       |                              | 0-0<br>FC1-6<br>2B              |                              | 4                               | 0                            | 0                               | 0                            | 0                               | 1                            | 1                                |                              |                                 |                                  |                                    |                                  |        |
| Ed Charles, R (1, 5)<br>OBP: 0.321, SLG: 0.368  | 0-0<br>F8   |                                     | 4-0<br>G6-4-3<br>BB              |                                 |                              | 0-3<br>K                        |                              | 0-0<br>1-3<br>2B                |                              | 3                               | 0                            | 1                               | 0                            | 1                               | 1                            | 0                                |                              |                                 |                                  |                                    |                                  |        |
| Ken Harrelson, R (1, 7)<br>OBP: 0.500, SLG: 1.250   | 0-0<br>BB<br>1B   |                                     | 0-0<br>G6-4-3<br>1-2f            |                                 |                              | 0-0<br>HR                       |                              | 0-0<br>5-3                      |                              | 4                               | 1                            | 2                               | 1                            | 0                               | 0                            | 3                                |                              |                                 |                                  |                                    |                                  |        |
| Rocky Colavito, R (1, 9)<br>OBP: 0.383, SLG: 0.526  | 4-0<br>1-2<br>BB  |                                     |                                  | 0-0<br>G4-6-3<br>1B             |                              | 0-0<br>1B                       |                              | 4-0<br>IBB                      |                              | 2                               | 0                            | 2                               | 0                            | 2                               | 0                            | 0                                |                              |                                 |                                  |                                    |                                  |        |
| Jim Gentile, L (1, 3)<br>OBP: 0.411, SLG: 0.522   | 0-3<br>K  |                                     |                                  | 0-0<br>G4-6-3<br>1-2f           |                              | 0-3<br>K                        |                              | 0-3<br>K                        |                              | 4                               | 0                            | 0                               | 0                            | 0                               | 3                            | 7                                |                              |                                 |                                  |                                    |                                  |        |
| Doc Edwards, R (1, 2)<br>OBP: 0.230, SLG: 0.242   |   | 0-0<br>1B                           |                                  | 0-0<br>F7                       |                              |                                 | 0-0<br>F3                    |                                 | 0-0<br>L4                    | 4                               | 0                            | 1                               | 0                            | 0                               | 0                            | 0                                |                              |                                 |                                  |                                    |                                  |        |
| Charlie Shoemaker, L (1, 4)<br>OBP: 0.250, SLG: 0.500   |   | 0-3<br>K                            |                                  |                                 | 0-0<br>F9                    |                                 | 0-0<br>4-3                   |                                 | 0-0<br>2B                    | 4                               | 0                            | 1                               | 0                            | 0                               | 1                            | 1                                |                              |                                 |                                  |                                    |                                  |        |
| Nelson Mathews, R (1, 8)<br>OBP: 0.286, SLG: 0.342  |   | 0-0<br>F9                           |                                  |                                 | 0-0<br>6-3                   |                                 | 0-0<br>F4                    |                                 | 0-3<br>K                     | 4                               | 0                            | 0                               | 0                            | 0                               | 1                            | 2                                |                              |                                 |                                  |                                    |                                  |        |
| Jose Santiago, R (1, 1)<br>Wes Stock, R (6, 1)<br>Dick Green, R (8, PH)<br>John Wyatt, R (9, 1)<br>George Alusik, R (9, PH) |   | 0-0<br>F7                           |                                  |                                 | 0-0<br>L4                    |                                 |                              | 0-0<br>FC1-6<br>1B              | 0-0<br>5-3                   | 2                               | 0                            | 0                               | 0                            | 0                               | 0                            | 1                                |                              |                                 |                                  |                                    |                                  |        |
| <b>Inning Stats</b>   | R: 0<br>E: 0<br>K: 2<br>S: 8                                  | H: 1<br>LOB: 2<br>BB: 1<br>P: 12    | R: 0<br>E: 0<br>K: 1<br>S: 6     | H: 1<br>LOB: 1<br>BB: 0<br>P: 6 | R: 0<br>E: 0<br>K: 0<br>S: 2 | H: 0<br>LOB: 0<br>BB: 1<br>P: 6 | R: 0<br>E: 0<br>K: 0<br>S: 3 | H: 1<br>LOB: 0<br>BB: 0<br>P: 3 | R: 0<br>E: 0<br>K: 0<br>S: 3 | H: 0<br>LOB: 0<br>BB: 0<br>P: 3 | R: 1<br>E: 0<br>K: 2<br>S: 9 | H: 2<br>LOB: 1<br>BB: 0<br>P: 9 | R: 0<br>E: 0<br>K: 0<br>S: 3 | H: 0<br>LOB: 0<br>BB: 0<br>P: 3 | R: 0<br>E: 0<br>K: 1<br>S: 7 | H: 2<br>LOB: 3<br>BB: 1<br>P: 11 | R: 0<br>E: 0<br>K: 1<br>S: 6 | H: 1<br>LOB: 1<br>BB: 0<br>P: 6 | 1B: 5<br>2B: 2<br>3B: 0<br>HR: 1 | SF: 0<br>SAC: 0<br>DP: 2<br>HBP: 0 | WP: 0<br>PB: 0<br>SB: 0<br>CS: 0 | PA: 36 |
| <b>PITCHER</b><br>Jim Kaat, L (1, 1)<br>ERA: 3.38   | IP: 9.0<br>WLS: W<br>BF: 36<br>H: 8<br>R: 1<br>ER: 1<br>SO: 7 | BB: 2<br>IBB: 1<br>HBP: 0<br>BLK: 0 | WP: 0<br>HR: 1<br>S: 47<br>P: 59 | ERA: 1.00<br>WHIP: 1.111        |                              |                                 |                              |                                 |                              |                                 |                              |                                 |                              |                                 |                              |                                  |                              |                                 |                                  |                                    |                                  |        |

**BOTTOM**

**Minnesota Twins @ Kansas City Athletics**  
 Municipal Stadium, Kansas City, MO  
 Thu Jul 09 1964, 8:05 PM EDT  
 Att. 10,316 - Unknown

|            |           |
|------------|-----------|
| <b>AB</b>  | <b>33</b> |
| <b>R</b>   | <b>1</b>  |
| <b>H</b>   | <b>8</b>  |
| <b>RBI</b> | <b>1</b>  |
| <b>BB</b>  | <b>3</b>  |
| <b>SO</b>  | <b>7</b>  |
| <b>LOB</b> | <b>16</b> |



| Batter  | 1   | 2  | 3  | 4   | 5  | 6  | 7  | 8   | 9  | AB R H RBI BB SO LOB  | TOP                                     |
|---|---|--|--|---|--|--|--|---|--|---|---|
| Zoilo Versalles, R (1, 6)<br>OBP: 0.324, SLG: 0.432   | 0-0 F3  | 0-0 1B                                     |  | 0-0 1B 2B                                   | 0-0 1B 1B                                  |  | 0-0 F8                                     |   | 0-3 K  | 6 2 3 1 0 1 1   |   |
| Rich Rollins, R (1, 5)<br>OBP: 0.355, SLG: 0.441  | 4-0 1B BB   | 0-0 1B                                     |  | 0-0 HR 1B                                   | 0-0 1B                                     |  |  | 4-0 BB                                      | 0-0 1B                                       | 4 1 4 2 2 0 0   |   |
| Tony Oliva, L (1, 9)<br>OBP: 0.371, SLG: 0.594  | 0-0 1B  |  | 0-0 1B                                     | 0-0 HR                                      | 0-0 4-3                                    |  |  | 0-0 F9                                      | 0-3 K  | 6 1 3 2 0 1 4   |   |
| Harmon Killebrew, R (1, 7)<br>OBP: 0.390, SLG: 0.628<br>Jimmie Hall, L (9, 8)<br>OBP: 0.306, SLG: 0.482 | 0-0 F6  |  | 0-3 K                                      | 1-0 HBP HBP                                 |  | 0-0 HR                                     |  | 0-0 F7                                      |  | 4 1 1 1 0 1 4<br>0 0 0 0 0 0 0                              |   |
| Bob Allison, R (1, 8)<br>OBP: 0.436, SLG: 0.656   | 0-0 F4  |  | 0-0 FC6 1B                                 | 1-0 HBP                                     |  | 0-0 5-3                                    |  | 0-0 F3                                      |  | 4 0 1 0 0 0 3   |   |
| Don Mincher, L (1, 3)<br>OBP: 0.355, SLG: 0.677   |   | 0-0 1B FC4-6 1B                            | 0-0 F7                                     | 0-0 4-3                                     |  | 0-0 1-3                                    |  |   | 0-0 HR                                       | 5 2 2 1 0 0 4   |   |
| Earl Battey, R (1, 2)<br>OBP: 0.332, SLG: 0.411<br>Jerry Zimmerman, R (9, 2)<br>OBP: 0.299, SLG: 0.250  |   | 0-0 FC4-6 1B                               | 0-0 FC6                                    |   | 0-0 SH5-4 1B 1B                            |  | 0-0 F8                                     |   | 0-0 HR                                       | 5 2 3 1 0 0 2<br>0 0 0 0 0 0 0                              |   |
| Jim Snyder, R (1, 4)<br>OBP: 0.302, SLG: 0.289  |   | 0-3 K                                      |  | 0-0 F8                                      | 0-0 SH5-4                                  |  | 0-0 F5                                     |   | 0-0 4-3                                      | 4 0 0 0 0 1 2   |   |
| Mudcat Grant, R (1, 1)<br>OBP: 0.273, SLG: 0.439  |   | 0-0 FC4-6 1B                               |  | 0-3 K                                       | 0-3 K                                      |  | 0-0 F2                                     |   | 0-0 1B 1B                                    | 5 0 1 1 0 2 2   |   |
| <b>Inning Stats</b>   | R: 0 H: 1 E: 0 LOB: 2 K: 0 BB: 1 S: 4 P: 8            | R: 1 H: 4 E: 0 LOB: 2 K: 1 BB: 0 S: 8 P: 8 | R: 0 H: 2 E: 0 LOB: 2 K: 1 BB: 0 S: 7 P: 7 | R: 3 H: 3 E: 0 LOB: 2 K: 1 BB: 0 S: 8 P: 10 | R: 2 H: 3 E: 0 LOB: 1 K: 1 BB: 0 S: 8 P: 8 | R: 1 H: 1 E: 0 LOB: 0 K: 0 BB: 0 S: 4 P: 4 | R: 0 H: 0 E: 0 LOB: 0 K: 0 BB: 0 S: 3 P: 3 | R: 0 H: 0 E: 0 LOB: 1 K: 2 BB: 1 S: 11 P: 7 | R: 2 H: 4 E: 0 LOB: 2 K: 2 BB: 0 S: 11 P: 11 | 1B: 13 SF: 0<br>2B: 1 SAC: 1<br>3B: 0 DP: 0<br>HR: 4 HBP: 2 | WP: 0 PA: 48<br>PB: 0<br>SB: 0<br>CS: 0 |
| <b>PITCHER</b>  | IP WLS BF H R ER SO BB IBB HBP BLK WP HR S P ERA WHIP |  |  |   |  |  |  |   |  |   |   |
| Diego Segui, R (1, 1)<br>ERA: 3.96  | 3.2 L 20 9 3 3 3 1 0 0 0 0 0 0 25 29 7.36 2.727       |  |  |   |  |  |  |   |  |   |   |
| Dan Pfister, R (4, 1)<br>ERA: 7.01  | 0.0 3 1 1 1 0 0 0 0 2 0 0 0 1 1 3 ∞ ∞                 |  |  |   |  |  |  |   |  |   |   |
| Ted Bowsfield, L (4, 1)<br>ERA: 4.98  | 2.1 11 4 3 3 1 0 0 0 0 0 0 1 13 13 11.57 1.714        |  |  |   |  |  |  |   |  |   |   |
| Joe Grzenda, L (7, 1)<br>ERA: 5.12  | 2.0 7 0 0 0 0 1 0 0 0 0 0 0 6 10 0.00 0.500           |  |  |   |  |  |  |   |  |   |   |
| Moe Drabowsky, R (9, 1)<br>ERA: 5.85  | 1.0 7 4 2 2 2 0 0 0 0 0 0 2 11 11 18.00 4.000         |  |  |   |  |  |  |   |  |   |   |

Minnesota Twins @ Kansas City Athletics  
Municipal Stadium, Kansas City, MO  
Fri Jul 10 1964, 8:05 PM EDT  
Att. 11,988 - Unknown

|     |    |
|-----|----|
| AB  | 43 |
| R   | 9  |
| H   | 18 |
| RBI | 9  |
| BB  | 2  |
| SO  | 6  |
| LOB | 22 |



| Batter  | 1         | 2       | 3      | 4 | 5       | 6          | 7       | 8            | 9            | AB | R | H | RBI | BB | SO | LOB |
|---|-----------|---------|--------|---|---------|------------|---------|--------------|--------------|----|---|---|-----|----|----|-----|
| Wayne Causey, L (1, 6)<br>OBP: 0.396, SLG: 0.386      | 0-0 F7    |         | 0-0 F7 |   |         | 0-0 G4-6-3 |         | 0-0 1B       |              | 4  | 0 | 1 | 1   | 0  | 0  | 1   |
| Ed Charles, R (1, 5)<br>OBP: 0.320, SLG: 0.366        | 0-0 E8 1B |         | 0-0 F7 |   |         | 0-3 K      |         | 0-0 4-3      |              | 4  | 0 | 1 | 0   | 0  | 1  | 2   |
| Ken Harrelson, R (1, 7)<br>OBP: 0.375, SLG: 0.750     | 0-3 K     |         |        |   | 0-0 F8  |            | 0-3 K   |              | 0-0 E6 1B HR | 4  | 1 | 1 | 0   | 0  | 2  | 1   |
| Rocky Colavito, R (1, 9)<br>OBP: 0.382, SLG: 0.532    | 0-0 F5    |         |        |   | 0-0 F3  |            | 0-0 4-3 |              | 0-0 HR       | 4  | 1 | 1 | 2   | 0  | 0  | 1   |
| Jim Gentile, L (1, 3)<br>OBP: 0.404, SLG: 0.511       |           |         |        |   | 0-0 F6  |            | 0-0 F7  |              | 0-0 F8       | 4  | 0 | 0 | 0   | 0  | 0  | 0   |
| Billy Bryan, L (1, 2)<br>OBP: 0.319, SLG: 0.579       |           | 4-0 BB  |        |   |         | 0-0 G3     |         | 0-0 1B 1B 2B | 0-0 F5       | 3  | 0 | 1 | 0   | 1  | 0  | 0   |
| Nelson Mathews, R (1, 8)<br>OBP: 0.284, SLG: 0.340    |           | 0-0 F5  |        |   | 0-0 6-3 |            |         | 0-0 1-3      | 0-0 1B       | 2  | 0 | 0 | 0   | 0  | 0  | 1   |
| Joe Grzenda, R (7, 1)                                 |           |         |        |   |         |            |         |              |              | 0  | 0 | 0 | 0   | 0  | 0  | 0   |
| Manny Jimenez, L (8, PH)<br>OBP: 0.306, SLG: 0.514    |           |         |        |   |         |            |         |              |              | 1  | 0 | 0 | 0   | 0  | 0  | 1   |
| Moe Drabowsky, R (9, 1)<br>OBP: 0.036, SLG: 0.036     |           |         |        |   |         |            |         |              |              | 0  | 0 | 0 | 0   | 0  | 0  | 0   |
| Doc Edwards, R (9, PH)<br>OBP: 0.235, SLG: 0.248      |           |         |        |   |         |            |         |              |              | 1  | 0 | 1 | 0   | 0  | 0  | 0   |
| Charlie Shoemaker, L (1, 4)<br>OBP: 0.250, SLG: 0.375 |           | 0-0 1-3 |        |   | 0-3 K   |            |         | 0-0 1B 1B    | 0-0 F8       | 4  | 1 | 1 | 0   | 0  | 1  | 2   |
| Diego Segui, R (1, 1)<br>OBP: 0.200, SLG: 0.256       |           |         | 0-3 K  |   |         |            |         | 0-0 1B       |              | 1  | 0 | 0 | 0   | 0  | 1  | 0   |
| Dan Pfister, R (4, 1)                                 |           |         |        |   |         |            |         |              |              | 0  | 0 | 0 | 0   | 0  | 0  | 0   |
| Ted Bowsfield, R (4, 1)                               |           |         |        |   |         |            |         |              |              | 0  | 0 | 0 | 0   | 0  | 0  | 0   |
| Jose Tartabull, L (6, PH)<br>OBP: 0.233, SLG: 0.241   |           |         |        |   |         |            |         | 0-0 1B       |              | 2  | 0 | 2 | 0   | 0  | 0  | 0   |

| Inning Stats | R: 0 | H: 1 | E: 1 | K: 1 | S: 6   | LOB: 1 | BB: 0 | P: 6 |
|--------------|------|------|------|------|--|--------|-------|------|
|              | R: 0 | H: 0 | E: 0 | K: 0 | S: 3 <td>LOB: 1</td> <td>BB: 1</td> <td>P: 7 </td> | LOB: 1 | BB: 1 | P: 7 |
|              | R: 0 | H: 0 | E: 0 | K: 1 | S: 5 <td>LOB: 0</td> <td>BB: 0</td> <td>P: 5 </td> | LOB: 0 | BB: 0 | P: 5 |
|              | R: 0 | H: 0 | E: 0 | K: 0 | S: 3 <td>LOB: 0</td> <td>BB: 0</td> <td>P: 3 </td> | LOB: 0 | BB: 0 | P: 3 |
|              | R: 0 | H: 0 | E: 0 | K: 1 | S: 5 <td>LOB: 0</td> <td>BB: 0</td> <td>P: 5 </td> | LOB: 0 | BB: 0 | P: 5 |
|              | R: 0 | H: 1 | E: 0 | K: 1 | S: 5 <td>LOB: 0</td> <td>BB: 0</td> <td>P: 5 </td> | LOB: 0 | BB: 0 | P: 5 |
|              | R: 0 | H: 0 | E: 0 | K: 1 | S: 5 <td>LOB: 0</td> <td>BB: 0</td> <td>P: 5 </td> | LOB: 0 | BB: 0 | P: 5 |
|              | R: 1 | H: 4 | E: 0 | K: 0 | S: 6 <td>LOB: 2</td> <td>BB: 0</td> <td>P: 6 </td> | LOB: 2 | BB: 0 | P: 6 |
|              | R: 2 | H: 3 | E: 1 | K: 0 | S: 6 <td>LOB: 1</td> <td>BB: 0</td> <td>P: 6 </td> | LOB: 1 | BB: 0 | P: 6 |

| PITCHER                            | IP  | WLS | BF | H | R | ER | SO | BB | IBB | HBP | BLK | WP | HR | S  | P  | ERA  | WHIP  |
|------------------------------------|-----|-----|----|---|---|----|----|----|-----|-----|-----|----|----|----|----|------|-------|
| Mudcat Grant, R (1, 1)<br>ERA: 4.9 | 9.0 | W   | 35 | 9 | 3 | 3  | 5  | 1  | 0   | 0   | 0   | 0  | 1  | 44 | 48 | 3.00 | 1.111 |

**BOTTOM**

**Minnesota Twins @ Kansas City Athletics**  
Municipal Stadium, Kansas City, MO  
Fri Jul 10 1964, 8:05 PM EDT  
Att. 11,988 - Unknown

| AB  | 34 |
|-----|----|
| R   | 3  |
| H   | 9  |
| RBI | 3  |
| BB  | 1  |
| SO  | 5  |
| LOB | 9  |

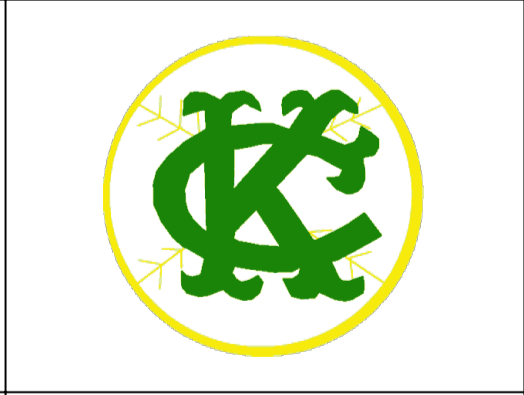

| WP | PA | 35 |
|----|----|----|
| PB | 0  |    |
| SB | 0  |    |
| CS | 0  |    |

| Batter  | 1   | 2                               | 3                            | 4                               | 5                            | 6                               | 7                            | 8                               | 9                            | AB R H RBI BB SO LOB                            | TOP  |                                 |                              |                                 |                              |                                 |                              |                                 |                                  |                                    |                                  |        |
|---|---|---------------------------------|------------------------------|---------------------------------|------------------------------|---------------------------------|------------------------------|---------------------------------|------------------------------|---|--|---------------------------------|------------------------------|---------------------------------|------------------------------|---------------------------------|------------------------------|---------------------------------|----------------------------------|------------------------------------|----------------------------------|--------|
| Zoilo Versalles, R (1, 6)<br>OBP: 0.330, SLG: 0.449   | 0-0<br>1B<br>2B                                       |                                 | 0-0<br>6-3                   |                                 | 0-0<br>3-H<br>HR             |                                 | 0-0<br>1-2<br>1B             |                                 | 0-0<br>1B                    | 5 2 4 2 0 0 0                                   | <b>Minnesota Twins @ Kansas City Athletics</b><br>Municipal Stadium, Kansas City, MO<br>Sat Jul 11 1964, 4:33 AM EDT<br>Att. 8,212 - Unknown<br><a href="http://livebaseballscorecards.com">livebaseballscorecards.com</a> |                                 |                              |                                 |                              |                                 |                              |                                 |                                  |                                    |                                  |        |
| Rich Rollins, R (1, 5)<br>OBP: 0.350, SLG: 0.434  | 0-3<br>K  |                                 | 0-0<br>F4                    |                                 | 0-3<br>K                     |                                 | 0-3<br>K                     |                                 | 0-0<br>F9                    | 5 0 0 0 0 3 4                                   |  |                                 |                              |                                 |                              |                                 |                              |                                 |                                  |                                    |                                  |        |
| Tony Oliva, L (1, 9)<br>OBP: 0.372, SLG: 0.594  | 0-0<br>F7   |                                 | 0-0<br>F9                    |                                 |                              | 4-0<br>F8<br>E<br>SF7<br>BB     |                              | 0-0<br>F9<br>2B                 |                              | 3 1 1 0 1 0 1                                   |  |                                 |                              |                                 |                              |                                 |                              |                                 |                                  |                                    |                                  |        |
| Harmon Killebrew, R (1, 7)<br>OBP: 0.388, SLG: 0.622<br>Jimmie Hall, L (9, 8)<br>OBP: 0.306, SLG: 0.482                             | 0-0<br>2-H<br>1B                                      |                                 |                              | 0-3<br>K                        |                              | 0-0<br>F8<br>1-3                |                              | 0-0<br>5-3                      |                              | 4 0 1 1 0 1 2<br>0 0 0 0 0 0 0                  |  |                                 |                              |                                 |                              |                                 |                              |                                 |                                  |                                    |                                  |        |
| Bob Allison, R (1, 8)<br>OBP: 0.431, SLG: 0.649   | 0-0<br>G3   |                                 |                              | 0-0<br>5-3                      |                              | 0-0<br>SF7                      |                              | 0-0<br>F9                       |                              | 3 0 0 1 0 0 2                                   |  |                                 |                              |                                 |                              |                                 |                              |                                 |                                  |                                    |                                  |        |
| Don Mincher, L (1, 3)<br>OBP: 0.359, SLG: 0.692   |   | 0-0<br>HR                       |                              | 0-3<br>K                        |                              | 0-3<br>3-H<br>K                 |                              | 4-0<br>F9<br>FC6-4<br>BB        |                              | 3 1 1 1 1 2 0                                   |  |                                 |                              |                                 |                              |                                 |                              |                                 |                                  |                                    |                                  |        |
| Earl Battey, R (1, 2)<br>OBP: 0.335, SLG: 0.417   |   | 0-0<br>F8                       |                              |                                 | 0-0<br>SH1-3<br>HR<br>2B     |                                 | 0-0<br>1B<br>1B              | 0-0<br>FC6-4<br>1-2f            |                              | 4 1 2 0 0 0 2                                   |  |                                 |                              |                                 |                              |                                 |                              |                                 |                                  |                                    |                                  |        |
| Jim Snyder, R (1, 4)<br>OBP: 0.283, SLG: 0.268  |   | 0-0<br>5-3                      |                              |                                 | 0-0<br>SH1-3<br>2-3          |                                 | 0-0<br>L4                    |                                 | 0-0<br>F4                    | 3 0 0 0 0 0 1                                   |  |                                 |                              |                                 |                              |                                 |                              |                                 |                                  |                                    |                                  |        |
| Camilo Pascual, R (1, 1)<br>OBP: 0.264, SLG: 0.300<br>Bill Pleis, L (9, 1)<br>OBP: 0.667, SLG: 0.500<br>Johnny Klippstein, R (9, 1) |   | 0-0<br>F8                       |                              |                                 | 0-0<br>6-3                   |                                 | 0-0<br>F3                    |                                 | 0-0<br>6-3                   | 4 0 0 0 0 0 2<br>0 0 0 0 0 0 0<br>0 0 0 0 0 0 0 |  |                                 |                              |                                 |                              |                                 |                              |                                 |                                  |                                    |                                  |        |
| <b>Inning Stats</b>   | R: 1<br>E: 0<br>K: 1<br>S: 7                          | H: 2<br>LOB: 1<br>BB: 0<br>P: 7 | R: 1<br>E: 0<br>K: 0<br>S: 4 | H: 1<br>LOB: 0<br>BB: 0<br>P: 4 | R: 0<br>E: 0<br>K: 0<br>S: 3 | H: 0<br>LOB: 0<br>BB: 0<br>P: 3 | R: 0<br>E: 0<br>K: 2<br>S: 7 | H: 0<br>LOB: 0<br>BB: 0<br>P: 7 | R: 2<br>E: 0<br>K: 1<br>S: 7 | H: 2<br>LOB: 0<br>BB: 0<br>P: 7                 | R: 1<br>E: 1<br>K: 1<br>S: 5   | H: 0<br>LOB: 0<br>BB: 1<br>P: 9 | R: 0<br>E: 0<br>K: 1<br>S: 7 | H: 2<br>LOB: 2<br>BB: 0<br>P: 7 | R: 0<br>E: 0<br>K: 0<br>S: 4 | H: 1<br>LOB: 2<br>BB: 1<br>P: 8 | R: 0<br>E: 0<br>K: 0<br>S: 4 | H: 1<br>LOB: 1<br>BB: 0<br>P: 4 | 1B: 4<br>2B: 3<br>3B: 0<br>HR: 2 | SF: 1<br>SAC: 1<br>DP: 0<br>HBP: 0 | WP: 0<br>PB: 0<br>SB: 0<br>CS: 0 | PA: 38 |
| <b>PITCHER</b>  | IP WLS BF H R ER SO BB IBB HBP BLK WP HR S P ERA WHIP |                                 |                              |                                 |                              |                                 |                              |                                 |                              |   |  |                                 |                              |                                 |                              |                                 |                              |                                 |                                  |                                    |                                  |        |
| Orlando Pena, R (1, 1)<br>ERA: 4.2  | 5.0 L 20 5 4 4 4 0 0 0 0 0 0 2 28 28 7.20 1.000       |                                 |                              |                                 |                              |                                 |                              |                                 |                              |   |  |                                 |                              |                                 |                              |                                 |                              |                                 |                                  |                                    |                                  |        |
| Wes Stock, R (6, 1)<br>ERA: 2.7   | 3.0 14 3 1 0 2 2 0 0 0 0 0 0 16 24 0.00 1.667         |                                 |                              |                                 |                              |                                 |                              |                                 |                              |   |  |                                 |                              |                                 |                              |                                 |                              |                                 |                                  |                                    |                                  |        |
| Dan Pfister, R (9, 1)<br>ERA: 6.75  | 1.0 4 1 0 0 0 0 0 0 0 0 0 0 4 4 0.00 1.000            |                                 |                              |                                 |                              |                                 |                              |                                 |                              |   |  |                                 |                              |                                 |                              |                                 |                              |                                 |                                  |                                    |                                  |        |

**Minnesota Twins @ Kansas City Athletics**  
Municipal Stadium, Kansas City, MO  
Sat Jul 11 1964, 4:33 AM EDT  
Att. 8,212 - Unknown

|     |    |
|-----|----|
| AB  | 34 |
| R   | 5  |
| H   | 9  |
| RBI | 5  |
| BB  | 2  |
| SO  | 6  |
| LOB | 14 |



| Batter   | 1          | 2                | 3                     | 4         | 5        | 6          | 7           | 8                    | 9                             | AB | R | H | RBI | BB | SO | LOB |
|--|------------|------------------|-----------------------|-----------|----------|------------|-------------|----------------------|-------------------------------|----|---|---|-----|----|----|-----|
| <b>Wayne Causey, L</b> (1, 6)<br>OBP: 0.396, SLG: 0.386  | 0-0<br>3-1 |                  | 0-0<br>G6-4-3<br>1B   |           | 0-3<br>K |            |             | 0-0<br>F3            | 0-0<br>1-3<br>1B              | 5  | 0 | 2 | 0   | 0  | 1  | 1   |
| <b>Ed Charles, R</b> (1, 5)<br>OBP: 0.316, SLG: 0.360  | 0-0<br>F3  |                  | 0-3<br>K              |           |          | 0-3<br>K   |             | 0-0<br>FC5-4<br>1-2f | 0-3<br>K                      | 5  | 0 | 0 | 0   | 0  | 3  | 4   |
| <b>Ken Harrelson, R</b> (1, 7)<br>OBP: 0.250, SLG: 0.500   | 0-3<br>K   |                  | 0-0<br>G6-4-3<br>1-2f |           |          | 0-0<br>5-3 |             | 0-3<br>K             |                               | 4  | 0 | 0 | 0   | 0  | 2  | 2   |
| <b>Jim Gentile, L</b> (1, 3)<br>OBP: 0.402, SLG: 0.505   |            | 0-0<br>F8        |                       | 0-3<br>K  |          | 0-0<br>1B  |             |                      | 0-3<br>K                      | 4  | 0 | 1 | 0   | 0  | 2  | 0   |
| <b>Rocky Colavito, R</b> (1, 9)<br>OBP: 0.383, SLG: 0.535  |            | 0-0<br>WP<br>2B  |                       | 0-0<br>F7 |          | 0-0<br>F6  |             |                      | 0-0<br>BB<br>1B<br>1B         | 4  | 1 | 2 | 0   | 0  | 0  | 1   |
| <b>Billy Bryan, L</b> (1, 2)<br>OBP: 0.317, SLG: 0.564<br><b>Charlie Shoemaker, L</b> (9, PR)<br>OBP: 0.250, SLG: 0.375  |            | 0-0<br>F6<br>2-3 |                       | 0-3<br>K  |          |            | 0-3<br>K2-3 |                      | 4-0<br>WP<br>1B<br>1B<br>BB   | 3  | 0 | 0 | 0   | 1  | 2  | 1   |
| <b>Nelson Mathews, R</b> (1, 8)<br>OBP: 0.287, SLG: 0.340  |            | 4-0<br>BB<br>BB  |                       |           |          | 0-0<br>F8  |             | 0-0<br>F7            | 0-0<br>1-2<br>2-H<br>1B<br>1B | 3  | 1 | 1 | 1   | 1  | 0  | 0   |
| <b>Dick Green, R</b> (1, 4)<br>OBP: 0.265, SLG: 0.352  |            | 4-0<br>1-2<br>BB |                       |           |          | 0-0<br>HR  |             | 0-0<br>5-3           | 0-3<br>1-2<br>2-3<br>K        | 3  | 1 | 1 | 1   | 1  | 1  | 2   |
| <b>Orlando Pena, R</b> (1, 1)<br>OBP: 0.130, SLG: 0.159<br><b>George Aluskic, R</b> (5, PH)<br>OBP: 0.367, SLG: 0.358<br><b>Wes Stock, R</b> (6, 1)<br>OBP: 0.125, SLG: 0.125<br><b>Jose Tartabull, L</b> (8, PH)<br>OBP: 0.259, SLG: 0.267<br><b>Dan Plister, R</b> (9, 1)<br><b>Manny Jimenez, L</b> (9, PH)<br>OBP: 0.311, SLG: 0.518<br><b>Ted Bowfield, R</b> (9, PR) |            | 0-0<br>F9        |                       |           |          | 0-3<br>K   |             | 0-0<br>FC5-4<br>1B   | 0-0<br>2-H<br>3-H<br>1B<br>1B | 1  | 0 | 0 | 0   | 0  | 0  | 3   |

**MINNESOTA TWINS @ KANSAS CITY ATHLETICS**  
**Municipal Stadium, Kansas City, MO**  
 Sat Jul 11 1964, 4:33 AM EDT  
 Att. 8,212 - Unknown

|     |    |
|-----|----|
| AB  | 35 |
| R   | 4  |
| H   | 9  |
| RBI | 4  |
| BB  | 3  |
| SO  | 12 |
| LOB | 14 |



| Inning Stats  |     |    |   |   |    |    |    |     |     |     |    |    |    |    |      | WP: 2   | PA: 38 |     |    |   |   |    |    |    |     |     |     |    |    |         |   |     |      |   |   |   |   |   |   |   |   |   |   |    |    |         |    |    |    |     |    |     |    |    |    |    |     |      |   |    |     |    |      |       |    |    |    |     |     |     |    |    |   |   |     |      |    |     |    |   |   |    |    |    |     |     |     |    |    |   |   |     |      |     |   |    |   |   |   |    |   |   |   |   |   |   |    |    |      |       |  |  |  |  |  |  |  |  |  |  |  |  |  |  |  |  |  |  |     |  |   |   |   |   |   |   |   |   |   |   |   |   |   |   |   |  |  |  |  |  |  |  |  |  |  |  |  |  |  |  |  |  |  |     |   |   |   |   |   |   |   |   |   |   |   |   |   |   |      |       |  |  |  |  |  |  |  |  |  |  |  |  |  |  |  |  |  |  |
|---|-----|----|---|---|----|----|----|-----|-----|-----|----|----|----|----|------|---------|--------|-----|----|---|---|----|----|----|-----|-----|-----|----|----|---------|---|-----|------|---|---|---|---|---|---|---|---|---|---|----|----|---------|----|----|----|-----|----|-----|----|----|----|----|-----|------|---|----|-----|----|------|-------|----|----|----|-----|-----|-----|----|----|---|---|-----|------|----|-----|----|---|---|----|----|----|-----|-----|-----|----|----|---|---|-----|------|-----|---|----|---|---|---|----|---|---|---|---|---|---|----|----|------|-------|--|--|--|--|--|--|--|--|--|--|--|--|--|--|--|--|--|--|-----|--|---|---|---|---|---|---|---|---|---|---|---|---|---|---|---|--|--|--|--|--|--|--|--|--|--|--|--|--|--|--|--|--|--|-----|---|---|---|---|---|---|---|---|---|---|---|---|---|---|------|-------|--|--|--|--|--|--|--|--|--|--|--|--|--|--|--|--|--|--|
| R   | H   | E  | K | S | R  | H  | E  | K   | S   | R   | H  | E  | K  | S  | R    | H       | E      | K   | S  | R | H | E  | K  | S  | R   | H   | E   | K  | S  | R       | H | E   | K    | S | R | H | E | K | S | R | H | E | K | S  | 1B | 2B      | 3B | HR | SF | SAC | DP | HBP | WP | PB | SB | CS | ERA | WHIP |   |    |     |    |      |       |    |    |    |     |     |     |    |    |   |   |     |      |    |     |    |   |   |    |    |    |     |     |     |    |    |   |   |     |      |     |   |    |   |   |   |    |   |   |   |   |   |   |    |    |      |       |  |  |  |  |  |  |  |  |  |  |  |  |  |  |  |  |  |  |     |  |   |   |   |   |   |   |   |   |   |   |   |   |   |   |   |  |  |  |  |  |  |  |  |  |  |  |  |  |  |  |  |  |  |     |   |   |   |   |   |   |   |   |   |   |   |   |   |   |      |       |  |  |  |  |  |  |  |  |  |  |  |  |  |  |  |  |  |  |
| 0   | 0   | 0  | 1 | 5 | 0  | 1  | 0  | 0   | 4   | 0   | 0  | 0  | 2  | 7  | 1    | 1       | 0      | 2   | 8  | 0 | 1 | 0  | 1  | 6  | 0   | 0   | 0   | 1  | 5  | 0       | 1 | 0   | 1    | 6 | 0 | 1 | 0 | 1 | 6 | 0 | 4 | 0 | 3 | 13 | 0  | 2       | 0  | 1  | 17 | 7   | 1  | 0   | 1  | 0  | 0  | 1  | 0   | 2    | 0 | 0  | 0   | 38 | 4.15 | 1.269 |    |    |    |     |     |     |    |    |   |   |     |      |    |     |    |   |   |    |    |    |     |     |     |    |    |   |   |     |      |     |   |    |   |   |   |    |   |   |   |   |   |   |    |    |      |       |  |  |  |  |  |  |  |  |  |  |  |  |  |  |  |  |  |  |     |  |   |   |   |   |   |   |   |   |   |   |   |   |   |   |   |  |  |  |  |  |  |  |  |  |  |  |  |  |  |  |  |  |  |     |   |   |   |   |   |   |   |   |   |   |   |   |   |   |      |       |  |  |  |  |  |  |  |  |  |  |  |  |  |  |  |  |  |  |
| <table border="1"> <thead> <tr> <th colspan="16">PITCHER</th> <th colspan="14">PITCHER</th> </tr> <tr> <th>IP</th><th>WLS</th><th>BF</th><th>H</th><th>R</th><th>ER</th><th>SO</th><th>BB</th><th>IBB</th><th>HBP</th><th>BLK</th><th>WP</th><th>HR</th><th>S</th><th>P</th><th>ERA</th><th>WHIP</th> <th>IP</th><th>WLS</th><th>BF</th><th>H</th><th>R</th><th>ER</th><th>SO</th><th>BB</th><th>IBB</th><th>HBP</th><th>BLK</th><th>WP</th><th>HR</th><th>S</th><th>P</th><th>ERA</th><th>WHIP</th> </tr> </thead> <tbody> <tr> <td>8.2</td><td>W</td><td>36</td><td>8</td><td>4</td><td>4</td><td>11</td><td>3</td><td>0</td><td>0</td><td>0</td><td>2</td><td>1</td><td>55</td><td>67</td><td>4.15</td><td>1.269</td> <td></td><td></td><td></td><td></td><td></td><td></td><td></td><td></td><td></td><td></td><td></td><td></td><td></td><td></td><td></td><td></td><td></td><td></td> </tr> <tr> <td>0.0</td><td></td><td>1</td><td>1</td><td>0</td><td>0</td><td>0</td><td>0</td><td>0</td><td>0</td><td>0</td><td>0</td><td>0</td><td>1</td><td>1</td><td>∞</td><td>∞</td> <td></td><td></td><td></td><td></td><td></td><td></td><td></td><td></td><td></td><td></td><td></td><td></td><td></td><td></td><td></td><td></td><td></td><td></td> </tr> <tr> <td>0.1</td><td>S</td><td>1</td><td>0</td><td>0</td><td>0</td><td>1</td><td>0</td><td>0</td><td>0</td><td>0</td><td>0</td><td>0</td><td>3</td><td>3</td><td>0.00</td><td>0.000</td> <td></td><td></td><td></td><td></td><td></td><td></td><td></td><td></td><td></td><td></td><td></td><td></td><td></td><td></td><td></td><td></td><td></td><td></td> </tr> </tbody> </table> |     |    |   |   |    |    |    |     |     |     |    |    |    |    |      |         |        |     |    |   |   |    |    |    |     |     |     |    |    | PITCHER |   |     |      |   |   |   |   |   |   |   |   |   |   |    |    | PITCHER |    |    |    |     |    |     |    |    |    |    |     |      |   | IP | WLS | BF | H    | R     | ER | SO | BB | IBB | HBP | BLK | WP | HR | S | P | ERA | WHIP | IP | WLS | BF | H | R | ER | SO | BB | IBB | HBP | BLK | WP | HR | S | P | ERA | WHIP | 8.2 | W | 36 | 8 | 4 | 4 | 11 | 3 | 0 | 0 | 0 | 2 | 1 | 55 | 67 | 4.15 | 1.269 |  |  |  |  |  |  |  |  |  |  |  |  |  |  |  |  |  |  | 0.0 |  | 1 | 1 | 0 | 0 | 0 | 0 | 0 | 0 | 0 | 0 | 0 | 1 | 1 | ∞ | ∞ |  |  |  |  |  |  |  |  |  |  |  |  |  |  |  |  |  |  | 0.1 | S | 1 | 0 | 0 | 0 | 1 | 0 | 0 | 0 | 0 | 0 | 0 | 3 | 3 | 0.00 | 0.000 |  |  |  |  |  |  |  |  |  |  |  |  |  |  |  |  |  |  |
| PITCHER   |     |    |   |   |    |    |    |     |     |     |    |    |    |    |      | PITCHER |        |     |    |   |   |    |    |    |     |     |     |    |    |         |   |     |      |   |   |   |   |   |   |   |   |   |   |    |    |         |    |    |    |     |    |     |    |    |    |    |     |      |   |    |     |    |      |       |    |    |    |     |     |     |    |    |   |   |     |      |    |     |    |   |   |    |    |    |     |     |     |    |    |   |   |     |      |     |   |    |   |   |   |    |   |   |   |   |   |   |    |    |      |       |  |  |  |  |  |  |  |  |  |  |  |  |  |  |  |  |  |  |     |  |   |   |   |   |   |   |   |   |   |   |   |   |   |   |   |  |  |  |  |  |  |  |  |  |  |  |  |  |  |  |  |  |  |     |   |   |   |   |   |   |   |   |   |   |   |   |   |   |      |       |  |  |  |  |  |  |  |  |  |  |  |  |  |  |  |  |  |  |
| IP  | WLS | BF | H | R | ER | SO | BB | IBB | HBP | BLK | WP | HR | S  | P  | ERA  | WHIP    | IP     | WLS | BF | H | R | ER | SO | BB | IBB | HBP | BLK | WP | HR | S       | P | ERA | WHIP |   |   |   |   |   |   |   |   |   |   |    |    |         |    |    |    |     |    |     |    |    |    |    |     |      |   |    |     |    |      |       |    |    |    |     |     |     |    |    |   |   |     |      |    |     |    |   |   |    |    |    |     |     |     |    |    |   |   |     |      |     |   |    |   |   |   |    |   |   |   |   |   |   |    |    |      |       |  |  |  |  |  |  |  |  |  |  |  |  |  |  |  |  |  |  |     |  |   |   |   |   |   |   |   |   |   |   |   |   |   |   |   |  |  |  |  |  |  |  |  |  |  |  |  |  |  |  |  |  |  |     |   |   |   |   |   |   |   |   |   |   |   |   |   |   |      |       |  |  |  |  |  |  |  |  |  |  |  |  |  |  |  |  |  |  |
| 8.2   | W   | 36 | 8 | 4 | 4  | 11 | 3  | 0   | 0   | 0   | 2  | 1  | 55 | 67 | 4.15 | 1.269   |        |     |    |   |   |    |    |    |     |     |     |    |    |         |   |     |      |   |   |   |   |   |   |   |   |   |   |    |    |         |    |    |    |     |    |     |    |    |    |    |     |      |   |    |     |    |      |       |    |    |    |     |     |     |    |    |   |   |     |      |    |     |    |   |   |    |    |    |     |     |     |    |    |   |   |     |      |     |   |    |   |   |   |    |   |   |   |   |   |   |    |    |      |       |  |  |  |  |  |  |  |  |  |  |  |  |  |  |  |  |  |  |     |  |   |   |   |   |   |   |   |   |   |   |   |   |   |   |   |  |  |  |  |  |  |  |  |  |  |  |  |  |  |  |  |  |  |     |   |   |   |   |   |   |   |   |   |   |   |   |   |   |      |       |  |  |  |  |  |  |  |  |  |  |  |  |  |  |  |  |  |  |
| 0.0   |     | 1  | 1 | 0 | 0  | 0  | 0  | 0   | 0   | 0   | 0  | 0  | 1  | 1  | ∞    | ∞       |        |     |    |   |   |    |    |    |     |     |     |    |    |         |   |     |      |   |   |   |   |   |   |   |   |   |   |    |    |         |    |    |    |     |    |     |    |    |    |    |     |      |   |    |     |    |      |       |    |    |    |     |     |     |    |    |   |   |     |      |    |     |    |   |   |    |    |    |     |     |     |    |    |   |   |     |      |     |   |    |   |   |   |    |   |   |   |   |   |   |    |    |      |       |  |  |  |  |  |  |  |  |  |  |  |  |  |  |  |  |  |  |     |  |   |   |   |   |   |   |   |   |   |   |   |   |   |   |   |  |  |  |  |  |  |  |  |  |  |  |  |  |  |  |  |  |  |     |   |   |   |   |   |   |   |   |   |   |   |   |   |   |      |       |  |  |  |  |  |  |  |  |  |  |  |  |  |  |  |  |  |  |
| 0.1   | S   | 1  | 0 | 0 | 0  | 1  | 0  | 0   | 0   | 0   | 0  | 0  | 3  | 3  | 0.00 | 0.000   |        |     |    |   |   |    |    |    |     |     |     |    |    |         |   |     |      |   |   |   |   |   |   |   |   |   |   |    |    |         |    |    |    |     |    |     |    |    |    |    |     |      |   |    |     |    |      |       |    |    |    |     |     |     |    |    |   |   |     |      |    |     |    |   |   |    |    |    |     |     |     |    |    |   |   |     |      |     |   |    |   |   |   |    |   |   |   |   |   |   |    |    |      |       |  |  |  |  |  |  |  |  |  |  |  |  |  |  |  |  |  |  |     |  |   |   |   |   |   |   |   |   |   |   |   |   |   |   |   |  |  |  |  |  |  |  |  |  |  |  |  |  |  |  |  |  |  |     |   |   |   |   |   |   |   |   |   |   |   |   |   |   |      |       |  |  |  |  |  |  |  |  |  |  |  |  |  |  |  |  |  |  |

| Batter   | 1  | 2   | 3   | 4   | 5  | 6   | 7   | 8   | 9   | AB R H RBI BB SO LOB                                       | TOP   |   |
|--|--|---|---|---|--|---|---|---|---|--|---|---|
| <b>Jim Landis, R</b> (1, 8)<br><small>OBP: 0.294, SLG: 0.306</small>   | 0-0<br>  |   | 0-0<br>5-3<br>                                      |   | 4-0<br>  |   | 4-0<br>   |   | 0-0<br>F3<br>                                       | 3 1 1 0 2 0 0  | <b>Chicago White Sox @ Kansas City Athletics</b><br>Municipal Stadium, Kansas City, MO<br>Sun Jul 12 1964, 4:33 AM EDT<br>Unknown |   |
| <b>Floyd Robinson, L</b> (1, 9)<br><small>OBP: 0.362, SLG: 0.431</small>   | 0-3<br>K<br>   |   | 0-0<br>4-3<br>                                      |   | 4-0<br>1-2<br>                                       |   | 0-0<br>FC4-6<br>                                    | 0-0<br>F6<br>                                       | 4 0 0 0 1 1 2                                       |  |   |   |
| <b>Jeoff Long, R</b> (1, 3)<br><b>Tom McCraw, L</b> (7, 3)<br><small>OBP: 0.361, SLG: 0.327</small><br><small>OBP: 0.354, SLG: 0.429</small>   | 0-0<br>  |   | 0-0<br>   |   | 0-3<br>K<br>   |   | 0-0<br>FC4-6<br>                                    |   | 4 0 2 1 0 1 3<br>0 0 0 0 0 0 0                      |  |   |   |
| <b>Pete Ward, L</b> (1, 5)<br><small>OBP: 0.338, SLG: 0.441</small>  | 0-0<br>F9<br>  |   | 0-0<br>4-3<br>                                      |   | 0-0<br>4-3<br>                                       |   |   | 0-0<br>   | 4 1 1 1 0 0 4                                       |  |   |   |
| <b>Ron Hansen, R</b> (1, 6)<br><small>OBP: 0.350, SLG: 0.368</small>   | 0-0<br>F9<br>  |   |   | 0-0<br>4-3<br>                                      |  | 0-0<br>F6<br>                                       |   | 0-0<br>5-3<br>                                      | 4 0 0 0 0 0 1                                       |  |   |   |
| <b>Dave Nicholson, R</b> (1, 7)<br><small>OBP: 0.351, SLG: 0.386</small>   |  | 0-3<br>K<br>  |   | 4-0<br>G5-3<br>                                     |  | 0-0<br>   |   | 0-0<br>FC4-6<br>                                    | 3 1 2 1 1 1 0                                       |  |   |   |
| <b>Al Weis, S</b> (1, 4)<br><small>OBP: 0.313, SLG: 0.344</small>  |  | 0-0<br>   |   | 0-0<br>1-2<br>                                      |  | 0-0<br>F9<br>                                       |   | 0-0<br>FC4-6<br>                                    | 4 0 2 0 0 0 1                                       |  |   |   |
| <b>Jerry McNertney, R</b> (1, 2)<br><small>OBP: 0.304, SLG: 0.311</small>  |  | 0-0<br>4-3<br>                                      |   | 0-0<br>G5-3<br>                                     |  | 0-0<br>6-3<br>                                      |   | 0-3<br>K2-3<br>                                     | 4 0 0 0 0 1 4                                       |  |   |   |
| <b>John Buzhardt, R</b> (1, 1)<br><small>OBP: 0.143, SLG: 0.121</small>  |  | 0-3<br>K<br>  |   | 0-3<br>K<br>  |  |   | 0-3<br>K<br>  | 0-0<br>F9<br>                                       | 4 0 0 0 0 3 1                                       |  |   |   |
| <b>Inning Stats</b>  | R: 1 H: 2<br>E: 0 LOB: 1<br>K: 1 BB: 0<br>S: 7 P: 7  | R: 0 H: 1<br>E: 0 LOB: 1<br>K: 2 BB: 0<br>S: 8 P: 8 | R: 0 H: 1<br>E: 0 LOB: 1<br>K: 0 BB: 1<br>S: 4 P: 4 | R: 0 H: 1<br>E: 0 LOB: 1<br>K: 0 BB: 1<br>S: 3 P: 7 | R: 0 H: 0<br>E: 0 LOB: 2<br>K: 2 BB: 2<br>S: 7 P: 15 | R: 1 H: 1<br>E: 0 LOB: 0<br>K: 0 BB: 0<br>S: 4 P: 4 | R: 0 H: 0<br>E: 0 LOB: 1<br>K: 1 BB: 1<br>S: 5 P: 9 | R: 1 H: 2<br>E: 0 LOB: 1<br>K: 1 BB: 0<br>S: 7 P: 7 | R: 0 H: 0<br>E: 0 LOB: 0<br>K: 0 BB: 0<br>S: 3 P: 3 | 1B: 5 SF: 0<br>2B: 1 SAC: 0<br>3B: 0 DP: 1<br>HR: 2 HBP: 0 | WP: 0 PA: 38<br>PB: 0<br>SB: 3<br>CS: 0   |   |
| <b>PITCHER</b><br><b>John O'Donoghue, L</b> (1, 1)<br><small>ERA: 4.31</small><br><b>Diego Segui, R</b> (8, 1)<br><small>ERA: 3.94</small><br><b>John Wyatt, R</b> (9, 1)<br><small>ERA: 2.4</small> | IP WLS BF H R ER SO BB IBB HBP BLK WP HR S P ERA WHIP<br>7.1 L 33 8 3 3 6 4 0 0 0 0 0 2 41 57 3.68 1.636<br>0.2 2 0 0 0 1 0 0 0 0 0 0 0 4 4 0.00 0.000<br>1.0 3 0 0 0 0 0 0 0 0 0 0 0 3 3 0.00 0.000 |   |   |   |  |   |   |   |   |  |   | <b>PITCHER</b><br>IP WLS BF H R ER SO BB IBB HBP BLK WP HR S P ERA WHIP |

livebaseballscorecards.com

|            |    |
|------------|----|
| <b>AB</b>  | 34 |
| <b>R</b>   | 3  |
| <b>H</b>   | 8  |
| <b>RBI</b> | 3  |
| <b>BB</b>  | 4  |
| <b>SO</b>  | 7  |
| <b>LOB</b> | 16 |



| Batter   | 1                      | 2                               | 3                   | 4               | 5                        | 6               | 7               | 8                | 9               | AB | R | H | RBI | BB | SO | LOB |
|--|------------------------|---------------------------------|---------------------|-----------------|--------------------------|-----------------|-----------------|------------------|-----------------|----|---|---|-----|----|----|-----|
| Wayne Causey, L<br>OBP: 0.395, SLG: 0.383<br>(1, 6)  | 0-0<br>4-3<br>①        |                                 | 4-0<br>WP HBP<br>BB |                 | 0-0<br>4-3<br>③          |                 |                 | 0-3<br>K<br>②    |                 | 3  | 0 | 0 | 0   | 1  | 1  | 2   |
| Ed Charles, R<br>OBP: 0.321, SLG: 0.363<br>(1, 5)  | 0-0<br>4-3<br>1B       |                                 | 1-0<br>WP HBP       |                 |                          | 0-0<br>6-3<br>① |                 | 0-0<br>2-H<br>1B |                 | 3  | 0 | 2 | 1   | 0  | 0  | 0   |
| Manny Jimenez, L<br>OBP: 0.302, SLG: 0.500<br>John Wyatt, R<br>(9, 1)  | 0-0<br>4-3<br>1-2<br>② |                                 | 0-0<br>F3<br>③      |                 |                          | 0-0<br>4-3<br>② |                 | 0-0<br>4-3<br>③  |                 | 4  | 0 | 0 | 0   | 0  | 0  | 4   |
| Jim Gentile, L<br>OBP: 0.395, SLG: 0.495<br>(1, 3)   | 0-3<br>K<br>③          |                                 |                     | 0-0<br>F7<br>①  |                          | 0-0<br>4-3<br>③ |                 |                  | 0-0<br>3-1<br>① | 4  | 0 | 0 | 0   | 0  | 1  | 1   |
| Rocky Colavito, R<br>OBP: 0.378, SLG: 0.528<br>(1, 9)  |                        | 0-0<br>5-3<br>①                 |                     | 0-0<br>6-3<br>② |                          | 0-3<br>K<br>①   |                 | 0-0<br>5-3<br>②  |                 | 4  | 0 | 0 | 0   | 0  | 1  | 0   |
| Billy Bryan, L<br>OBP: 0.315, SLG: 0.553<br>(1, 2)   |                        | 0-0<br>G6-4-3<br>1B             |                     | 0-0<br>F9<br>③  |                          | 0-0<br>F8<br>②  |                 | 0-0<br>1-3<br>③  |                 | 4  | 0 | 1 | 0   | 0  | 0  | 0   |
| Nelson Mathews, R<br>OBP: 0.284, SLG: 0.336<br>(1, 8)  |                        | 0-0<br>G6-4-3<br>1-2f<br>②<br>③ |                     | 0-0<br>3-1<br>① |                          | 0-0<br>5-3<br>③ |                 |                  |                 | 3  | 0 | 0 | 0   | 0  | 0  | 1   |
| Dick Green, R<br>OBP: 0.270, SLG: 0.361<br>(1, 4)  |                        |                                 | 0-0<br>F8<br>①      |                 | 0-0<br>SH1-4<br>1B       |                 | 0-0<br>1B<br>2B |                  |                 | 3  | 1 | 2 | 0   | 0  | 0  | 0   |
| John O'Donoghue, R<br>OBP: 0.250, SLG: 0.344<br>Diego Segui, R<br>OBP: 0.200, SLG: 0.256<br>Jose Tartabull, L<br>OBP: 0.250, SLG: 0.258<br>(8, PH)<br>(9, 7) |                        |                                 | 0-3<br>K<br>②       |                 | 0-0<br>SH1-4<br>1-2<br>② |                 | 0-0<br>F9<br>①  |                  |                 | 1  | 0 | 0 | 0   | 0  | 1  | 0   |

| Inning Stats | R: 0 | H: 1 | E: 0 | K: 1 | S: 6 | LOB: 1 | BB: 0 | P: 6 | R: 0 | H: 1 | E: 0 | K: 0 | S: 3 | LOB: 0 | BB: 0 | P: 3 | R: 0 | H: 0 | E: 0 | K: 1 | S: 5 | LOB: 2 | BB: 1 | P: 10 | R: 0 | H: 1 | E: 0 | K: 0 | S: 4 | LOB: 1 | BB: 0 | P: 4 | R: 0 | H: 0 | E: 0 | K: 0 | S: 3 | LOB: 0 | BB: 0 | P: 3 | R: 0 | H: 0 | E: 0 | K: 1 | S: 5 | LOB: 0 | BB: 0 | P: 5 | R: 1 | H: 2 | E: 0 | K: 1 | S: 7 | LOB: 1 | BB: 0 | P: 7 | R: 0 | H: 0 | E: 0 | K: 0 | S: 3 | LOB: 0 | BB: 0 | P: 3 | 1B: 4 | SF: 0 | 2B: 1 | SAC: 1 | 3B: 0 | DP: 1 | HR: 0 | HBP: 1 | WP: 1 | PA: 33 |
|--------------|------|------|------|------|------|--------|-------|------|------|------|------|------|------|--------|-------|------|------|------|------|------|------|--------|-------|-------|------|------|------|------|------|--------|-------|------|------|------|------|------|------|--------|-------|------|------|------|------|------|------|--------|-------|------|------|------|------|------|------|--------|-------|------|------|------|------|------|------|--------|-------|------|-------|-------|-------|--------|-------|-------|-------|--------|-------|--------|
|--------------|------|------|------|------|------|--------|-------|------|------|------|------|------|------|--------|-------|------|------|------|------|------|------|--------|-------|-------|------|------|------|------|------|--------|-------|------|------|------|------|------|------|--------|-------|------|------|------|------|------|------|--------|-------|------|------|------|------|------|------|--------|-------|------|------|------|------|------|------|--------|-------|------|-------|-------|-------|--------|-------|-------|-------|--------|-------|--------|

| PITCHER                                | IP  | WLS | BF | H | R | ER | SO | BB | IBB | HBP | BLK | WP | HR | S  | P  | ERA  | WHIP  |
|--|-----|-----|----|---|---|----|----|----|-----|-----|-----|----|----|----|----|------|-------|
| John Buzhardt, R<br>ERA: 3.0<br>(1, 1) | 9.0 | W   | 33 | 5 | 1 | 1  | 4  | 1  | 0   | 1   | 0   | 1  | 0  | 39 | 44 | 1.00 | 0.667 |

**BOTTOM**

**Chicago White Sox @ Kansas City Athletics**  
Municipal Stadium, Kansas City, MO

Sun Jul 12 1964, 4:33 AM EDT  
Unknown

livebaseballscorecards.com

|            |           |
|------------|-----------|
| <b>AB</b>  | <b>30</b> |
| <b>R</b>   | <b>1</b>  |
| <b>H</b>   | <b>5</b>  |
| <b>RBI</b> | <b>1</b>  |
| <b>BB</b>  | <b>1</b>  |
| <b>SO</b>  | <b>4</b>  |
| <b>LOB</b> | <b>9</b>  |



| Batter  | 1   | 2                                | 3                            | 4                               | 5                            | 6                               | 7                            | 8                               | 9                            | AB R H RBI BB SO LOB                            | TOP                          |                                 |                              |                                 |                               |                                  |                              |                                 |                                  |                                    |                                  |        |  |  |  |  |  |  |  |  |  |  |  |  |  |  |
|---|---|----------------------------------|------------------------------|---------------------------------|------------------------------|---------------------------------|------------------------------|---------------------------------|------------------------------|---|------------------------------|---------------------------------|------------------------------|---------------------------------|-------------------------------|----------------------------------|------------------------------|---------------------------------|----------------------------------|------------------------------------|----------------------------------|--------|--|--|--|--|--|--|--|--|--|--|--|--|--|--|
| Tom McCraw, L (1, 3)<br>OBP: 0.353, SLG: 0.423  | 0-0<br>F5   | 0-3<br>K                         |                              |                                 | 4-0<br>1B<br>SF7-5-3<br>BB   |                                 | 0-0<br>F4                    | 0-0<br>BB<br>HR<br>1B           | 0-0<br>G3                    | 5 2 1 1 1 1 3                                   |                              |                                 |                              |                                 |                               |                                  |                              |                                 |                                  |                                    |                                  |        |  |  |  |  |  |  |  |  |  |  |  |  |  |  |
| Don Buford, S (1, 4)<br>Al Weis, S (8, 4)<br>OBP: 0.320, SLG: 0.305<br>OBP: 0.313, SLG: 0.344   | 0-0<br>E9<br>SF7<br>2B                                |                                  | 0-0<br>4-3                   |                                 | 0-0<br>F8                    |                                 | 0-0<br>F8                    | 4-0<br>BB<br>HR<br>BB           |                              | 4 2 1 0 1 0 2<br>0 0 0 0 0 0 0                  |                              |                                 |                              |                                 |                               |                                  |                              |                                 |                                  |                                    |                                  |        |  |  |  |  |  |  |  |  |  |  |  |  |  |  |
| Floyd Robinson, L (1, 9)<br>Jim Landis, R (8, PR)<br>OBP: 0.366, SLG: 0.443<br>OBP: 0.294, SLG: 0.306   | 0-0<br>E5<br>SF7<br>S                                 |                                  | 0-0<br>F8                    |                                 | 0-0<br>1B<br>SF7-5-3         |                                 | 0-0<br>HR                    | 4-0<br>1-2<br>2-3<br>HR<br>BB   |                              | 4 1 2 2 1 0 1<br>0 1 0 0 0 0 0                  |                              |                                 |                              |                                 |                               |                                  |                              |                                 |                                  |                                    |                                  |        |  |  |  |  |  |  |  |  |  |  |  |  |  |  |
| Pete Ward, L (1, 5)<br>OBP: 0.343, SLG: 0.455   | 4-0<br>HBP<br>1-2<br>BB                               |                                  | 4-0<br>BB                    |                                 | 0-0<br>SF7-5-3               |                                 | 0-0<br>F8                    | 0-0<br>1-H<br>2-H<br>3-H<br>HR  |                              | 2 1 1 5 2 0 0                                   |                              |                                 |                              |                                 |                               |                                  |                              |                                 |                                  |                                    |                                  |        |  |  |  |  |  |  |  |  |  |  |  |  |  |  |
| Gene Stephens, L (1, 8)<br>OBP: 0.333, SLG: 0.375   | 0-0<br>SF7  |                                  | 0-0<br>4-3                   |                                 |                              |                                 | 0-0<br>F8                    |                                 | 0-0<br>K                     | 4 0 0 1 0 1 2                                   |                              |                                 |                              |                                 |                               |                                  |                              |                                 |                                  |                                    |                                  |        |  |  |  |  |  |  |  |  |  |  |  |  |  |  |
| Dave Nicholson, R (1, 7)<br>Mike Hershberger, R (1, PR)<br>OBP: 0.354, SLG: 0.386<br>OBP: 0.312, SLG: 0.328   | 1-0<br>HBP  |                                  |                              |                                 | 0-0<br>F8                    |                                 | 0-0<br>2B                    | 0-0<br>S<br>1B                  | 0-0<br>FC5-4<br>1B           | 0 0 0 0 0 0 0<br>4 1 3 0 0 0 0                  |                              |                                 |                              |                                 |                               |                                  |                              |                                 |                                  |                                    |                                  |        |  |  |  |  |  |  |  |  |  |  |  |  |  |  |
| Ron Hansen, R (1, 6)<br>OBP: 0.344, SLG: 0.361  | 0-3<br>K  |                                  | 0-3<br>K                     |                                 | 0-0<br>F4                    |                                 | 0-0<br>F4                    | 0-3<br>K                        | 0-3<br>K                     | 5 0 0 0 0 4 6                                   |                              |                                 |                              |                                 |                               |                                  |                              |                                 |                                  |                                    |                                  |        |  |  |  |  |  |  |  |  |  |  |  |  |  |  |
| J.C. Martin, L (1, 2)<br>OBP: 0.253, SLG: 0.314   |   |                                  | 0-0<br>4-3                   |                                 | 4-0<br>BB                    |                                 | 0-0<br>6-3                   | 4-0<br>1B<br>E<br>IBB           | 0-0<br>FC5-4<br>1B           | 3 1 0 0 2 0 2                                   |                              |                                 |                              |                                 |                               |                                  |                              |                                 |                                  |                                    |                                  |        |  |  |  |  |  |  |  |  |  |  |  |  |  |  |
| Eddie Fisher, R (1, 1)<br>Joe Cunningham, L (7, PH)<br>Hoyt Wilhelm, R (7, 1)<br>OBP: 0.091, SLG: 0.091<br>OBP: 0.355, SLG: 0.318<br>OBP: 0.273, SLG: 0.200 |   |                                  | 0-0<br>F3                    |                                 | 0-0<br>F2                    |                                 | 0-0<br>HR<br>2B              | 0-0<br>E2<br>1B<br>1B           | 0-0<br>1-2<br>1B             | 2 0 0 0 0 0 1<br>1 1 1 0 0 0 0<br>2 1 2 1 0 0 0 |                              |                                 |                              |                                 |                               |                                  |                              |                                 |                                  |                                    |                                  |        |  |  |  |  |  |  |  |  |  |  |  |  |  |  |
| <b>Inning Stats</b>   | R: 1<br>E: 2<br>K: 1<br>S: 7                          | H: 1<br>LOB: 3<br>BB: 1<br>P: 12 | R: 0<br>E: 0<br>K: 1<br>S: 5 | H: 0<br>LOB: 0<br>BB: 0<br>P: 5 | R: 0<br>E: 0<br>K: 0<br>S: 3 | H: 0<br>LOB: 1<br>BB: 1<br>P: 7 | R: 0<br>E: 0<br>K: 1<br>S: 5 | H: 0<br>LOB: 1<br>BB: 1<br>P: 9 | R: 1<br>E: 0<br>K: 0<br>S: 3 | H: 1<br>LOB: 0<br>BB: 1<br>P: 7                 | R: 0<br>E: 0<br>K: 0<br>S: 4 | H: 1<br>LOB: 1<br>BB: 0<br>P: 4 | R: 2<br>E: 0<br>K: 0<br>S: 5 | H: 2<br>LOB: 0<br>BB: 0<br>P: 5 | R: 7<br>E: 1<br>K: 2<br>S: 11 | H: 4<br>LOB: 1<br>BB: 3<br>P: 23 | R: 0<br>E: 0<br>K: 1<br>S: 7 | H: 2<br>LOB: 2<br>BB: 0<br>P: 7 | 1B: 6<br>2B: 4<br>3B: 0<br>HR: 2 | SF: 2<br>SAC: 0<br>DP: 1<br>HBP: 1 | WP: 0<br>PB: 0<br>SB: 2<br>CS: 0 | PA: 46 |  |  |  |  |  |  |  |  |  |  |  |  |  |  |
| <b>PITCHER</b>  | IP WLS BF H R ER SO BB IBB HBP BLK WP HR S P ERA WHIP |                                  |                              |                                 |                              |                                 |                              |                                 |                              |   |                              |                                 |                              |                                 |                               |                                  |                              |                                 |                                  |                                    |                                  |        |  |  |  |  |  |  |  |  |  |  |  |  |  |  |
| Moe Drabowsky, R (1, 1)<br>ERA: 5.72  | 6.2   |                                  | 30                           | 5                               | 4                            | 3                               | 3                            | 4                               | 0                            | 1   | 0                            | 0                               | 1                            | 31                              | 48                            | 4.05                             | 1.350                        |                                 |                                  |                                    |                                  |        |  |  |  |  |  |  |  |  |  |  |  |  |  |  |
| John Wyatt, R (7, 1)<br>ERA: 3.2  | 1.0   | L                                | 9                            | 3                               | 6                            | 6                               | 2                            | 2                               | 1                            | 0   | 0                            | 0                               | 0                            | 10                              | 22                            | 54.00                            | 5.000                        |                                 |                                  |                                    |                                  |        |  |  |  |  |  |  |  |  |  |  |  |  |  |  |
| Orlando Pena, R (8, 1)<br>ERA: 4.26   | 0.1   |                                  | 2                            | 1                               | 1                            | 1                               | 0                            | 0                               | 0                            | 0   | 0                            | 0                               | 1                            | 2                               | 2                             | 27.00                            | 3.000                        |                                 |                                  |                                    |                                  |        |  |  |  |  |  |  |  |  |  |  |  |  |  |  |
| Joe Grzenda, L (9, 1)<br>ERA: 4.87  | 1.0   |                                  | 5                            | 2                               | 0                            | 0                               | 1                            | 0                               | 0                            | 0   | 0                            | 0                               | 0                            | 7                               | 7                             | 0.00                             | 2.000                        |                                 |                                  |                                    |                                  |        |  |  |  |  |  |  |  |  |  |  |  |  |  |  |

Chicago White Sox @ Kansas City Athletics  
Municipal Stadium, Kansas City, MO  
Sun Jul 12 1964, 4:38 AM EDT  
Att: 18,611 - Unknown

|     |    |
|-----|----|
| AB  | 36 |
| R   | 11 |
| H   | 11 |
| RBI | 10 |
| BB  | 7  |
| SO  | 6  |
| LOB | 17 |





| Batter  | 1      | 2       | 3      | 4         | 5       | 6 | 7 | 8      | 9      | AB | R | H | RBI | BB | SO | LOB |
|---|--------|---------|--------|-----------|---------|---|---|--------|--------|----|---|---|-----|----|----|-----|
| Wayne Causey, L (1, 6)<br>OBP: 0.393, SLG: 0.379    | 0-0 F8 |         |        | 4-0 HR BB | 0-0 6-3 |   |   | 0-3 K  |        | 3  | 1 | 0 | 0   | 1  | 1  | 1   |
| Ed Charles, R (1, 5)<br>OBP: 0.317, SLG: 0.358      | 0-0 F8 |         |        | 0-0 F7    |         |   |   | 0-0 F9 |        | 4  | 0 | 0 | 0   | 0  | 1  | 1   |
| Manny Jimenez, L (1, 7)<br>OBP: 0.308, SLG: 0.551   | 0-0 F7 |         |        | 0-0 HR    |         |   |   |        | 0-0 F4 | 4  | 2 | 2 | 3   | 0  | 0  | 0   |
| Rocky Colavito, R (1, 9)<br>OBP: 0.377, SLG: 0.534  |        | 0-3 K   |        | 0-0 HR    |         |   |   |        | 0-0 F8 | 4  | 1 | 1 | 1   | 0  | 1  | 0   |
| Jim Gentile, L (1, 3)<br>OBP: 0.389, SLG: 0.485     |        | 0-0 4-3 |        | 0-0 6-3   |         |   |   |        | 0-0 F6 | 4  | 0 | 0 | 0   | 0  | 0  | 0   |
| Doc Edwards, R (1, 2)<br>OBP: 0.230, SLG: 0.243     |        | 0-3 K   |        | 0-0 F4    |         |   |   |        |        | 3  | 0 | 0 | 0   | 0  | 1  | 0   |
| Dave Duncan, R (9, 2)<br>OBP: 0.200, SLG: 0.200     |        |         |        |           |         |   |   |        |        | 0  | 0 | 0 | 0   | 0  | 0  | 0   |
| Dick Green, R (1, 4)<br>OBP: 0.267, SLG: 0.356      |        |         | 0-0 F7 |           | 0-0 F7  |   |   |        |        | 3  | 0 | 0 | 0   | 0  | 0  | 0   |
| Nelson Mathews, R (1, 8)<br>OBP: 0.284, SLG: 0.340  |        |         | 0-3 K  |           | 0-0 2B  |   |   |        |        | 3  | 0 | 1 | 0   | 0  | 1  | 0   |
| Moe Drabowsky, R (1, 1)<br>OBP: 0.033, SLG: 0.033   |        |         | 0-0 F2 |           | 0-0 F7  |   |   |        |        | 2  | 0 | 0 | 0   | 0  | 0  | 1   |
| John Wyatt, R (7, 1)                                |        |         |        |           |         |   |   |        |        | 0  | 0 | 0 | 0   | 0  | 0  | 0   |
| Orlando Pena, R (8, 1)<br>OBP: 0.130, SLG: 0.159    |        |         |        |           |         |   |   |        |        | 0  | 0 | 0 | 0   | 0  | 0  | 0   |
| Jose Tartabull, L (8, PH)<br>OBP: 0.242, SLG: 0.250 |        |         |        |           |         |   |   |        |        | 1  | 0 | 0 | 0   | 0  | 0  | 0   |
| Joe Grzenda, R (9, 1)                               |        |         |        |           |         |   |   |        |        | 0  | 0 | 0 | 0   | 0  | 0  | 0   |

| Inning Stats | R: 0 | H: 0 | E: 0 | K: 0 | S: 3 | R: 0 | H: 0 | E: 0 | K: 2 | S: 7 | R: 0 | H: 0 | E: 0 | K: 1 | S: 5 | R: 3 | H: 2 | E: 0 | K: 0 | S: 5 | R: 0 | H: 1 | E: 0 | K: 0 | S: 4 | R: 1 | H: 1 | E: 0 | K: 1 | S: 6 | R: 0 | H: 0 | E: 0 | K: 0 | S: 3 | R: 0 | H: 0 | E: 0 | K: 1 | S: 5 | R: 0 | H: 0 | E: 0 | K: 0 | S: 3 | R: 0 | H: 0 | E: 0 | K: 0 | S: 3 | 1B: 0 | SF: 0 | 2B: 1 | SAC: 0 | 3B: 0 | DP: 0 | HR: 3 | HBP: 0 | WP: 0 | PA: 32 |
|--------------|------|------|------|------|------|------|------|------|------|------|------|------|------|------|------|------|------|------|------|------|------|------|------|------|------|------|------|------|------|------|------|------|------|------|------|------|------|------|------|------|------|------|------|------|------|------|------|------|------|------|-------|-------|-------|--------|-------|-------|-------|--------|-------|--------|
|--------------|------|------|------|------|------|------|------|------|------|------|------|------|------|------|------|------|------|------|------|------|------|------|------|------|------|------|------|------|------|------|------|------|------|------|------|------|------|------|------|------|------|------|------|------|------|------|------|------|------|------|-------|-------|-------|--------|-------|-------|-------|--------|-------|--------|

| PITCHER                             | IP  | WLS | BF | H | R | ER | SO | BB | IBB | HBP | BLK | WP | HR | S  | P  | ERA  | WHIP  |
|-------------------------------------|-----|-----|----|---|---|----|----|----|-----|-----|-----|----|----|----|----|------|-------|
| Eddie Fisher, R (1, 1)<br>ERA: 3.7  | 6.0 |     | 23 | 4 | 4 | 4  | 4  | 1  | 0   | 0   | 0   | 0  | 3  | 30 | 34 | 6.00 | 0.833 |
| Hoyt Wilhelm, R (7, 1)<br>ERA: 1.99 | 3.0 | W   | 9  | 0 | 0 | 0  | 1  | 0  | 0   | 0   | 0   | 0  | 0  | 11 | 11 | 0.00 | 0.000 |

BOTTOM

Chicago White Sox @ Kansas City Athletics  
Municipal Stadium, Kansas City, MO  
Sun Jul 12 1964, 4:38 AM EDT  
Att. 18,611 - Unknown

|     |    |
|-----|----|
| AB  | 31 |
| R   | 4  |
| H   | 4  |
| RBI | 4  |
| BB  | 1  |
| SO  | 5  |
| LOB | 3  |



|       |        |
|-------|--------|
| WP: 0 | PA: 32 |
| PB: 0 |        |
| SB: 0 |        |
| CS: 0 |        |

livebaseballscores.com

| Batter  | 1   | 2                                | 3                            | 4                               | 5                            | 6                               | 7                            | 8                               | 9                            | AB R H RBI BB SO LOB             | TOP                          |                                  |                              |                                 |                              |                                 |                              |                                 |                                   |                                    |                                  |        |
|---|---|----------------------------------|------------------------------|---------------------------------|------------------------------|---------------------------------|------------------------------|---------------------------------|------------------------------|----------------------------------|------------------------------|----------------------------------|------------------------------|---------------------------------|------------------------------|---------------------------------|------------------------------|---------------------------------|-----------------------------------|------------------------------------|----------------------------------|--------|
| <b>Tom McCraw, L</b> (1, 3)<br>OBP: 0.350, SLG: 0.417       | 0-0<br>6-3  |                                  | 0-0<br>4-3<br>1B             | 0-0<br>4-3                      | 0-0<br>1-3                   |                                 | 0-0<br>6-3                   |                                 |                              | 5 1 1 0 0 0 2                    |                              |                                  |                              |                                 |                              |                                 |                              |                                 |                                   |                                    |                                  |        |
| <b>Don Buford, S</b> (1, 4)<br>OBP: 0.319, SLG: 0.304       | 0-0   |                                  | 0-0<br>4-3                   | 0-0<br>4-3                      |                              | 0-3<br>K2-3                     |                              | 0-0                             |                              | 4 0 1 0 0 1 2                    |                              |                                  |                              |                                 |                              |                                 |                              |                                 |                                   |                                    |                                  |        |
| <b>Al Weis, S</b> (6, 4)<br>OBP: 0.316, SLG: 0.347          | CS<br>1B  |                                  | 1-2                          |                                 |                              |                                 |                              | CS<br>1B                        |                              | 1 0 1 0 0 0 0                    |                              |                                  |                              |                                 |                              |                                 |                              |                                 |                                   |                                    |                                  |        |
| <b>Floyd Robinson, L</b> (1, 9)<br>OBP: 0.370, SLG: 0.444   | 4-0<br>BB<br>1-2<br>BB                                |                                  | 0-0<br>1B<br>1B              |                                 | 0-0<br>1B<br>SF9             |                                 | 0-0<br>1-3                   | 0-0<br>F1                       |                              | 4 2 2 1 1 0 1                    |                              |                                  |                              |                                 |                              |                                 |                              |                                 |                                   |                                    |                                  |        |
| <b>Pete Ward, L</b> (1, 5)<br>OBP: 0.352, SLG: 0.460        | 4-0<br>BB<br>1-2<br>BB                                |                                  | 0-0<br>1B<br>1B              |                                 | 0-0<br>SF9<br>S<br>2B        |                                 | 0-0<br>BB<br>1B              | 0-3<br>K<br>1-2                 |                              | 4 2 3 0 1 1 1                    |                              |                                  |                              |                                 |                              |                                 |                              |                                 |                                   |                                    |                                  |        |
| <b>Gene Stephens, L</b> (1, 7)<br>OBP: 0.340, SLG: 0.381    | 0-0<br>G3   |                                  | 0-0<br>1-3<br>1B             |                                 | 0-3<br>K                     |                                 | 4-0<br>BB<br>1B              |                                 | 0-3<br>K                     | 2 0 1 1 0 0 2                    |                              |                                  |                              |                                 |                              |                                 |                              |                                 |                                   |                                    |                                  |        |
| <b>Jim Landis, R</b> (5, PH)<br>OBP: 0.295, SLG: 0.301      |   |                                  | 1-3<br>3-H                   |                                 | 0-3<br>K                     |                                 | 1-2<br>BB                    |                                 | 0-3<br>K                     | 2 0 0 0 1 2 2                    |                              |                                  |                              |                                 |                              |                                 |                              |                                 |                                   |                                    |                                  |        |
| <b>Mike Hershberger, R</b> (1, 8)<br>OBP: 0.320, SLG: 0.335 |   | 0-0<br>FC4-6<br>1B               | 0-0<br>1B                    |                                 | 4-0<br>2B<br>HR<br>IBB       |                                 | 0-0<br>4-3                   |                                 | 0-0<br>CS<br>1B              | 4 1 3 1 1 0 2                    |                              |                                  |                              |                                 |                              |                                 |                              |                                 |                                   |                                    |                                  |        |
| <b>Ron Hansen, R</b> (1, 6)<br>OBP: 0.342, SLG: 0.360       |   | 0-3<br>K                         | 0-0<br>F7                    |                                 | 0-0<br>SF9                   |                                 | 0-0<br>WP<br>1B              |                                 | 0-3<br>K<br>1-2              | 4 0 1 1 0 2 3                    |                              |                                  |                              |                                 |                              |                                 |                              |                                 |                                   |                                    |                                  |        |
| <b>J.C. Martin, L</b> (1, 2)<br>OBP: 0.253, SLG: 0.319      |   | 0-0<br>FC4-6<br>1-2f             |                              | 0-0<br>3-1                      | 0-0<br>HR<br>2B              |                                 | 0-3<br>K                     |                                 | 0-3<br>K                     | 4 1 1 1 0 1 2                    |                              |                                  |                              |                                 |                              |                                 |                              |                                 |                                   |                                    |                                  |        |
| <b>Gary Peters, L</b> (1, 1)<br>OBP: 0.264, SLG: 0.396      |   | 0-0<br>4-3                       |                              | 0-0<br>1B                       | 0-0<br>HR                    |                                 | 0-3<br>K                     |                                 | 0-3<br>K                     | 3 1 2 3 0 0 1                    |                              |                                  |                              |                                 |                              |                                 |                              |                                 |                                   |                                    |                                  |        |
| <b>Hoyt Wilhelm, R</b> (6, 1)<br>OBP: 0.273, SLG: 0.200     |   |                                  |                              |                                 |                              |                                 |                              |                                 |                              | 0 0 0 0 0 0 0                    |                              |                                  |                              |                                 |                              |                                 |                              |                                 |                                   |                                    |                                  |        |
| <b>Joe Cunningham, L</b> (7, PH)<br>OBP: 0.352, SLG: 0.315  |   |                                  |                              |                                 |                              |                                 |                              |                                 |                              | 1 0 0 0 0 1 1                    |                              |                                  |                              |                                 |                              |                                 |                              |                                 |                                   |                                    |                                  |        |
| <b>Eddie Fisher, R</b> (7, 1)<br>OBP: 0.091, SLG: 0.091     |   |                                  |                              |                                 |                              |                                 |                              |                                 |                              | 0 0 0 0 0 0 0                    |                              |                                  |                              |                                 |                              |                                 |                              |                                 |                                   |                                    |                                  |        |
| <b>Don Mossi, L</b> (9, 1)<br>OBP: 0.091, SLG: 0.091        |   |                                  |                              |                                 |                              |                                 |                              |                                 |                              | 0 0 0 0 0 0 0                    |                              |                                  |                              |                                 |                              |                                 |                              |                                 |                                   |                                    |                                  |        |
| <b>Inning Stats</b>   | R: 0<br>E: 0<br>K: 0<br>S: 3                          | H: 1<br>LOB: 2<br>BB: 2<br>P: 11 | R: 0<br>E: 0<br>K: 1<br>S: 6 | H: 1<br>LOB: 1<br>BB: 0<br>P: 6 | R: 3<br>E: 0<br>K: 0<br>S: 7 | H: 5<br>LOB: 1<br>BB: 0<br>P: 7 | R: 0<br>E: 0<br>K: 0<br>S: 4 | H: 1<br>LOB: 1<br>BB: 0<br>P: 4 | R: 5<br>E: 0<br>K: 1<br>S: 9 | H: 4<br>LOB: 0<br>BB: 1<br>P: 13 | R: 0<br>E: 0<br>K: 1<br>S: 6 | H: 1<br>LOB: 2<br>BB: 1<br>P: 10 | R: 0<br>E: 0<br>K: 2<br>S: 8 | H: 1<br>LOB: 1<br>BB: 0<br>P: 8 | R: 0<br>E: 0<br>K: 1<br>S: 5 | H: 1<br>LOB: 0<br>BB: 0<br>P: 5 | R: 0<br>E: 0<br>K: 2<br>S: 7 | H: 1<br>LOB: 1<br>BB: 0<br>P: 7 | 1B: 14<br>2B: 2<br>3B: 0<br>HR: 1 | SF: 1<br>SAC: 0<br>DP: 1<br>HBP: 0 | WP: 1<br>PB: 0<br>SB: 1<br>CS: 3 | PA: 43 |
| <b>PITCHER</b>  | IP WLS BF H R ER SO BB IBB HBP BLK WP HR S P ERA WHIP |                                  |                              |                                 |                              |                                 |                              |                                 |                              |                                  |                              |                                  |                              |                                 |                              |                                 |                              |                                 |                                   |                                    |                                  |        |
| <b>Jose Santiago, R</b> (1, 1)<br>ERA: 4.32                 | 4.0 L 22 10 5 5 1 2 0 0 0 0 0 0 22 30 11.25 3.000     |                                  |                              |                                 |                              |                                 |                              |                                 |                              |                                  |                              |                                  |                              |                                 |                              |                                 |                              |                                 |                                   |                                    |                                  |        |
| <b>Joe Grzenda, L</b> (5, 1)<br>ERA: 5.64                   | 2.0 11 3 3 3 2 1 1 0 0 0 1 13 21 13.50 2.000          |                                  |                              |                                 |                              |                                 |                              |                                 |                              |                                  |                              |                                  |                              |                                 |                              |                                 |                              |                                 |                                   |                                    |                                  |        |
| <b>Wes Stock, R</b> (7, 1)<br>ERA: 2.54                     | 3.0 10 3 0 0 5 0 0 0 0 1 0 20 20 0.00 1.000           |                                  |                              |                                 |                              |                                 |                              |                                 |                              |                                  |                              |                                  |                              |                                 |                              |                                 |                              |                                 |                                   |                                    |                                  |        |

**Chicago White Sox @ Kansas City Athletics**  
 Municipal Stadium, Kansas City, MO  
 Mon Jul 13 1964, 4:33 AM EDT  
 Unknown

|            |           |
|------------|-----------|
| <b>AB</b>  | <b>38</b> |
| <b>R</b>   | <b>8</b>  |
| <b>H</b>   | <b>16</b> |
| <b>RBI</b> | <b>8</b>  |
| <b>BB</b>  | <b>4</b>  |
| <b>SO</b>  | <b>8</b>  |
| <b>LOB</b> | <b>19</b> |



| Batter   | 1      | 2               | 3              | 4      | 5               | 6            | 7         | 8                   | 9       | AB R H RBI BB SO LOB  |
|--|--------|-----------------|----------------|--------|-----------------|--------------|-----------|---------------------|---------|---|
| Wayne Causey, L (1, 6)<br>OBP: 0.391, SLG: 0.377   | 0-3 K  |                 | 0-0 1B         |        |                 | 6-3          |           |                     | 0-0 F4  | 5 0 1 0 0 1 2   |
| Ed Charles, R (1, 5)<br>OBP: 0.321, SLG: 0.363   | 0-0 2B |                 | 0-0 L6-4       |        |                 | 4-0 HR BB    | 0-0 L3 1B |                     | 0-0 5-3 | 4 1 2 0 1 0 2   |
| Manny Jimenez, L (1, 7)<br>OBP: 0.303, SLG: 0.542<br>George Alusik, R (6, PH)<br>OBP: 0.368, SLG: 0.379 (7, 7)   | 0-0 F6 |                 | 0-0 1-3        |        |                 | 0-0 HR       | 0-0 L3    |                     |         | 2 0 0 0 0 0 2<br>2 1 1 2 0 0 1  |
| Rocky Colavito, R (1, 9)<br>OBP: 0.375, SLG: 0.531   | 0-0 F8 |                 |                | 0-0 F6 |                 | 0-0 2B WP 1B | 0-0 6-3   |                     |         | 4 1 1 0 0 0 1   |
| Jim Gentile, L (1, 3)<br>OBP: 0.390, SLG: 0.485<br>Ken Harrelson, R (6, PH)<br>OBP: 0.357, SLG: 0.643 (7, 3)   |        | 0-0 G4-6-3 1B   |                | 0-0 G3 |                 | 0-0 WP 2B 2B |           | 0-0 1-3 PB FC6-2 1B |         | 2 0 1 0 0 0 0<br>2 1 2 0 0 0 0  |
| Doc Edwards, R (1, 2)<br>OBP: 0.224, SLG: 0.236  |        | 0-0 G4-6-3 1-2f |                | 0-3 K  |                 | 0-0 F4       |           | 0-0 1-3             |         | 4 0 0 0 0 1 3   |
| Dick Green, R (1, 4)<br>OBP: 0.275, SLG: 0.380   |        | 0-0 HR          |                |        | 0-0 G5-4-3 1B   | 0-0 1B 2B    |           | 0-0 FC6-2 WP        |         | 4 2 3 2 0 0 1   |
| Nelson Mathews, R (1, 8)<br>OBP: 0.284, SLG: 0.338   |        | 0-0 6-3         |                |        | 0-0 G5-4-3 1-2f | 0-0 1B 1B    |           | 0-0 6-3 1-2         |         | 4 0 1 0 0 0 2   |
| Jose Santiago, R (1, 1)<br>Joe Grzenda, R (5, 1)<br>Billy Bryan, L (6, PH)<br>Wes Stock, R (7, 1)<br>Jose Tartabull, L (9, PH)<br>OBP: 0.235, SLG: 0.242 |        |                 | 4-0 L6-4 1B BB |        | 0-0 F9          | 0-0 FC6-4 1B |           | 0-3 K               |         | 0 0 0 0 1 0 0<br>1 0 0 0 0 0 0<br>1 0 1 1 0 0 0<br>0 0 0 0 0 0 0<br>1 0 0 0 0 1 0 |

| Inning Stats | R: 0<br>E: 0<br>K: 1<br>S: 6 | H: 1<br>LOB: 1<br>BB: 0<br>P: 6 | R: 1<br>E: 0<br>K: 0<br>S: 4 | H: 2<br>LOB: 0<br>BB: 0<br>P: 4 | R: 0<br>E: 0<br>K: 0<br>S: 3 | H: 1<br>LOB: 1<br>BB: 1<br>P: 7 | R: 0<br>E: 0<br>K: 1<br>S: 5 | H: 0<br>LOB: 0<br>BB: 0<br>P: 5 | R: 0<br>E: 0<br>K: 0<br>S: 3 | H: 1<br>LOB: 0<br>BB: 0<br>P: 3 | R: 5<br>E: 0<br>K: 0<br>S: 9 | H: 6<br>LOB: 2<br>BB: 1<br>P: 13 | R: 0<br>E: 0<br>K: 0<br>S: 3 | H: 1<br>LOB: 0<br>BB: 0<br>P: 3 | R: 0<br>E: 0<br>K: 0<br>S: 4 | H: 1<br>LOB: 1<br>BB: 0<br>P: 4 | R: 0<br>E: 0<br>K: 1<br>S: 5 | H: 0<br>LOB: 0<br>BB: 0<br>P: 5 | 1B: 8<br>2B: 5<br>3B: 0<br>HR: 2 | SF: 0<br>SAC: 0<br>DP: 4<br>HBP: 0 |
|--------------|------------------------------|---------------------------------|------------------------------|---------------------------------|------------------------------|---------------------------------|------------------------------|---------------------------------|------------------------------|---------------------------------|------------------------------|----------------------------------|------------------------------|---------------------------------|------------------------------|---------------------------------|------------------------------|---------------------------------|----------------------------------|------------------------------------|
|--------------|------------------------------|---------------------------------|------------------------------|---------------------------------|------------------------------|---------------------------------|------------------------------|---------------------------------|------------------------------|---------------------------------|------------------------------|----------------------------------|------------------------------|---------------------------------|------------------------------|---------------------------------|------------------------------|---------------------------------|----------------------------------|------------------------------------|

| PITCHER                             | IP  | WLS | BF | H | R | ER | SO | BB | IBB | HBP | BLK | WP | HR | S  | P  | ERA   | WHIP  |
|-------------------------------------|-----|-----|----|---|---|----|----|----|-----|-----|-----|----|----|----|----|-------|-------|
| Gary Peters, L (1, 1)<br>ERA: 2.69  | 5.1 | W   | 23 | 8 | 5 | 5  | 2  | 2  | 0   | 0   | 0   | 0  | 2  | 25 | 33 | 8.44  | 1.875 |
| Hoyt Wilhelm, R (6, 1)<br>ERA: 2.11 | 0.2 |     | 5  | 3 | 1 | 1  | 0  | 0  | 0   | 0   | 0   | 1  | 0  | 5  | 5  | 13.50 | 4.500 |
| Eddie Fisher, R (7, 1)<br>ERA: 3.57 | 2.0 |     | 7  | 2 | 0 | 0  | 0  | 0  | 0   | 0   | 0   | 1  | 0  | 7  | 7  | 0.00  | 1.000 |
| Don Mossi, L (9, 1)<br>ERA: 2.1     | 1.0 | S   | 3  | 0 | 0 | 0  | 1  | 0  | 0   | 0   | 0   | 0  | 0  | 5  | 5  | 0.00  | 0.000 |

**BOTTOM**

**Chicago White Sox @ Kansas City Athletics**  
Municipal Stadium, Kansas City, MO

Mon Jul 13 1964, 4:33 AM EDT  
Unknown

|            |           |
|------------|-----------|
| <b>AB</b>  | <b>36</b> |
| <b>R</b>   | <b>6</b>  |
| <b>H</b>   | <b>13</b> |
| <b>RBI</b> | <b>5</b>  |
| <b>BB</b>  | <b>2</b>  |
| <b>SO</b>  | <b>3</b>  |
| <b>LOB</b> | <b>14</b> |



| WP | PA | ERA | WHIP |
|----|----|-----|------|
| 2  | 38 |     |      |
| 1  |    |     |      |
| 0  |    |     |      |
| 0  |    |     |      |

| Batter   | 1   | 2   | 3  | 4                               | 5                             | 6                                | 7                            | 8                               | 9  | AB R H RBI BB SO LOB             | TOP  |                                 |                              |                                 |                              |                                 |                              |                                 |                                  |                                    |                                  |        |
|--|---|---|--|---------------------------------|-------------------------------|----------------------------------|------------------------------|---------------------------------|--|----------------------------------|--|---------------------------------|------------------------------|---------------------------------|------------------------------|---------------------------------|------------------------------|---------------------------------|----------------------------------|------------------------------------|----------------------------------|--------|
| Tom McCraw, L (1, 3)<br>OBP: 0.351, SLG: 0.417   | 0-0<br>F8   |   | 0-3<br>K                                     | 0-0<br>CS<br>1B                 |                               |                                  | 0-0<br>F8                    |                                 | 0-0<br>3-1<br>BLK<br>1B  | 5 0 2 0 0 1 1                    | <b>Chicago White Sox @ Kansas City Athletics</b><br>Municipal Stadium, Kansas City, MO<br>Mon Jul 13 1964, 8:05 PM EDT<br>Att. 3,938 - Unknown<br><a href="http://livebaseballscorecards.com">livebaseballscorecards.com</a> |                                 |                              |                                 |                              |                                 |                              |                                 |                                  |                                    |                                  |        |
| Don Buford, S (1, 4)<br>(7, 5)<br>OBP: 0.321, SLG: 0.325   | 0-0<br>2B   |   | 0-0<br>HR                                    | 0-0<br>CS<br>1-2                | 0-0<br>4-3                    |                                  | 0-0<br>F5                    | 0-0<br>3-1<br>1-3               | 5 1 2 2 0 0 1  |                                  |  |                                 |                              |                                 |                              |                                 |                              |                                 |                                  |                                    |                                  |        |
| Floyd Robinson, L (1, 9)<br>(8, 7)<br>OBP: 0.374, SLG: 0.444   | 0-0<br>F8   |   | 0-0<br>HR<br>1B                              |                                 | 4-0<br>HR<br>BB               |                                  | 0-0<br>1B                    | 0-0<br>F8                       | 4 2 2 0 1 0 2  |                                  |  |                                 |                              |                                 |                              |                                 |                              |                                 |                                  |                                    |                                  |        |
| Pete Ward, L (1, 5)<br>Al Weis, S (7, 4)<br>OBP: 0.350, SLG: 0.469<br>OBP: 0.316, SLG: 0.347                   | 0-0<br>4-1  |   | 0-0<br>HR                                    |                                 | 0-3<br>K                      |                                  | 0-0<br>6-3                   |                                 | 4 1 1 2 0 1 3<br>0 0 0 0 0 0 0                                   |                                  |  |                                 |                              |                                 |                              |                                 |                              |                                 |                                  |                                    |                                  |        |
| Gene Stephens, L (1, 7)<br>Jim Landis, R (8, PH)<br>(8, 8)<br>OBP: 0.357, SLG: 0.467<br>OBP: 0.293, SLG: 0.298 |   | 0-0<br>1-3                                | 0-0<br>BB<br>1B                              |                                 | 0-0<br>HR                     |                                  | 0-0<br>4-3                   |                                 | 3 1 2 2 0 0 0<br>1 0 0 0 0 0 0                                   |                                  |  |                                 |                              |                                 |                              |                                 |                              |                                 |                                  |                                    |                                  |        |
| Mike Hershberger, R (1, 8)<br>(8, 9)<br>OBP: 0.323, SLG: 0.335   |   | 0-0<br>1B                                 | 4-0<br>BB                                    |                                 | 0-0<br>F4                     |                                  | 0-0<br>6-3                   |                                 | 3 0 1 0 1 0 0  |                                  |  |                                 |                              |                                 |                              |                                 |                              |                                 |                                  |                                    |                                  |        |
| Ron Hansen, R (1, 6)<br>OBP: 0.341, SLG: 0.369   |   | 0-0<br>F5                                 | 0-0<br>F6                                    |                                 | 0-0<br>F2                     |                                  | 0-0<br>HR                    |                                 | 4 1 1 1 0 0 2  |                                  |  |                                 |                              |                                 |                              |                                 |                              |                                 |                                  |                                    |                                  |        |
| Jerry McNertney, R (1, 2)<br>OBP: 0.302, SLG: 0.303  |   |   | 1-0<br>HR<br>HBP                             | 0-0<br>F6                       | 0-3<br>K                      |                                  | 0-0<br>4-3                   |                                 | 3 1 0 0 0 1 0  |                                  |  |                                 |                              |                                 |                              |                                 |                              |                                 |                                  |                                    |                                  |        |
| Ray Herbert, R (1, 1)<br>Don Mossi, L (7, 1)<br>OBP: 0.143, SLG: 0.154   |   |   | 0-3<br>K                                     | 0-3<br>K                        | 0-3<br>K                      |                                  |                              | 0-0<br>F7                       | 3 0 0 0 0 3 1<br>0 0 0 0 0 0 0<br>1 0 0 0 0 0 0<br>0 0 0 0 0 0 0 |                                  |  |                                 |                              |                                 |                              |                                 |                              |                                 |                                  |                                    |                                  |        |
| Jeoff Long, R (9, PH)<br>Frank Kreutzer, R (9, 1)<br>OBP: 0.355, SLG: 0.321<br>OBP: 0.125, SLG: 0.250          |   |   |  |                                 |                               |                                  |                              |                                 |  |                                  |  |                                 |                              |                                 |                              |                                 |                              |                                 |                                  |                                    |                                  |        |
| <b>Inning Stats</b>  | R: 0<br>E: 0<br>K: 0<br>S: 4                          | H: 1<br>LOB: 1<br>BB: 0<br>P: 4           | R: 0<br>E: 0<br>K: 0<br>S: 3                 | H: 1<br>LOB: 0<br>BB: 0<br>P: 3 | R: 4<br>E: 0<br>K: 2<br>S: 11 | H: 4<br>LOB: 2<br>BB: 1<br>P: 16 | R: 0<br>E: 0<br>K: 1<br>S: 5 | H: 1<br>LOB: 0<br>BB: 1<br>P: 5 | R: 2<br>E: 0<br>K: 1<br>S: 6                                     | H: 1<br>LOB: 0<br>BB: 1<br>P: 10 | R: 0<br>E: 0<br>K: 2<br>S: 7   | H: 0<br>LOB: 0<br>BB: 0<br>P: 7 | R: 0<br>E: 0<br>K: 0<br>S: 4 | H: 1<br>LOB: 1<br>BB: 0<br>P: 4 | R: 1<br>E: 0<br>K: 0<br>S: 4 | H: 1<br>LOB: 0<br>BB: 0<br>P: 4 | R: 0<br>E: 0<br>K: 0<br>S: 4 | H: 1<br>LOB: 1<br>BB: 0<br>P: 4 | 1B: 6<br>2B: 1<br>3B: 0<br>HR: 4 | SF: 0<br>SAC: 0<br>DP: 0<br>HBP: 1 | WP: 0<br>PB: 0<br>SB: 0<br>CS: 1 | PA: 40 |
| <b>PITCHER</b>   | IP WLS BF H R ER SO BB IBB HBP BLK WP HR S P ERA WHIP |   |  |                                 |                               |                                  |                              |                                 |  |                                  |  |                                 |                              |                                 |                              |                                 |                              |                                 |                                  |                                    |                                  |        |
| Dan Pfister, R (1, 1)<br>ERA: 7.36   | 2.2   |   | 15 6 4 4 2 1 0 1 0 1 0 0 2 17 22 13.50 2.625 |                                 |                               |                                  |                              |                                 |  |                                  |  |                                 |                              |                                 |                              |                                 |                              |                                 |                                  |                                    |                                  |        |
| Joe Grzenda, L (3, 1)<br>ERA: 5.56   | 0.1   | 1 0 0 0 0 0 0 0 0 0 0 0 0 1 1 0.00 0.000  |  |                                 |                               |                                  |                              |                                 |  |                                  |  |                                 |                              |                                 |                              |                                 |                              |                                 |                                  |                                    |                                  |        |
| John Wyatt, R (4, 1)<br>ERA: 3.28  | 4.0   | 15 3 2 2 4 1 0 0 0 0 0 1 22 26 4.50 1.000 |  |                                 |                               |                                  |                              |                                 |  |                                  |  |                                 |                              |                                 |                              |                                 |                              |                                 |                                  |                                    |                                  |        |
| Ted Bowsfield, L (8, 1)<br>ERA: 4.97   | 2.0 W   | 8 2 1 1 0 0 0 0 0 0 1 0 1 8 8 4.50 1.000  |  |                                 |                               |                                  |                              |                                 |  |                                  |  |                                 |                              |                                 |                              |                                 |                              |                                 |                                  |                                    |                                  |        |

**Chicago White Sox @ Kansas City Athletics**  
Municipal Stadium, Kansas City, MO  
Mon Jul 13 1964, 8:05 PM EDT  
Att. 3,938 - Unknown

|            |    |
|------------|----|
| <b>AB</b>  | 36 |
| <b>R</b>   | 7  |
| <b>H</b>   | 11 |
| <b>RBI</b> | 7  |
| <b>BB</b>  | 2  |
| <b>SO</b>  | 6  |
| <b>LOB</b> | 10 |



| Batter   | 1          | 2          | 3          | 4                  | 5                  | 6 | 7               | 8 | 9                     | AB | R | H | RBI | BB | SO | LOB |
|--|------------|------------|------------|--------------------|--------------------|---|-----------------|---|-----------------------|----|---|---|-----|----|----|-----|
| Jose Tartabull, L (1, 8)<br>OBP: 0.263, SLG: 0.270<br>Nelson Mathews, R (9, PH)<br>OBP: 0.286, SLG: 0.338  | 0-0<br>F8  |            |            | 0-0<br>FC6-4<br>1B | 0-0<br>FC6-4<br>1B |   | 0-0<br>G3       |   | 4-0<br>1B<br>IBB      | 4  | 0 | 2 | 0   | 0  | 0  | 2   |
| Wayne Causey, L (1, 6)<br>OBP: 0.391, SLG: 0.386   | 0-3<br>K   |            |            | 0-0<br>FC6-4<br>HR | 0-0<br>FC6-4       |   | 0-0<br>HR       |   | 0-0<br>1B             | 5  | 2 | 2 | 4   | 0  | 1  | 3   |
| Manny Jimenez, L (1, 7)<br>OBP: 0.301, SLG: 0.556<br>Ted Bowsfield, R (8, 1)   | 0-0<br>4-3 |            |            | 0-0<br>HR          |                    |   | 0-0<br>F4       |   | 0-0<br>F4             | 4  | 1 | 1 | 2   | 0  | 0  | 0   |
| Jim Gentile, L (1, 3)<br>OBP: 0.391, SLG: 0.500  |            | 0-3<br>K   |            | 0-0<br>1B          |                    |   | 0-3<br>K        |   | 0-0<br>HR             | 4  | 1 | 2 | 1   | 0  | 2  | 0   |
| Rocky Colavito, R (1, 9)<br>OBP: 0.371, SLG: 0.523   |            | 0-0<br>G3  |            | 0-0<br>F9          |                    |   | 0-0<br>5-3      |   | 0-0<br>F7             | 4  | 0 | 0 | 0   | 0  | 0  | 1   |
| Billy Bryan, L (1, 2)<br>OBP: 0.313, SLG: 0.542<br>Doc Edwards, R (8, PH)<br>OBP: 0.222, SLG: 0.234  |            | 0-0<br>4-3 |            | 0-0<br>F8          |                    |   | 0-0<br>4-3      |   | 0-0<br>F6             | 3  | 0 | 0 | 0   | 0  | 0  | 1   |
| Ed Charles, R (1, 5)<br>OBP: 0.320, SLG: 0.371   |            |            | 0-0<br>F7  |                    |                    |   | 0-0<br>F9       |   | 0-0<br>F9             | 4  | 1 | 1 | 1   | 0  | 0  | 0   |
| Dick Green, R (1, 4)<br>OBP: 0.282, SLG: 0.386   |            |            | 0-0<br>6-3 |                    |                    |   | 0-0<br>1B<br>1B |   | 0-0<br>2B<br>1B<br>1B | 4  | 2 | 3 | 0   | 0  | 0  | 0   |
| Dan Pfister, R (1, 1)<br>Joe Grzenda, R (3, 1)<br>Charlie Shoemaker, L (3, PH)<br>OBP: 0.222, SLG: 0.333<br>John Wyatt, R (4, 1)<br>Ken Harrelson, R (7, PH)<br>OBP: 0.436, SLG: 0.750 |            |            | 0-0<br>F5  |                    |                    |   | 0-3<br>K        |   | 0-0<br>1B<br>2B       | 0  | 0 | 0 | 0   | 0  | 0  | 0   |

| Inning Stats | R: 0 | H: 0 | E: 0 | K: 1 | S: 5 | R: 0 | H: 0 | E: 0 | K: 1 | S: 5 | R: 0 | H: 0 | E: 0 | K: 0 | S: 3 | R: 2 | H: 3 | E: 0 | K: 0 | S: 6 | R: 0 | H: 2 | E: 0 | K: 1 | S: 7 | R: 0 | H: 0 | E: 0 | K: 1 | S: 5 | R: 4 | H: 4 | E: 0 | K: 0 | S: 7 | R: 1 | H: 1 | E: 0 | K: 0 | S: 4 | R: 1 | H: 3 | E: 0 | K: 0 | S: 3 | 1B: 8 | SF: 0 | 2B: 1 | SAC: 0 | 3B: 0 | DP: 0 | HR: 4 | HBP: 0 | WP: 0 | PA: 38 |
|--------------|------|------|------|------|------|------|------|------|------|------|------|------|------|------|------|------|------|------|------|------|------|------|------|------|------|------|------|------|------|------|------|------|------|------|------|------|------|------|------|------|------|------|------|------|------|-------|-------|-------|--------|-------|-------|-------|--------|-------|--------|
|--------------|------|------|------|------|------|------|------|------|------|------|------|------|------|------|------|------|------|------|------|------|------|------|------|------|------|------|------|------|------|------|------|------|------|------|------|------|------|------|------|------|------|------|------|------|------|-------|-------|-------|--------|-------|-------|-------|--------|-------|--------|

| PITCHER                               | IP  | WLS | BF | H | R | ER | SO | BB | IBB | HBP | BLK | WP | HR | S  | P  | ERA   | WHIP  |
|---------------------------------------|-----|-----|----|---|---|----|----|----|-----|-----|-----|----|----|----|----|-------|-------|
| Ray Herbert, R (1, 1)<br>ERA: 3.96    | 6.2 |     | 28 | 8 | 5 | 5  | 4  | 0  | 0   | 0   | 0   | 0  | 2  | 36 | 36 | 6.75  | 1.200 |
| Don Mossi, L (7, 1)<br>ERA: 2.67      | 1.1 |     | 6  | 2 | 2 | 2  | 0  | 0  | 0   | 0   | 0   | 0  | 2  | 6  | 6  | 13.50 | 1.500 |
| Frank Kreutzer, L (9, 1)<br>ERA: 3.43 | 0.0 | L   | 4  | 3 | 1 | 1  | 0  | 0  | 1   | 0   | 0   | 0  | 0  | 3  | 7  | ∞     | ∞     |

**BOTTOM**

**Chicago White Sox @ Kansas City Athletics**  
Municipal Stadium, Kansas City, MO  
Mon Jul 13 1964, 8:05 PM EDT  
Att. 3,938 - Unknown

|            |           |
|------------|-----------|
| <b>AB</b>  | <b>37</b> |
| <b>R</b>   | <b>8</b>  |
| <b>H</b>   | <b>13</b> |
| <b>RBI</b> | <b>8</b>  |
| <b>BB</b>  | <b>1</b>  |
| <b>SO</b>  | <b>4</b>  |
| <b>LOB</b> | <b>8</b>  |

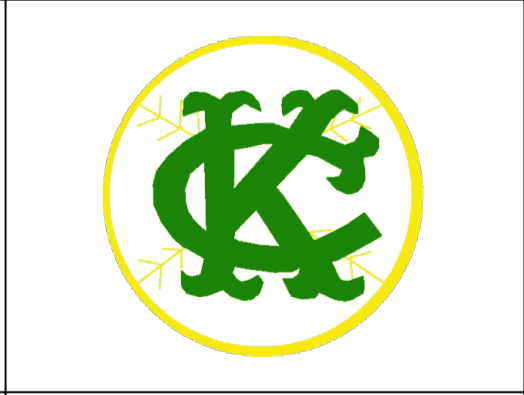

| WP | HR | S | P | ERA   | WHIP  |
|----|----|---|---|-------|-------|
| 0  | 2  | 4 | 3 | 6.75  | 1.200 |
| 0  | 2  | 0 | 6 | 13.50 | 1.500 |
| 0  | 0  | 0 | 7 | ∞     | ∞     |

| Batter   | 1   | 2                               | 3                            | 4                                | 5                            | 6                               | 7                            | 8                                | 9                            | AB R H RBI BB SO LOB                            | TOP  |                                 |                              |                                 |                              |                                  |                              |                                  |                                   |                                    |                                  |        |  |  |  |  |  |  |  |  |  |  |  |  |  |  |  |
|--|---|---------------------------------|------------------------------|----------------------------------|------------------------------|---------------------------------|------------------------------|----------------------------------|------------------------------|---|--|---------------------------------|------------------------------|---------------------------------|------------------------------|----------------------------------|------------------------------|----------------------------------|-----------------------------------|------------------------------------|----------------------------------|--------|--|--|--|--|--|--|--|--|--|--|--|--|--|--|--|
| Dick Howser, R (1, 6)<br>OBP: 0.300, SLG: 0.298  | 0-3<br>K  |                                 | 0-0<br>5-3                   | 0-0<br>1B<br>2B                  |                              | 0-0<br>1B                       |                              | 0-0<br>1B<br>4-3                 | 0-0<br>1B                    | 6 1 4 2 0 1 0                                   | <b>Cleveland Indians @ Kansas City Athletics</b><br>Municipal Stadium, Kansas City, MO<br>Tue Jul 14 1964, 8:05 PM EDT<br>Att. 5,422 - Unknown |                                 |                              |                                 |                              |                                  |                              |                                  |                                   |                                    |                                  |        |  |  |  |  |  |  |  |  |  |  |  |  |  |  |  |
| Vic Davalillo, L (1, 8)<br>OBP: 0.282, SLG: 0.312  | 0-0<br>S<br>1B  |                                 | 0-0<br>2B<br>FC<br>1B        | 0-0<br>S<br>1B                   |                              | 0-0<br>F8                       |                              | 0-0<br>4-3<br>1B                 | 0-0<br>1B                    | 6 1 4 1 0 0 2                                   |  |                                 |                              |                                 |                              |                                  |                              |                                  |                                   |                                    |                                  |        |  |  |  |  |  |  |  |  |  |  |  |  |  |  |  |
| Leon Wagner, L (1, 7)<br>OBP: 0.337, SLG: 0.497  | 0-0<br>F4<br>1-2                                      |                                 | 0-0<br>FC<br>1B<br>2B        | 0-0<br>F6<br>1-2                 |                              |                                 | 0-0<br>HR                    | 0-0<br>S<br>1B                   | 0-0<br>F7                    | 6 2 3 1 0 0 5                                   |  |                                 |                              |                                 |                              |                                  |                              |                                  |                                   |                                    |                                  |        |  |  |  |  |  |  |  |  |  |  |  |  |  |  |  |
| Bob Chance, L (1, 3)<br>OBP: 0.422, SLG: 0.585   | 0-3<br>K  |                                 | 0-0<br>FC<br>1B              |                                  | 0-3<br>K                     |                                 | 0-3<br>K                     | 4-0<br>1-2<br>BB                 | 0-0<br>4-3                   | 5 0 0 1 1 3 5                                   |  |                                 |                              |                                 |                              |                                  |                              |                                  |                                   |                                    |                                  |        |  |  |  |  |  |  |  |  |  |  |  |  |  |  |  |
| Tito Francona, L (1, 9)<br>OBP: 0.385, SLG: 0.394  |   | 4-0<br>BB<br>FC5-4<br>BB        | 0-0<br>1-2<br>3-H<br>1B      |                                  | 0-0<br>1B                    |                                 | 0-0<br>HR                    | 0-0<br>4-3                       |                              | 4 1 3 2 1 0 3                                   |  |                                 |                              |                                 |                              |                                  |                              |                                  |                                   |                                    |                                  |        |  |  |  |  |  |  |  |  |  |  |  |  |  |  |  |
| John Romano, R (1, 2)<br>OBP: 0.364, SLG: 0.488  |   | 0-0<br>FC5-4<br>1-2f            | 0-0<br>G6-3<br>1-2f          |                                  | 0-3<br>K                     |                                 | 0-3<br>K                     |                                  | 4-0<br>1B<br>BB              | 4 1 0 0 1 2 4                                   |  |                                 |                              |                                 |                              |                                  |                              |                                  |                                   |                                    |                                  |        |  |  |  |  |  |  |  |  |  |  |  |  |  |  |  |
| Chico Salmon, R (1, 4)<br>OBP: 0.364, SLG: 0.381   |   | 0-3<br>K                        |                              | 0-0<br>4-3                       |                              | 0-0<br>F7                       |                              | 0-0<br>F4                        | 0-0<br>1B<br>1B              | 5 1 1 0 0 1 2                                   |  |                                 |                              |                                 |                              |                                  |                              |                                  |                                   |                                    |                                  |        |  |  |  |  |  |  |  |  |  |  |  |  |  |  |  |
| Woodie Held, R (1, 5)<br>OBP: 0.297, SLG: 0.471  |   | 4-0<br>BB                       |                              | 4-0<br>2B<br>BB                  |                              | 0-0<br>F7                       |                              | 0-0<br>HR                        | 0-0<br>1B<br>1B              | 3 2 2 2 2 0 0                                   |  |                                 |                              |                                 |                              |                                  |                              |                                  |                                   |                                    |                                  |        |  |  |  |  |  |  |  |  |  |  |  |  |  |  |  |
| Sam McDowell, L (1, 1)<br>OBP: 0.111, SLG: 0.040<br>Gary Bell, R (7, 1)<br>OBP: 0.375, SLG: 0.375<br>Don McMahon, R (8, 1)<br>OBP: 0.143, SLG: 0.143 | 0-3<br>K  |                                 | 0-3<br>K                     |                                  | 0-3<br>K                     |                                 | 0-3<br>K                     | 0-3<br>K                         | 0-3<br>K                     | 3 0 0 0 0 3 3<br>1 0 0 0 0 1 0<br>1 0 0 0 0 1 2 |  |                                 |                              |                                 |                              |                                  |                              |                                  |                                   |                                    |                                  |        |  |  |  |  |  |  |  |  |  |  |  |  |  |  |  |
| <b>Inning Stats</b>  | R: 0<br>E: 0<br>K: 2<br>S: 8                          | H: 1<br>LOB: 1<br>BB: 0<br>P: 8 | R: 0<br>E: 1<br>K: 2<br>S: 7 | H: 0<br>LOB: 2<br>BB: 2<br>P: 15 | R: 2<br>E: 0<br>K: 0<br>S: 6 | H: 3<br>LOB: 1<br>BB: 0<br>P: 6 | R: 2<br>E: 0<br>K: 1<br>S: 7 | H: 2<br>LOB: 1<br>BB: 1<br>P: 11 | R: 0<br>E: 0<br>K: 2<br>S: 8 | H: 1<br>LOB: 1<br>BB: 0<br>P: 8                 | R: 0<br>E: 0<br>K: 1<br>S: 6   | H: 1<br>LOB: 1<br>BB: 0<br>P: 6 | R: 2<br>E: 0<br>K: 2<br>S: 9 | H: 2<br>LOB: 0<br>BB: 0<br>P: 9 | R: 1<br>E: 0<br>K: 1<br>S: 8 | H: 3<br>LOB: 3<br>BB: 1<br>P: 12 | R: 2<br>E: 0<br>K: 1<br>S: 9 | H: 4<br>LOB: 3<br>BB: 1<br>P: 13 | 1B: 12<br>2B: 2<br>3B: 0<br>HR: 3 | SF: 0<br>SAC: 0<br>DP: 1<br>HBP: 0 | WP: 0<br>PB: 0<br>SB: 3<br>CS: 0 | PA: 49 |  |  |  |  |  |  |  |  |  |  |  |  |  |  |  |
| <b>PITCHER</b>   | IP WLS BF H R ER SO BB IBB HBP BLK WP HR S P ERA WHIP |                                 |                              |                                  |                              |                                 |                              |                                  |                              |   |  |                                 |                              |                                 |                              |                                  |                              |                                  |                                   |                                    |                                  |        |  |  |  |  |  |  |  |  |  |  |  |  |  |  |  |
| Diego Segui, R (1, 1)<br>ERA: 4.11   | 6.0   |                                 | 30                           | 9                                | 5                            | 5                               | 8                            | 3                                | 0                            | 0   | 0  | 0                               | 0                            | 1                               | 43                           | 55                               | 7.50                         | 2.000                            |                                   |                                    |                                  |        |  |  |  |  |  |  |  |  |  |  |  |  |  |  |  |
| Moe Drabowsky, R (7, 1)<br>ERA: 5.76   | 1.0   |                                 | 4                            | 1                                | 1                            | 1                               | 2                            | 0                                | 0                            | 0   | 0  | 0                               | 0                            | 1                               | 8                            | 8                                | 9.00                         | 1.000                            |                                   |                                    |                                  |        |  |  |  |  |  |  |  |  |  |  |  |  |  |  |  |
| John Wyatt, R (8, 1)<br>ERA: 3.62  | 1.0   | L                               | 10                           | 5                                | 3                            | 3                               | 1                            | 2                                | 0                            | 0   | 0  | 0                               | 0                            | 1                               | 10                           | 18                               | 27.00                        | 7.000                            |                                   |                                    |                                  |        |  |  |  |  |  |  |  |  |  |  |  |  |  |  |  |
| Joe Grzenda, L (9, 1)<br>ERA: 5.32   | 1.0   |                                 | 5                            | 2                                | 0                            | 0                               | 1                            | 0                                | 0                            | 0   | 0  | 0                               | 0                            | 0                               | 7                            | 7                                | 0.00                         | 2.000                            |                                   |                                    |                                  |        |  |  |  |  |  |  |  |  |  |  |  |  |  |  |  |

livebaseballscorecards.com

|     |    |
|-----|----|
| AB  | 44 |
| R   | 9  |
| H   | 17 |
| RBI | 9  |
| BB  | 5  |
| SO  | 12 |
| LOB | 26 |



| Batter  | 1                     | 2         | 3                | 4         | 5          | 6                                 | 7          | 8                | 9          | AB | R | H | RBI | BB | SO | LOB |
|---|-----------------------|-----------|------------------|-----------|------------|-----------------------------------|------------|------------------|------------|----|---|---|-----|----|----|-----|
| Wayne Causey, L (1, 6)<br>OBP: 0.391, SLG: 0.384    | 0-0<br>G6-4-3<br>1B   |           | 0-0<br>E3<br>1B  |           |            | 4-0<br>FC6-4<br>1B<br>HR<br>BB    | 0-0<br>4-3 |                  | 0-3<br>K   | 4  | 1 | 1 | 0   | 1  | 1  | 1   |
| Dick Green, R (1, 4)<br>OBP: 0.284, SLG: 0.398      | 0-3<br>K              |           | 0-0<br>1-2<br>1B |           |            | 0-3<br>K                          |            | 0-0<br>HR        | 0-0<br>F4  | 5  | 1 | 2 | 1   | 0  | 2  | 2   |
| Ed Charles, R (1, 5)<br>OBP: 0.321, SLG: 0.375      | 0-0<br>G6-4-3<br>1-2f |           | 0-0<br>F8        |           |            | 0-0<br>1-2<br>FC6-4<br>1B         |            | 0-0<br>HR<br>2B  | 0-0<br>5-3 | 5  | 1 | 2 | 0   | 0  | 0  | 3   |
| Rocky Colavito, R (1, 9)<br>OBP: 0.372, SLG: 0.533  |                       | 0-0<br>1B |                  | 0-3<br>K  |            | 0-0<br>1-2f<br>2-3<br>FC6-4<br>HR |            | 0-0<br>2-H<br>HR |            | 4  | 2 | 2 | 2   | 0  | 1  | 2   |
| Ken Harrelson, R (1, 7)<br>OBP: 0.450, SLG: 1.000   |                       | 0-3<br>K  |                  | 0-0<br>L7 |            | 0-0<br>1-H<br>3-H<br>HR           |            | 0-0<br>HR        |            | 4  | 2 | 2 | 4   | 0  | 1  | 1   |
| Jim Gentile, L (1, 3)<br>OBP: 0.385, SLG: 0.490     |                       | 0-3<br>K  |                  | 0-3<br>K  |            | 0-0<br>6-3                        |            | 0-0<br>5-3       |            | 4  | 0 | 0 | 0   | 0  | 2  | 1   |
| Doc Edwards, R (1, 2)<br>OBP: 0.218, SLG: 0.229     |                       | 0-3<br>K  |                  |           | 0-0<br>6-3 |                                   | 0-0<br>5-3 |                  | 0-3<br>K   | 3  | 0 | 0 | 0   | 0  | 1  | 1   |
| Billy Bryan, L (8, PH)<br>OBP: 0.310, SLG: 0.538    |                       |           |                  |           |            |                                   |            |                  |            | 1  | 0 | 0 | 0   | 0  | 1  | 0   |
| Nelson Mathews, R (1, 8)<br>OBP: 0.287, SLG: 0.338  |                       |           | 0-0<br>6-3       |           | 0-0<br>6-3 |                                   | 0-0<br>1B  |                  | 0-0<br>E5  | 3  | 0 | 1 | 0   | 0  | 0  | 0   |
| Jose Tartabull, L (8, PH)<br>OBP: 0.256, SLG: 0.263 |                       |           |                  |           |            |                                   |            |                  |            | 1  | 0 | 0 | 0   | 0  | 0  | 0   |
| Diego Segui, R (1, 1)<br>OBP: 0.191, SLG: 0.244     |                       |           | 0-0<br>5-3       |           | 0-3<br>K   |                                   | 0-3<br>K   |                  | 0-3<br>K   | 2  | 0 | 0 | 0   | 0  | 1  | 0   |
| Moe Drabowsky, R (7, 1)<br>OBP: 0.033, SLG: 0.033   |                       |           |                  |           |            |                                   |            |                  |            | 0  | 0 | 0 | 0   | 0  | 0  | 0   |
| George Alusik, R (7, PH)<br>OBP: 0.366, SLG: 0.377  |                       |           |                  |           |            |                                   |            |                  |            | 1  | 0 | 0 | 0   | 0  | 1  | 1   |
| John Wyatt, R (8, 1)                                |                       |           |                  |           |            |                                   |            |                  |            | 1  | 0 | 0 | 0   | 0  | 1  | 1   |
| Joe Grzenda, R (9, 1)                               |                       |           |                  |           |            |                                   |            |                  | 1-2        | 0  | 0 | 0 | 0   | 0  | 0  | 0   |

| Inning Stats | R: 0 | H: 1 | E: 0 | LOB: 0 | K: 1 | BB: 0 | S: 5 | R: 0 | H: 1 | E: 0 | LOB: 1 | K: 3 | BB: 0 | S: 10 | R: 0 | H: 1 | E: 1 | LOB: 2 | K: 0 | BB: 0 | S: 5 | R: 0 | H: 0 | E: 0 | LOB: 0 | K: 2 | BB: 0 | S: 7 | R: 0 | H: 0 | E: 0 | LOB: 0 | K: 1 | BB: 0 | S: 5 | R: 3 | H: 2 | E: 0 | LOB: 0 | K: 1 | BB: 1 | S: 7 | R: 0 | H: 1 | E: 0 | LOB: 1 | K: 1 | BB: 0 | S: 6 | R: 4 | H: 4 | E: 1 | LOB: 1 | K: 2 | BB: 0 | S: 12 | R: 0 | H: 0 | E: 0 | LOB: 0 | K: 1 | BB: 0 | S: 5 | R: 0 | H: 0 | E: 0 | LOB: 0 | K: 1 | BB: 0 | S: 5 | 1B: 5 | SF: 0 | 2B: 1 | SAC: 0 | 3B: 0 | DP: 1 | HR: 4 | HBP: 0 | WP: 0 | PA: 39 |
|--------------|------|------|------|--------|------|-------|------|------|------|------|--------|------|-------|-------|------|------|------|--------|------|-------|------|------|------|------|--------|------|-------|------|------|------|------|--------|------|-------|------|------|------|------|--------|------|-------|------|------|------|------|--------|------|-------|------|------|------|------|--------|------|-------|-------|------|------|------|--------|------|-------|------|------|------|------|--------|------|-------|------|-------|-------|-------|--------|-------|-------|-------|--------|-------|--------|
|--------------|------|------|------|--------|------|-------|------|------|------|------|--------|------|-------|-------|------|------|------|--------|------|-------|------|------|------|------|--------|------|-------|------|------|------|------|--------|------|-------|------|------|------|------|--------|------|-------|------|------|------|------|--------|------|-------|------|------|------|------|--------|------|-------|-------|------|------|------|--------|------|-------|------|------|------|------|--------|------|-------|------|-------|-------|-------|--------|-------|-------|-------|--------|-------|--------|

| PITCHER                             | IP  | WLS | BF | H | R | ER | SO | BB | IBB | HBP | BLK | WP | HR | S  | P  | ERA   | WHIP  |
|-------------------------------------|-----|-----|----|---|---|----|----|----|-----|-----|-----|----|----|----|----|-------|-------|
| Sam McDowell, L (1, 1)<br>ERA: 2.68 | 6.1 |     | 26 | 6 | 3 | 3  | 8  | 1  | 0   | 0   | 0   | 0  | 1  | 41 | 45 | 4.26  | 1.105 |
| Gary Bell, R (7, 1)<br>ERA: 4.44    | 0.2 |     | 5  | 3 | 3 | 3  | 1  | 0  | 0   | 0   | 0   | 0  | 2  | 7  | 7  | 40.50 | 4.500 |
| Don McMahon, R (8, 1)<br>ERA: 1.7   | 2.0 | W   | 8  | 1 | 1 | 1  | 3  | 0  | 0   | 0   | 0   | 0  | 1  | 14 | 14 | 4.50  | 0.500 |

**BOTTOM**

**Cleveland Indians @ Kansas City Athletics**  
Municipal Stadium, Kansas City, MO

Tue Jul 14 1964, 8:05 PM EDT  
Att. 5,422 - Unknown

livebaseballscorecards.com

|            |           |
|------------|-----------|
| <b>AB</b>  | <b>38</b> |
| <b>R</b>   | <b>7</b>  |
| <b>H</b>   | <b>10</b> |
| <b>RBI</b> | <b>7</b>  |
| <b>BB</b>  | <b>1</b>  |
| <b>SO</b>  | <b>12</b> |
| <b>LOB</b> | <b>13</b> |



| Batter  | 1   | 2                               | 3                            | 4                               | 5                            | 6                               | 7                            | 8                               | 9                            | AB R H RBI BB SO LOB            | TOP   |                                  |                              |                                 |                              |                                 |                              |                                 |                                  |                                    |                                  |        |  |  |  |  |  |
|---|---|---------------------------------|------------------------------|---------------------------------|------------------------------|---------------------------------|------------------------------|---------------------------------|------------------------------|---------------------------------|---|----------------------------------|------------------------------|---------------------------------|------------------------------|---------------------------------|------------------------------|---------------------------------|----------------------------------|------------------------------------|----------------------------------|--------|--|--|--|--|--|
| Dick Howser, R (1, 6)<br>OBP: 0.299, SLG: 0.298   | 0-0<br>F2   |                                 |                              | 0-0<br>1-3                      |                              | 0-0<br>BB 1B<br>2-3 1B          |                              | 0-0<br>F9                       |                              | 4 1 1 0 0 0 0                   | <b>Cleveland Indians @ Kansas City Athletics</b><br>Municipal Stadium, Kansas City, MO<br>Wed Jul 15 1964, 8:05 PM EDT<br>Unknown |                                  |                              |                                 |                              |                                 |                              |                                 |                                  |                                    |                                  |        |  |  |  |  |  |
| Vic Davalillo, L (1, 8)<br>OBP: 0.285, SLG: 0.314 | 0-0<br>F8   |                                 |                              | 0-0<br>4-3                      |                              | 0-0<br>1-2<br>BB 1B             |                              | 0-0<br>1B<br>1B                 |                              | 4 1 2 0 0 0 0                   |   |                                  |                              |                                 |                              |                                 |                              |                                 |                                  |                                    |                                  |        |  |  |  |  |  |
| Leon Wagner, L (1, 7)<br>OBP: 0.341, SLG: 0.507   | 0-0<br>F5   |                                 |                              | 0-0<br>HR                       |                              | 4-0<br>1-2<br>2-3<br>BB         |                              | 0-0<br>1-2<br>1B                |                              | 3 1 2 1 1 0 0                   |   |                                  |                              |                                 |                              |                                 |                              |                                 |                                  |                                    |                                  |        |  |  |  |  |  |
| Bob Chance, L (1, 3)<br>OBP: 0.423, SLG: 0.580    |   | 4-0<br>F8-3<br>BB               |                              | 0-0<br>G3                       |                              | 0-0<br>1-2<br>2-H<br>3-H<br>1B  |                              | 0-3<br>K                        |                              | 3 0 1 2 1 1 2                   |   |                                  |                              |                                 |                              |                                 |                              |                                 |                                  |                                    |                                  |        |  |  |  |  |  |
| Tito Francona, L (1, 9)<br>OBP: 0.384, SLG: 0.393 |   | 0-0<br>F8-3                     |                              |                                 | 0-0<br>G6-4-3<br>1B          | 0-3<br>K                        |                              | 0-0<br>F2                       |                              | 3 0 1 0 0 1 3                   |   |                                  |                              |                                 |                              |                                 |                              |                                 |                                  |                                    |                                  |        |  |  |  |  |  |
| Gary Bell, R (6, 1)<br>OBP: 0.375, SLG: 0.375     |   | 1-2                             |                              |                                 |                              |                                 |                              |                                 |                              | 0 0 0 0 0 0 0                   |   |                                  |                              |                                 |                              |                                 |                              |                                 |                                  |                                    |                                  |        |  |  |  |  |  |
| Sonny Siebert, R (8, 1)<br>OBP: 0.294, SLG: 0.375 |   |                                 |                              |                                 |                              |                                 |                              |                                 |                              | 0 0 0 0 0 0 0                   |   |                                  |                              |                                 |                              |                                 |                              |                                 |                                  |                                    |                                  |        |  |  |  |  |  |
| Larry Brown, R (9, PH)<br>OBP: 0.266, SLG: 0.372  |   |                                 |                              |                                 |                              |                                 |                              |                                 |                              | 1 0 0 0 0 0 0                   |   |                                  |                              |                                 |                              |                                 |                              |                                 |                                  |                                    |                                  |        |  |  |  |  |  |
| John Romano, R (1, 2)<br>OBP: 0.358, SLG: 0.478   |   | 0-3<br>K                        |                              |                                 | 0-0<br>G6-4-3<br>1-2f        | 0-3<br>K                        |                              | 0-3<br>K                        |                              | 4 0 0 0 0 3 1                   |   |                                  |                              |                                 |                              |                                 |                              |                                 |                                  |                                    |                                  |        |  |  |  |  |  |
| Chico Salmon, R (1, 4)<br>OBP: 0.333, SLG: 0.348  |   |                                 | 0-0<br>6-3                   |                                 | 0-0<br>G3                    |                                 | 0-3<br>K                     |                                 | 0-3<br>K                     | 4 0 0 0 0 2 0                   |   |                                  |                              |                                 |                              |                                 |                              |                                 |                                  |                                    |                                  |        |  |  |  |  |  |
| Woodie Held, R (1, 5)<br>OBP: 0.298, SLG: 0.465   |   |                                 | 0-3<br>K                     |                                 |                              | 1-0<br>1B 4-3<br>HBP            |                              | 0-0<br>F4                       |                              | 2 0 0 0 0 1 0                   |   |                                  |                              |                                 |                              |                                 |                              |                                 |                                  |                                    |                                  |        |  |  |  |  |  |
| Jack Kralick, L (1, 1)<br>OBP: 0.188, SLG: 0.191  |   |                                 | 0-0<br>F8                    |                                 |                              | 0-0<br>4-3                      |                              | 0-0<br>4-3                      |                              | 1 0 0 0 0 0 0                   |   |                                  |                              |                                 |                              |                                 |                              |                                 |                                  |                                    |                                  |        |  |  |  |  |  |
| Pedro Ramos, S (5, 1)<br>OBP: 0.290, SLG: 0.448   |   |                                 |                              |                                 |                              |                                 |                              |                                 |                              | 0 0 0 0 0 0 0                   |   |                                  |                              |                                 |                              |                                 |                              |                                 |                                  |                                    |                                  |        |  |  |  |  |  |
| Billy Moran, R (6, PH)<br>OBP: 0.291, SLG: 0.292  |   |                                 |                              |                                 |                              |                                 |                              |                                 |                              | 2 0 0 0 0 0 1                   |   |                                  |                              |                                 |                              |                                 |                              |                                 |                                  |                                    |                                  |        |  |  |  |  |  |
| <b>Inning Stats</b>                               | R: 0<br>E: 0<br>K: 0<br>S: 3                          | H: 0<br>LOB: 0<br>BB: 0<br>P: 3 | R: 0<br>E: 0<br>K: 1<br>S: 4 | H: 0<br>LOB: 0<br>BB: 1<br>P: 8 | R: 0<br>E: 0<br>K: 1<br>S: 5 | H: 0<br>LOB: 0<br>BB: 0<br>P: 5 | R: 1<br>E: 0<br>K: 0<br>S: 4 | H: 1<br>LOB: 0<br>BB: 0<br>P: 4 | R: 0<br>E: 0<br>K: 0<br>S: 3 | H: 1<br>LOB: 0<br>BB: 0<br>P: 3 | R: 2<br>E: 0<br>K: 1<br>S: 7  | H: 3<br>LOB: 2<br>BB: 1<br>P: 12 | R: 0<br>E: 0<br>K: 2<br>S: 7 | H: 0<br>LOB: 0<br>BB: 0<br>P: 7 | R: 0<br>E: 0<br>K: 1<br>S: 7 | H: 2<br>LOB: 2<br>BB: 0<br>P: 7 | R: 0<br>E: 0<br>K: 2<br>S: 7 | H: 0<br>LOB: 0<br>BB: 0<br>P: 7 | 1B: 6<br>2B: 1<br>3B: 0<br>HR: 1 | SF: 0<br>SAC: 0<br>DP: 2<br>HBP: 1 | WP: 0<br>PB: 0<br>SB: 0<br>CS: 0 | PA: 34 |  |  |  |  |  |
| <b>PITCHER</b>                                    | IP WLS BF H R ER SO BB IBB HBP BLK WP HR S P ERA WHIP |                                 |                              |                                 |                              |                                 |                              |                                 |                              |                                 |   |                                  |                              |                                 |                              |                                 |                              |                                 |                                  |                                    |                                  |        |  |  |  |  |  |
| Orlando Pena, R (1, 1)<br>ERA: 4.29               | 5.2   |                                 | 22                           | 5                               | 3                            | 3                               | 2                            | 2                               | 0                            | 1                               | 0   | 0                                | 1                            | 23                              | 32                           | 4.76                            | 1.235                        |                                 |                                  |                                    |                                  |        |  |  |  |  |  |
| Wes Stock, R (6, 1)<br>ERA: 2.38                  | 3.1   | W                               | 12                           | 2                               | 0                            | 0                               | 6                            | 0                               | 0                            | 0                               | 0   | 0                                | 0                            | 24                              | 24                           | 0.00                            | 0.600                        |                                 |                                  |                                    |                                  |        |  |  |  |  |  |

|     |    |
|-----|----|
| AB  | 31 |
| R   | 3  |
| H   | 7  |
| RBI | 3  |
| BB  | 2  |
| SO  | 8  |
| LOB | 7  |





| Batter  | 1                 | 2                  | 3               | 4                  | 5          | 6               | 7                | 8                   | 9 |
|---|-------------------|--------------------|-----------------|--------------------|------------|-----------------|------------------|---------------------|---|
| Wayne Causey, L (1, 6)<br>OBP: 0.394, SLG: 0.384    | 0-0<br>1B<br>1B   | 1-0<br>FC6<br>HBP  |                 | 0-0<br>FC1-6<br>2B |            | 4-0<br>1B<br>BB |                  | 0-0<br>F9           |   |
| Dick Green, R (1, 4)<br>OBP: 0.294, SLG: 0.410      | 0-0<br>L5-3<br>1B | 0-0<br>FC6         |                 | 0-0<br>2B          |            | 0-0<br>1B       |                  | 0-0<br>1B           |   |
| Ken Harrelson, R (1, 3)<br>OBP: 0.400, SLG: 0.840   | 0-0<br>F5         |                    | 0-0<br>6-3      | 0-3<br>K           |            | 0-3<br>K        |                  | 0-0<br>G6-4-3<br>1B |   |
| Rocky Colavito, R (1, 9)<br>OBP: 0.367, SLG: 0.524  | 0-0<br>L5-3       |                    | 0-0<br>5-3      |                    | 0-3<br>K   |                 | 0-0<br>F8        | 0-0<br>G6-4-3       |   |
| George Alusik, R (1, 7)<br>OBP: 0.374, SLG: 0.392   |                   | 0-0<br>FC6-4<br>1B | 0-0<br>BB<br>1B |                    | 0-0<br>6-3 |                 | 0-0<br>1B<br>2B  |                     |   |
| Ed Charles, R (1, 5)<br>OBP: 0.321, SLG: 0.372      |                   | 0-0<br>FC6-4<br>1B | 4-0<br>BB       |                    | 0-0<br>F9  |                 | 0-0<br>F6        |                     |   |
| Doc Edwards, R (1, 2)<br>OBP: 0.213, SLG: 0.224     |                   | 0-0<br>6-3         | 0-0<br>F8       |                    |            | 0-0<br>5-3      | 4-0<br>1B<br>IBB |                     |   |
| Billy Bryan, L (7, PH)<br>OBP: 0.315, SLG: 0.538    |                   | 1-2                |                 |                    |            |                 |                  |                     |   |
| Nelson Mathews, R (1, 8)<br>OBP: 0.290, SLG: 0.347  |                   | 0-0<br>1B<br>1B    |                 | 0-0<br>1B<br>3B    |            | 0-3<br>K        | 0-0<br>1B        |                     |   |
| Jose Tartabull, L (7, PH)<br>OBP: 0.275, SLG: 0.282 |                   | 2-H                |                 |                    |            | 1-3<br>2-H      |                  |                     |   |
| Orlando Pena, R (1, 1)<br>OBP: 0.167, SLG: 0.196    |                   | 0-0<br>HBP         |                 | 0-0<br>FC1-6<br>1B |            | 4-0<br>1B<br>BB | 0-3<br>K         |                     |   |
| Wes Stock, R (6, 1)<br>OBP: 0.200, SLG: 0.111       |                   | 1-3<br>1B          |                 | 3-H                |            |                 |                  |                     |   |

| Inning Stats | R: 0 | H: 2 | E: 0 | K: 0 | S: 4 | LOB: 1 | BB: 0 | P: 4  |
|--------------|------|------|------|------|------|--------|-------|-------|
|              | R: 1 | H: 3 | E: 0 | K: 0 | S: 6 | LOB: 3 | BB: 0 | P: 7  |
|              | R: 0 | H: 1 | E: 0 | K: 0 | S: 4 | LOB: 2 | BB: 1 | P: 8  |
|              | R: 2 | H: 3 | E: 0 | K: 1 | S: 7 | LOB: 0 | BB: 0 | P: 7  |
|              | R: 0 | H: 0 | E: 0 | K: 1 | S: 5 | LOB: 0 | BB: 0 | P: 5  |
|              | R: 1 | H: 1 | E: 0 | K: 2 | S: 8 | LOB: 2 | BB: 2 | P: 16 |
|              | R: 1 | H: 2 | E: 0 | K: 1 | S: 7 | LOB: 2 | BB: 1 | P: 11 |
|              | R: 0 | H: 2 | E: 0 | K: 0 | S: 4 | LOB: 1 | BB: 0 | P: 4  |

| PITCHER                              | IP  | WLS | BF | H | R | ER | SO | BB | IBB | HBP | BLK | WP | HR | S  | P  | ERA  | WHIP  |
|--------------------------------------|-----|-----|----|---|---|----|----|----|-----|-----|-----|----|----|----|----|------|-------|
| Jack Kralick, L (1, 1)<br>ERA: 2.55  | 4.0 |     | 21 | 9 | 3 | 3  | 1  | 1  | 0   | 0   | 0   | 0  | 0  | 21 | 26 | 6.75 | 2.500 |
| Pedro Ramos, R (5, 1)<br>ERA: 4.09   | 1.0 |     | 3  | 0 | 0 | 0  | 1  | 0  | 0   | 0   | 0   | 0  | 0  | 5  | 5  | 0.00 | 0.000 |
| Gary Bell, R (6, 1)<br>ERA: 4.59     | 2.1 | L   | 15 | 5 | 2 | 2  | 3  | 2  | 1   | 0   | 0   | 0  | 0  | 18 | 30 | 7.71 | 3.000 |
| Sonny Siebert, R (8, 1)<br>ERA: 4.62 | 0.2 |     | 1  | 0 | 0 | 0  | 0  | 0  | 0   | 0   | 0   | 0  | 0  | 1  | 1  | 0.00 | 0.000 |

AB R H RBI BB SO LOB

|   |   |   |   |   |   |   |
|---|---|---|---|---|---|---|
| 3 | 1 | 1 | 0 | 1 | 0 | 1 |
| 5 | 0 | 4 | 2 | 0 | 0 | 3 |
| 5 | 0 | 1 | 0 | 0 | 2 | 4 |
| 5 | 0 | 0 | 0 | 0 | 1 | 4 |
| 4 | 1 | 3 | 0 | 0 | 0 | 0 |
| 3 | 1 | 0 | 0 | 1 | 0 | 2 |
| 3 | 0 | 0 | 0 | 0 | 0 | 3 |
| 0 | 0 | 0 | 0 | 1 | 0 | 0 |
| 3 | 1 | 2 | 1 | 0 | 1 | 0 |
| 1 | 0 | 1 | 1 | 0 | 0 | 0 |
| 2 | 0 | 2 | 1 | 0 | 0 | 0 |
| 1 | 1 | 0 | 0 | 1 | 1 | 2 |

|        |        |       |        |
|--------|--------|-------|--------|
| 1B: 11 | SF: 0  | WP: 0 | PA: 40 |
| 2B: 3  | SAC: 0 | PB: 0 |        |
| 3B: 1  | DP: 2  | SB: 0 |        |
| HR: 0  | HBP: 1 | CS: 0 |        |
| AB     | 35     |       |        |
| R      | 5      |       |        |
| H      | 14     |       |        |
| RBI    | 5      |       |        |
| BB     | 4      |       |        |
| SO     | 5      |       |        |
| LOB    | 19     |       |        |



**Cleveland Indians @ Kansas City Athletics**  
Municipal Stadium, Kansas City, MO  
Wed Jul 15 1964, 8:05 PM EDT  
Unknown

livebaseballscorecards.com

| Batter   | 1  | 2                               | 3                            | 4                               | 5                            | 6                               | 7                            | 8                               | 9                            | AB R H RBI BB SO LOB            | TOP   |                                 |  |                                  |                              |                                 |                              |                                 |                                  |                                    |                                  |        |
|--|--|---------------------------------|------------------------------|---------------------------------|------------------------------|---------------------------------|------------------------------|---------------------------------|------------------------------|---------------------------------|---|---------------------------------|--|----------------------------------|------------------------------|---------------------------------|------------------------------|---------------------------------|----------------------------------|------------------------------------|----------------------------------|--------|
| Dick Howser, R (1, 6)<br>OBP: 0.301, SLG: 0.296        | 0-0<br>F4  |                                 | 4-0<br>1B<br>SF7<br>BB       |                                 | 0-0<br>6-3                   |                                 |                              | 4-0<br>F9<br>FC3-6<br>BB        |                              | 2 2 0 0 2 0 0                   | <b>Cleveland Indians @ Kansas City Athletics</b><br>Municipal Stadium, Kansas City, MO<br>Wed Jul 15 1964, 8:05 PM EDT<br>Att: 10,341 - Unknown<br><a href="http://livebaseballscorecards.com">livebaseballscorecards.com</a> |                                 |  |                                  |                              |                                 |                              |                                 |                                  |                                    |                                  |        |
| Vic Davalillo, L (1, 8)<br>OBP: 0.285, SLG: 0.311      | 0-0<br>1-3   |                                 | 0-0<br>F7                    |                                 | 0-0<br>4-3                   |                                 | 4-0<br>FC3-6<br>BB           |                                 | 3 0 0 0 1 0 1                |                                 |   |                                 |  |                                  |                              |                                 |                              |                                 |                                  |                                    |                                  |        |
| Leon Wagner, L (1, 7)<br>OBP: 0.340, SLG: 0.504        | 0-0<br>F2  |                                 | 0-0<br>SF7<br>1B             |                                 | 0-0<br>4-3                   |                                 | 0-0<br>F9                    |                                 | 4 0 1 0 0 0 2                |                                 |   |                                 |  |                                  |                              |                                 |                              |                                 |                                  |                                    |                                  |        |
| Bob Chance, L (1, 3)<br>OBP: 0.420, SLG: 0.576         |  | 0-0<br>G6-4-3<br>1B             | 0-0<br>SF7                   |                                 | 0-0<br>6-3                   |                                 | 0-0<br>FC3-6                 |                                 | 3 0 1 2 0 0 1                |                                 |   |                                 |  |                                  |                              |                                 |                              |                                 |                                  |                                    |                                  |        |
| Al Smith, R (1, 9)<br>OBP: 0.202, SLG: 0.298           |  | 0-0<br>G6-4-3                   | 0-0<br>6-3                   |                                 | 0-0<br>F2                    |                                 | 0-0<br>G3                    |                                 | 4 0 0 0 0 0 3                |                                 |   |                                 |  |                                  |                              |                                 |                              |                                 |                                  |                                    |                                  |        |
| Joe Azcue, R (1, 2)<br>OBP: 0.244, SLG: 0.300          |  | 0-0<br>E<br>1B<br>1B            |                              | 0-3<br>K                        |                              | 0-0<br>4-3                      |                              | 0-0<br>F5                       | 4 0 1 0 0 1 0                |                                 |   |                                 |  |                                  |                              |                                 |                              |                                 |                                  |                                    |                                  |        |
| Larry Brown, R (1, 4)<br>OBP: 0.266, SLG: 0.370        |  | 0-0<br>E<br>1B                  |                              | 0-0<br>5-3                      |                              | 0-0<br>F9                       |                              | 0-0<br>F8                       | 4 0 1 0 0 0 0                |                                 |   |                                 |  |                                  |                              |                                 |                              |                                 |                                  |                                    |                                  |        |
| Woodie Held, R (1, 5)<br>OBP: 0.302, SLG: 0.463        |  | 0-0<br>E5                       |                              | 0-0<br>1B                       |                              | 0-0<br>F8                       |                              | 4-0<br>BB                       | 3 0 1 0 1 0 2                |                                 |   |                                 |  |                                  |                              |                                 |                              |                                 |                                  |                                    |                                  |        |
| Lee Stange, R (1, 1)<br>OBP: 0.176, SLG: 0.036         |  | 0-3<br>K                        |                              | 0-0<br>F9                       |                              | 0-0<br>6-3                      |                              | 0-0<br>F2                       | 2 0 0 0 0 1 4                |                                 |   |                                 |  |                                  |                              |                                 |                              |                                 |                                  |                                    |                                  |        |
| Billy Moran, R (7, PH)<br>OBP: 0.290, SLG: 0.291       |  |                                 |                              |                                 |                              |                                 |                              |                                 | 1 0 0 0 0 0 0                |                                 |   |                                 |  |                                  |                              |                                 |                              |                                 |                                  |                                    |                                  |        |
| Don McMahon, R (7, 1)<br>OBP: 0.143, SLG: 0.143        |  |                                 |                              |                                 |                              |                                 |                              |                                 | 0 0 0 0 0 0 0                |                                 |   |                                 |  |                                  |                              |                                 |                              |                                 |                                  |                                    |                                  |        |
| John Romano, R (9, PH)<br>OBP: 0.357, SLG: 0.476       |  |                                 |                              |                                 |                              |                                 |                              |                                 | 1 0 0 0 0 0 1                |                                 |   |                                 |  |                                  |                              |                                 |                              |                                 |                                  |                                    |                                  |        |
| <b>Inning Stats</b>                                    | R: 0<br>E: 0<br>K: 0<br>S: 3   | H: 0<br>LOB: 0<br>BB: 0<br>P: 3 | R: 0<br>E: 1<br>K: 1<br>S: 8 | H: 3<br>LOB: 3<br>BB: 0<br>P: 8 | R: 1<br>E: 0<br>K: 0<br>S: 4 | H: 1<br>LOB: 1<br>BB: 1<br>P: 8 | R: 0<br>E: 0<br>K: 1<br>S: 6 | H: 1<br>LOB: 1<br>BB: 0<br>P: 6 | R: 0<br>E: 0<br>K: 0<br>S: 3 | H: 0<br>LOB: 0<br>BB: 0<br>P: 3 | R: 0<br>E: 0<br>K: 0<br>S: 3  | H: 0<br>LOB: 0<br>BB: 0<br>P: 3 | R: 0<br>E: 0<br>K: 0<br>S: 3   | H: 0<br>LOB: 1<br>BB: 2<br>P: 11 | R: 1<br>E: 0<br>K: 0<br>S: 3 | H: 0<br>LOB: 1<br>BB: 2<br>P: 7 | R: 0<br>E: 0<br>K: 0<br>S: 3 | H: 0<br>LOB: 1<br>BB: 1<br>P: 7 | 1B: 5<br>2B: 0<br>3B: 0<br>HR: 0 | SF: 1<br>SAC: 0<br>DP: 1<br>HBP: 0 | WP: 0<br>PB: 0<br>SB: 0<br>CS: 0 | PA: 36 |
| <b>PITCHER</b><br>Ted Bowsfield, L (1, 1)<br>ERA: 4.57 | IP: 9.0<br>WLS: W<br>BF: 36<br>H: 5<br>R: 2<br>ER: 2<br>SO: 2<br>BB: 4<br>IBB: 0<br>HBP: 0<br>BLK: 0<br>WP: 0<br>HR: 0<br>S: 36<br>P: 52<br>ERA: 2.00<br>WHIP: 1.000 |                                 |                              |                                 |                              |                                 |                              |                                 |                              |                                 |   | <b>PITCHER</b>                  | IP: WLS: BF: H: R: ER: SO: BB: IBB: HBP: BLK: WP: HR: S: P: ERA: WHIP: |                                  |                              |                                 |                              |                                 |                                  |                                    |                                  |        |



| Batter  | 1          | 2                | 3                    | 4                     | 5          | 6          | 7 | 8          | 9 | AB | R | H | RBI | BB | SO | LOB |
|---|------------|------------------|----------------------|-----------------------|------------|------------|---|------------|---|----|---|---|-----|----|----|-----|
| Jose Tartabull, L (1, 8)<br>OBP: 0.250, SLG: 0.256  | 0-0<br>1-3 |                  | 0-0<br>F8            |                       | 0-0<br>4-3 |            |   | 0-0<br>F4  |   | 4  | 0 | 0 | 0   | 0  | 0  | 0   |
| Wayne Causey, L (1, 6)<br>OBP: 0.397, SLG: 0.384  | 4-0<br>BB  |                  | 0-0<br>FC5-4<br>1B   |                       |            | 0-0<br>F8  |   | 1-0<br>HBP |   | 2  | 0 | 1 | 0   | 1  | 0  | 0   |
| Dick Green, R (1, 4)<br>OBP: 0.290, SLG: 0.406<br>Charlie Shoemaker, L (7, 4)<br>OBP: 0.200, SLG: 0.300 | 0-0<br>F9  |                  | 0-0<br>F9            |                       |            | 0-0<br>5-3 |   | 0-0<br>3-1 |   | 3  | 0 | 0 | 0   | 0  | 0  | 2   |
| Rocky Colavito, R (1, 9)<br>OBP: 0.367, SLG: 0.532  | 0-0<br>F7  |                  | 0-0<br>FC5-4<br>1-2f |                       |            | 0-0<br>HR  |   |            |   | 3  | 1 | 1 | 1   | 0  | 0  | 2   |
| Manny Jimenez, L (1, 7)<br>OBP: 0.299, SLG: 0.552<br>George Alusik, R (3, 7)<br>OBP: 0.376, SLG: 0.394  |            | 0-3<br>K         |                      | 0-0<br>G6-4-3<br>1B   |            | 0-0<br>F7  |   |            |   | 1  | 0 | 0 | 0   | 0  | 1  | 0   |
| Ken Harrelson, R (1, 3)<br>OBP: 0.357, SLG: 0.750   |            | 0-3<br>K         |                      | 0-0<br>G6-4-3<br>1-2f |            | 0-0<br>F7  |   |            |   | 3  | 0 | 0 | 0   | 0  | 1  | 1   |
| Ed Charles, R (1, 5)<br>OBP: 0.318, SLG: 0.368  |            | 0-0<br>E6<br>HR  |                      | 0-3<br>K              |            | 0-0<br>F2  |   |            |   | 3  | 1 | 0 | 0   | 0  | 1  | 0   |
| Billy Bryan, L (1, 2)<br>OBP: 0.316, SLG: 0.557   |            | 0-0<br>1-H<br>HR |                      | 0-3<br>K              |            | 0-0<br>F3  |   |            |   | 3  | 1 | 1 | 2   | 0  | 1  | 0   |
| Ted Bowsfield, R (1, 1)   |            | 0-3<br>K         |                      | 0-3<br>K              |            |            |   | 0-3<br>K   |   | 3  | 0 | 0 | 0   | 0  | 3  | 0   |

| Inning Stats | R: 0 | H: 0 | E: 0 | K: 0 | S: 3 | R: 2 | H: 1 | E: 1 | K: 3 | S: 11 | R: 0 | H: 1 | E: 0 | K: 1 | S: 5 | R: 0 | H: 0 | E: 0 | K: 2 | S: 7 | R: 1 | H: 1 | E: 0 | K: 0 | S: 4 | R: 0 | H: 0 | E: 0 | K: 0 | S: 3 | R: 0 | H: 0 | E: 0 | K: 1 | S: 5 |   |
|--------------|------|------|------|------|------|------|------|------|------|-------|------|------|------|------|------|------|------|------|------|------|------|------|------|------|------|------|------|------|------|------|------|------|------|------|------|---|
|              | 0    | 0    | 0    | 0    | 7    | 0    | 1    | 0    | 0    | 11    | 0    | 1    | 0    | 1    | 5    | 0    | 0    | 0    | 0    | 0    | 7    | 0    | 1    | 0    | 0    | 4    | 0    | 0    | 0    | 0    | 3    | 0    | 0    | 0    | 6    | 0 |

**BOTTOM**

**Cleveland Indians @ Kansas City Athletics**  
**Municipal Stadium, Kansas City, MO**  
 Wed Jul 15 1964, 8:05 PM EDT  
 Att. 10,341 - Unknown

|     |    |
|-----|----|
| AB  | 28 |
| R   | 3  |
| H   | 4  |
| RBI | 3  |
| BB  | 1  |
| SO  | 7  |
| LOB | 6  |

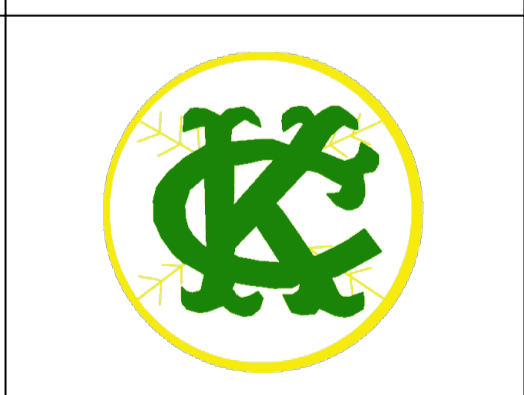

|       |        |       |        |
|-------|--------|-------|--------|
| 1B: 2 | SF: 0  | WP: 0 | PA: 30 |
| 2B: 0 | SAC: 0 | PB: 0 |        |
| 3B: 0 | DP: 1  | SB: 0 |        |
| HR: 2 | HBP: 1 | CS: 0 |        |

| PITCHER                            | IP  | WLS | BF | H | R | ER | SO | BB | IBB | HBP | BLK | WP | HR | S  | P  | ERA  | WHIP  |
|------------------------------------|-----|-----|----|---|---|----|----|----|-----|-----|-----|----|----|----|----|------|-------|
| Lee Stange, R (1, 1)<br>ERA: 5.13  | 6.0 | L   | 23 | 4 | 3 | 1  | 6  | 1  | 0   | 0   | 0   | 0  | 2  | 34 | 38 | 1.50 | 0.833 |
| Don McMahon, R (7, 1)<br>ERA: 1.64 | 2.0 |     | 7  | 0 | 0 | 0  | 1  | 0  | 0   | 1   | 0   | 0  | 0  | 8  | 9  | 0.00 | 0.000 |

| Batter  | 1                            | 2                                | 3                            | 4                               | 5                            | 6                               | 7                            | 8                               | 9                            | 10                              | AB                           | R                                | H                            | RBI                             | BB                           | SO                              | LOB                          | TOP                              |                                   |                                    |                                  |        |  |  |
|---|------------------------------|----------------------------------|------------------------------|---------------------------------|------------------------------|---------------------------------|------------------------------|---------------------------------|------------------------------|---------------------------------|------------------------------|----------------------------------|------------------------------|---------------------------------|------------------------------|---------------------------------|------------------------------|----------------------------------|-----------------------------------|------------------------------------|----------------------------------|--------|--|--|
| <b>Dick Howser, R</b><br>OBP: 0.307, SLG: 0.298<br>(1, 6)     |                              |                                  |                              |                                 |                              |                                 |                              |                                 |                              |                                 | 4                            | 2                                | 2                            | 1                               | 2                            | 0                               | 1                            |                                  |                                   |                                    |                                  |        |  |  |
| <b>Vic Davalillo, L</b><br>OBP: 0.286, SLG: 0.318<br>(1, 8)   |                              |                                  |                              |                                 |                              |                                 |                              |                                 |                              |                                 | 6                            | 1                                | 2                            | 2                               | 0                            | 1                               | 3                            |                                  |                                   |                                    |                                  |        |  |  |
| <b>Leon Wagner, L</b><br>OBP: 0.340, SLG: 0.500<br>(1, 7)     |                              |                                  |                              |                                 |                              |                                 |                              |                                 |                              |                                 | 5                            | 1                                | 1                            | 2                               | 1                            | 2                               | 1                            |                                  |                                   |                                    |                                  |        |  |  |
| <b>Bob Chance, L</b><br>OBP: 0.414, SLG: 0.565<br>(1, 3)      |                              |                                  |                              |                                 |                              |                                 |                              |                                 |                              |                                 | 5                            | 1                                | 1                            | 0                               | 0                            | 2                               | 1                            |                                  |                                   |                                    |                                  |        |  |  |
| <b>Al Smith, R</b><br>OBP: 0.202, SLG: 0.294<br>(1, 9)        |                              |                                  |                              |                                 |                              |                                 |                              |                                 |                              |                                 | 5                            | 1                                | 1                            | 1                               | 0                            | 3                               | 0                            |                                  |                                   |                                    |                                  |        |  |  |
| <b>Joe Azcue, R</b><br>OBP: 0.265, SLG: 0.339<br>(1, 2)       |                              |                                  |                              |                                 |                              |                                 |                              |                                 |                              |                                 | 4                            | 2                                | 3                            | 1                               | 1                            | 1                               | 0                            |                                  |                                   |                                    |                                  |        |  |  |
| <b>Larry Brown, R</b><br>OBP: 0.277, SLG: 0.376<br>(1, 4)     |                              |                                  |                              |                                 |                              |                                 |                              |                                 |                              |                                 | 4                            | 3                                | 3                            | 0                               | 0                            | 1                               | 0                            |                                  |                                   |                                    |                                  |        |  |  |
| <b>Woodie Held, R</b><br>OBP: 0.310, SLG: 0.470<br>(1, 5)     |                              |                                  |                              |                                 |                              |                                 |                              |                                 |                              |                                 | 4                            | 0                                | 2                            | 3                               | 0                            | 1                               | 2                            |                                  |                                   |                                    |                                  |        |  |  |
| <b>Tommy John, R</b><br>OBP: 0.228, SLG: 0.208<br>(1, 1)      |                              |                                  |                              |                                 |                              |                                 |                              |                                 |                              |                                 | 0                            | 0                                | 0                            | 0                               | 0                            | 0                               | 0                            |                                  |                                   |                                    |                                  |        |  |  |
| <b>Gary Bell, R</b><br>OBP: 0.275, SLG: 0.375<br>(1, 1)       |                              |                                  |                              |                                 |                              |                                 |                              |                                 |                              |                                 | 0                            | 0                                | 0                            | 0                               | 0                            | 0                               | 0                            |                                  |                                   |                                    |                                  |        |  |  |
| <b>Sonny Siebert, R</b><br>OBP: 0.276, SLG: 0.353<br>(4, PH)  |                              |                                  |                              |                                 |                              |                                 |                              |                                 |                              |                                 | 1                            | 0                                | 0                            | 0                               | 0                            | 0                               | 0                            |                                  |                                   |                                    |                                  |        |  |  |
| <b>Tito Francona, L</b><br>OBP: 0.382, SLG: 0.390<br>(6, PH)  |                              |                                  |                              |                                 |                              |                                 |                              |                                 |                              |                                 | 1                            | 0                                | 0                            | 0                               | 0                            | 1                               | 1                            |                                  |                                   |                                    |                                  |        |  |  |
| <b>Ted Abernathy, R</b><br>OBP: 0.298, SLG: 0.391<br>(6, PH)  |                              |                                  |                              |                                 |                              |                                 |                              |                                 |                              |                                 | 1                            | 0                                | 0                            | 0                               | 0                            | 0                               | 0                            |                                  |                                   |                                    |                                  |        |  |  |
| <b>Fred Whitfield, L</b><br>OBP: 0.298, SLG: 0.391<br>(8, PH) |                              |                                  |                              |                                 |                              |                                 |                              |                                 |                              |                                 | 1                            | 0                                | 0                            | 0                               | 0                            | 0                               | 2                            |                                  |                                   |                                    |                                  |        |  |  |
| <b>Don McMahon, R</b><br>OBP: 0.296, SLG: 0.250<br>(8, PH)    |                              |                                  |                              |                                 |                              |                                 |                              |                                 |                              |                                 | 1                            | 1                                | 1                            | 0                               | 0                            | 0                               | 0                            |                                  |                                   |                                    |                                  |        |  |  |
| <b>Inning Stats</b>   | R: 7<br>E: 2<br>K: 0<br>S: 7 | H: 5<br>LOB: 1<br>BB: 2<br>P: 16 | R: 0<br>E: 0<br>K: 1<br>S: 5 | H: 0<br>LOB: 0<br>BB: 0<br>P: 5 | R: 0<br>E: 0<br>K: 2<br>S: 7 | H: 0<br>LOB: 0<br>BB: 0<br>P: 7 | R: 0<br>E: 0<br>K: 1<br>S: 6 | H: 1<br>LOB: 1<br>BB: 0<br>P: 6 | R: 0<br>E: 0<br>K: 1<br>S: 6 | H: 2<br>LOB: 1<br>BB: 0<br>P: 6 | R: 0<br>E: 0<br>K: 2<br>S: 7 | H: 0<br>LOB: 1<br>BB: 1<br>P: 11 | R: 2<br>E: 0<br>K: 1<br>S: 8 | H: 3<br>LOB: 2<br>BB: 0<br>P: 9 | R: 0<br>E: 0<br>K: 2<br>S: 7 | H: 0<br>LOB: 0<br>BB: 0<br>P: 7 | R: 3<br>E: 0<br>K: 1<br>S: 8 | H: 5<br>LOB: 1<br>BB: 1<br>P: 12 | 1B: 12<br>2B: 3<br>3B: 0<br>HR: 1 | SF: 0<br>SAC: 1<br>DP: 1<br>HBP: 2 | WP: 0<br>PB: 0<br>SB: 0<br>CS: 1 | PA: 48 |  |  |
| <b>PITCHER</b>  | IP                           | WLS                              | BF                           | H                               | R                            | ER                              | SO                           | BB                              | IBB                          | HBP                             | BLK                          | WP                               | HR                           | S                               | P                            | ERA                             | WHIP                         |                                  |                                   |                                    |                                  |        |  |  |
| <b>John O'Donoghue, L</b><br>ERA: 4.69<br>(1, 1)              | 0.0                          |                                  | 4                            | 3                               | 4                            | 4                               | 0                            | 1                               | 0                            | 0                               | 0                            | 0                                | 0                            | 3                               | 7                            | ∞                               | ∞                            |                                  |                                   |                                    |                                  |        |  |  |
| <b>Jose Santiago, R</b><br>ERA: 4.23<br>(1, 1)                | 5.0                          |                                  | 21                           | 5                               | 3                            | 2                               | 5                            | 1                               | 0                            | 1                               | 0                            | 0                                | 0                            | 29                              | 34                           | 3.60                            | 1.200                        |                                  |                                   |                                    |                                  |        |  |  |
| <b>Dan Pfister, R</b><br>ERA: 7.39<br>(6, 1)                  | 2.1                          |                                  | 10                           | 2                               | 2                            | 2                               | 4                            | 1                               | 0                            | 1                               | 0                            | 0                                | 1                            | 16                              | 21                           | 7.71                            | 1.286                        |                                  |                                   |                                    |                                  |        |  |  |
| <b>Diego Segui, R</b><br>ERA: 4.08<br>(8, 1)                  | 0.2                          |                                  | 3                            | 1                               | 0                            | 0                               | 0                            | 0                               | 0                            | 0                               | 0                            | 0                                | 0                            | 3                               | 3                            | 0.00                            | 1.500                        |                                  |                                   |                                    |                                  |        |  |  |
| <b>Joe Grzenda, L</b><br>ERA: 5.4<br>(9, 1)                   | 1.1                          | L                                | 6                            | 3                               | 2                            | 2                               | 2                            | 0                               | 0                            | 0                               | 0                            | 0                                | 0                            | 10                              | 10                           | 13.50                           | 2.250                        |                                  |                                   |                                    |                                  |        |  |  |

**Cleveland Indians @ Kansas City Athletics**  
**Municipal Stadium, Kansas City, MO**  
Thu Jul 16 1964, 4:33 AM EDT  
Att: 3,129 - Unknown

|     |    |
|-----|----|
| AB  | 41 |
| R   | 12 |
| H   | 16 |
| RBI | 10 |
| BB  | 4  |
| SO  | 12 |
| LOB | 11 |



Cleveland Indians @ Kansas City Athletics  
Municipal Stadium, Kansas City, MO

Thu Jul 16 1964, 4:33 AM EDT  
Att. 3,129 - Unknown

livebaseballscorecards.com



WP: 3 PA: 49  
PB: 0  
SB: 0  
CS: 3

| Batter   | 1                               | 2             | 3                 | 4               | 5          | 6                     | 7              | 8                  | 9         | 10                 | AB | R | H | RBI | BB | SO | LOB |
|--|---------------------------------|---------------|-------------------|-----------------|------------|-----------------------|----------------|--------------------|-----------|--------------------|----|---|---|-----|----|----|-----|
| Wayne Causey, L (1, 6)<br>OBP: 0.399, SLG: 0.394   | 0-0<br>BB 1B<br>1B              | 0-0<br>G3     | 0-0<br>SF7        |                 |            | 0-0<br>HR             |                | 0-0<br>L5          |           | 4-0<br>WP 1B<br>BB | 4  | 2 | 2 | 2   | 1  | 0  | 1   |
| Ed Charles, R (1, 5)<br>OBP: 0.326, SLG: 0.375   | 4-0<br>BB 1B<br>1-2             | 0-0<br>2B 1B  | 0-0<br>CS 1B      |                 |            | 0-0<br>G6-4-3<br>1B   |                | 0-0<br>L6-3<br>1-2 |           | 0-0<br>WP 1B       | 5  | 1 | 4 | 0   | 1  | 0  | 1   |
| Ken Harrelson, R (1, 3)<br>OBP: 0.324, SLG: 0.636  | 0-3<br>K                        | 0-0<br>F7     | 0-0<br>CS 1B      | 4-0<br>1B CS BB |            | 0-0<br>G6-4-3<br>1-2f |                | 0-0<br>F9          |           | 0-3<br>K 1-2 2-3   | 5  | 0 | 0 | 0   | 1  | 2  | 6   |
| Rocky Colavito, R (1, 9)<br>OBP: 0.370, SLG: 0.534   | 4-0<br>BB 1B<br>1-2 2-3         | 0-0<br>1-3 2B |                   | 0-0<br>F8       |            | 0-3<br>K              |                | 4-0<br>WP BB       |           |                    | 3  | 1 | 1 | 0   | 2  | 1  | 1   |
| George Alusik, R (1, 7)<br>OBP: 0.376, SLG: 0.394  | 0-0<br>4-3 BB<br>1-2 2-H 3-H 1B | 0-0<br>5-3    |                   | 0-0<br>CS 1B    |            | 0-0<br>5-3            |                | 0-0<br>F4 1-2      |           |                    | 5  | 1 | 2 | 2   | 0  | 0  | 3   |
| Doc Edwards, R (1, 2)<br>OBP: 0.227, SLG: 0.228  | 4-0<br>4-3 BB<br>1-2 2-3 1B     |               | 0-0<br>WP 2B 1B   | 0-0<br>F7 3-H   |            | 4-0<br>BB BB BB       |                | 4-0<br>BB BB       |           |                    | 2  | 2 | 1 | 0   | 2  | 0  | 2   |
| Billy Bryan, L (9, PH)<br>OBP: 0.321, SLG: 0.557   | 10, 2                           |               |                   |                 |            |                       |                |                    |           |                    | 0  | 0 | 0 | 0   | 1  | 0  | 0   |
| Charlie Shoemaker, L (1, 4)<br>OBP: 0.200, SLG: 0.333  | 0-0<br>4-3<br>1-2 2-3 3-H 1B    |               | 0-0<br>1-H 1B 2B  |                 | 0-3<br>K   |                       | 0-0<br>F8      |                    | 0-0<br>F5 |                    | 5  | 1 | 1 | 2   | 0  | 1  | 5   |
| Nelson Mathews, R (1, 8)<br>OBP: 0.291, SLG: 0.348   | 0-0<br>2-H 3-H 1B               |               | 0-0<br>4-3 SF7 1B |                 | 0-0<br>1-3 |                       | 0-0<br>1-3     |                    |           | 0-3<br>K           | 5  | 1 | 2 | 3   | 0  | 1  | 1   |
| John O'Donoghue, R (1, 1)<br>Jose Santiago, R (1, 1)<br>Dan Frieser, R (1, 1)<br>Diego Segui, R (1, 1)<br>Manny Gonzalez, L (1, 1)<br>Jose Tartabull, L (1, 1)<br>Joe Grzenda, R (1, 1)<br>John Wyatt, R (1, 1)<br>Jim Gentile, L (1, 1) | 0-3<br>K                        |               | 0-0<br>4-3        |                 | 0-3<br>K   |                       | 4-0<br>L6-3 BB |                    | 0-3<br>K  |                    | 0  | 0 | 0 | 0   | 0  | 0  | 0   |

| Inning Stats | R: 5 | H: 3 | E: 0 | K: 2 | S: 10 | P: 22 | R: 0 | H: 2 | E: 0 | K: 0 | S: 5 | P: 5 | R: 3 | H: 4 | E: 0 | K: 0 | S: 6 | R: 0 | H: 1 | E: 0 | K: 0 | S: 3 | P: 7 | R: 0 | H: 0 | E: 0 | K: 2 | S: 7 | P: 7 | R: 1 | H: 2 | E: 0 | K: 1 | S: 6 | R: 0 | H: 0 | E: 0 | K: 0 | S: 3 | P: 7 | R: 0 | H: 0 | E: 0 | K: 0 | S: 2 | P: 6 | R: 0 | H: 0 | E: 0 | K: 0 | S: 3 | P: 11 | R: 0 | H: 1 | E: 0 | K: 3 | S: 10 | P: 14 | 1B: 10 | SF: 1 | 2B: 3 | SAC: 0 | 3B: 0 | DP: 2 | HR: 1 | HBP: 0 | WP: 3 | PA: 49 |
|--------------|------|------|------|------|-------|-------|------|------|------|------|------|------|------|------|------|------|------|------|------|------|------|------|------|------|------|------|------|------|------|------|------|------|------|------|------|------|------|------|------|------|------|------|------|------|------|------|------|------|------|------|------|-------|------|------|------|------|-------|-------|--------|-------|-------|--------|-------|-------|-------|--------|-------|--------|
|--------------|------|------|------|------|-------|-------|------|------|------|------|------|------|------|------|------|------|------|------|------|------|------|------|------|------|------|------|------|------|------|------|------|------|------|------|------|------|------|------|------|------|------|------|------|------|------|------|------|------|------|------|------|-------|------|------|------|------|-------|-------|--------|-------|-------|--------|-------|-------|-------|--------|-------|--------|

| PITCHER                              | IP  | WLS | BF | H | R | ER | SO | BB | IBB | HBP | BLK | WP | HR | S  | P  | ERA   | WHIP  |
|--------------------------------------|-----|-----|----|---|---|----|----|----|-----|-----|-----|----|----|----|----|-------|-------|
| Tommy John, L (1, 1)<br>ERA: 4.3     | 0.2 |     | 8  | 3 | 5 | 5  | 1  | 3  | 0   | 0   | 0   | 0  | 0  | 7  | 19 | 67.50 | 9.000 |
| Gary Bell, R (1, 1)<br>ERA: 4.89     | 2.1 |     | 12 | 6 | 3 | 3  | 1  | 0  | 0   | 0   | 0   | 1  | 0  | 14 | 14 | 11.57 | 2.571 |
| Sonny Siebert, R (4, 1)<br>ERA: 4.48 | 2.0 |     | 7  | 1 | 0 | 0  | 2  | 1  | 0   | 0   | 0   | 0  | 0  | 10 | 14 | 0.00  | 1.000 |
| Ted Abernathy, R (6, 1)<br>ERA: 3.28 | 2.0 |     | 8  | 2 | 1 | 1  | 1  | 1  | 0   | 0   | 0   | 0  | 1  | 9  | 13 | 4.50  | 1.500 |
| Don McMahon, R (8, 1)<br>ERA: 1.55   | 3.0 | W   | 13 | 1 | 0 | 0  | 3  | 4  | 0   | 0   | 0   | 2  | 0  | 15 | 31 | 0.00  | 1.667 |

| Batter  | 1   | 2                               | 3                            | 4                               | 5                            | 6                               | 7                            | 8                                | 9                            | AB R H RBI BB SO LOB            | TOP   |                                 |  |                                 |                              |                                 |                              |                                  |                                  |                                    |                                  |        |
|---|---|---------------------------------|------------------------------|---------------------------------|------------------------------|---------------------------------|------------------------------|----------------------------------|------------------------------|---------------------------------|---|---------------------------------|--|---------------------------------|------------------------------|---------------------------------|------------------------------|----------------------------------|----------------------------------|------------------------------------|----------------------------------|--------|
| Wayne Causey, L (1, 6)<br>OBP: 0.397, SLG: 0.391      | 4-0<br>FC6-4<br>BB  |                                 | 0-0<br>F6                    |                                 | 0-0<br>G4-6-3                |                                 |                              | 0-3<br>K                         |                              | 3 0 0 0 1 1 1                   | <b>Kansas City Athletics @ Chicago White Sox</b><br>Comiskey Park, Chicago, IL<br>Fri Jul 17 1964, 8:05 PM EDT<br>Att. 22,432 - Unknown |                                 |  |                                 |                              |                                 |                              |                                  |                                  |                                    |                                  |        |
| Ed Charles, R (1, 5)<br>OBP: 0.323, SLG: 0.370        | 0-0<br>FC6-4<br>WP  |                                 |                              | 0-3<br>K                        |                              | 0-3<br>K                        |                              | 0-0<br>6-3                       |                              | 4 0 0 0 0 2 1                   |   |                                 |  |                                 |                              |                                 |                              |                                  |                                  |                                    |                                  |        |
| Manny Jimenez, L (1, 7)<br>OBP: 0.296, SLG: 0.535     | 0-0<br>G3   |                                 |                              | 0-3<br>K                        |                              | 0-0<br>4-3                      |                              |                                  | 0-3<br>K                     | 4 0 0 0 0 2 1                   |   |                                 |  |                                 |                              |                                 |                              |                                  |                                  |                                    |                                  |        |
| Rocky Colavito, R (1, 9)<br>OBP: 0.372, SLG: 0.539    | 0-0<br>6-3  |                                 |                              | 0-0<br>2B                       |                              | 0-0<br>2B                       |                              |                                  | 0-3<br>K                     | 4 1 2 0 0 1 1                   |   |                                 |  |                                 |                              |                                 |                              |                                  |                                  |                                    |                                  |        |
| Ken Harrelson, R (1, 3)<br>OBP: 0.342, SLG: 0.600     |   | 0-0<br>1-3                      |                              | 4-0<br>2B<br>BB                 |                              | 0-3<br>K                        |                              |                                  | 4-0<br>BB                    | 2 0 0 0 0 2 1 1                 |   |                                 |  |                                 |                              |                                 |                              |                                  |                                  |                                    |                                  |        |
| Billy Bryan, L (1, 2)<br>OBP: 0.326, SLG: 0.560       |   | 4-0<br>G6-4-3<br>BB             |                              | 0-0<br>1-3<br>2-H<br>2B         |                              |                                 | 0-3<br>K                     |                                  | 0-3<br>K                     | 3 0 1 1 1 2 1                   |   |                                 |  |                                 |                              |                                 |                              |                                  |                                  |                                    |                                  |        |
| Nelson Mathews, R (1, 8)<br>OBP: 0.289, SLG: 0.345    |   | 0-0<br>G6-4-3                   |                              | 0-0<br>5-3                      |                              |                                 | 0-0<br>L1                    |                                  |                              | 3 0 0 0 0 0 3                   |   |                                 |  |                                 |                              |                                 |                              |                                  |                                  |                                    |                                  |        |
| Charlie Shoemaker, L (1, 4)<br>OBP: 0.167, SLG: 0.278 |   |                                 | 0-0<br>F8                    |                                 | 0-0<br>G3                    |                                 |                              | 0-0<br>F6                        |                              | 3 0 0 0 0 0 0                   |   |                                 |  |                                 |                              |                                 |                              |                                  |                                  |                                    |                                  |        |
| Moe Drabowsky, R (1, 1)<br>OBP: 0.031, SLG: 0.031     |   |                                 | 0-0<br>F8                    |                                 | 0-0<br>E1                    |                                 |                              | 0-3<br>K                         |                              | 2 0 0 0 0 0 0                   |   |                                 |  |                                 |                              |                                 |                              |                                  |                                  |                                    |                                  |        |
| Wes Stock, R (6, 1)<br>OBP: 0.200, SLG: 0.111         |   |                                 |                              |                                 |                              |                                 |                              |                                  |                              | 0 0 0 0 0 0 0                   |   |                                 |  |                                 |                              |                                 |                              |                                  |                                  |                                    |                                  |        |
| George Alusik, R (8, PH)<br>OBP: 0.374, SLG: 0.392    |   |                                 |                              |                                 |                              |                                 |                              |                                  |                              | 1 0 0 0 0 1 0                   |   |                                 |  |                                 |                              |                                 |                              |                                  |                                  |                                    |                                  |        |
| Orlando Pena, R (8, 1)<br>OBP: 0.167, SLG: 0.196      |   |                                 |                              |                                 |                              |                                 |                              |                                  |                              | 0 0 0 0 0 0 0                   |   |                                 |  |                                 |                              |                                 |                              |                                  |                                  |                                    |                                  |        |
| <b>Inning Stats</b>                                   | R: 0<br>E: 0<br>K: 0<br>S: 3  | H: 0<br>LOB: 1<br>BB: 1<br>P: 7 | R: 0<br>E: 0<br>K: 0<br>S: 2 | H: 0<br>LOB: 0<br>BB: 1<br>P: 6 | R: 0<br>E: 0<br>K: 0<br>S: 3 | H: 0<br>LOB: 0<br>BB: 0<br>P: 3 | R: 1<br>E: 0<br>K: 2<br>S: 9 | H: 2<br>LOB: 2<br>BB: 1<br>P: 13 | R: 0<br>E: 1<br>K: 0<br>S: 3 | H: 0<br>LOB: 0<br>BB: 0<br>P: 3 | R: 0<br>E: 0<br>K: 2<br>S: 8  | H: 1<br>LOB: 1<br>BB: 0<br>P: 8 | R: 0<br>E: 0<br>K: 1<br>S: 5   | H: 0<br>LOB: 0<br>BB: 0<br>P: 5 | R: 0<br>E: 0<br>K: 2<br>S: 7 | H: 0<br>LOB: 0<br>BB: 0<br>P: 7 | R: 0<br>E: 0<br>K: 3<br>S: 9 | H: 0<br>LOB: 1<br>BB: 1<br>P: 13 | 1B: 0<br>2B: 3<br>3B: 0<br>HR: 0 | SF: 0<br>SAC: 0<br>DP: 2<br>HBP: 0 | WP: 1<br>PB: 0<br>SB: 0<br>CS: 0 | PA: 33 |
| <b>PITCHER</b><br>Gary Peters, L (1, 1)<br>ERA: 2.59  | IP: 9.0<br>WLS: W<br>BF: 33<br>H: 3<br>R: 1<br>ER: 1<br>SO: 10<br>BB: 4<br>IBB: 0<br>HBP: 0<br>BLK: 0<br>WP: 1<br>HR: 0<br>S: 49<br>P: 65<br>ERA: 1.00<br>WHIP: 0.778 |                                 |                              |                                 |                              |                                 |                              |                                  |                              |                                 |   | <b>PITCHER</b>                  | IP: WLS: BF: H: R: ER: SO: BB: IBB: HBP: BLK: WP: HR: S: P: ERA: WHIP: |                                 |                              |                                 |                              |                                  |                                  |                                    |                                  |        |

livebaseballscorecards.com

|     |    |
|-----|----|
| AB  | 29 |
| R   | 1  |
| H   | 3  |
| RBI | 1  |
| BB  | 4  |
| SO  | 10 |
| LOB | 9  |



| Batter  | 1                      | 2          | 3         | 4                      | 5          | 6                      | 7                  | 8                     | 9 |
|---|------------------------|------------|-----------|------------------------|------------|------------------------|--------------------|-----------------------|---|
| Tom McCraw, L (1, 7)<br>OBP: 0.356, SLG: 0.435<br>Gene Stephens, L (6, 7)<br>OBP: 0.362, SLG: 0.457 | 0-0<br>6-3             |            | 0-0<br>F7 |                        | 0-0<br>F8  |                        | 0-3<br>K           |                       |   |
| Don Buford, S (1, 4)<br>OBP: 0.327, SLG: 0.341<br>Al Weis, S (9, 4)<br>OBP: 0.312, SLG: 0.342       | 0-0<br>E7<br>3-1<br>1B |            |           | 0-0<br>3-1<br>1B<br>2B |            | 0-0<br>5-3             |                    | 0-0<br>4-3            |   |
| Floyd Robinson, L (1, 9)<br>OBP: 0.371, SLG: 0.442  | 0-0<br>3-1             |            |           | 0-0<br>3-1             |            | 0-0<br>E7<br>SF7<br>2B |                    | 0-0<br>2B<br>2B<br>1B |   |
| Pete Ward, L (1, 5)<br>OBP: 0.343, SLG: 0.460   | 0-0<br>5-3             |            |           | 0-0<br>5-3<br>1B<br>1B |            | 0-0<br>SF7             |                    | 0-0<br>2B<br>2B       |   |
| Bill Skowron, R (1, 3)<br>OBP: 0.316, SLG: 0.473  |                        | 0-0<br>F8  |           | 0-0<br>5-3             |            | 0-0<br>HR              |                    | 4-0<br>2B<br>IBB      |   |
| Jim Landis, R (1, 8)<br>OBP: 0.286, SLG: 0.285  |                        | 0-0<br>5-3 |           | 0-0<br>FC6-4<br>1B     |            | 0-0<br>F9              |                    | 0-3<br>K              |   |
| Ron Hansen, R (1, 6)<br>OBP: 0.351, SLG: 0.382  |                        | 0-3<br>K   |           | 0-0<br>FC6-4<br>1-2f   |            |                        | 4-0<br>SH1-4<br>BB | 0-0<br>2B             |   |
| J.C. Martin, L (1, 2)<br>OBP: 0.253, SLG: 0.316   |                        |            | 0-3<br>K  |                        | 0-0<br>4-3 |                        | 0-0<br>SH1-4       | 0-0<br>F8             |   |
| Gary Peters, L (1, 1)<br>OBP: 0.250, SLG: 0.375   |                        |            | 0-0<br>F4 |                        | 0-3<br>K   |                        | 0-3<br>K           |                       |   |

| AB | R | H | RBI | BB | SO | LOB |
|----|---|---|-----|----|----|-----|
| 3  | 0 | 0 | 0   | 0  | 0  | 0   |
| 1  | 0 | 0 | 0   | 0  | 1  | 1   |
| 4  | 1 | 2 | 0   | 0  | 0  | 0   |
| 0  | 0 | 0 | 0   | 0  | 0  | 0   |
| 4  | 2 | 2 | 0   | 0  | 0  | 2   |
| 3  | 2 | 2 | 2   | 0  | 0  | 1   |
| 3  | 1 | 1 | 1   | 1  | 0  | 1   |
| 4  | 0 | 1 | 1   | 0  | 1  | 3   |
| 3  | 0 | 1 | 2   | 1  | 1  | 1   |
| 3  | 0 | 0 | 0   | 0  | 1  | 2   |
| 3  | 0 | 0 | 0   | 0  | 2  | 1   |

**BOTTOM**

**Kansas City Athletics @ Chicago White Sox**  
Comiskey Park, Chicago, IL

Fri Jul 17 1964, 8:05 PM EDT  
Att. 22,432 - Unknown

|     |    |
|-----|----|
| AB  | 31 |
| R   | 6  |
| H   | 9  |
| RBI | 6  |
| BB  | 2  |
| SO  | 6  |
| LOB | 12 |



| Inning Stats |        | R: 0 | H: 1   | R: 0 | H: 0   | R: 0 | H: 0   | R: 2 | H: 3   | R: 0 | H: 0   | R: 2 | H: 2   | R: 0 | H: 0   | R: 2 | H: 3   |
|--------------|--------|------|--------|------|--------|------|--------|------|--------|------|--------|------|--------|------|--------|------|--------|
| E: 1         | LOB: 1 | E: 0 | LOB: 0 | E: 0 | LOB: 0 | E: 0 | LOB: 1 | E: 1 | LOB: 0 | E: 0 | LOB: 1 | E: 0 | LOB: 1 | E: 0 | LOB: 0 | E: 0 | LOB: 2 |
| K: 0         | BB: 0  | K: 1 | BB: 0  | K: 0 | BB: 0  | K: 0 | BB: 0  | K: 0 | BB: 0  | K: 2 | BB: 1  | K: 1 | BB: 1  | K: 1 | BB: 0  | K: 1 | BB: 1  |
| S: 4         | P: 4   | S: 5 | P: 5   | S: 5 | P: 5   | S: 6 | P: 6   | S: 5 | P: 5   | S: 7 | P: 11  | S: 8 | P: 12  | S: 7 | P: 11  | S: 8 | P: 12  |

| PITCHER                 |           | IP  | WLS | BF | H | R | ER | SO | BB | IBB | HBP | BLK | WP | HR | S  | P  | ERA   | WHIP  |
|-------------------------|-----------|-----|-----|----|---|---|----|----|----|-----|-----|-----|----|----|----|----|-------|-------|
| Moe Drabowsky, R (1, 1) | ERA: 5.72 | 5.1 | L   | 21 | 5 | 3 | 3  | 3  | 0  | 0   | 0   | 0   | 0  | 0  | 27 | 27 | 5.06  | 0.938 |
| Wes Stock, R (6, 1)     | ERA: 2.47 | 1.2 |     | 7  | 1 | 1 | 1  | 2  | 1  | 0   | 0   | 0   | 0  | 1  | 10 | 14 | 5.40  | 1.200 |
| Orlando Pena, R (8, 1)  | ERA: 4.39 | 1.0 |     | 7  | 3 | 2 | 2  | 1  | 0  | 1   | 0   | 0   | 0  | 0  | 8  | 12 | 18.00 | 3.000 |

| WP | PA |
|----|----|
| 0  | 35 |
| 0  |    |
| 0  |    |
| 0  |    |

| Batter  | 1   | 2                               | 3                            | 4                               | 5                            | 6                               | 7                            | 8                               | 9                            | 10                              | 11                           | 12                              | 13                           | AB R H RBI BB SO LOB            | TOP                          |                                 |                              |                                 |                                   |                                    |                                  |        |   |
|---|---|---------------------------------|------------------------------|---------------------------------|------------------------------|---------------------------------|------------------------------|---------------------------------|------------------------------|---------------------------------|------------------------------|---------------------------------|------------------------------|---------------------------------|------------------------------|---------------------------------|------------------------------|---------------------------------|-----------------------------------|------------------------------------|----------------------------------|--------|---|
| Wayne Causey, L (1, 6)<br>OBP: 0.394, SLG: 0.385      | 0-0<br>F8   |                                 | H 1-0<br>HBP                 |                                 |                              | X 0-0<br>F6                     |                              | X 0-0<br>F8                     |                              |                                 | X 0-0<br>F5                  |                                 | X 0-0<br>G3                  | 5 0 0 0 0 0 1                   |                              |                                 |                              |                                 |                                   |                                    |                                  |        |   |
| Ed Charles, R (1, 5)<br>OBP: 0.320, SLG: 0.367        | 0-0<br>5-3  |                                 | X 0-0<br>F2                  |                                 |                              | X 0-0<br>6-3                    |                              | 0-0<br>K                        |                              |                                 | 0-3<br>K                     |                                 | X 0-0<br>K                   | 6 0 1 1 0 2 1                   |                              |                                 |                              |                                 |                                   |                                    |                                  |        |   |
| Ken Harrelson, R (1, 7)<br>OBP: 0.318, SLG: 0.537     | 0-0<br>6-3  |                                 |                              |                                 | X 0-0<br>FC6-4<br>1B         |                                 |                              | X 0-0<br>F7                     |                              | X 0-0<br>1-3                    |                              | X 0-0<br>F8                     | 0-3<br>K                     | 6 0 1 0 0 1 1                   |                              |                                 |                              |                                 |                                   |                                    |                                  |        |   |
| Rocky Colavito, R (1, 9)<br>OBP: 0.369, SLG: 0.534    |   | X 0-0<br>F4                     |                              |                                 | X 0-0<br>F7                  |                                 |                              | X 0-0<br>1B<br>1B               |                              | X 0-0<br>F8                     |                              | X 0-0<br>6-3                    |                              | 5 1 1 0 0 0 1                   |                              |                                 |                              |                                 |                                   |                                    |                                  |        |   |
| Jim Gentile, L (1, 3)<br>OBP: 0.390, SLG: 0.481       |   | X 0-0<br>F9                     |                              |                                 | X 0-0<br>FC6-4               |                                 |                              | X 0-0<br>F8                     |                              | X 0-0<br>F7                     |                              | X 0-0<br>K                      |                              | 5 0 1 0 0 0 2                   |                              |                                 |                              |                                 |                                   |                                    |                                  |        |   |
| Doc Edwards, R (1, 2)<br>OBP: 0.241, SLG: 0.242       |   | X 0-0<br>K                      |                              |                                 | X 0-0<br>F8                  |                                 |                              | X 0-0<br>1B<br>CS<br>1B         |                              | X 0-0<br>K                      |                              | X 0-3<br>K                      |                              | 4 0 3 0 0 0 1                   |                              |                                 |                              |                                 |                                   |                                    |                                  |        |   |
| Dick Green, R (10, PR)<br>OBP: 0.290, SLG: 0.406      |   |                                 |                              |                                 |                              |                                 |                              |                                 |                              |                                 |                              |                                 |                              | 0 0 0 0 0 0 0                   |                              |                                 |                              |                                 |                                   |                                    |                                  |        |   |
| Billy Bryan, L (10, 2)<br>OBP: 0.324, SLG: 0.556      |   |                                 |                              |                                 |                              |                                 |                              |                                 |                              |                                 |                              |                                 |                              | 1 0 0 0 0 1 1                   |                              |                                 |                              |                                 |                                   |                                    |                                  |        |   |
| Nelson Mathews, R (1, 8)<br>OBP: 0.290, SLG: 0.346    |   | 0-3<br>K                        |                              |                                 |                              | X 0-0<br>B1-6-4<br>1B           |                              | X 0-0<br>CS<br>1B               |                              | X 0-0<br>F3                     |                              | X 0-3<br>K                      |                              | 5 0 2 1 0 2 3                   |                              |                                 |                              |                                 |                                   |                                    |                                  |        |   |
| Charlie Shoemaker, L (1, 4)<br>OBP: 0.174, SLG: 0.261 |   |                                 | 0-3<br>K                     |                                 |                              | X 0-0<br>F4                     |                              | X 0-0<br>F6                     |                              | X 0-0<br>3-4                    |                              |                                 | X 0-0<br>G3<br>SH3-4<br>1B   | 5 1 1 0 0 1 4                   |                              |                                 |                              |                                 |                                   |                                    |                                  |        |   |
| Diego Segui, R (1, 1)<br>OBP: 0.180, SLG: 0.229       |   |                                 | 0-3<br>K                     |                                 |                              | X 0-0<br>B1-6-4                 |                              | 0-3<br>K                        |                              | X 0-0<br>F7                     |                              |                                 | X 0-0<br>SH3-4               | 3 0 0 0 0 2 1                   |                              |                                 |                              |                                 |                                   |                                    |                                  |        |   |
| Ted Bowsfield, R (9, 1)                               |   |                                 |                              |                                 |                              |                                 |                              |                                 |                              |                                 |                              |                                 |                              | 0 0 0 0 0 0 0                   |                              |                                 |                              |                                 |                                   |                                    |                                  |        |   |
| George Alusik, R (10, PH)<br>OBP: 0.372, SLG: 0.389   |   |                                 |                              |                                 |                              |                                 |                              |                                 |                              |                                 |                              |                                 |                              | 1 0 0 0 0 0 2                   |                              |                                 |                              |                                 |                                   |                                    |                                  |        |   |
| John Wyatt, R (10, 1)                                 |   |                                 |                              |                                 |                              |                                 |                              |                                 |                              |                                 |                              |                                 |                              | 0 0 0 0 0 0 0                   |                              |                                 |                              |                                 |                                   |                                    |                                  |        |   |
| Wes Stock, R (10, 1)<br>OBP: 0.200, SLG: 0.111        |   |                                 |                              |                                 |                              |                                 |                              |                                 |                              |                                 |                              |                                 |                              | 0 0 0 0 0 0 0                   |                              |                                 |                              |                                 |                                   |                                    |                                  |        |   |
| <b>Inning Stats</b>                                   | R: 0<br>E: 0<br>K: 0<br>S: 3                          | H: 0<br>LOB: 0<br>BB: 0<br>P: 3 | R: 0<br>E: 0<br>K: 1<br>S: 6 | H: 1<br>LOB: 1<br>BB: 0<br>P: 6 | R: 0<br>E: 0<br>K: 2<br>S: 7 | H: 0<br>LOB: 1<br>BB: 0<br>P: 8 | R: 0<br>E: 0<br>K: 0<br>S: 4 | H: 1<br>LOB: 1<br>BB: 0<br>P: 4 | R: 0<br>E: 0<br>K: 0<br>S: 3 | H: 1<br>LOB: 0<br>BB: 0<br>P: 3 | R: 0<br>E: 0<br>K: 0<br>S: 3 | H: 0<br>LOB: 0<br>BB: 0<br>P: 3 | R: 0<br>E: 0<br>K: 1<br>S: 5 | H: 0<br>LOB: 0<br>BB: 0<br>P: 5 | R: 0<br>E: 0<br>K: 2<br>S: 8 | H: 1<br>LOB: 1<br>BB: 0<br>P: 8 | R: 1<br>E: 0<br>K: 1<br>S: 7 | H: 2<br>LOB: 1<br>BB: 0<br>P: 7 | 1B: 10<br>2B: 0<br>3B: 0<br>HR: 0 | SF: 0<br>SAC: 1<br>DP: 1<br>HBP: 1 | WP: 0<br>PB: 0<br>SB: 0<br>CS: 2 | PA: 48 |   |
| <b>PITCHER</b>  | IP WLS BF H R ER SO BB IBB HBP BLK WP HR S P ERA WHIP |                                 |                              |                                 |                              |                                 |                              |                                 |                              |                                 |                              |                                 |                              |                                 |                              |                                 |                              |                                 |                                   |                                    |                                  |        |   |
| Juan Pizarro, L (1, 1)<br>ERA: 2.23                   | 10.0  |                                 |                              |                                 |                              |                                 |                              |                                 |                              |                                 |                              |                                 |                              |                                 |                              |                                 |                              |                                 |                                   |                                    |                                  |        |   |
| Hoyt Wilhelm, R (11, 1)<br>ERA: 2.06                  | 3.0   | W                               | 12                           | 3                               | 1                            | 1                               | 4                            | 0                               | 0                            | 0                               | 0                            | 0                               | 0                            | 0                               | 0                            | 0                               | 0                            | 0                               | 0                                 | 0                                  | 0                                | 0      | 0 |

Kansas City Athletics @ Chicago White Sox  
Comiskey Park, Chicago, IL  
Sun Jul 19 1964, 4:33 AM EDT  
Unknown

|     |    |
|-----|----|
| AB  | 46 |
| R   | 2  |
| H   | 10 |
| RBI | 2  |
| BB  | 0  |
| SO  | 9  |
| LOB | 18 |

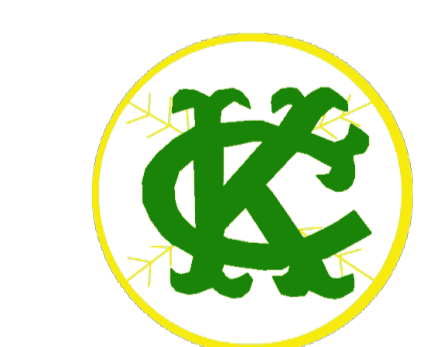

|       |        |
|-------|--------|
| WP: 0 | PA: 48 |
| PB: 0 |        |
| SB: 0 |        |
| CS: 2 |        |

livebaseballscorecards.com



| Batter   | 1                       | 2          | 3          | 4          | 5 | 6                | 7          | 8 | 9                   | 10               | 11               | 12             | 13              |
|--|-------------------------|------------|------------|------------|---|------------------|------------|---|---------------------|------------------|------------------|----------------|-----------------|
| Mike Hershberger, R<br>(1, 9)<br>OBP: 0.323, SLG: 0.325<br>(11, 8)   | 4-0<br>1B BB<br>SF8 BB  |            | 0-3<br>K   |            |   | 0-0<br>F8        |            |   | 4-0<br>SH3-4<br>BB  |                  | 0-0<br>CS<br>1B  |                |                 |
| Don Buford, S<br>(1, 4)<br>OBP: 0.329, SLG: 0.338<br>(13, 5)   | 4-0<br>SF8 1B<br>1-2 BB |            | 0-0<br>F7  |            |   | 4-0<br>F6<br>BB  |            |   | 0-0<br>SH3-4<br>1-2 |                  | 0-0<br>F4<br>1-2 |                |                 |
| Floyd Robinson, L<br>(1, 7)<br>OBP: 0.369, SLG: 0.438<br>(11, 9)   | 0-0<br>1-2 2-3<br>1B    |            | 0-0<br>1-3 |            |   | 0-0<br>F6<br>1-2 |            |   | 0-0<br>6-3          |                  | 0-0<br>6-3       |                |                 |
| Pete Ward, L<br>(1, 5)<br>OBP: 0.337, SLG: 0.451<br>Al Weis, S<br>(13, 4)<br>OBP: 0.312, SLG: 0.342  | 0-3<br>K                |            |            | 0-0<br>F6  |   |                  | 0-0<br>F8  |   | 0-0<br>4-3          |                  |                  | 0-0<br>3-1     |                 |
| Tom McCraw, L<br>(1, 3)<br>OBP: 0.357, SLG: 0.433  | 0-0<br>SF8<br>2-3 3-H   |            |            | 0-0<br>F5  |   |                  | 0-0<br>F1  |   |                     | 1-0<br>WP<br>HBP |                  | 0-0<br>S<br>1B |                 |
| Jim Landis, R<br>(1, 8)<br>OBP: 0.290, SLG: 0.279<br>Gene Stephens, L<br>(10, PH)<br>OBP: 0.350, SLG: 0.438<br>(11, 7)   | 0-0<br>5-3              |            |            | 0-0<br>1-3 |   |                  | 0-0<br>6-3 |   |                     | 0-0<br>F5<br>1-2 |                  | 0-3<br>K       |                 |
| Ron Hansen, R<br>(1, 6)<br>OBP: 0.346, SLG: 0.376  |                         | 0-3<br>K   |            |            |   | 0-0<br>F9        |            |   | 0-0<br>F7           |                  | 0-0<br>F8        |                | 0-0<br>F7       |
| J.C. Martin, L<br>(1, 2)<br>OBP: 0.257, SLG: 0.314<br>Dave Nicholson, R<br>(13, PR)<br>OBP: 0.354, SLG: 0.383  |                         | 0-0<br>1-3 |            |            |   | 0-0<br>F5        |            |   | 0-0<br>F7           |                  | 4-0<br>IBB       |                | 0-0<br>HR<br>1B |
| Juan Pizarro, L<br>(1, 1)<br>OBP: 0.224, SLG: 0.281<br>Bill Skowron, R<br>(10, PH)<br>OBP: 0.315, SLG: 0.471<br>Hoyt Wilhelm, R<br>(11, 1)<br>OBP: 0.273, SLG: 0.200<br>Gary Peters, L<br>(13, PH)<br>OBP: 0.263, SLG: 0.439 |                         | 0-0<br>F7  |            |            |   | 0-3<br>K         |            |   | 0-0<br>2-3          |                  | 0-0<br>6-3       |                | 0-0<br>HR       |

| Inning Stats | R: 1 | H: 1 | E: 0 | LOB: 2 | K: 1 | S: 6 | P: 14 | R: 0 | H: 0 | E: 0 | LOB: 0 | K: 1 | S: 5 | P: 5 | R: 0 | H: 0 | E: 0 | LOB: 0 | K: 1 | S: 5 | P: 5 | R: 0 | H: 0 | E: 0 | LOB: 0 | K: 1 | S: 5 | P: 5 | R: 0 | H: 0 | E: 0 | LOB: 0 | K: 0 | S: 3 | P: 3 | R: 0 | H: 0 | E: 0 | LOB: 0 | K: 0 | S: 2 | P: 6 | R: 0 | H: 0 | E: 0 | LOB: 0 | K: 0 | S: 3 | P: 3 | R: 0 | H: 0 | E: 0 | LOB: 0 | K: 0 | S: 3 | P: 3 | R: 0 | H: 0 | E: 0 | LOB: 1 | K: 0 | S: 3 | P: 7 | R: 0 | H: 1 | E: 0 | LOB: 0 | K: 0 | S: 3 | P: 3 | R: 0 | H: 1 | E: 0 | LOB: 1 | K: 1 | S: 6 | P: 6 | R: 2 | H: 2 | E: 0 | LOB: 1 | K: 0 | S: 2 | P: 2 | 1B: 4 | SF: 1 | 2B: 0 | SAC: 1 | 3B: 0 | DP: 0 | HR: 1 | HBP: 1 | WP: 1 | PA: 45 |
|--------------|------|------|------|--------|------|------|-------|------|------|------|--------|------|------|------|------|------|------|--------|------|------|------|------|------|------|--------|------|------|------|------|------|------|--------|------|------|------|------|------|------|--------|------|------|------|------|------|------|--------|------|------|------|------|------|------|--------|------|------|------|------|------|------|--------|------|------|------|------|------|------|--------|------|------|------|------|------|------|--------|------|------|------|------|------|------|--------|------|------|------|-------|-------|-------|--------|-------|-------|-------|--------|-------|--------|
|--------------|------|------|------|--------|------|------|-------|------|------|------|--------|------|------|------|------|------|------|--------|------|------|------|------|------|------|--------|------|------|------|------|------|------|--------|------|------|------|------|------|------|--------|------|------|------|------|------|------|--------|------|------|------|------|------|------|--------|------|------|------|------|------|------|--------|------|------|------|------|------|------|--------|------|------|------|------|------|------|--------|------|------|------|------|------|------|--------|------|------|------|-------|-------|-------|--------|-------|-------|-------|--------|-------|--------|

| PITCHER                      | IP      | WLS | BF   | H | R | ER | SO | BB | IBB | HBP | BLK | WP | HR | S  | P  | ERA  | WHIP  |
|------------------------------|---------|-----|------|---|---|----|----|----|-----|-----|-----|----|----|----|----|------|-------|
| Diego Segui, R<br>ERA: 3.91  | (1, 1)  | 8.0 | 28   | 1 | 1 | 1  | 4  | 4  | 0   | 0   | 0   | 0  | 0  | 32 | 48 | 1.12 | 0.625 |
| Ted Bowsfield, L<br>ERA: 4.5 | (9, 1)  | 1.0 | 3    | 0 | 0 | 0  | 0  | 0  | 0   | 0   | 0   | 0  | 0  | 3  | 3  | 0.00 | 0.000 |
| John Wyatt, R<br>ERA: 3.84   | (10, 1) | 0.0 | 1    | 0 | 0 | 0  | 0  | 0  | 0   | 1   | 0   | 0  | 0  | 1  | ∞  | ∞    |       |
| Wes Stock, R<br>ERA: 2.65    | (10, 1) | 3.0 | L 13 | 4 | 2 | 2  | 1  | 0  | 1   | 0   | 0   | 1  | 1  | 14 | 18 | 6.00 | 1.333 |

**BOTTOM**

**Kansas City Athletics @ Chicago White Sox**  
Comiskey Park, Chicago, IL

Sun Jul 19 1964, 4:33 AM EDT  
Unknown

|     |   |   |   |   |   |   |   |   |   |   |   |   |   |
|-----|---|---|---|---|---|---|---|---|---|---|---|---|---|
| AB  | 3 | 2 | 5 | 5 | 3 | 0 | 3 | 5 | 4 | 0 | 3 | 1 | 0 |
| R   | 1 | 0 | 0 | 0 | 0 | 0 | 0 | 0 | 0 | 0 | 0 | 0 | 0 |
| H   | 1 | 0 | 1 | 1 | 0 | 0 | 0 | 0 | 0 | 0 | 0 | 0 | 0 |
| RBI | 1 | 0 | 1 | 1 | 0 | 0 | 0 | 0 | 0 | 0 | 0 | 0 | 0 |
| BB  | 0 | 0 | 0 | 0 | 0 | 0 | 0 | 0 | 0 | 0 | 0 | 0 | 0 |
| SO  | 2 | 0 | 0 | 0 | 0 | 0 | 0 | 0 | 0 | 0 | 0 | 0 | 0 |
| LOB | 1 | 0 | 0 | 0 | 0 | 0 | 0 | 0 | 0 | 0 | 0 | 0 | 0 |

livebaseballscorecards.com

|     |    |
|-----|----|
| AB  | 37 |
| R   | 3  |
| H   | 5  |
| RBI | 3  |
| BB  | 5  |
| SO  | 5  |
| LOB | 15 |



| Batter  | 1   | 2                                | 3                            | 4                               | 5                            | 6                               | 7                            | 8                               | 9                            | AB R H RBI BB SO LOB   | TOP   |                                 |                              |                                 |                              |                                 |                              |                                 |                                  |                                    |                                  |        |
|---|---|----------------------------------|------------------------------|---------------------------------|------------------------------|---------------------------------|------------------------------|---------------------------------|------------------------------|--|---|---------------------------------|------------------------------|---------------------------------|------------------------------|---------------------------------|------------------------------|---------------------------------|----------------------------------|------------------------------------|----------------------------------|--------|
| Jose Tartabull, L (1, 8)<br>OBP: 0.271, SLG: 0.277    | 0-0<br>1-3<br>1B                                      |                                  | 0-0<br>1-3<br>1B             |                                 |                              | 0-0<br>F8                       |                              | 0-0<br>6-3                      |                              | 4 0 2 0 0 0 0  | <b>Kansas City Athletics @ Chicago White Sox</b><br>Comiskey Park, Chicago, IL<br>Sun Jul 19 1964, 4:38 AM EDT<br>Att: 18,664 - Unknown<br><a href="http://livebaseballscorecards.com">livebaseballscorecards.com</a> |                                 |                              |                                 |                              |                                 |                              |                                 |                                  |                                    |                                  |        |
| Wayne Causey, L (1, 6)<br>OBP: 0.393, SLG: 0.384      | 0-0<br>1-3<br>1-2                                     |                                  | 0-0<br>1-3                   |                                 |                              | 0-0<br>1-3                      |                              |                                 | 0-0<br>HR<br>1B              | 4 1 1 0 0 0 1  |   |                                 |                              |                                 |                              |                                 |                              |                                 |                                  |                                    |                                  |        |
| Jim Gentile, L (1, 3)<br>OBP: 0.382, SLG: 0.493       | 4-0<br>BB   |                                  |                              |                                 | 0-0<br>F7                    |                                 | 0-0<br>F7                    |                                 | 0-0<br>1-H<br>HR             | 3 1 1 2 1 0 0  |   |                                 |                              |                                 |                              |                                 |                              |                                 |                                  |                                    |                                  |        |
| Rocky Colavito, R (1, 9)<br>OBP: 0.368, SLG: 0.540    | 0-0<br>F2   |                                  |                              |                                 | 0-0<br>F6                    |                                 |                              |                                 | 0-0<br>6-3                   | 4 1 1 1 0 0 2  |   |                                 |                              |                                 |                              |                                 |                              |                                 |                                  |                                    |                                  |        |
| Ken Harrelson, R (1, 7)<br>OBP: 0.313, SLG: 0.511     | 0-3<br>K  |                                  |                              |                                 | 0-0<br>F4                    |                                 | 0-0<br>F2                    |                                 | 0-0<br>1B<br>1B              | 4 0 1 0 0 1 2  |   |                                 |                              |                                 |                              |                                 |                              |                                 |                                  |                                    |                                  |        |
| Billy Bryan, L (1, 2)<br>OBP: 0.317, SLG: 0.543       |   | 0-3<br>K2-3                      |                              |                                 | 0-0<br>6-3                   |                                 | 0-3<br>K                     |                                 | 0-0<br>1-2<br>G6-4-3<br>1B   | 3 0 0 0 0 2 0<br>1 0 1 0 0 0 0                                   |   |                                 |                              |                                 |                              |                                 |                              |                                 |                                  |                                    |                                  |        |
| Doc Edwards, R (9, PH)<br>OBP: 0.245, SLG: 0.247      |   |                                  |                              |                                 |                              |                                 |                              |                                 |                              |  |   |                                 |                              |                                 |                              |                                 |                              |                                 |                                  |                                    |                                  |        |
| Ed Charles, R (1, 5)<br>OBP: 0.317, SLG: 0.362        |   |                                  |                              |                                 | 0-0<br>F8                    |                                 | 0-0<br>F8                    |                                 | 0-0<br>G6-4-3<br>1-2         | 4 0 0 0 0 0 2  |   |                                 |                              |                                 |                              |                                 |                              |                                 |                                  |                                    |                                  |        |
| Charlie Shoemaker, L (1, 4)<br>OBP: 0.192, SLG: 0.269 |   |                                  |                              |                                 | 0-0<br>F6                    |                                 |                              |                                 | 0-0<br>4-3                   | 3 0 1 0 0 0 0  |   |                                 |                              |                                 |                              |                                 |                              |                                 |                                  |                                    |                                  |        |
| John O'Donoghue, R (1, 1)<br>OBP: 0.242, SLG: 0.333   |   |                                  | 0-3<br>K                     |                                 | 0-0<br>1B                    |                                 |                              |                                 |                              |  |   |                                 |                              |                                 |                              |                                 |                              |                                 |                                  |                                    |                                  |        |
| Dan Pfister, R (4, 1)                                 |   |                                  |                              |                                 | 0-0<br>1-3                   |                                 |                              |                                 | 0-3<br>K                     | 1 0 0 0 0 1 0<br>1 0 0 0 0 0 1<br>1 0 0 0 0 1 0<br>0 0 0 0 0 0 0 |   |                                 |                              |                                 |                              |                                 |                              |                                 |                                  |                                    |                                  |        |
| George Alusik, R (8, PH)<br>OBP: 0.371, SLG: 0.387    |   |                                  |                              |                                 |                              |                                 |                              |                                 |                              |  |   |                                 |                              |                                 |                              |                                 |                              |                                 |                                  |                                    |                                  |        |
| Moe Drabowsky, R (8, 1)<br>OBP: 0.031, SLG: 0.031     |   |                                  |                              |                                 |                              |                                 |                              |                                 |                              |  |   |                                 |                              |                                 |                              |                                 |                              |                                 |                                  |                                    |                                  |        |
| <b>Inning Stats</b>                                   | R: 0<br>E: 0<br>K: 1<br>S: 6                          | H: 1<br>LOB: 2<br>BB: 1<br>P: 10 | R: 0<br>E: 0<br>K: 1<br>S: 5 | H: 0<br>LOB: 0<br>BB: 0<br>P: 5 | R: 0<br>E: 0<br>K: 1<br>S: 5 | H: 1<br>LOB: 0<br>BB: 0<br>P: 5 | R: 0<br>E: 0<br>K: 0<br>S: 3 | H: 0<br>LOB: 0<br>BB: 0<br>P: 3 | R: 0<br>E: 0<br>K: 0<br>S: 4 | H: 1<br>LOB: 1<br>BB: 0<br>P: 4                                  | R: 0<br>E: 0<br>K: 0<br>S: 3  | H: 0<br>LOB: 0<br>BB: 0<br>P: 3 | R: 1<br>E: 0<br>K: 1<br>S: 6 | H: 1<br>LOB: 0<br>BB: 0<br>P: 6 | R: 0<br>E: 0<br>K: 1<br>S: 5 | H: 0<br>LOB: 0<br>BB: 0<br>P: 5 | R: 2<br>E: 0<br>K: 0<br>S: 6 | H: 4<br>LOB: 1<br>BB: 0<br>P: 6 | 1B: 6<br>2B: 0<br>3B: 0<br>HR: 2 | SF: 0<br>SAC: 0<br>DP: 1<br>HBP: 0 | WP: 0<br>PB: 0<br>SB: 0<br>CS: 0 | PA: 34 |
| <b>PITCHER</b>  | IP WLS BF H R ER SO BB IBB HBP BLK WP HR S P ERA WHIP |                                  |                              |                                 |                              |                                 |                              |                                 |                              |  |   |                                 |                              |                                 |                              |                                 |                              |                                 |                                  |                                    |                                  |        |
| Ray Herbert, R (1, 1)<br>ERA: 3.86                    | 8.0 W 30 6 3 3 5 1 0 0 0 0 2 39 43 3.38 0.875         |                                  |                              |                                 |                              |                                 |                              |                                 |                              |  |   |                                 |                              |                                 |                              |                                 |                              |                                 |                                  |                                    |                                  |        |
| Hoyt Wilhelm, R (9, 1)<br>ERA: 2.05                   | 0.1 2 1 0 0 0 0 0 0 0 0 0 0 2 2 0.00 3.000            |                                  |                              |                                 |                              |                                 |                              |                                 |                              |  |   |                                 |                              |                                 |                              |                                 |                              |                                 |                                  |                                    |                                  |        |
| Don Mossi, L (9, 1)<br>ERA: 2.67                      | 0.0 1 1 0 0 0 0 0 0 0 0 0 0 1 1 ∞ ∞                   |                                  |                              |                                 |                              |                                 |                              |                                 |                              |  |   |                                 |                              |                                 |                              |                                 |                              |                                 |                                  |                                    |                                  |        |
| Eddie Fisher, R (9, 1)<br>ERA: 3.92                   | 0.2 S 1 0 0 0 0 0 0 0 0 0 0 0 1 1 0.00 0.000          |                                  |                              |                                 |                              |                                 |                              |                                 |                              |  |   |                                 |                              |                                 |                              |                                 |                              |                                 |                                  |                                    |                                  |        |



| Batter   | 1                   | 2                       | 3          | 4                    | 5                  | 6                | 7          | 8                   | 9 | AB | R | H | RBI | BB | SO | LOB |
|--|---------------------|-------------------------|------------|----------------------|--------------------|------------------|------------|---------------------|---|----|---|---|-----|----|----|-----|
| Don Buford, S<br>OBP: 0.332, SLG: 0.342 (1, 5)       | 0-0<br>6-3 WP<br>2B |                         | 0-0<br>F9  | 0-0<br>4-3           |                    | 1-0<br>1B<br>HBP |            |                     |   | 3  | 1 | 1 | 0   | 0  | 0  | 1   |
| Al Weis, S<br>OBP: 0.315, SLG: 0.345 (1, 4)          | 0-0<br>6-3<br>2-3   |                         | 0-0<br>6-3 |                      | 0-0<br>F8 1B<br>1B | 0-0<br>1B<br>1-3 |            |                     |   | 4  | 0 | 2 | 0   | 0  | 0  | 1   |
| Jim Landis, R<br>OBP: 0.286, SLG: 0.280 (1, 8)       | 0-0<br>F9<br>3-H    |                         | 4-0<br>BB  |                      | 0-0<br>1B<br>1-2   |                  | 0-0<br>6-3 |                     |   | 3  | 0 | 1 | 0   | 1  | 0  | 0   |
| Bill Skowron, R<br>OBP: 0.311, SLG: 0.464 (1, 3)     | 0-0<br>F9           |                         | 0-0<br>F9  |                      | 0-0<br>F8<br>2-3   |                  | 0-0<br>E5  |                     |   | 4  | 0 | 0 | 0   | 0  | 0  | 3   |
| Mike Hershberger, R<br>OBP: 0.322, SLG: 0.321 (1, 9) |                     | 4-0<br>BB<br>BB<br>BB   |            | 0-0<br>E5<br>HR      | 0-0<br>F5          |                  | 0-0<br>F7  |                     |   | 3  | 1 | 0 | 0   | 1  | 0  | 2   |
| Dave Nicholson, R<br>OBP: 0.356, SLG: 0.397 (1, 7)   |                     | 0-0                     |            | 0-0<br>HR            | 0-3<br>K           |                  | 0-3<br>K   |                     |   | 4  | 1 | 2 | 2   | 0  | 2  | 2   |
| Gene Stephens, L<br>OBP: 0.350, SLG: 0.438 (9, 7)    |                     | 0-0<br>L5-4<br>1B       |            | 0-0<br>HR            |                    |                  |            |                     |   | 0  | 0 | 0 | 0   | 0  | 0  | 0   |
| Ron Hansen, R<br>OBP: 0.351, SLG: 0.389 (1, 6)       |                     | 0-0<br>E6<br>1-2<br>2-3 |            | 4-0<br>FC1-6<br>BB   |                    | 0-0<br>HR        |            | 0-0<br>G6-4-3<br>1B |   | 3  | 1 | 2 | 1   | 1  | 0  | 2   |
| Jerry McNertney, R<br>OBP: 0.288, SLG: 0.286 (1, 2)  |                     | 0-0<br>F9               |            | 0-0<br>FC1-6<br>1-2f |                    | 0-0<br>F9        |            | 0-0<br>G6-4-3       |   | 4  | 0 | 0 | 0   | 0  | 0  | 5   |
| Don Mossi, L (9, 1)                                  |                     |                         |            |                      |                    |                  |            |                     |   | 0  | 0 | 0 | 0   | 0  | 0  | 0   |
| Eddie Fisher, R<br>OBP: 0.083, SLG: 0.083 (9, 1)     |                     |                         |            |                      |                    |                  |            |                     |   | 0  | 0 | 0 | 0   | 0  | 0  | 0   |
| Ray Herbert, R<br>OBP: 0.118, SLG: 0.125 (1, 1)      |                     | 0-0<br>L5-4             |            | 0-0<br>F2            |                    | 0-0<br>F8        |            |                     |   | 3  | 0 | 0 | 0   | 0  | 0  | 4   |
| Hoyt Wilhelm, R<br>OBP: 0.273, SLG: 0.200 (9, 1)     |                     |                         |            |                      |                    |                  |            |                     |   | 0  | 0 | 0 | 0   | 0  | 0  | 0   |
| J.C. Martin, L<br>OBP: 0.257, SLG: 0.314 (9, 2)      |                     |                         |            |                      |                    |                  |            |                     |   | 0  | 0 | 0 | 0   | 0  | 0  | 0   |

| Inning Stats | R: 1 | H: 1  | E: 0 | LOB: 0 | K: 0 | P: 4  | R: 0 | H: 1  | E: 1 | LOB: 2 | K: 0 | P: 8  | R: 0 | H: 0  | E: 0 | LOB: 1 | K: 0 | P: 7  | R: 2 | H: 1  | E: 1 | LOB: 1 | K: 0 | P: 9  | R: 0 | H: 2  | E: 0 | LOB: 2 | K: 1 | P: 7  | R: 1 | H: 2  | E: 0 | LOB: 2 | K: 0 | P: 5  | R: 0 | H: 0  | E: 1 | LOB: 0 | K: 0 | P: 3  | R: 0 | H: 1  | E: 0 | LOB: 0 | K: 1 | P: 5 |
|--------------|------|-------|------|--------|------|-------|------|-------|------|--------|------|-------|------|-------|------|--------|------|-------|------|-------|------|--------|------|-------|------|-------|------|--------|------|-------|------|-------|------|--------|------|-------|------|-------|------|--------|------|-------|------|-------|------|--------|------|------|
|              | S: 4 | BB: 0 | S: 4 | BB: 1  | S: 4 | BB: 8 | S: 3 | BB: 1 | S: 5 | BB: 9  | S: 7 | BB: 0 | S: 4 | BB: 0 | S: 3 | BB: 0  | S: 5 | BB: 5 | S: 4 | BB: 0 | S: 3 | BB: 0  | S: 5 | BB: 5 | S: 4 | BB: 0 | S: 3 | BB: 0  | S: 5 | BB: 0 | S: 5 | BB: 5 | S: 4 | BB: 0  | S: 3 | BB: 0 | S: 5 | BB: 0 | S: 5 | BB: 5  | S: 4 | BB: 0 | S: 3 | BB: 0 | S: 5 | BB: 5  |      |      |

| PITCHER                                | IP  | WLS | BF | H | R | ER | SO | BB | IBB | HBP | BLK | WP | HR | S  | P  | ERA  | WHIP  |
|--|-----|-----|----|---|---|----|----|----|-----|-----|-----|----|----|----|----|------|-------|
| John O'Donoghue, L<br>ERA: 4.73 (1, 1) | 3.0 | L   | 16 | 3 | 3 | 2  | 0  | 3  | 0   | 0   | 0   | 1  | 1  | 13 | 25 | 6.00 | 2.000 |
| Dan Pfister, R<br>ERA: 6.81 (4, 1)     | 4.0 |     | 16 | 4 | 1 | 1  | 1  | 0  | 0   | 1   | 0   | 0  | 1  | 17 | 18 | 2.25 | 1.000 |
| Moe Drabowsky, R<br>ERA: 5.67 (8, 1)   | 1.0 |     | 3  | 1 | 0 | 0  | 1  | 0  | 0   | 0   | 0   | 0  | 0  | 5  | 5  | 0.00 | 1.000 |

**BOTTOM**

**Kansas City Athletics @ Chicago White Sox**  
Comiskey Park, Chicago, IL

Sun Jul 19 1964, 4:38 AM EDT  
Att. 18,664 - Unknown

| AB | R | H | RBI | BB | SO | LOB |
|----|---|---|-----|----|----|-----|
| 31 | 4 | 8 | 3   | 3  | 2  | 20  |

livebaseballscorecards.com



| WP | HR | S  | P  | ERA  | WHIP  |
|----|----|----|----|------|-------|
| 1  | 1  | 13 | 25 | 6.00 | 2.000 |

| Batter  | 1   | 2                               | 3                            | 4                               | 5   | 6   | 7   | 8                               | 9                                | AB R H RBI BB SO LOB  | TOP                          |                                 |                              |                                  |                              |                                 |                              |                                 |                                  |                                    |                                  |        |
|---|---|---------------------------------|------------------------------|---------------------------------|---|---|---|---------------------------------|----------------------------------|---|------------------------------|---------------------------------|------------------------------|----------------------------------|------------------------------|---------------------------------|------------------------------|---------------------------------|----------------------------------|------------------------------------|----------------------------------|--------|
| Jose Tartabull, L<br>OBP: 0.283, SLG: 0.275<br>(1, 8)<br>(7, 7)   | 0-0<br>F4   |                                 | 0-0<br>1B<br>1B              |                                 | 0-0<br>L1   |   | 0-0<br>1B<br>2B<br>BB   |                                 | 0-0<br>F7                        | 4 2 1 0 1 0 0   |                              |                                 |                              |                                  |                              |                                 |                              |                                 |                                  |                                    |                                  |        |
| Wayne Causey, L<br>OBP: 0.395, SLG: 0.395<br>(1, 6)   | 0-0<br>HR   |                                 | 0-0<br>1B<br>1B              |                                 | 0-0<br>F4   |   | 0-0<br>2B<br>1B   |                                 | 0-0<br>4-3                       | 5 1 3 1 0 0 0   |                              |                                 |                              |                                  |                              |                                 |                              |                                 |                                  |                                    |                                  |        |
| Rocky Colavito, R<br>OBP: 0.371, SLG: 0.544<br>(1, 9)   | 0-0<br>5-3  |                                 | 0-0<br>1B<br>1-2<br>3-H      |                                 | 0-0<br>F7   |   | 0-0<br>2B   |                                 | 0-0<br>1B<br>1B                  | 5 0 3 3 0 0 0   |                              |                                 |                              |                                  |                              |                                 |                              |                                 |                                  |                                    |                                  |        |
| Jim Gentile, L<br>OBP: 0.386, SLG: 0.498<br>(1, 3)  | 0-0<br>2B   |                                 | 0-3<br>K                     |                                 | 0-3<br>K  |   | 4-0<br>BB<br>IBB  |                                 | 0-0<br>1B                        | 4 0 2 0 1 2 2   |                              |                                 |                              |                                  |                              |                                 |                              |                                 |                                  |                                    |                                  |        |
| Ken Harrelson, R<br>OBP: 0.327, SLG: 0.500<br>Nelson Mathews, R<br>OBP: 0.290, SLG: 0.345<br>(1, 7)<br>(7, 8)                             | 0-0<br>F7   |                                 | 0-0<br>F5                    |                                 | 0-0<br>2B<br>1B   |   | 4-0<br>1B<br>BB   |                                 | 0-0<br>F3                        | 3 1 1 0 1 0 3<br>1 0 0 0 0 0 2  |                              |                                 |                              |                                  |                              |                                 |                              |                                 |                                  |                                    |                                  |        |
| Billy Bryan, L<br>OBP: 0.317, SLG: 0.545<br>Doc Edwards, R<br>OBP: 0.244, SLG: 0.245<br>(1, 2)<br>(7, PH)<br>(7, 2)                       |   | 0-3<br>K                        |                              | 0-0<br>F4                       |   | 0-0<br>2B   | 0-3<br>K  |                                 |                                  | 3 0 1 1 0 1 0<br>1 0 0 0 0 1 3  |                              |                                 |                              |                                  |                              |                                 |                              |                                 |                                  |                                    |                                  |        |
| Ed Charles, R<br>OBP: 0.314, SLG: 0.358<br>(1, 5)   |   | 0-0<br>F4                       |                              | 0-0<br>6-3                      |   | 0-0<br>F8   |   | 0-3<br>K                        |                                  | 4 0 0 0 0 1 1   |                              |                                 |                              |                                  |                              |                                 |                              |                                 |                                  |                                    |                                  |        |
| Charlie Shoemaker, L<br>OBP: 0.200, SLG: 0.267<br>(1, 4)  |   | 0-0<br>4-3                      |                              | 0-0<br>1-3                      |   |   | 0-0<br>1B<br>2B<br>5-3<br>1B  |                                 | 0-3<br>K                         | 4 1 1 0 0 1 0   |                              |                                 |                              |                                  |                              |                                 |                              |                                 |                                  |                                    |                                  |        |
| Jose Santiago, R<br>Moe Drabowsky, R<br>Dan Pfister, R<br>Wes Stock, R<br>John Wyatt, R<br>(1, 1)<br>(1, 1)<br>(5, 1)<br>(5, 1)<br>(9, 1) |   |                                 | 0-0<br>F7                    |                                 | 0-3<br>K  |   |   | 0-3<br>K                        |                                  | 0 0 0 0 0 0 0<br>2 0 0 0 0 1 0<br>0 0 0 0 0 0 0<br>2 0 0 0 0 1 1<br>0 0 0 0 0 0 0 |                              |                                 |                              |                                  |                              |                                 |                              |                                 |                                  |                                    |                                  |        |
| <b>Inning Stats</b>   | R: 1<br>E: 0<br>K: 0<br>S: 5                          | H: 2<br>LOB: 1<br>BB: 0<br>P: 5 | R: 0<br>E: 0<br>K: 1<br>S: 5 | H: 0<br>LOB: 0<br>BB: 0<br>P: 5 | R: 1<br>E: 0<br>K: 1<br>S: 8  | H: 3<br>LOB: 2<br>BB: 0<br>P: 8   | R: 0<br>E: 0<br>K: 0<br>S: 3  | H: 0<br>LOB: 0<br>BB: 0<br>P: 3 | R: 0<br>E: 0<br>K: 1<br>S: 5     | H: 0<br>LOB: 0<br>BB: 0<br>P: 5   | R: 1<br>E: 0<br>K: 1<br>S: 7 | H: 2<br>LOB: 1<br>BB: 0<br>P: 7 | R: 2<br>E: 0<br>K: 1<br>S: 7 | H: 3<br>LOB: 3<br>BB: 3<br>P: 19 | R: 0<br>E: 0<br>K: 3<br>S: 9 | H: 0<br>LOB: 0<br>BB: 0<br>P: 9 | R: 0<br>E: 0<br>K: 0<br>S: 5 | H: 2<br>LOB: 2<br>BB: 0<br>P: 5 | 1B: 8<br>2B: 3<br>3B: 0<br>HR: 1 | SF: 0<br>SAC: 0<br>DP: 0<br>HBP: 0 | WP: 0<br>PB: 0<br>SB: 0<br>CS: 0 | PA: 41 |
| <b>PITCHER</b>  | IP WLS BF H R ER SO BB IBB HBP BLK WP HR S P ERA WHIP |                                 |                              |                                 |   |   |   |                                 |                                  |   |                              |                                 |                              |                                  |                              |                                 |                              |                                 |                                  |                                    |                                  |        |
| Camilo Pascual, R<br>ERA: 3.75<br>Johnny Klippstein, R<br>ERA: 2.82<br>Gerry Arrigo, L<br>ERA: 4.13<br>Al Worthington, R<br>ERA: 2.96     | (1, 1)<br>(7, 1)<br>(7, 1)<br>(8, 1)                  | 6.1<br>0.1<br>0.1<br>2.0        | L<br>3<br>1<br>8             | 29<br>1<br>0<br>8               | H: 9<br>R: 5<br>ER: 5<br>SO: 4<br>BB: 1<br>IBB: 0<br>HBP: 0<br>BLK: 0<br>WP: 0<br>HR: 1<br>S: 36<br>P: 40 | H: 1<br>R: 0<br>ER: 0<br>SO: 0<br>BB: 1<br>IBB: 1<br>HBP: 0<br>BLK: 0<br>WP: 0<br>HR: 0<br>S: 9<br>P: 9 | H: 0<br>R: 0<br>ER: 0<br>SO: 3<br>BB: 0<br>HBP: 0<br>BLK: 0<br>WP: 0<br>HR: 0<br>S: 14<br>P: 14 | 7.11<br>0.00<br>0.00<br>0.00    | 1.579<br>6.000<br>0.000<br>1.000 |   |                              |                                 |                              |                                  |                              |                                 |                              |                                 |                                  |                                    |                                  |        |

**Kansas City Athletics @ Minnesota Twins**  
 Metropolitan Stadium, Bloomington, MI  
 Tue Jul 21 1964, 8:05 PM EDT  
 Att. 10,269 - Unknown

|     |    |
|-----|----|
| AB  | 38 |
| R   | 5  |
| H   | 12 |
| RBI | 5  |
| BB  | 3  |
| SO  | 8  |
| LOB | 12 |



|       |        |
|-------|--------|
| WP: 0 | PA: 41 |
| PB: 0 |        |
| SB: 0 |        |
| CS: 0 |        |

BOTTOM

Kansas City Athletics @ Minnesota Twins  
Metropolitan Stadium, Bloomington, MI

Tue Jul 21 1964, 8:05 PM EDT  
Att. 10,269 - Unknown

livebaseballscorecards.com

|     |    |
|-----|----|
| AB  | 34 |
| R   | 4  |
| H   | 8  |
| RBI | 4  |
| BB  | 9  |
| SO  | 8  |
| LOB | 26 |



| AB | R | H | RBI | BB | SO | LOB |
|----|---|---|-----|----|----|-----|
| 5  | 0 | 0 | 0   | 0  | 0  | 4   |
| 4  | 1 | 1 | 0   | 1  | 1  | 0   |
| 5  | 1 | 2 | 0   | 0  | 1  | 1   |
| 3  | 2 | 1 | 0   | 2  | 1  | 0   |
| 3  | 0 | 2 | 2   | 2  | 1  | 2   |
| 5  | 0 | 1 | 1   | 0  | 0  | 6   |
| 2  | 0 | 1 | 0   | 2  | 0  | 2   |
| 0  | 0 | 0 | 0   | 0  | 0  | 0   |
| 1  | 0 | 0 | 0   | 0  | 0  | 1   |
| 2  | 0 | 0 | 0   | 0  | 2  | 5   |
| 0  | 0 | 0 | 0   | 1  | 0  | 0   |
| 1  | 0 | 0 | 0   | 0  | 1  | 1   |
| 2  | 0 | 0 | 1   | 1  | 1  | 3   |
| 0  | 0 | 0 | 0   | 0  | 0  | 0   |
| 0  | 0 | 0 | 0   | 0  | 0  | 0   |
| 1  | 0 | 0 | 0   | 0  | 0  | 1   |
| 0  | 0 | 0 | 0   | 0  | 0  | 0   |

|     |   |     |    |
|-----|---|-----|----|
| WP: | 0 | PA: | 43 |
| PB: | 0 |     |    |
| SB: | 1 |     |    |
| CS: | 0 |     |    |

| PITCHER          | IP     | WLS | BF | H | R | ER | SO | BB | IBB | HBP | BLK | WP | HR | S  | P  | ERA   | WHIP   |
|------------------|--------|-----|----|---|---|----|----|----|-----|-----|-----|----|----|----|----|-------|--------|
| Jose Santiago, R | (1, 1) |     | 7  | 4 | 3 | 3  | 0  | 2  | 0   | 0   | 0   | 0  | 0  | 5  | 13 | 81.00 | 18.000 |
| Moe Drabowsky, R | (1, 1) |     | 16 | 2 | 1 | 1  | 5  | 3  | 0   | 0   | 0   | 0  | 0  | 23 | 35 | 2.46  | 1.364  |
| Dan Pfister, R   | (5, 1) |     | 4  | 0 | 0 | 0  | 0  | 1  | 1   | 0   | 0   | 0  | 0  | 2  | 10 | 0.00  | 1.500  |
| Wes Stock, R     | (5, 1) | W   | 14 | 2 | 0 | 0  | 3  | 2  | 0   | 0   | 0   | 0  | 0  | 18 | 26 | 0.00  | 1.200  |
| John Wyatt, R    | (9, 1) | S   | 2  | 0 | 0 | 0  | 0  | 0  | 0   | 0   | 0   | 0  | 0  | 2  | 2  | 0.00  | 0.000  |

| Batter   | 1          | 2         | 3         | 4          | 5          | 6         | 7         | 8         | 9             |
|--|------------|-----------|-----------|------------|------------|-----------|-----------|-----------|---------------|
| Zoilo Versalles, R<br>OBP: 0.313, SLG: 0.423<br>(1, 6)   | 0-0<br>1-3 | 0-0<br>F7 |           | 0-0<br>5-3 | 0-0<br>F5  |           | 0-0<br>F7 |           |               |
| Rich Rollins, R<br>OBP: 0.343, SLG: 0.426<br>(1, 5)  | 0-0<br>1B  | 0-3<br>K  |           | 4-0<br>BB  |            | 0-0<br>F8 |           | 0-0<br>F8 |               |
| Tony Oliva, L<br>OBP: 0.369, SLG: 0.575<br>(1, 9)  | 0-0<br>1B  | 0-0<br>F7 |           | 0-0<br>F8  |            | 0-0<br>BB |           | 0-3<br>K  |               |
| Harmon Killebrew, R<br>OBP: 0.381, SLG: 0.599<br>(1, 7)  | 4-0<br>1B  |           | 0-3<br>K  |            | 0-0<br>6-3 | 4-0<br>1B |           | 0-0<br>F3 |               |
| Jimmie Hall, L<br>OBP: 0.313, SLG: 0.476<br>(1, 8)   | 0-0<br>1B  |           | 4-0<br>BB |            | 0-0<br>BB  | 0-3<br>K  |           | 4-0<br>BB |               |
| Bob Allison, R<br>OBP: 0.419, SLG: 0.615<br>(1, 3)   | 0-0<br>1B  |           | 0-0<br>F4 |            | 0-0<br>6-3 | 0-0<br>F6 |           | 0-0<br>F9 |               |
| Earl Battey, R<br>OBP: 0.351, SLG: 0.430<br>Jim Kaat, L<br>OBP: 0.302, SLG: 0.326<br>Jerry Zimmerman, R<br>OBP: 0.297, SLG: 0.254<br>(1, 2)<br>(7, PR)<br>(8, 2)                                       | 4-0<br>1B  |           | 4-0<br>BB |            | 0-0<br>F5  |           | 0-0<br>1B |           | 0-0<br>G3-6-3 |
| Jerry Kindall, R<br>OBP: 0.269, SLG: 0.337<br>Don Mincher, L<br>OBP: 0.350, SLG: 0.648<br>Jim Snyder, R<br>OBP: 0.242, SLG: 0.267<br>(1, 4)<br>(5, PH)<br>(5, PR)<br>(6, 4)                            | 0-3<br>K   |           | 0-3<br>K  |            | 4-0<br>BB  |           | 0-3<br>K  |           |               |
| Camilo Pascual, R<br>OBP: 0.254, SLG: 0.273<br>Johnny Klippstein, R<br>(7, 1)<br>Gerry Arrigo, L<br>OBP: 0.231, SLG: 0.167<br>Frank Kostro, R<br>OBP: 0.350, SLG: 0.556<br>Al Worthington, R<br>(8, 1) | 0-3<br>K   |           |           | 0-0<br>5-3 | 4-0<br>BB  |           | 0-0<br>F8 |           |               |

| Inning Stats | R | H | E | K | S  | H | LOB | BB | P  | R | H | E | K | S  | H | LOB | BB | P  | 1B | 2B | 3B | HR | SF | SAC | DP | HBP |
|--------------|---|---|---|---|----|---|-----|----|----|---|---|---|---|----|---|-----|----|----|----|----|----|----|----|-----|----|-----|
|              | 3 | 4 | 0 | 2 | 11 | 0 | 3   | 0  | 5  | 0 | 0 | 0 | 2 | 7  | 0 | 1   | 10 | 6  | 8  | 0  | 0  | 0  | 0  | 0   | 0  |     |
|              | 0 | 0 | 0 | 1 | 5  | 0 | 0   | 0  | 5  | 0 | 0 | 0 | 1 | 10 | 2 | 2   | 5  | 6  | 0  | 0  | 0  | 0  | 0  | 0   | 0  |     |
|              | 0 | 0 | 0 | 2 | 7  | 0 | 2   | 0  | 13 | 0 | 0 | 0 | 3 | 13 | 0 | 3   | 6  | 10 | 0  | 0  | 0  | 0  | 0  | 0   | 0  |     |
|              | 0 | 0 | 0 | 1 | 5  | 0 | 1   | 0  | 10 | 0 | 0 | 0 | 1 | 10 | 0 | 2   | 6  | 6  | 0  | 0  | 0  | 0  | 0  | 0   | 0  |     |
|              | 0 | 0 | 0 | 2 | 7  | 0 | 2   | 0  | 13 | 0 | 0 | 0 | 3 | 13 | 0 | 3   | 6  | 10 | 0  | 0  | 0  | 0  | 0  | 0   | 0  |     |

| Batter  | 1   | 2                               | 3                            | 4                                | 5                            | 6                               | 7                              | 8                               | 9                            | AB R H RBI BB SO LOB            | TOP                          |                                 |                              |                                  |                              |                                 |                              |                                 |                                  |                                    |                                  |        |  |  |  |
|---|---|---------------------------------|------------------------------|----------------------------------|------------------------------|---------------------------------|--------------------------------|---------------------------------|------------------------------|---------------------------------|------------------------------|---------------------------------|------------------------------|----------------------------------|------------------------------|---------------------------------|------------------------------|---------------------------------|----------------------------------|------------------------------------|----------------------------------|--------|--|--|--|
| Nelson Mathews, R (1, 8)<br>OBP: 0.288, SLG: 0.343      | 0-3<br>K  |                                 | 0-0<br>F7                    |                                  | 0-0<br>F7                    |                                 | 0-3<br>K                       |                                 | 0-0<br>HR                    | 5 1 1 0 0 2 2                   |                              |                                 |                              |                                  |                              |                                 |                              |                                 |                                  |                                    |                                  |        |  |  |  |
| Wayne Causey, L (1, 6)<br>OBP: 0.393, SLG: 0.392        | 0-0<br>F6   |                                 | 0-0<br>L6                    |                                  | 0-0<br>F8                    |                                 | 0-0<br>1B<br>4-3<br>1B         |                                 | 0-0<br>F3                    | 5 1 1 0 0 0 2                   |                              |                                 |                              |                                  |                              |                                 |                              |                                 |                                  |                                    |                                  |        |  |  |  |
| Rocky Colavito, R (1, 9)<br>OBP: 0.377, SLG: 0.564      | 0-0<br>HR   |                                 | 4-0<br>BB                    |                                  | 0-0<br>F5                    |                                 | 0-0<br>4-3<br>1B<br>1-3<br>2-H |                                 | 0-0<br>HR                    | 4 2 3 4 1 0 1                   |                              |                                 |                              |                                  |                              |                                 |                              |                                 |                                  |                                    |                                  |        |  |  |  |
| Jim Gentile, L (1, 3)<br>OBP: 0.383, SLG: 0.491         | 0-3<br>K  |                                 | 0-0<br>F2                    |                                  |                              | 0-3<br>K                        | 0-0<br>4-3                     |                                 | 0-0<br>HR                    | 5 0 1 1 0 2 2                   |                              |                                 |                              |                                  |                              |                                 |                              |                                 |                                  |                                    |                                  |        |  |  |  |
| Ken Harrelson, R (1, 7)<br>OBP: 0.333, SLG: 0.509       |   | 0-0<br>2B                       |                              | 0-0<br>FC5-4<br>1B               |                              | 0-0<br>F6                       | 0-3<br>K                       |                                 | 0-0<br>F9                    | 5 0 2 0 0 1 2                   |                              |                                 |                              |                                  |                              |                                 |                              |                                 |                                  |                                    |                                  |        |  |  |  |
| Doc Edwards, R (1, 2)<br>OBP: 0.245, SLG: 0.253         |   | 0-0<br>6-3                      |                              | 0-0<br>F6                        |                              | 0-0<br>2B                       |                                | 0-0<br>F8                       |                              | 3 1 1 0 0 0 2                   |                              |                                 |                              |                                  |                              |                                 |                              |                                 |                                  |                                    |                                  |        |  |  |  |
| Billy Bryan, L (8, PH)<br>OBP: 0.315, SLG: 0.541 (8, 2) |   |                                 |                              | 0-0<br>F9                        |                              | 0-0<br>2B                       |                                |                                 |                              | 1 0 0 0 0 0 0                   |                              |                                 |                              |                                  |                              |                                 |                              |                                 |                                  |                                    |                                  |        |  |  |  |
| Ed Charles, R (1, 5)<br>OBP: 0.316, SLG: 0.361          |   | 4-0<br>BB                       |                              | 0-0<br>F9                        |                              | 0-0<br>2B                       |                                | 0-0<br>F9                       |                              | 3 0 1 1 1 0 1                   |                              |                                 |                              |                                  |                              |                                 |                              |                                 |                                  |                                    |                                  |        |  |  |  |
| Charlie Shoemaker, L (1, 4)<br>OBP: 0.176, SLG: 0.235   |   | 0-3<br>K                        |                              | 0-0<br>FC5-4                     |                              | 0-0<br>4-3                      |                                | 0-0<br>F8                       |                              | 4 0 0 0 0 1 4                   |                              |                                 |                              |                                  |                              |                                 |                              |                                 |                                  |                                    |                                  |        |  |  |  |
| Orlando Pena, R (1, 1)<br>OBP: 0.163, SLG: 0.191        |   | 0-0<br>6-3                      |                              |                                  | 4-0<br>BB                    |                                 | 4-0<br>1B<br>BB                |                                 | 0-0<br>1-3                   | 1 0 0 0 0 0 2                   |                              |                                 |                              |                                  |                              |                                 |                              |                                 |                                  |                                    |                                  |        |  |  |  |
| George Aluskis, R (5, PH)<br>OBP: 0.374, SLG: 0.387     |   |                                 |                              |                                  |                              |                                 |                                |                                 |                              | 0 0 0 0 1 0 0                   |                              |                                 |                              |                                  |                              |                                 |                              |                                 |                                  |                                    |                                  |        |  |  |  |
| Ted Bowsfield, R (5, 1)                                 |   |                                 |                              |                                  |                              |                                 |                                |                                 |                              | 0 1 0 0 1 0 0                   |                              |                                 |                              |                                  |                              |                                 |                              |                                 |                                  |                                    |                                  |        |  |  |  |
| John Wyatt, R (7, 1)                                    |   |                                 |                              |                                  |                              |                                 |                                |                                 |                              | 0 0 0 0 0 0 0                   |                              |                                 |                              |                                  |                              |                                 |                              |                                 |                                  |                                    |                                  |        |  |  |  |
| Jose Tartabull, L (9, PH)<br>OBP: 0.278, SLG: 0.289     |   |                                 |                              |                                  |                              |                                 |                                |                                 |                              | 1 0 0 0 0 0 0                   |                              |                                 |                              |                                  |                              |                                 |                              |                                 |                                  |                                    |                                  |        |  |  |  |
| Moe Uraibowsky, R (9, 1)<br>OBP: 0.029, SLG: 0.029      |   |                                 |                              |                                  |                              |                                 |                                |                                 |                              | 0 0 0 0 0 0 0                   |                              |                                 |                              |                                  |                              |                                 |                              |                                 |                                  |                                    |                                  |        |  |  |  |
| <b>Inning Stats</b>                                     | R: 1<br>E: 0<br>K: 2<br>S: 8                          | H: 1<br>LOB: 0<br>BB: 0<br>P: 8 | R: 0<br>E: 0<br>K: 1<br>S: 6 | H: 1<br>LOB: 2<br>BB: 1<br>P: 10 | R: 0<br>E: 0<br>K: 0<br>S: 3 | H: 0<br>LOB: 1<br>BB: 0<br>P: 7 | R: 0<br>E: 0<br>K: 0<br>S: 4   | H: 1<br>LOB: 1<br>BB: 0<br>P: 4 | R: 0<br>E: 0<br>K: 0<br>S: 3 | H: 0<br>LOB: 1<br>BB: 1<br>P: 7 | R: 1<br>E: 0<br>K: 1<br>S: 7 | H: 2<br>LOB: 1<br>BB: 0<br>P: 7 | R: 2<br>E: 0<br>K: 2<br>S: 9 | H: 2<br>LOB: 1<br>BB: 1<br>P: 13 | R: 0<br>E: 0<br>K: 0<br>S: 3 | H: 0<br>LOB: 0<br>BB: 0<br>P: 3 | R: 2<br>E: 0<br>K: 0<br>S: 6 | H: 3<br>LOB: 1<br>BB: 0<br>P: 6 | 1B: 5<br>2B: 3<br>3B: 0<br>HR: 2 | SF: 0<br>SAC: 0<br>DP: 0<br>HBP: 0 | WP: 0<br>PB: 0<br>SB: 0<br>CS: 0 | PA: 41 |  |  |  |
| <b>PITCHER</b>  | IP WLS BF H R ER SO BB IBB HBP BLK WP HR S P ERA WHIP |                                 |                              |                                  |                              |                                 |                                |                                 |                              |                                 |                              |                                 |                              |                                  |                              |                                 |                              |                                 |                                  |                                    |                                  |        |  |  |  |
| Dick Stigman, L (1, 1)<br>ERA: 3.74                     | 7.0   |                                 | 32                           | 7                                | 4                            | 4                               | 6                              | 4                               | 0                            | 0                               | 0                            | 0                               | 1                            | 40                               | 56                           | 5.14                            | 1.571                        |                                 |                                  |                                    |                                  |        |  |  |  |
| Al Worthington, R (8, 1)<br>ERA: 2.84                   | 1.0   |                                 | 3                            | 0                                | 0                            | 0                               | 0                              | 0                               | 0                            | 0                               | 0                            | 0                               | 0                            | 3                                | 3                            | 0.00                            | 0.000                        |                                 |                                  |                                    |                                  |        |  |  |  |
| Johnny Klippstein, R (9, 1)<br>ERA: 3.2                 | 1.0   | L                               | 6                            | 3                                | 2                            | 2                               | 0                              | 0                               | 0                            | 0                               | 0                            | 1                               | 6                            | 6                                | 18.00                        | 3.000                           |                              |                                 |                                  |                                    |                                  |        |  |  |  |

Kansas City Athletics @ Minnesota Twins  
Metropolitan Stadium, Bloomington, MI

Wed Jul 22 1964, 8:05 PM EDT  
Att. 9,571 - Unknown

livebaseballscorecards.com

|     |    |
|-----|----|
| AB  | 37 |
| R   | 6  |
| H   | 10 |
| RBI | 6  |
| BB  | 4  |
| SO  | 6  |
| LOB | 18 |



**BOTTOM**

**Kansas City Athletics @ Minnesota Twins**  
 Metropolitan Stadium, Bloomington , MI

Wed Jul 22 1964, 8:05 PM EDT  
 Att. 9,571 - Unknown

livebaseballscorecards.com

|            |           |
|------------|-----------|
| <b>AB</b>  | <b>36</b> |
| <b>R</b>   | <b>4</b>  |
| <b>H</b>   | <b>8</b>  |
| <b>RBI</b> | <b>4</b>  |
| <b>BB</b>  | <b>1</b>  |
| <b>SO</b>  | <b>6</b>  |
| <b>LOB</b> | <b>14</b> |



|       |        |
|-------|--------|
| WP: 0 | PA: 39 |
| PB: 0 |        |
| SB: 1 |        |
| CS: 0 |        |

| Batter   | 1          | 2          | 3                       | 4          | 5 | 6 | 7                | 8                        | 9          | AB | R | H | RBI | BB | SO | LOB |
|--|------------|------------|-------------------------|------------|---|---|------------------|--------------------------|------------|----|---|---|-----|----|----|-----|
| Zoilo Versalles, R (1, 6)<br>OBP: 0.312, SLG: 0.423  | 0-0<br>5-3 |            | 0-0<br>E<br>2B          | 0-0<br>1-3 |   |   | 0-0<br>F8        |                          | 0-0<br>5-3 | 5  | 1 | 1 | 0   | 0  | 0  | 1   |
| Rich Rollins, R (1, 5)<br>OBP: 0.341, SLG: 0.423     | 0-3<br>K   |            | 0-0<br>E5<br>2B<br>SF9  |            |   |   | 0-0<br>1-3       | 0-0<br>1-2<br>HBP<br>1B  | 0-0<br>6-3 | 5  | 1 | 1 | 0   | 0  | 1  | 1   |
| Tony Oliva, L (1, 9)<br>OBP: 0.369, SLG: 0.580       | 0-0<br>HR  |            | 0-0<br>F8               |            |   |   | 0-0<br>3-1       | 1-0<br>1-2<br>2-3<br>HBP | 0-0<br>F7  | 4  | 1 | 1 | 1   | 0  | 0  | 2   |
| Harmon Killebrew, R (1, 7)<br>OBP: 0.382, SLG: 0.601 | 0-0<br>1B  |            | 0-0<br>SF9<br>1-3<br>2B |            |   |   | 0-0<br>F3        | 0-0<br>4-3               |            | 4  | 0 | 2 | 1   | 0  | 0  | 3   |
| Jimmie Hall, L (1, 8)<br>OBP: 0.309, SLG: 0.471      | 0-3<br>K   |            | 0-0<br>SF9              |            |   |   | 0-0<br>4-3       | 0-0<br>4-3               |            | 3  | 0 | 0 | 1   | 0  | 1  | 1   |
| Bob Allison, R (1, 3)<br>OBP: 0.415, SLG: 0.608      |            | 0-0<br>F4  | 0-3<br>K                |            |   |   | 0-0<br>5-3       | 0-0<br>E6                |            | 4  | 0 | 0 | 0   | 0  | 1  | 1   |
| Earl Battey, R (1, 2)<br>OBP: 0.353, SLG: 0.442      |            | 0-0<br>F9  |                         | 0-0<br>HR  |   |   | 0-0<br>6-3       | 4-0<br>1-2<br>BB         |            | 3  | 1 | 1 | 1   | 1  | 0  | 0   |
| Johnny Goryl, R (1, 4)<br>OBP: 0.259, SLG: 0.234     |            | 0-0        |                         | 0-3<br>K   |   |   | 0-3<br>K         | 0-0<br>F7                |            | 3  | 0 | 1 | 0   | 0  | 2  | 0   |
| Don Mincher, L (8, PH)<br>OBP: 0.348, SLG: 0.643     |            | 0-0        |                         |            |   |   |                  |                          |            | 1  | 0 | 0 | 0   | 0  | 0  | 2   |
| Jerry Kindall, R (9, 4)<br>OBP: 0.269, SLG: 0.337    |            | 0-0<br>1B  |                         |            |   |   |                  |                          |            | 0  | 0 | 0 | 0   | 0  | 0  | 0   |
| Dick Stigman, R (1, 1)<br>OBP: 0.098, SLG: 0.120     |            | 0-0<br>6-3 |                         | 0-3<br>K   |   |   | 0-0<br>HBP<br>1B | 0-0<br>F8                |            | 3  | 0 | 1 | 0   | 0  | 1  | 1   |
| Al Worthington, R (8, 1)                             |            |            |                         |            |   |   |                  |                          |            | 0  | 0 | 0 | 0   | 0  | 0  | 0   |
| Frank Kostro, R (8, PH)<br>OBP: 0.333, SLG: 0.526    |            |            |                         |            |   |   |                  |                          |            | 1  | 0 | 0 | 0   | 0  | 0  | 2   |
| Johnny Klippstein, R (9, 1)                          |            |            |                         |            |   |   |                  |                          |            | 0  | 0 | 0 | 0   | 0  | 0  | 0   |

| Inning Stats | R: 1 | H: 2 | E: 0 | K: 2 | S: 9 | H: 2 | LOB: 1 | BB: 0 | P: 9 | R: 0 | H: 1 | E: 0 | K: 0 | S: 4 | R: 2 | H: 2 | E: 1 | K: 1 | S: 8 | R: 1 | H: 1 | E: 0 | K: 2 | S: 8 | R: 0 | H: 0 | E: 0 | K: 0 | S: 3 | R: 0 | H: 0 | E: 0 | K: 0 | S: 3 | R: 0 | H: 2 | E: 1 | K: 1 | S: 7 | R: 0 | H: 0 | E: 1 | K: 0 | S: 4 | R: 0 | H: 0 | E: 0 | K: 0 | S: 3 | 1B: 4 | SF: 1 | 2B: 2 | 3B: 0 | HR: 2 |
|--------------|------|------|------|------|------|------|--------|-------|------|------|------|------|------|------|------|------|------|------|------|------|------|------|------|------|------|------|------|------|------|------|------|------|------|------|------|------|------|------|------|------|------|------|------|------|------|------|------|------|------|-------|-------|-------|-------|-------|
|--------------|------|------|------|------|------|------|--------|-------|------|------|------|------|------|------|------|------|------|------|------|------|------|------|------|------|------|------|------|------|------|------|------|------|------|------|------|------|------|------|------|------|------|------|------|------|------|------|------|------|------|-------|-------|-------|-------|-------|

| PITCHER                              | IP  | WLS | BF | H | R | ER | SO | BB | IBB | HBP | BLK | WP | HR | S  | P  | ERA  | WHIP  |
|--------------------------------------|-----|-----|----|---|---|----|----|----|-----|-----|-----|----|----|----|----|------|-------|
| Orlando Pena, R (1, 1)<br>ERA: 4.47  | 4.0 |     | 19 | 6 | 4 | 3  | 5  | 0  | 0   | 0   | 0   | 0  | 2  | 29 | 29 | 6.75 | 1.500 |
| Ted Bowsfield, L (5, 1)<br>ERA: 4.33 | 2.2 |     | 11 | 2 | 0 | 0  | 1  | 0  | 0   | 1   | 0   | 0  | 0  | 12 | 13 | 0.00 | 0.750 |
| John Wyatt, R (7, 1)<br>ERA: 3.72    | 1.1 | W   | 6  | 0 | 0 | 0  | 0  | 1  | 0   | 0   | 0   | 0  | 0  | 5  | 9  | 0.00 | 0.750 |
| Moe Drabowsky, R (9, 1)<br>ERA: 5.5  | 1.0 | S   | 3  | 0 | 0 | 0  | 0  | 0  | 0   | 0   | 0   | 0  | 0  | 3  | 3  | 0.00 | 0.000 |

| PITCHER | IP | WLS | BF | H | R | ER | SO | BB | IBB | HBP | BLK | WP | HR | S | P | ERA | WHIP |
|---------|----|-----|----|---|---|----|----|----|-----|-----|-----|----|----|---|---|-----|------|
|---------|----|-----|----|---|---|----|----|----|-----|-----|-----|----|----|---|---|-----|------|

| Batter  | 1   | 2                                | 3                            | 4                               | 5                            | 6                               | 7                            | 8                               | 9                            | 10                              | 11                           | AB R H RBI BB SO LOB                            | TOP                          |                                 |                              |                                 |                              |                                 |                              |                                 |                                  |                                    |                                  |        |  |  |  |  |  |  |
|---|---|----------------------------------|------------------------------|---------------------------------|------------------------------|---------------------------------|------------------------------|---------------------------------|------------------------------|---------------------------------|------------------------------|---|------------------------------|---------------------------------|------------------------------|---------------------------------|------------------------------|---------------------------------|------------------------------|---------------------------------|----------------------------------|------------------------------------|----------------------------------|--------|--|--|--|--|--|--|
| Nelson Mathews, R (1, 8)<br>OBP: 0.285, SLG: 0.338  | 0-3<br>K  |                                  | x 0-0<br>F9                  |                                 | x 0-0<br>E1                  |                                 | x 0-0<br>F3                  |                                 |                              | x 0-0<br>F9                     |                              | 5 0 0 0 0 1 3                                   |                              |                                 |                              |                                 |                              |                                 |                              |                                 |                                  |                                    |                                  |        |  |  |  |  |  |  |
| Bert Campaneris, R (1, 6)<br>OBP: 0.800, SLG: 2.250   | 0-0<br>HR   |                                  | x 0-0<br>G6-4-3<br>1B        |                                 | x 0-0<br>FC5-4               |                                 | x 0-0<br>HR                  |                                 |                              | 4-0<br>BB                       |                              | 4 2 3 3 1 0 2                                   |                              |                                 |                              |                                 |                              |                                 |                              |                                 |                                  |                                    |                                  |        |  |  |  |  |  |  |
| Rocky Colavito, R (1, 9)<br>OBP: 0.374, SLG: 0.558  | 4-0<br>BB   |                                  | x 0-0<br>G6-4-3              |                                 | x 0-0<br>L5                  |                                 | x 0-0<br>5-3                 |                                 |                              | x 0-0<br>F4                     |                              | 4 0 0 0 1 0 5                                   |                              |                                 |                              |                                 |                              |                                 |                              |                                 |                                  |                                    |                                  |        |  |  |  |  |  |  |
| Jim Gentile, L (1, 3)<br>OBP: 0.379, SLG: 0.485   | 0-0<br>FC6-4  |                                  |                              | x 0-0<br>WP<br>1B               |                              | 0-3<br>K                        |                              | 0-3<br>K                        |                              | x 0-0<br>F7                     |                              | 5 0 1 0 0 2 4                                   |                              |                                 |                              |                                 |                              |                                 |                              |                                 |                                  |                                    |                                  |        |  |  |  |  |  |  |
| Ken Harrelson, R (1, 7)<br>George Alusik, R (9, 7)<br>Jose Tartabull, L (11, 7)<br>OBP: 0.311, SLG: 0.474<br>OBP: 0.372, SLG: 0.385<br>OBP: 0.278, SLG: 0.269 | 0-0<br>FC6-4  |                                  |                              | x 0-0<br>F8                     |                              | x 0-0<br>F2                     |                              | 0-3<br>K                        |                              |                                 | 0-3<br>K                     | 4 0 0 0 0 1 2<br>1 0 0 0 0 1 0<br>0 0 0 0 0 0 0 |                              |                                 |                              |                                 |                              |                                 |                              |                                 |                                  |                                    |                                  |        |  |  |  |  |  |  |
| Doc Edwards, R (1, 2)<br>OBP: 0.250, SLG: 0.276   |   | x 0-0<br>G6-4-3<br>1B            |                              | x 0-0<br>F4                     |                              | x 0-0<br>6-3                    |                              | x 0-0<br>F3                     |                              |                                 | x 0-0<br>HR                  | 5 1 2 1 0 0 1                                   |                              |                                 |                              |                                 |                              |                                 |                              |                                 |                                  |                                    |                                  |        |  |  |  |  |  |  |
| Ed Charles, R (1, 5)<br>OBP: 0.319, SLG: 0.362  |   | x 0-0<br>G6-4-3                  |                              | x 4-0<br>FC5-4<br>IBB           |                              | x 0-0<br>CS<br>1B               |                              |                                 | x 0-0<br>6-3                 |                                 | x 0-0<br>1B                  | 4 0 2 0 1 0 1                                   |                              |                                 |                              |                                 |                              |                                 |                              |                                 |                                  |                                    |                                  |        |  |  |  |  |  |  |
| Charlie Shoemaker, L (1, 4)<br>OBP: 0.179, SLG: 0.231   |   | x 0-0<br>6-3                     |                              | x 0-0<br>FC5-4                  |                              | x 0-0<br>CS                     |                              | x 0-0<br>SH5-4<br>HR<br>1B      |                              | x 0-0<br>1-3                    |                              | 5 1 1 0 0 0 3                                   |                              |                                 |                              |                                 |                              |                                 |                              |                                 |                                  |                                    |                                  |        |  |  |  |  |  |  |
| Diego Segui, R (1, 1)<br>John Wyatt, R (10, 1)<br>OBP: 0.208, SLG: 0.255  |   |                                  | x 0-0<br>1B                  |                                 | x 0-0<br>FC5-4<br>E<br>1B    |                                 | x 0-0<br>SH5-4               |                                 | 0-3<br>K                     |                                 | 0-3<br>K                     | 3 0 2 0 0 1 0<br>1 0 0 0 0 1 1                  |                              |                                 |                              |                                 |                              |                                 |                              |                                 |                                  |                                    |                                  |        |  |  |  |  |  |  |
| <b>Inning Stats</b>   | R: 1<br>E: 0<br>K: 1<br>S: 6                          | H: 1<br>LOB: 1<br>BB: 1<br>P: 10 | R: 0<br>E: 0<br>K: 0<br>S: 3 | H: 1<br>LOB: 0<br>BB: 0<br>P: 3 | R: 0<br>E: 0<br>K: 0<br>S: 4 | H: 2<br>LOB: 1<br>BB: 0<br>P: 4 | R: 0<br>E: 0<br>K: 0<br>S: 4 | H: 1<br>LOB: 2<br>BB: 1<br>P: 8 | R: 0<br>E: 1<br>K: 1<br>S: 7 | H: 1<br>LOB: 2<br>BB: 0<br>P: 7 | R: 0<br>E: 0<br>K: 2<br>S: 7 | H: 0<br>LOB: 0<br>BB: 0<br>P: 7                 | R: 0<br>E: 0<br>K: 1<br>S: 5 | H: 0<br>LOB: 0<br>BB: 0<br>P: 5 | R: 0<br>E: 0<br>K: 2<br>S: 7 | H: 0<br>LOB: 0<br>BB: 0<br>P: 7 | R: 0<br>E: 0<br>K: 1<br>S: 5 | H: 0<br>LOB: 1<br>BB: 1<br>P: 7 | R: 1<br>E: 0<br>K: 2<br>S: 9 | H: 2<br>LOB: 1<br>BB: 0<br>P: 9 | 1B: 8<br>2B: 0<br>3B: 0<br>HR: 3 | SF: 0<br>SAC: 1<br>DP: 2<br>HBP: 0 | WP: 1<br>PB: 0<br>SB: 2<br>CS: 1 | PA: 46 |  |  |  |  |  |  |
| <b>PITCHER</b>  | IP WLS BF H R ER SO BB IBB HBP BLK WP HR S P ERA WHIP |                                  |                              |                                 |                              |                                 |                              |                                 |                              |                                 |                              |   |                              |                                 |                              |                                 |                              |                                 |                              |                                 |                                  |                                    |                                  |        |  |  |  |  |  |  |
| Jim Kaat, L (1, 1)<br>ERA: 3.4  | 9.0   |                                  | 36                           | 9                               | 3                            | 3                               | 5                            | 1                               | 1                            | 0                               | 0                            | 1   | 2                            | 44                              | 52                           | 3.00                            | 1.111                        |                                 |                              |                                 |                                  |                                    |                                  |        |  |  |  |  |  |  |
| Al Worthington, R (10, 1)<br>ERA: 2.73  | 1.0   |                                  | 4                            | 0                               | 0                            | 0                               | 0                            | 1                               | 0                            | 0                               | 0                            | 0   | 0                            | 3                               | 7                            | 0.00                            | 1.000                        |                                 |                              |                                 |                                  |                                    |                                  |        |  |  |  |  |  |  |
| Gerry Arrigo, L (11, 1)<br>ERA: 4.19  | 1.0   | L                                | 5                            | 2                               | 1                            | 1                               | 2                            | 0                               | 0                            | 0                               | 0                            | 0   | 1                            | 9                               | 9                            | 9.00                            | 2.000                        |                                 |                              |                                 |                                  |                                    |                                  |        |  |  |  |  |  |  |

**Kansas City Athletics @ Minnesota Twins**  
 Metropolitan Stadium, Bloomington, MI  
 Thu Jul 23 1964, 4:33 AM EDT  
 Att: 5,321 - Unknown

|     |    |
|-----|----|
| AB  | 41 |
| R   | 4  |
| H   | 11 |
| RBI | 4  |
| BB  | 3  |
| SO  | 7  |
| LOB | 22 |



|       |        |
|-------|--------|
| WP: 1 | PA: 46 |
|-------|--------|



| Batter  | 1   | 2                                | 3                            | 4                               | 5                            | 6                               | 7                            | 8                               | 9                            | 10                              | 11                           | AB R H RBI BB SO LOB   | BOTTOM  |                              |                                 |                              |                                 |                              |                                  |                              |                                 |                                  |                                    |                                  |        |
|---|---|----------------------------------|------------------------------|---------------------------------|------------------------------|---------------------------------|------------------------------|---------------------------------|------------------------------|---------------------------------|------------------------------|--|---|------------------------------|---------------------------------|------------------------------|---------------------------------|------------------------------|----------------------------------|------------------------------|---------------------------------|----------------------------------|------------------------------------|----------------------------------|--------|
| <b>Rich Rollins, R</b><br>OBP: 0.339, SLG: 0.420<br>(1, 5)  | 0-0<br>3-1<br>1-3<br>1B                               |                                  | 0-3<br>K2-3                  |                                 |                              | 0-0<br>F8                       |                              | 0-0<br>F3                       |                              | 0-0<br>FC5-4<br>1-2f            |                              | 5 0 1 0 0 1 2  | <b>Kansas City Athletics @ Minnesota Twins</b><br>Metropolitan Stadium, Bloomington, MI<br>Thu Jul 23 1964, 4:33 AM EDT<br>Att: 5,321 - Unknown |                              |                                 |                              |                                 |                              |                                  |                              |                                 |                                  |                                    |                                  |        |
| <b>Tony Oliva, L</b><br>OBP: 0.367, SLG: 0.575<br>(1, 9)  | 0-0<br>1-3<br>1-2                                     |                                  | 0-0<br>3-1                   |                                 |                              | 0-0<br>BB<br>HR<br>1B           |                              | 0-0<br>F7                       |                              |                                 | 0-0<br>F7                    | 5 1 1 0 0 0 1  |   |                              |                                 |                              |                                 |                              |                                  |                              |                                 |                                  |                                    |                                  |        |
| <b>Jimmie Hall, L</b><br>OBP: 0.311, SLG: 0.466<br>(1, 8)   | 0-0<br>3-1<br>2-3                                     |                                  |                              | 0-0<br>F4                       |                              | 4-0<br>BB<br>HR<br>BB           |                              | 0-0<br>F6                       |                              |                                 | 4-0<br>FC5-4<br>BB           | 3 1 0 0 2 0 1  |   |                              |                                 |                              |                                 |                              |                                  |                              |                                 |                                  |                                    |                                  |        |
| <b>Harmon Killebrew, R</b><br>OBP: 0.363, SLG: 0.605<br><b>Mudcat Grant, R</b><br>OBP: 0.280, SLG: 0.391<br>(1, 7)<br>(11, PR)  | 4-0<br>BB   |                                  | 0-3<br>K                     |                                 |                              | 0-0<br>1-H<br>2-H<br>HR         |                              | 0-0<br>F7                       |                              |                                 | 0-0<br>FC5-4<br>1-2f         | 4 1 1 3 1 1 1<br>0 0 0 0 0 0 0                                   |   |                              |                                 |                              |                                 |                              |                                  |                              |                                 |                                  |                                    |                                  |        |
| <b>Don Mincher, L</b><br>OBP: 0.337, SLG: 0.622<br>(1, 3)   | 0-3<br>K  |                                  | 0-3<br>K                     |                                 |                              | 0-0<br>F9                       |                              | 0-0<br>3-1                      |                              |                                 | 0-0<br>F8                    | 5 0 0 0 0 2 3  |   |                              |                                 |                              |                                 |                              |                                  |                              |                                 |                                  |                                    |                                  |        |
| <b>Earl Battey, R</b><br>OBP: 0.348, SLG: 0.434<br>(1, 2)   |   | 0-0<br>F9                        |                              | 0-3<br>K                        |                              | 0-0<br>F8                       |                              | 0-0<br>F8                       |                              | 0-0<br>F8                       |                              | 4 0 0 0 0 1 0  |   |                              |                                 |                              |                                 |                              |                                  |                              |                                 |                                  |                                    |                                  |        |
| <b>Zoilo Versalles, R</b><br>OBP: 0.311, SLG: 0.423<br>(1, 6)   |   | 0-0<br>F7                        |                              | 0-0<br>F3                       |                              | 0-0<br>F7                       |                              | 0-0<br>F7                       |                              | 0-0<br>2B                       |                              | 4 0 1 0 0 0 0  |   |                              |                                 |                              |                                 |                              |                                  |                              |                                 |                                  |                                    |                                  |        |
| <b>Johnny Goryl, R</b><br>OBP: 0.250, SLG: 0.225<br><b>Frank Kastro, R</b><br>OBP: 0.318, SLG: 0.500<br><b>Jerry Kindall, R</b><br>OBP: 0.269, SLG: 0.337<br>(1, 4)<br>(10, PH)<br>(11, 4)            |   | 0-0<br>F8                        |                              | 0-0<br>6-3                      |                              | 0-0<br>F4                       |                              | 0-3<br>K                        |                              | 0-3<br>K                        |                              | 3 0 0 0 0 0 0<br>1 0 0 0 0 1 1<br>0 0 0 0 0 0 0                  |   |                              |                                 |                              |                                 |                              |                                  |                              |                                 |                                  |                                    |                                  |        |
| <b>Jim Kaat, L</b><br>OBP: 0.286, SLG: 0.306<br><b>Al Worthington, R</b><br>(10, 1)<br><b>Bob Allison, R</b><br>OBP: 0.416, SLG: 0.608<br><b>Gerry Arrigo, L</b><br>OBP: 0.231, SLG: 0.167<br>(11, 1) |   | 0-0<br>F7                        |                              |                                 |                              | 0-0<br>F7                       |                              | 0-0<br>G3                       |                              | 4-0<br>FC5-4<br>IBB             |                              | 3 0 0 0 0 0 0<br>0 0 0 0 0 0 0<br>0 0 0 0 1 0 0<br>0 0 0 0 0 0 0 |   |                              |                                 |                              |                                 |                              |                                  |                              |                                 |                                  |                                    |                                  |        |
| <b>Inning Stats</b>   | R: 0<br>E: 0<br>K: 1<br>S: 6                          | H: 1<br>LOB: 2<br>BB: 1<br>P: 10 | R: 0<br>E: 0<br>K: 0<br>S: 3 | H: 0<br>LOB: 0<br>BB: 0<br>P: 3 | R: 0<br>E: 0<br>K: 1<br>S: 5 | H: 0<br>LOB: 0<br>BB: 0<br>P: 5 | R: 0<br>E: 0<br>K: 2<br>S: 7 | H: 0<br>LOB: 0<br>BB: 0<br>P: 7 | R: 0<br>E: 0<br>K: 1<br>S: 5 | H: 0<br>LOB: 0<br>BB: 0<br>P: 5 | R: 3<br>E: 0<br>K: 0<br>S: 5 | H: 2<br>LOB: 0<br>BB: 1<br>P: 9                                  |   | R: 0<br>E: 0<br>K: 0<br>S: 3 | H: 0<br>LOB: 0<br>BB: 0<br>P: 3 | R: 0<br>E: 0<br>K: 0<br>S: 3 | H: 0<br>LOB: 0<br>BB: 0<br>P: 3 | R: 0<br>E: 0<br>K: 1<br>S: 6 | H: 1<br>LOB: 2<br>BB: 1<br>P: 10 | R: 0<br>E: 0<br>K: 0<br>S: 3 | H: 0<br>LOB: 1<br>BB: 1<br>P: 7 | 1B: 2<br>2B: 1<br>3B: 0<br>HR: 1 | SF: 0<br>SAC: 0<br>DP: 0<br>HBP: 0 | WP: 0<br>PB: 0<br>SB: 0<br>CS: 0 | PA: 41 |
| <b>PITCHER</b>  | IP WLS BF H R ER SO BB IBB HBP BLK WP HR S P ERA WHIP |                                  |                              |                                 |                              |                                 |                              |                                 |                              |                                 |                              |  |   |                              |                                 |                              |                                 |                              |                                  |                              |                                 |                                  |                                    |                                  |        |
| <b>Diego Segui, R</b><br>ERA: 3.85<br>(1, 1)  | 9.1   | 34                               | 4                            | 3                               | 3                            | 5                               | 2                            | 0                               | 0                            | 0                               | 0                            | 0  | 1   | 42                           | 50                              | 2.89                         | 0.643                           |                              |                                  |                              |                                 |                                  |                                    |                                  |        |
| <b>John Wyatt, R</b><br>ERA: 3.63<br>(10, 1)  | 1.2   | 7                                | 0                            | 0                               | 0                            | 1                               | 1                            | 1                               | 0                            | 0                               | 0                            | 0  | 0   | 7                            | 15                              | 0.00                         | 0.600                           |                              |                                  |                              |                                 |                                  |                                    |                                  |        |

livebaseballscores.com

|     |    |
|-----|----|
| AB  | 37 |
| R   | 3  |
| H   | 4  |
| RBI | 3  |
| BB  | 4  |
| SO  | 6  |
| LOB | 9  |



| Batter   | 1  | 2   | 3   | 4   | 5   | 6  | 7   | 8   | 9   | AB R H RBI BB SO LOB                                       | TOP  |   |
|--|--|---|---|---|---|--|---|---|---|--|--|---|
| <b>Jim Piersall, R</b> (1, 7)<br><small>OBP: 0.383, SLG: 0.414</small>   | 0-0<br>6-3   |   |   | 0-0<br>6-3  |   | 4-0<br>SH3-4<br>G1-2-3<br>BB                         |   | 0-0<br>F3   |   | 3 0 0 0 1 0 0  | <b>Los Angeles Angels @ Kansas City Athletics</b><br><b>Municipal Stadium, Kansas City, MO</b><br><small>Fri Jul 24 1964, 8:05 PM EDT</small><br><small>Att. 8,261 - Unknown</small> |   |
| <b>Vic Power, R</b> (1, 5)<br><small>OBP: 0.271, SLG: 0.309</small>  | 0-0<br>6-3   |   |   | 0-0<br>BB<br>1B                                     |   | 0-0<br>SH3-4<br>1B                                   |   | 0-0<br>1B   |   | 4 0 3 0 0 0 0  |  |   |
| <b>Jim Fregosi, R</b> (1, 6)<br><small>OBP: 0.401, SLG: 0.526</small>  | 0-0<br>F3  |   |   | 0-0<br>F7   |   | 0-0<br>SH3-4<br>1-2<br>2-3                           |   | 0-0<br>F9   |   | 3 0 0 0 0 0 2  |  |   |
| <b>Joe Adcock, R</b> (1, 3)<br><small>OBP: 0.356, SLG: 0.507</small><br><b>Albie Pearson, L</b> (9, PR)<br><small>OBP: 0.310, SLG: 0.269</small>                         |  | 0-0<br>6-3  |   | 4-0<br>FC6-4<br>BB                                  |   | 4-0<br>IBB   |   | 0-0<br>FC6-4<br>1B                                  |   | 2 0 1 0 2 0 0<br>0 0 0 0 0 0 0                             |  |   |
| <b>Lou Clinton, R</b> (1, 9)<br><small>OBP: 0.293, SLG: 0.402</small>  |  | 0-0<br>5-3  |   | 0-0<br>FC6-4<br>1-2f                                |   | 0-0<br>G1-2-3<br>3-Hf                                |   | 0-0<br>F8   |   | 4 0 0 0 0 0 6  |  |   |
| <b>Bob Perry, R</b> (1, 8)<br><small>OBP: 0.346, SLG: 0.405</small>  |  | 0-0<br>F7   |   |   | 0-0<br>FC6-4<br>1B                                  |  | 0-0<br>FC6-4<br>1B                                  |   | 0-0<br>FC6-4<br>1-2f                                |  |  | 4 0 2 0 0 0 1                                   |
| <b>Buck Rodgers, S</b> (1, 2)<br><small>OBP: 0.302, SLG: 0.308</small>   |  |   | 0-0<br>F3   |   | 0-0<br>FC6-4<br>1-2f                                |  | 0-0<br>FC6-4<br>1-2f                                |   | 0-0<br>FC6-4<br>1-2f                                |  |  | 4 0 0 0 0 0 3                                   |
| <b>Bobby Knoop, R</b> (1, 4)<br><small>OBP: 0.305, SLG: 0.287</small>  |  |   | 0-0<br>L6   |   | 0-0<br>4-3  |  | 0-0<br>G6-3   |   |   |  |  | 3 0 0 0 0 0 2                                   |
| <b>Don Lee, R</b> (1, 1)<br><small>OBP: 0.235, SLG: 0.250</small><br><b>Felix Torres, R</b> (8, PH)<br><small>OBP: 0.257, SLG: 0.412</small><br><b>Bob Lee, R</b> (8, 1) |  |   | 0-0<br>1-3  |   | 0-3<br>K  |  | 0-3<br>K  |   |   |  |  | 2 0 0 0 0 1 1<br>1 0 0 0 0 1 0<br>0 0 0 0 0 0 0 |
| <b>Inning Stats</b>  | R: 0 H: 0<br>E: 0 LOB: 0<br>K: 0 BB: 0<br>S: 3 P: 3  | R: 0 H: 0<br>E: 0 LOB: 0<br>K: 0 BB: 0<br>S: 3 P: 3 | R: 0 H: 0<br>E: 0 LOB: 0<br>K: 0 BB: 0<br>S: 3 P: 3 | R: 0 H: 1<br>E: 0 LOB: 2<br>K: 0 BB: 1<br>S: 4 P: 8 | R: 0 H: 1<br>E: 0 LOB: 1<br>K: 1 BB: 0<br>S: 6 P: 6 | R: 0 H: 1<br>E: 0 LOB: 2<br>K: 0 BB: 2<br>S: 3 P: 11 | R: 0 H: 1<br>E: 0 LOB: 0<br>K: 0 BB: 0<br>S: 3 P: 3 | R: 0 H: 1<br>E: 0 LOB: 1<br>K: 1 BB: 0<br>S: 6 P: 6 | R: 0 H: 1<br>E: 0 LOB: 1<br>K: 0 BB: 0<br>S: 4 P: 4 | 1B: 6 SF: 0<br>2B: 0 SAC: 1<br>3B: 0 DP: 2<br>HR: 0 HBP: 0 | WP: 0 PA: 34<br>PB: 0<br>SB: 0<br>CS: 0  |   |
| <b>PITCHER</b><br><b>John O'Donoghue, L</b> (1, 1)<br><small>ERA: 4.33</small>   | IP WLS BF H R ER SO BB IBB HBP BLK WP HR S P ERA WHIP<br>9.0 W 34 6 0 0 2 2 1 0 0 0 0 0 35 47 0.00 0.889 |   |   |   |   |  |   |   |   |  |  |   |

livebaseballscorecards.com

|     |    |
|-----|----|
| AB  | 30 |
| R   | 0  |
| H   | 6  |
| RBI | 0  |
| BB  | 3  |
| SO  | 2  |
| LOB | 15 |



| Batter  | 1             | 2               | 3                | 4              | 5                        | 6              | 7               | 8                     | 9 | AB | R | H | RBI | BB | SO | LOB |
|---|---------------|-----------------|------------------|----------------|--------------------------|----------------|-----------------|-----------------------|---|----|---|---|-----|----|----|-----|
| Bert Campaneris, R<br>OBP: 0.556, SLG: 1.250<br>(1, 6)  | 0-3<br>K<br>① |                 | 0-3<br>K<br>②    |                | 0-0<br>F6<br>③           |                |                 | 0-0<br>E3<br>F8<br>1B |   | 4  | 0 | 1 | 0   | 0  | 2  | 2   |
| Jose Tartabull, L<br>OBP: 0.259, SLG: 0.250<br>(1, 8)<br>(9, 7)   | 0-0<br>6-3    |                 | 0-0<br>5-3       |                |                          | 0-0<br>F8<br>① |                 | 0-0<br>F8<br>②        |   | 4  | 0 | 0 | 0   | 0  | 0  | 2   |
| Rocky Colavito, R<br>OBP: 0.371, SLG: 0.551<br>(1, 9)   | 0-0<br>F2     |                 |                  | 0-0<br>F7<br>① |                          | 0-3<br>K<br>②  |                 | 0-0<br>6-3<br>③       |   | 4  | 0 | 0 | 0   | 0  | 1  | 1   |
| Jim Gentile, L<br>OBP: 0.382, SLG: 0.487<br>(1, 3)  |               | 0-0<br>4-3<br>① |                  | 0-0<br>1B      |                          | 0-0<br>1B      |                 |                       |   | 3  | 0 | 2 | 0   | 0  | 0  | 0   |
| Ken Harrelson, R<br>OBP: 0.297, SLG: 0.450<br>Nelson Mathews, R<br>OBP: 0.285, SLG: 0.338<br>(1, 7)<br>(9, 8) |               | 0-0<br>5-3<br>② |                  | 0-0<br>F5<br>② |                          | 0-0<br>F8<br>③ |                 |                       |   | 3  | 0 | 0 | 0   | 0  | 0  | 2   |
| Billy Bryan, L<br>OBP: 0.309, SLG: 0.529<br>(1, 2)  |               | 0-0<br>F9<br>③  |                  | 0-3<br>K<br>③  |                          |                |                 |                       |   | 0  | 0 | 0 | 0   | 0  | 0  | 0   |
| Ed Charles, R<br>OBP: 0.322, SLG: 0.365<br>(1, 5)   |               |                 | 0-0<br>3B<br>1B  |                | 0-0<br>SH3-4<br>1B       |                | 0-3<br>K<br>①   | 0-0<br>F7<br>②        |   | 3  | 1 | 2 | 0   | 0  | 0  | 0   |
| Charlie Shoemaker, L<br>OBP: 0.190, SLG: 0.286<br>(1, 4)  |               |                 | 0-0<br>1-H<br>3B |                | 0-0<br>F7<br>①           |                | 0-0<br>4-3<br>③ |                       |   | 3  | 0 | 1 | 1   | 0  | 0  | 1   |
| John O'Donoghue, R<br>OBP: 0.229, SLG: 0.314<br>(1, 1)  |               |                 | 0-3<br>K<br>①    |                | 0-0<br>SH3-4<br>1-2<br>② |                |                 | 0-0<br>4-3<br>①       |   | 2  | 0 | 0 | 0   | 0  | 1  | 1   |

**BOTTOM**

Los Angeles Angels @ Kansas City Athletics  
Municipal Stadium, Kansas City, MO

Fri Jul 24 1964, 8:05 PM EDT  
Att. 8,261 - Unknown

livebaseballscorecards.com

|     |    |
|-----|----|
| AB  | 29 |
| R   | 1  |
| H   | 6  |
| RBI | 1  |
| BB  | 0  |
| SO  | 6  |
| LOB | 10 |



| Inning Stats |        |      |        |      |        |      |        |      |        |      |        |      |        |      |        |      | 1B:    | SF: | WP: | PA: |    |
|--------------|--------|------|--------|------|--------|------|--------|------|--------|------|--------|------|--------|------|--------|------|--------|-----|-----|-----|----|
| R: 0         | H: 0   | R: 0 | H: 0   | R: 1 | H: 2   | R: 0 | H: 1   | R: 0 | H: 1   | R: 0 | H: 0   | R: 0 | H: 1   | R: 0 | H: 1   | R: 0 | H: 1   | 5   | 0   | 0   | 30 |
| E: 0         | LOB: 0 | E: 0 | LOB: 0 | E: 0 | LOB: 1 | E: 0 | LOB: 1 | E: 0 | LOB: 1 | E: 0 | LOB: 0 | E: 1 | LOB: 1 | E: 0 | LOB: 0 | E: 0 | LOB: 1 | 0   | 0   | 0   | 0  |
| K: 1         | BB: 0  | K: 0 | BB: 0  | K: 2 | BB: 0  | K: 1 | BB: 0  | K: 0 | BB: 0  | K: 1 | BB: 0  | K: 1 | BB: 0  | K: 0 | BB: 0  | K: 0 | BB: 0  | 0   | 0   | 0   | 0  |
| S: 5         | P: 5   | S: 3 | P: 3   | S: 9 | P: 9   | S: 6 | P: 6   | S: 4 | P: 4   | S: 5 | P: 5   | S: 4 | P: 4   | S: 5 | P: 5   | S: 4 | P: 4   | 0   | 0   | 0   | 0  |

| PITCHER                           |     |     |    |   |   |    |    |    |     |     |     |    |    |    |    |      | ERA   | WHIP |
|-----------------------------------|-----|-----|----|---|---|----|----|----|-----|-----|-----|----|----|----|----|------|-------|------|
| Don Lee, R<br>ERA: 2.48<br>(1, 1) | IP  | WLS | BF | H | R | ER | SO | BB | IBB | HBP | BLK | WP | HR | S  | P  | ERA  | WHIP  |      |
| Bob Lee, R<br>ERA: 1.74<br>(8, 1) | 7.0 | L   | 26 | 5 | 1 | 1  | 6  | 0  | 0   | 0   | 0   | 0  | 0  | 38 | 38 | 1.29 | 0.714 |      |
|                                   | 1.0 |     | 4  | 1 | 0 | 0  | 0  | 0  | 0   | 0   | 0   | 0  | 0  | 4  | 4  | 0.00 | 1.000 |      |

| Batter  | 1   | 2   | 3  | 4   | 5  | 6   | 7   | 8   | 9   | AB R H RBI BB SO LOB  | TOP  |   |
|---|---|---|--|---|--|---|---|---|---|---|--|---|
| <b>Bob Perry, R</b><br>OBP: 0.345, SLG: 0.424 (1, 8)  | 5-3<br>F6   |   | 0-0<br>1-2 2-H<br>1B                                 |   | 0-3<br>K   | 0-0<br>1-H 2-H<br>HR                                  |   | 0-3<br>K  |   | 6 1 2 4 0 2 7   |  |   |
| <b>Vic Power, R</b><br>OBP: 0.267, SLG: 0.310 (1, 5)<br>(1, 3)  | 0-0<br>1B<br>2B                                       | 0-0<br>6-3  | 0-3<br>K   |   | 0-0<br>F9  | 0-0<br>5-3  |   | 0-0<br>F2   |   | 6 1 1 0 0 1 7   |  |   |
| <b>Jim Fregosi, R</b><br>OBP: 0.406, SLG: 0.528 (1, 6)<br>B B B B   | 4-0<br>1B<br>2B<br>BB                                 | 0-0<br>F6   |  | 4-0<br>G5-4-3<br>1B<br>BB                           |  | 0-0<br>HR<br>2B                                       | 0-0<br>5-3  | 4-0<br>1B<br>E<br>BB                                  |   | 3 3 1 1 3 0 0   |  |   |
| <b>Willie Smith, L</b><br>OBP: 0.316, SLG: 0.503 (1, 7)<br><b>Ed Kirkpatrick, L</b><br>OBP: 0.317, SLG: 0.363 (8, 7)  | 0-0<br>1-2 2-3<br>2B<br>1B                            | 0-0   |  | 0-0<br>G5-4-3<br>1B                                 |  | 0-0<br>2-H<br>HR                                      | 0-0<br>F8   | 0-0<br>1-2 2-3 3-H<br>E<br>1B                         |   | 6 2 5 3 0 0 0<br>0 0 0 0 0 0 0                              |  |   |
| <b>Joe Adcock, R</b><br>OBP: 0.358, SLG: 0.513 (1, 3)<br><b>Felix Torres, R</b><br>OBP: 0.255, SLG: 0.426 (1, PR)<br>(1, 5)   | 0-0<br>1B<br>2B<br>2B                                 | 0-0<br>F9   |  | 0-0<br>G5-4-3<br>1-2f 2-3                           |  | 0-0<br>F8   | 0-0<br>HR   | 0-0<br>E4<br>1-3 2-H 3-H                              |   | 1 0 1 3 0 0 0<br>5 2 1 1 0 0 4                              |  |   |
| <b>Buck Rodgers, S</b><br>OBP: 0.303, SLG: 0.318 (1, 2)<br><b>Tom Satriano, L</b><br>OBP: 0.288, SLG: 0.241 (7, 2)  | 0-0<br>2-3<br>BB<br>2B<br>1B                          |   | 0-0<br>F8  | 0-0<br>F2   |  | 0-0<br>HR   | 0-0<br>F8   | 0-0<br>F9   |   | 5 2 2 1 0 0 1<br>1 0 0 0 0 0 2                              |  |   |
| <b>Lou Clinton, R</b><br>OBP: 0.298, SLG: 0.402 (1, 9)<br>B B B B   | 4-0<br>1-2<br>2B<br>BB                                |   | 0-0<br>F8  |   | 0-0<br>F8  | 0-0<br>1B<br>HR<br>1B                                 |   | 0-0<br>1B<br>PB<br>BB<br>1B                           | 0-3<br>K  | 5 3 2 0 1 1 0   | <b>AB 47</b><br><b>R 18</b><br><b>H 19</b><br><b>RBI 16</b><br><b>BB 6</b><br><b>SO 6</b><br><b>LOB 25</b> |   |
| <b>Bobby Knoop, R</b><br>OBP: 0.311, SLG: 0.294 (1, 4)<br><b>Aubrey Gatewood, R</b><br>OBP: 0.200, SLG: 0.200 (8, PR)<br><b>Joe Koppe, R</b><br>OBP: 0.351, SLG: 0.320 (8, 4) | 0-0<br>4-3<br>1-H 2-H 3-H<br>2B                       |   | 4-0<br>1B<br>1B<br>BB                                |   | 4-0<br>SH<br>BB                                      | 0-3<br>K  |   | 0-0<br>BB<br>E<br>1B<br>1B                            | 0-0<br>6-3  | 3 1 2 3 2 1 1<br>0 1 0 0 0 0 0<br>1 0 0 0 0 0 0             |  |   |
| <b>Bo Belinsky, L</b><br>OBP: 0.146, SLG: 0.128 (1, 1)  | 0-0<br>4-3<br>2-3                                     |   | 0-0<br>1B<br>1B                                      |   | 0-0<br>SH  | 0-0<br>1-2<br>HR<br>1B                                |   | 0-0<br>E4<br>1B<br>BB<br>E                            | 0-3<br>K  | 5 2 2 0 0 1 3   |                       |   |
| <b>Inning Stats</b>   | R: 6 H: 5<br>E: 0 LOB: 2<br>K: 0 BB: 2<br>S: 8 P: 16  | R: 0 H: 1<br>E: 0 LOB: 1<br>K: 0 BB: 0<br>S: 4 P: 4 | R: 1 H: 2<br>E: 0 LOB: 2<br>K: 1 BB: 1<br>S: 7 P: 11 | R: 0 H: 1<br>E: 0 LOB: 1<br>K: 0 BB: 1<br>S: 3 P: 7 | R: 0 H: 0<br>E: 1 LOB: 2<br>K: 1 BB: 1<br>S: 6 P: 10 | R: 6 H: 6<br>E: 0 LOB: 0<br>K: 1 BB: 0<br>S: 11 P: 11 | R: 1 H: 1<br>E: 0 LOB: 0<br>K: 0 BB: 0<br>S: 4 P: 4 | R: 4 H: 3<br>E: 2 LOB: 2<br>K: 1 BB: 1<br>S: 10 P: 14 | R: 0 H: 0<br>E: 0 LOB: 0<br>K: 2 BB: 0<br>S: 7 P: 7 | 1B: 10 SF: 0<br>2B: 4 SAC: 1<br>3B: 1 DP: 1<br>HR: 4 HBP: 0 | WP: 0 PA: 54<br>PB: 1<br>SB: 0<br>CS: 0  |   |
| <b>PITCHER</b><br><b>Moe Drabowsky, R</b><br>ERA: 5.99 (1, 1)<br><b>Dan Pfister, R</b><br>ERA: 6.25 (1, 1)<br><b>Orlando Pena, R</b><br>ERA: 4.78 (5, 1)                      | IP WLS BF H R ER SO BB IBB HBP BLK WP HR S P ERA WHIP |   |  |   |  |   |   |   |   |   |  | <b>PITCHER</b><br>IP WLS BF H R ER SO BB IBB HBP BLK WP HR S P ERA WHIP |

Los Angeles Angels @ Kansas City Athletics  
Municipal Stadium, Kansas City, MO  
Sat Jul 25 1964, 4:33 AM EDT  
Att. 14,515 - Unknown

livebaseballscorecards.com

| Batter  | 1                            | 2                               | 3                            | 4                               | 5                            | 6                                | 7                            | 8                               | 9                            | AB                              | R                            | H                               | RBI                          | BB                              | SO                           | LOB                             |                                  |                                    |                                  |        |  |
|---|------------------------------|---------------------------------|------------------------------|---------------------------------|------------------------------|----------------------------------|------------------------------|---------------------------------|------------------------------|---------------------------------|------------------------------|---------------------------------|------------------------------|---------------------------------|------------------------------|---------------------------------|----------------------------------|------------------------------------|----------------------------------|--------|--|
| Bert Campaneris, R<br>OBP: 0.615, SLG: 1.100 (1, 6)   | 0-0<br>G3                    |                                 | 0-0<br>PB<br>1B              |                                 |                              | 4-0<br>G5-4-3<br>1B<br>BB        |                              | 4-0<br>G6-4-3<br>BB             |                              | 2                               | 1                            | 1                               | 0                            | 2                               | 0                            | 0                               |                                  |                                    |                                  |        |  |
| Nelson Mathews, R<br>OBP: 0.287, SLG: 0.340 (1, 8)    | 0-0<br>6-3                   |                                 | 0-0<br>1B                    |                                 |                              | 0-0<br>G5-4-3<br>1B              |                              | 0-0<br>G6-4-3<br>1-2f<br>2-3    |                              | 4                               | 0                            | 2                               | 2                            | 0                               | 0                            | 2                               |                                  |                                    |                                  |        |  |
| Rocky Colavito, R<br>OBP: 0.367, SLG: 0.545 (1, 9)    | 0-0<br>F6                    |                                 | 0-3<br>K                     |                                 |                              | 0-0<br>G5-4-3<br>1-2f<br>2-3     |                              | 0-0<br>1-3                      |                              | 4                               | 0                            | 0                               | 0                            | 0                               | 1                            | 4                               |                                  |                                    |                                  |        |  |
| Jim Gentile, L<br>OBP: 0.384, SLG: 0.489 (1, 3)       |                              | 0-3<br>K                        |                              | 0-0<br>4-3                      |                              | 1-0<br>HBP                       |                              | 0-0<br>4-3<br>2B                |                              | 3                               | 0                            | 1                               | 0                            | 0                               | 1                            | 0                               |                                  |                                    |                                  |        |  |
| Jose Tartabull, L<br>OBP: 0.259, SLG: 0.250 (9, PR)   |                              |                                 |                              |                                 |                              |                                  |                              |                                 |                              | 0                               | 0                            | 0                               | 0                            | 0                               | 0                            | 0                               |                                  |                                    |                                  |        |  |
| Ken Harrelson, R<br>OBP: 0.279, SLG: 0.422 (1, 7)     |                              | 0-3<br>K                        |                              | 0-0<br>5-3                      |                              | 0-3<br>K                         |                              | 0-0<br>4-3<br>2-3               |                              | 4                               | 0                            | 0                               | 0                            | 0                               | 2                            | 3                               |                                  |                                    |                                  |        |  |
| Doc Edwards, R<br>OBP: 0.247, SLG: 0.273 (1, 2)       |                              |                                 |                              |                                 |                              |                                  |                              |                                 |                              | 2                               | 0                            | 0                               | 0                            | 0                               | 0                            | 0                               |                                  |                                    |                                  |        |  |
| Dave Duncan, R<br>OBP: 0.143, SLG: 0.143 (5, 2)       |                              | 0-0<br>F8                       |                              | 0-0<br>F4                       |                              |                                  |                              | 0-3<br>K                        |                              | 2                               | 0                            | 0                               | 0                            | 0                               | 1                            | 2                               |                                  |                                    |                                  |        |  |
| Ed Charles, R<br>OBP: 0.319, SLG: 0.361 (1, 5)        |                              |                                 | 0-3<br>K                     |                                 | 0-0<br>6-3                   |                                  | 0-0<br>5-3                   | 0-0<br>F9                       |                              | 4                               | 0                            | 0                               | 0                            | 0                               | 1                            | 2                               |                                  |                                    |                                  |        |  |
| Charlie Shoemaker, L<br>OBP: 0.178, SLG: 0.267 (1, 4) |                              |                                 | 0-0<br>6-3                   |                                 | 0-0<br>5-3                   |                                  | 0-3<br>K                     |                                 |                              | 3                               | 0                            | 0                               | 0                            | 0                               | 1                            | 0                               |                                  |                                    |                                  |        |  |
| Moe Drabowsky, R<br>OBP: 0.029, SLG: 0.029 (1, 1)     |                              |                                 | 4-0<br>1B<br>1B<br>BB        |                                 | 0-3<br>K                     |                                  |                              | 0-0<br>G6-4-3<br>BB<br>1B       |                              | 0                               | 0                            | 0                               | 0                            | 0                               | 0                            | 0                               |                                  |                                    |                                  |        |  |
| Dan Pfister, R (1, 1)                                 |                              |                                 |                              |                                 |                              |                                  |                              |                                 |                              | 0                               | 1                            | 0                               | 0                            | 1                               | 0                            | 0                               |                                  |                                    |                                  |        |  |
| Orlando Pena, R<br>OBP: 0.176, SLG: 0.204 (5, 1)      |                              |                                 |                              |                                 |                              |                                  |                              |                                 |                              | 2                               | 0                            | 1                               | 0                            | 0                               | 1                            | 0                               |                                  |                                    |                                  |        |  |
| <b>Inning Stats</b>                                   | R: 0<br>E: 0<br>K: 0<br>S: 3 | H: 0<br>LOB: 0<br>BB: 0<br>P: 3 | R: 0<br>E: 0<br>K: 2<br>S: 7 | H: 0<br>LOB: 0<br>BB: 0<br>P: 7 | R: 2<br>E: 0<br>K: 2<br>S: 9 | H: 2<br>LOB: 1<br>BB: 1<br>P: 13 | R: 0<br>E: 0<br>K: 0<br>S: 3 | H: 0<br>LOB: 0<br>BB: 0<br>P: 3 | R: 0<br>E: 0<br>K: 1<br>S: 5 | H: 0<br>LOB: 0<br>BB: 0<br>P: 5 | R: 0<br>E: 0<br>K: 2<br>S: 7 | H: 0<br>LOB: 0<br>BB: 0<br>P: 7 | R: 0<br>E: 0<br>K: 0<br>S: 3 | H: 1<br>LOB: 1<br>BB: 1<br>P: 7 | R: 0<br>E: 0<br>K: 0<br>S: 4 | H: 1<br>LOB: 2<br>BB: 0<br>P: 4 | 1B: 4<br>2B: 1<br>3B: 0<br>HR: 0 | SF: 0<br>SAC: 0<br>DP: 2<br>HBP: 1 | WP: 0<br>PB: 1<br>SB: 0<br>CS: 0 | PA: 34 |  |
| <b>PITCHER</b><br>Bo Belinsky, L<br>ERA: 2.71 (1, 1)  | IP<br>9.0                    | WLS<br>W                        | BF<br>34                     | H<br>5                          | R<br>2                       | ER<br>2                          | SO<br>8                      | BB<br>3                         | IBB<br>0                     | HBP<br>1                        | BLK<br>0                     | WP<br>0                         | HR<br>0                      | S<br>46                         | P<br>59                      | ERA<br>2.00                     | WHIP<br>0.889                    |                                    |                                  |        |  |
| <b>PITCHER</b>  | IP                           | WLS                             | BF                           | H                               | R                            | ER                               | SO                           | BB                              | IBB                          | HBP                             | BLK                          | WP                              | HR                           | S                               | P                            | ERA                             | WHIP                             |                                    |                                  |        |  |

**BOTTOM**

Los Angeles Angels @ Kansas City Athletics  
Municipal Stadium, Kansas City, MO  
Sat Jul 25 1964, 4:33 AM EDT  
Att. 14,515 - Unknown

[livebaseballscorecards.com](http://livebaseballscorecards.com)

|            |           |
|------------|-----------|
| <b>AB</b>  | <b>30</b> |
| <b>R</b>   | <b>2</b>  |
| <b>H</b>   | <b>5</b>  |
| <b>RBI</b> | <b>2</b>  |
| <b>BB</b>  | <b>3</b>  |
| <b>SO</b>  | <b>8</b>  |
| <b>LOB</b> | <b>13</b> |



| Batter  | 1   | 2                               | 3                            | 4                                | 5                            | 6                               | 7                            | 8                                | 9                            | AB R H RBI BB SO LOB                            | TOP  |                                 |                              |                                 |                              |                                 |                              |                                 |                                  |                                    |                                  |        |
|---|---|---------------------------------|------------------------------|----------------------------------|------------------------------|---------------------------------|------------------------------|----------------------------------|------------------------------|---|--|---------------------------------|------------------------------|---------------------------------|------------------------------|---------------------------------|------------------------------|---------------------------------|----------------------------------|------------------------------------|----------------------------------|--------|
| Bob Perry, R (1, 8)<br>OBP: 0.343, SLG: 0.419   | 0-0<br>WP<br>E<br>4-3<br>1B                           |                                 | 0-0<br>F3                    |                                  | 0-0<br>4-3                   |                                 | 0-3<br>K                     |                                  |                              | 4 1 1 0 0 1 0                                   | <p>Los Angeles Angels @ Kansas City Athletics<br/>Municipal Stadium, Kansas City, MO</p> <p>Sun Jul 26 1964, 4:33 AM EDT<br/>Unknown</p> |                                 |                              |                                 |                              |                                 |                              |                                 |                                  |                                    |                                  |        |
| Vic Power, R (1, 3)<br>OBP: 0.260, SLG: 0.302   | 0-0<br>4-3<br>1-2                                     |                                 | 0-0<br>F6                    |                                  | 0-0<br>F5                    |                                 |                              | 0-0<br>F8                        |                              | 4 0 0 0 0 0 1                                   |  |                                 |                              |                                 |                              |                                 |                              |                                 |                                  |                                    |                                  |        |
| Jim Fregosi, R (1, 6)<br>OBP: 0.404, SLG: 0.527   | 0-0<br>E9<br>SF9<br>2-H<br>2B                         |                                 | 0-3<br>K                     |                                  | 0-0<br>F4                    |                                 |                              | 0-0<br>F8                        |                              | 4 1 1 1 0 1 0                                   |  |                                 |                              |                                 |                              |                                 |                              |                                 |                                  |                                    |                                  |        |
| Willie Smith, L (1, 7)<br>OBP: 0.315, SLG: 0.500  | 0-0<br>SF9<br>3-H                                     |                                 |                              | 0-0<br>F6                        |                              | 0-0<br>CS<br>1B                 |                              | 0-0<br>F8                        |                              | 3 0 1 1 0 0 0                                   |  |                                 |                              |                                 |                              |                                 |                              |                                 |                                  |                                    |                                  |        |
| Buck Rodgers, S (1, 2)<br>OBP: 0.305, SLG: 0.320  | 0-0<br>F8   |                                 |                              | 0-0<br>E<br>S<br>1B              |                              | 0-0<br>1-2<br>1B                |                              | 0-0<br>F9                        |                              | 4 1 2 0 0 0 0                                   |  |                                 |                              |                                 |                              |                                 |                              |                                 |                                  |                                    |                                  |        |
| Felix Torres, R (1, 5)<br>OBP: 0.255, SLG: 0.417  |   | 4-0<br>BB                       |                              | 0-3<br>K<br>1-2                  |                              | 0-0<br>L4                       |                              | 0-0<br>F8                        |                              | 3 0 0 0 1 1 2                                   |  |                                 |                              |                                 |                              |                                 |                              |                                 |                                  |                                    |                                  |        |
| Lou Clinton, R (1, 9)<br>OBP: 0.297, SLG: 0.400   |   | 0-3<br>K                        |                              | 0-0<br>E7<br>2-H<br>1B           |                              | 0-0<br>F8                       |                              | 0-0<br>F7                        |                              | 4 0 1 1 0 1 2                                   |  |                                 |                              |                                 |                              |                                 |                              |                                 |                                  |                                    |                                  |        |
| Bobby Knoop, R (1, 4)<br>OBP: 0.312, SLG: 0.292   |   | 0-3<br>K                        |                              | 4-0<br>IBB                       |                              |                                 | 0-0<br>F6                    |                                  |                              | 2 0 0 0 1 1 1                                   |  |                                 |                              |                                 |                              |                                 |                              |                                 |                                  |                                    |                                  |        |
| Aubrey Gatewood, R (1, 1)<br>OBP: 0.143, SLG: 0.143<br>Ed Kirkpatrick, L (7, PH)<br>OBP: 0.316, SLG: 0.361<br>Bob Lee, R (7, 1) |   | 0-3<br>K                        |                              | 0-0<br>F9                        |                              |                                 | 0-3<br>K                     |                                  |                              | 2 0 0 0 0 1 3<br>1 0 0 0 0 1 0<br>0 0 0 0 0 0 0 |  |                                 |                              |                                 |                              |                                 |                              |                                 |                                  |                                    |                                  |        |
| <b>Inning Stats</b>   | R: 2<br>E: 1<br>K: 0<br>S: 5                          | H: 2<br>LOB: 0<br>BB: 0<br>P: 5 | R: 0<br>E: 0<br>K: 3<br>S: 9 | H: 0<br>LOB: 1<br>BB: 1<br>P: 13 | R: 0<br>E: 0<br>K: 1<br>S: 5 | H: 0<br>LOB: 0<br>BB: 0<br>P: 5 | R: 1<br>E: 1<br>K: 1<br>S: 7 | H: 2<br>LOB: 2<br>BB: 1<br>P: 11 | R: 0<br>E: 0<br>K: 0<br>S: 4 | H: 2<br>LOB: 1<br>BB: 0<br>P: 4                 | R: 0<br>E: 0<br>K: 2<br>S: 7   | H: 0<br>LOB: 0<br>BB: 0<br>P: 7 | R: 0<br>E: 0<br>K: 0<br>S: 3 | H: 0<br>LOB: 0<br>BB: 0<br>P: 3 | R: 0<br>E: 0<br>K: 0<br>S: 3 | H: 0<br>LOB: 0<br>BB: 0<br>P: 3 | R: 0<br>E: 0<br>K: 0<br>S: 3 | H: 0<br>LOB: 0<br>BB: 0<br>P: 3 | 1B: 5<br>2B: 1<br>3B: 0<br>HR: 0 | SF: 1<br>SAC: 0<br>DP: 0<br>HBP: 0 | WP: 1<br>PB: 0<br>SB: 1<br>CS: 1 | PA: 34 |
| <b>PITCHER</b>  | IP WLS BF H R ER SO BB IBB HBP BLK WP HR S P ERA WHIP |                                 |                              |                                  |                              |                                 |                              |                                  |                              |   |  |                                 |                              |                                 |                              |                                 |                              |                                 |                                  |                                    |                                  |        |
| Jose Santiago, R (1, 1)<br>ERA: 4.85  | 4.0 L 18 4 3 2 5 1 1 0 0 1 0 26 34 4.50 1.250         |                                 |                              |                                  |                              |                                 |                              |                                  |                              |   |  |                                 |                              |                                 |                              |                                 |                              |                                 |                                  |                                    |                                  |        |
| Wes Stock, R (5, 1)<br>ERA: 2.39  | 3.0 10 2 0 0 2 0 0 0 0 0 0 14 14 0.00 0.667           |                                 |                              |                                  |                              |                                 |                              |                                  |                              |   |  |                                 |                              |                                 |                              |                                 |                              |                                 |                                  |                                    |                                  |        |
| John Wyatt, R (8, 1)<br>ERA: 3.54   | 2.0 6 0 0 0 0 0 0 0 0 0 0 6 6 0.00 0.000              |                                 |                              |                                  |                              |                                 |                              |                                  |                              |   |  |                                 |                              |                                 |                              |                                 |                              |                                 |                                  |                                    |                                  |        |

livebaseballscorecards.com

|     |    |
|-----|----|
| AB  | 31 |
| R   | 3  |
| H   | 6  |
| RBI | 3  |
| BB  | 2  |
| SO  | 7  |
| LOB | 9  |



| Batter  | 1      | 2          | 3            | 4       | 5         | 6      | 7          | 8      | 9     | AB | R | H | RBI | BB | SO | LOB |
|---|--------|------------|--------------|---------|-----------|--------|------------|--------|-------|----|---|---|-----|----|----|-----|
| Bert Campaneris, R (1, 6)<br>OBP: 0.647, SLG: 1.000   | 0-0 F7 |            | 0-0 BB 1B    |         | 0-0 WP 1B |        | 0-0 1-2 1B |        |       | 4  | 0 | 3 | 0   | 0  | 0  | 0   |
| Nelson Mathews, R (1, 8)<br>OBP: 0.284, SLG: 0.336    | 0-0 F8 |            | 0-0 F7       |         | 0-3 K     |        | 0-0 F2     |        |       | 4  | 0 | 0 | 0   | 0  | 1  | 4   |
| Rocky Colavito, R (1, 9)<br>OBP: 0.368, SLG: 0.547    | 0-0 2B |            | 0-0 BB 1B    |         | 0-0 F5    |        | 0-3 K      |        |       | 4  | 0 | 2 | 0   | 0  | 1  | 3   |
| Jim Gentile, L (1, 3)<br>OBP: 0.382, SLG: 0.483       | 0-3 K  |            | 4-0 FC6-4 BB |         | 0-0 2-3   |        |            | 0-0 F7 |       | 3  | 0 | 0 | 0   | 1  | 1  | 2   |
| Ken Harrelson, R (1, 7)<br>OBP: 0.278, SLG: 0.412     |        | 0-0 5-3 1B | 0-0 FC6-4    |         | 0-0 F7    |        |            | 0-0 F8 |       | 4  | 0 | 1 | 0   | 0  | 0  | 3   |
| Billy Bryan, L (1, 2)<br>OBP: 0.301, SLG: 0.514       |        | 0-0 F6     |              | 0-0 F8  |           | 0-3 K  |            | 0-0 F9 |       | 4  | 0 | 0 | 0   | 0  | 1  | 1   |
| Ed Charles, R (1, 5)<br>OBP: 0.316, SLG: 0.358        |        | 0-0 5-3    |              | 0-0 5-3 |           | 0-0 F9 |            |        | 0-3 K | 3  | 0 | 0 | 0   | 0  | 0  | 1   |
| John Wyatt, R (8, 1)                                  |        | 1-2        |              |         |           |        |            |        |       | 0  | 0 | 0 | 0   | 0  | 0  | 0   |
| Jose Tartabull, L (9, PH)<br>OBP: 0.254, SLG: 0.246   |        |            |              |         |           |        |            |        |       | 1  | 0 | 0 | 0   | 0  | 1  | 0   |
| Charlie Shoemaker, L (1, 4)<br>OBP: 0.184, SLG: 0.306 |        | 0-0 F8     |              | 0-0 3B  |           | 0-3 K  |            | 0-3 K  |       | 4  | 0 | 1 | 0   | 0  | 2  | 1   |
| Jose Santiago, R (1, 1)                               |        |            | 0-3 K        |         | 0-0 F8    |        |            |        | 0-3 K | 1  | 0 | 0 | 0   | 0  | 1  | 0   |
| Manny Jimenez, L (4, PH)<br>OBP: 0.294, SLG: 0.531    |        |            |              |         |           |        |            |        |       | 1  | 0 | 0 | 0   | 0  | 0  | 1   |
| Wes Stock, R (5, 1)<br>OBP: 0.167, SLG: 0.091         |        |            |              |         |           |        |            |        |       | 0  | 0 | 0 | 0   | 0  | 0  | 0   |
| Wayne Causey, L (7, PH)<br>OBP: 0.393, SLG: 0.393     |        |            |              |         |           |        | 0-0 1B     |        |       | 2  | 0 | 1 | 0   | 0  | 1  | 0   |

| Inning Stats | R: 0 | H: 1 | E: 0 | LOB: 1 | K: 1 | S: 6 | P: 6 | R: 0 | H: 1 | E: 0 | LOB: 1 | K: 0 | S: 4 | R: 0 | H: 2 | E: 0 | LOB: 3 | K: 1 | S: 7 | R: 0 | H: 1 | E: 0 | LOB: 1 | K: 0 | S: 4 | R: 0 | H: 1 | E: 0 | LOB: 0 | K: 1 | S: 5 | R: 0 | H: 2 | E: 0 | LOB: 2 | K: 2 | S: 9 | R: 0 | H: 0 | E: 0 | LOB: 0 | K: 0 | S: 3 | R: 0 | H: 0 | E: 0 | LOB: 0 | K: 3 | S: 9 | R: 0 | H: 0 | E: 0 | LOB: 0 | K: 0 | S: 9 | 1B: 6 | SF: 0 | 2B: 1 | SAC: 0 | 3B: 1 | DP: 0 | HR: 0 | HBP: 0 | WP: 1 | PA: 36 | PB: 0 | SB: 0 | CS: 0 |
|--------------|------|------|------|--------|------|------|------|------|------|------|--------|------|------|------|------|------|--------|------|------|------|------|------|--------|------|------|------|------|------|--------|------|------|------|------|------|--------|------|------|------|------|------|--------|------|------|------|------|------|--------|------|------|------|------|------|--------|------|------|-------|-------|-------|--------|-------|-------|-------|--------|-------|--------|-------|-------|-------|
|--------------|------|------|------|--------|------|------|------|------|------|------|--------|------|------|------|------|------|--------|------|------|------|------|------|--------|------|------|------|------|------|--------|------|------|------|------|------|--------|------|------|------|------|------|--------|------|------|------|------|------|--------|------|------|------|------|------|--------|------|------|-------|-------|-------|--------|-------|-------|-------|--------|-------|--------|-------|-------|-------|

| PITCHER                                | IP  | WLS | BF | H | R | ER | SO | BB | IBB | HBP | BLK | WP | HR | S  | P  | ERA  | WHIP  |
|--|-----|-----|----|---|---|----|----|----|-----|-----|-----|----|----|----|----|------|-------|
| Aubrey Gatewood, R (1, 1)<br>ERA: 1.69 | 6.0 | W   | 25 | 6 | 0 | 0  | 4  | 1  | 0   | 0   | 0   | 1  | 0  | 32 | 36 | 0.00 | 1.167 |
| Bob Lee, R (7, 1)<br>ERA: 1.69         | 3.0 | S   | 11 | 2 | 0 | 0  | 5  | 0  | 0   | 0   | 0   | 0  | 0  | 21 | 21 | 0.00 | 0.667 |

**BOTTOM**

Los Angeles Angels @ Kansas City Athletics  
Municipal Stadium, Kansas City, MO

Sun Jul 26 1964, 4:33 AM EDT  
Unknown

|     |    |
|-----|----|
| AB  | 35 |
| R   | 0  |
| H   | 8  |
| RBI | 0  |
| BB  | 1  |
| SO  | 9  |
| LOB | 16 |



livebaseballscorecards.com

| Batter  | 1                            | 2                               | 3                            | 4                               | 5                            | 6                                | 7                            | 8                               | 9                            | 10                              | AB                           | R                               | H                            | RBI                             | BB                           | SO                              | LOB                              | TOP                                |                                  |        |
|---|------------------------------|---------------------------------|------------------------------|---------------------------------|------------------------------|----------------------------------|------------------------------|---------------------------------|------------------------------|---------------------------------|------------------------------|---------------------------------|------------------------------|---------------------------------|------------------------------|---------------------------------|----------------------------------|------------------------------------|----------------------------------|--------|
| <b>Bob Perry, R</b> (1, 8)<br>OBP: 0.336, SLG: 0.408  | 0-0<br>F9                    |                                 | 0-0<br>F8                    | 0-0<br>3-1                      |                              | 0-0<br>F8                        |                              | 0-0<br>FC6-4<br>1B              |                              | 0-0<br>6-3                      | 6                            | 0                               | 1                            | 1                               | 0                            | 0                               | 5                                |                                    |                                  |        |
| <b>Vic Power, R</b> (1, 3)<br>OBP: 0.250, SLG: 0.290  | 0-0<br>6-3                   |                                 | 0-0<br>F9                    |                                 | 0-0<br>F3                    |                                  | 0-0<br>F8                    | 0-0<br>FC6-4<br>1B              |                              | 0-0<br>E5                       | 6                            | 0                               | 0                            | 0                               | 0                            | 0                               | 2                                |                                    |                                  |        |
| <b>Jim Fregosi, R</b> (1, 6)<br>OBP: 0.403, SLG: 0.522  | 4-0<br>FC6-4<br>BB           |                                 | 0-0<br>1B                    |                                 | 0-0<br>F2                    |                                  | 0-0<br>F9                    |                                 | 0-0<br>F4                    | 0-0<br>6-3                      | 5                            | 0                               | 1                            | 0                               | 1                            | 0                               | 1                                |                                    |                                  |        |
| <b>Willie Smith, L</b> (1, 7)<br>OBP: 0.317, SLG: 0.494   | 0-0<br>FC6-4                 |                                 | 0-0<br>1B                    |                                 | 4-0<br>BB                    |                                  | 0-0<br>4-3                   |                                 | 0-0<br>F9                    |                                 | 4                            | 0                               | 1                            | 0                               | 1                            | 0                               | 1                                |                                    |                                  |        |
| <b>Felix Torres, R</b> (1, 5)<br>OBP: 0.266, SLG: 0.443   |                              | 0-0<br>FC6-4<br>1B              | 0-0<br>L6                    |                                 | 0-0<br>F8                    |                                  |                              | 0-0<br>HR                       | 0-0<br>FC5-4<br>1B           |                                 | 5                            | 1                               | 3                            | 1                               | 0                            | 0                               | 3                                |                                    |                                  |        |
| <b>Lou Clinton, R</b> (1, 9)<br>OBP: 0.296, SLG: 0.400  |                              | 0-0<br>F3                       |                              | 0-0<br>6-3<br>2B                |                              | 0-0<br>F8                        |                              | 0-0<br>F5                       | 0-0<br>FC5-4                 |                                 | 5                            | 0                               | 1                            | 0                               | 0                            | 0                               | 2                                |                                    |                                  |        |
| <b>Bobby Knoop, R</b> (1, 4)<br>OBP: 0.318, SLG: 0.300  |                              | 0-0<br>FC6-4<br>1B              |                              | 0-3<br>K                        |                              | 1-0<br>4-3<br>HBP                |                              | 0-0<br>1B<br>1B                 |                              | 0-0<br>E<br>2B                  | 4                            | 2                               | 3                            | 0                               | 0                            | 1                               | 1                                |                                    |                                  |        |
| <b>Tom Satriano, L</b> (1, 2)<br><b>Buck Rodgers, S</b> (6, PH)   |                              | 0-0<br>FC6-4                    |                              | 0-0<br>6-3                      |                              | 0-0<br>4-3                       |                              | 0-0<br>1B<br>1B                 |                              | 0-0<br>F2                       | 2                            | 0                               | 0                            | 0                               | 0                            | 0                               | 3                                |                                    |                                  |        |
| <b>Don Osinski, R</b><br><b>Barry Latham, R</b><br><b>Joe Adcock, R</b><br><b>Aubrey Gatewood, R</b><br><b>Bob Lee, R</b><br><b>Albie Pearson, L</b><br><b>Dean Chance, R</b><br><b>Ed King, R</b><br><b>Don Lee, R</b><br><b>Bob Duliba, R</b> |                              | 0-0<br>1-2<br>2-3               |                              | 0-0<br>1-3                      |                              | 4-0<br>BB                        |                              | 4-0<br>BB                       |                              | 0-0<br>E<br>1B                  | 3                            | 0                               | 1                            | 0                               | 0                            | 0                               | 2                                |                                    |                                  |        |
| <b>Inning Stats</b>   | R: 0<br>E: 0<br>K: 0<br>S: 3 | H: 0<br>LOB: 1<br>BB: 1<br>P: 7 | R: 0<br>E: 0<br>K: 0<br>S: 5 | H: 2<br>LOB: 2<br>BB: 0<br>P: 5 | R: 0<br>E: 0<br>K: 1<br>S: 5 | H: 2<br>LOB: 2<br>BB: 1<br>P: 10 | R: 0<br>E: 0<br>K: 1<br>S: 6 | H: 1<br>LOB: 2<br>BB: 1<br>P: 8 | R: 0<br>E: 0<br>K: 0<br>S: 3 | H: 0<br>LOB: 0<br>BB: 0<br>P: 3 | R: 2<br>E: 0<br>K: 0<br>S: 7 | H: 4<br>LOB: 2<br>BB: 0<br>P: 7 | R: 0<br>E: 0<br>K: 0<br>S: 4 | H: 1<br>LOB: 1<br>BB: 0<br>P: 4 | R: 2<br>E: 2<br>K: 0<br>S: 6 | H: 2<br>LOB: 1<br>BB: 0<br>P: 6 | 1B: 9<br>2B: 2<br>3B: 0<br>HR: 1 | SF: 0<br>SAC: 0<br>DP: 0<br>HBP: 1 | WP: 0<br>PB: 0<br>SB: 0<br>CS: 0 | PA: 48 |
| <b>PITCHER</b><br><b>Ted Bowsfield, L</b> (1, 1)<br>ERA: 4.01<br><b>Wes Stock, R</b> (6, 1)<br>ERA: 2.6<br><b>John Wyatt, R</b> (8, 1)<br>ERA: 3.53   | IP<br>5.2                    | WLS<br>26                       | BF<br>5                      | H<br>0                          | R<br>0                       | ER<br>0                          | SO<br>1                      | BB<br>3                         | IBB<br>0                     | HBP<br>1                        | BLK<br>0                     | WP<br>0                         | HR<br>0                      | S<br>24                         | P<br>37                      | ERA<br>0.00                     | WHIP<br>1.412                    |                                    |                                  |        |
|   | 1.2                          | 8                               | 2                            | 2                               | 2                            | 0                                | 1                            | 0                               | 0                            | 0                               | 0                            | 0                               | 1                            | 7                               | 11                           | 10.80                           | 1.800                            |                                    |                                  |        |
|   | 2.2                          | L 14                            | 5                            | 2                               | 1                            | 0                                | 0                            | 0                               | 0                            | 0                               | 0                            | 0                               | 0                            | 14                              | 14                           | 3.38                            | 1.875                            |                                    |                                  |        |

Los Angeles Angels @ Kansas City Athletics  
Municipal Stadium, Kansas City, MO  
Sun Jul 26 1964, 4:38 AM EDT  
Att: 9,763 - Unknown

livebaseballscorecards.com

|     |    |
|-----|----|
| AB  | 43 |
| R   | 4  |
| H   | 12 |
| RBI | 3  |
| BB  | 4  |
| SO  | 1  |
| LOB | 24 |





| Batter   | 1                            | 2                               | 3                            | 4                               | 5                            | 6                               | 7                            | 8                               | 9                            | 10                              | AB                           | R                               | H                            | RBI                             | BB                           | SO                              | LOB                          | BOTTOM   |                                  |                                    |                                  |        |
|--|------------------------------|---------------------------------|------------------------------|---------------------------------|------------------------------|---------------------------------|------------------------------|---------------------------------|------------------------------|---------------------------------|------------------------------|---------------------------------|------------------------------|---------------------------------|------------------------------|---------------------------------|------------------------------|--|----------------------------------|------------------------------------|----------------------------------|--------|
| <b>Bert Campaneris, R</b> (1, 6)<br>OBP: 0.545, SLG: 0.842   | 0-3<br>K                     |                                 | X 0-0<br>5-3                 |                                 | X 0-0<br>FC5<br>FC6-4        |                                 |                              | X 0-0<br>SH1-4<br>WP<br>2B      |                              | X 0-0<br>6-3                    | 5                            | 1                               | 1                            | 1                               | 0                            | 1                               | 3                            | <b>Los Angeles Angels @ Kansas City Athletics</b><br><b>Municipal Stadium, Kansas City, MO</b><br>Sun Jul 26 1964, 4:38 AM EDT<br>Att. 9,763 - Unknown |                                  |                                    |                                  |        |
| <b>Jose Tartabull, L</b> (1, 8)<br>OBP: 0.254, SLG: 0.246    | 0-0<br>1-3                   |                                 | X 0-0<br>F5                  |                                 | X 0-0<br>FC6-4               |                                 |                              | X 0-0<br>SH1-4                  |                              | X 0-0<br>3-H<br>BB<br>1B        | 4                            | 0                               | 1                            | 0                               | 0                            | 0                               | 3                            |  |                                  |                                    |                                  |        |
| <b>Rocky Colavito, R</b> (1, 9)<br>OBP: 0.369, SLG: 0.544    | 0-0<br>6-3                   |                                 |                              | X 0-0<br>G6-4-3<br>1B           |                              |                                 |                              | X 0-3<br>K                      |                              | B B B B<br>4-0<br>1-2<br>BB     | 4                            | 0                               | 1                            | 0                               | 1                            | 1                               | 0                            |  |                                  |                                    |                                  |        |
| <b>Dick Green, R</b> (10, PR)<br>OBP: 0.290, SLG: 0.406      |                              |                                 |                              |                                 |                              |                                 |                              | X 0-3<br>K                      |                              |                                 | 0                            | 0                               | 0                            | 0                               | 0                            | 0                               | 0                            |  |                                  |                                    |                                  |        |
| <b>Jim Gentile, L</b> (1, 3)<br>OBP: 0.379, SLG: 0.477       |                              | X 0-0<br>F5                     |                              | X 0-0<br>G6-4-3<br>1B           |                              |                                 | X 0-0<br>4-3                 |                                 |                              | X 0-0<br>F7                     | 5                            | 0                               | 1                            | 0                               | 0                            | 1                               | 2                            |  |                                  |                                    |                                  |        |
| <b>George Alusik, R</b> (1, 7)<br>OBP: 0.366, SLG: 0.378     | 0-3<br>K                     |                                 | X 0-0<br>G6-4-3<br>1B        |                                 | X 0-0<br>G6-4-3              |                                 | X 0-0<br>F9                  |                                 |                              | X 0-3<br>K                      | 3                            | 0                               | 0                            | 0                               | 0                            | 1                               | 2                            |  |                                  |                                    |                                  |        |
| <b>Nelson Mathews, R</b> (7, 8)<br>OBP: 0.283, SLG: 0.335    |                              |                                 |                              |                                 |                              |                                 |                              | X 0-0<br>F8                     |                              | X 0-0<br>F3                     | 1                            | 0                               | 0                            | 0                               | 0                            | 1                               | 0                            |  |                                  |                                    |                                  |        |
| <b>Doc Edwards, R</b> (1, 2)<br>OBP: 0.247, SLG: 0.290       |                              | X 0-0<br>HR                     |                              |                                 |                              |                                 |                              | X 0-0<br>F9                     |                              | X 0-0<br>6-3                    | 4                            | 1                               | 1                            | 1                               | 0                            | 1                               | 1                            |  |                                  |                                    |                                  |        |
| <b>Ed Charles, R</b> (1, 5)<br>OBP: 0.316, SLG: 0.357        |                              |                                 | X 0-0<br>6-3                 |                                 | X 0-0<br>FC4-6<br>1B         |                                 |                              | X 0-0<br>F9                     |                              | X 0-0<br>6-3                    | 4                            | 0                               | 1                            | 0                               | 0                            | 0                               | 0                            |  |                                  |                                    |                                  |        |
| <b>Charlie Shoemaker, L</b> (1, 4)<br>OBP: 0.212, SLG: 0.327 |                              |                                 |                              |                                 | X 0-0<br>SH1-3<br>1B         |                                 |                              | X 0-0<br>FC4-6<br>FC5<br>1B     |                              | X 0-0<br>4-3<br>6-3<br>2B       | 3                            | 0                               | 2                            | 0                               | 0                            | 0                               | 1                            |  |                                  |                                    |                                  |        |
| <b>Wayne Causey, L</b> (10, PH)<br>OBP: 0.395, SLG: 0.397    |                              |                                 |                              |                                 |                              |                                 |                              | X 0-3<br>K                      |                              | X 0-0<br>4-3                    | 1                            | 1                               | 1                            | 0                               | 0                            | 0                               | 0                            |  |                                  |                                    |                                  |        |
| <b>Ted Bowsfield, R</b> (1, 1)<br>OBP: 0.111, SLG: 0.059     |                              |                                 | X 0-0<br>SH1-3               |                                 | X 0-0<br>FC5<br>1B           |                                 |                              | X 0-3<br>K                      |                              | X 0-0<br>4-3                    | 1                            | 0                               | 1                            | 0                               | 0                            | 0                               | 0                            |  |                                  |                                    |                                  |        |
| <b>Wes Stock, R</b> (6, 1)<br>OBP: 0.154, SLG: 0.083         |                              |                                 |                              |                                 |                              |                                 |                              |                                 |                              |                                 | 1                            | 0                               | 0                            | 0                               | 0                            | 1                               | 1                            |  |                                  |                                    |                                  |        |
| <b>John Wyatt, R</b> (8, 1)<br>OBP: 0.154, SLG: 0.083        |                              |                                 |                              |                                 |                              |                                 |                              |                                 |                              |                                 | 0                            | 0                               | 0                            | 0                               | 0                            | 0                               | 0                            |  |                                  |                                    |                                  |        |
| <b>Manny Jimenez, L</b> (10, PH)<br>OBP: 0.292, SLG: 0.527   |                              |                                 |                              |                                 |                              |                                 |                              |                                 |                              | X 0-0<br>2-3                    | 1                            | 0                               | 0                            | 0                               | 0                            | 0                               | 1                            |  |                                  |                                    |                                  |        |
| <b>Inning Stats</b>  | R: 0<br>E: 0<br>K: 1<br>S: 5 | H: 0<br>LOB: 0<br>BB: 0<br>P: 5 | R: 1<br>E: 0<br>K: 1<br>S: 6 | H: 1<br>LOB: 1<br>BB: 0<br>P: 6 | R: 0<br>E: 0<br>K: 0<br>S: 4 | H: 1<br>LOB: 1<br>BB: 0<br>P: 4 | R: 0<br>E: 0<br>K: 1<br>S: 6 | H: 2<br>LOB: 1<br>BB: 0<br>P: 6 | R: 0<br>E: 0<br>K: 0<br>S: 3 | H: 0<br>LOB: 0<br>BB: 0<br>P: 3 | R: 0<br>E: 0<br>K: 1<br>S: 6 | H: 1<br>LOB: 1<br>BB: 0<br>P: 6 | R: 1<br>E: 0<br>K: 2<br>S: 8 | H: 1<br>LOB: 0<br>BB: 0<br>P: 8 | R: 0<br>E: 0<br>K: 1<br>S: 5 | H: 0<br>LOB: 0<br>BB: 0<br>P: 5 | R: 1<br>E: 0<br>K: 0<br>S: 5 | H: 2<br>LOB: 2<br>BB: 1<br>P: 9  | 1B: 7<br>2B: 2<br>3B: 0<br>HR: 1 | SF: 0<br>SAC: 2<br>DP: 1<br>HBP: 0 | WP: 1<br>PB: 0<br>SB: 0<br>CS: 0 | PA: 40 |
| <b>PITCHER</b>   | IP                           | WLS                             | BF                           | H                               | R                            | ER                              | SO                           | BB                              | IBB                          | HBP                             | BLK                          | WP                              | HR                           | S                               | P                            | ERA                             | WHIP                         |  |                                  |                                    |                                  |        |
| <b>Dan Osinski, R</b> (1, 1)<br>ERA: 4.45                    | 4.2                          |                                 | 19                           | 6                               | 1                            | 1                               | 3                            | 0                               | 0                            | 0                               | 0                            | 0                               | 1                            | 25                              | 25                           | 1.93                            | 1.286                        |  |                                  |                                    |                                  |        |
| <b>Barry Latman, R</b> (5, 1)<br>ERA: 3.91                   | 0.1                          |                                 | 1                            | 0                               | 0                            | 0                               | 0                            | 0                               | 0                            | 0                               | 0                            | 0                               | 0                            | 1                               | 1                            | 0.00                            | 0.000                        |  |                                  |                                    |                                  |        |
| <b>Bob Lee, R</b> (6, 1)<br>ERA: 1.65                        | 2.0                          |                                 | 7                            | 1                               | 0                            | 0                               | 1                            | 0                               | 0                            | 0                               | 0                            | 0                               | 0                            | 9                               | 9                            | 0.00                            | 0.500                        |  |                                  |                                    |                                  |        |
| <b>Dean Chance, R</b> (8, 1)<br>ERA: 1.77                    | 2.0                          | W                               | 7                            | 1                               | 1                            | 1                               | 3                            | 0                               | 0                            | 0                               | 0                            | 1                               | 0                            | 13                              | 13                           | 4.50                            | 0.500                        |  |                                  |                                    |                                  |        |
| <b>Don Lee, R</b> (10, 1)<br>ERA: 2.6                        | 0.0                          |                                 | 1                            | 1                               | 1                            | 1                               | 0                            | 0                               | 0                            | 0                               | 0                            | 0                               | 0                            | 1                               | 1                            | ∞                               | ∞                            |  |                                  |                                    |                                  |        |
| <b>PITCHER</b>   | IP                           | WLS                             | BF                           | H                               | R                            | ER                              | SO                           | BB                              | IBB                          | HBP                             | BLK                          | WP                              | HR                           | S                               | P                            | ERA                             | WHIP                         |  |                                  |                                    |                                  |        |
| <b>Bob Duliba, R</b> (10, 1)<br>ERA: 2.53                    | 1.0                          |                                 | 5                            | 1                               | 0                            | 0                               | 0                            | 1                               | 0                            | 0                               | 0                            | 0                               | 0                            | 4                               | 8                            | 0.00                            | 2.000                        |  |                                  |                                    |                                  |        |

livebaseballscorecards.com

**AB** 37  
**R** 3  
**H** 10  
**RBI** 2  
**BB** 1  
**SO** 7  
**LOB** 14

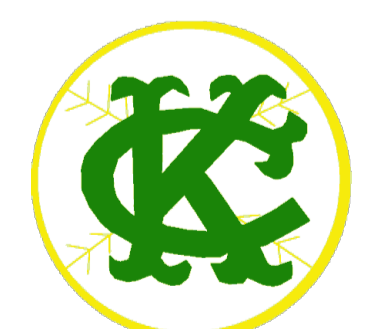

| Batter   | 1          | 2          | 3          | 4            | 5           | 6          | 7         | 8             | 9        | AB R H RBI BB SO LOB |
|--|------------|------------|------------|--------------|-------------|------------|-----------|---------------|----------|----------------------|
| Dalton Jones, L (1, 4)<br>OBP: 0.288, SLG: 0.359     | 0-0<br>F7  |            | 0-0<br>4-3 | 0-0<br>F7    |             |            | 0-0<br>E6 |               |          | 4 0 0 0 0 0 2        |
| Felix Mantilla, R (1, 9)<br>OBP: 0.354, SLG: 0.604   | 0-0<br>F8  |            | 0-0<br>HR  |              |             | 0-0<br>F6  | 0-3<br>K  |               |          | 4 1 1 1 0 1 1        |
| Carl Yastrzemski, L (1, 8)<br>OBP: 0.381, SLG: 0.479 | 0-0<br>6-3 |            | 0-0<br>1B  |              |             | 0-0<br>1B  |           | 0-0<br>1B     |          | 4 0 3 0 0 0 0        |
| Dick Stuart, R (1, 3)<br>OBP: 0.315, SLG: 0.515      |            | 4-0<br>BB  | 0-3<br>K   |              | 0-0<br>L4-3 |            |           | 0-0<br>G6-4-3 |          | 3 0 0 0 1 1 3        |
| Frank Malzone, R (1, 5)<br>OBP: 0.337, SLG: 0.416    |            | 1-0<br>HBP | 0-0<br>F4  |              |             | 0-0<br>5-3 |           | 0-0<br>1B     |          | 3 0 1 0 0 0 1        |
| Dick Williams, R (1, 7)<br>OBP: 0.270, SLG: 0.418    |            | 0-0<br>1-2 |            | 0-0<br>F3    |             | 0-0<br>6-3 |           | 0-0<br>FC6-4  |          | 4 0 0 0 0 0 3        |
| Eddie Bressoud, R (1, 6)<br>OBP: 0.373, SLG: 0.469   |            | 0-3<br>K   |            | 0-0<br>SH1-4 |             | 0-3<br>K   |           | 0-0<br>L3     |          | 4 0 1 0 0 2 2        |
| Bob Tillman, R (1, 2)<br>OBP: 0.361, SLG: 0.441      |            | 4-0<br>IBB |            | 0-0<br>SH1-4 |             | 0-3<br>K   |           | 0-3<br>K      |          | 3 0 1 0 1 2 0        |
| Dave Morehead, R (1, 1)<br>OBP: 0.136, SLG: 0.050    | 0-0<br>L8  |            |            | 0-0<br>SH1-4 |             |            | 0-3<br>K  |               | 0-3<br>K | 1 0 0 0 0 0 3        |
| Earl Wilson, R (7, PH)<br>OBP: 0.296, SLG: 0.520     |            |            |            |              |             |            |           |               |          | 1 0 0 0 0 1 0        |
| Jack Lamabe, R (7, 1)<br>OBP: 0.136, SLG: 0.143      |            |            |            |              |             |            |           |               |          | 0 0 0 0 0 0 0        |
| Russ Nixon, L (9, PH)<br>OBP: 0.341, SLG: 0.333      |            |            |            | 1-2<br>2-3   |             |            |           |               |          | 1 0 0 0 0 1 0        |

| Inning Stats | R: 0 | H: 0 | E: 0 | K: 0 | S: 3 | P: 3 | R: 0 | H: 0 | E: 0 | K: 1 | S: 5 | P: 14 | R: 1 | H: 2 | E: 0 | K: 1 | S: 7 | P: 7 | R: 0 | H: 2 | E: 0 | K: 0 | S: 5 | P: 5 | R: 0 | H: 1 | E: 0 | K: 1 | S: 3 | P: 3 | R: 0 | H: 0 | E: 0 | K: 1 | S: 5 | P: 5 | R: 0 | H: 0 | E: 0 | K: 3 | S: 10 | P: 10 | R: 0 | H: 2 | E: 0 | K: 0 | S: 4 | P: 4 | R: 0 | H: 0 | E: 0 | K: 2 | S: 7 | P: 7 | 1B: 6 | SF: 0 | 2B: 1 | SAC: 1 | 3B: 0 | DP: 2 | HR: 1 | HBP: 1 | WP: 0 | PA: 36 |
|--------------|------|------|------|------|------|------|------|------|------|------|------|-------|------|------|------|------|------|------|------|------|------|------|------|------|------|------|------|------|------|------|------|------|------|------|------|------|------|------|------|------|-------|-------|------|------|------|------|------|------|------|------|------|------|------|------|-------|-------|-------|--------|-------|-------|-------|--------|-------|--------|
|--------------|------|------|------|------|------|------|------|------|------|------|------|-------|------|------|------|------|------|------|------|------|------|------|------|------|------|------|------|------|------|------|------|------|------|------|------|------|------|------|------|------|-------|-------|------|------|------|------|------|------|------|------|------|------|------|------|-------|-------|-------|--------|-------|-------|-------|--------|-------|--------|

| PITCHER                             | IP  | WLS | BF | H | R | ER | SO | BB | IBB | HBP | BLK | WP | HR | S  | P  | ERA  | WHIP  |
|-------------------------------------|-----|-----|----|---|---|----|----|----|-----|-----|-----|----|----|----|----|------|-------|
| Orlando Pena, R (1, 1)<br>ERA: 4.54 | 9.0 | W   | 36 | 7 | 1 | 1  | 8  | 1  | 1   | 1   | 0   | 0  | 1  | 49 | 58 | 1.00 | 0.889 |

**TOP**

**Boston Red Sox @ Kansas City Athletics**  
**Municipal Stadium, Kansas City, MO**

Tue Jul 28 1964, 8:05 PM EDT  
Att. 6,121 - Unknown

livebaseballscorecards.com

|            |           |
|------------|-----------|
| <b>AB</b>  | <b>32</b> |
| <b>R</b>   | <b>1</b>  |
| <b>H</b>   | <b>7</b>  |
| <b>RBI</b> | <b>1</b>  |
| <b>BB</b>  | <b>2</b>  |
| <b>SO</b>  | <b>8</b>  |
| <b>LOB</b> | <b>15</b> |





| Batter   | 1  | 2                               | 3                            | 4                               | 5                            | 6                               | 7                            | 8                               | 9                            | AB R H RBI BB SO LOB            | TOP                          |                                  |                              |                                 |                              |                                 |                                  |                                    |                                  |        |
|--|--|---------------------------------|------------------------------|---------------------------------|------------------------------|---------------------------------|------------------------------|---------------------------------|------------------------------|---------------------------------|------------------------------|----------------------------------|------------------------------|---------------------------------|------------------------------|---------------------------------|----------------------------------|------------------------------------|----------------------------------|--------|
| Dalton Jones, L (1, 4)<br>OBP: 0.286, SLG: 0.356     | 0-0<br>F9  |                                 | 0-3<br>K                     |                                 | 0-0<br>1B                    |                                 | 0-0<br>4-3                   |                                 | 0-0<br>F3                    | 5 0 1 0 0 1 4                   |                              |                                  |                              |                                 |                              |                                 |                                  |                                    |                                  |        |
| Felix Mantilla, R (1, 9)<br>OBP: 0.348, SLG: 0.592   | 0-3<br>K   |                                 | 0-0<br>G6-4-3                |                                 | 0-3<br>K                     |                                 |                              | 0-3<br>K                        |                              | 4 0 0 0 0 3 2                   |                              |                                  |                              |                                 |                              |                                 |                                  |                                    |                                  |        |
| Carl Yastrzemski, L (1, 8)<br>OBP: 0.383, SLG: 0.490 | 0-3<br>K   |                                 |                              | 0-0<br>E<br>2B                  |                              | 0-0<br>F7                       |                              | 0-0<br>HR                       |                              | 4 2 2 1 0 1 0                   |                              |                                  |                              |                                 |                              |                                 |                                  |                                    |                                  |        |
| Dick Stuart, R (1, 3)<br>OBP: 0.316, SLG: 0.515      |  | 0-0<br>E6<br>5-3                |                              | 0-0<br>F3                       |                              | 0-0<br>1B                       |                              | 0-0<br>G5-4-3<br>1B             |                              | 4 0 2 0 0 0 1                   |                              |                                  |                              |                                 |                              |                                 |                                  |                                    |                                  |        |
| Frank Malzone, R (1, 5)<br>OBP: 0.333, SLG: 0.411    |  | 0-0<br>5-3                      |                              | 0-0<br>L8                       |                              | 0-0<br>6-3                      |                              | 0-0<br>G5-4-3                   |                              | 4 0 0 0 0 0 3                   |                              |                                  |                              |                                 |                              |                                 |                                  |                                    |                                  |        |
| Dick Williams, R (1, 7)<br>OBP: 0.254, SLG: 0.390    |  | 0-0<br>5-3                      |                              | 0-0<br>E3<br>2-H                |                              |                                 | 0-3<br>K                     |                                 | 0-0<br>L7                    | 4 0 0 0 0 1 1                   |                              |                                  |                              |                                 |                              |                                 |                                  |                                    |                                  |        |
| Eddie Bressoud, R (1, 6)<br>OBP: 0.372, SLG: 0.466   |  | 0-0<br>E4<br>2-3                |                              | 0-0<br>5-3                      |                              |                                 | 0-0<br>F8                    |                                 | 4-0<br>E<br>BB               | 3 1 0 0 1 0 2                   |                              |                                  |                              |                                 |                              |                                 |                                  |                                    |                                  |        |
| Bob Tillman, R (1, 2)<br>OBP: 0.359, SLG: 0.438      |  | 0-0<br>F5                       |                              |                                 | 0-0<br>5-3                   |                                 | 0-0<br>BB<br>1B              |                                 | 0-0<br>E5<br>SH3-4<br>1-H    | 4 0 1 0 0 0 2                   |                              |                                  |                              |                                 |                              |                                 |                                  |                                    |                                  |        |
| Bob Heffner, R (1, 1)<br>OBP: 0.227, SLG: 0.364      |  |                                 | 0-0<br>E5<br>G6-4-3          |                                 | 0-3<br>K                     |                                 | 4-0<br>BB<br>1-2             |                                 | 0-0<br>SH3-4                 | 2 0 0 0 0 1 0                   |                              |                                  |                              |                                 |                              |                                 |                                  |                                    |                                  |        |
| Earl Wilson, R (7, PH)<br>OBP: 0.309, SLG: 0.520     |  |                                 |                              |                                 |                              |                                 |                              |                                 |                              | 0 0 0 0 1 0 0                   |                              |                                  |                              |                                 |                              |                                 |                                  |                                    |                                  |        |
| Dick Radatz, R (7, 1)<br>OBP: 0.222, SLG: 0.231      |  |                                 |                              |                                 |                              |                                 |                              |                                 |                              | 0 0 0 0 0 0 0                   |                              |                                  |                              |                                 |                              |                                 |                                  |                                    |                                  |        |
| <b>Inning Stats</b>                                  | R: 0<br>E: 0<br>K: 2<br>S: 7   | H: 0<br>LOB: 0<br>BB: 0<br>P: 7 | R: 0<br>E: 2<br>K: 0<br>S: 5 | H: 0<br>LOB: 2<br>BB: 0<br>P: 5 | R: 0<br>E: 1<br>K: 1<br>S: 5 | H: 0<br>LOB: 0<br>BB: 0<br>P: 5 | R: 1<br>E: 1<br>K: 0<br>S: 5 | H: 1<br>LOB: 1<br>BB: 0<br>P: 5 | R: 0<br>E: 0<br>K: 2<br>S: 8 | H: 1<br>LOB: 1<br>BB: 0<br>P: 8 | R: 0<br>E: 0<br>K: 1<br>S: 6 | H: 1<br>LOB: 2<br>BB: 1<br>P: 10 | R: 1<br>E: 0<br>K: 1<br>S: 6 | H: 2<br>LOB: 0<br>BB: 0<br>P: 6 | R: 1<br>E: 2<br>K: 0<br>S: 4 | H: 0<br>LOB: 1<br>BB: 1<br>P: 8 | 1B: 4<br>2B: 1<br>3B: 0<br>HR: 1 | SF: 0<br>SAC: 1<br>DP: 2<br>HBP: 0 | WP: 0<br>PB: 0<br>SB: 0<br>CS: 0 | PA: 37 |
| <b>PITCHER</b><br>Diego Segui, R (1, 1)<br>ERA: 3.68 | IP: 9.0<br>WLS: L<br>BF: 37<br>H: 6<br>R: 3<br>ER: 1<br>SO: 7<br>BB: 2<br>IBB: 0<br>HBP: 0<br>BLK: 0<br>WP: 0<br>HR: 1<br>S: 49<br>P: 57<br>ERA: 1.00<br>WHIP: 0.889 |                                 |                              |                                 |                              |                                 |                              |                                 |                              |                                 |                              |                                  |                              |                                 |                              |                                 |                                  |                                    |                                  |        |
| <b>PITCHER</b>                                       | IP: 9.0<br>WLS: L<br>BF: 37<br>H: 6<br>R: 3<br>ER: 1<br>SO: 7<br>BB: 2<br>IBB: 0<br>HBP: 0<br>BLK: 0<br>WP: 0<br>HR: 1<br>S: 49<br>P: 57<br>ERA: 1.00<br>WHIP: 0.889 |                                 |                              |                                 |                              |                                 |                              |                                 |                              |                                 |                              |                                  |                              |                                 |                              |                                 |                                  |                                    |                                  |        |

**Boston Red Sox @ Kansas City Athletics**  
**Municipal Stadium, Kansas City, MO**  
 Wed Jul 29 1964, 8:05 PM EDT  
 Att. 5,510 - Unknown

livebaseballscorecards.com

|            |    |
|------------|----|
| <b>AB</b>  | 34 |
| <b>R</b>   | 3  |
| <b>H</b>   | 6  |
| <b>RBI</b> | 1  |
| <b>BB</b>  | 2  |
| <b>SO</b>  | 7  |
| <b>LOB</b> | 15 |



| Batter  | 1        | 2           | 3          | 4        | 5            | 6          | 7          | 8          | 9          | AB R H RBI BB SO LOB |
|---|----------|-------------|------------|----------|--------------|------------|------------|------------|------------|----------------------|
| Dick Green, R (1, 4)<br>OBP: 0.294, SLG: 0.404      | 0-3 K ①  |             |            | 0-3 K ①  |              | X 0-0 1B   |            |            | 0-3 K ①    | 4 0 1 0 0 3 0        |
| Bert Campaneris, R (1, 5)<br>OBP: 0.433, SLG: 0.630 | 0-0 F6 ② |             |            | 0-3 K ②  |              | X 0-0 L9 ② |            |            | 0-0 L6 ②   | 4 0 0 0 0 1 1        |
| Wayne Causey, L (1, 6)<br>OBP: 0.392, SLG: 0.391    | 0-0 F7 ③ |             |            | 0-0 L7 ③ |              | X 0-0 F6 ③ |            |            | 4-0 BB ③   | 3 0 0 0 1 0 1        |
| Rocky Colavito, R (1, 9)<br>OBP: 0.366, SLG: 0.540  |          | X 0-0 6-3 ① |            |          | X 0-0 HR 2B  |            | X 0-0 L9 ① |            | X 0-0 F6 ③ | 4 1 1 0 0 0 1        |
| Jim Gentile, L (1, 3)<br>OBP: 0.374, SLG: 0.480     |          | X 0-0 F8 ②  |            |          | X 0-0 HR 2-H |            | 0-3 K ②    |            |            | 3 1 1 2 0 1 0        |
| Doc Edwards, R (1, 2)<br>OBP: 0.254, SLG: 0.301     |          | X 0-0 6-3 ③ |            |          | X 0-0 F3 ①   |            | 0-3 K ③    |            |            | 3 0 0 0 0 1 0        |
| Ken Harrelson, R (1, 7)<br>OBP: 0.269, SLG: 0.405   |          |             | X 0-0 F9 ① |          | 0-3 K ②      |            |            | X 0-0 F4 ① |            | 3 0 0 0 0 1 0        |
| Jose Tartabull, L (9, 7)<br>OBP: 0.254, SLG: 0.246  |          |             |            |          | 0-3 K ②      |            |            |            |            | 0 0 0 0 0 0 0        |
| Nelson Mathews, R (1, 8)<br>OBP: 0.280, SLG: 0.332  |          |             | 0-3 K ②    |          | X 0-0 F6 ③   |            |            | X 0-0 L4 ② |            | 3 0 0 0 0 1 0        |
| Diego Segui, R (1, 1)<br>OBP: 0.196, SLG: 0.241     |          |             | 0-3 K ③    |          |              | X 0-0 L7 ① |            | 0-3 K ③    |            | 3 0 0 0 0 2 0        |

| Inning Stats | R: 0 | H: 0 | E: 0 | K: 1 | S: 5 | LOB: 0 | BB: 0 | P: 5 | R: 0 | H: 0 | E: 0 | K: 0 | S: 3 | LOB: 0 | BB: 0 | P: 3 | R: 0 | H: 0 | E: 0 | K: 2 | S: 7 | LOB: 0 | BB: 0 | P: 7 | R: 2 | H: 2 | E: 0 | K: 1 | S: 7 | LOB: 0 | BB: 0 | P: 7 | R: 0 | H: 1 | E: 0 | K: 0 | S: 4 | LOB: 1 | BB: 0 | P: 4 | R: 0 | H: 0 | E: 0 | K: 2 | S: 7 | LOB: 0 | BB: 0 | P: 7 | R: 0 | H: 0 | E: 0 | K: 1 | S: 5 | LOB: 0 | BB: 0 | P: 5 | R: 0 | H: 0 | E: 0 | K: 1 | S: 5 | LOB: 1 | BB: 1 | P: 9 | 1B: 1 | SF: 0 | 2B: 1 | SAC: 0 | 3B: 0 | DP: 0 | HR: 1 | HBP: 0 | WP: 0 | PA: 31 |
|--------------|------|------|------|------|------|--------|-------|------|------|------|------|------|------|--------|-------|------|------|------|------|------|------|--------|-------|------|------|------|------|------|------|--------|-------|------|------|------|------|------|------|--------|-------|------|------|------|------|------|------|--------|-------|------|------|------|------|------|------|--------|-------|------|------|------|------|------|------|--------|-------|------|-------|-------|-------|--------|-------|-------|-------|--------|-------|--------|
|--------------|------|------|------|------|------|--------|-------|------|------|------|------|------|------|--------|-------|------|------|------|------|------|------|--------|-------|------|------|------|------|------|------|--------|-------|------|------|------|------|------|------|--------|-------|------|------|------|------|------|------|--------|-------|------|------|------|------|------|------|--------|-------|------|------|------|------|------|------|--------|-------|------|-------|-------|-------|--------|-------|-------|-------|--------|-------|--------|

| PITCHER                            | IP  | WLS | BF | H | R | ER | SO | BB | IBB | HBP | BLK | WP | HR | S  | P  | ERA  | WHIP  |
|------------------------------------|-----|-----|----|---|---|----|----|----|-----|-----|-----|----|----|----|----|------|-------|
| Bob Heffner, R (1, 1)<br>ERA: 3.67 | 6.0 |     | 21 | 3 | 2 | 2  | 6  | 0  | 0   | 0   | 0   | 0  | 1  | 33 | 33 | 3.00 | 0.500 |
| Dick Radatz, R (7, 1)<br>ERA: 1.98 | 3.0 | W   | 10 | 0 | 0 | 0  | 4  | 1  | 0   | 0   | 0   | 0  | 0  | 17 | 21 | 0.00 | 0.333 |

**BOTTOM**

**Boston Red Sox @ Kansas City Athletics**  
Municipal Stadium, Kansas City, MO

Wed Jul 29 1964, 8:05 PM EDT  
Att. 5,510 - Unknown

livebaseballscorecards.com

|            |           |
|------------|-----------|
| <b>AB</b>  | <b>30</b> |
| <b>R</b>   | <b>2</b>  |
| <b>H</b>   | <b>3</b>  |
| <b>RBI</b> | <b>2</b>  |
| <b>BB</b>  | <b>1</b>  |
| <b>SO</b>  | <b>10</b> |
| <b>LOB</b> | <b>3</b>  |



| Batter  | 1                      | 2          | 3          | 4          | 5                      | 6          | 7                | 8                      | 9                       | AB R H RBI BB SO LOB |
|---|------------------------|------------|------------|------------|------------------------|------------|------------------|------------------------|-------------------------|----------------------|
| Jackie Brandt, R<br>OBP: 0.312, SLG: 0.409 (1, 8) X   | 0-0<br>G3<br>6-3<br>2B |            | 0-0<br>6-3 |            | 0-3<br>K               |            | 0-3<br>K         |                        | 0-0<br>F6<br>1-2<br>2-3 | 5 1 1 0 0 2 6        |
| Luis Aparicio, R<br>OBP: 0.324, SLG: 0.389 (1, 6) X   | 0-0<br>G3<br>2-3       |            |            | 0-0<br>6-3 | 0-0<br>4-3             |            | 0-0<br>5-3       |                        | 0-0<br>SF7<br>3-H       | 4 0 0 1 0 0 5        |
| Bob Johnson, R<br>OBP: 0.323, SLG: 0.418 (1, 3) X     | 0-0<br>6-3<br>3-H      |            |            | 0-0<br>F9  |                        | 0-0<br>F2  |                  | 0-3<br>K               | 0-0<br>1B               | 5 0 1 2 0 1 0        |
| Brooks Robinson, R<br>OBP: 0.368, SLG: 0.488 (1, 5) X | 0-0<br>5-3             |            |            | 0-0<br>HR  |                        | 1-0<br>HBP |                  | 4-0<br>1B<br>BB        | 0-3<br>K                | 3 2 1 1 1 1 1        |
| Sam Bowens, R<br>OBP: 0.325, SLG: 0.468 (1, 9) X      |                        | 0-0<br>F4  |            | 0-0<br>F8  |                        | 0-3<br>K   |                  | 0-0<br>1B<br>1-2       |                         | 4 0 1 0 0 1 1        |
| Earl Robinson, R<br>OBP: 0.500, SLG: 0.619 (1, 7) X   |                        | 0-0<br>F9  |            |            | 0-0<br>1B<br>2B        |            | 0-3<br>K         | 0-0<br>1B<br>G6-4-3    |                         | 2 1 1 0 0 0 0        |
| Boog Powell, L<br>OBP: 0.374, SLG: 0.610 (5, 7) X     |                        |            |            |            |                        |            |                  | 1-2<br>2-H<br>1B       |                         | 2 0 1 1 0 1 1        |
| Jerry Adair, R<br>OBP: 0.284, SLG: 0.314 (1, 4) X     |                        | 0-0<br>5-3 |            |            | 0-0<br>BB<br>1B<br>2-H |            | 0-0<br>1B<br>1B  | 0-0<br>G6-4-3<br>1-2f  |                         | 4 0 2 1 0 0 2        |
| Dick Brown, R<br>OBP: 0.312, SLG: 0.428 (1, 2) X      |                        |            | 0-0<br>F2  |            | 4-0<br>BB<br>1-2       |            | 0-0<br>1B<br>1-3 | 4-0<br>WP<br>SF7<br>BB |                         | 2 1 1 0 2 0 0        |
| Wally Bunker, R<br>OBP: 0.130, SLG: 0.093 (1, 1) X    |                        |            | 0-0<br>1-3 |            | 0-3<br>K               |            | 0-3<br>K         | 4-0<br>WP<br>1B<br>BB  |                         | 3 1 0 0 1 2 4        |

**TOP**

**Baltimore Orioles @ Kansas City Athletics**  
Municipal Stadium, Kansas City, MO

Fri Jul 31 1964, 8:05 PM EDT  
Unknown

|     |    |
|-----|----|
| AB  | 34 |
| R   | 6  |
| H   | 9  |
| RBI | 6  |
| BB  | 4  |
| SO  | 8  |
| LOB | 20 |



| Inning Stats | R: 1 | H: 1 | E: 0 | K: 0 | S: 4 | P: 4 | R: 0 | H: 0 | E: 0 | K: 0 | S: 3 | P: 3 | R: 0 | H: 0 | E: 0 | K: 0 | S: 3 | P: 3 | R: 1 | H: 1 | E: 0 | K: 0 | S: 4 | P: 4 | R: 1 | H: 2 | E: 0 | K: 2 | S: 9 | P: 13 | R: 0 | H: 0 | E: 0 | K: 2 | S: 7 | P: 8 | R: 0 | H: 2 | E: 0 | K: 2 | S: 9 | P: 9 | R: 1 | H: 2 | E: 0 | K: 1 | S: 6 | P: 10 | R: 2 | H: 1 | E: 0 | K: 1 | S: 6 | P: 14 | 1B: 6 | SF: 1 | 2B: 2 | SAC: 0 | 3B: 0 | DP: 1 | HR: 1 | HBP: 1 | WP: 1 | PA: 40 |
|--------------|------|------|------|------|------|------|------|------|------|------|------|------|------|------|------|------|------|------|------|------|------|------|------|------|------|------|------|------|------|-------|------|------|------|------|------|------|------|------|------|------|------|------|------|------|------|------|------|-------|------|------|------|------|------|-------|-------|-------|-------|--------|-------|-------|-------|--------|-------|--------|
|--------------|------|------|------|------|------|------|------|------|------|------|------|------|------|------|------|------|------|------|------|------|------|------|------|------|------|------|------|------|------|-------|------|------|------|------|------|------|------|------|------|------|------|------|------|------|------|------|------|-------|------|------|------|------|------|-------|-------|-------|-------|--------|-------|-------|-------|--------|-------|--------|

| PITCHER                                | IP  | WLS | BF | H | R | ER | SO | BB | IBB | HBP | BLK | WP | HR | S  | P  | ERA   | WHIP  |
|--|-----|-----|----|---|---|----|----|----|-----|-----|-----|----|----|----|----|-------|-------|
| John O'Donoghue, L<br>ERA: 4.42 (1, 1) | 4.0 | L   | 17 | 4 | 3 | 3  | 0  | 1  | 0   | 0   | 0   | 0  | 1  | 16 | 20 | 6.75  | 1.250 |
| Wes Stock, R<br>ERA: 2.53 (5, 1)       | 0.0 |     | 0  | 0 | 0 | 0  | 0  | 0  | 0   | 0   | 0   | 0  | 0  | 0  | 0  | ∞     | ∞     |
| Moe Drabowsky, R<br>ERA: 5.96 (7, 1)   | 2.0 |     | 10 | 4 | 1 | 1  | 3  | 1  | 0   | 0   | 0   | 0  | 0  | 15 | 19 | 4.50  | 2.500 |
| Dan Pfister, R<br>ERA: 6.53 (9, 1)     | 1.0 |     | 6  | 1 | 2 | 2  | 1  | 2  | 0   | 0   | 0   | 1  | 0  | 6  | 14 | 18.00 | 3.000 |

| PITCHER | IP | WLS | BF | H | R | ER | SO | BB | IBB | HBP | BLK | WP | HR | S | P | ERA | WHIP |
|---------|----|-----|----|---|---|----|----|----|-----|-----|-----|----|----|---|---|-----|------|
|---------|----|-----|----|---|---|----|----|----|-----|-----|-----|----|----|---|---|-----|------|

| Batter   | 1          | 2          | 3          | 4          | 5             | 6          | 7          | 8          | 9          | AB R H RBI BB SO LOB   |
|--|------------|------------|------------|------------|---------------|------------|------------|------------|------------|--|
| Jose Tartabull, L (1, 8)<br>OBP: 0.239, SLG: 0.232   | 0-0<br>6-3 |            | 0-0<br>5-3 |            |               | 0-0<br>F7  |            |            | 0-0<br>4-3 | 4 0 0 0 0 0 0  |
| Bert Campaneris, R (1, 5)<br>OBP: 0.412, SLG: 0.613  | 0-0<br>2B  |            |            | 0-0<br>F8  |               |            | 0-0<br>1-3 |            | 0-3<br>K   | 4 0 1 0 0 1 0  |
| Wayne Causey, L (1, 6)<br>OBP: 0.389, SLG: 0.387   | 0-3<br>K   |            |            | 0-0<br>4-3 |               |            | 0-0<br>G3  |            | 0-0<br>F8  | 4 0 0 0 0 1 1  |
| Rocky Colavito, R (1, 9)<br>OBP: 0.366, SLG: 0.546   | 0-0<br>1-3 |            |            | 0-0<br>5-3 |               |            | 0-0<br>HR  |            |            | 3 1 1 1 0 0 1  |
| Jim Gentile, L (1, 3)<br>OBP: 0.377, SLG: 0.484  |            | 0-0<br>4-3 |            |            | 4-0<br>BB     |            | 0-0<br>2B  |            |            | 2 0 1 0 1 0 0  |
| Manny Jimenez, L (1, 7)<br>OBP: 0.286, SLG: 0.515  |            | 0-0<br>5-3 |            |            | 0-0<br>G4-6-3 |            | 0-0<br>G3  |            |            | 3 0 0 0 0 0 2  |
| Billy Bryan, L (1, 2)<br>OBP: 0.295, SLG: 0.503  |            | 0-3<br>K   |            |            | 0-0<br>F8     |            |            | 0-0<br>F8  |            | 3 0 0 0 0 1 0  |
| Dick Green, R (1, 4)<br>OBP: 0.291, SLG: 0.399   |            |            | 0-0<br>5-3 |            |               | 0-0<br>4-3 |            | 0-0<br>4-3 |            | 3 0 0 0 0 0 0  |
| John O'Donoghue, R (1, 1)<br>Wes Stock, R (5, 1)<br>Ken Harrelson, R (6, PH)<br>Moe Drabowsky, R (7, 1)<br>George Alusik, R (8, PH)<br>Dan Pfister, R (9, 1) |            |            | 0-0<br>1-3 |            |               | 0-3<br>K   |            | 0-0<br>F6  |            | 1 0 0 0 0 0 0<br>0 0 0 0 0 0 0<br>1 0 0 0 0 1 0<br>0 0 0 0 0 0 0<br>1 0 0 0 0 0 0<br>0 0 0 0 0 0 0 |

| Inning Stats                                   | R: 0<br>E: 0<br>K: 1<br>S: 6  | H: 1<br>LOB: 1<br>BB: 0<br>P: 6 | R: 0<br>E: 0<br>K: 1<br>S: 5 | H: 0<br>LOB: 0<br>BB: 0<br>P: 5 | R: 0<br>E: 0<br>K: 0<br>S: 3 | H: 0<br>LOB: 0<br>BB: 0<br>P: 3 | R: 0<br>E: 0<br>K: 0<br>S: 3 | H: 0<br>LOB: 0<br>BB: 0<br>P: 3 | R: 0<br>E: 0<br>K: 0<br>S: 2 | H: 0<br>LOB: 0<br>BB: 1<br>P: 6 | R: 0<br>E: 0<br>K: 1<br>S: 5 | H: 0<br>LOB: 0<br>BB: 0<br>P: 5 | R: 1<br>E: 0<br>K: 0<br>S: 5 | H: 2<br>LOB: 1<br>BB: 0<br>P: 5 | R: 0<br>E: 0<br>K: 0<br>S: 3 | H: 0<br>LOB: 0<br>BB: 0<br>P: 3 | R: 0<br>E: 0<br>K: 1<br>S: 5 | H: 0<br>LOB: 0<br>BB: 0<br>P: 5 | 1B: 0<br>2B: 2<br>3B: 0<br>HR: 1 | SF: 0<br>SAC: 0<br>DP: 1<br>HBP: 0 | WP: 0<br>PB: 0<br>SB: 0<br>CS: 0 | PA: 30 |
|--|---|---------------------------------|------------------------------|---------------------------------|------------------------------|---------------------------------|------------------------------|---------------------------------|------------------------------|---------------------------------|------------------------------|---------------------------------|------------------------------|---------------------------------|------------------------------|---------------------------------|------------------------------|---------------------------------|----------------------------------|------------------------------------|----------------------------------|--------|
| PITCHER<br>Wally Bunker, R (1, 1)<br>ERA: 2.71 | IP 9.0<br>WLS W<br>BF 30<br>H 3<br>R 1<br>ER 1<br>SO 4<br>BB 1<br>IBB 0<br>HBP 0<br>BLK 0<br>WP 0<br>HR 1<br>S 37<br>P 41<br>ERA 1.00<br>WHIP 0.444 |                                 |                              |                                 |                              |                                 |                              |                                 |                              |                                 |                              |                                 |                              |                                 |                              |                                 |                              |                                 |                                  |                                    |                                  |        |

BOTTOM

Baltimore Orioles @ Kansas City Athletics  
Municipal Stadium, Kansas City, MO  
Fri Jul 31 1964, 8:05 PM EDT  
Unknown

livebaseballscorecards.com

|     |    |
|-----|----|
| AB  | 29 |
| R   | 1  |
| H   | 3  |
| RBI | 1  |
| BB  | 1  |
| SO  | 4  |
| LOB | 4  |



| Batter   | 1   | 2                               | 3                            | 4                               | 5                            | 6                               | 7                            | 8                               | 9                            | AB R H RBI BB SO LOB                            | TOP                          |                                 |                              |                                 |                              |                                 |                              |                                  |                                  |                                    |   |        |  |  |  |  |  |  |  |  |  |  |  |  |  |
|--|---|---------------------------------|------------------------------|---------------------------------|------------------------------|---------------------------------|------------------------------|---------------------------------|------------------------------|---|------------------------------|---------------------------------|------------------------------|---------------------------------|------------------------------|---------------------------------|------------------------------|----------------------------------|----------------------------------|------------------------------------|---|--------|--|--|--|--|--|--|--|--|--|--|--|--|--|
| Jackie Brandt, R (1, 8)<br>OBP: 0.310, SLG: 0.406  | 0-0<br>F8   |                                 | 0-0<br>5-3                   |                                 | 0-0<br>F9                    |                                 | 0-0<br>E8<br>1B              |                                 | 0-3<br>K                     | 5 1 1 1 0 1 1                                   |                              |                                 |                              |                                 |                              |                                 |                              |                                  |                                  |                                    |   |        |  |  |  |  |  |  |  |  |  |  |  |  |  |
| Luis Aparicio, R (1, 6)<br>OBP: 0.323, SLG: 0.386  | 0-0<br>F8   |                                 |                              | 0-0<br>4-3                      |                              | 0-0<br>E3<br>2B                 | 0-0<br>2B<br>1B              |                                 | 0-0<br>F9                    | 5 1 1 1 0 0 1                                   |                              |                                 |                              |                                 |                              |                                 |                              |                                  |                                  |                                    |   |        |  |  |  |  |  |  |  |  |  |  |  |  |  |
| Bob Johnson, R (1, 3)<br>OBP: 0.327, SLG: 0.427<br>Norm Siebern, L (9, PH)<br>OBP: 0.382, SLG: 0.363 (9, 3)                  | 0-0<br>3-1  |                                 |                              | 0-0<br>1B                       |                              | 0-0<br>F8<br>1-H<br>2B          | 0-0<br>6-3                   |                                 | 4-0<br>1-2<br>BB             | 4 0 2 1 0 0 1<br>0 0 0 0 1 0 0                  |                              |                                 |                              |                                 |                              |                                 |                              |                                  |                                  |                                    |   |        |  |  |  |  |  |  |  |  |  |  |  |  |  |
| Brooks Robinson, R (1, 5)<br>OBP: 0.364, SLG: 0.482  |   | 0-0<br>F8                       |                              | 0-3<br>K                        |                              | 0-0<br>F8<br>2-3                |                              | 0-0<br>1-3                      | 0-0<br>F2                    | 5 0 0 0 0 1 4                                   |                              |                                 |                              |                                 |                              |                                 |                              |                                  |                                  |                                    |   |        |  |  |  |  |  |  |  |  |  |  |  |  |  |
| Sam Bowens, R (1, 9)<br>OBP: 0.324, SLG: 0.465   |   | 0-0<br>F9                       |                              | 0-0<br>F4                       |                              | 0-0<br>6-3                      |                              | 0-0<br>1B                       |                              | 4 0 1 0 0 0 2                                   |                              |                                 |                              |                                 |                              |                                 |                              |                                  |                                  |                                    |   |        |  |  |  |  |  |  |  |  |  |  |  |  |  |
| Earl Robinson, R (1, 7)<br>OBP: 0.481, SLG: 0.625<br>Boog Powell, L (8, PH)<br>OBP: 0.373, SLG: 0.608 (8, 7)                 |   | 0-0<br>2B                       |                              |                                 | 0-0<br>F4                    | 0-0<br>6-3                      |                              | 0-3<br>K                        |                              | 3 0 1 0 0 0 1<br>1 0 0 0 0 1 1                  |                              |                                 |                              |                                 |                              |                                 |                              |                                  |                                  |                                    |   |        |  |  |  |  |  |  |  |  |  |  |  |  |  |
| Jerry Adair, R (1, 4)<br>OBP: 0.284, SLG: 0.313  |   | 0-0<br>F9                       |                              |                                 | 0-0<br>HR<br>1B              |                                 | 0-0<br>F4                    | 0-0<br>4-3                      |                              | 4 1 1 0 0 0 2                                   |                              |                                 |                              |                                 |                              |                                 |                              |                                  |                                  |                                    |   |        |  |  |  |  |  |  |  |  |  |  |  |  |  |
| Dick Brown, R (1, 2)<br>OBP: 0.323, SLG: 0.477   |   |                                 | 0-0<br>F8                    |                                 | 0-0<br>HR                    |                                 | 0-0<br>SH2-4<br>E<br>1B      |                                 | 0-0<br>HR                    | 4 3 3 3 0 0 0                                   |                              |                                 |                              |                                 |                              |                                 |                              |                                  |                                  |                                    |   |        |  |  |  |  |  |  |  |  |  |  |  |  |  |
| Dave McNally, R (1, 1)<br>OBP: 0.200, SLG: 0.167<br>Stu Miller, R (8, 1)<br>Steve Barber, L (8, 1)<br>OBP: 0.281, SLG: 0.333 |   |                                 | 0-3<br>K                     |                                 | 0-0<br>F8                    |                                 | 0-0<br>SH2-4                 |                                 | 0-0<br>BB<br>1B              | 2 0 0 0 0 1 0<br>0 0 0 0 0 0 0<br>1 0 1 0 0 0 0 |                              |                                 |                              |                                 |                              |                                 |                              |                                  |                                  |                                    |   |        |  |  |  |  |  |  |  |  |  |  |  |  |  |
| <b>Inning Stats</b>  | R: 0<br>E: 0<br>K: 0<br>S: 3  | H: 0<br>LOB: 0<br>BB: 0<br>P: 3 | R: 0<br>E: 0<br>K: 0<br>S: 4 | H: 1<br>LOB: 1<br>BB: 0<br>P: 4 | R: 0<br>E: 0<br>K: 1<br>S: 5 | H: 0<br>LOB: 0<br>BB: 0<br>P: 5 | R: 0<br>E: 0<br>K: 1<br>S: 6 | H: 1<br>LOB: 1<br>BB: 0<br>P: 6 | R: 2<br>E: 0<br>K: 0<br>S: 5 | H: 2<br>LOB: 0<br>BB: 0<br>P: 5                 | R: 1<br>E: 1<br>K: 0<br>S: 5 | H: 1<br>LOB: 1<br>BB: 0<br>P: 5 | R: 2<br>E: 1<br>K: 0<br>S: 6 | H: 3<br>LOB: 1<br>BB: 0<br>P: 6 | R: 0<br>E: 0<br>K: 1<br>S: 6 | H: 1<br>LOB: 1<br>BB: 0<br>P: 6 | R: 1<br>E: 0<br>K: 1<br>S: 7 | H: 2<br>LOB: 2<br>BB: 1<br>P: 11 | 1B: 7<br>2B: 2<br>3B: 0<br>HR: 2 | SF: 0<br>SAC: 1<br>DP: 0<br>HBP: 0 | WP: 0<br>PB: 0<br>SB: 1<br>CS: 0  | PA: 40 |  |  |  |  |  |  |  |  |  |  |  |  |  |
| <b>PITCHER</b>   | IP<br>WLS<br>BF<br>H<br>R<br>ER<br>SO<br>BB<br>IBB<br>HBP<br>BLK<br>WP<br>HR<br>S<br>P<br>ERA<br>WHIP |                                 |                              |                                 |                              |                                 |                              |                                 |                              |   |                              |                                 |                              |                                 |                              |                                 |                              |                                  |                                  | <b>PITCHER</b>                     | IP<br>WLS<br>BF<br>H<br>R<br>ER<br>SO<br>BB<br>IBB<br>HBP<br>BLK<br>WP<br>HR<br>S<br>P<br>ERA<br>WHIP |        |  |  |  |  |  |  |  |  |  |  |  |  |  |
| Ted Bowsfield, L (1, 1)<br>ERA: 4.01   | 6.2   |                                 | 29                           | 8                               | 5                            | 3                               | 2                            | 0                               | 0                            | 0   | 0                            | 0                               | 1                            | 33                              | 33                           | 4.05                            | 1.200                        |                                  |                                  |                                    |   |        |  |  |  |  |  |  |  |  |  |  |  |  |  |
| Jose Santiago, R (7, 1)<br>ERA: 4.81   | 0.1   |                                 | 1                            | 0                               | 0                            | 0                               | 0                            | 0                               | 0                            | 0   | 0                            | 0                               | 0                            | 1                               | 1                            | 0.00                            | 0.000                        |                                  |                                  |                                    |   |        |  |  |  |  |  |  |  |  |  |  |  |  |  |
| Moe Drabowsky, R (8, 1)<br>ERA: 5.91   | 1.0   |                                 | 4                            | 1                               | 0                            | 0                               | 1                            | 0                               | 0                            | 0   | 0                            | 0                               | 0                            | 6                               | 6                            | 0.00                            | 1.000                        |                                  |                                  |                                    |   |        |  |  |  |  |  |  |  |  |  |  |  |  |  |
| John Wyatt, R (9, 1)<br>ERA: 3.6   | 1.0   | W                               | 6                            | 2                               | 1                            | 1                               | 1                            | 1                               | 0                            | 0   | 0                            | 0                               | 1                            | 7                               | 11                           | 9.00                            | 3.000                        |                                  |                                  |                                    |   |        |  |  |  |  |  |  |  |  |  |  |  |  |  |

Baltimore Orioles @ Kansas City Athletics  
Municipal Stadium, Kansas City, MO

Fri Jul 31 1964, 8:05 PM EDT  
Att: 10,128 - Unknown

|     |    |
|-----|----|
| AB  | 38 |
| R   | 6  |
| H   | 11 |
| RBI | 6  |
| BB  | 1  |
| SO  | 4  |
| LOB | 13 |



|    |   |    |    |
|----|---|----|----|
| WP | 0 | PA | 40 |
| PB | 0 |    |    |
| SB | 1 |    |    |
| CS | 0 |    |    |

| PITCHER | IP | WLS | BF | H | R | ER | SO | BB | IBB | HBP | BLK | WP | HR | S | P | ERA | WHIP |
|---------|----|-----|----|---|---|----|----|----|-----|-----|-----|----|----|---|---|-----|------|
|---------|----|-----|----|---|---|----|----|----|-----|-----|-----|----|----|---|---|-----|------|



BOTTOM

Baltimore Orioles @ Kansas City Athletics  
Municipal Stadium, Kansas City, MO

livebaseballscores.com

AB 33  
R 7  
H 11  
RBI 7  
BB 3  
SO 3  
LOB 14

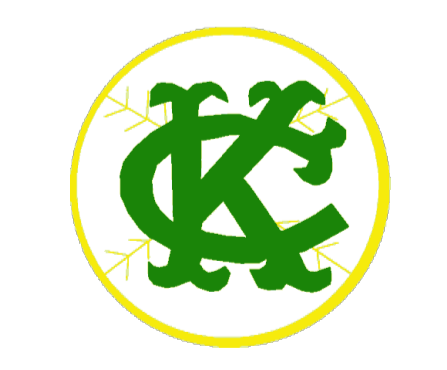

WP: 0 PA: 38  
PB: 0  
SB: 0  
CS: 0

ERA WHIP

AB R H RBI BB SO LOB

4 0 1 1 0 1 3

4 2 2 1 1 0 1

4 0 0 0 0 0 4

4 1 1 0 0 0 1

3 1 1 0 1 2 1

3 1 1 1 0 0 1

4 1 1 2 0 0 2

4 1 3 2 0 0 0

1B: 6 SF: 1  
2B: 3 SAC: 0  
3B: 1 DP: 1  
HR: 1 HBP: 1

WP HR S P ERA WHIP

0-0 SF9

0-0 BB 1B 2B HR

0-0 F8

0-0 E3 1B 2B

0-0 FC5-4 1B BB

0-0 FC5-4 1B

0-0 E 1B

0-0 E1 SF9 1B

0-0 SF9 IBB

0-0 F6

0-0 F8

0-0 F8

0-0 5-3

0-0 FC5-4 1B

0-0 FC5-4 1-2f

0-0 6-3

0-0 3B

0-0 5-3

0-0 F9

0-0 F8

0-0 F8

0-0 4-3 2B

0-0 K

0-0 HBP

0-0 G6-4-3 1-2f

0-0 F8

0-0 1-3

0-0 1B

0-0 BB

0-0 F9

0-0 2B

0-0 K

0-0 HBP

0-0 G6-4-3 1-2f

0-0 F8

0-0 1-3

0-0

0-0 BB

0-0 F9

0-0 2B

0-0 K

0-0 HBP

0-0 G6-4-3 1-2f

0-0 F8

0-0 1-3

0-0

0-0 BB

0-0 F9

0-0 2B

0-0 K

0-0 HBP

0-0 G6-4-3 1-2f

0-0 F8

0-0 1-3

0-0

0-0 BB

0-0 F9

0-0 2B

0-0 K

0-0 HBP

0-0 G6-4-3 1-2f

0-0 F8

0-0 1-3

0-0

0-0 BB

0-0 F9

0-0 2B

0-0 K

0-0 HBP

0-0 G6-4-3 1-2f

0-0 F8

0-0 1-3

0-3 K

0-0 5-3

0-0 L4

0-0 4-3

0-3 K

0-0 6-3

0-0 F8

0-0 BB 1B

0-0 BB 1B

Wayne Causey, L (1, 4)  
OBP: 0.386, SLG: 0.386

Ed Charles, R (1, 5)  
OBP: 0.319, SLG: 0.369

Rocky Colavito, R (1, 9)  
OBP: 0.363, SLG: 0.541

Ken Harrelson, R (1, 7)  
OBP: 0.265, SLG: 0.405

Jim Gentile, L (1, 3)  
OBP: 0.378, SLG: 0.482

Doc Edwards, R (1, 2)  
OBP: 0.259, SLG: 0.302

Bert Campaneris, R (1, 6)  
OBP: 0.395, SLG: 0.600

Nelson Mathews, R (1, 8)  
OBP: 0.285, SLG: 0.341

Ted Bowsfield, R (1, 1)  
OBP: 0.150, SLG: 0.105  
Jose Santiago, R (7, 1)  
George Alusik, R (7, PH)  
OBP: 0.363, SLG: 0.374  
Moe Drabowsky, R (8, 1)  
OBP: 0.029, SLG: 0.029  
Manny Jimenez, L (8, PH)  
OBP: 0.291, SLG: 0.615  
Jose Tartabull, L (8, PR)  
OBP: 0.239, SLG: 0.232  
John Wyatt, R (9, 1)

Inning Stats

PITCHER  
Dave McNally, L (1, 1)  
ERA: 3.86  
Stu Miller, R (8, 1)  
ERA: 2.53  
Steve Barber, L (8, 1)  
ERA: 4.07

R: 0 H: 0 E: 0 K: 1 S: 5  
R: 0 H: 0 E: 0 K: 1 S: 5  
R: 0 H: 2 E: 0 K: 0 S: 5  
R: 0 H: 1 E: 0 K: 1 S: 5  
R: 0 H: 1 E: 0 K: 0 S: 4  
R: 0 H: 1 E: 0 K: 0 S: 4  
R: 0 H: 1 E: 0 K: 0 S: 4  
R: 6 H: 4 E: 2 K: 0 S: 7  
R: 1 H: 1 E: 0 K: 0 S: 1  
1B: 6 2B: 3 3B: 1 HR: 1  
SF: 1 SAC: 0 DP: 1 HBP: 1

IP WLS BF H R ER SO BB IBB HBP BLK WP HR S P ERA WHIP  
7.1 0 33 8 4 4 3 2 0 1 0 0 0 0 4.91 1.364  
0.0 3 2 1 0 0 0 1 0 0 0 0 2 6 ∞ ∞  
0.2 L 2 1 2 1 0 0 0 0 0 0 0 1 2 2 13.50 1.500

| Batter  | 1   | 2   | 3   | 4   | 5   | 6   | 7  | 8   | 9  | AB R H RBI BB SO LOB   | TOP  |  |
|---|---|---|---|---|---|---|--|---|--|--|--|--|
| Jackie Brandt, R (1, 8)<br>OBP: 0.307, SLG: 0.401   | 0-3<br>K  |   | 0-0<br>F2   |   |   | 0-0<br>F5   |  | 0-3<br>K  | 0-0<br>F8  | 5 0 0 0 0 2 2  |  |  |
| Luis Aparicio, R (1, 6)<br>OBP: 0.322, SLG: 0.385   | 0-0<br>F9   |   | 0-3<br>K  |   |   | 0-0<br>6-3  |  |   | 0-0<br>1B<br>1B  | 4 1 1 0 0 1 0  |  |  |
| Norm Siebern, L (1, 3)<br>OBP: 0.386, SLG: 0.369  | 0-0<br>2B   |   |   | 4-0<br>BB<br>G3-6-3   |   |   | 0-0<br>G3  |   | 0-0<br>1B<br>1B<br>FC6-2<br>1B                                   | 3 0 2 0 1 0 0  |  |  |
| Boog Powell, L (1, 7)<br>OBP: 0.374, SLG: 0.605   | 0-0<br>4-3  |   |   | 0-0<br>G3-6-3<br>1-2f   |   |   | 4-0<br>BB<br>BB  |   | 0-0<br>FC6-2<br>1B<br>1-2<br>2B<br>1B<br>3-H                     | 3 1 1 1 1 0 2  |  |  |
| Brooks Robinson, R (1, 5)<br>OBP: 0.363, SLG: 0.479   |   | 0-0<br>F4   |   | 0-3<br>K  |   |   | 0-0<br>F4  |   | 0-0<br>FC6-2<br>2B<br>1B<br>1-2<br>2-3                           | 4 1 1 0 0 1 1  |  |  |
| Sam Bowens, R (1, 9)<br>OBP: 0.323, SLG: 0.460  |   | 0-0<br>5-3  |   |   | 0-0<br>1-3  |   | 4-0<br>1-2<br>BB   |   | 0-0<br>FC6-2<br>2B<br>1-2<br>2-3<br>3-Hf                         | 3 1 0 0 1 0 3  |  |  |
| Dick Brown, R (1, 2)<br>OBP: 0.321, SLG: 0.477  |   | 0-3<br>K  |   |   | 0-0<br>4-3  |   | 0-0<br>F9  |   | 0-0<br>SH3-4<br>2B<br>1-H<br>2-H<br>3-H                          | 4 0 1 3 0 1 2  |  |  |
| Jerry Adair, R (1, 4)<br>OBP: 0.286, SLG: 0.322   |   |   | 0-0<br>HR   |   | 0-0<br>L4   |   |  | 0-0<br>F8   | 4-0<br>SH3-4<br>IBB  | 3 1 1 1 1 0 0  |  |  |
| Frank Bertaina, L (1, 1)<br>Bob Johnson, R (8, PH)<br>Dick Hall, R (8, 1)<br>OBP: 0.273, SLG: 0.200 |   |   | 0-0<br>G3   |   |   | 0-0<br>4-3  |  | 0-0<br>5-3  | 0-0<br>SH3-4<br>1-2<br>2-3                                       | 2 0 0 0 0 0 0<br>1 0 0 0 0 0 0<br>0 0 0 0 0 0 0                        |  |  |
| <b>Inning Stats</b>   | R: 0<br>E: 0<br>K: 1<br>S: 6<br>H: 1<br>LOB: 1<br>BB: 0<br>P: 6 | R: 0<br>E: 0<br>K: 1<br>S: 5<br>H: 0<br>LOB: 0<br>BB: 0<br>P: 5 | R: 1<br>E: 0<br>K: 1<br>S: 6<br>H: 1<br>LOB: 0<br>BB: 0<br>P: 6 | R: 0<br>E: 0<br>K: 1<br>S: 4<br>H: 0<br>LOB: 0<br>BB: 1<br>P: 8 | R: 0<br>E: 0<br>K: 0<br>S: 3<br>H: 0<br>LOB: 0<br>BB: 0<br>P: 3 | R: 0<br>E: 0<br>K: 0<br>S: 3<br>H: 0<br>LOB: 0<br>BB: 0<br>P: 3 | R: 0<br>E: 0<br>K: 0<br>S: 3<br>H: 0<br>LOB: 2<br>BB: 2<br>P: 11 | R: 0<br>E: 0<br>K: 1<br>S: 5<br>H: 0<br>LOB: 0<br>BB: 0<br>P: 5 | R: 4<br>E: 0<br>K: 0<br>S: 8<br>H: 5<br>LOB: 2<br>BB: 1<br>P: 12 | 1B: 4<br>2B: 2<br>3B: 0<br>HR: 1<br>SF: 0<br>SAC: 1<br>DP: 1<br>HBP: 0 | WP: 0<br>PB: 0<br>SB: 0<br>CS: 0<br>PA: 37 |  |
| <b>PITCHER</b>  | IP WLS BF H R ER SO BB IBB HBP BLK WP HR S P ERA WHIP           |   |   |   |   |   |  |   |  |  |  |  |
| Orlando Pena, R (1, 1)<br>ERA: 4.48   | 8.0 L 30 4 3 3 5 3 0 0 0 0 1 37 49 3.38 0.875                   |   |   |   |   |   |  |   |  |  |  |  |
| John Wyatt, R (9, 1)<br>ERA: 3.78   | 1.0 7 3 2 2 0 0 1 0 0 0 0 6 10 18.00 3.000                      |   |   |   |   |   |  |   |  |  |  |  |

Baltimore Orioles @ Kansas City Athletics  
Municipal Stadium, Kansas City, MO  
Sat Aug 01 1964, 8:05 PM EDT  
Att: 25,003 - Unknown

|     |    |
|-----|----|
| AB  | 32 |
| R   | 5  |
| H   | 7  |
| RBI | 5  |
| BB  | 4  |
| SO  | 5  |
| LOB | 10 |



| Batter  | 1                      | 2                  | 3          | 4              | 5         | 6          | 7                  | 8           | 9            | AB | R | H | RBI | BB | SO | LOB |
|---|------------------------|--------------------|------------|----------------|-----------|------------|--------------------|-------------|--------------|----|---|---|-----|----|----|-----|
| Wayne Causey, L (1, 4)<br>OBP: 0.385, SLG: 0.384    | 0-0<br>1B<br>1B        | 0-0<br>F4          |            |                | 0-0<br>F9 |            | 0-0<br>4-3         |             |              | 4  | 1 | 1 | 0   | 0  | 0  | 2   |
| Ed Charles, R (1, 5)<br>OBP: 0.321, SLG: 0.378      | 0-0<br>1B<br>1-2<br>1B |                    | 0-0<br>L6  |                | 0-0<br>HR |            |                    | 0-0<br>4-3  |              | 4  | 1 | 2 | 1   | 0  | 0  | 0   |
| Rocky Colavito, R (1, 9)<br>OBP: 0.359, SLG: 0.535  | 0-0<br>F7              |                    | 0-0<br>5-3 |                | 0-0<br>F4 |            |                    | 0-0<br>5-3  |              | 4  | 0 | 0 | 0   | 0  | 0  | 2   |
| Ken Harrelson, R (1, 3)<br>OBP: 0.253, SLG: 0.386   | 0-0<br>F7              |                    | 0-0<br>5-3 |                |           | 0-0<br>6-3 |                    | 0-0<br>F8   |              | 4  | 0 | 0 | 0   | 0  | 0  | 2   |
| George Alusik, R (1, 7)<br>OBP: 0.362, SLG: 0.373   | 0-0                    |                    |            | 0-0<br>L7      |           | 0-0<br>F7  |                    |             | 0-0          | 3  | 0 | 1 | 1   | 0  | 0  | 0   |
| Jose Tartabull, L (8, 7)<br>OBP: 0.250, SLG: 0.243  | 1-3<br>2-H<br>1B       |                    |            |                |           |            |                    | FC6-4<br>1B |              | 1  | 0 | 1 | 0   | 0  | 0  | 0   |
| Doc Edwards, R (1, 2)<br>OBP: 0.254, SLG: 0.295     | 0-0<br>5-3             |                    |            | 0-0<br>F2      |           | 0-3<br>K   |                    | 0-0<br>L7   |              | 4  | 0 | 0 | 0   | 0  | 1  | 3   |
| Bert Campaneris, R (1, 6)<br>OBP: 0.381, SLG: 0.564 |                        | 0-0<br>5-3         |            | 0-0<br>S<br>1B |           |            | 0-0<br>5-3         |             | 0-3<br>K     | 4  | 0 | 1 | 0   | 0  | 1  | 1   |
| Nelson Mathews, R (1, 8)<br>OBP: 0.287, SLG: 0.341  |                        | 4-0<br>SH1-4<br>BB |            | 0-0<br>6-3     |           |            | 0-0<br>SH1-4<br>1B |             | 0-0<br>FC6-4 | 3  | 0 | 1 | 0   | 1  | 0  | 2   |
| Orlando Pena, R (1, 1)<br>OBP: 0.182, SLG: 0.208    |                        | 0-0<br>SH1-4       |            |                | 0-3<br>K  |            |                    |             |              | 1  | 0 | 0 | 0   | 0  | 1  | 0   |
| John Wyatt, R (9, 1)                                |                        | 1-2                |            |                |           |            | 1-2                |             |              | 0  | 0 | 0 | 0   | 0  | 0  | 0   |

| Inning Stats | R: 1  | H: 3  | E: 0   | K: 0  | S: 6  | H: 3  | LOB: 2 | BB: 0 | P: 6   | R: 0 | H: 0 | E: 0 | K: 0 | S: 3 | H: 0 | LOB: 1 | BB: 1 | P: 7 | R: 0 | H: 0 | E: 0 | K: 0 | S: 3 | H: 0 | LOB: 0 | BB: 0 | P: 3 | R: 0 | H: 1 | E: 0 | K: 1 | S: 6 | H: 1 | LOB: 0 | BB: 0 | P: 6 | R: 0 | H: 0 | E: 0 | K: 1 | S: 5 | H: 0 | LOB: 0 | BB: 0 | P: 5 | R: 0 | H: 1 | E: 0 | K: 0 | S: 4 | H: 1 | LOB: 1 | BB: 0 | P: 4 | R: 0 | H: 0 | E: 0 | K: 0 | S: 4 | H: 0 | LOB: 0 | BB: 0 | P: 3 | R: 0 | H: 1 | E: 0 | K: 1 | S: 6 | H: 1 | LOB: 1 | BB: 0 | P: 6 | R: 0 | H: 0 | E: 0 | K: 0 | S: 3 | H: 0 | LOB: 0 | BB: 0 | P: 3 | R: 0 | H: 1 | E: 0 | K: 1 | S: 6 | H: 1 | LOB: 1 | BB: 0 | P: 6 |
|--------------|-------|-------|--------|-------|-------|-------|--------|-------|--------|------|------|------|------|------|------|--------|-------|------|------|------|------|------|------|------|--------|-------|------|------|------|------|------|------|------|--------|-------|------|------|------|------|------|------|------|--------|-------|------|------|------|------|------|------|------|--------|-------|------|------|------|------|------|------|------|--------|-------|------|------|------|------|------|------|------|--------|-------|------|------|------|------|------|------|------|--------|-------|------|------|------|------|------|------|------|--------|-------|------|
| 1B: 6        | SF: 0 | 2B: 0 | SAC: 2 | 3B: 0 | DP: 0 | HR: 1 | HBP: 0 | WP: 0 | PA: 35 |      |      |      |      |      |      |        |       |      |      |      |      |      |      |      |        |       |      |      |      |      |      |      |      |        |       |      |      |      |      |      |      |      |        |       |      |      |      |      |      |      |      |        |       |      |      |      |      |      |      |      |        |       |      |      |      |      |      |      |      |        |       |      |      |      |      |      |      |      |        |       |      |      |      |      |      |      |      |        |       |      |

| PITCHER                               | IP  | WLS | BF | H | R | ER | SO | BB | IBB | HBP | BLK | WP | HR | S  | P  | ERA  | WHIP  |
|---------------------------------------|-----|-----|----|---|---|----|----|----|-----|-----|-----|----|----|----|----|------|-------|
| Frank Bertaina, L (1, 1)<br>ERA: 2.57 | 7.0 |     | 28 | 6 | 2 | 2  | 2  | 1  | 0   | 0   | 0   | 0  | 1  | 31 | 35 | 2.57 | 1.000 |
| Dick Hall, R (8, 1)<br>ERA: 2.68      | 2.0 | W   | 7  | 1 | 0 | 0  | 1  | 0  | 0   | 0   | 0   | 0  | 0  | 9  | 9  | 0.00 | 0.500 |

**BOTTOM**

**Baltimore Orioles @ Kansas City Athletics**  
Municipal Stadium, Kansas City, MO

Sat Aug 01 1964, 8:05 PM EDT  
Att. 25,003 - Unknown

|            |           |
|------------|-----------|
| <b>AB</b>  | <b>32</b> |
| <b>R</b>   | <b>2</b>  |
| <b>H</b>   | <b>7</b>  |
| <b>RBI</b> | <b>2</b>  |
| <b>BB</b>  | <b>1</b>  |
| <b>SO</b>  | <b>3</b>  |
| <b>LOB</b> | <b>12</b> |



| Batter  | 1   | 2                               | 3                            | 4                                | 5                            | 6                               | 7                            | 8                               | 9                            | AB R H RBI BB SO LOB            | TOP                          |                                 |                              |                                  |                              |                                 |                                   |                                    |                                  |        |  |  |  |  |  |  |  |  |  |  |  |  |  |  |  |  |
|---|---|---------------------------------|------------------------------|----------------------------------|------------------------------|---------------------------------|------------------------------|---------------------------------|------------------------------|---------------------------------|------------------------------|---------------------------------|------------------------------|----------------------------------|------------------------------|---------------------------------|-----------------------------------|------------------------------------|----------------------------------|--------|--|--|--|--|--|--|--|--|--|--|--|--|--|--|--|--|
| Jackie Brandt, R (1, 8)<br>OBP: 0.309, SLG: 0.404   | 0-0 L7<br>BBB   | 4-0 1B<br>1-2 2-3 BB            |                              | 0-0 FC4-6 E<br>HR 1B             | 0-3 K                        |                                 |                              | 0-0 2B<br>2B                    | 0-0 F5                       | 5 2 2 0 1 1 3                   |                              |                                 |                              |                                  |                              |                                 |                                   |                                    |                                  |        |  |  |  |  |  |  |  |  |  |  |  |  |  |  |  |  |
| Luis Aparicio, R (1, 6)<br>OBP: 0.323, SLG: 0.385   | 0-0 E S<br>1B   | 0-0 S<br>1B                     |                              | 0-0 E8<br>FC4-6                  | 0-0 F8                       |                                 |                              | 0-0 6-3                         |                              | 5 1 2 2 0 0 3                   |                              |                                 |                              |                                  |                              |                                 |                                   |                                    |                                  |        |  |  |  |  |  |  |  |  |  |  |  |  |  |  |  |  |
| Norm Siebern, L (1, 3)<br>OBP: 0.383, SLG: 0.370    | 0-3 K<br>1-3  | 0-0 F9<br>1-2                   |                              | 0-0 FC4-6<br>HR                  |                              | 0-0 4-3                         |                              | 0-0 2B                          |                              | 5 1 1 1 0 1 5                   |                              |                                 |                              |                                  |                              |                                 |                                   |                                    |                                  |        |  |  |  |  |  |  |  |  |  |  |  |  |  |  |  |  |
| Boog Powell, L (1, 7)<br>OBP: 0.380, SLG: 0.615     | 0-0 FC3-4<br>1B                                       |                                 | 4-0 2B<br>BB                 | 0-0 1-H<br>HR                    |                              | 0-0 F6                          |                              | 4-0 IBB                         |                              | 3 2 2 4 2 0 0                   |                              |                                 |                              |                                  |                              |                                 |                                   |                                    |                                  |        |  |  |  |  |  |  |  |  |  |  |  |  |  |  |  |  |
| Brooks Robinson, R (1, 5)<br>OBP: 0.361, SLG: 0.478 | 0-0 FC3-4<br>1-2f                                     |                                 | 0-0 1-H<br>2B                | 0-0 F2                           |                              | 0-3 K                           |                              | 0-0 F9                          |                              | 5 0 1 1 0 1 3                   |                              |                                 |                              |                                  |                              |                                 |                                   |                                    |                                  |        |  |  |  |  |  |  |  |  |  |  |  |  |  |  |  |  |
| Sam Bowens, R (1, 9)<br>OBP: 0.324, SLG: 0.459      |   | 0-0 F7                          | 0-0 F7                       | 0-0 E<br>1B                      |                              | 0-0 F3                          |                              | 0-0 1B<br>1B                    |                              | 5 0 2 0 0 0 0                   |                              |                                 |                              |                                  |                              |                                 |                                   |                                    |                                  |        |  |  |  |  |  |  |  |  |  |  |  |  |  |  |  |  |
| Dick Brown, R (1, 2)<br>OBP: 0.329, SLG: 0.478      |   | 4-0 BB 1B<br>1B BB              | 0-0 1B<br>1B                 | 0-0 F8<br>1-2                    |                              | 0-3 K                           |                              | 0-0 6-3<br>1B                   |                              | 4 1 2 0 1 1 1                   |                              |                                 |                              |                                  |                              |                                 |                                   |                                    |                                  |        |  |  |  |  |  |  |  |  |  |  |  |  |  |  |  |  |
| Jerry Adair, R (1, 4)<br>OBP: 0.290, SLG: 0.326     |   | 0-0 BB<br>1B 1B                 | 0-0 1-2<br>1B                |                                  | 0-0 WP<br>1B                 |                                 | 0-0 F9                       |                                 | 0-0 6-3                      | 5 1 3 0 0 0 2                   |                              |                                 |                              |                                  |                              |                                 |                                   |                                    |                                  |        |  |  |  |  |  |  |  |  |  |  |  |  |  |  |  |  |
| Robin Roberts, S (1, 1)<br>OBP: 0.154, SLG: 0.083   |   | 0-0 F5                          | 0-0 F8                       |                                  | 0-3 K                        |                                 |                              | 0-3 K                           | 0-3 K                        | 2 0 0 0 0 0 4                   |                              |                                 |                              |                                  |                              |                                 |                                   |                                    |                                  |        |  |  |  |  |  |  |  |  |  |  |  |  |  |  |  |  |
| Steve Barber, L (4, 1)<br>OBP: 0.273, SLG: 0.323    |   |                                 |                              |                                  |                              |                                 |                              |                                 |                              | 1 0 0 0 0 1 1                   |                              |                                 |                              |                                  |                              |                                 |                                   |                                    |                                  |        |  |  |  |  |  |  |  |  |  |  |  |  |  |  |  |  |
| John Orsino, R (8, PH)<br>OBP: 0.290, SLG: 0.356    |   |                                 |                              |                                  |                              |                                 |                              |                                 |                              | 1 0 0 0 0 1 0                   |                              |                                 |                              |                                  |                              |                                 |                                   |                                    |                                  |        |  |  |  |  |  |  |  |  |  |  |  |  |  |  |  |  |
| Harvey Haddix, L (8, 1)                             |   |                                 |                              |                                  |                              |                                 |                              |                                 |                              | 1 0 0 0 0 1 2                   |                              |                                 |                              |                                  |                              |                                 |                                   |                                    |                                  |        |  |  |  |  |  |  |  |  |  |  |  |  |  |  |  |  |
| <b>Inning Stats</b>                                 | R: 1<br>E: 0<br>K: 1<br>S: 7                          | H: 2<br>LOB: 1<br>BB: 0<br>P: 7 | R: 2<br>E: 0<br>K: 0<br>S: 5 | H: 2<br>LOB: 2<br>BB: 2<br>P: 13 | R: 1<br>E: 0<br>K: 0<br>S: 5 | H: 3<br>LOB: 2<br>BB: 1<br>P: 9 | R: 3<br>E: 2<br>K: 0<br>S: 7 | H: 3<br>LOB: 1<br>BB: 0<br>P: 7 | R: 0<br>E: 0<br>K: 1<br>S: 5 | H: 0<br>LOB: 0<br>BB: 0<br>P: 5 | R: 0<br>E: 0<br>K: 1<br>S: 5 | H: 0<br>LOB: 0<br>BB: 0<br>P: 5 | R: 1<br>E: 0<br>K: 1<br>S: 7 | H: 2<br>LOB: 2<br>BB: 1<br>P: 11 | R: 0<br>E: 0<br>K: 1<br>S: 7 | H: 2<br>LOB: 2<br>BB: 0<br>P: 7 | 1B: 11<br>2B: 3<br>3B: 0<br>HR: 1 | SF: 0<br>SAC: 0<br>DP: 0<br>HBP: 0 | WP: 1<br>PB: 0<br>SB: 2<br>CS: 0 | PA: 46 |  |  |  |  |  |  |  |  |  |  |  |  |  |  |  |  |
| <b>PITCHER</b>                                      | IP WLS BF H R ER SO BB IBB HBP BLK WP HR S P ERA WHIP |                                 |                              |                                  |                              |                                 |                              |                                 |                              |                                 |                              |                                 |                              |                                  |                              |                                 |                                   |                                    |                                  |        |  |  |  |  |  |  |  |  |  |  |  |  |  |  |  |  |
| Diego Segui, R (1, 1)<br>ERA: 3.86                  | 2.1   |                                 | 14                           | 5                                | 4                            | 4                               | 1                            | 3                               | 0                            | 0                               | 0                            | 0                               | 0                            | 13                               | 25                           | 15.43                           | 3.429                             |                                    |                                  |        |  |  |  |  |  |  |  |  |  |  |  |  |  |  |  |  |
| Ted Bowsfield, L (3, 1)<br>ERA: 4.18                | 1.0   |                                 | 8                            | 4                                | 3                            | 2                               | 0                            | 0                               | 0                            | 0                               | 0                            | 0                               | 1                            | 8                                | 8                            | 18.00                           | 4.000                             |                                    |                                  |        |  |  |  |  |  |  |  |  |  |  |  |  |  |  |  |  |
| Moe Drabowsky, R (4, 1)<br>ERA: 5.75                | 4.2   | L                               | 19                           | 4                                | 1                            | 1                               | 5                            | 0                               | 1                            | 0                               | 0                            | 1                               | 0                            | 28                               | 32                           | 1.93                            | 0.857                             |                                    |                                  |        |  |  |  |  |  |  |  |  |  |  |  |  |  |  |  |  |
| Wes Stock, R (9, 1)<br>ERA: 2.49                    | 0.0   |                                 | 0                            | 0                                | 0                            | 0                               | 0                            | 0                               | 0                            | 0                               | 0                            | 0                               | 0                            | 0                                | ∞                            | ∞                               |                                   |                                    |                                  |        |  |  |  |  |  |  |  |  |  |  |  |  |  |  |  |  |

Baltimore Orioles @ Kansas City Athletics  
Municipal Stadium, Kansas City, MO  
Sun Aug 02 1964, 4:33 AM EDT  
Att. 7,652 - Unknown

livebaseballscorecards.com

|     |    |
|-----|----|
| AB  | 42 |
| R   | 8  |
| H   | 15 |
| RBI | 8  |
| BB  | 4  |
| SO  | 7  |
| LOB | 24 |



| Batter   | 1          | 2                | 3          | 4                      | 5 | 6                | 7 | 8          | 9                  | AB | R | H | RBI | BB | SO | LOB |
|--|------------|------------------|------------|------------------------|---|------------------|---|------------|--------------------|----|---|---|-----|----|----|-----|
| Bert Campaneris, R (1, 6)<br>OBP: 0.426, SLG: 0.674  | 0-0<br>HR  | 0-0<br>1-2<br>1B |            | 0-0<br>1-3<br>HR<br>2B |   | 0-0<br>1-3       |   | 1-0<br>HBP |                    | 4  | 2 | 3 | 1   | 0  | 0  | 0   |
| Wayne Causey, L (1, 4)<br>OBP: 0.383, SLG: 0.382   | 0-0<br>1B  | 0-0<br>F7        |            | 0-3<br>K               |   | 0-0<br>F3        |   | 0-0<br>F9  |                    | 5  | 0 | 1 | 0   | 0  | 1  | 5   |
| Ed Charles, R (1, 5)<br>OBP: 0.324, SLG: 0.387   | 0-3<br>K   |                  | 0-0<br>F9  | 0-0<br>HR              |   | 4-0<br>BB        |   |            | 0-0<br>FC5-6<br>1B | 4  | 1 | 2 | 3   | 1  | 1  | 1   |
| Jim Gentile, L (1, 3)<br>OBP: 0.375, SLG: 0.488<br>Dick Green, R (9, PR)<br>OBP: 0.291, SLG: 0.399   | 0-0<br>F5  |                  | 0-0<br>HR  | 0-3<br>K               |   | 0-0<br>G3        |   |            | 0-0<br>FC5-6       | 5  | 1 | 1 | 1   | 0  | 1  | 3   |
| Rocky Colavito, R (1, 9)<br>OBP: 0.355, SLG: 0.528   | 0-0<br>6-3 |                  | 0-0<br>1-3 |                        |   | 0-0<br>F7        |   | 0-0<br>5-3 | 0-0<br>F8          | 5  | 0 | 0 | 0   | 0  | 0  | 2   |
| Manny Jimenez, L (1, 7)<br>OBP: 0.294, SLG: 0.532  |            | 0-0<br>HR        | 0-0<br>F7  |                        |   | 0-0<br>1B<br>1B  |   | 0-0<br>6-3 | 0-0<br>4-3         | 5  | 1 | 2 | 1   | 0  | 0  | 1   |
| Doc Edwards, R (1, 2)<br>OBP: 0.253, SLG: 0.293<br>Billy Bryan, L (4, PH)<br>OBP: 0.296, SLG: 0.507  |            | 0-0<br>F4        |            | 0-0<br>1B<br>2B        |   | 0-0<br>F8        |   | 0-3<br>K   |                    | 1  | 0 | 0 | 0   | 0  | 0  | 0   |
| Nelson Mathews, R (1, 8)<br>OBP: 0.292, SLG: 0.346   |            | 0-0<br>1B<br>1B  |            | 0-0<br>2B<br>HR<br>1B  |   | 0-0<br>1-2<br>1B |   | 0-3<br>K   |                    | 4  | 1 | 3 | 1   | 0  | 1  | 0   |
| Diego Segui, R (1, 1)<br>OBP: 0.193, SLG: 0.236<br>Ted Bowsfield, R (3, 1)<br>OBP: 0.150, SLG: 0.105<br>Moe Drabowsky, R (4, 1)<br>OBP: 0.028, SLG: 0.028<br>George Alusik, R (8, PH)<br>OBP: 0.361, SLG: 0.371<br>Wes Stock, R (9, 1)<br>OBP: 0.154, SLG: 0.083 |            | 0-3<br>K         |            | 0-0<br>F9              |   | 0-0<br>F8        |   | 0-3<br>K   | 0-3<br>K           | 1  | 0 | 0 | 0   | 0  | 1  | 1   |

| Inning Stats | R: 1 | H: 2 | E: 0 | K: 1 | S: 7 | H: 3 | LOB: 1 | BB: 0 | P: 7 | R: 1 | H: 3 | E: 0 | K: 1 | S: 8 | R: 1 | H: 1 | E: 0 | K: 0 | S: 4 | R: 4 | H: 4 | E: 0 | K: 2 | S: 11 | R: 0 | H: 2 | E: 0 | K: 0 | S: 5 | R: 0 | H: 0 | E: 0 | K: 1 | S: 5 | R: 0 | H: 0 | E: 0 | K: 2 | S: 7 | R: 0 | H: 0 | E: 0 | K: 2 | S: 7 | R: 0 | H: 1 | E: 0 | K: 0 | S: 4 | 1B: 7 | 2B: 2 | 3B: 0 | HR: 4 | SF: 0 | SAC: 0 | DP: 0 | HBP: 1 | WP: 0 | PA: 42 |
|--------------|------|------|------|------|------|------|--------|-------|------|------|------|------|------|------|------|------|------|------|------|------|------|------|------|-------|------|------|------|------|------|------|------|------|------|------|------|------|------|------|------|------|------|------|------|------|------|------|------|------|------|-------|-------|-------|-------|-------|--------|-------|--------|-------|--------|
|--------------|------|------|------|------|------|------|--------|-------|------|------|------|------|------|------|------|------|------|------|------|------|------|------|------|-------|------|------|------|------|------|------|------|------|------|------|------|------|------|------|------|------|------|------|------|------|------|------|------|------|------|-------|-------|-------|-------|-------|--------|-------|--------|-------|--------|

| PITCHER                              | IP  | WLS | BF | H | R | ER | SO | BB | IBB | HBP | BLK | WP | HR | S  | P  | ERA   | WHIP  |
|--------------------------------------|-----|-----|----|---|---|----|----|----|-----|-----|-----|----|----|----|----|-------|-------|
| Robin Roberts, R (1, 1)<br>ERA: 3.03 | 3.0 |     | 17 | 8 | 5 | 5  | 2  | 0  | 0   | 0   | 0   | 0  | 3  | 21 | 21 | 15.00 | 2.667 |
| Steve Barber, L (4, 1)<br>ERA: 4.09  | 4.0 | W   | 17 | 4 | 2 | 2  | 3  | 1  | 0   | 0   | 0   | 0  | 1  | 22 | 26 | 4.50  | 1.250 |
| Harvey Haddix, L (8, 1)<br>ERA: 1.98 | 2.0 | S   | 8  | 1 | 0 | 0  | 2  | 0  | 0   | 1   | 0   | 0  | 0  | 11 | 12 | 0.00  | 0.500 |

BOTTOM

Baltimore Orioles @ Kansas City Athletics  
Municipal Stadium, Kansas City, MO

livebaseballscores.com

|     |    |
|-----|----|
| AB  | 40 |
| R   | 7  |
| H   | 13 |
| RBI | 7  |
| BB  | 1  |
| SO  | 7  |
| LOB | 17 |



Sun Aug 02 1964, 4:33 AM EDT  
Att. 7,652 - Unknown

| Batter   | 1   | 2   | 3   | 4   | 5   | 6  | 7   | 8   | 9   | AB R H RBI BB SO LOB                                       | TOP  |
|--|---|---|---|---|---|--|---|---|---|--|--|
| Tony Kubek, L (1, 6)<br>OBP: 0.273, SLG: 0.331       | 0-0<br>FC4<br>1B                                      |   | 0-0<br>5-3  |   | 0-0<br>3-1  |  |   | 0-0<br>F7   |   | 4 0 1 0 0 0 0  | <b>New York Yankees @ Kansas City Athletics</b><br>Municipal Stadium, Kansas City, MO<br>Tue Aug 04 1964, 8:05 PM EDT<br>Att: 18,232 - Unknown |
| Bobby Richardson, R (1, 4)<br>OBP: 0.285, SLG: 0.326 | 0-0<br>FC4<br>1-2f<br>FC6-4<br>1B                     |   | 0-0<br>FC6-4<br>1B                                  |   |   | 0-0<br>F8  |   | 0-0<br>1B   |   | 4 0 2 0 0 0 1  |  |
| Tom Tresh, S (1, 7)<br>OBP: 0.378, SLG: 0.450        | 0-0<br>P4   |   | 0-0<br>FC6-4<br>1-2f                                |   |   | 0-3<br>K   |   | 0-3<br>K  |   | 4 0 0 0 0 2 3  |  |
| Mickey Mantle, S (1, 8)<br>OBP: 0.445, SLG: 0.611    | 0-0<br>FC6-4<br>1-2f                                  |   |   | 0-3<br>K  |   | 3-0<br>HR  |   | 0-0<br>1B   |   | 4 1 2 1 0 1 1  |  |
| Elston Howard, R (1, 2)<br>OBP: 0.348, SLG: 0.410    |   | 0-0<br>5-3  |   | 0-0<br>FC5-4<br>1B                                  |   | 0-3<br>K   |   | 0-3<br>K  |   | 4 0 1 0 0 2 1  |  |
| Hector Lopez, R (1, 9)<br>OBP: 0.328, SLG: 0.443     |   | 0-0<br>FC6-4<br>1B                                  |   | 0-0<br>F4   |   |  | 0-0<br>F9   |   | 0-3<br>K  | 4 0 1 0 0 1 2  |  |
| Pedro Gonzalez, R (1, 3)<br>OBP: 0.318, SLG: 0.375   |   | 0-0<br>FC6-4<br>1-2f                                |   | 0-0<br>FC5-4<br>1-2f                                |   |  | 0-0<br>CS<br>1B                                     |   | 0-0<br>1-3  | 4 0 1 0 0 0 3  |  |
| Clete Boyer, R (1, 5)<br>OBP: 0.282, SLG: 0.316      |   | 0-0<br>F7   |   |   | 0-0<br>F8   |  | 0-3<br>K<br>1-2                                     |   |   | 3 0 0 0 0 1 2  |  |
| Whitey Ford, L (1, 1)<br>OBP: 0.273, SLG: 0.170      |   |   | 0-0<br>6-3  |   | 0-3<br>K  |  |   | 0-3<br>K  |   | 2 0 0 0 0 1 0  |  |
| Roger Maris, L (8, PH)<br>OBP: 0.355, SLG: 0.449     |   |   |   |   |   |  |   |   |   | 1 0 0 0 0 1 0  |  |
| Hal Reniff, R (8, 1)<br>OBP: 0.111, SLG: 0.111       |   |   |   |   |   |  |   |   |   | 0 0 0 0 0 0 0  |  |
| <b>Inning Stats</b>                                  | R: 0 H: 1<br>E: 0 LOB: 1<br>K: 0 BB: 0<br>S: 4 P: 4   | R: 0 H: 1<br>E: 0 LOB: 1<br>K: 0 BB: 0<br>S: 4 P: 4 | R: 0 H: 1<br>E: 0 LOB: 1<br>K: 0 BB: 0<br>S: 4 P: 4 | R: 0 H: 1<br>E: 0 LOB: 1<br>K: 1 BB: 0<br>S: 6 P: 6 | R: 0 H: 0<br>E: 0 LOB: 0<br>K: 1 BB: 0<br>S: 5 P: 5 | R: 1 H: 1<br>E: 0 LOB: 0<br>K: 2 BB: 0<br>S: 8 P: 11 | R: 0 H: 1<br>E: 0 LOB: 0<br>K: 1 BB: 0<br>S: 5 P: 5 | R: 0 H: 1<br>E: 0 LOB: 1<br>K: 2 BB: 0<br>S: 8 P: 8 | R: 0 H: 1<br>E: 0 LOB: 1<br>K: 2 BB: 0<br>S: 8 P: 8 | 1B: 7 SF: 0<br>2B: 0 SAC: 0<br>3B: 0 DP: 0<br>HR: 1 HBP: 0 | WP: 0 PA: 34<br>PB: 0<br>SB: 0<br>CS: 1  |
| <b>PITCHER</b>                                       | IP WLS BF H R ER SO BB IBB HBP BLK WP HR S P ERA WHIP |   |   |   |   |  |   |   |   |  |  |
| John O'Donoghue, L (1, 1)<br>ERA: 4.26               | 6.1 W 25 6 1 1 4 0 0 0 0 0 1 33 36 1.42 0.947         |   |   |   |   |  |   |   |   |  |  |
| Wes Stock, R (7, 1)<br>ERA: 2.4                      | 2.2 S 9 2 0 0 5 0 0 0 0 0 0 0 19 19 0.00 0.750        |   |   |   |   |  |   |   |   |  |  |

livebaseballscorecards.com

|     |    |
|-----|----|
| AB  | 34 |
| R   | 1  |
| H   | 8  |
| RBI | 1  |
| BB  | 0  |
| SO  | 9  |
| LOB | 13 |



| Batter  | 1                             | 2               | 3                          | 4               | 5                | 6                                | 7                      | 8                                    | 9 |
|---|-------------------------------|-----------------|----------------------------|-----------------|------------------|----------------------------------|------------------------|--------------------------------------|---|
| Bert Campaneris, R<br>OBP: 0.423, SLG: 0.630<br>(1, 6)  | 0-0<br>5-3<br>①               |                 | 4-0<br>P6<br>BB            |                 | 0-0<br>F3<br>②   |                                  | 0-0<br>6-3<br>①        | 4-0<br>BB<br>BB<br>1-2<br>2-3        |   |
| Wayne Causey, L<br>OBP: 0.381, SLG: 0.378<br>(1, 4)   | 0-3<br>K<br>②                 |                 | 0-0<br>P6<br>1-2<br>①<br>② |                 | 0-3<br>K<br>③    |                                  | 0-0<br>E6<br>2B<br>②   | 4-0<br>BB<br>BB<br>1-2<br>2-3<br>3-H |   |
| Ed Charles, R<br>OBP: 0.327, SLG: 0.391<br>(1, 5)   | 0-0<br>BB<br>BB<br>1B         |                 | 0-0<br>5-3<br>③            |                 |                  | 4-0<br>BB<br>BB<br>2B<br>BB<br>① | 0-0<br>2B<br>2B<br>2-H | 0-0<br>F4<br>③                       |   |
| Rocky Colavito, R<br>OBP: 0.354, SLG: 0.524<br>(1, 9)   | 4-0<br>BB<br>1-2<br>BB        |                 |                            | 0-0<br>5-3<br>① |                  | 0-0<br>F7<br>1-2<br>①            | 0-0<br>6-3<br>③        |                                      |   |
| Jim Gentile, L<br>OBP: 0.377, SLG: 0.485<br>(1, 3)  | 4-0<br>BB<br>1-2<br>2-3<br>BB |                 |                            | 0-3<br>K<br>②   |                  | 4-0<br>BB<br>BB<br>2B<br>E<br>BB |                        | 0-0<br>G3<br>①                       |   |
| Doc Edwards, R<br>OBP: 0.253, SLG: 0.298<br>(1, 2)  | 0-0<br>1-3<br>③               |                 |                            | 0-3<br>K<br>③   |                  | 0-0<br>E6<br>1-H<br>2-H<br>2B    |                        | 0-0<br>5-3<br>②                      |   |
| Manny Jimenez, L<br>OBP: 0.288, SLG: 0.521<br>Jose Tartabull, L<br>OBP: 0.260, SLG: 0.268<br>(1, 7)<br>(7, 7) |                               | 0-3<br>K<br>①   |                            |                 | 0-0<br>1-3<br>①  | 0-0<br>6-3<br>②                  |                        | 0-0<br>1B<br>2B                      |   |
| Nelson Mathews, R<br>OBP: 0.296, SLG: 0.346<br>(1, 8)   |                               | 0-0<br>4-3<br>② |                            |                 | 0-0<br>SH<br>1B  | 4-0<br>IBB                       |                        | 4-0<br>BB<br>1B<br>BB<br>IBB         |   |
| John O'Donoghue, R<br>OBP: 0.211, SLG: 0.289<br>Wes Stock, R<br>OBP: 0.214, SLG: 0.154<br>(1, 1)<br>(7, 1)    |                               | 0-3<br>K<br>③   |                            |                 | 0-0<br>SH<br>1-2 | 0-0<br>L4<br>③                   |                        | 0-0<br>BB<br>BB<br>1-2<br>2-H<br>1B  |   |

| Inning Stats | R: 0 | H: 1 | E: 0 | LOB: 3 | K: 1 | S: 6 | P: 14 | R: 0 | H: 0 | E: 0 | LOB: 0 | K: 2 | S: 7 | R: 0 | H: 0 | E: 0 | LOB: 0 | K: 0 | S: 2 | R: 0 | H: 0 | E: 0 | LOB: 0 | K: 2 | S: 7 | R: 0 | H: 1 | E: 0 | LOB: 2 | K: 1 | S: 7 | R: 2 | H: 1 | E: 1 | LOB: 2 | K: 0 | S: 4 | R: 1 | H: 1 | E: 1 | LOB: 0 | K: 0 | S: 4 | R: 2 | H: 2 | E: 0 | LOB: 3 | K: 0 | S: 5 |
|--------------|------|------|------|--------|------|------|-------|------|------|------|--------|------|------|------|------|------|--------|------|------|------|------|------|--------|------|------|------|------|------|--------|------|------|------|------|------|--------|------|------|------|------|------|--------|------|------|------|------|------|--------|------|------|
|              | 0    | 1    | 0    | 3      | 1    | 6    | 14    | 0    | 0    | 0    | 0      | 2    | 7    | 0    | 0    | 0    | 0      | 0    | 2    | 0    | 0    | 0    | 0      | 0    | 0    | 7    | 0    | 1    | 2      | 0    | 7    | 2    | 1    | 1    | 2      | 0    | 4    | 1    | 1    | 0    | 0      | 4    | 2    | 0    | 3    | 0    | 5      |      |      |

| PITCHER                               | IP  | WLS | BF | H | R | ER | SO | BB | IBB | HBP | BLK | WP | HR | S  | P  | ERA   | WHIP  |
|---------------------------------------|-----|-----|----|---|---|----|----|----|-----|-----|-----|----|----|----|----|-------|-------|
| Whitey Ford, L<br>ERA: 2.18<br>(1, 1) | 7.0 | L   | 31 | 4 | 3 | 1  | 6  | 5  | 1   | 0   | 0   | 0  | 0  | 37 | 61 | 1.29  | 1.286 |
| Hal Reniff, R<br>ERA: 2.96<br>(8, 1)  | 1.0 |     | 8  | 2 | 2 | 2  | 0  | 2  | 1   | 0   | 0   | 0  | 0  | 5  | 17 | 18.00 | 4.000 |

| PITCHER | IP | WLS | BF | H | R | ER | SO | BB | IBB | HBP | BLK | WP | HR | S | P | ERA | WHIP |
|---------|----|-----|----|---|---|----|----|----|-----|-----|-----|----|----|---|---|-----|------|
|         |    |     |    |   |   |    |    |    |     |     |     |    |    |   |   |     |      |

AB R H RBI BB SO LOB

|   |   |   |   |   |   |   |
|---|---|---|---|---|---|---|
| 3 | 0 | 0 | 0 | 2 | 0 | 2 |
| 4 | 1 | 0 | 1 | 1 | 2 | 3 |
| 4 | 1 | 2 | 1 | 1 | 0 | 3 |
| 3 | 0 | 0 | 0 | 1 | 0 | 1 |
| 2 | 1 | 0 | 0 | 2 | 1 | 0 |
| 4 | 0 | 1 | 1 | 0 | 1 | 3 |
| 3 | 0 | 0 | 0 | 0 | 1 | 1 |
| 1 | 1 | 1 | 0 | 0 | 0 | 0 |
| 2 | 1 | 1 | 0 | 2 | 0 | 0 |
| 2 | 0 | 0 | 0 | 0 | 1 | 2 |
| 1 | 0 | 1 | 1 | 0 | 0 | 0 |

|     |    |
|-----|----|
| AB  | 29 |
| R   | 5  |
| H   | 6  |
| RBI | 4  |
| BB  | 9  |
| SO  | 6  |
| LOB | 15 |

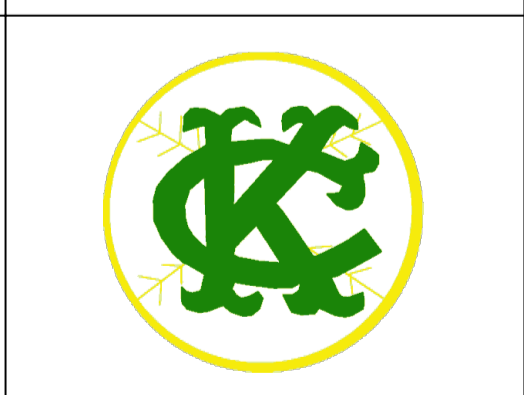

| WP | PA | 3B | SF | SAC | DP | HBP | CS |
|----|----|----|----|-----|----|-----|----|
| 0  | 39 | 0  | 0  | 1   | 0  | 0   | 0  |

**New York Yankees @ Kansas City Athletics**  
Municipal Stadium, Kansas City, MO  
Tue Aug 04 1964, 8:05 PM EDT  
Att. 18,232 - Unknown

livebaseballscorecards.com

| Batter   | 1   | 2                                | 3                            | 4                               | 5                            | 6                               | 7                            | 8                               | 9                            | AB R H RBI BB SO LOB   | TOP   |                                 |   |                                 |                              |                                 |                              |                                 |                                  |                                    |                                  |        |
|--|---|----------------------------------|------------------------------|---------------------------------|------------------------------|---------------------------------|------------------------------|---------------------------------|------------------------------|--|---|---------------------------------|---|---------------------------------|------------------------------|---------------------------------|------------------------------|---------------------------------|----------------------------------|------------------------------------|----------------------------------|--------|
| Tony Kubek, L (1, 6)<br>OBP: 0.273, SLG: 0.328<br>Phil Linz, R (8, 6)<br>OBP: 0.318, SLG: 0.357  | 0-0<br>4-3  |                                  | 0-0<br>F9                    |                                 |                              | 4-0<br>FC5-4<br>BB              |                              | 0-3<br>K                        |                              | 3 0 0 0 1 1 0<br>0 0 0 0 0 0 0   | <p><b>New York Yankees @ Kansas City Athletics</b><br/>Municipal Stadium, Kansas City, MO</p> <p>Wed Aug 05 1964, 8:05 PM EDT<br/>Att: 22,784 - Unknown</p> <p>livebaseballscorecards.com</p> |                                 |   |                                 |                              |                                 |                              |                                 |                                  |                                    |                                  |        |
| Bobby Richardson, R (1, 4)<br>OBP: 0.286, SLG: 0.328<br>Pedro Gonzalez, R (8, 4)<br>OBP: 0.318, SLG: 0.375   | 4-0<br>BB<br>BB   |                                  | 0-0<br>1-3                   |                                 |                              | 0-0<br>FC5-4<br>1B<br>1-2f      |                              | 0-0<br>G3<br>2B                 |                              | 3 0 1 0 1 0 1<br>0 0 0 0 0 0 0   |   |                                 |   |                                 |                              |                                 |                              |                                 |                                  |                                    |                                  |        |
| Roger Maris, L (1, 9)<br>OBP: 0.359, SLG: 0.451  | 4-0<br>1-2<br>BB  |                                  |                              | 0-0<br>FC3-6<br>1B              |                              | 0-0<br>1-3<br>1B                |                              | 0-0<br>G3<br>2-3                |                              | 3 0 2 0 1 0 1  |   |                                 |   |                                 |                              |                                 |                              |                                 |                                  |                                    |                                  |        |
| Mickey Mantle, S (1, 8)<br>OBP: 0.440, SLG: 0.603<br>Hector Lopez, R (8, 8)<br>OBP: 0.328, SLG: 0.443  | 0-3<br>K  |                                  |                              | 0-0<br>F5                       |                              | 0-0<br>4-3                      |                              | 0-0<br>1-3                      |                              | 4 0 0 0 0 1 5<br>0 0 0 0 0 0 0   |   |                                 |   |                                 |                              |                                 |                              |                                 |                                  |                                    |                                  |        |
| Tom Tresh, S (1, 7)<br>OBP: 0.374, SLG: 0.445  | 0-0<br>F5   |                                  |                              | 0-0<br>FC3-6<br>1-2f            |                              |                                 | 0-0<br>L9                    |                                 | 0-3<br>K                     | 4 0 0 0 0 1 3  |   |                                 |   |                                 |                              |                                 |                              |                                 |                                  |                                    |                                  |        |
| Joe Pepitone, L (1, 3)<br>OBP: 0.286, SLG: 0.404   |   | 0-3<br>K                         |                              | 0-0<br>F8                       |                              |                                 | 0-0<br>HR                    |                                 | 0-0<br>F9                    | 4 1 1 1 0 1 1  |   |                                 |   |                                 |                              |                                 |                              |                                 |                                  |                                    |                                  |        |
| Elston Howard, R (1, 2)<br>OBP: 0.350, SLG: 0.411  |   | 0-0<br>6-3                       |                              |                                 | 0-0<br>F3                    |                                 | 0-0<br>1B<br>1B              |                                 | 0-0<br>1B<br>1B              | 4 0 2 0 0 0 0  |   |                                 |   |                                 |                              |                                 |                              |                                 |                                  |                                    |                                  |        |
| Clete Boyer, R (1, 5)<br>OBP: 0.281, SLG: 0.316  |   | 0-0<br>G3                        |                              |                                 | 0-0<br>F4                    |                                 | 0-0<br>P3                    |                                 | 0-0<br>1-2<br>1B             | 4 0 1 0 0 0 1  |   |                                 |   |                                 |                              |                                 |                              |                                 |                                  |                                    |                                  |        |
| Al Downing, R (1, 1)<br>OBP: 0.164, SLG: 0.189<br>Rolie Sheldon, R (6, 1)<br>OBP: 0.143, SLG: 0.143<br>Archie Moore, L (7, PH)<br>OBP: 0.276, SLG: 0.250<br>Pete Mikkelsen, R (7, 1)<br>OBP: 0.083, SLG: 0.167<br>Bill Stafford, R (8, 1)<br>OBP: 0.083, SLG: 0.167<br>Johnny Blanchard, L (9, PH)<br>OBP: 0.357, SLG: 0.361 |   |                                  | 0-0<br>F9                    |                                 | 0-0<br>4-3                   |                                 | 0-3<br>K                     |                                 | 0-0<br>F4                    | 2 0 0 0 0 0 0<br>0 0 0 0 0 0 0<br>1 0 0 0 0 0 1<br>0 0 0 0 0 0 0<br>0 0 0 0 0 0 0<br>1 0 0 0 0 0 2 |   |                                 |   |                                 |                              |                                 |                              |                                 |                                  |                                    |                                  |        |
| <b>Inning Stats</b>  | R: 0<br>E: 0<br>K: 1<br>S: 5  | H: 0<br>LOB: 2<br>BB: 2<br>P: 13 | R: 0<br>E: 0<br>K: 1<br>S: 5 | H: 0<br>LOB: 0<br>BB: 0<br>P: 5 | R: 0<br>E: 0<br>K: 0<br>S: 3 | H: 0<br>LOB: 0<br>BB: 0<br>P: 3 | R: 0<br>E: 0<br>K: 0<br>S: 4 | H: 1<br>LOB: 1<br>BB: 0<br>P: 4 | R: 0<br>E: 0<br>K: 0<br>S: 3 | H: 0<br>LOB: 0<br>BB: 0<br>P: 3  | R: 0<br>E: 0<br>K: 0<br>S: 3  | H: 1<br>LOB: 1<br>BB: 1<br>P: 7 | R: 1<br>E: 0<br>K: 1<br>S: 7                          | H: 2<br>LOB: 1<br>BB: 0<br>P: 7 | R: 0<br>E: 0<br>K: 1<br>S: 6 | H: 1<br>LOB: 1<br>BB: 0<br>P: 6 | R: 0<br>E: 0<br>K: 1<br>S: 7 | H: 2<br>LOB: 2<br>BB: 0<br>P: 7 | 1B: 5<br>2B: 1<br>3B: 0<br>HR: 1 | SF: 0<br>SAC: 0<br>DP: 0<br>HBP: 0 | WP: 0<br>PB: 0<br>SB: 0<br>CS: 0 | PA: 36 |
| <b>PITCHER</b><br>Orlando Pena, R (1, 1)<br>ERA: 4.29  | IP 9.0<br>WLS W<br>BF 36<br>H 7<br>R 1<br>ER 1<br>SO 5<br>BB 3<br>IBB 0<br>HBP 0<br>BLK 0<br>WP 0<br>HR 1<br>S 43<br>P 55<br>ERA 1.00<br>WHIP 1.111 |                                  |                              |                                 |                              |                                 |                              |                                 |                              |  |   | <b>PITCHER</b>                  | IP WLS BF H R ER SO BB IBB HBP BLK WP HR S P ERA WHIP |                                 |                              |                                 |                              |                                 |                                  |                                    |                                  |        |

**New York Yankees @ Kansas City Athletics**  
Municipal Stadium, Kansas City, MO

|     |    |
|-----|----|
| AB  | 33 |
| R   | 1  |
| H   | 7  |
| RBI | 1  |
| BB  | 3  |
| SO  | 5  |
| LOB | 15 |





| Batter   | 1                | 2                                | 3          | 4                          | 5               | 6          | 7                             | 8          | 9 |
|--|------------------|----------------------------------|------------|----------------------------|-----------------|------------|-------------------------------|------------|---|
| Bert Campaneris, R<br>OBP: 0.404, SLG: 0.588<br>(1, 6)   | 0-0<br>L9<br>1B  |                                  | 0-3<br>K   |                            | 0-0<br>F9       |            | 0-3<br>K                      | 0-0<br>L7  |   |
| Wayne Causey, L<br>OBP: 0.380, SLG: 0.377<br>Dick Green, R<br>OBP: 0.290, SLG: 0.398<br>(1, 4)<br>(8, 4)                 | 0-0<br>L9<br>1-2 |                                  |            | 0-0<br>L8                  | 0-3<br>K        |            | 0-0<br>BB<br>1B               | 0-0<br>E6  |   |
| Ed Charles, R<br>OBP: 0.328, SLG: 0.388<br>(1, 5)  | 0-3<br>K         |                                  |            | 0-0<br>1-3                 | 4-0<br>HR<br>BB |            | 4-0<br>1B<br>1-2<br>HBP<br>BB | 0-0<br>5-3 |   |
| Rocky Colavito, R<br>OBP: 0.360, SLG: 0.541<br>(1, 9)  |                  | 0-0<br>E5<br>FC6<br>G6-4-3<br>2B |            | 0-0<br>1B<br>2B            | 0-0<br>HR       |            | 0-0<br>HBP<br>BB<br>1B        |            |   |
| Jim Gentile, L<br>OBP: 0.378, SLG: 0.481<br>(1, 3)   |                  | 0-0<br>FC6<br>G6-4-3<br>2-3      |            | 4-0<br>E<br>1B<br>HR<br>BB | 0-0<br>F7       |            | 4-0<br>FC5<br>HBP<br>BB       |            |   |
| Doc Edwards, R<br>OBP: 0.258, SLG: 0.298<br>(1, 2)   |                  | 0-0<br>G6-4-3<br>1-2f<br>3-H     |            | 0-0<br>HR<br>1B            |                 | 0-0<br>F1  | 1-0<br>HBP                    |            |   |
| George Alusik, R<br>OBP: 0.355, SLG: 0.365<br>Jose Tartabull, L<br>OBP: 0.257, SLG: 0.264<br>(1, 7)<br>(7, PH)<br>(8, 7) |                  | 0-0<br>F6                        |            | 0-0<br>E6<br>HR            |                 | 0-0<br>L6  | 0-0<br>F2                     |            |   |
| Nelson Mathews, R<br>OBP: 0.298, SLG: 0.356<br>(1, 8)  |                  |                                  | 0-0<br>1-3 | 0-0<br>HR                  |                 | 0-0<br>1B  | 0-0<br>FC5                    |            |   |
| Orlando Pena, R<br>OBP: 0.169, SLG: 0.193<br>(1, 1)  |                  |                                  | 0-3<br>K   | 0-3<br>K                   |                 | 0-0<br>1-3 |                               | 0-3<br>K   |   |

| Inning Stats | R: 0 | H: 1 | E: 0 | LOB: 0 | K: 1 | S: 5 | P: 5 | R: 1 | H: 1 | E: 1 | LOB: 0 | K: 0 | S: 4 | P: 4 | R: 0 | H: 0 | E: 0 | LOB: 0 | K: 2 | S: 7 | R: 5 | H: 3 | E: 1 | LOB: 0 | K: 1 | S: 9 | P: 13 | R: 2 | H: 1 | E: 0 | LOB: 1 | K: 0 | S: 4 | R: 2 | H: 2 | E: 0 | LOB: 3 | K: 1 | S: 7 | R: 0 | H: 0 | E: 1 | LOB: 1 | K: 1 | S: 6 | P: 6 |
|--------------|------|------|------|--------|------|------|------|------|------|------|--------|------|------|------|------|------|------|--------|------|------|------|------|------|--------|------|------|-------|------|------|------|--------|------|------|------|------|------|--------|------|------|------|------|------|--------|------|------|------|
|--------------|------|------|------|--------|------|------|------|------|------|------|--------|------|------|------|------|------|------|--------|------|------|------|------|------|--------|------|------|-------|------|------|------|--------|------|------|------|------|------|--------|------|------|------|------|------|--------|------|------|------|

| PITCHER                                  |     |    |    |   |    |    |    |     |     |     |    |    |   |    | PITCHER |       |       |     |    |   |   |    |    |    |     |     |     |    |    |   |   |     |      |  |  |  |  |  |  |  |  |  |  |  |  |  |  |  |  |  |  |  |  |  |
|--|-----|----|----|---|----|----|----|-----|-----|-----|----|----|---|----|---------|-------|-------|-----|----|---|---|----|----|----|-----|-----|-----|----|----|---|---|-----|------|--|--|--|--|--|--|--|--|--|--|--|--|--|--|--|--|--|--|--|--|--|
| IP                                       | WLS | BF | H  | R | ER | SO | BB | IBB | HBP | BLK | WP | HR | S | P  | ERA     | WHIP  | IP    | WLS | BF | H | R | ER | SO | BB | IBB | HBP | BLK | WP | HR | S | P | ERA | WHIP |  |  |  |  |  |  |  |  |  |  |  |  |  |  |  |  |  |  |  |  |  |
| Al Downing, L<br>ERA: 3.35<br>(1, 1)     | 5.0 | L  | 23 | 6 | 8  | 3  | 5  | 2   | 0   | 0   | 0  | 0  | 2 | 31 | 39      | 5.40  | 1.600 |     |    |   |   |    |    |    |     |     |     |    |    |   |   |     |      |  |  |  |  |  |  |  |  |  |  |  |  |  |  |  |  |  |  |  |  |  |
| Rollie Sheldon, R<br>ERA: 3.71<br>(6, 1) | 1.0 |    | 4  | 1 | 0  | 0  | 0  | 0   | 0   | 0   | 0  | 0  | 0 | 4  | 4       | 0.00  | 1.000 |     |    |   |   |    |    |    |     |     |     |    |    |   |   |     |      |  |  |  |  |  |  |  |  |  |  |  |  |  |  |  |  |  |  |  |  |  |
| Pete Mikkelsen, R<br>ERA: 4.33<br>(7, 1) | 1.0 |    | 8  | 2 | 2  | 2  | 1  | 2   | 0   | 1   | 0  | 0  | 0 | 7  | 16      | 18.00 | 4.000 |     |    |   |   |    |    |    |     |     |     |    |    |   |   |     |      |  |  |  |  |  |  |  |  |  |  |  |  |  |  |  |  |  |  |  |  |  |
| Bill Stafford, R<br>ERA: 2.47<br>(8, 1)  | 1.0 |    | 4  | 0 | 0  | 0  | 1  | 0   | 0   | 0   | 0  | 0  | 0 | 6  | 6       | 0.00  | 0.000 |     |    |   |   |    |    |    |     |     |     |    |    |   |   |     |      |  |  |  |  |  |  |  |  |  |  |  |  |  |  |  |  |  |  |  |  |  |

**BOTTOM**

**New York Yankees @ Kansas City Athletics**  
**Municipal Stadium, Kansas City, MO**  
 Wed Aug 05 1964, 8:05 PM EDT  
 Att. 22,784 - Unknown

[livebaseballscorecards.com](http://livebaseballscorecards.com)

|            |           |
|------------|-----------|
| <b>AB</b>  | <b>34</b> |
| <b>R</b>   | <b>10</b> |
| <b>H</b>   | <b>9</b>  |
| <b>RBI</b> | <b>9</b>  |
| <b>BB</b>  | <b>4</b>  |
| <b>SO</b>  | <b>7</b>  |
| <b>LOB</b> | <b>13</b> |



|              |               |
|--------------|---------------|
| <b>WP:</b> 0 | <b>PA:</b> 39 |
| <b>PB:</b> 0 |               |
| <b>SB:</b> 0 |               |
| <b>CS:</b> 0 |               |

| Batter  | 1   | 2                                | 3                            | 4                               | 5                            | 6                               | 7                            | 8                               | 9                            | AB R H RBI BB SO LOB            | TOP   |                                 |                              |                                  |                              |                                 |                              |                                  |                                  |                                    |                                  |        |  |  |  |  |  |
|---|---|----------------------------------|------------------------------|---------------------------------|------------------------------|---------------------------------|------------------------------|---------------------------------|------------------------------|---------------------------------|---|---------------------------------|------------------------------|----------------------------------|------------------------------|---------------------------------|------------------------------|----------------------------------|----------------------------------|------------------------------------|----------------------------------|--------|--|--|--|--|--|
| Tony Kubek, L (1, 6)<br>OBP: 0.278, SLG: 0.330  | 0-0<br>1B   | 4-0<br>FC6-4<br>BB               |                              | 0-0<br>G3                       |                              |                                 | 0-0<br>6-3                   | 0-0<br>1B                       |                              | 4 0 2 1 1 0 1                   |   |                                 |                              |                                  |                              |                                 |                              |                                  |                                  |                                    |                                  |        |  |  |  |  |  |
| Bobby Richardson, R (1, 4)<br>OBP: 0.288, SLG: 0.329  | 0-0<br>1B   | 0-0<br>FC6-4                     |                              |                                 | 0-0<br>F8                    |                                 | 0-0<br>3B<br>1B              | 0-0<br>F7                       |                              | 5 1 2 0 0 0 3                   |   |                                 |                              |                                  |                              |                                 |                              |                                  |                                  |                                    |                                  |        |  |  |  |  |  |
| Roger Maris, L (1, 9)<br>OBP: 0.363, SLG: 0.461   | 4-0<br>1B   |                                  | 0-0<br>BB<br>1B              |                                 | 0-0<br>HR                    |                                 | 0-0<br>F9                    | 0-0<br>4-3                      |                              | 4 1 2 1 1 0 2                   |   |                                 |                              |                                  |                              |                                 |                              |                                  |                                  |                                    |                                  |        |  |  |  |  |  |
| Mickey Mantle, S (1, 8)<br>Hector Lopez, R (9, 7)<br>OBP: 0.439, SLG: 0.597<br>OBP: 0.328, SLG: 0.443 | 0-3<br>K  |                                  | 0-0<br>F9                    |                                 | 4-0<br>BB                    |                                 | 4-0<br>3B<br>BB              |                                 | 0-3<br>K                     | 3 1 0 0 2 2 4<br>0 0 0 0 0 0 0  |   |                                 |                              |                                  |                              |                                 |                              |                                  |                                  |                                    |                                  |        |  |  |  |  |  |
| Tom Tresh, S (1, 7)<br>OBP: 0.377, SLG: 0.450   | 0-3<br>K  |                                  | 4-0<br>BB<br>G4-3            |                                 | 0-0<br>L8                    |                                 | 0-0<br>3B                    | 4-0<br>1B<br>BB<br>G1-2-3       |                              | 3 0 1 2 2 1 4                   |   |                                 |                              |                                  |                              |                                 |                              |                                  |                                  |                                    |                                  |        |  |  |  |  |  |
| Joe Pepitone, L (1, 3)<br>OBP: 0.285, SLG: 0.401  | 0-0<br>L6   |                                  | 0-0<br>BB<br>G4-3            |                                 | 0-0<br>F8                    |                                 | 0-3<br>K                     | 0-0<br>1B                       |                              | 5 0 1 0 0 1 7                   |   |                                 |                              |                                  |                              |                                 |                              |                                  |                                  |                                    |                                  |        |  |  |  |  |  |
| Elston Howard, R (1, 2)<br>OBP: 0.350, SLG: 0.418   |   | 0-0<br>5-3                       |                              | 0-3<br>K                        |                              | 0-0<br>6-3                      |                              | 0-0<br>HR                       | 4-0<br>1B<br>IBB             | 4 1 1 1 1 1 0                   | AB 37<br>R 5<br>H 12<br>RBI 5<br>BB 7<br>SO 6<br>LOB 26                               |                                 |                              |                                  |                              |                                 |                              |                                  |                                  |                                    |                                  |        |  |  |  |  |  |
| Clete Boyer, R (1, 5)<br>OBP: 0.283, SLG: 0.320   |   | 0-0<br>BB<br>1B                  |                              | 0-0<br>4-3                      |                              | 0-3<br>K                        |                              | 0-0<br>1B<br>2B                 | 0-0<br>G1-2-3                | 5 1 2 0 0 1 3                   |   |                                 |                              |                                  |                              |                                 |                              |                                  |                                  |                                    |                                  |        |  |  |  |  |  |
| Ralph Terry, R (1, 1)<br>Hal Reniff, R (8, 1)<br>OBP: 0.250, SLG: 0.231<br>OBP: 0.111, SLG: 0.111     |   | 0-0<br>F3                        |                              | 0-0<br>1B                       |                              | 0-0<br>4-3                      |                              | 0-0<br>3-4                      |                              | 4 0 1 0 0 0 2<br>0 0 0 0 0 0 0  |  |                                 |                              |                                  |                              |                                 |                              |                                  |                                  |                                    |                                  |        |  |  |  |  |  |
| Inning Stats  | R: 0<br>E: 0<br>K: 2<br>S: 9                          | H: 2<br>LOB: 3<br>BB: 1<br>P: 13 | R: 0<br>E: 0<br>K: 0<br>S: 4 | H: 1<br>LOB: 2<br>BB: 1<br>P: 8 | R: 0<br>E: 0<br>K: 0<br>S: 3 | H: 1<br>LOB: 1<br>BB: 1<br>P: 7 | R: 0<br>E: 0<br>K: 1<br>S: 6 | H: 1<br>LOB: 1<br>BB: 0<br>P: 6 | R: 1<br>E: 0<br>K: 0<br>S: 4 | H: 1<br>LOB: 1<br>BB: 1<br>P: 8 | R: 0<br>E: 0<br>K: 1<br>S: 5  | H: 0<br>LOB: 0<br>BB: 0<br>P: 5 | R: 2<br>E: 0<br>K: 1<br>S: 7 | H: 2<br>LOB: 1<br>BB: 1<br>P: 11 | R: 2<br>E: 0<br>K: 0<br>S: 6 | H: 3<br>LOB: 1<br>BB: 0<br>P: 6 | R: 0<br>E: 0<br>K: 1<br>S: 5 | H: 1<br>LOB: 2<br>BB: 2<br>P: 13 | 1B: 8<br>2B: 1<br>3B: 1<br>HR: 2 | SF: 0<br>SAC: 0<br>DP: 2<br>HBP: 0 | WP: 0<br>PB: 0<br>SB: 4<br>CS: 0 | PA: 44 |  |  |  |  |  |
| PITCHER   | IP WLS BF H R ER SO BB IBB HBP BLK WP HR S P ERA WHIP |                                  |                              |                                 |                              |                                 |                              |                                 |                              |                                 |   |                                 |                              |                                  |                              |                                 |                              |                                  |                                  |                                    |                                  |        |  |  |  |  |  |
| Diego Segui, R (1, 1)<br>ERA: 3.79  | 5.0   |                                  | 24                           | 6                               | 1                            | 1                               | 3                            | 4                               | 0                            | 0                               | 0   | 0                               | 1                            | 26                               | 42                           | 1.80                            | 2.000                        |                                  |                                  |                                    |                                  |        |  |  |  |  |  |
| Jose Santiago, R (6, 1)<br>ERA: 5.0   | 2.0   | L                                | 9                            | 2                               | 2                            | 2                               | 2                            | 1                               | 0                            | 0                               | 0   | 0                               | 0                            | 12                               | 16                           | 9.00                            | 1.500                        |                                  |                                  |                                    |                                  |        |  |  |  |  |  |
| John Wyatt, R (8, 1)<br>ERA: 3.98   | 0.1   |                                  | 4                            | 3                               | 2                            | 2                               | 0                            | 0                               | 0                            | 0                               | 0   | 0                               | 1                            | 4                                | 4                            | 54.00                           | 9.000                        |                                  |                                  |                                    |                                  |        |  |  |  |  |  |
| Ken Sanders, R (8, 1)<br>ERA:   | 1.2   |                                  | 7                            | 1                               | 0                            | 0                               | 1                            | 1                               | 1                            | 0                               | 0   | 0                               | 0                            | 7                                | 15                           | 0.00                            | 1.200                        |                                  |                                  |                                    |                                  |        |  |  |  |  |  |

**New York Yankees @ Kansas City Athletics**  
Municipal Stadium, Kansas City, MO  
Thu Aug 06 1964, 4:33 AM EDT  
Att: 14,881 - Unknown

livebaseballscorecards.com

BOTTOM

New York Yankees @ Kansas City Athletics  
Municipal Stadium, Kansas City, MO

AB 34  
R 3  
H 7  
RBI 3  
BB 2  
SO 7  
LOB 10

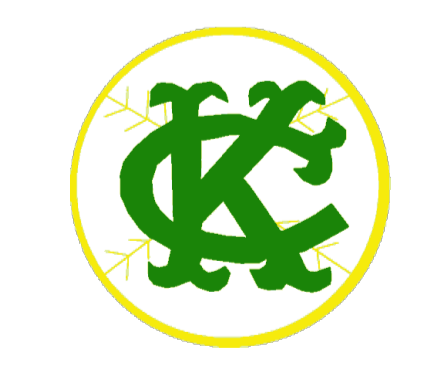

WP: 0 PA: 36  
PB: 0  
SB: 0  
CS: 0

ERA WHIP

Thu Aug 06 1964, 4:33 AM EDT  
Att. 14,881 - Unknown

AB R H RBI BB SO LOB

4 0 0 0 0 0 1

4 1 1 1 0 2 0

3 1 0 0 1 1 0

3 1 1 2 1 1 0

4 0 2 0 0 0 1

4 0 0 0 0 1 3

4 0 1 0 0 1 1

4 0 1 0 0 0 2

1 0 0 0 0 1 0  
1 0 1 0 0 0 0  
0 0 0 0 0 0 0  
1 0 0 0 0 0 2  
0 0 0 0 0 0 0  
0 0 0 0 0 0 0  
1 0 0 0 0 0 0

1B: 3 SF: 0  
2B: 2 SAC: 0  
3B: 0 DP: 0  
HR: 2 HBP: 0

WP HR S P ERA WHIP

9

1

2

3

1

1

3

1

2

3

8

1

2

4

0

0

0

0

0

0

7

2

2

0

0

0

1

2

0

3

6

1

3

2

0

0

0

0

2

0

5

3

3

2

3

2

0

0

2

0

1

4

2

3

3

1

2

0

0

0

0

1

3

2

3

3

1

2

0

0

0

1

1

2

2

3

3

4

0

0

0

0

0

1

1

1

2

3

3

0

0

0

0

0

0

0

0

0

Batter

Bert Campaneris, R (1, 6)  
OBP: 0.377, SLG: 0.545

Nelson Mathews, R (1, 8)  
OBP: 0.298, SLG: 0.362

Ed Charles, R (1, 5)  
OBP: 0.327, SLG: 0.385

Rocky Colavito, R (1, 9)  
OBP: 0.361, SLG: 0.548

Jim Gentile, L (1, 3)  
OBP: 0.380, SLG: 0.485

Doc Edwards, R (1, 2)  
OBP: 0.252, SLG: 0.292

Manny Jimenez, L (1, 7)  
OBP: 0.288, SLG: 0.514

Dick Green, R (1, 4)  
OBP: 0.289, SLG: 0.399

Diego Segui, R (1, 1)  
Ken Harrelson, R (5, PH)  
Jose Santiago, R (6, 1)  
George Alusik, R (7, PH)  
John Wyatt, R (8, 1)  
Ken Sanders, R (8, 1)  
Billy Bryan, L (9, PH)  
OBP: 0.294, SLG: 0.503

Inning Stats

PITCHER  
Ralph Terry, R (1, 1)  
ERA: 4.92  
Hal Reniff, R (8, 1)  
ERA: 2.88

R: 0 H: 0  
E: 0 LOB: 0  
K: 1 BB: 0  
S: 5 P: 5

R: 0 H: 1  
E: 0 LOB: 2  
K: 1 BB: 1  
S: 6 P: 10

R: 1 H: 1  
E: 0 LOB: 0  
K: 2 BB: 0  
S: 8 P: 8

R: 0 H: 0  
E: 0 LOB: 0  
K: 1 BB: 0  
S: 5 P: 5

R: 0 H: 1  
E: 0 LOB: 1  
K: 1 BB: 0  
S: 6 P: 6

R: 0 H: 0  
E: 0 LOB: 0  
K: 1 BB: 0  
S: 5 P: 5

R: 0 H: 2  
E: 0 LOB: 2  
K: 0 BB: 0  
S: 5 P: 5

R: 2 H: 2  
E: 0 LOB: 1  
K: 0 BB: 1  
S: 5 P: 9

R: 0 H: 0  
E: 0 LOB: 0  
K: 0 BB: 0  
S: 3 P: 3

IP WLS BF H R ER SO BB IBB HBP BLK WP HR S P ERA WHIP

7.2 W 32 7 3 3 7 2 0 0 0 0 0 0 44 52 3.52 1.174

1.1 S 4 0 0 0 0 0 0 0 0 0 0 0 4 4 0.00 0.000

IP WLS BF H R ER SO BB IBB HBP BLK WP HR S P ERA WHIP

1.1 S 4 0 0 0 0 0 0 0 0 0 0 0 4 4 0.00 0.000

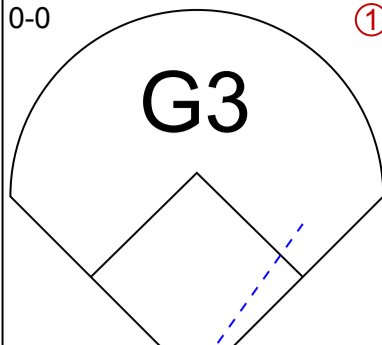
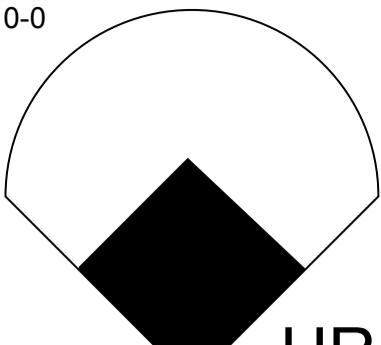
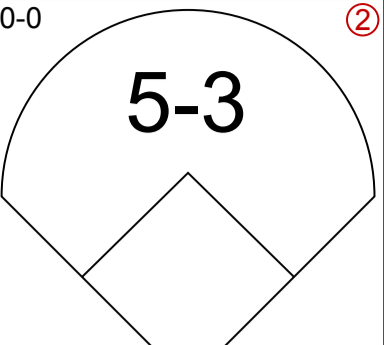
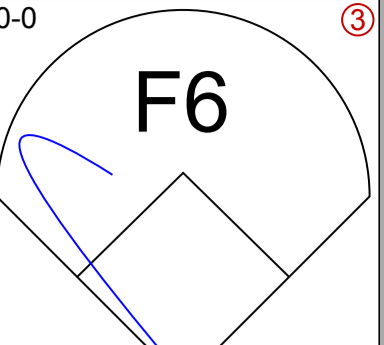
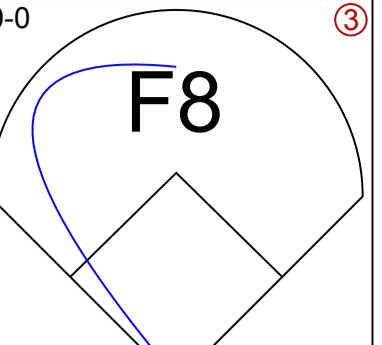
|   |  |  |  |  |  |  |  |  |  |               |   |
|---|--|--|--|--|--|--|--|--|--|---------------|---|
| <b>Bert Campaneris, R</b> (1, 6)<br><small>OBP: 0.364, SLG: 0.567</small> | 0-0<br> |  | 0-0<br> |  | 0-0<br> |  | 0-0<br> |  | 0-0<br> | 5 1 1 1 0 0 2 | Kansas City Athletics @ Detroit Tigers<br>Tiger Stadium, Detroit, MI<br>Fri Aug 07 1964, 7:05 PM EDT<br>Att. 13,939 - Unknown |
|---|--|--|--|--|--|--|--|--|--|---------------|---|

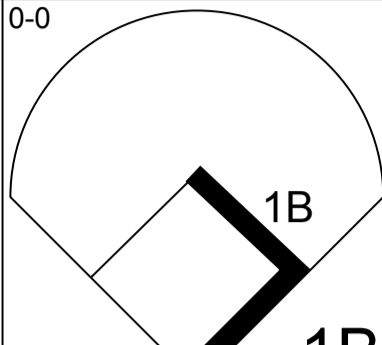
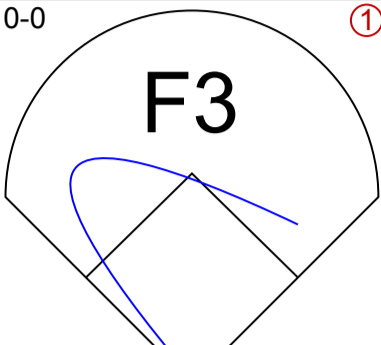
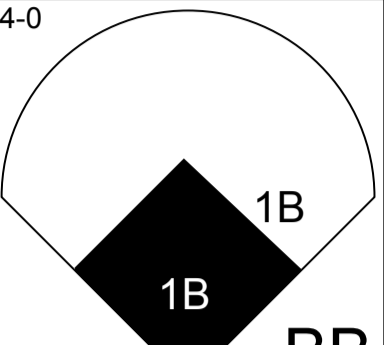
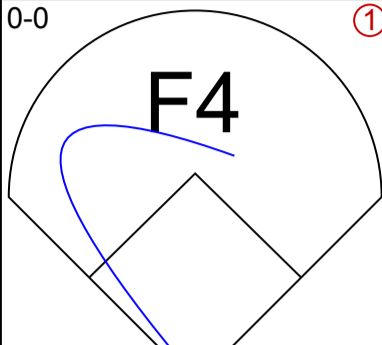
|  |  |  |  |  |  |  |  |  |  |               |  |
|--|--|--|--|--|--|--|--|--|--|---------------|--|
| <b>Ed Charles, R</b> (1, 5)<br><small>OBP: 0.329, SLG: 0.385</small> | 0-0<br> |  | 0-0<br> |  | 4-0<br> |  |  | 0-0<br> |  | 3 1 1 0 1 0 0 |  |
|--|--|--|--|--|--|--|--|--|--|---------------|--|

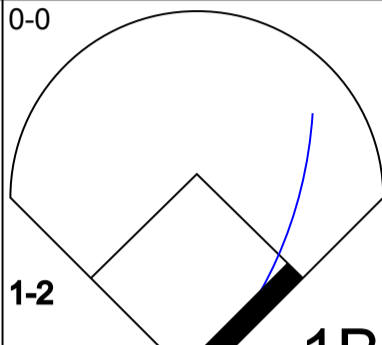
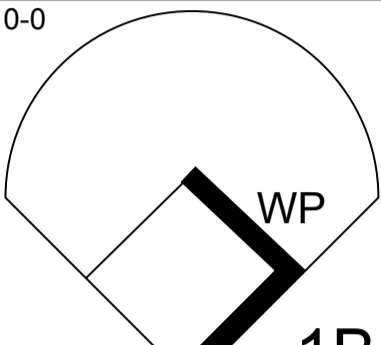
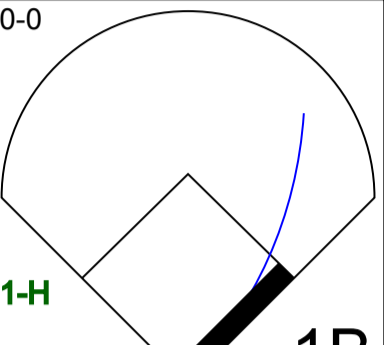
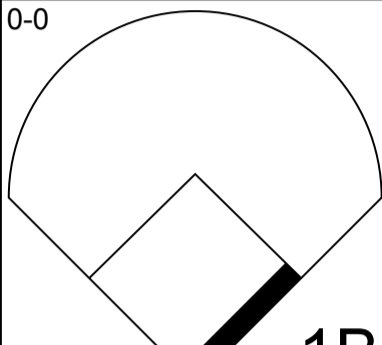
|   |  |  |  |  |  |  |  |  |  |                                |  |
|---|--|--|--|--|--|--|--|--|--|--------------------------------|--|
| <b>Manny Jimenez, L</b> (1, 7)<br><small>OBP: 0.305, SLG: 0.527</small> | 0-0<br> |  | 0-0<br> |  | 0-0<br> |  |  | 0-0<br> |  | 4 0 4 1 0 0 0<br>0 0 0 0 0 0 0 |  |
|---|--|--|--|--|--|--|--|--|--|--------------------------------|--|

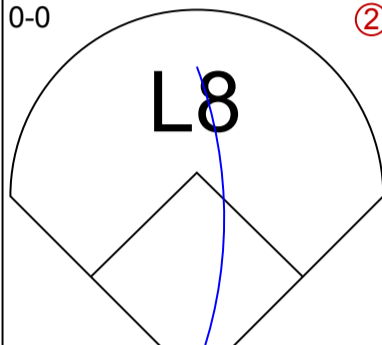
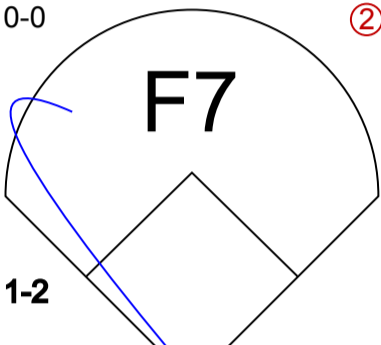
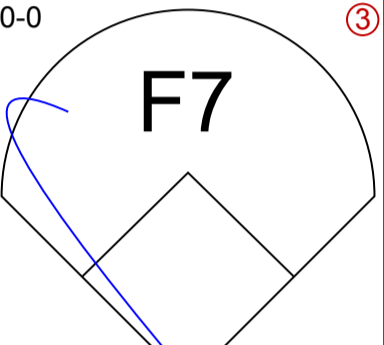
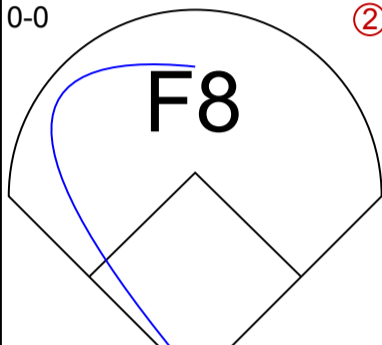
|  |  |  |  |  |  |  |  |  |  |               |  |
|--|--|--|--|--|--|--|--|--|--|---------------|--|
| <b>Rocky Colavito, R</b> (1, 9)<br><small>OBP: 0.358, SLG: 0.542</small> | 0-0<br> |  | 0-0<br> |  | 0-0<br> |  |  | 0-0<br> |  | 4 0 0 0 0 0 5 |  |
|--|--|--|--|--|--|--|--|--|--|---------------|--|

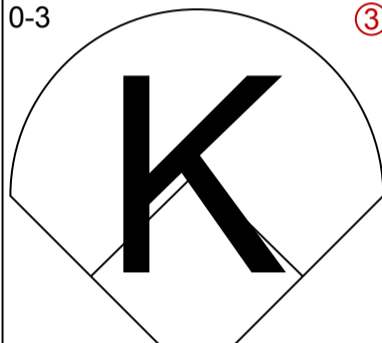
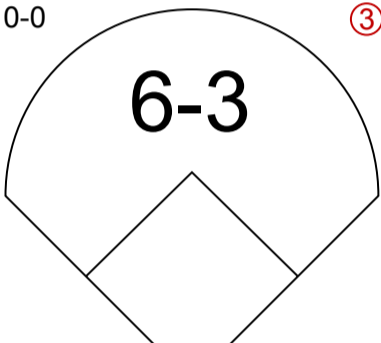
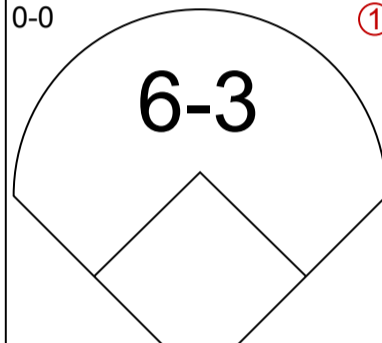
|   |  |  |  |  |  |  |  |  |  |                                |  |
|---|--|--|--|--|--|--|--|--|--|--------------------------------|--|
| <b>Jim Gentile, L</b> (1, 3)<br><small>OBP: 0.379, SLG: 0.483</small> | 0-3<br> |  | 0-0<br> |  |  |  |  | 0-0<br> |  | 1 0 0 0 0 1 2<br>3 0 0 0 0 0 2 |  |
|---|--|--|--|--|--|--|--|--|--|--------------------------------|--|

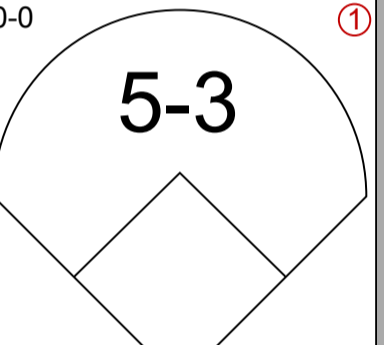
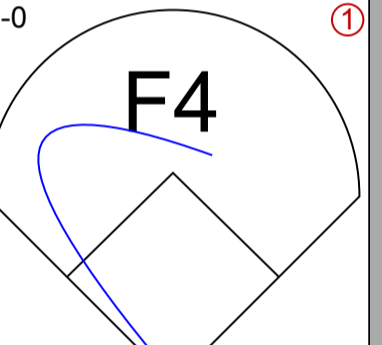
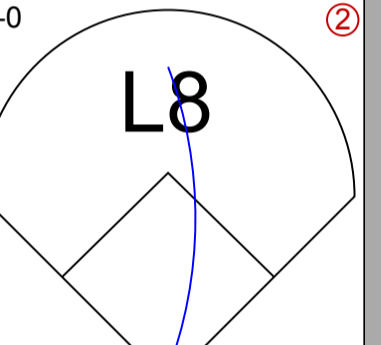
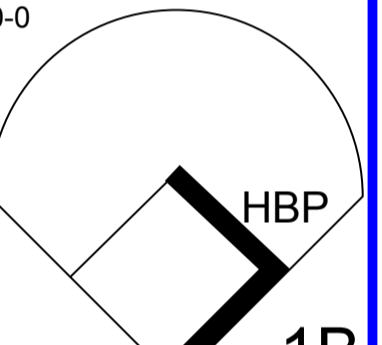
|   |  |   |  |   |  |  |   |  |   |                                |  |
|---|--|---|--|---|--|--|---|--|---|--------------------------------|--|
| <b>Doc Edwards, R</b> (1, 2)<br><small>OBP: 0.252, SLG: 0.291</small> |  | 0-0<br> |  | 0-0<br> |  |  | 0-0<br> |  | 0-0<br> | 4 0 1 0 0 0 0<br>0 0 0 0 0 0 0 |  |
|---|--|---|--|---|--|--|---|--|---|--------------------------------|--|

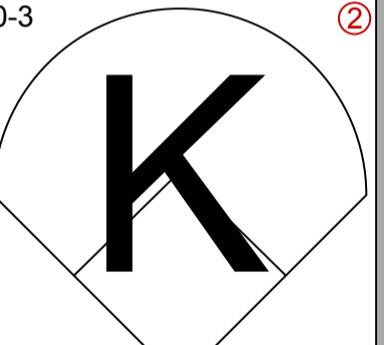
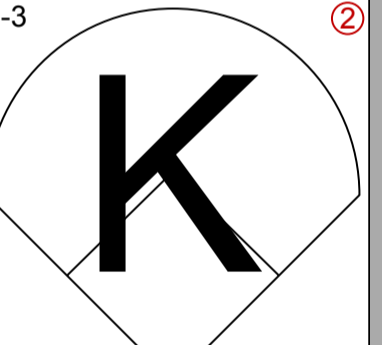
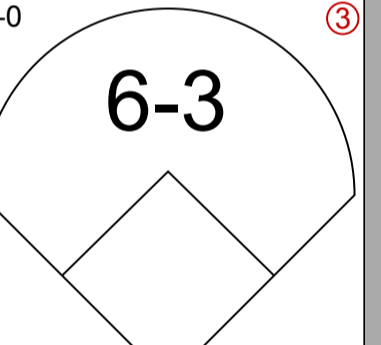
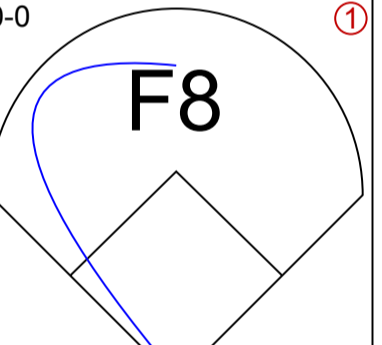
|  |  |  |  |  |  |  |  |  |  |               |  |
|--|--|--|--|--|--|--|--|--|--|---------------|--|
| <b>Nelson Mathews, R</b> (1, 8)<br><small>OBP: 0.295, SLG: 0.359</small> |  | 0-3<br> |  | 0-3<br> |  |  | 0-0<br> |  | 0-0<br> | 4 0 0 0 0 2 1 |  |
|--|--|--|--|--|--|--|--|--|--|---------------|--|

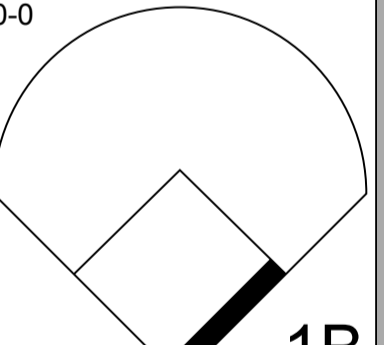
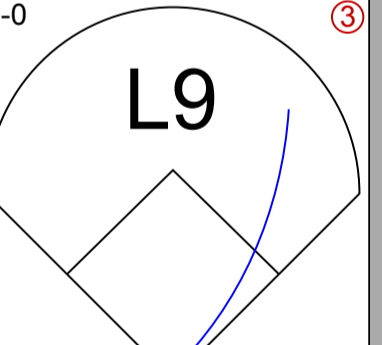
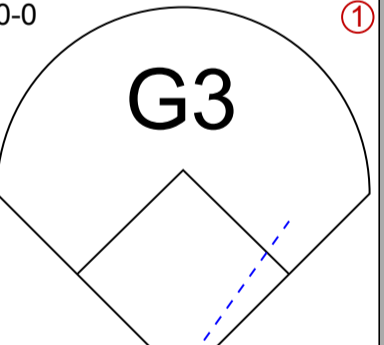
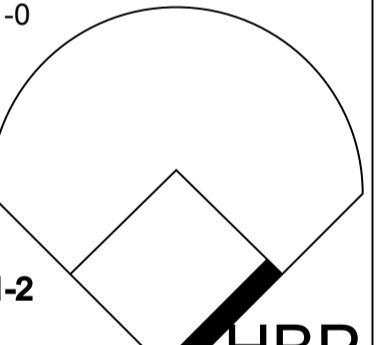
|  |  |  |  |  |  |  |  |  |  |               |  |
|--|--|--|--|--|--|--|--|--|--|---------------|--|
| <b>Dick Green, R</b> (1, 4)<br><small>OBP: 0.292, SLG: 0.399</small> |  | 0-0<br> |  | 0-0<br> |  |  | 0-0<br> |  | 1-0<br> | 3 0 1 0 0 0 0 |  |
|--|--|--|--|--|--|--|--|--|--|---------------|--|

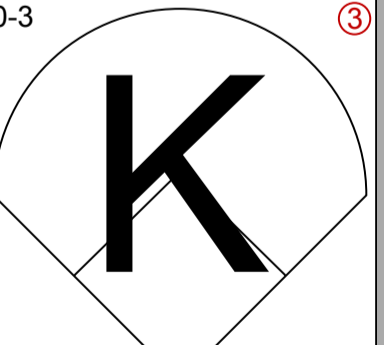
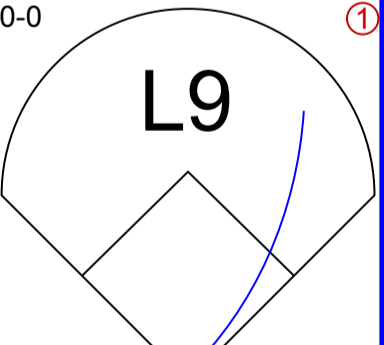
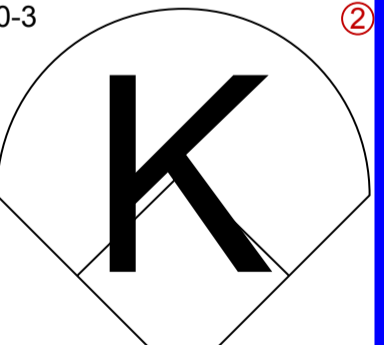
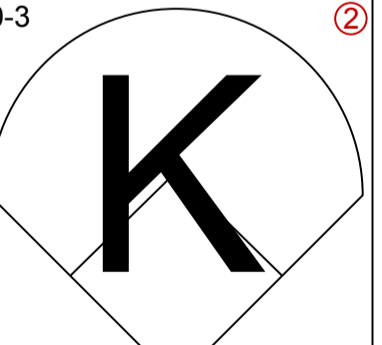
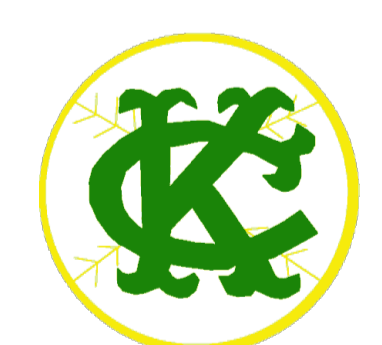
|   |  |  |  |  |  |  |  |  |  |  |   |
|---|--|--|--|--|--|--|--|--|--|--|---|
| <b>Ted Bowsfield, R</b> (1, 1)<br><small>OBP: 0.136, SLG: 0.095</small> |  | 0-3<br> |  | 0-0<br> |  |  | 0-3<br> |  | 0-3<br> | 2 0 0 0 0 1 1<br>0 0 0 0 0 0 0<br>1 0 0 0 0 1 0<br>0 0 0 0 0 0 0<br>0 0 0 0 0 0 0<br>1 0 0 0 0 1 2 |  |
|---|--|--|--|--|--|--|--|--|--|--|---|

| Inning Stats | R: 0<br>E: 0<br>K: 1<br>S: 7 | H: 2<br>LOB: 2<br>BB: 0<br>P: 7 | R: 0<br>E: 0<br>K: 2<br>S: 8 | H: 1<br>LOB: 1<br>BB: 0<br>P: 8 | R: 1<br>E: 0<br>K: 0<br>S: 5 | H: 2<br>LOB: 1<br>BB: 0<br>P: 5 | R: 0<br>E: 0<br>K: 1<br>S: 5 | H: 0<br>LOB: 0<br>BB: 0<br>P: 5 | R: 1<br>E: 0<br>K: 0<br>S: 4 | H: 1<br>LOB: 1<br>BB: 1<br>P: 8 | R: 0<br>E: 0<br>K: 0<br>S: 3 | H: 0<br>LOB: 0<br>BB: 0<br>P: 3 | R: 0<br>E: 0<br>K: 1<br>S: 5 | H: 0<br>LOB: 0<br>BB: 0<br>P: 5 | R: 0<br>E: 0<br>K: 0<br>S: 4 | H: 1<br>LOB: 1<br>BB: 0<br>P: 4 | R: 0<br>E: 0<br>K: 1<br>S: 6 | H: 1<br>LOB: 2<br>BB: 0<br>P: 7 | 1B: 7<br>2B: 0<br>3B: 0<br>HR: 1 | SF: 0<br>SAC: 0<br>DP: 0<br>HBP: 1 | WP: 1<br>PB: 0<br>SB: 0<br>CS: 0 | PA: 37 |
|--------------|------------------------------|---------------------------------|------------------------------|---------------------------------|------------------------------|---------------------------------|------------------------------|---------------------------------|------------------------------|---------------------------------|------------------------------|---------------------------------|------------------------------|---------------------------------|------------------------------|---------------------------------|------------------------------|---------------------------------|----------------------------------|------------------------------------|----------------------------------|--------|
|--------------|------------------------------|---------------------------------|------------------------------|---------------------------------|------------------------------|---------------------------------|------------------------------|---------------------------------|------------------------------|---------------------------------|------------------------------|---------------------------------|------------------------------|---------------------------------|------------------------------|---------------------------------|------------------------------|---------------------------------|----------------------------------|------------------------------------|----------------------------------|--------|

| PITCHER   | IP  | WLS | BF | H | R | ER | SO | BB | IBB | HBP | BLK | WP | HR | S  | P  | ERA  | WHIP  |
|---|-----|-----|----|---|---|----|----|----|-----|-----|-----|----|----|----|----|------|-------|
| <b>Phil Regan, R</b> (1, 1)<br><small>ERA: 4.65</small> | 9.0 | W   | 37 | 8 | 2 | 2  | 6  | 1  | 0   | 1   | 0   | 1  | 1  | 47 | 52 | 2.00 | 1.000 |

| Batter   | 1       | 2       | 3                   | 4       | 5             | 6            | 7      | 8                     | 9 |
|--|---------|---------|---------------------|---------|---------------|--------------|--------|-----------------------|---|
| Don Wert, R (1, 5)<br>OBP: 0.322, SLG: 0.349<br>Bubba Phillips, R (7, 5)<br>OBP: 0.359, SLG: 0.426 | 0-0 L3  |         | 0-0 F9              |         | 0-0 G3        | 0-3 K        |        | 0-0 F9                |   |
| Jerry Lumpe, L (1, 4)<br>OBP: 0.303, SLG: 0.319  | 0-0 1-3 |         | 0-0 1B<br>1B        |         | 4-0 2B<br>BB  |              | 0-0 1B | 4-0 BB<br>BB          |   |
| Al Kaline, R (1, 9)<br>OBP: 0.385, SLG: 0.474  | 0-0 L4  |         | 0-0 1B<br>1B        |         | 0-0 1-3<br>2B |              | 0-0 F3 | 4-0 1-2<br>2-3 BB     |   |
| Don Demeter, R (1, 3)<br>OBP: 0.288, SLG: 0.417  |         | 0-0 F6  | 0-0 1B<br>HBP<br>1B |         | 0-3 K         |              | 0-3 K  | 0-3 K                 |   |
| Gates Brown, L (1, 7)<br>OBP: 0.320, SLG: 0.523  |         | 0-0 HR  | 1-0 1B<br>HBP       |         | 0-3 K         |              | 0-0 F8 |                       |   |
| George Thomas, R (1, 8)<br>OBP: 0.328, SLG: 0.473  |         | 0-0 4-3 | 0-0 1B              |         |               | 0-3 K        |        | 0-0 HR                |   |
| Bill Freehan, R (1, 2)<br>OBP: 0.345, SLG: 0.434   |         | 0-0 1B  |                     | 0-0 5-3 |               | 0-0 6-3      |        | 0-0 HR                |   |
| Dick McAuliffe, L (1, 6)<br>OBP: 0.335, SLG: 0.473   |         | 0-3 K   |                     | 0-0 4-3 |               | 0-0 BB<br>1B |        | 4-0 BB<br>SH1-4<br>BB |   |
| Phil Regan, R (1, 1)<br>OBP: 0.415, SLG: 0.389   |         |         | 0-0 3-1             | 0-0 L7  |               | 4-0 BB       |        | 0-0 SH1-4             |   |

| AB | R | H | RBI | BB | SO | LOB |
|----|---|---|-----|----|----|-----|
| 4  | 0 | 0 | 0   | 0  | 1  | 2   |
| 1  | 0 | 0 | 0   | 0  | 0  | 1   |
| 3  | 1 | 2 | 0   | 2  | 0  | 0   |
| 4  | 1 | 2 | 0   | 1  | 0  | 1   |
| 5  | 0 | 1 | 1   | 0  | 3  | 6   |
| 3  | 1 | 1 | 1   | 0  | 1  | 3   |
| 4  | 1 | 2 | 2   | 0  | 1  | 0   |
| 4  | 1 | 2 | 1   | 0  | 0  | 0   |
| 3  | 0 | 1 | 0   | 1  | 1  | 1   |
| 2  | 0 | 0 | 0   | 1  | 0  | 0   |

**BOTTOM**

**Kansas City Athletics @ Detroit Tigers**  
Tiger Stadium, Detroit, MI  
Fri Aug 07 1964, 7:05 PM EDT  
Att. 13,939 - Unknown

[livebaseballscorecards.com](http://livebaseballscorecards.com)

|            |           |
|------------|-----------|
| <b>AB</b>  | <b>33</b> |
| <b>R</b>   | <b>5</b>  |
| <b>H</b>   | <b>11</b> |
| <b>RBI</b> | <b>5</b>  |
| <b>BB</b>  | <b>5</b>  |
| <b>SO</b>  | <b>7</b>  |
| <b>LOB</b> | <b>14</b> |



|       |        |
|-------|--------|
| 1B: 7 | SF: 0  |
| 2B: 1 | SAC: 1 |
| 3B: 0 | DP: 0  |
| HR: 3 | HBP: 1 |

|       |        |
|-------|--------|
| WP: 0 | PA: 40 |
| PB: 0 |        |
| SB: 0 |        |
| CS: 0 |        |

| Inning Stats                         | R: 0      | H: 0       | E: 0      | K: 0     | S: 3     | R: 1      | H: 2      | E: 0      | K: 1       | S: 7       | R: 2       | H: 4      | E: 0      | K: 0     | S: 6     | R: 0       | H: 1        | E: 0  | K: 2   | S: 8  | R: 0 | H: 1   | E: 0  | K: 1  | S: 6 | R: 2 | H: 2 | E: 0 | K: 1 | S: 7 |
|--------------------------------------|-----------|------------|-----------|----------|----------|-----------|-----------|-----------|------------|------------|------------|-----------|-----------|----------|----------|------------|-------------|-------|--------|-------|------|--------|-------|-------|------|------|------|------|------|------|
|                                      | LOB: 0    | BB: 0      | P: 3      | LOB: 1   | BB: 0    | P: 7      | LOB: 2    | BB: 0     | P: 7       | LOB: 0     | BB: 0      | P: 3      | LOB: 2    | BB: 1    | P: 12    | LOB: 2     | BB: 1       | P: 12 | LOB: 1 | BB: 0 | P: 6 | LOB: 3 | BB: 3 | P: 19 |      |      |      |      |      |      |
| <b>PITCHER</b>                       | <b>IP</b> | <b>WLS</b> | <b>BF</b> | <b>H</b> | <b>R</b> | <b>ER</b> | <b>SO</b> | <b>BB</b> | <b>IBB</b> | <b>HBP</b> | <b>BLK</b> | <b>WP</b> | <b>HR</b> | <b>S</b> | <b>P</b> | <b>ERA</b> | <b>WHIP</b> |       |        |       |      |        |       |       |      |      |      |      |      |      |
| Ted Bowsfield, L (1, 1)<br>ERA: 4.28 | 4.1       | L          | 21        | 7        | 3        | 3         | 1         | 1         | 0          | 0          | 0          | 0         | 1         | 21       | 26       | 6.23       | 1.846       |       |        |       |      |        |       |       |      |      |      |      |      |      |
| Ken Sanders, R (5, 1)<br>ERA:        | 1.2       |            | 7         | 1        | 0        | 0         | 4         | 1         | 0          | 0          | 0          | 0         | 0         | 14       | 18       | 0.00       | 1.200       |       |        |       |      |        |       |       |      |      |      |      |      |      |
| Wes Stock, R (7, 1)<br>ERA: 2.6      | 1.1       |            | 8         | 3        | 2        | 2         | 1         | 1         | 0          | 0          | 0          | 0         | 2         | 9        | 13       | 13.50      | 3.000       |       |        |       |      |        |       |       |      |      |      |      |      |      |
| John Wyatt, R (8, 1)<br>ERA: 3.95    | 0.2       |            | 4         | 0        | 0        | 0         | 1         | 2         | 0          | 0          | 0          | 0         | 0         | 4        | 12       | 0.00       | 3.000       |       |        |       |      |        |       |       |      |      |      |      |      |      |

| Batter  | 1   | 2                               | 3                            | 4                                | 5                            | 6                               | 7                            | 8                               | 9                            | 10                              | 11                           | 12                              | 13                           | AB R H RBI BB SO LOB   | TOP   |   |                                 |                              |                                 |                              |                                 |                              |                                 |                              |                                 |                                   |                                    |  |  |  |
|---|---|---------------------------------|------------------------------|----------------------------------|------------------------------|---------------------------------|------------------------------|---------------------------------|------------------------------|---------------------------------|------------------------------|---------------------------------|------------------------------|--|---|---|---------------------------------|------------------------------|---------------------------------|------------------------------|---------------------------------|------------------------------|---------------------------------|------------------------------|---------------------------------|-----------------------------------|------------------------------------|--|--|--|
| Bert Campaneris, R (1, 6)<br>Wayne Causey, L (7, 6)<br>OBP: 0.371, SLG: 0.556<br>OBP: 0.380, SLG: 0.377   | K   |                                 | 1B                           | HBP                              |                              |                                 | F7                           |                                 | 1B                           |                                 |                              | 4-3                             |                              | 3 1 1 0 0 1 0<br>2 0 1 1 0 0 0   | <b>Kansas City Athletics @ Detroit Tigers</b><br>Tiger Stadium, Detroit, MI<br>Sat Aug 08 1964, 4:33 AM EDT<br>Att: 6,337 - Unknown |   |                                 |                              |                                 |                              |                                 |                              |                                 |                              |                                 |                                   |                                    |  |  |  |
| Ed Charles, R (1, 5)<br>OBP: 0.329, SLG: 0.384  | L8  |                                 | 1B                           | 4-3                              |                              |                                 | 5-3                          |                                 | K                            |                                 |                              | G6-4-3                          |                              | 6 1 2 0 0 1 3  |   |   |                                 |                              |                                 |                              |                                 |                              |                                 |                              |                                 |                                   |                                    |  |  |  |
| Manny Jimenez, L (1, 7)<br>OBP: 0.306, SLG: 0.526   | 1B  |                                 | F5                           |                                  |                              |                                 | L9                           | G3                              |                              |                                 |                              | G6-4-3                          |                              | 6 0 2 0 0 0 3  |   |   |                                 |                              |                                 |                              |                                 |                              |                                 |                              |                                 |                                   |                                    |  |  |  |
| Rocky Colavito, R (1, 9)<br>OBP: 0.355, SLG: 0.536  | F7  |                                 | 1B                           |                                  |                              |                                 | F8                           | L9                              |                              |                                 |                              | 1-3                             |                              | 6 0 1 1 0 0 2  |   |   |                                 |                              |                                 |                              |                                 |                              |                                 |                              |                                 |                                   |                                    |  |  |  |
| Jim Gentile, L (1, 3)<br>OBP: 0.378, SLG: 0.478   |   | BB                              | 1B                           |                                  |                              |                                 | F8                           | G3                              |                              |                                 |                              | K                               |                              | 5 0 1 1 1 2 1  |   |   |                                 |                              |                                 |                              |                                 |                              |                                 |                              |                                 |                                   |                                    |  |  |  |
| Billy Bryan, L (1, 2)<br>OBP: 0.287, SLG: 0.487   |   | K                               | K                            |                                  |                              |                                 | K                            | K                               |                              |                                 |                              | F8                              |                              | 6 0 1 0 0 4 4  |   |   |                                 |                              |                                 |                              |                                 |                              |                                 |                              |                                 |                                   |                                    |  |  |  |
| Nelson Mathews, R (1, 8)<br>Jose Santiago, R (7, 1)<br>George Alusik, R (9, PH)<br>John Wyatt, R (9, 1)<br>Ken Harrelson, R (11, PH)<br>Diego Segui, R (11, 1)<br>Doc Edwards, R (13, PH)<br>Ken Sanders, R (13, 1) |   | K                               |                              | 1-3                              |                              |                                 | F4                           |                                 | F8                           |                                 |                              | F3                              |                              | 3 0 0 0 0 1 1<br>0 0 0 0 0 0 0<br>1 0 0 0 0 0 0<br>0 0 0 0 0 0 0<br>1 0 0 0 0 0 0<br>0 0 0 0 0 0 0<br>1 0 0 0 0 0 1<br>0 0 0 0 0 0 0 |   |   |                                 |                              |                                 |                              |                                 |                              |                                 |                              |                                 |                                   |                                    |  |  |  |
| Dick Green, R (1, 4)<br>OBP: 0.297, SLG: 0.402  | 1-3   |                                 |                              | HBP                              |                              |                                 | F7                           |                                 | SH1-3                        |                                 |                              | 1B                              |                              | 5 1 3 0 0 0 1  |   |   |                                 |                              |                                 |                              |                                 |                              |                                 |                              |                                 |                                   |                                    |  |  |  |
| John O'Donoghue, R (1, 1)<br>Jose Tartabull, L (7, PH)<br>OBP: 0.200, SLG: 0.275<br>OBP: 0.250, SLG: 0.257  |   |                                 | L7                           |                                  |                              |                                 | F7                           |                                 | SH1-3                        |                                 |                              | F7                              |                              | 2 0 0 0 0 0 1<br>2 0 0 0 0 0 1   |   |   |                                 |                              |                                 |                              |                                 |                              |                                 |                              |                                 |                                   |                                    |  |  |  |
| <b>Inning Stats</b>   | R: 0<br>E: 0<br>K: 1<br>S: 6  | H: 1<br>LOB: 1<br>BB: 0<br>P: 6 | R: 0<br>E: 0<br>K: 2<br>S: 7 | H: 0<br>LOB: 1<br>BB: 1<br>P: 11 | R: 2<br>E: 0<br>K: 1<br>S: 9 | H: 4<br>LOB: 2<br>BB: 0<br>P: 9 | R: 0<br>E: 0<br>K: 0<br>S: 4 | H: 1<br>LOB: 2<br>BB: 0<br>P: 5 | R: 0<br>E: 0<br>K: 1<br>S: 5 | H: 0<br>LOB: 0<br>BB: 0<br>P: 5 | R: 0<br>E: 0<br>K: 1<br>S: 6 | H: 1<br>LOB: 1<br>BB: 0<br>P: 6 | R: 1<br>E: 0<br>K: 1<br>S: 7 | H: 2<br>LOB: 1<br>BB: 0<br>P: 7  |   | R: 0<br>E: 0<br>K: 1<br>S: 5  | H: 0<br>LOB: 0<br>BB: 0<br>P: 5 | R: 0<br>E: 0<br>K: 0<br>S: 4 | H: 1<br>LOB: 1<br>BB: 0<br>P: 4 | R: 0<br>E: 0<br>K: 0<br>S: 3 | H: 1<br>LOB: 0<br>BB: 0<br>P: 3 | R: 0<br>E: 0<br>K: 1<br>S: 6 | H: 1<br>LOB: 1<br>BB: 0<br>P: 6 | R: 0<br>E: 0<br>K: 1<br>S: 6 | H: 1<br>LOB: 1<br>BB: 0<br>P: 6 | 1B: 11<br>2B: 1<br>3B: 0<br>HR: 0 | SF: 0<br>SAC: 1<br>DP: 1<br>HBP: 1 | WP: 0<br>PA: 52<br>PB: 0<br>SB: 0<br>CS: 0 |  |  |
| <b>PITCHER</b>  | IP<br>WLS<br>BF<br>H<br>R<br>ER<br>SO<br>BB<br>IBB<br>HBP<br>BLK<br>WP<br>HR<br>S<br>P<br>ERA<br>WHIP |                                 |                              |                                  |                              |                                 |                              |                                 |                              |                                 |                              |                                 |                              |  |   | IP<br>WLS<br>BF<br>H<br>R<br>ER<br>SO<br>BB<br>IBB<br>HBP<br>BLK<br>WP<br>HR<br>S<br>P<br>ERA<br>WHIP |                                 |                              |                                 |                              |                                 |                              |                                 |                              |                                 |                                   |                                    |  |  |  |
| Dave Wickersham, R (1, 1)<br>ERA: 3.48  | 9.0   | 38                              | 9                            | 3                                | 3                            | 7                               | 1                            | 0                               | 0                            | 0                               | 0                            | 0                               | 0                            | 0  |   | 3.00  | 1.111                           |                              |                                 |                              |                                 |                              |                                 |                              |                                 |                                   |                                    |  |  |  |
| Fred Gladding, R (10, 1)<br>ERA: 3.26   | 4.0   | 14                              | 3                            | 0                                | 0                            | 2                               | 0                            | 0                               | 0                            | 0                               | 0                            | 0                               | 0                            | 0  |   | 0.00  | 0.750                           |                              |                                 |                              |                                 |                              |                                 |                              |                                 |                                   |                                    |  |  |  |

livebaseballscorecards.com

|     |    |
|-----|----|
| AB  | 49 |
| R   | 3  |
| H   | 12 |
| RBI | 3  |
| BB  | 1  |
| SO  | 9  |
| LOB | 18 |



| Batter   | 1                | 2              | 3           | 4               | 5          | 6          | 7          | 8         | 9          | 10         | 11         | 12        | 13                 | AB R H RBI BB SO LOB   |
|--|------------------|----------------|-------------|-----------------|------------|------------|------------|-----------|------------|------------|------------|-----------|--------------------|--|
| <b>George Thomas, R</b><br>OBP: 0.325, SLG: 0.470<br>(1, 8)<br>(11, 5)   | 0-0<br>F9        | 0-0<br>L8      |             | 0-0<br>2B       |            | 0-0<br>F9  |            |           | 0-0<br>G3  |            | 0-3<br>K   |           |                    | 6 0 1 1 0 1 2  |
| <b>Jerry Lumpe, L</b><br>OBP: 0.303, SLG: 0.319<br>(1, 4)<br>(11, 5)     | 0-0<br>1B<br>FC4 | 0-0<br>F8      |             | 0-0<br>1-3      |            |            | 0-3<br>K   |           | 0-0<br>1B  |            | 0-0<br>L7  |           |                    | 6 1 2 0 0 1 3  |
| <b>Al Kaline, R</b><br>OBP: 0.382, SLG: 0.469<br>(1, 9)<br>(11, 8)       | 0-0<br>1B<br>FC4 |                | 0-0<br>L5-3 |                 | 0-0<br>L8  |            | 0-0<br>L7  |           | 0-0<br>L9  |            |            | 0-0<br>L6 |                    | 6 0 1 0 0 0 1  |
| <b>Don Demeter, R</b><br>OBP: 0.286, SLG: 0.422<br>(1, 3)<br>(11, 8)     | 0-0<br>1B<br>FC4 |                | 0-0<br>F7   |                 | 0-0<br>HR  |            | 0-0<br>F7  |           |            | 0-0<br>1-3 |            | 0-3<br>K  |                    | 6 1 1 2 0 1 1  |
| <b>Gates Brown, L</b><br>OBP: 0.324, SLG: 0.521<br>(1, 7)<br>(11, 3)     | 0-0<br>1B        |                | 0-0<br>1B   |                 | 0-3<br>K   |            | 0-0<br>3-1 |           | 4-0<br>BB  | 4-0<br>BB  | 0-3<br>K   | 0-3<br>K  |                    | 5 0 2 0 1 2 0  |
| <b>Bill Freehan, R</b><br>OBP: 0.345, SLG: 0.432<br>(1, 2)<br>(11, 3)    | 0-0<br>6-3       |                | 0-0<br>L8   |                 | 0-0<br>1B  |            | 0-0<br>K   |           | 0-3<br>K   | 0-0<br>4-3 | 0-0<br>4-3 |           | 0-0<br>SH1-4<br>1B | 6 1 2 0 0 1 4  |
| <b>Dick McAuliffe, L</b><br>OBP: 0.340, SLG: 0.476<br>(1, 6)<br>(11, 3)  |                  | 0-0<br>1B<br>E |             | 0-0<br>1B<br>2B | 0-0<br>4-3 |            | 0-0<br>1B  |           | 0-0<br>1B  | 4-0<br>BB  | 4-0<br>BB  |           | 0-0<br>SH1-4       | 4 1 3 0 1 0 1  |
| <b>Bubba Phillips, R</b><br>OBP: 0.341, SLG: 0.403<br>(1, 5)<br>(11, 3)  |                  | 0-0<br>F7      |             | 0-0<br>1-3      |            | 0-3<br>K   |            | 0-0<br>F6 |            | 0-0<br>4-3 |            | 4-0<br>1B | 4-0<br>IBB         | 4 0 0 0 0 1 3<br>1 0 0 0 1 0 2                                   |
| <b>Norm Cash, L</b><br>OBP: 0.317, SLG: 0.401<br>(10, PH)<br>(11, 3)     |                  |                |             | 1-2             |            |            |            |           |            |            |            |           |                    |  |
| <b>Dave Wickersham, R</b><br>OBP: 0.119, SLG: 0.105<br>(1, 1)<br>(11, 3) |                  | 0-0<br>E1      |             | 0-0<br>F9       |            | 0-0<br>4-3 |            |           | 0-0<br>4-3 |            | 0-0<br>L7  |           | 0-0<br>1B          | 3 0 0 0 0 0 2<br>1 0 0 0 0 0 0<br>1 0 0 0 0 0 0<br>1 0 1 1 0 0 0 |
| <b>Bill Bruton, L</b><br>OBP: 0.339, SLG: 0.387<br>(9, PH)<br>(10, 1)    |                  |                |             |                 |            |            |            |           |            |            |            |           |                    |  |
| <b>Fred Gladding, L</b><br>(10, 1)                                       |                  |                |             |                 |            |            |            |           |            |            |            |           |                    |  |
| <b>Jake Wood, R</b><br>OBP: 0.252, SLG: 0.300<br>(13, PH)<br>(11, 3)     |                  | 1-2            |             |                 |            |            |            |           |            |            |            |           | 1-2<br>2-H         |  |

| Inning Stats | R: 1<br>E: 0<br>K: 0<br>S: 6 | H: 3<br>LOB: 2<br>BB: 0<br>P: 6 | R: 0<br>E: 0<br>K: 0<br>S: 5 | H: 1<br>LOB: 2<br>BB: 0<br>P: 5 | R: 0<br>E: 0<br>K: 0<br>S: 4 | H: 1<br>LOB: 1<br>BB: 0<br>P: 4 | R: 1<br>E: 0<br>K: 1<br>S: 7 | H: 2<br>LOB: 1<br>BB: 0<br>P: 7 | R: 0<br>E: 0<br>K: 1<br>S: 5 | H: 0<br>LOB: 0<br>BB: 0<br>P: 5 | R: 0<br>E: 0<br>K: 1<br>S: 6 | H: 1<br>LOB: 1<br>BB: 0<br>P: 6 | R: 0<br>E: 0<br>K: 0<br>S: 4 | H: 1<br>LOB: 1<br>BB: 0<br>P: 4 | R: 0<br>E: 0<br>K: 2<br>S: 7 | H: 0<br>LOB: 0<br>BB: 0<br>P: 7 | R: 1<br>E: 0<br>K: 0<br>S: 3 | H: 2<br>LOB: 2<br>BB: 1<br>P: 7 | R: 0<br>E: 0<br>K: 2<br>S: 7 | H: 0<br>LOB: 0<br>BB: 0<br>P: 7 | R: 1<br>E: 0<br>K: 0<br>S: 3 | H: 2<br>LOB: 2<br>BB: 1<br>P: 7 | AB: 11<br>R: 2<br>H: 3<br>I: 1<br>BB: 1<br>SO: 1<br>LOB: 0 | WP: 0<br>PA: 54 |
|--------------|------------------------------|---------------------------------|------------------------------|---------------------------------|------------------------------|---------------------------------|------------------------------|---------------------------------|------------------------------|---------------------------------|------------------------------|---------------------------------|------------------------------|---------------------------------|------------------------------|---------------------------------|------------------------------|---------------------------------|------------------------------|---------------------------------|------------------------------|---------------------------------|--|-----------------|
|--------------|------------------------------|---------------------------------|------------------------------|---------------------------------|------------------------------|---------------------------------|------------------------------|---------------------------------|------------------------------|---------------------------------|------------------------------|---------------------------------|------------------------------|---------------------------------|------------------------------|---------------------------------|------------------------------|---------------------------------|------------------------------|---------------------------------|------------------------------|---------------------------------|--|-----------------|

| PITCHER  | IP  | WLS | BF | H | R | ER | SO | BB | IBB | HBP | BLK | WP | HR | S  | P  | ERA   | WHIP  |
|--|-----|-----|----|---|---|----|----|----|-----|-----|-----|----|----|----|----|-------|-------|
| <b>John O'Donoghue, L</b><br>ERA: 4.27<br>(1, 1) | 6.0 |     | 28 | 9 | 3 | 3  | 2  | 0  | 0   | 0   | 0   | 0  | 1  | 32 | 32 | 4.50  | 1.500 |
| <b>Jose Santiago, R</b><br>ERA: 4.79<br>(7, 1)   | 2.0 |     | 7  | 1 | 0 | 0  | 2  | 0  | 0   | 0   | 0   | 0  | 0  | 11 | 11 | 0.00  | 0.500 |
| <b>John Wyatt, R</b><br>ERA: 3.86<br>(9, 1)      | 2.0 |     | 9  | 1 | 0 | 0  | 0  | 2  | 0   | 0   | 0   | 0  | 0  | 7  | 15 | 0.00  | 1.500 |
| <b>Diego Segui, R</b><br>ERA: 3.75<br>(11, 1)    | 2.0 |     | 6  | 0 | 0 | 0  | 3  | 0  | 0   | 0   | 0   | 0  | 0  | 12 | 12 | 0.00  | 0.000 |
| <b>Ken Sanders, R</b><br>ERA: 2.45<br>(13, 1)    | 0.1 | L   | 4  | 2 | 1 | 1  | 0  | 0  | 1   | 0   | 0   | 0  | 0  | 3  | 7  | 27.00 | 6.000 |

**BOTTOM**

**Kansas City Athletics @ Detroit Tigers**  
Tiger Stadium, Detroit, MI  
Sat Aug 08 1964, 4:33 AM EDT  
Att. 6,337 - Unknown

|     |    |
|-----|----|
| AB  | 50 |
| R   | 4  |
| H   | 13 |
| RBI | 4  |
| BB  | 3  |
| SO  | 7  |
| LOB | 19 |



| PITCHER | IP | WLS | BF | H | R | ER | SO | BB | IBB | HBP | BLK | WP | HR | S | P | ERA | WHIP |
|---------|----|-----|----|---|---|----|----|----|-----|-----|-----|----|----|---|---|-----|------|
|---------|----|-----|----|---|---|----|----|----|-----|-----|-----|----|----|---|---|-----|------|

| Batter  | 1   | 2                               | 3                            | 4                               | 5                              | 6                                | 7                            | 8                               | 9  | AB R H RBI BB SO LOB             | TOP  |                                  |                              |                                 |                              |                                 |                              |                                 |                                  |                                    |                                  |        |  |  |  |  |  |
|---|---|---------------------------------|------------------------------|---------------------------------|--------------------------------|----------------------------------|------------------------------|---------------------------------|--|----------------------------------|--|----------------------------------|------------------------------|---------------------------------|------------------------------|---------------------------------|------------------------------|---------------------------------|----------------------------------|------------------------------------|----------------------------------|--------|--|--|--|--|--|
| <b>Wayne Causey, L</b> (1, 6)<br>OBP: 0.378, SLG: 0.373   | 0-0<br>3-1  |                                 | 0-0<br>G4-6-3                |                                 | 4-0<br>BB<br>1B<br>BB          | 0-0<br>F2                        |                              | 0-0<br>L8                       |  | 4 1 0 0 1 0 4                    | <b>Kansas City Athletics @ Detroit Tigers</b><br>Tiger Stadium, Detroit, MI<br>Sun Aug 09 1964, 4:33 AM EDT<br>Unknown<br><br><a href="http://livebaseballscorecards.com">livebaseballscorecards.com</a> |                                  |                              |                                 |                              |                                 |                              |                                 |                                  |                                    |                                  |        |  |  |  |  |  |
| <b>Ed Charles, R</b> (1, 5)<br>OBP: 0.330, SLG: 0.381   | 0-0<br>5-3  |                                 | 4-0<br>HBP<br>BB             |                                 | 4-0<br>1-2<br>1B<br>BB         | 0-0<br>F7                        |                              | 0-0<br>F4                       | 3 1 0 0 2 0 2  |                                  |  |                                  |                              |                                 |                              |                                 |                              |                                 |                                  |                                    |                                  |        |  |  |  |  |  |
| <b>Manny Jimenez, L</b> (1, 7)<br>OBP: 0.309, SLG: 0.516  | 4-0<br>FC5-4<br>BB                                    |                                 | 1-0<br>1-2<br>HBP            |                                 | 0-0<br>F5                      |                                  | 0-0<br>L9                    | 0-0<br>1-3                      | 3 0 0 0 1 0 2  |                                  |  |                                  |                              |                                 |                              |                                 |                              |                                 |                                  |                                    |                                  |        |  |  |  |  |  |
| <b>Rocky Colavito, R</b> (1, 9)<br>OBP: 0.356, SLG: 0.533   | 0-0<br>FC5-4  |                                 | 0-0<br>F2                    |                                 | 4-0<br>1-2<br>2-3<br>1B<br>BB  |                                  | 0-0<br>FC6-4<br>1B           | 0-0<br>F4                       | 4 0 1 0 1 0 3  |                                  |  |                                  |                              |                                 |                              |                                 |                              |                                 |                                  |                                    |                                  |        |  |  |  |  |  |
| <b>Jim Gentile, L</b> (1, 3)<br>OBP: 0.379, SLG: 0.478  |   | 0-0<br>F2                       |                              | 0-0<br>1B                       | 0-0<br>1-3<br>2-H<br>3-H<br>1B |                                  | 0-3<br>K                     |                                 | 4 0 2 2 0 1 1  |                                  |  |                                  |                              |                                 |                              |                                 |                              |                                 |                                  |                                    |                                  |        |  |  |  |  |  |
| <b>Doc Edwards, R</b> (1, 2)<br>OBP: 0.246, SLG: 0.284  |   | 0-0<br>1-3                      |                              | 0-0<br>L8                       | 0-0<br>F2                      |                                  | 0-0<br>FC6-4                 |                                 | 4 0 0 0 0 0 4  |                                  |  |                                  |                              |                                 |                              |                                 |                              |                                 |                                  |                                    |                                  |        |  |  |  |  |  |
| <b>Nelson Mathews, R</b> (1, 8)<br>OBP: 0.295, SLG: 0.356   |   | 0-0<br>1B                       |                              | 0-3<br>K                        |                                | 4-0<br>BB<br>BB                  |                              | 0-3<br>K                        | 3 0 1 0 1 2 1  |                                  |  |                                  |                              |                                 |                              |                                 |                              |                                 |                                  |                                    |                                  |        |  |  |  |  |  |
| <b>Dick Green, R</b> (1, 4)<br>OBP: 0.300, SLG: 0.401   |   | 0-0<br>4-3                      |                              | 0-0<br>4-3                      |                                | 4-0<br>1-2<br>BB                 |                              | 0-0<br>1B                       | 3 0 1 0 1 0 2  |                                  |  |                                  |                              |                                 |                              |                                 |                              |                                 |                                  |                                    |                                  |        |  |  |  |  |  |
| <b>Orlando Pena, R</b> (1, 1)<br>OBP: 0.190, SLG: 0.190<br><b>Jose Santiago, R</b> (5, 1)<br><b>George Alusik, R</b> (6, PH)<br><b>Wes Stock, R</b> (6, 1)<br><b>Billy Bryan, L</b> (8, PH)<br><b>Ken Sanders, R</b> (8, 1) |   |                                 | 4-0<br>G4-6-3<br>BB          |                                 | 0-0<br>F5                      | 0-0<br>F2                        |                              | 0-3<br>K                        | 1 0 0 0 1 0 0<br>0 0 0 0 0 0 0<br>1 0 0 0 0 0 2<br>0 0 0 0 0 0 0<br>1 0 0 0 0 1 1<br>0 0 0 0 0 0 0 |                                  |  |                                  |                              |                                 |                              |                                 |                              |                                 |                                  |                                    |                                  |        |  |  |  |  |  |
| <b>Inning Stats</b>   | R: 0<br>E: 0<br>K: 0<br>S: 3                          | H: 0<br>LOB: 1<br>BB: 1<br>P: 7 | R: 0<br>E: 0<br>K: 0<br>S: 4 | H: 1<br>LOB: 1<br>BB: 0<br>P: 4 | R: 0<br>E: 0<br>K: 0<br>S: 2   | H: 0<br>LOB: 2<br>BB: 2<br>P: 11 | R: 0<br>E: 0<br>K: 1<br>S: 6 | H: 1<br>LOB: 1<br>BB: 0<br>P: 6 | R: 2<br>E: 0<br>K: 0<br>S: 4   | H: 1<br>LOB: 2<br>BB: 3<br>P: 16 | R: 0<br>E: 0<br>K: 0<br>S: 3   | H: 0<br>LOB: 2<br>BB: 2<br>P: 11 | R: 0<br>E: 0<br>K: 1<br>S: 6 | H: 1<br>LOB: 1<br>BB: 0<br>P: 6 | R: 0<br>E: 0<br>K: 2<br>S: 8 | H: 1<br>LOB: 1<br>BB: 0<br>P: 8 | R: 0<br>E: 0<br>K: 0<br>S: 3 | H: 0<br>LOB: 0<br>BB: 0<br>P: 3 | 1B: 5<br>2B: 0<br>3B: 0<br>HR: 0 | SF: 0<br>SAC: 0<br>DP: 1<br>HBP: 1 | WP: 0<br>PB: 0<br>SB: 0<br>CS: 0 | PA: 40 |  |  |  |  |  |
| <b>PITCHER</b>  | IP WLS BF H R ER SO BB IBB HBP BLK WP HR S P ERA WHIP |                                 |                              |                                 |                                |                                  |                              |                                 |  |                                  |  |                                  |                              |                                 |                              |                                 |                              |                                 |                                  |                                    |                                  |        |  |  |  |  |  |
| <b>Joe Sparma, R</b> (1, 1)<br>ERA: 2.5   | 4.2   | W                               | 23                           | 3                               | 2                              | 2                                | 1                            | 6                               | 0  | 1                                | 0  | 0                                | 0                            | 18                              | 43                           | 3.86                            | 1.929                        |                                 |                                  |                                    |                                  |        |  |  |  |  |  |
| <b>Julio Navarro, R</b> (5, 1)<br>ERA: 4.97   | 4.1   | W                               | 17                           | 2                               | 0                              | 0                                | 3                            | 2                               | 0  | 0                                | 0  | 0                                | 0                            | 21                              | 29                           | 0.00                            | 0.923                        |                                 |                                  |                                    |                                  |        |  |  |  |  |  |

**Kansas City Athletics @ Detroit Tigers**  
Tiger Stadium, Detroit, MI  
Sun Aug 09 1964, 4:33 AM EDT  
Unknown

|     |    |
|-----|----|
| AB  | 31 |
| R   | 2  |
| H   | 5  |
| RBI | 2  |
| BB  | 8  |
| SO  | 4  |
| LOB | 22 |

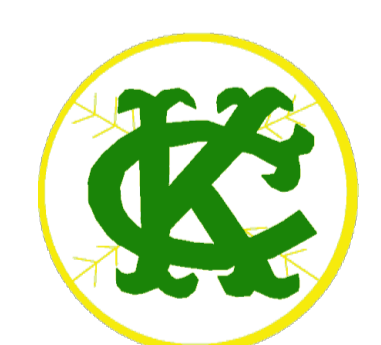



| Batter   | 1          | 2                      | 3              | 4          | 5                                 | 6                | 7               | 8 | 9 | AB R H RBI BB SO LOB |
|--|------------|------------------------|----------------|------------|-----------------------------------|------------------|-----------------|---|---|----------------------|
| Bill Bruton, L<br>OBP: 0.338, SLG: 0.389 (1, 8)    | 0-3<br>K   | 0-0<br>1-H<br>2B       |                | 0-0<br>F7  |                                   | 0-0<br>F4        |                 |   |   | 4 0 1 1 0 1 1        |
| Jerry Lumpe, L<br>OBP: 0.305, SLG: 0.319 (1, 4)    | 0-0<br>L7  | 4-0<br>BB              |                | 0-0<br>4-3 |                                   | 0-0<br>CS<br>1-2 | 0-0<br>E8<br>1B |   |   | 3 0 1 0 1 0 0        |
| Al Kaline, R<br>OBP: 0.383, SLG: 0.471 (1, 9)      | 4-0<br>BB  | 0-0<br>L8              |                |            | 0-0<br>G3<br>1B<br>2B             |                  | 0-0<br>L9       |   |   | 3 1 1 0 1 0 3        |
| Gates Brown, L<br>OBP: 0.323, SLG: 0.521 (1, 7)    | 0-0<br>4-3 |                        | 0-0<br>E<br>2B |            | 0-0<br>G3<br>2-3                  |                  | 0-0<br>4-3      |   |   | 4 0 1 0 0 0 3        |
| Norm Cash, L<br>OBP: 0.322, SLG: 0.411 (1, 3)      |            | 0-0<br>HR              | 0-3<br>K       |            | 4-0<br>1B<br>BB                   |                  | 4-0<br>BB<br>BB |   |   | 2 1 1 1 2 1 1        |
| Bill Freehan, R<br>OBP: 0.344, SLG: 0.430 (1, 2)   |            | 0-3<br>K               | 0-3<br>K       |            | 0-0<br>G4-6-3<br>1-2<br>3-H<br>1B |                  | 0-0<br>F8       |   |   | 4 0 1 1 0 2 3        |
| Dick McAuliffe, L<br>OBP: 0.341, SLG: 0.474 (1, 6) |            | 4-0<br>1B<br>4-3<br>BB | 4-0<br>E<br>BB |            | 0-0<br>G4-6-3<br>1-2f             |                  | 0-0<br>4-3      |   |   | 2 1 0 0 2 0 2        |
| Bubba Phillips, R<br>OBP: 0.337, SLG: 0.395 (1, 5) |            | 0-0<br>4-3             | 0-0<br>F4      |            |                                   | 0-0<br>CS<br>1B  | 0-3<br>K        |   |   | 4 0 1 0 0 1 3        |
| Joe Sparna, R<br>OBP: 0.167, SLG: 0.235 (1, 1)     |            | 0-0<br>2B              |                | 0-3<br>K   |                                   | 0-0<br>F3        | 0-0<br>5-3      |   |   | 2 1 1 1 0 1 0        |
| Julio Navarro, R (5, 1)                            |            |                        |                |            |                                   |                  |                 |   |   | 2 0 0 0 0 0 1        |

| Inning Stats                     | R: 0<br>E: 0<br>K: 1<br>S: 5       | H: 0<br>LOB: 1<br>BB: 1<br>P: 9 | R: 3<br>E: 0<br>K: 1<br>S: 8 | H: 3<br>LOB: 2<br>BB: 2<br>P: 16 | R: 0<br>E: 1<br>K: 2<br>S: 8 | H: 1<br>LOB: 2<br>BB: 1<br>P: 12 | R: 0<br>E: 0<br>K: 1<br>S: 5 | H: 0<br>LOB: 0<br>BB: 0<br>P: 5 | R: 1<br>E: 0<br>K: 0<br>S: 4 | H: 2<br>LOB: 1<br>BB: 1<br>P: 8 | R: 0<br>E: 0<br>K: 0<br>S: 3 | H: 1<br>LOB: 0<br>BB: 0<br>P: 3 | R: 0<br>E: 1<br>K: 0<br>S: 4 | H: 1<br>LOB: 2<br>BB: 1<br>P: 8 | R: 0<br>E: 0<br>K: 1<br>S: 5 | H: 0<br>LOB: 0<br>BB: 0<br>P: 5 |
|----------------------------------|------------------------------------|---------------------------------|------------------------------|----------------------------------|------------------------------|----------------------------------|------------------------------|---------------------------------|------------------------------|---------------------------------|------------------------------|---------------------------------|------------------------------|---------------------------------|------------------------------|---------------------------------|
| 1B: 4<br>2B: 3<br>3B: 0<br>HR: 1 | SF: 0<br>SAC: 0<br>DP: 1<br>HBP: 0 | WP: 0<br>PA: 37                 |                              |                                  |                              |                                  |                              |                                 |                              |                                 |                              |                                 |                              |                                 |                              |                                 |

| PITCHER                              | IP  | WLS | BF | H | R | ER | SO | BB | IBB | HBP | BLK | WP | HR | S  | P  | ERA  | WHIP  |
|--------------------------------------|-----|-----|----|---|---|----|----|----|-----|-----|-----|----|----|----|----|------|-------|
| Orlando Pena, R<br>ERA: 4.39 (1, 1)  | 4.1 | L   | 24 | 6 | 4 | 4  | 5  | 5  | 0   | 0   | 0   | 0  | 1  | 29 | 49 | 8.31 | 2.538 |
| Jose Santiago, R<br>ERA: 4.72 (5, 1) | 0.2 |     | 1  | 0 | 0 | 0  | 0  | 0  | 0   | 0   | 0   | 0  | 0  | 1  | 1  | 0.00 | 0.000 |
| Wes Stock, R<br>ERA: 2.53 (6, 1)     | 2.0 |     | 8  | 2 | 0 | 0  | 0  | 1  | 0   | 0   | 0   | 0  | 0  | 7  | 11 | 0.00 | 1.500 |
| Ken Sanders, R<br>ERA: 1.93 (8, 1)   | 1.0 |     | 3  | 0 | 0 | 0  | 1  | 0  | 0   | 0   | 0   | 0  | 0  | 5  | 5  | 0.00 | 0.000 |

**BOTTOM**

**Kansas City Athletics @ Detroit Tigers**

**Tiger Stadium, Detroit, MI**

Sun Aug 09 1964, 4:33 AM EDT  
Unknown

|            |           |
|------------|-----------|
| <b>AB</b>  | <b>30</b> |
| <b>R</b>   | <b>4</b>  |
| <b>H</b>   | <b>8</b>  |
| <b>RBI</b> | <b>4</b>  |
| <b>BB</b>  | <b>6</b>  |
| <b>SO</b>  | <b>6</b>  |
| <b>LOB</b> | <b>17</b> |



| Batter   | 1   | 2                               | 3                            | 4                               | 5                            | 6                               | 7                            | 8                               | 9                            | AB R H RBI BB SO LOB            | TOP                          |                                 |                              |                                 |                              |                                 |                              |                                 |                                  |                                    |                                  |        |
|--|---|---------------------------------|------------------------------|---------------------------------|------------------------------|---------------------------------|------------------------------|---------------------------------|------------------------------|---------------------------------|------------------------------|---------------------------------|------------------------------|---------------------------------|------------------------------|---------------------------------|------------------------------|---------------------------------|----------------------------------|------------------------------------|----------------------------------|--------|
| Wayne Causey, L (1, 6)<br>OBP: 0.377, SLG: 0.379     | 0-0<br>F2   |                                 |                              | 0-0<br>HR                       |                              | 0-0<br>4-3                      |                              |                                 | 0-0<br>L8                    | 4 1 1 1 0 0 0                   |                              |                                 |                              |                                 |                              |                                 |                              |                                 |                                  |                                    |                                  |        |
| Ed Charles, R (1, 5)<br>OBP: 0.329, SLG: 0.382       | 0-0<br>L9   |                                 |                              | 0-0<br>4-3                      |                              |                                 | 0-0<br>2B                    |                                 | 0-0<br>L4                    | 4 1 1 0 0 0 0                   |                              |                                 |                              |                                 |                              |                                 |                              |                                 |                                  |                                    |                                  |        |
| Manny Jimenez, L (1, 7)<br>OBP: 0.302, SLG: 0.503    | 0-0<br>4-3  |                                 |                              | 0-0<br>F7                       |                              |                                 | 0-0<br>4-3                   |                                 | 0-3<br>K                     | 4 0 0 0 0 1 1                   |                              |                                 |                              |                                 |                              |                                 |                              |                                 |                                  |                                    |                                  |        |
| Rocky Colavito, R (1, 9)<br>OBP: 0.356, SLG: 0.534   |   | 0-0<br>F7                       |                              | 0-0<br>F8                       |                              |                                 | 0-0<br>2B                    |                                 |                              | 3 0 1 1 0 0 0                   |                              |                                 |                              |                                 |                              |                                 |                              |                                 |                                  |                                    |                                  |        |
| Jim Gentile, L (1, 3)<br>OBP: 0.382, SLG: 0.477      |   | 4-0<br>BB                       |                              |                                 | 0-0<br>4-3                   |                                 | 4-0<br>BB                    |                                 |                              | 1 0 0 0 2 0 0                   |                              |                                 |                              |                                 |                              |                                 |                              |                                 |                                  |                                    |                                  |        |
| Doc Edwards, R (1, 2)<br>OBP: 0.243, SLG: 0.280      |   | 0-0<br>G6-4-3                   |                              |                                 | 0-0<br>L9                    |                                 | 0-0<br>G3-6-1                |                                 |                              | 3 0 0 0 0 0 3                   |                              |                                 |                              |                                 |                              |                                 |                              |                                 |                                  |                                    |                                  |        |
| Nelson Mathews, R (1, 8)<br>OBP: 0.293, SLG: 0.353   |   |                                 | 0-3<br>K                     |                                 | 0-0<br>F8                    |                                 |                              | 0-3<br>K                        |                              | 3 0 0 0 0 2 0                   |                              |                                 |                              |                                 |                              |                                 |                              |                                 |                                  |                                    |                                  |        |
| Dick Green, R (1, 4)<br>OBP: 0.300, SLG: 0.401       |   |                                 | 0-0<br>1B                    |                                 |                              | 0-0<br>F7                       |                              | 0-0<br>F6                       |                              | 3 0 1 0 0 0 0                   |                              |                                 |                              |                                 |                              |                                 |                              |                                 |                                  |                                    |                                  |        |
| Moe Drabowsky, R (1, 1)<br>OBP: 0.026, SLG: 0.026    |   |                                 | 0-0<br>G5-4-3                |                                 |                              | 0-3<br>K                        |                              | 0-0<br>F3                       |                              | 2 0 0 0 0 1 1                   |                              |                                 |                              |                                 |                              |                                 |                              |                                 |                                  |                                    |                                  |        |
| John Wyatt, R (6, 1)                                 |   |                                 |                              |                                 |                              |                                 |                              |                                 |                              | 0 0 0 0 0 0 0                   |                              |                                 |                              |                                 |                              |                                 |                              |                                 |                                  |                                    |                                  |        |
| Bert Campaneris, R (8, PH)<br>OBP: 0.366, SLG: 0.547 |   |                                 |                              |                                 |                              |                                 |                              |                                 |                              | 1 0 0 0 0 0 0                   |                              |                                 |                              |                                 |                              |                                 |                              |                                 |                                  |                                    |                                  |        |
| Wes Stock, R (8, 1)<br>OBP: 0.214, SLG: 0.154        |   |                                 |                              |                                 |                              |                                 |                              |                                 |                              | 0 0 0 0 0 0 0                   |                              |                                 |                              |                                 |                              |                                 |                              |                                 |                                  |                                    |                                  |        |
| <b>Inning Stats</b>                                  | R: 0<br>E: 0<br>K: 0<br>S: 3                          | H: 0<br>LOB: 0<br>BB: 0<br>P: 3 | R: 0<br>E: 0<br>K: 0<br>S: 2 | H: 0<br>LOB: 0<br>BB: 1<br>P: 6 | R: 0<br>E: 0<br>K: 1<br>S: 5 | H: 1<br>LOB: 0<br>BB: 0<br>P: 5 | R: 1<br>E: 0<br>K: 0<br>S: 4 | H: 1<br>LOB: 0<br>BB: 0<br>P: 4 | R: 0<br>E: 0<br>K: 0<br>S: 3 | H: 0<br>LOB: 0<br>BB: 0<br>P: 3 | R: 0<br>E: 0<br>K: 1<br>S: 5 | H: 0<br>LOB: 0<br>BB: 0<br>P: 5 | R: 1<br>E: 0<br>K: 0<br>S: 4 | H: 2<br>LOB: 1<br>BB: 1<br>P: 8 | R: 0<br>E: 0<br>K: 1<br>S: 5 | H: 0<br>LOB: 0<br>BB: 0<br>P: 5 | R: 0<br>E: 0<br>K: 1<br>S: 5 | H: 0<br>LOB: 0<br>BB: 0<br>P: 5 | 1B: 1<br>2B: 2<br>3B: 0<br>HR: 1 | SF: 0<br>SAC: 0<br>DP: 3<br>HBP: 0 | WP: 0<br>PB: 0<br>SB: 0<br>CS: 0 | PA: 30 |
| <b>PITCHER</b>                                       | IP WLS BF H R ER SO BB IBB HBP BLK WP HR S P ERA WHIP |                                 |                              |                                 |                              |                                 |                              |                                 |                              |                                 |                              |                                 |                              |                                 |                              |                                 |                              |                                 |                                  |                                    |                                  |        |
| Denny McLain, R (1, 1)<br>ERA: 3.96                  | 6.1 W 23 4 2 2 2 2 2 0 0 0 0 1 25 33 2.84 0.947       |                                 |                              |                                 |                              |                                 |                              |                                 |                              |                                 |                              |                                 |                              |                                 |                              |                                 |                              |                                 |                                  |                                    |                                  |        |
| Terry Fox, R (7, 1)<br>ERA: 2.62                     | 2.2 S 7 0 0 0 2 0 0 0 0 0 0 0 11 11 0.00 0.000        |                                 |                              |                                 |                              |                                 |                              |                                 |                              |                                 |                              |                                 |                              |                                 |                              |                                 |                              |                                 |                                  |                                    |                                  |        |

**Kansas City Athletics @ Detroit Tigers**  
 Tiger Stadium, Detroit, MI  
 Sun Aug 09 1964, 4:38 AM EDT  
 Att: 46,342 - Unknown

[livebaseballscorecards.com](http://livebaseballscorecards.com)

|     |    |
|-----|----|
| AB  | 28 |
| R   | 2  |
| H   | 4  |
| RBI | 2  |
| BB  | 2  |
| SO  | 4  |
| LOB | 5  |

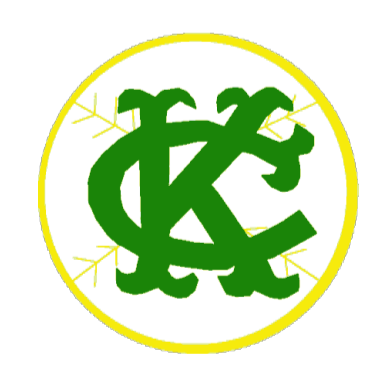

| Batter  | 1           | 2               | 3                 | 4          | 5             | 6          | 7           | 8            | 9        |
|---|-------------|-----------------|-------------------|------------|---------------|------------|-------------|--------------|----------|
| <b>Bill Bruton, L</b> (1, 8)<br>OBP: 0.336, SLG: 0.384    | 0-0<br>2-3  |                 | 0-0<br>F8         |            | 4-0<br>BB     |            | 0-0<br>5-3  |              |          |
| <b>Jerry Lumpe, L</b> (1, 4)<br>OBP: 0.306, SLG: 0.323    | 0-0<br>4-3  |                 | 0-0<br>1B SF8 1B  |            | 0-0<br>1-2 2B |            | 0-0<br>4-3  |              |          |
| <b>Al Kaline, R</b> (1, 9)<br>OBP: 0.387, SLG: 0.481      | 0-0<br>L5-3 |                 | 0-0<br>1-3 2-H 1B |            | 4-0<br>BB     |            | 0-0<br>HR   |              |          |
| <b>Gates Brown, L</b> (1, 7)<br>OBP: 0.322, SLG: 0.517    |             | 0-0<br>4-3      | 0-0<br>SF8        |            | 0-0<br>4-3    |            | 4-0<br>S BB |              |          |
| <b>Norm Cash, L</b> (1, 3)<br>OBP: 0.323, SLG: 0.420      |             | 0-0<br>FC4-6 1B | 0-0<br>1-3        |            |               | 0-0<br>HR  | 0-0<br>L8   |              |          |
| <b>Dick McAuliffe, L</b> (1, 6)<br>OBP: 0.341, SLG: 0.472 |             | 0-0<br>FC4-6 1B |                   | 0-3<br>K   |               | 0-0<br>G3  |             | 0-0<br>E3 1B |          |
| <b>Bill Freehan, R</b> (1, 2)<br>OBP: 0.346, SLG: 0.439   |             | 0-0<br>FC5-4 1B |                   | 0-0<br>F9  |               | 0-0<br>HR  |             | 0-3<br>K     |          |
| <b>Bubba Phillips, R</b> (1, 5)<br>OBP: 0.322, SLG: 0.375 |             | 0-0<br>FC5-4    |                   | 0-0<br>5-3 |               | 0-0<br>6-3 |             | 0-3<br>K     |          |
| <b>Denny McLain, R</b> (1, 1)<br>OBP: 0.136, SLG: 0.095   |             |                 | 0-0<br>1B 1B      |            | 0-0<br>F9     |            | 0-0<br>F4   |              | 0-3<br>K |
| <b>Terry Fox, R</b> (7, 1)<br>OBP: 0.286, SLG: 0.429      |             |                 |                   |            |               |            |             |              |          |

AB R H RBI BB SO LOB

**Kansas City Athletics @ Detroit Tigers**  
Tiger Stadium, Detroit, MI  
Sun Aug 09 1964, 4:38 AM EDT  
Att. 46,342 - Unknown

|   |   |   |   |   |   |   |
|---|---|---|---|---|---|---|
| 3 | 0 | 0 | 0 | 1 | 0 | 1 |
| 4 | 1 | 2 | 0 | 0 | 0 | 0 |
| 3 | 1 | 2 | 2 | 1 | 0 | 0 |
| 2 | 0 | 0 | 1 | 1 | 0 | 2 |
| 4 | 1 | 2 | 1 | 0 | 0 | 2 |
| 4 | 0 | 1 | 0 | 0 | 1 | 1 |
| 4 | 1 | 2 | 1 | 0 | 1 | 1 |
| 4 | 0 | 0 | 0 | 0 | 1 | 3 |
| 3 | 1 | 1 | 0 | 0 | 0 | 0 |
| 1 | 0 | 0 | 0 | 0 | 1 | 1 |

livebaseballscorecards.com

|     |    |
|-----|----|
| AB  | 32 |
| R   | 5  |
| H   | 10 |
| RBI | 5  |
| BB  | 3  |
| SO  | 4  |
| LOB | 11 |



| Inning Stats | R: 0   | H: 0  | E: 0 | K: 0   | S: 3  | R: 0 | H: 2   | E: 0  | K: 0 | S: 5   | R: 2  | H: 3 | E: 0   | K: 0  | S: 6  | R: 0   | H: 0  | E: 0 | K: 1   | S: 5  | R: 0 | H: 1   | E: 0  | K: 0  | S: 3   | R: 2  | H: 2  | E: 0   | K: 0  | S: 5  | R: 1   | H: 1   | E: 0  | K: 0   | S: 4 | R: 0 | H: 1 | E: 1 | K: 3 | S: 10 |
|--------------|--------|-------|------|--------|-------|------|--------|-------|------|--------|-------|------|--------|-------|-------|--------|-------|------|--------|-------|------|--------|-------|-------|--------|-------|-------|--------|-------|-------|--------|--------|-------|--------|------|------|------|------|------|-------|
|              | LOB: 0 | BB: 0 | P: 3 | LOB: 2 | BB: 0 | P: 5 | LOB: 1 | BB: 0 | P: 6 | LOB: 0 | BB: 0 | P: 5 | LOB: 2 | BB: 2 | P: 11 | LOB: 0 | BB: 0 | P: 5 | LOB: 1 | BB: 1 | P: 8 | LOB: 1 | BB: 0 | P: 10 | LOB: 0 | BB: 0 | P: 10 | LOB: 0 | BB: 0 | P: 10 | LOB: 1 | SAC: 0 | DP: 0 | HBP: 0 |      |      |      |      |      |       |

| PITCHER                                     | IP  | WLS | BF | H | R | ER | SO | BB | IBB | HBP | BLK | WP | HR | S  | P  | ERA  | WHIP  |
|---|-----|-----|----|---|---|----|----|----|-----|-----|-----|----|----|----|----|------|-------|
| <b>Moe Drabowsky, R</b> (1, 1)<br>ERA: 5.79 | 5.1 | L   | 25 | 8 | 4 | 4  | 1  | 2  | 0   | 0   | 0   | 0  | 2  | 25 | 33 | 6.75 | 1.875 |
| <b>John Wyatt, R</b> (6, 1)<br>ERA: 3.89    | 1.2 |     | 7  | 1 | 1 | 1  | 0  | 1  | 0   | 0   | 0   | 0  | 1  | 6  | 10 | 5.40 | 1.200 |
| <b>Wes Stock, R</b> (8, 1)<br>ERA: 2.5      | 1.0 |     | 4  | 1 | 0 | 0  | 3  | 0  | 0   | 0   | 0   | 0  | 0  | 10 | 10 | 0.00 | 1.000 |

| WP: 0 | PA: 36 |
|-------|--------|
| PB: 0 | SB: 1  |
| CS: 1 |        |

| Batter  | 1   | 2                               | 3                            | 4                               | 5                            | 6                               | 7                            | 8                                | 9                            | AB R H RBI BB SO LOB            | TOP                          |                                 |                              |                                 |                              |                                 |                                  |                                    |                                  |        |
|---|---|---------------------------------|------------------------------|---------------------------------|------------------------------|---------------------------------|------------------------------|----------------------------------|------------------------------|---------------------------------|------------------------------|---------------------------------|------------------------------|---------------------------------|------------------------------|---------------------------------|----------------------------------|------------------------------------|----------------------------------|--------|
| <b>Fred Valentine, S</b> (1, 7)<br>OBP: 0.323, SLG: 0.330   | 0-3<br>K  |                                 | 0-0<br>3-1                   |                                 | 0-0<br>P1                    |                                 |                              | 0-0<br>3-1                       |                              | 4 0 0 0 0 1 0                   |                              |                                 |                              |                                 |                              |                                 |                                  |                                    |                                  |        |
| <b>Don Blasingame, L</b> (1, 4)<br>OBP: 0.310, SLG: 0.311   | 0-0<br>F9   |                                 |                              | 0-0<br>F9                       | 0-0<br>F5                    |                                 |                              | 0-0<br>4-1                       |                              | 4 0 0 0 0 0 0                   |                              |                                 |                              |                                 |                              |                                 |                                  |                                    |                                  |        |
| <b>Jim King, L</b> (1, 9)<br>OBP: 0.353, SLG: 0.451   | 0-0<br>HR   |                                 |                              | 4-0<br>HR BB                    | 0-0<br>4-3                   |                                 |                              | 0-0<br>1-3                       |                              | 3 2 1 1 1 0 0                   |                              |                                 |                              |                                 |                              |                                 |                                  |                                    |                                  |        |
| <b>Don Lock, R</b> (1, 8)<br>OBP: 0.352, SLG: 0.473   | 0-0<br>F9   |                                 |                              | 0-0<br>1-H<br>HR                |                              | 0-3<br>K                        |                              |                                  | 0-0<br>F7                    | 4 1 1 2 0 1 0                   |                              |                                 |                              |                                 |                              |                                 |                                  |                                    |                                  |        |
| <b>Dick Phillips, L</b> (1, 3)<br>OBP: 0.322, SLG: 0.297  |   | 0-0<br>F2                       |                              | 0-0<br>1B<br>2B<br>1B           |                              | 0-0<br>F7                       |                              |                                  | 0-0<br>P4                    | 4 1 1 0 0 0 0                   |                              |                                 |                              |                                 |                              |                                 |                                  |                                    |                                  |        |
| <b>Don Zimmer, R</b> (1, 5)<br><b>John Kennedy, R</b> (6, 5)<br>OBP: 0.297, SLG: 0.444<br>OBP: 0.295, SLG: 0.356  |   | 0-0<br>1-3                      |                              | 0-3<br>K                        |                              | 0-3<br>K                        |                              |                                  | 0-3<br>K                     | 3 0 0 0 0 2 1<br>1 0 0 0 0 1 0  |                              |                                 |                              |                                 |                              |                                 |                                  |                                    |                                  |        |
| <b>Mike Brumley, L</b> (1, 2)<br>OBP: 0.319, SLG: 0.316   |   | 0-0<br>F5                       |                              | 0-0<br>1-3<br>2B<br>1B          |                              |                                 | 0-0<br>1-3                   |                                  |                              | 3 1 1 0 0 0 0                   |                              |                                 |                              |                                 |                              |                                 |                                  |                                    |                                  |        |
| <b>Ed Brinkman, R</b> (1, 6)<br>OBP: 0.267, SLG: 0.328  |   |                                 | 0-0<br>6-3                   | 0-0<br>1-H<br>2B                |                              |                                 | 0-0<br>P4                    |                                  |                              | 3 0 1 2 0 0 0                   |                              |                                 |                              |                                 |                              |                                 |                                  |                                    |                                  |        |
| <b>Claude Osteen, L</b> (1, 1)<br><b>Jim Hannan, R</b> (7, 1)<br>OBP: 0.157, SLG: 0.179<br>OBP: 0.176, SLG: 0.188 |   |                                 | 0-0<br>F7                    | 0-0<br>3-H<br>4-3               |                              |                                 | 0-0<br>6-3                   |                                  |                              | 3 0 0 0 0 0 1<br>0 0 0 0 0 0 0  |                              |                                 |                              |                                 |                              |                                 |                                  |                                    |                                  |        |
| <b>Inning Stats</b>   | R: 1<br>E: 0<br>K: 1<br>S: 6                          | H: 1<br>LOB: 0<br>BB: 0<br>P: 6 | R: 0<br>E: 0<br>K: 0<br>S: 3 | H: 0<br>LOB: 0<br>BB: 0<br>P: 3 | R: 0<br>E: 0<br>K: 3<br>S: 3 | H: 0<br>LOB: 0<br>BB: 0<br>P: 3 | R: 4<br>E: 0<br>K: 1<br>S: 9 | H: 4<br>LOB: 1<br>BB: 1<br>P: 13 | R: 0<br>E: 0<br>K: 2<br>S: 7 | H: 0<br>LOB: 0<br>BB: 0<br>P: 7 | R: 0<br>E: 0<br>K: 0<br>S: 3 | H: 0<br>LOB: 0<br>BB: 0<br>P: 3 | R: 0<br>E: 0<br>K: 0<br>S: 3 | H: 0<br>LOB: 0<br>BB: 0<br>P: 3 | R: 0<br>E: 0<br>K: 1<br>S: 5 | H: 0<br>LOB: 0<br>BB: 0<br>P: 5 | 1B: 2<br>2B: 1<br>3B: 0<br>HR: 2 | SF: 0<br>SAC: 0<br>DP: 0<br>HBP: 0 | WP: 0<br>PB: 0<br>SB: 0<br>CS: 0 | PA: 33 |
| <b>PITCHER</b>  | IP WLS BF H R ER SO BB IBB HBP BLK WP HR S P ERA WHIP |                                 |                              |                                 |                              |                                 |                              |                                  |                              |                                 |                              |                                 |                              |                                 |                              |                                 |                                  |                                    |                                  |        |
| <b>Diego Segui, R</b> (1, 1)<br>ERA: 3.93   | 3.2 L 17 5 5 5 2 1 0 0 0 0 0 2 20 24 12.27 1.636      |                                 |                              |                                 |                              |                                 |                              |                                  |                              |                                 |                              |                                 |                              |                                 |                              |                                 |                                  |                                    |                                  |        |
| <b>Wes Stock, R</b> (4, 1)<br>ERA: 2.45   | 1.1 4 0 0 0 0 0 0 0 0 0 0 0 4 4 0.00 0.000            |                                 |                              |                                 |                              |                                 |                              |                                  |                              |                                 |                              |                                 |                              |                                 |                              |                                 |                                  |                                    |                                  |        |
| <b>Ken Sanders, R</b> (6, 1)<br>ERA: 1.35   | 2.0 6 0 0 0 0 2 0 0 0 0 0 0 10 10 0.00 0.000          |                                 |                              |                                 |                              |                                 |                              |                                  |                              |                                 |                              |                                 |                              |                                 |                              |                                 |                                  |                                    |                                  |        |
| <b>John Wyatt, R</b> (8, 1)<br>ERA: 3.8   | 2.0 6 0 0 0 0 1 0 0 0 0 0 0 8 8 0.00 0.000            |                                 |                              |                                 |                              |                                 |                              |                                  |                              |                                 |                              |                                 |                              |                                 |                              |                                 |                                  |                                    |                                  |        |

Washington Senators @ Kansas City Athletics  
Municipal Stadium, Kansas City, MO  
Tue Aug 11 1964, 8:05 PM EDT  
Att. 8,062 - Unknown

|     |    |
|-----|----|
| AB  | 32 |
| R   | 5  |
| H   | 5  |
| RBI | 5  |
| BB  | 1  |
| SO  | 5  |
| LOB | 2  |



livebaseballscorecards.com

BOTTOM

Washington Senators @ Kansas City Athletics  
Municipal Stadium, Kansas City, MO  
Tue Aug 11 1964, 8:05 PM EDT  
Att. 8,062 - Unknown

livebaseballscorecards.com

AB 37  
R 2  
H 10  
RBI 2  
BB 1  
SO 8  
LOB 18

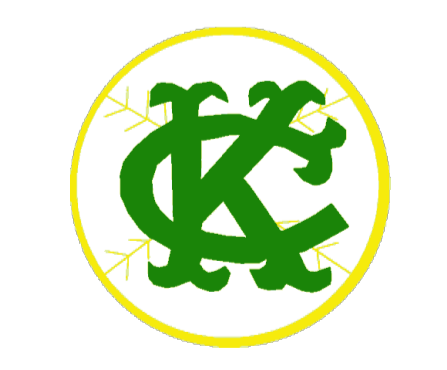

WP: 0 PA: 38  
PB: 0  
SB: 0  
CS: 0

AB R H RBI BB SO LOB

|   |   |   |   |   |   |   |
|---|---|---|---|---|---|---|
| 5 | 0 | 1 | 0 | 0 | 2 | 3 |
| 4 | 0 | 1 | 0 | 1 | 0 | 3 |
| 3 | 0 | 0 | 0 | 0 | 1 | 1 |
| 1 | 0 | 0 | 0 | 0 | 1 | 2 |
| 4 | 0 | 0 | 0 | 0 | 0 | 1 |
| 4 | 0 | 1 | 0 | 0 | 2 | 1 |
| 4 | 1 | 2 | 0 | 0 | 0 | 1 |
| 4 | 0 | 2 | 0 | 0 | 1 | 3 |
| 4 | 1 | 1 | 1 | 0 | 1 | 3 |
| 1 | 0 | 1 | 0 | 0 | 0 | 0 |
| 0 | 0 | 0 | 0 | 0 | 0 | 0 |
| 1 | 0 | 1 | 1 | 0 | 0 | 0 |
| 0 | 0 | 0 | 0 | 0 | 0 | 0 |
| 1 | 0 | 0 | 0 | 0 | 0 | 0 |
| 0 | 0 | 0 | 0 | 0 | 0 | 0 |
| 1 | 0 | 0 | 0 | 0 | 0 | 0 |

1B: 7 SF: 0  
2B: 2 SAC: 0  
3B: 0 DP: 1  
HR: 1 HBP: 0

| Batter  | 1         | 2                   | 3                    | 4         | 5               | 6            | 7          | 8        | 9        |
|---|-----------|---------------------|----------------------|-----------|-----------------|--------------|------------|----------|----------|
| Bert Campaneris, R (1, 6)<br>OBP: 0.355, SLG: 0.522   | 0-0 4-3 ① |                     | 0-3 K ①              |           | 0-0 P6 ②        |              | 0-0 BB 1B  |          | 0-3 K ②  |
| Wayne Causey, L (1, 5)<br>OBP: 0.377, SLG: 0.380  | 0-0 2B    |                     | 0-0 G4-6-3 ②<br>1-2f |           | 0-0 4-3 ③       |              | 4-0 BB 1-2 |          | 0-0 F5 ③ |
| Ken Harrelson, R (1, 7)<br>Manny Jimenez, L (7, PH) (8, 7)<br>OBP: 0.242, SLG: 0.363<br>OBP: 0.300, SLG: 0.500  | 0-0 F9 ②  |                     |                      | 0-3 K ①   |                 | 0-0 5-3 ①    | 0-3 K ③    |          |          |
| Rocky Colavito, R (1, 9)<br>OBP: 0.353, SLG: 0.529  | 0-0 5-3 ③ |                     |                      | 0-0 5-3 ② |                 | 0-0 4-3 ②    |            | 0-0 E6   |          |
| Jim Gentile, L (1, 3)<br>OBP: 0.380, SLG: 0.473   |           | 0-0 4-3 ①           |                      | 0-3 K ③   |                 | 0-0 1B 1B    |            | 0-3 K ①  |          |
| Doc Edwards, R (1, 2)<br>OBP: 0.248, SLG: 0.284   |           | 0-0 G3 ②            |                      |           | 0-0 F9 1B 2B 1B | 0-0 FC4 1B   |            | 0-0 F8 ② |          |
| Dick Green, R (1, 4)<br>OBP: 0.303, SLG: 0.402  |           | 0-0 FC6-4 1B        |                      |           | 0-0 2B 1B       | 0-0 FC4 1-2f |            | 0-3 K ③  |          |
| Nelson Mathews, R (1, 8)<br>OBP: 0.292, SLG: 0.360  |           | 0-0 FC6-4 ③<br>1-2f |                      |           | 0-0 F9 ①<br>2-3 |              | 0-3 K ①    |          | 0-0 HR   |
| Diego Segui, R (1, 1)<br>Wes Stock, R (4, 1)<br>George Alusik, R (5, PH)<br>Ken Sanders, R (6, 1)<br>Ed Charles, R (7, PH)<br>John Wyatt, R (8, 1)<br>Jose Tartabull, L (9, PH)<br>OBP: 0.236, SLG: 0.246<br>OBP: 0.214, SLG: 0.154<br>OBP: 0.353, SLG: 0.368 |           |                     | 0-0 G4-6-3 1B        |           | 0-0 1-3 2B      |              | 0-0 6-3 ②  |          | 0-0 F9 ① |

| Inning Stats | R: 0 | H: 1 | E: 0 | LOB: 1 | K: 0 | BB: 0 | S: 4 | P: 4  |
|--------------|------|------|------|--------|------|-------|------|-------|
|              | R: 0 | H: 1 | E: 0 | LOB: 1 | K: 0 | BB: 0 | S: 4 | P: 4  |
|              | R: 0 | H: 1 | E: 0 | LOB: 0 | K: 1 | BB: 0 | S: 5 | P: 5  |
|              | R: 0 | H: 0 | E: 0 | LOB: 0 | K: 2 | BB: 0 | S: 7 | P: 7  |
|              | R: 1 | H: 3 | E: 0 | LOB: 2 | K: 0 | BB: 0 | S: 6 | P: 6  |
|              | R: 0 | H: 2 | E: 0 | LOB: 2 | K: 0 | BB: 0 | S: 5 | P: 5  |
|              | R: 0 | H: 1 | E: 0 | LOB: 2 | K: 2 | BB: 1 | S: 8 | P: 12 |
|              | R: 0 | H: 0 | E: 1 | LOB: 1 | K: 2 | BB: 0 | S: 8 | P: 8  |
|              | R: 1 | H: 1 | E: 0 | LOB: 0 | K: 1 | BB: 0 | S: 6 | P: 6  |

| PITCHER                              | IP  | WLS | BF | H | R | ER | SO | BB | IBB | HBP | BLK | WP | HR | S  | P  | ERA  | WHIP  |
|--------------------------------------|-----|-----|----|---|---|----|----|----|-----|-----|-----|----|----|----|----|------|-------|
| Claude Osteen, L (1, 1)<br>ERA: 3.44 | 6.2 | W   | 29 | 9 | 1 | 1  | 4  | 1  | 0   | 0   | 0   | 0  | 0  | 36 | 40 | 1.35 | 1.500 |
| Jim Hannan, R (7, 1)<br>ERA: 3.98    | 2.1 | S   | 9  | 1 | 1 | 1  | 4  | 0  | 0   | 0   | 0   | 0  | 1  | 17 | 17 | 3.86 | 0.429 |

| Batter  | 1   | 2                               | 3                            | 4                               | 5                            | 6                                | 7                            | 8                               | 9                            | AB R H RBI BB SO LOB            | TOP   |                                 |                              |                                 |                              |                                 |                                  |                                    |                                  |        |  |  |  |  |  |  |  |  |  |  |  |  |  |  |  |  |
|---|---|---------------------------------|------------------------------|---------------------------------|------------------------------|----------------------------------|------------------------------|---------------------------------|------------------------------|---------------------------------|---|---------------------------------|------------------------------|---------------------------------|------------------------------|---------------------------------|----------------------------------|------------------------------------|----------------------------------|--------|--|--|--|--|--|--|--|--|--|--|--|--|--|--|--|--|
| <b>Fred Valentine, S</b> (1, 7)<br>OBP: 0.322, SLG: 0.328 | 0-3<br>K  |                                 | 0-0<br>6-3                   |                                 | 0-0<br>F7                    |                                  |                              | 0-0<br>WP 4-3<br>HR 1B          |                              | 4 1 1 0 0 1 0                   | <b>Washington Senators @ Kansas City Athletics</b><br><b>Municipal Stadium, Kansas City, MO</b><br>Wed Aug 12 1964, 8:05 PM EDT<br>Att. 3,786 - Unknown |                                 |                              |                                 |                              |                                 |                                  |                                    |                                  |        |  |  |  |  |  |  |  |  |  |  |  |  |  |  |  |  |
| <b>Don Blasingame, L</b> (1, 4)<br>OBP: 0.309, SLG: 0.310 | 0-0<br>HR 1B  |                                 | 0-0<br>4-3                   |                                 |                              | 0-0<br>F7                        |                              | 0-0<br>4-3                      |                              | 4 1 1 0 0 0 1                   |   |                                 |                              |                                 |                              |                                 |                                  |                                    |                                  |        |  |  |  |  |  |  |  |  |  |  |  |  |  |  |  |  |
| <b>Jim King, L</b> (1, 9)<br>OBP: 0.354, SLG: 0.459       | 0-0<br>P4   |                                 |                              | 0-0<br>4-3                      |                              | 4-0<br>HBP<br>BB                 |                              | 0-0<br>2-H<br>HR                |                              | 3 1 1 2 1 0 1                   |   |                                 |                              |                                 |                              |                                 |                                  |                                    |                                  |        |  |  |  |  |  |  |  |  |  |  |  |  |  |  |  |  |
| <b>Don Lock, R</b> (1, 8)<br>OBP: 0.353, SLG: 0.480       | 0-0<br>1-H<br>HR                                      |                                 |                              | 0-3<br>K                        |                              | 1-0<br>H<br>G6-4-3<br>HBP        |                              | 0-3<br>K                        |                              | 3 1 1 2 0 2 0                   |   |                                 |                              |                                 |                              |                                 |                                  |                                    |                                  |        |  |  |  |  |  |  |  |  |  |  |  |  |  |  |  |  |
| <b>Dick Phillips, L</b> (1, 3)<br>OBP: 0.316, SLG: 0.290  | 0-3<br>K  |                                 |                              | 0-0<br>E1<br>BB                 |                              | 0-0<br>G6-4-3<br>1-2f            |                              | 0-0<br>4-3                      |                              | 4 0 0 0 0 1 2                   |   |                                 |                              |                                 |                              |                                 |                                  |                                    |                                  |        |  |  |  |  |  |  |  |  |  |  |  |  |  |  |  |  |
| <b>Don Zimmer, R</b> (1, 5)<br>OBP: 0.298, SLG: 0.440     |   | 0-3<br>K                        |                              | 4-0<br>BB<br>FC4-6<br>BB        |                              | 0-0<br>L4                        |                              | 0-3<br>K                        |                              | 2 0 0 0 1 1 0                   |   |                                 |                              |                                 |                              |                                 |                                  |                                    |                                  |        |  |  |  |  |  |  |  |  |  |  |  |  |  |  |  |  |
| <b>John Kennedy, R</b> (8, 5)<br>OBP: 0.295, SLG: 0.355   |   |                                 |                              |                                 |                              |                                  |                              |                                 |                              | 1 0 0 0 0 1 0                   |   |                                 |                              |                                 |                              |                                 |                                  |                                    |                                  |        |  |  |  |  |  |  |  |  |  |  |  |  |  |  |  |  |
| <b>Mike Brumley, L</b> (1, 2)<br>OBP: 0.316, SLG: 0.312   |   | 0-3<br>K                        |                              | 0-0<br>FC4-6<br>1-2f            |                              | 0-0<br>F8                        |                              | 0-3<br>K                        |                              | 4 0 0 0 0 2 2                   |   |                                 |                              |                                 |                              |                                 |                                  |                                    |                                  |        |  |  |  |  |  |  |  |  |  |  |  |  |  |  |  |  |
| <b>Ed Brinkman, R</b> (1, 6)<br>OBP: 0.266, SLG: 0.325    |   | 0-0<br>4-3                      |                              |                                 | 0-0<br>F7                    |                                  | 4-0<br>BB<br>BB              |                                 | 0-0<br>6-3                   | 3 0 0 0 1 0 0                   |   |                                 |                              |                                 |                              |                                 |                                  |                                    |                                  |        |  |  |  |  |  |  |  |  |  |  |  |  |  |  |  |  |
| <b>Buster Narum, R</b> (1, 1)<br>OBP: 0.022, SLG: 0.022   |   |                                 | 0-0<br>3-1                   |                                 | 0-3<br>K                     |                                  | 0-3<br>K                     |                                 |                              | 2 0 0 0 0 1 0                   |   |                                 |                              |                                 |                              |                                 |                                  |                                    |                                  |        |  |  |  |  |  |  |  |  |  |  |  |  |  |  |  |  |
| <b>Alan Koch, R</b> (5, 1)<br>OBP: 0.286, SLG: 0.393      |   |                                 |                              |                                 |                              |                                  |                              |                                 |                              | 0 0 0 0 0 0 0                   |   |                                 |                              |                                 |                              |                                 |                                  |                                    |                                  |        |  |  |  |  |  |  |  |  |  |  |  |  |  |  |  |  |
| <b>Steve Ridzik, R</b> (5, 1)<br>OBP: 0.318, SLG: 0.333   |   |                                 |                              |                                 |                              |                                  |                              |                                 |                              | 0 0 0 0 0 0 0                   |   |                                 |                              |                                 |                              |                                 |                                  |                                    |                                  |        |  |  |  |  |  |  |  |  |  |  |  |  |  |  |  |  |
| <b>Roy Sievers, R</b> (7, PH)<br>OBP: 0.257, SLG: 0.313   |   |                                 |                              |                                 |                              |                                  |                              |                                 |                              | 1 0 0 0 0 1 1                   |   |                                 |                              |                                 |                              |                                 |                                  |                                    |                                  |        |  |  |  |  |  |  |  |  |  |  |  |  |  |  |  |  |
| <b>Ron Kline, R</b> (7, 1)<br>OBP: 0.400, SLG: 0.250      |   |                                 |                              |                                 |                              |                                  |                              |                                 |                              | 0 0 0 0 0 0 0                   |   |                                 |                              |                                 |                              |                                 |                                  |                                    |                                  |        |  |  |  |  |  |  |  |  |  |  |  |  |  |  |  |  |
| <b>Inning Stats</b>                                       | R: 2<br>E: 0<br>K: 2<br>S: 9                          | H: 2<br>LOB: 0<br>BB: 0<br>P: 9 | R: 0<br>E: 0<br>K: 2<br>S: 7 | H: 0<br>LOB: 0<br>BB: 0<br>P: 7 | R: 0<br>E: 0<br>K: 0<br>S: 3 | H: 0<br>LOB: 2<br>BB: 1<br>P: 10 | R: 0<br>E: 0<br>K: 1<br>S: 5 | H: 0<br>LOB: 0<br>BB: 0<br>P: 5 | R: 0<br>E: 0<br>K: 0<br>S: 2 | H: 0<br>LOB: 1<br>BB: 1<br>P: 7 | R: 0<br>E: 0<br>K: 1<br>S: 5  | H: 0<br>LOB: 1<br>BB: 1<br>P: 9 | R: 2<br>E: 0<br>K: 1<br>S: 7 | H: 2<br>LOB: 0<br>BB: 0<br>P: 7 | R: 0<br>E: 0<br>K: 2<br>S: 7 | H: 0<br>LOB: 0<br>BB: 0<br>P: 7 | 1B: 2<br>2B: 0<br>3B: 0<br>HR: 2 | SF: 0<br>SAC: 0<br>DP: 1<br>HBP: 1 | WP: 1<br>PB: 0<br>SB: 0<br>CS: 0 | PA: 35 |  |  |  |  |  |  |  |  |  |  |  |  |  |  |  |  |
| <b>PITCHER</b>  | IP WLS BF H R ER SO BB IBB HBP BLK WP HR S P ERA WHIP |                                 |                              |                                 |                              |                                  |                              |                                 |                              |                                 |   |                                 |                              |                                 |                              |                                 |                                  |                                    |                                  |        |  |  |  |  |  |  |  |  |  |  |  |  |  |  |  |  |
| <b>Jose Santiago, R</b> (1, 1)<br>ERA: 4.58               | 5.1   |                                 | 22                           | 2                               | 2                            | 2                                | 6                            | 2                               | 0                            | 1                               | 0   | 0                               | 1                            | 31                              | 40                           | 3.38                            | 0.750                            |                                    |                                  |        |  |  |  |  |  |  |  |  |  |  |  |  |  |  |  |  |
| <b>Moe Drabowsky, R</b> (6, 1)<br>ERA: 5.76               | 3.2   | L                               | 13                           | 2                               | 2                            | 2                                | 4                            | 1                               | 0                            | 0                               | 0   | 1                               | 1                            | 20                              | 24                           | 4.91                            | 0.818                            |                                    |                                  |        |  |  |  |  |  |  |  |  |  |  |  |  |  |  |  |  |

livebaseballscorecards.com

|            |    |
|------------|----|
| <b>AB</b>  | 31 |
| <b>R</b>   | 4  |
| <b>H</b>   | 4  |
| <b>RBI</b> | 4  |
| <b>BB</b>  | 3  |
| <b>SO</b>  | 10 |
| <b>LOB</b> | 7  |



| Batter  | 1          | 2                   | 3                            | 4         | 5                                    | 6          | 7           | 8         | 9   | AB | R | H | RBI | BB | SO | LOB |
|---|------------|---------------------|------------------------------|-----------|--------------------------------------|------------|-------------|-----------|---|----|---|---|-----|----|----|-----|
| Dick Green, R (1, 4)<br>OBP: 0.301, SLG: 0.399  | 0-0<br>6-3 |                     | 0-0<br>6-3                   |           | 0-0<br>1B<br>1B                      | 0-0<br>1-3 |             | 0-0<br>F8 | 5 1 1 0 0 0 1                                   |    |   |   |     |    |    |     |
| Wayne Causey, L (1, 5)<br>OBP: 0.380, SLG: 0.383  | 0-0<br>4-3 |                     | 0-0<br>BB<br>1B<br>2-H<br>1B |           | 0-0<br>1B<br>1B                      | 0-0<br>4-3 |             | 0-0<br>1B | 5 1 3 1 0 0 0                                   |    |   |   |     |    |    |     |
| Manny Jimenez, L (1, 7)<br>OBP: 0.304, SLG: 0.500<br>Jose Tartabull, L (8, 7)<br>OBP: 0.244, SLG: 0.250 | 0-0<br>P3  |                     | 0-0<br>BB<br>1B              |           | 0-0<br>BB<br>1B<br>1-3<br>3-H<br>1B  |            | 0-0<br>4-3  | 0-0<br>F9 | 4 0 2 1 0 0 0<br>1 0 0 0 0 0 1                  |    |   |   |     |    |    |     |
| Rocky Colavito, R (1, 9)<br>OBP: 0.356, SLG: 0.530  |            | 0-0<br>G3-6<br>1B   | 4-0<br>1-2<br>2-3<br>BB      |           | 0-0<br>1-2<br>3-H<br>4-0<br>BB<br>1B |            | 0-0<br>F8   |           | 3 0 2 1 1 0 0                                   |    |   |   |     |    |    |     |
| Jim Gentile, L (1, 3)<br>OBP: 0.379, SLG: 0.468   |            | 0-0<br>G3-6<br>1-2f | 0-0<br>F9                    |           | 0-0<br>1-2<br>2-3<br>BB              |            | 0-3<br>K2-3 |           | 3 0 0 0 1 1 4                                   |    |   |   |     |    |    |     |
| Doc Edwards, R (1, 2)<br>OBP: 0.252, SLG: 0.285   |            | 0-0<br>1B           |                              | 4-0<br>BB | 0-0<br>P5                            |            | 0-0<br>4-3  |           | 3 0 1 0 1 0 3                                   |    |   |   |     |    |    |     |
| Bert Campaneris, R (1, 6)<br>OBP: 0.338, SLG: 0.493   |            | 0-0<br>F9           |                              | 0-0<br>F8 | 0-3<br>K                             |            | 0-0<br>F9   |           | 4 0 0 0 0 1 5                                   |    |   |   |     |    |    |     |
| Nelson Mathews, R (1, 8)<br>OBP: 0.292, SLG: 0.359  |            |                     | 0-0<br>SH3-4<br>1B           | 0-0<br>F8 | 0-3<br>K                             |            | 0-0<br>4-3  |           | 4 1 1 0 0 1 4                                   |    |   |   |     |    |    |     |
| Jose Santiago, R (1, 1)<br>Moe Drabowsky, R (6, 1)<br>Ed Charles, R (9, PH)<br>OBP: 0.328, SLG: 0.380   |            |                     | 0-0<br>SH3-4                 | 0-3<br>K  | 0-3<br>K                             |            | 0-0<br>6-3  |           | 1 0 0 0 0 1 1<br>1 0 0 0 0 1 0<br>1 0 0 0 0 0 0 |    |   |   |     |    |    |     |

| Inning Stats | R: 0 | H: 0 | E: 0 | K: 0 | S: 3 | H: 2 | LOB: 1 | BB: 0 | P: 4 | R: 1 | H: 3 | E: 0 | K: 0 | S: 6 | R: 0 | H: 0 | E: 0 | K: 1 | S: 5 | R: 2 | H: 4 | E: 0 | K: 2 | S: 11 | R: 0 | H: 0 | E: 0 | K: 1 | S: 5 | R: 0 | H: 0 | E: 0 | K: 1 | S: 3 | R: 0 | H: 1 | E: 0 | K: 0 | S: 4 | R: 0 | H: 0 | E: 0 | K: 0 | S: 3 | R: 0 | H: 1 | E: 0 | K: 0 | S: 4 | 1B: 10 | SF: 0 | 2B: 0 | SAC: 1 | 3B: 0 | DP: 1 | HR: 0 | HBP: 0 | WP: 0 | PA: 39 |
|--------------|------|------|------|------|------|------|--------|-------|------|------|------|------|------|------|------|------|------|------|------|------|------|------|------|-------|------|------|------|------|------|------|------|------|------|------|------|------|------|------|------|------|------|------|------|------|------|------|------|------|------|--------|-------|-------|--------|-------|-------|-------|--------|-------|--------|
|--------------|------|------|------|------|------|------|--------|-------|------|------|------|------|------|------|------|------|------|------|------|------|------|------|------|-------|------|------|------|------|------|------|------|------|------|------|------|------|------|------|------|------|------|------|------|------|------|------|------|------|------|--------|-------|-------|--------|-------|-------|-------|--------|-------|--------|

| PITCHER                             | IP  | WLS | BF | H | R | ER | SO | BB | IBB | HBP | BLK | WP | HR | S  | P  | ERA  | WHIP  |
|-------------------------------------|-----|-----|----|---|---|----|----|----|-----|-----|-----|----|----|----|----|------|-------|
| Buster Narum, R (1, 1)<br>ERA: 4.03 | 4.0 |     | 20 | 7 | 3 | 3  | 1  | 2  | 0   | 0   | 0   | 0  | 0  | 20 | 28 | 6.75 | 2.250 |
| Alan Koch, R (5, 1)<br>ERA: 5.27    | 0.0 |     | 2  | 2 | 0 | 0  | 0  | 0  | 0   | 0   | 0   | 0  | 0  | 2  | 2  | ∞    | ∞     |
| Steve Ridzik, R (5, 1)<br>ERA: 2.45 | 2.0 |     | 7  | 0 | 0 | 0  | 3  | 1  | 0   | 0   | 0   | 0  | 0  | 12 | 16 | 0.00 | 0.500 |
| Ron Kline, R (7, 1)<br>ERA: 2.28    | 3.0 | W   | 10 | 1 | 0 | 0  | 1  | 0  | 0   | 0   | 0   | 0  | 0  | 12 | 12 | 0.00 | 0.333 |

**BOTTOM**

Washington Senators @ Kansas City Athletics  
Municipal Stadium, Kansas City, MO  
Wed Aug 12 1964, 8:05 PM EDT  
Att. 3,786 - Unknown

[livebaseballscorecards.com](http://livebaseballscorecards.com)

|            |           |
|------------|-----------|
| <b>AB</b>  | <b>35</b> |
| <b>R</b>   | <b>3</b>  |
| <b>H</b>   | <b>10</b> |
| <b>RBI</b> | <b>3</b>  |
| <b>BB</b>  | <b>3</b>  |
| <b>SO</b>  | <b>5</b>  |
| <b>LOB</b> | <b>19</b> |



| Batter  | 1   | 2                                | 3                            | 4                               | 5                            | 6                               | 7                            | 8                               | 9                            | AB R H RBI BB SO LOB            | TOP                          |                                 |                              |                                 |                              |                                  |                              |                                 |                                  |                                    |                                  |        |
|---|---|----------------------------------|------------------------------|---------------------------------|------------------------------|---------------------------------|------------------------------|---------------------------------|------------------------------|---------------------------------|------------------------------|---------------------------------|------------------------------|---------------------------------|------------------------------|----------------------------------|------------------------------|---------------------------------|----------------------------------|------------------------------------|----------------------------------|--------|
| Bill Bruton, L (1, 8)<br>OBP: 0.340, SLG: 0.381     | 0-3<br>K  | 0-0<br>F5                        |                              | 0-3<br>K                        |                              |                                 | 0-0<br>3-1                   |                                 | 0-0<br>6-3                   | 5 0 0 0 0 2 2                   |                              |                                 |                              |                                 |                              |                                  |                              |                                 |                                  |                                    |                                  |        |
| Jerry Lumpe, L (1, 4)<br>OBP: 0.305, SLG: 0.321     | 0-0<br>2B   |                                  | 0-0<br>F7                    |                                 | 0-0<br>F7                    |                                 | 0-0<br>G3                    |                                 | 4-0<br>BB                    | 4 0 1 0 1 0 0                   |                              |                                 |                              |                                 |                              |                                  |                              |                                 |                                  |                                    |                                  |        |
| Al Kaline, R (1, 9)<br>OBP: 0.381, SLG: 0.471       | 0-3<br>K  |                                  | 0-0<br>L5-3                  |                                 | 0-0<br>2B 1B                 |                                 | 0-0<br>3B 1B                 |                                 | 0-3<br>K                     | 5 1 2 0 0 2 2                   |                              |                                 |                              |                                 |                              |                                  |                              |                                 |                                  |                                    |                                  |        |
| Gates Brown, L (1, 7)<br>OBP: 0.321, SLG: 0.511     | 4-0<br>BB   |                                  | 0-0<br>L8                    |                                 | 0-0<br>F4                    |                                 | 0-0<br>1-H 3B                |                                 | 0-0<br>F8                    | 4 0 1 1 1 0 2                   |                              |                                 |                              |                                 |                              |                                  |                              |                                 |                                  |                                    |                                  |        |
| Norm Cash, L (1, 3)<br>OBP: 0.330, SLG: 0.433       | 0-0<br>L5   |                                  |                              | 0-0<br>SF8 3B                   | 0-0<br>1-3 2B                |                                 | 0-0<br>F9                    |                                 |                              | 4 1 2 0 0 0 3                   |                              |                                 |                              |                                 |                              |                                  |                              |                                 |                                  |                                    |                                  |        |
| Bill Freehan, R (1, 2)<br>OBP: 0.351, SLG: 0.460    |   | 0-0<br>HR                        |                              | 0-0<br>F2                       | 0-3<br>K                     |                                 | 0-0<br>F3                    |                                 |                              | 4 1 1 1 0 1 3                   |                              |                                 |                              |                                 |                              |                                  |                              |                                 |                                  |                                    |                                  |        |
| Dick McAuliffe, L (1, 6)<br>OBP: 0.341, SLG: 0.469  |   | 0-0<br>F8                        |                              | 0-0<br>SF8                      |                              | 0-3<br>K                        |                              | 4-0<br>BB                       |                              | 2 0 0 1 1 1 0                   |                              |                                 |                              |                                 |                              |                                  |                              |                                 |                                  |                                    |                                  |        |
| Don Wert, R (1, 5)<br>OBP: 0.323, SLG: 0.350        |   | 0-0<br>F8                        |                              | 0-0<br>1B WP 1B                 |                              | 0-0<br>2B                       |                              | 0-3<br>K                        |                              | 4 1 2 0 0 1 1                   |                              |                                 |                              |                                 |                              |                                  |                              |                                 |                                  |                                    |                                  |        |
| Phil Regan, R (1, 1)<br>OBP: 0.429, SLG: 0.405      |   | 0-0<br>1B                        |                              | 0-0<br>1B                       |                              | 0-0<br>6-3                      |                              | 0-3<br>K                        |                              | 1 0 1 0 0 0 0                   |                              |                                 |                              |                                 |                              |                                  |                              |                                 |                                  |                                    |                                  |        |
| Bubba Phillips, R (4, PH)<br>OBP: 0.330, SLG: 0.383 |   |                                  |                              |                                 |                              |                                 |                              |                                 |                              | 1 0 1 0 0 0 0                   |                              |                                 |                              |                                 |                              |                                  |                              |                                 |                                  |                                    |                                  |        |
| Hank Aguirre, R (4, 1)                              |   |                                  |                              |                                 |                              |                                 |                              |                                 |                              | 0 0 0 0 0 0 0                   |                              |                                 |                              |                                 |                              |                                  |                              |                                 |                                  |                                    |                                  |        |
| Jake Wood, R (6, PH)<br>OBP: 0.248, SLG: 0.295      |   |                                  |                              |                                 |                              |                                 |                              |                                 |                              | 1 0 0 0 0 0 0                   |                              |                                 |                              |                                 |                              |                                  |                              |                                 |                                  |                                    |                                  |        |
| Ed Rakow, S (6, 1)                                  |   |                                  |                              |                                 |                              |                                 |                              |                                 |                              | 0 0 0 0 0 0 0                   |                              |                                 |                              |                                 |                              |                                  |                              |                                 |                                  |                                    |                                  |        |
| Don Demeter, R (8, PH)<br>OBP: 0.284, SLG: 0.426    |   |                                  |                              |                                 |                              |                                 |                              |                                 |                              | 1 0 0 0 0 1 1                   |                              |                                 |                              |                                 |                              |                                  |                              |                                 |                                  |                                    |                                  |        |
| Terry Fox, R (8, 1)<br>OBP: 0.286, SLG: 0.429       |   |                                  |                              |                                 |                              |                                 |                              |                                 |                              | 0 0 0 0 0 0 0                   |                              |                                 |                              |                                 |                              |                                  |                              |                                 |                                  |                                    |                                  |        |
| <b>Inning Stats</b>                                 | R: 0<br>E: 0<br>K: 2<br>S: 8                          | H: 1<br>LOB: 2<br>BB: 1<br>P: 12 | R: 1<br>E: 0<br>K: 0<br>S: 5 | H: 2<br>LOB: 1<br>BB: 0<br>P: 5 | R: 0<br>E: 0<br>K: 0<br>S: 3 | H: 0<br>LOB: 0<br>BB: 0<br>P: 3 | R: 2<br>E: 0<br>K: 1<br>S: 8 | H: 3<br>LOB: 1<br>BB: 0<br>P: 8 | R: 0<br>E: 0<br>K: 1<br>S: 7 | H: 2<br>LOB: 2<br>BB: 0<br>P: 7 | R: 0<br>E: 0<br>K: 1<br>S: 5 | H: 1<br>LOB: 0<br>BB: 0<br>P: 5 | R: 1<br>E: 0<br>K: 0<br>S: 5 | H: 2<br>LOB: 1<br>BB: 0<br>P: 5 | R: 0<br>E: 0<br>K: 2<br>S: 7 | H: 0<br>LOB: 1<br>BB: 1<br>P: 11 | R: 0<br>E: 0<br>K: 1<br>S: 5 | H: 0<br>LOB: 1<br>BB: 1<br>P: 9 | 1B: 5<br>2B: 3<br>3B: 2<br>HR: 1 | SF: 1<br>SAC: 0<br>DP: 0<br>HBP: 0 | WP: 1<br>PB: 0<br>SB: 0<br>CS: 0 | PA: 40 |
| <b>PITCHER</b>                                      | IP WLS BF H R ER SO BB IBB HBP BLK WP HR S P ERA WHIP |                                  |                              |                                 |                              |                                 |                              |                                 |                              |                                 |                              |                                 |                              |                                 |                              |                                  |                              |                                 |                                  |                                    |                                  |        |
| Orlando Pena, R (1, 1)<br>ERA: 4.43                 | 6.2 W 31 11 4 4 5 1 0 0 0 1 1 40 44 5.40 1.800        |                                  |                              |                                 |                              |                                 |                              |                                 |                              |                                 |                              |                                 |                              |                                 |                              |                                  |                              |                                 |                                  |                                    |                                  |        |
| Wes Stock, R (7, 1)<br>ERA: 2.38                    | 2.1 S 9 0 0 0 3 2 0 0 0 0 0 0 13 21 0.00 0.857        |                                  |                              |                                 |                              |                                 |                              |                                 |                              |                                 |                              |                                 |                              |                                 |                              |                                  |                              |                                 |                                  |                                    |                                  |        |

**Detroit Tigers @ Kansas City Athletics**  
 Municipal Stadium, Kansas City, MO  
 Fri Aug 14 1964, 8:05 PM EDT  
 Att. 4,573 - Unknown

[livebaseballscorecards.com](http://livebaseballscorecards.com)

**AB** 36  
**R** 4  
**H** 11  
**RBI** 3  
**BB** 3  
**SO** 8  
**LOB** 14





| Batter  | 1                                     | 2                                     | 3                                     | 4                                     | 5                                     | 6                                     | 7                                     | 8                                     | 9                                     | AB                               | R                                     | H                                     | RBI                                   | BB                                    | SO                                    | LOB                                   | BOTTOM  |                                    |                                  |        |
|---|---------------------------------------|---------------------------------------|---------------------------------------|---------------------------------------|---------------------------------------|---------------------------------------|---------------------------------------|---------------------------------------|---------------------------------------|----------------------------------|---------------------------------------|---------------------------------------|---------------------------------------|---------------------------------------|---------------------------------------|---------------------------------------|---|------------------------------------|----------------------------------|--------|
| Dick Green, R<br>OBP: 0.303, SLG: 0.399 (1, 4)  | 0-0<br>G3 4-3<br>1B                   | 0-3<br>K                              |                                       | 0-0<br>F5                             |                                       | 0-0<br>1B                             |                                       | 0-0<br>F4                             |                                       | 5                                | 1                                     | 2                                     | 0                                     | 0                                     | 1                                     | 3                                     | <b>Detroit Tigers @ Kansas City Athletics</b><br>Municipal Stadium, Kansas City, MO<br>Fri Aug 14 1964, 8:05 PM EDT<br>Att. 4,573 - Unknown |                                    |                                  |        |
| Wayne Causey, L<br>OBP: 0.378, SLG: 0.383 (1, 5)  | 0-0<br>4-3<br>1-2                     |                                       | 0-0<br>1B<br>2B                       | 0-0<br>L9                             |                                       | 0-0<br>F7                             |                                       | 0-0<br>G3                             |                                       | 5                                | 1                                     | 1                                     | 0                                     | 0                                     | 0                                     | 5                                     |   |                                    |                                  |        |
| Manny Jimenez, L<br>OBP: 0.303, SLG: 0.494 (1, 7)<br>Jose Tartabull, L<br>OBP: 0.244, SLG: 0.250 (8, 7) | 0-0<br>G3<br>2-3                      |                                       | 0-0<br>G4-6-3<br>1B                   |                                       | 0-0<br>4-3                            |                                       | 0-0<br>1-3                            |                                       |                                       | 4                                | 0                                     | 1                                     | 1                                     | 0                                     | 0                                     | 1                                     |   |                                    |                                  |        |
| Rocky Colavito, R<br>OBP: 0.359, SLG: 0.530 (1, 9)  | 0-0<br>1B                             |                                       | 0-0<br>G4-6-3<br>1-2f                 |                                       | 4-0<br>FC1-4<br>BB                    |                                       | 4-0<br>1B<br>BB                       |                                       |                                       | 2                                | 0                                     | 1                                     | 1                                     | 2                                     | 0                                     | 1                                     |   |                                    |                                  |        |
| Jim Gentile, L<br>OBP: 0.380, SLG: 0.467 (1, 3)   | 0-3<br>K                              |                                       | 0-0<br>F2                             |                                       | 4-0<br>FC1-4<br>BB                    |                                       | 0-0<br>1-3<br>1B                      |                                       |                                       | 3                                | 0                                     | 1                                     | 0                                     | 1                                     | 1                                     | 1                                     |   |                                    |                                  |        |
| Doc Edwards, R<br>OBP: 0.252, SLG: 0.284 (1, 2)   |                                       | 0-0<br>6-3                            |                                       | 0-0<br>1B<br>1B                       |                                       | 0-0<br>FC1-4<br>1-2f<br>2-3           |                                       | 0-3<br>K                              |                                       | 4                                | 1                                     | 1                                     | 0                                     | 0                                     | 1                                     | 4                                     |   |                                    |                                  |        |
| Bert Campaneris, R<br>OBP: 0.333, SLG: 0.494 (1, 6)   |                                       | 0-0<br>1B<br>2B                       |                                       | 0-0<br>E4<br>FC2-5<br>1B              |                                       | 0-3<br>K                              |                                       | 0-0<br>5-3                            |                                       | 4                                | 1                                     | 1                                     | 0                                     | 0                                     | 1                                     | 5                                     |   |                                    |                                  |        |
| Nelson Mathews, R<br>OBP: 0.296, SLG: 0.362 (1, 8)  |                                       | 0-0<br>WP<br>SF9<br>1B                |                                       | 0-0<br>FC2-5<br>1B                    |                                       | 0-0<br>6-3                            |                                       | 0-0<br>1B                             |                                       | 4                                | 1                                     | 3                                     | 2                                     | 0                                     | 0                                     | 0                                     |   |                                    |                                  |        |
| Orlando Pena, R<br>OBP: 0.172, SLG: 0.183 (1, 1)<br>Wes Stock, R<br>OBP: 0.200, SLG: 0.143 (7, 1)       |                                       | 0-0<br>SF9                            |                                       | 0-0<br>FC2-5                          |                                       | 0-3<br>K                              |                                       | 0-3<br>K                              |                                       | 2                                | 0                                     | 0                                     | 1                                     | 0                                     | 1                                     | 2                                     |   |                                    |                                  |        |
|   |                                       |                                       |                                       |                                       |                                       |                                       |                                       |                                       |                                       | 1                                | 0                                     | 0                                     | 0                                     | 0                                     | 1                                     | 1                                     |   |                                    |                                  |        |
| <b>Inning Stats</b>   | R: 1<br>E: 0<br>K: 1<br>S: 7          | H: 2<br>LOB: 1<br>BB: 0<br>P: 7       | R: 2<br>E: 0<br>K: 1<br>S: 7          | H: 2<br>LOB: 0<br>BB: 0<br>P: 7       | R: 1<br>E: 0<br>K: 0<br>S: 4          | H: 2<br>LOB: 0<br>BB: 0<br>P: 4       | R: 1<br>E: 1<br>K: 0<br>S: 6          | H: 2<br>LOB: 2<br>BB: 0<br>P: 6       | R: 0<br>E: 0<br>K: 1<br>S: 5          | H: 0<br>LOB: 2<br>BB: 2<br>P: 13 | R: 0<br>E: 0<br>K: 1<br>S: 6          | H: 1<br>LOB: 1<br>BB: 0<br>P: 6       | R: 0<br>E: 0<br>K: 1<br>S: 6          | H: 1<br>LOB: 2<br>BB: 1<br>P: 10      | R: 0<br>E: 0<br>K: 1<br>S: 6          | H: 1<br>LOB: 1<br>BB: 0<br>P: 6       | 1B: 9<br>2B: 2<br>3B: 0<br>HR: 0  | SF: 1<br>SAC: 0<br>DP: 1<br>HBP: 0 | WP: 1<br>PB: 0<br>SB: 0<br>CS: 0 | PA: 38 |
| <b>PITCHER</b>  | IP<br>WLS<br>BF<br>H<br>R<br>ER<br>SO | IP<br>WLS<br>BF<br>H<br>R<br>ER<br>SO | IP<br>WLS<br>BF<br>H<br>R<br>ER<br>SO | IP<br>WLS<br>BF<br>H<br>R<br>ER<br>SO | IP<br>WLS<br>BF<br>H<br>R<br>ER<br>SO | IP<br>WLS<br>BF<br>H<br>R<br>ER<br>SO | IP<br>WLS<br>BF<br>H<br>R<br>ER<br>SO | IP<br>WLS<br>BF<br>H<br>R<br>ER<br>SO | IP<br>WLS<br>BF<br>H<br>R<br>ER<br>SO | ERA<br>WHIP                      | IP<br>WLS<br>BF<br>H<br>R<br>ER<br>SO | IP<br>WLS<br>BF<br>H<br>R<br>ER<br>SO | IP<br>WLS<br>BF<br>H<br>R<br>ER<br>SO | IP<br>WLS<br>BF<br>H<br>R<br>ER<br>SO | IP<br>WLS<br>BF<br>H<br>R<br>ER<br>SO | IP<br>WLS<br>BF<br>H<br>R<br>ER<br>SO | BB<br>IBB<br>HBP<br>BLK<br>WP<br>HR<br>S<br>P   | ERA<br>WHIP                        |                                  |        |
| Phil Regan, R<br>ERA: 4.82 (1, 1)   | 3.0<br>L                              | 14                                    | 6                                     | 4                                     | 4                                     | 2                                     | 0                                     | 0                                     | 0                                     | 12.00                            | 2.000                                 |                                       |                                       |                                       |                                       |                                       |   |                                    |                                  |        |
| Hank Aguirre, L<br>ERA: 3.75 (4, 1)   | 2.0                                   | 11                                    | 2                                     | 1                                     | 0                                     | 1                                     | 2                                     | 0                                     | 0                                     | 0.00                             | 2.000                                 |                                       |                                       |                                       |                                       |                                       |   |                                    |                                  |        |
| Ed Rakow, R<br>ERA: 4.05 (6, 1)   | 2.0                                   | 9                                     | 2                                     | 0                                     | 0                                     | 2                                     | 1                                     | 0                                     | 0                                     | 0.00                             | 1.500                                 |                                       |                                       |                                       |                                       |                                       |   |                                    |                                  |        |
| Terry Fox, R<br>ERA: 2.55 (8, 1)  | 1.0                                   | 4                                     | 1                                     | 0                                     | 0                                     | 1                                     | 0                                     | 0                                     | 0                                     | 0.00                             | 1.000                                 |                                       |                                       |                                       |                                       |                                       |   |                                    |                                  |        |

livebaseballscorecards.com

|     |    |
|-----|----|
| AB  | 34 |
| R   | 5  |
| H   | 11 |
| RBI | 5  |
| BB  | 3  |
| SO  | 6  |
| LOB | 23 |



| Batter   | 1   | 2                               | 3                            | 4                               | 5                            | 6                               | 7                            | 8                               | 9                            | AB R H RBI BB SO LOB            | TOP                          |                                 |                              |                                  |                              |                                 |                              |                                  |                                  |                                    |                                  |        |
|--|---|---------------------------------|------------------------------|---------------------------------|------------------------------|---------------------------------|------------------------------|---------------------------------|------------------------------|---------------------------------|------------------------------|---------------------------------|------------------------------|----------------------------------|------------------------------|---------------------------------|------------------------------|----------------------------------|----------------------------------|------------------------------------|----------------------------------|--------|
| Bill Bruton, L (1, 8)<br>OBP: 0.341, SLG: 0.383    | 0-0<br>F6   | 0-0<br>2B                       |                              |                                 | 0-0<br>6-3                   |                                 | 4-0<br>WP SF7 E BB           |                                 | 0-0<br>6-3                   | 4 1 1 0 1 0 0                   |                              |                                 |                              |                                  |                              |                                 |                              |                                  |                                  |                                    |                                  |        |
| Jerry Lumpe, L (1, 4)<br>OBP: 0.306, SLG: 0.320    | 0-0<br>2B 1B  | 0-0<br>3-1                      |                              |                                 | 0-3<br>K                     |                                 | 0-0<br>E1 WP WP              |                                 | 4-0<br>BB BB                 | 4 1 1 0 1 1 3                   |                              |                                 |                              |                                  |                              |                                 |                              |                                  |                                  |                                    |                                  |        |
| Al Kaline, R (1, 9)<br>OBP: 0.381, SLG: 0.473      | 0-0<br>1B 2B  |                                 | 0-0<br>L1-3                  |                                 | 0-0<br>L9                    |                                 | 0-0<br>SF7                   |                                 | 4-0<br>BB BB                 | 3 1 1 1 1 0 0                   |                              |                                 |                              |                                  |                              |                                 |                              |                                  |                                  |                                    |                                  |        |
| Gates Brown, L (1, 7)<br>OBP: 0.319, SLG: 0.505    | 0-0<br>1B 1B  |                                 | 0-0<br>4-3                   |                                 | 0-0<br>4-3                   |                                 | 0-0<br>4-3                   |                                 | 0-3<br>K                     | 5 1 1 2 0 1 3                   |                              |                                 |                              |                                  |                              |                                 |                              |                                  |                                  |                                    |                                  |        |
| Norm Cash, L (1, 3)<br>OBP: 0.329, SLG: 0.429      | 0-3<br>K  |                                 | 0-0<br>4-3                   |                                 | 0-0<br>4-3                   |                                 | 0-0<br>F6                    |                                 | 4-0<br>FC5-4 BB              | 3 0 0 0 1 1 1                   |                              |                                 |                              |                                  |                              |                                 |                              |                                  |                                  |                                    |                                  |        |
| Bill Freehan, R (1, 2)<br>OBP: 0.355, SLG: 0.462   | 0-0<br>FC6-4 1B                                       |                                 | 0-0<br>F9 4-3 1B             |                                 | 4-0<br>BB                    |                                 | 0-0<br>F3                    |                                 |                              | 3 0 2 1 1 0 1                   |                              |                                 |                              |                                  |                              |                                 |                              |                                  |                                  |                                    |                                  |        |
| Dick McAuliffe, L (1, 6)<br>OBP: 0.338, SLG: 0.464 | 0-0<br>FC6-4  |                                 | 0-0<br>4-3                   |                                 | 0-0<br>F6                    |                                 | 0-0<br>F6                    |                                 | 0-0<br>F8                    | 4 0 0 0 0 0 4                   |                              |                                 |                              |                                  |                              |                                 |                              |                                  |                                  |                                    |                                  |        |
| Don Wert, R (1, 5)<br>OBP: 0.322, SLG: 0.351       |   | 0-0<br>5-3                      |                              | 0-0<br>F9                       |                              | 0-0<br>E WP 2B                  |                              | 0-0<br>FC5-4                    |                              | 4 1 1 0 0 0 2                   |                              |                                 |                              |                                  |                              |                                 |                              |                                  |                                  |                                    |                                  |        |
| Denny McLain, R (1, 1)<br>OBP: 0.115, SLG: 0.080   |   | 0-3<br>K                        |                              | 0-0<br>4-3                      |                              | 0-3<br>K                        |                              | 0-3<br>K                        |                              | 4 0 0 0 0 3 2                   |                              |                                 |                              |                                  |                              |                                 |                              |                                  |                                  |                                    |                                  |        |
| <b>Inning Stats</b>                                | R: 3<br>E: 0<br>K: 1<br>S: 9                          | H: 4<br>LOB: 1<br>BB: 0<br>P: 9 | R: 0<br>E: 0<br>K: 1<br>S: 6 | H: 1<br>LOB: 1<br>BB: 0<br>P: 6 | R: 0<br>E: 0<br>K: 0<br>S: 3 | H: 0<br>LOB: 0<br>BB: 0<br>P: 3 | R: 0<br>E: 0<br>K: 0<br>S: 4 | H: 1<br>LOB: 1<br>BB: 0<br>P: 4 | R: 0<br>E: 0<br>K: 1<br>S: 5 | H: 0<br>LOB: 0<br>BB: 0<br>P: 5 | R: 0<br>E: 0<br>K: 0<br>S: 3 | H: 0<br>LOB: 1<br>BB: 1<br>P: 7 | R: 2<br>E: 1<br>K: 1<br>S: 7 | H: 1<br>LOB: 1<br>BB: 1<br>P: 11 | R: 0<br>E: 0<br>K: 0<br>S: 3 | H: 0<br>LOB: 1<br>BB: 1<br>P: 7 | R: 0<br>E: 0<br>K: 2<br>S: 7 | H: 0<br>LOB: 2<br>BB: 2<br>P: 15 | 1B: 4<br>2B: 3<br>3B: 0<br>HR: 0 | SF: 1<br>SAC: 0<br>DP: 0<br>HBP: 0 | WP: 2<br>PB: 0<br>SB: 1<br>CS: 0 | PA: 40 |
| <b>PITCHER</b>                                     | IP WLS BF H R ER SO BB IBB HBP BLK WP HR S P ERA WHIP |                                 |                              |                                 |                              |                                 |                              |                                 |                              |                                 |                              |                                 |                              |                                  |                              |                                 |                              |                                  |                                  |                                    |                                  |        |
| Diego Segui, R (1, 1)<br>ERA: 4.08                 | 0.2 L 6 4 3 3 1 0 0 0 0 0 0 0 8 8 40.50 6.000         |                                 |                              |                                 |                              |                                 |                              |                                 |                              |                                 |                              |                                 |                              |                                  |                              |                                 |                              |                                  |                                  |                                    |                                  |        |
| Ted Bowsfield, L (1, 1)<br>ERA: 4.08               | 4.1 15 2 0 0 2 0 0 0 0 0 0 0 19 19 0.00 0.462         |                                 |                              |                                 |                              |                                 |                              |                                 |                              |                                 |                              |                                 |                              |                                  |                              |                                 |                              |                                  |                                  |                                    |                                  |        |
| Ken Sanders, R (6, 1)<br>ERA: 2.25                 | 1.1 8 1 2 1 1 2 0 0 0 0 0 0 8 16 6.75 2.250           |                                 |                              |                                 |                              |                                 |                              |                                 |                              |                                 |                              |                                 |                              |                                  |                              |                                 |                              |                                  |                                  |                                    |                                  |        |
| John Wyatt, R (7, 1)<br>ERA: 3.77                  | 0.2 2 0 0 0 0 0 0 0 0 0 2 0 2 2 0.00 0.000            |                                 |                              |                                 |                              |                                 |                              |                                 |                              |                                 |                              |                                 |                              |                                  |                              |                                 |                              |                                  |                                  |                                    |                                  |        |
| Bob Meyer, L (8, 1)<br>ERA: 4.7                    | 2.0 9 0 0 0 2 3 0 0 0 0 0 0 10 22 0.00 1.500          |                                 |                              |                                 |                              |                                 |                              |                                 |                              |                                 |                              |                                 |                              |                                  |                              |                                 |                              |                                  |                                  |                                    |                                  |        |

**Detroit Tigers @ Kansas City Athletics**  
 Municipal Stadium, Kansas City, MO  
 Sat Aug 15 1964, 8:05 PM EDT  
 Att. 6,821 - Unknown

[livebaseballscorecards.com](http://livebaseballscorecards.com)

**AB** 34  
**R** 5  
**H** 7  
**RBI** 4  
**BB** 5  
**SO** 6  
**LOB** 16



| Batter  | 1  | 2  | 3      | 4 | 5  | 6     | 7 | 8     | 9 | AB | R | H | RBI | BB | SO | LOB |
|---|----|----|--------|---|----|-------|---|-------|---|----|---|---|-----|----|----|-----|
| Dick Green, R<br>OBP: 0.299, SLG: 0.393 (1, 4)      | F8 |    | G6-4-3 |   | F8 |       |   | F3    |   | 4  | 0 | 0 | 0   | 0  | 0  | 2   |
| Wayne Causey, L<br>OBP: 0.375, SLG: 0.379 (1, 5)    | F7 |    | F6     |   |    | K     |   | E8    |   | 4  | 0 | 0 | 0   | 0  | 1  | 0   |
| Manny Jimenez, L<br>OBP: 0.297, SLG: 0.483 (1, 7)   | F7 |    |        |   |    | L9    |   | F3    |   | 4  | 0 | 0 | 0   | 0  | 1  | 1   |
| Rocky Colavito, R<br>OBP: 0.361, SLG: 0.536 (1, 9)  |    | HR |        |   |    | K     |   | FC6-4 |   | 3  | 1 | 1 | 1   | 1  | 1  | 1   |
| Jim Gentile, L<br>OBP: 0.379, SLG: 0.464 (1, 3)     |    | G3 |        |   |    | FC4-6 |   | K     |   | 4  | 0 | 1 | 0   | 0  | 1  | 1   |
| Doc Edwards, R<br>OBP: 0.248, SLG: 0.279 (1, 2)     |    | E6 |        |   |    | FC6-4 |   | L6    |   | 4  | 0 | 0 | 0   | 0  | 1  | 2   |
| Bert Campaneris, R<br>OBP: 0.318, SLG: 0.469 (1, 6) |    |    |        |   |    |       |   | K     |   | 4  | 0 | 0 | 0   | 0  | 2  | 2   |
| Nelson Mathews, R<br>OBP: 0.298, SLG: 0.363 (1, 8)  |    |    |        |   |    |       |   | K     |   | 2  | 0 | 1 | 0   | 1  | 1  | 1   |
| Diego Segui, R<br>OBP: 0.252, SLG: 0.246 (1, 1)     |    |    |        |   |    |       |   |       |   | 0  | 0 | 0 | 0   | 0  | 0  | 0   |
| Ted Bowsfield, R<br>OBP: 0.174, SLG: 0.095 (1, 1)   |    |    |        |   |    |       |   |       |   | 0  | 0 | 0 | 0   | 1  | 0  | 0   |
| George Alusik, R<br>OBP: 0.352, SLG: 0.366 (5, PH)  |    |    |        |   |    |       |   |       |   | 1  | 0 | 0 | 0   | 0  | 0  | 1   |
| Ken Sanders, R (8, 1)                               |    |    |        |   |    |       |   |       |   | 0  | 0 | 0 | 0   | 0  | 0  | 0   |
| John Wyatt, R (7, 1)                                |    |    |        |   |    |       |   |       |   | 0  | 0 | 0 | 0   | 0  | 0  | 0   |
| Ken Harrelson, R<br>OBP: 0.249, SLG: 0.359 (7, PH)  |    |    |        |   |    |       |   |       |   | 1  | 0 | 0 | 0   | 0  | 0  | 2   |
| Bob Meyer, R (8, 1)                                 |    |    |        |   |    |       |   |       |   | 0  | 0 | 0 | 0   | 0  | 0  | 0   |

| Inning Stats | R: 0 | H: 0 | E: 0 | K: 0 | S: 3 | R: 1 | H: 1 | E: 1 | K: 2 | S: 9 | R: 0 | H: 0 | E: 0 | K: 1 | S: 2 | R: 0 | H: 0 | E: 0 | K: 1 | S: 5 | R: 0 | H: 1 | E: 0 | K: 0 | S: 4 | R: 0 | H: 0 | E: 0 | K: 2 | S: 7 | R: 0 | H: 1 | E: 1 | K: 1 | S: 6 | R: 0 | H: 0 | E: 1 | K: 0 | S: 4 | R: 0 | H: 0 | E: 0 | K: 2 | S: 7 | R: 0 | H: 0 | E: 0 | K: 2 | S: 7 | 1B: 2 | SF: 0 | 2B: 0 | SAC: 0 | 3B: 0 | DP: 1 | HR: 1 | HBP: 0 | WP: 0 | PA: 34 |
|--------------|------|------|------|------|------|------|------|------|------|------|------|------|------|------|------|------|------|------|------|------|------|------|------|------|------|------|------|------|------|------|------|------|------|------|------|------|------|------|------|------|------|------|------|------|------|------|------|------|------|------|-------|-------|-------|--------|-------|-------|-------|--------|-------|--------|
|--------------|------|------|------|------|------|------|------|------|------|------|------|------|------|------|------|------|------|------|------|------|------|------|------|------|------|------|------|------|------|------|------|------|------|------|------|------|------|------|------|------|------|------|------|------|------|------|------|------|------|------|-------|-------|-------|--------|-------|-------|-------|--------|-------|--------|

| PITCHER                             | IP  | WLS | BF | H | R | ER | SO | BB | IBB | HBP | BLK | WP | HR | S  | P  | ERA  | WHIP  |
|-------------------------------------|-----|-----|----|---|---|----|----|----|-----|-----|-----|----|----|----|----|------|-------|
| Denny McLain, R<br>ERA: 3.58 (1, 1) | 9.0 | W   | 34 | 3 | 1 | 1  | 8  | 3  | 0   | 0   | 0   | 0  | 1  | 47 | 59 | 1.00 | 0.667 |

**DETROIT TIGERS @ KANSAS CITY ATHLETICS**  
Municipal Stadium, Kansas City, MO  
Sat Aug 15 1964, 8:05 PM EDT  
Att. 6,821 - Unknown

|            |           |
|------------|-----------|
| <b>AB</b>  | <b>31</b> |
| <b>R</b>   | <b>1</b>  |
| <b>H</b>   | <b>3</b>  |
| <b>RBI</b> | <b>1</b>  |
| <b>BB</b>  | <b>3</b>  |
| <b>SO</b>  | <b>8</b>  |
| <b>LOB</b> | <b>13</b> |



| Batter  | 1   | 2                               | 3                              | 4                               | 5                             | 6                                | 7                                   | 8                               | 9                            | AB R H RBI BB SO LOB            | TOP                          |                                 |                              |                                 |                              |                                 |                              |                                 |                                  |                                    |                                  |   |
|---|---|---------------------------------|--------------------------------|---------------------------------|-------------------------------|----------------------------------|-------------------------------------|---------------------------------|------------------------------|---------------------------------|------------------------------|---------------------------------|------------------------------|---------------------------------|------------------------------|---------------------------------|------------------------------|---------------------------------|----------------------------------|------------------------------------|----------------------------------|---|
| George Thomas, R (1, 8)<br>OBP: 0.319, SLG: 0.469   | 0-0<br>F9   |                                 | 0-0<br>E<br>L5-4-3<br>2B<br>1B | 0-0<br>F4                       |                               | 0-3<br>K                         | 0-0<br>HR                           |                                 | 0-0<br>F8                    | 6 2 2 2 0 1 0                   |                              |                                 |                              |                                 |                              |                                 |                              |                                 |                                  |                                    |                                  |   |
| Jerry Lumpe, L (1, 4)<br>OBP: 0.307, SLG: 0.321     | 0-0<br>BB<br>1B   |                                 | 0-0<br>E3<br>L5-4-3<br>1-2     | 0-0<br>4-3                      |                               | 0-0<br>FC5-4<br>1B               | 0-0<br>F9                           |                                 |                              | 5 0 2 0 0 0 1                   |                              |                                 |                              |                                 |                              |                                 |                              |                                 |                                  |                                    |                                  |   |
| Al Kaline, R (1, 9)<br>OBP: 0.382, SLG: 0.470       | 4-0<br>BB<br>1-2<br>BB  |                                 | 0-0<br>L5-4-3<br>1-2<br>2-3    | 0-0<br>1B                       |                               | 0-0<br>FC5-4<br>1-2f             |                                     | 0-0<br>L9                       |                              | 4 0 1 0 1 0 3                   |                              |                                 |                              |                                 |                              |                                 |                              |                                 |                                  |                                    |                                  |   |
| Don Demeter, R (1, 3)<br>OBP: 0.283, SLG: 0.426     | 0-0<br>F8   |                                 | 0-0<br>E<br>3-H<br>2B          | 0-3<br>K                        |                               | 0-3<br>K                         |                                     | 0-0<br>F2                       |                              | 5 1 1 1 0 2 4                   |                              |                                 |                              |                                 |                              |                                 |                              |                                 |                                  |                                    |                                  |   |
| Bill Freehan, R (1, 2)<br>OBP: 0.358, SLG: 0.469    | 0-0<br>6-3  |                                 | 0-0<br>E9<br>HR<br>2-H<br>1B   |                                 | 0-0<br>E4<br>2B               |                                  | 0-0<br>E<br>1B<br>2B                | 0-0<br>1B<br>2B                 |                              | 5 4 3 1 0 0 2                   |                              |                                 |                              |                                 |                              |                                 |                              |                                 |                                  |                                    |                                  |   |
| Gates Brown, L (1, 7)<br>OBP: 0.324, SLG: 0.509     |   | 0-0<br>F5                       | 4-0<br>HR<br>BB                |                                 | 0-0<br>SH3<br>1-H<br>2B       |                                  | 0-0<br>E8<br>1B<br>SF7<br>2-3       | 0-0<br>WP<br>1B<br>2-H          |                              | 4 2 2 2 1 0 1                   |                              |                                 |                              |                                 |                              |                                 |                              |                                 |                                  |                                    |                                  |   |
| Don Wert, R (1, 5)<br>OBP: 0.324, SLG: 0.361        |   | 0-0<br>E5<br>1B                 | 0-0<br>HR<br>1-H<br>2-H        |                                 | 0-0<br>SH3<br>2-3             |                                  | 0-0<br>G3<br>HR<br>1B<br>1-3<br>3-H | 0-3<br>K<br>1-2                 |                              | 4 2 2 4 0 1 1                   |                              |                                 |                              |                                 |                              |                                 |                              |                                 |                                  |                                    |                                  |   |
| Dick McAuliffe, L (1, 6)<br>OBP: 0.341, SLG: 0.465  |   | 0-0<br>G1-6-3<br>1-2<br>1B      | 0-0<br>1B                      |                                 | 4-0<br>G6-3<br>BB             |                                  | 0-0<br>G3<br>1-2                    |                                 | 0-0<br>F6                    | 4 0 2 0 1 0 2                   |                              |                                 |                              |                                 |                              |                                 |                              |                                 |                                  |                                    |                                  |   |
| Dave Wickersham, R (1, 1)<br>OBP: 0.109, SLG: 0.098 |   | 0-0<br>G1-6-3<br>1-2f           | 0-3<br>K                       |                                 | 0-0<br>G6-3<br>1-2f           |                                  | 0-0<br>SF7<br>3-H                   |                                 | 0-3<br>K                     | 4 0 0 1 0 2 5                   |                              |                                 |                              |                                 |                              |                                 |                              |                                 |                                  |                                    |                                  |   |
| <b>Inning Stats</b>                                 | R: 0<br>E: 0<br>K: 0<br>S: 4  | H: 1<br>LOB: 2<br>BB: 1<br>P: 8 | R: 0<br>E: 1<br>K: 0<br>S: 4   | H: 1<br>LOB: 1<br>BB: 0<br>P: 4 | R: 5<br>E: 2<br>K: 1<br>S: 10 | H: 5<br>LOB: 1<br>BB: 1<br>P: 14 | R: 0<br>E: 0<br>K: 1<br>S: 6        | H: 1<br>LOB: 1<br>BB: 0<br>P: 6 | R: 1<br>E: 1<br>K: 0<br>S: 4 | H: 1<br>LOB: 1<br>BB: 1<br>P: 8 | R: 0<br>E: 0<br>K: 2<br>S: 8 | H: 1<br>LOB: 1<br>BB: 0<br>P: 8 | R: 4<br>E: 1<br>K: 0<br>S: 7 | H: 3<br>LOB: 0<br>BB: 0<br>P: 7 | R: 1<br>E: 0<br>K: 1<br>S: 7 | H: 2<br>LOB: 1<br>BB: 0<br>P: 7 | R: 0<br>E: 0<br>K: 1<br>S: 5 | H: 0<br>LOB: 0<br>BB: 0<br>P: 5 | 1B: 9<br>2B: 4<br>3B: 0<br>HR: 2 | SF: 1<br>SAC: 1<br>DP: 3<br>HBP: 0 | WP: 1<br>PB: 0<br>SB: 0<br>CS: 0 | PA: 46  |
| <b>PITCHER</b>                                      | IP<br>WLS<br>BF<br>H<br>R<br>ER<br>SO<br>BB<br>IBB<br>HBP<br>BLK<br>WP<br>HR<br>S<br>P<br>ERA<br>WHIP |                                 |                                |                                 |                               |                                  |                                     |                                 |                              |                                 |                              |                                 |                              |                                 |                              |                                 |                              |                                 |                                  |                                    | <b>PITCHER</b>                   | IP<br>WLS<br>BF<br>H<br>R<br>ER<br>SO<br>BB<br>IBB<br>HBP<br>BLK<br>WP<br>HR<br>S<br>P<br>ERA<br>WHIP |
| John O'Donoghue, L (1, 1)<br>ERA: 4.52              | 3.0<br>L<br>18<br>7<br>5<br>5<br>1<br>2<br>0<br>0<br>0<br>0<br>1<br>18<br>26<br>15.00<br>3.000        |                                 |                                |                                 |                               |                                  |                                     |                                 |                              |                                 |                              |                                 |                              |                                 |                              |                                 |                              |                                 |                                  |                                    |                                  |   |
| Moe Drabowsky, R (4, 1)<br>ERA: 5.67                | 2.0<br>9<br>2<br>1<br>0<br>1<br>1<br>1<br>0<br>0<br>0<br>0<br>0<br>10<br>14<br>0.00<br>1.500          |                                 |                                |                                 |                               |                                  |                                     |                                 |                              |                                 |                              |                                 |                              |                                 |                              |                                 |                              |                                 |                                  |                                    |                                  |   |
| Bob Meyer, L (6, 1)<br>ERA: 4.46                    | 2.0<br>11<br>4<br>4<br>0<br>2<br>0<br>0<br>0<br>0<br>0<br>0<br>1<br>15<br>15<br>0.00<br>2.000         |                                 |                                |                                 |                               |                                  |                                     |                                 |                              |                                 |                              |                                 |                              |                                 |                              |                                 |                              |                                 |                                  |                                    |                                  |   |
| John Wyatt, R (8, 1)<br>ERA: 3.79                   | 2.0<br>8<br>2<br>1<br>1<br>2<br>0<br>0<br>0<br>0<br>0<br>1<br>0<br>12<br>12<br>4.50<br>1.000          |                                 |                                |                                 |                               |                                  |                                     |                                 |                              |                                 |                              |                                 |                              |                                 |                              |                                 |                              |                                 |                                  |                                    |                                  |   |

**Detroit Tigers @ Kansas City Athletics**  
 Municipal Stadium, Kansas City, MO  
 Sun Aug 16 1964, 4:33 AM EDT  
 Att. 9,174 - Unknown

[livebaseballscorecards.com](http://livebaseballscorecards.com)

**AB** 41  
**R** 11  
**H** 15  
**RBI** 11  
**BB** 3  
**SO** 6  
**LOB** 19



| Batter  | 1       | 2       | 3       | 4       | 5            | 6       | 7       | 8                | 9       | AB | R | H | RBI | BB | SO | LOB |
|---|---------|---------|---------|---------|--------------|---------|---------|------------------|---------|----|---|---|-----|----|----|-----|
| Dick Green, R (1, 4)<br>OBP: 0.298, SLG: 0.390      | 0-0 1-3 |         | 0-0 4-3 |         | 0-0 1B       |         | 0-0 6-3 |                  | 0-0 L9  | 5  | 0 | 1 | 0   | 0  | 0  | 0   |
| Wayne Causey, L (1, 5)<br>OBP: 0.374, SLG: 0.378    | 0-0 L9  |         | 0-0 F8  |         | 0-0 1B       |         | 0-0 G3  |                  |         | 4  | 0 | 1 | 1   | 0  | 0  | 0   |
| Manny Jimenez, L (1, 7)<br>OBP: 0.296, SLG: 0.475   | 0-0 L9  |         |         | 0-0 3-1 | 0-0 1-3      |         |         | 1-0 FC6-4<br>HBP |         | 3  | 0 | 0 | 0   | 0  | 0  | 2   |
| Rocky Colavito, R (1, 9)<br>OBP: 0.360, SLG: 0.540  |         | 0-0 F8  |         | 0-0 1-3 |              | 0-0 HR  |         | 0-0 FC6-4<br>HR  |         | 4  | 2 | 1 | 1   | 0  | 0  | 1   |
| Jim Gentile, L (1, 3)<br>OBP: 0.383, SLG: 0.486     |         | 0-0 HR  |         | 1-0 HBP |              | 0-0 F6  |         | 0-0 HR           |         | 3  | 2 | 2 | 3   | 0  | 0  | 0   |
| Doc Edwards, R (1, 2)<br>OBP: 0.247, SLG: 0.278     |         | 0-0 5-3 |         | 0-3 K   |              | 0-3 K   |         | 0-0 6-3          |         | 1  | 0 | 0 | 0   | 0  | 0  | 0   |
| Dave Duncan, R (3, 2)<br>OBP: 0.100, SLG: 0.100     |         |         |         |         |              |         |         |                  |         | 3  | 0 | 0 | 0   | 0  | 2  | 1   |
| Bert Campaneris, R (1, 6)<br>OBP: 0.326, SLG: 0.471 |         | 0-0 1B  |         |         | 0-0 L9       | 0-0 1B  |         | 0-0 F4           |         | 4  | 0 | 2 | 0   | 0  | 0  | 0   |
| Nelson Mathews, R (1, 8)<br>OBP: 0.296, SLG: 0.360  |         | 0-0 6-3 |         |         | 0-0 E5<br>1B | 0-0 4-3 |         |                  | 0-0 1-3 | 4  | 1 | 0 | 0   | 0  | 0  | 2   |
| John O'Donoghue, R (1, 1)<br>OBP: 0.200, SLG: 0.275 |         |         | 0-0 5-3 |         | 0-0 F5       |         | 0-0 F3  |                  | 0-0 5-3 | 0  | 0 | 0 | 0   | 0  | 0  | 0   |
| George Alusk, R (3, PH)<br>OBP: 0.350, SLG: 0.364   |         |         |         |         |              |         |         |                  |         | 1  | 0 | 0 | 0   | 0  | 0  | 0   |
| Moe Drabowsky, R (4, 1)<br>OBP: 0.026, SLG: 0.026   |         |         |         |         |              |         |         |                  |         | 0  | 0 | 0 | 0   | 0  | 0  | 0   |
| Jose Tartabull, L (5, PH)<br>OBP: 0.241, SLG: 0.247 |         |         |         |         |              |         |         |                  |         | 1  | 0 | 0 | 0   | 0  | 0  | 1   |
| Bob Meyer, R (6, 1)                                 |         |         |         |         |              |         |         |                  |         | 0  | 0 | 0 | 0   | 0  | 0  | 0   |
| Ed Charles, R (7, PH)<br>OBP: 0.327, SLG: 0.380     |         |         |         |         |              |         |         |                  |         | 1  | 0 | 0 | 0   | 0  | 0  | 0   |
| John Wyatt, R (8, 1)                                |         |         |         |         |              |         |         |                  |         | 0  | 0 | 0 | 0   | 0  | 0  | 0   |
| Ken Harrelson, R (9, PH)<br>OBP: 0.237, SLG: 0.355  |         |         |         |         |              |         |         |                  |         | 1  | 0 | 0 | 0   | 0  | 0  | 0   |

| Inning Stats | R: 0 | H: 0 | E: 0 | K: 0 | S: 3 | R: 1 | H: 2 | E: 0 | K: 0 | S: 5 | R: 0 | H: 0 | E: 0 | K: 1 | S: 5 | R: 0 | H: 0 | E: 0 | K: 0 | S: 3 | R: 1 | H: 2 | E: 1 | K: 0 | S: 6 | R: 1 | H: 2 | E: 0 | K: 1 | S: 7 | R: 0 | H: 0 | E: 0 | K: 0 | S: 3 | R: 2 | H: 1 | E: 0 | K: 0 | S: 4 | R: 0 | H: 0 | E: 0 | K: 0 | S: 3 | R: 0 | H: 0 | E: 0 | K: 0 | S: 3 | 1B: 4 | 2B: 0 | 3B: 0 | HR: 3 | SF: 0 | SAC: 0 | DP: 0 | HBP: 2 | WP: 0 | PA: 37 |
|--------------|------|------|------|------|------|------|------|------|------|------|------|------|------|------|------|------|------|------|------|------|------|------|------|------|------|------|------|------|------|------|------|------|------|------|------|------|------|------|------|------|------|------|------|------|------|------|------|------|------|------|-------|-------|-------|-------|-------|--------|-------|--------|-------|--------|
|--------------|------|------|------|------|------|------|------|------|------|------|------|------|------|------|------|------|------|------|------|------|------|------|------|------|------|------|------|------|------|------|------|------|------|------|------|------|------|------|------|------|------|------|------|------|------|------|------|------|------|------|-------|-------|-------|-------|-------|--------|-------|--------|-------|--------|

| PITCHER                                | IP  | WLS | BF | H | R | ER | SO | BB | IBB | HBP | BLK | WP | HR | S  | P  | ERA  | WHIP  |
|--|-----|-----|----|---|---|----|----|----|-----|-----|-----|----|----|----|----|------|-------|
| Dave Wickersham, R (1, 1)<br>ERA: 3.74 | 9.0 | W   | 37 | 7 | 5 | 4  | 2  | 0  | 0   | 2   | 0   | 0  | 3  | 39 | 41 | 4.00 | 0.778 |

BOTTOM

**Detroit Tigers @ Kansas City Athletics**  
Municipal Stadium, Kansas City, MO  
Sun Aug 16 1964, 4:33 AM EDT  
Att. 9,174 - Unknown

livebaseballscores.com

|     |    |
|-----|----|
| AB  | 35 |
| R   | 5  |
| H   | 7  |
| RBI | 5  |
| BB  | 0  |
| SO  | 2  |
| LOB | 7  |



| Batter   | 1   | 2   | 3                            | 4                               | 5                            | 6                               | 7                            | 8                               | 9                            | AB R H RBI BB SO LOB   | TOP   |                                  |                              |                                  |                               |                                  |                              |                                 |                                  |                                    |                                     |        |  |    |   |   |   |   |   |   |   |   |   |   |    |    |       |       |                                  |     |  |    |   |   |   |   |   |   |   |   |   |   |   |    |       |       |                                     |     |   |   |   |   |   |   |   |   |   |   |   |   |   |    |       |       |                                    |     |  |   |   |   |   |   |   |   |   |   |   |   |   |    |       |       |                                   |     |  |   |   |   |   |   |   |   |   |   |   |   |   |   |      |       |   |                                     |     |  |   |   |   |   |   |   |   |   |   |   |   |   |   |      |       |
|--|---|---|------------------------------|---------------------------------|------------------------------|---------------------------------|------------------------------|---------------------------------|------------------------------|--|---|----------------------------------|------------------------------|----------------------------------|-------------------------------|----------------------------------|------------------------------|---------------------------------|----------------------------------|------------------------------------|-------------------------------------|--------|--|----|---|---|---|---|---|---|---|---|---|---|----|----|-------|-------|----------------------------------|-----|--|----|---|---|---|---|---|---|---|---|---|---|---|----|-------|-------|-------------------------------------|-----|---|---|---|---|---|---|---|---|---|---|---|---|---|----|-------|-------|------------------------------------|-----|--|---|---|---|---|---|---|---|---|---|---|---|---|----|-------|-------|-----------------------------------|-----|--|---|---|---|---|---|---|---|---|---|---|---|---|---|------|-------|---|-------------------------------------|-----|--|---|---|---|---|---|---|---|---|---|---|---|---|---|------|-------|
| Dick Green, R (1, 4)<br>OBP: 0.298, SLG: 0.387   | 0-3<br>K  |   | 0-0<br>1B 3B 1B              | 0-0<br>FC4-6                    |                              | 4-0<br>G4-6-3                   | 0-0<br>F8                    |                                 | 0-3<br>K                     | 5 1 1 0 1 2 2  | <b>Kansas City Athletics @ Cleveland Indians</b><br>Cleveland Municipal Stadium, Cleveland, OH<br>Tue Aug 18 1964, 7:05 PM EDT<br>Unknown |                                  |                              |                                  |                               |                                  |                              |                                 |                                  |                                    |                                     |        |  |    |   |   |   |   |   |   |   |   |   |   |    |    |       |       |                                  |     |  |    |   |   |   |   |   |   |   |   |   |   |   |    |       |       |                                     |     |   |   |   |   |   |   |   |   |   |   |   |   |   |    |       |       |                                    |     |  |   |   |   |   |   |   |   |   |   |   |   |   |    |       |       |                                   |     |  |   |   |   |   |   |   |   |   |   |   |   |   |   |      |       |   |                                     |     |  |   |   |   |   |   |   |   |   |   |   |   |   |   |      |       |
| Wayne Causey, L (1, 5)<br>OBP: 0.377, SLG: 0.387   | 0-0<br>2B   |   | 0-0<br>1B 3B 1B              | 0-0<br>G4-6-3                   |                              | 0-0<br>G4-6-3                   |                              | 0-0<br>FC1-6                    | 0-0<br>2B                    | 6 1 4 0 0 0 3  |   |                                  |                              |                                  |                               |                                  |                              |                                 |                                  |                                    |                                     |        |  |    |   |   |   |   |   |   |   |   |   |   |    |    |       |       |                                  |     |  |    |   |   |   |   |   |   |   |   |   |   |   |    |       |       |                                     |     |   |   |   |   |   |   |   |   |   |   |   |   |   |    |       |       |                                    |     |  |   |   |   |   |   |   |   |   |   |   |   |   |    |       |       |                                   |     |  |   |   |   |   |   |   |   |   |   |   |   |   |   |      |       |   |                                     |     |  |   |   |   |   |   |   |   |   |   |   |   |   |   |      |       |
| Ken Harrelson, R (1, 7)<br>OBP: 0.243, SLG: 0.347  | 0-0<br>F7   |   | 0-0<br>1B 3B 1B              |                                 | 0-0<br>F7                    | 0-3<br>K                        |                              | 0-0<br>FC1-6                    | 4-0<br>F8-4                  | 5 2 1 0 1 1 3  |   |                                  |                              |                                  |                               |                                  |                              |                                 |                                  |                                    |                                     |        |  |    |   |   |   |   |   |   |   |   |   |   |    |    |       |       |                                  |     |  |    |   |   |   |   |   |   |   |   |   |   |   |    |       |       |                                     |     |   |   |   |   |   |   |   |   |   |   |   |   |   |    |       |       |                                    |     |  |   |   |   |   |   |   |   |   |   |   |   |   |    |       |       |                                   |     |  |   |   |   |   |   |   |   |   |   |   |   |   |   |      |       |   |                                     |     |  |   |   |   |   |   |   |   |   |   |   |   |   |   |      |       |
| Rocky Colavito, R (1, 9)<br>OBP: 0.363, SLG: 0.547   | 0-0<br>F9   |   | 0-0<br>4-3                   |                                 | 4-0<br>HR                    |                                 | 4-0<br>1B 1B                 | 0-0<br>1B                       | 0-0<br>F8-4                  | 4 4 2 3 2 0 3  |   |                                  |                              |                                  |                               |                                  |                              |                                 |                                  |                                    |                                     |        |  |    |   |   |   |   |   |   |   |   |   |   |    |    |       |       |                                  |     |  |    |   |   |   |   |   |   |   |   |   |   |   |    |       |       |                                     |     |   |   |   |   |   |   |   |   |   |   |   |   |   |    |       |       |                                    |     |  |   |   |   |   |   |   |   |   |   |   |   |   |    |       |       |                                   |     |  |   |   |   |   |   |   |   |   |   |   |   |   |   |      |       |   |                                     |     |  |   |   |   |   |   |   |   |   |   |   |   |   |   |      |       |
| Jim Gentile, L (1, 3)<br>OBP: 0.386, SLG: 0.497  |   | 0-0<br>F8   | 0-0<br>4-3                   |                                 | 0-0<br>HR                    |                                 | 0-0<br>1B 1B                 | 4-0<br>1B                       |                              | 4 3 2 3 1 0 0  |   |                                  |                              |                                  |                               |                                  |                              |                                 |                                  |                                    |                                     |        |  |    |   |   |   |   |   |   |   |   |   |   |    |    |       |       |                                  |     |  |    |   |   |   |   |   |   |   |   |   |   |   |    |       |       |                                     |     |   |   |   |   |   |   |   |   |   |   |   |   |   |    |       |       |                                    |     |  |   |   |   |   |   |   |   |   |   |   |   |   |    |       |       |                                   |     |  |   |   |   |   |   |   |   |   |   |   |   |   |   |      |       |   |                                     |     |  |   |   |   |   |   |   |   |   |   |   |   |   |   |      |       |
| Doc Edwards, R (1, 2)<br>OBP: 0.244, SLG: 0.274  |   | 0-0<br>F7   | 0-0<br>1-3                   |                                 | 0-0<br>5-3                   |                                 | 0-0<br>L6-3                  | 0-3<br>K                        |                              | 3 0 0 0 0 0 0  |   |                                  |                              |                                  |                               |                                  |                              |                                 |                                  |                                    |                                     |        |  |    |   |   |   |   |   |   |   |   |   |   |    |    |       |       |                                  |     |  |    |   |   |   |   |   |   |   |   |   |   |   |    |       |       |                                     |     |   |   |   |   |   |   |   |   |   |   |   |   |   |    |       |       |                                    |     |  |   |   |   |   |   |   |   |   |   |   |   |   |    |       |       |                                   |     |  |   |   |   |   |   |   |   |   |   |   |   |   |   |      |       |   |                                     |     |  |   |   |   |   |   |   |   |   |   |   |   |   |   |      |       |
| Billy Bryan, L (7, PH)<br>OBP: 0.288, SLG: 0.484   |   |   |                              |                                 |                              |                                 | 1-2<br>3-H                   |                                 |                              | 2 0 1 1 0 1 3  |   |                                  |                              |                                  |                               |                                  |                              |                                 |                                  |                                    |                                     |        |  |    |   |   |   |   |   |   |   |   |   |   |    |    |       |       |                                  |     |  |    |   |   |   |   |   |   |   |   |   |   |   |    |       |       |                                     |     |   |   |   |   |   |   |   |   |   |   |   |   |   |    |       |       |                                    |     |  |   |   |   |   |   |   |   |   |   |   |   |   |    |       |       |                                   |     |  |   |   |   |   |   |   |   |   |   |   |   |   |   |      |       |   |                                     |     |  |   |   |   |   |   |   |   |   |   |   |   |   |   |      |       |
| Bert Campaneris, R (1, 6)<br>OBP: 0.330, SLG: 0.461  |   | 4-0<br>2B   | 0-0<br>E6                    |                                 | 0-0<br>G3                    |                                 | 0-0<br>L6-3                  | 0-0<br>2B                       |                              | 4 0 1 2 1 0 2  |   |                                  |                              |                                  |                               |                                  |                              |                                 |                                  |                                    |                                     |        |  |    |   |   |   |   |   |   |   |   |   |   |    |    |       |       |                                  |     |  |    |   |   |   |   |   |   |   |   |   |   |   |    |       |       |                                     |     |   |   |   |   |   |   |   |   |   |   |   |   |   |    |       |       |                                    |     |  |   |   |   |   |   |   |   |   |   |   |   |   |    |       |       |                                   |     |  |   |   |   |   |   |   |   |   |   |   |   |   |   |      |       |   |                                     |     |  |   |   |   |   |   |   |   |   |   |   |   |   |   |      |       |
| Nelson Mathews, R (1, 8)<br>OBP: 0.301, SLG: 0.368   |   | 0-0<br>2B   | 0-0<br>5-3                   |                                 |                              | 0-0<br>BB                       | 4-0<br>1B                    | 0-0<br>1B                       | 0-0<br>2B                    | 4 2 3 1 1 0 1  |   |                                  |                              |                                  |                               |                                  |                              |                                 |                                  |                                    |                                     |        |  |    |   |   |   |   |   |   |   |   |   |   |    |    |       |       |                                  |     |  |    |   |   |   |   |   |   |   |   |   |   |   |    |       |       |                                     |     |   |   |   |   |   |   |   |   |   |   |   |   |   |    |       |       |                                    |     |  |   |   |   |   |   |   |   |   |   |   |   |   |    |       |       |                                   |     |  |   |   |   |   |   |   |   |   |   |   |   |   |   |      |       |   |                                     |     |  |   |   |   |   |   |   |   |   |   |   |   |   |   |      |       |
| Jose Santiago, R<br>Ted Bowfield, R<br>George Alusk, R<br>Moe Drabowsky, R<br>Jose Hernandez, L<br>Wes Stipp, R<br>Manny Jimenez, L<br>Bob Meyer, R<br>John Wyatt, R |   | 0-0<br>5-3  |                              | 4-0<br>FC4-6                    |                              | 4-0<br>G4-6-3                   | 0-0<br>1B                    | 0-0<br>1B                       | 0-3<br>K                     | 1 0 0 0 0 0 0 2<br>0 0 0 0 0 1 0 0<br>0 0 0 0 0 0 0 0<br>0 0 0 0 0 0 0 0<br>0 0 0 0 0 0 0 0<br>1 0 0 1 2 0 0 0<br>0 0 0 0 0 0 0 0<br>1 0 0 0 0 0 1 2 |   |                                  |                              |                                  |                               |                                  |                              |                                 |                                  |                                    |                                     |        |  |    |   |   |   |   |   |   |   |   |   |   |    |    |       |       |                                  |     |  |    |   |   |   |   |   |   |   |   |   |   |   |    |       |       |                                     |     |   |   |   |   |   |   |   |   |   |   |   |   |   |    |       |       |                                    |     |  |   |   |   |   |   |   |   |   |   |   |   |   |    |       |       |                                   |     |  |   |   |   |   |   |   |   |   |   |   |   |   |   |      |       |   |                                     |     |  |   |   |   |   |   |   |   |   |   |   |   |   |   |      |       |
| <b>Inning Stats</b>  | R: 0<br>E: 0<br>K: 1<br>S: 6                          | H: 1<br>LOB: 1<br>BB: 0<br>P: 6   | R: 0<br>E: 0<br>K: 0<br>S: 4 | H: 1<br>LOB: 2<br>BB: 1<br>P: 8 | R: 4<br>E: 1<br>K: 0<br>S: 8 | H: 4<br>LOB: 1<br>BB: 0<br>P: 8 | R: 0<br>E: 0<br>K: 0<br>S: 2 | H: 0<br>LOB: 0<br>BB: 1<br>P: 6 | R: 2<br>E: 0<br>K: 0<br>S: 4 | H: 1<br>LOB: 0<br>BB: 1<br>P: 8  | R: 1<br>E: 0<br>K: 1<br>S: 5  | H: 1<br>LOB: 1<br>BB: 2<br>P: 13 | R: 3<br>E: 0<br>K: 0<br>S: 5 | H: 3<br>LOB: 1<br>BB: 2<br>P: 13 | R: 3<br>E: 0<br>K: 2<br>S: 11 | H: 4<br>LOB: 2<br>BB: 1<br>P: 15 | R: 0<br>E: 0<br>K: 1<br>S: 5 | H: 1<br>LOB: 1<br>BB: 1<br>P: 9 | 1B: 9<br>2B: 7<br>3B: 1<br>HR: 1 | SF: 0<br>SAC: 0<br>DP: 4<br>HBP: 0 | WP: 0<br>PB: 0<br>SB: 0<br>CS: 0    | PA: 49 |  |    |   |   |   |   |   |   |   |   |   |   |    |    |       |       |                                  |     |  |    |   |   |   |   |   |   |   |   |   |   |   |    |       |       |                                     |     |   |   |   |   |   |   |   |   |   |   |   |   |   |    |       |       |                                    |     |  |   |   |   |   |   |   |   |   |   |   |   |   |    |       |       |                                   |     |  |   |   |   |   |   |   |   |   |   |   |   |   |   |      |       |   |                                     |     |  |   |   |   |   |   |   |   |   |   |   |   |   |   |      |       |
| <b>PITCHER</b>   | IP WLS BF H R ER SO BB IBB HBP BLK WP HR S P ERA WHIP | <table border="0"> <tr> <td>Jack Kralick, L (1, 1)<br/>ERA: 3.07</td> <td>3.0</td> <td></td> <td>18</td> <td>6</td> <td>4</td> <td>4</td> <td>1</td> <td>2</td> <td>0</td> <td>0</td> <td>0</td> <td>0</td> <td>0</td> <td>18</td> <td>26</td> <td>12.00</td> <td>2.667</td> </tr> <tr> <td>Gary Bell, R (4, 1)<br/>ERA: 4.26</td> <td>2.0</td> <td></td> <td>10</td> <td>2</td> <td>3</td> <td>3</td> <td>0</td> <td>3</td> <td>0</td> <td>0</td> <td>0</td> <td>0</td> <td>1</td> <td>7</td> <td>19</td> <td>13.50</td> <td>2.500</td> </tr> <tr> <td>Ted Abernathy, R (6, 1)<br/>ERA: 4.1</td> <td>1.2</td> <td>L</td> <td>8</td> <td>3</td> <td>3</td> <td>3</td> <td>1</td> <td>2</td> <td>0</td> <td>0</td> <td>0</td> <td>0</td> <td>0</td> <td>8</td> <td>16</td> <td>16.20</td> <td>3.000</td> </tr> <tr> <td>Pedro Ramos, R (7, 1)<br/>ERA: 5.01</td> <td>1.0</td> <td></td> <td>7</td> <td>3</td> <td>3</td> <td>3</td> <td>1</td> <td>0</td> <td>1</td> <td>0</td> <td>0</td> <td>0</td> <td>0</td> <td>8</td> <td>12</td> <td>27.00</td> <td>3.000</td> </tr> <tr> <td>Lee Stange, R (8, 1)<br/>ERA: 4.71</td> <td>0.1</td> <td></td> <td>2</td> <td>1</td> <td>0</td> <td>0</td> <td>1</td> <td>0</td> <td>0</td> <td>0</td> <td>0</td> <td>0</td> <td>0</td> <td>4</td> <td>4</td> <td>0.00</td> <td>3.000</td> </tr> </table> |                              |                                 |                              |                                 |                              |                                 |                              |  |   |                                  |                              |                                  |                               |                                  |                              |                                 |                                  |                                    | Jack Kralick, L (1, 1)<br>ERA: 3.07 | 3.0    |  | 18 | 6 | 4 | 4 | 1 | 2 | 0 | 0 | 0 | 0 | 0 | 18 | 26 | 12.00 | 2.667 | Gary Bell, R (4, 1)<br>ERA: 4.26 | 2.0 |  | 10 | 2 | 3 | 3 | 0 | 3 | 0 | 0 | 0 | 0 | 1 | 7 | 19 | 13.50 | 2.500 | Ted Abernathy, R (6, 1)<br>ERA: 4.1 | 1.2 | L | 8 | 3 | 3 | 3 | 1 | 2 | 0 | 0 | 0 | 0 | 0 | 8 | 16 | 16.20 | 3.000 | Pedro Ramos, R (7, 1)<br>ERA: 5.01 | 1.0 |  | 7 | 3 | 3 | 3 | 1 | 0 | 1 | 0 | 0 | 0 | 0 | 8 | 12 | 27.00 | 3.000 | Lee Stange, R (8, 1)<br>ERA: 4.71 | 0.1 |  | 2 | 1 | 0 | 0 | 1 | 0 | 0 | 0 | 0 | 0 | 0 | 4 | 4 | 0.00 | 3.000 | <table border="0"> <tr> <td>Dick Donovan, R (9, 1)<br/>ERA: 4.83</td> <td>1.0</td> <td></td> <td>4</td> <td>1</td> <td>0</td> <td>0</td> <td>1</td> <td>1</td> <td>0</td> <td>0</td> <td>0</td> <td>0</td> <td>0</td> <td>5</td> <td>9</td> <td>0.00</td> <td>2.000</td> </tr> </table> | Dick Donovan, R (9, 1)<br>ERA: 4.83 | 1.0 |  | 4 | 1 | 0 | 0 | 1 | 1 | 0 | 0 | 0 | 0 | 0 | 5 | 9 | 0.00 | 2.000 |
| Jack Kralick, L (1, 1)<br>ERA: 3.07  | 3.0   |   | 18                           | 6                               | 4                            | 4                               | 1                            | 2                               | 0                            | 0  | 0   | 0                                | 0                            | 18                               | 26                            | 12.00                            | 2.667                        |                                 |                                  |                                    |                                     |        |  |    |   |   |   |   |   |   |   |   |   |   |    |    |       |       |                                  |     |  |    |   |   |   |   |   |   |   |   |   |   |   |    |       |       |                                     |     |   |   |   |   |   |   |   |   |   |   |   |   |   |    |       |       |                                    |     |  |   |   |   |   |   |   |   |   |   |   |   |   |    |       |       |                                   |     |  |   |   |   |   |   |   |   |   |   |   |   |   |   |      |       |   |                                     |     |  |   |   |   |   |   |   |   |   |   |   |   |   |   |      |       |
| Gary Bell, R (4, 1)<br>ERA: 4.26   | 2.0   |   | 10                           | 2                               | 3                            | 3                               | 0                            | 3                               | 0                            | 0  | 0   | 0                                | 1                            | 7                                | 19                            | 13.50                            | 2.500                        |                                 |                                  |                                    |                                     |        |  |    |   |   |   |   |   |   |   |   |   |   |    |    |       |       |                                  |     |  |    |   |   |   |   |   |   |   |   |   |   |   |    |       |       |                                     |     |   |   |   |   |   |   |   |   |   |   |   |   |   |    |       |       |                                    |     |  |   |   |   |   |   |   |   |   |   |   |   |   |    |       |       |                                   |     |  |   |   |   |   |   |   |   |   |   |   |   |   |   |      |       |   |                                     |     |  |   |   |   |   |   |   |   |   |   |   |   |   |   |      |       |
| Ted Abernathy, R (6, 1)<br>ERA: 4.1  | 1.2   | L   | 8                            | 3                               | 3                            | 3                               | 1                            | 2                               | 0                            | 0  | 0   | 0                                | 0                            | 8                                | 16                            | 16.20                            | 3.000                        |                                 |                                  |                                    |                                     |        |  |    |   |   |   |   |   |   |   |   |   |   |    |    |       |       |                                  |     |  |    |   |   |   |   |   |   |   |   |   |   |   |    |       |       |                                     |     |   |   |   |   |   |   |   |   |   |   |   |   |   |    |       |       |                                    |     |  |   |   |   |   |   |   |   |   |   |   |   |   |    |       |       |                                   |     |  |   |   |   |   |   |   |   |   |   |   |   |   |   |      |       |   |                                     |     |  |   |   |   |   |   |   |   |   |   |   |   |   |   |      |       |
| Pedro Ramos, R (7, 1)<br>ERA: 5.01   | 1.0   |   | 7                            | 3                               | 3                            | 3                               | 1                            | 0                               | 1                            | 0  | 0   | 0                                | 0                            | 8                                | 12                            | 27.00                            | 3.000                        |                                 |                                  |                                    |                                     |        |  |    |   |   |   |   |   |   |   |   |   |   |    |    |       |       |                                  |     |  |    |   |   |   |   |   |   |   |   |   |   |   |    |       |       |                                     |     |   |   |   |   |   |   |   |   |   |   |   |   |   |    |       |       |                                    |     |  |   |   |   |   |   |   |   |   |   |   |   |   |    |       |       |                                   |     |  |   |   |   |   |   |   |   |   |   |   |   |   |   |      |       |   |                                     |     |  |   |   |   |   |   |   |   |   |   |   |   |   |   |      |       |
| Lee Stange, R (8, 1)<br>ERA: 4.71  | 0.1   |   | 2                            | 1                               | 0                            | 0                               | 1                            | 0                               | 0                            | 0  | 0   | 0                                | 0                            | 4                                | 4                             | 0.00                             | 3.000                        |                                 |                                  |                                    |                                     |        |  |    |   |   |   |   |   |   |   |   |   |   |    |    |       |       |                                  |     |  |    |   |   |   |   |   |   |   |   |   |   |   |    |       |       |                                     |     |   |   |   |   |   |   |   |   |   |   |   |   |   |    |       |       |                                    |     |  |   |   |   |   |   |   |   |   |   |   |   |   |    |       |       |                                   |     |  |   |   |   |   |   |   |   |   |   |   |   |   |   |      |       |   |                                     |     |  |   |   |   |   |   |   |   |   |   |   |   |   |   |      |       |
| Dick Donovan, R (9, 1)<br>ERA: 4.83  | 1.0   |   | 4                            | 1                               | 0                            | 0                               | 1                            | 1                               | 0                            | 0  | 0   | 0                                | 0                            | 5                                | 9                             | 0.00                             | 2.000                        |                                 |                                  |                                    |                                     |        |  |    |   |   |   |   |   |   |   |   |   |   |    |    |       |       |                                  |     |  |    |   |   |   |   |   |   |   |   |   |   |   |    |       |       |                                     |     |   |   |   |   |   |   |   |   |   |   |   |   |   |    |       |       |                                    |     |  |   |   |   |   |   |   |   |   |   |   |   |   |    |       |       |                                   |     |  |   |   |   |   |   |   |   |   |   |   |   |   |   |      |       |   |                                     |     |  |   |   |   |   |   |   |   |   |   |   |   |   |   |      |       |

livebaseballscorecards.com

|     |    |
|-----|----|
| AB  | 40 |
| R   | 13 |
| H   | 16 |
| RBI | 12 |
| BB  | 9  |
| SO  | 5  |
| LOB | 21 |

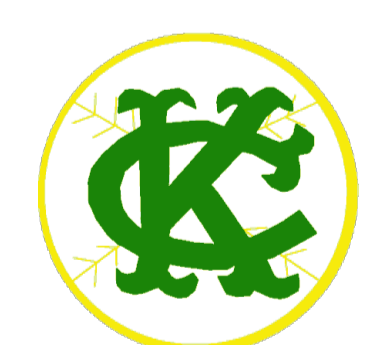

BOTTOM

Kansas City Athletics @ Cleveland Indians  
Cleveland Municipal Stadium, Cleveland, OH  
Tue Aug 18 1964, 7:05 PM EDT  
Unknown

livebaseballscorecards.com

AB 38  
R 9  
H 10  
RBI 8  
BB 3  
SO 4  
LOB 24



WP: 0 PA: 43  
PB: 0  
SB: 1  
CS: 1

AB R H RBI BB SO LOB

5 2 1 1 0 0 4

5 0 3 1 0 1 3

4 0 0 1 1 2 5

2 1 0 0 0 0 3

5 0 1 2 0 0 2

4 1 2 0 0 0 1

2 2 1 0 2 0 0

1 1 0 0 0 0 2  
1 0 0 0 0 0 2  
0 0 0 0 0 0 0  
0 0 0 0 0 0 0  
0 0 0 0 0 0 0  
1 0 0 0 0 1 0

1B: 8 SF: 0  
2B: 1 SAC: 1  
3B: 0 DP: 1  
HR: 1 HBP: 0

| Batter  | 1  | 2                              | 3                        | 4          | 5                                 | 6                     | 7          | 8               | 9 |
|---|--|--------------------------------|--------------------------|------------|-----------------------------------|-----------------------|------------|-----------------|---|
| Chico Salmon, R<br>OBP: 0.350, SLG: 0.396<br>(1, 9)   | 0-0<br>E5<br>1B<br>FC7-4                   | 0-0<br>E1<br>1B<br>1-3<br>2-H  | 0-0<br>F9                |            | 0-0<br>FC5-4<br>CS<br>1-2f<br>3-H |                       |            | 0-0<br>1B       |   |
| Dick Howser, R<br>OBP: 0.333, SLG: 0.329<br>(1, 6)  | 0-0<br>FC7-4<br>2-3<br>1B                  | 0-3<br>K<br>1-3<br>2-H<br>1B   | 0-0<br>1B                |            | 0-0<br>CS<br>1-2                  | 0-0<br>G4-6-3<br>1B   |            | 0-0<br>F4<br>1B |   |
| Bob Chance, L<br>OBP: 0.365, SLG: 0.476<br>Dick Donovan, L<br>OBP: 0.356, SLG: 0.278<br>(1, 3)<br>(9, 1)  | 0-0<br>FC7-4<br>FC6-4<br>1-2f<br>3-H<br>1B | 4-0<br>1B<br>BB                | 0-0<br>F9                |            |                                   | 0-3<br>K              |            | 0-3<br>K        |   |
| Leon Wagner, L<br>OBP: 0.323, SLG: 0.465<br>(1, 7)  | 0-0<br>FC6-4<br>E<br>S<br>2B<br>1-2f       | 0-0<br>1B<br>1-2<br>2-H<br>3-H |                          | 0-0<br>F6  |                                   | 0-0<br>G4-6-3<br>1-2f |            | 0-0<br>F4       |   |
| Max Alvis, R<br>OBP: 0.320, SLG: 0.444<br>Billy Moran, R<br>OBP: 0.287, SLG: 0.289<br>(1, 5)<br>(3, 5)  | 0-0<br>E6<br>2B<br>1-3                     | 0-0<br>F4                      |                          | 0-0<br>6-3 |                                   |                       | 0-0<br>HR  | 0-0<br>F4       |   |
| Vic Davalillo, L<br>OBP: 0.302, SLG: 0.332<br>(1, 8)  | 0-0<br>1-H<br>3-H<br>2B                    | 0-0<br>4-3                     |                          | 0-0<br>F8  |                                   |                       | 0-0<br>F8  | 0-0<br>4-3      |   |
| John Romano, R<br>OBP: 0.340, SLG: 0.452<br>(1, 2)  | 0-0<br>L5                                  |                                | 0-0<br>FC1-5<br>BB<br>1B |            | 0-0<br>FC5-6<br>BB<br>FC5-4<br>1B |                       | 0-0<br>4-3 |                 |   |
| Woodie Held, R<br>OBP: 0.310, SLG: 0.437<br>(1, 4)  |  | 0-0<br>SH<br>E<br>1B           | 4-0<br>FC1-5<br>1B<br>BB |            | 4-0<br>FC5-6<br>1-2<br>BB         |                       | 0-0<br>F9  |                 |   |
| Jack Kralick, L<br>OBP: 0.178, SLG: 0.180<br>Gary Bell, R<br>OBP: 0.412, SLG: 0.375<br>Ted Abernathy, R<br>OBP: 0.220, SLG: 0.333<br>Lee Stange, R<br>OBP: 0.170, SLG: 0.050<br>Tito Francona, L<br>OBP: 0.369, SLG: 0.362<br>(1, 1)<br>(4, 1)<br>(6, 1)<br>(7, 1)<br>(8, 1)<br>(8, PH)<br>(9, 3) |  | 0-0<br>SH<br>E<br>1B           | 0-0<br>FC1-5<br>1B       |            | 0-0<br>FC5-6<br>FC5-4             |                       |            | 0-3<br>K        |   |

| Inning Stats | R: 3<br>E: 2<br>K: 0<br>S: 7 | H: 2<br>LOB: 1<br>BB: 0<br>P: 7 | R: 3<br>E: 1<br>K: 1<br>S: 9 | H: 2<br>LOB: 2<br>BB: 1<br>P: 13 | R: 1<br>E: 0<br>K: 0<br>S: 5 | H: 2<br>LOB: 2<br>BB: 1<br>P: 9 | R: 0<br>E: 0<br>K: 0<br>S: 3 | H: 0<br>LOB: 0<br>BB: 0<br>P: 3 | R: 1<br>E: 0<br>K: 0<br>S: 3 | H: 1<br>LOB: 0<br>BB: 1<br>P: 7 | R: 0<br>E: 0<br>K: 1<br>S: 5 | H: 1<br>LOB: 0<br>BB: 0<br>P: 5 | R: 1<br>E: 0<br>K: 0<br>S: 4 | H: 1<br>LOB: 0<br>BB: 0<br>P: 4 | R: 0<br>E: 0<br>K: 2<br>S: 8 | H: 1<br>LOB: 1<br>BB: 0<br>P: 8 | R: 0<br>E: 0<br>K: 0<br>S: 3 | H: 0<br>LOB: 0<br>BB: 0<br>P: 3 |
|--------------|------------------------------|---------------------------------|------------------------------|----------------------------------|------------------------------|---------------------------------|------------------------------|---------------------------------|------------------------------|---------------------------------|------------------------------|---------------------------------|------------------------------|---------------------------------|------------------------------|---------------------------------|------------------------------|---------------------------------|
|--------------|------------------------------|---------------------------------|------------------------------|----------------------------------|------------------------------|---------------------------------|------------------------------|---------------------------------|------------------------------|---------------------------------|------------------------------|---------------------------------|------------------------------|---------------------------------|------------------------------|---------------------------------|------------------------------|---------------------------------|

| PITCHER                                 | IP  | WLS | BF | H | R | ER | SO | BB | IBB | HBP | BLK | WP | HR | S  | P  | ERA   | WHIP  |
|---|-----|-----|----|---|---|----|----|----|-----|-----|-----|----|----|----|----|-------|-------|
| Jose Santiago, R<br>ERA: 4.8<br>(1, 1)  | 1.1 |     | 12 | 3 | 6 | 2  | 1  | 1  | 0   | 0   | 0   | 0  | 0  | 13 | 17 | 13.50 | 3.000 |
| Ted Bowsfield, L<br>ERA: 4.1<br>(2, 1)  | 1.2 |     | 9  | 3 | 1 | 1  | 0  | 1  | 0   | 0   | 0   | 0  | 0  | 8  | 12 | 5.40  | 2.400 |
| Moe Drabowsky, R<br>ERA: 5.65<br>(4, 1) | 2.0 |     | 7  | 1 | 1 | 1  | 0  | 1  | 0   | 0   | 0   | 0  | 0  | 6  | 10 | 4.50  | 1.000 |
| Wes Stock, R<br>ERA: 2.35<br>(6, 1)     | 1.0 | W   | 3  | 1 | 0 | 0  | 1  | 0  | 0   | 0   | 0   | 0  | 0  | 5  | 5  | 0.00  | 1.000 |
| John Wyatt, R<br>ERA: 3.76<br>(7, 1)    | 3.0 | S   | 11 | 2 | 1 | 1  | 2  | 0  | 0   | 0   | 0   | 0  | 1  | 15 | 15 | 3.00  | 0.667 |

| Batter  | 1   | 2   | 3   | 4   | 5   | 6   | 7   | 8  | 9   | AB R H RBI BB SO LOB   | TOP   |
|---|---|---|---|---|---|---|---|--|---|--|---|
| Dick Green, R<br>OBP: 0.304, SLG: 0.392 (1, 4) X  | 0-0<br>1B<br>FC6-4<br>1B                              |   | 0-0<br>HBP<br>1B                                      |   | 0-0<br>1B   |   | 0-0<br>5-3  |  |   | 4 1 3 0 0 0 0  | <b>Kansas City Athletics @ Cleveland Indians</b><br><b>Cleveland Municipal Stadium, Cleveland, OH</b><br>Tue Aug 18 1964, 7:05 PM EDT<br>Att. 6,923 - Unknown |
| Wayne Causey, L<br>OBP: 0.382, SLG: 0.389 (1, 5) X  | 0-0<br>1-3<br>FC6-4<br>1B                             |   | 1-0<br>HBP  |   | 0-0<br>1-2<br>FC6-4<br>1B                           |   |   | 4-0<br>BB  |   | 2 0 2 0 1 0 0  |   |
| Ken Harrelson, R<br>OBP: 0.234, SLG: 0.333 (1, 7) X<br>(3, 3)   | 0-0<br>FC6-4<br>1-2f<br>3-H                           |   | 0-3<br>K  |   | 0-0<br>1-2f<br>FC6-4                                |   |   | 0-0<br>F8  |   | 4 0 0 1 0 1 6  |   |
| Rocky Colavito, R<br>OBP: 0.363, SLG: 0.543 (1, 9) X  | 0-0<br>F3   |   | 0-3<br>K  |   |   | 4-0<br>BB<br>FC6-4                                  |   | 0-3<br>K   |   | 3 0 0 0 1 2 4  |   |
| Jim Gentile, L<br>OBP: 0.385, SLG: 0.495 (1, 3) S<br>George Alusik, R<br>OBP: 0.348, SLG: 0.358 (3, 7) S  | 0-3<br>K  |   |   | 0-0<br>F7   |   | 0-0<br>6-3<br>1-2f<br>FC6-4                         |   | 0-3<br>K   |   | 1 0 0 0 0 1 1<br>3 0 0 0 0 1 2                                   |   |
| Nelson Mathews, R<br>OBP: 0.299, SLG: 0.364 (1, 8) S  |   | 0-3<br>K  |   | 0-0<br>F3   |   | 0-0<br>2-3<br>6-3                                   |   | 0-3<br>K   |   | 4 0 0 0 0 2 1  |   |
| Bert Campaneris, R<br>OBP: 0.327, SLG: 0.452 (1, 6) X   |   | 0-0<br>4-3  |   | 0-0<br>PO<br>1B                                     |   | 0-3<br>K  |   | 0-0<br>6-3   |   | 4 0 1 0 0 1 1  |   |
| Dave Duncan, R<br>OBP: 0.077, SLG: 0.077 (1, 2) X<br>Manny Jimenez, L<br>OBP: 0.298, SLG: 0.475 (9, PH)   |   | 0-0<br>G3   |   | 0-0<br>1-2<br>PO                                    |   | 0-0<br>5-3  |   | 0-0<br>F6  |   | 3 0 0 0 0 1 0<br>1 0 0 0 0 0 0                                   |   |
| Orlando Pena, R<br>OBP: 0.167, SLG: 0.177 (1, 1) S<br>John O'Donoghue, R<br>OBP: 0.200, SLG: 0.275 (5, 1) S<br>Jose Tartabull, L<br>OBP: 0.247, SLG: 0.244 (7, PH) S<br>Ken Sanders, R (7, 1) |   |   | 0-3<br>K  |   | 0-3<br>K  |   | 0-3<br>K  |  |   | 2 0 0 0 0 2 0<br>0 0 0 0 0 0 0<br>1 0 0 0 0 1 0<br>0 0 0 0 0 0 0 |   |
| <b>Inning Stats</b>   | R: 1 H: 2<br>E: 0 LOB: 1<br>K: 1 BB: 0<br>S: 7 P: 7   | R: 0 H: 0<br>E: 0 LOB: 0<br>K: 1 BB: 0<br>S: 5 P: 5 | R: 0 H: 1<br>E: 0 LOB: 2<br>K: 3 BB: 0<br>S: 10 P: 11 | R: 0 H: 1<br>E: 0 LOB: 0<br>K: 0 BB: 0<br>S: 3 P: 3 | R: 0 H: 2<br>E: 0 LOB: 2<br>K: 1 BB: 0<br>S: 7 P: 7 | R: 0 H: 0<br>E: 1 LOB: 1<br>K: 1 BB: 1<br>S: 5 P: 9 | R: 0 H: 0<br>E: 0 LOB: 0<br>K: 2 BB: 0<br>S: 7 P: 7 | R: 0 H: 0<br>E: 0 LOB: 1<br>K: 2 BB: 1<br>S: 7 P: 11 | R: 0 H: 0<br>E: 0 LOB: 0<br>K: 1 BB: 0<br>S: 5 P: 5 | 1B: 6 SF: 0<br>2B: 0 SAC: 0<br>3B: 0 DP: 0<br>HR: 0 HBP: 1       |   |
| <b>PITCHER</b><br>Luis Tiant, R (1, 1) ERA: 2.44  | IP WLS BF H R ER SO BB IBB HBP BLK WP HR S P ERA WHIP |   |   |   |   |   |   |  |   |  |   |

livebaseballscorecards.com

|            |           |
|------------|-----------|
| <b>AB</b>  | <b>32</b> |
| <b>R</b>   | <b>1</b>  |
| <b>H</b>   | <b>6</b>  |
| <b>RBI</b> | <b>1</b>  |
| <b>BB</b>  | <b>2</b>  |
| <b>SO</b>  | <b>12</b> |
| <b>LOB</b> | <b>15</b> |





| Batter   | 1                     | 2        | 3                  | 4                          | 5         | 6                 | 7                     | 8                | 9 |
|--|-----------------------|----------|--------------------|----------------------------|-----------|-------------------|-----------------------|------------------|---|
| Chico Salmon, R<br>OBP: 0.354, SLG: 0.405 (1, 4)   | 0-0<br>G5-4-3<br>1B   |          | 0-0<br>F4          |                            | 0-0<br>2B |                   | 0-0<br>F7             |                  |   |
| Dick Howser, R<br>OBP: 0.333, SLG: 0.327 (1, 6)    | 0-0<br>G5-4-3<br>1-2f |          | 0-0<br>5-3         |                            | 0-0<br>F8 |                   | 4-0<br>G1-6-3<br>BB   |                  |   |
| Fred Whitfield, L<br>OBP: 0.306, SLG: 0.430 (1, 3) | 0-0<br>F7             |          |                    | 0-0<br>HR                  | 0-0<br>2B |                   | 0-0<br>G1-6-3<br>1-2f |                  |   |
| Leon Wagner, L<br>OBP: 0.323, SLG: 0.465 (1, 7)    |                       | 0-3<br>K |                    | 0-3<br>K                   | 0-0<br>F8 |                   |                       | 0-0<br>4-3<br>2B |   |
| Tito Francona, L<br>OBP: 0.371, SLG: 0.379 (1, 9)  |                       | 0-3<br>K |                    | 0-0<br>HR                  |           | 0-0<br>4-3<br>1B  |                       | 0-0<br>4-3       |   |
| Woodie Held, R<br>OBP: 0.310, SLG: 0.437 (9, 9)    |                       |          |                    |                            |           |                   |                       | 2-3              |   |
| Vic Davalillo, L<br>OBP: 0.299, SLG: 0.329 (1, 8)  |                       | 0-3<br>K |                    | 0-0<br>E6<br>1B            |           | 0-0<br>4-3<br>1-2 |                       | 0-0<br>6-3       |   |
| Joe Azcue, R<br>OBP: 0.323, SLG: 0.396 (1, 2)      |                       |          | 0-0<br>SH5-4<br>1B | 0-0<br>G5-4-3<br>1-H<br>1B |           | 0-0<br>4-3        |                       | 0-0<br>2B        |   |
| Billy Moran, R<br>OBP: 0.292, SLG: 0.290 (1, 5)    |                       |          | 0-0<br>SH5-4<br>1B | 0-0<br>G5-4-3<br>1-2f      |           | 4-0<br>IBB        |                       | 4-0<br>IBB       |   |
| Luis Tiant, R<br>OBP: 0.050, SLG: 0.050 (1, 1)     |                       |          | 0-0<br>SH5-4       |                            | 0-0<br>F7 | 0-0<br>F9         |                       | 0-3<br>K         |   |

| AB | R | H | RBI | BB | SO | LOB |
|----|---|---|-----|----|----|-----|
| 4  | 1 | 2 | 0   | 0  | 0  | 2   |
| 3  | 0 | 0 | 0   | 1  | 0  | 4   |
| 4  | 1 | 2 | 2   | 0  | 0  | 1   |
| 4  | 1 | 1 | 0   | 0  | 2  | 1   |
| 4  | 1 | 2 | 1   | 0  | 1  | 1   |
| 0  | 0 | 0 | 0   | 0  | 0  | 0   |
| 4  | 1 | 0 | 0   | 0  | 1  | 2   |
| 4  | 0 | 3 | 2   | 0  | 0  | 1   |
| 2  | 0 | 1 | 0   | 2  | 0  | 1   |
| 3  | 0 | 0 | 0   | 0  | 1  | 4   |

**BOTTOM**

**Kansas City Athletics @ Cleveland Indians**  
Cleveland Municipal Stadium, Cleveland, OH

Tue Aug 18 1964, 7:05 PM EDT  
Att. 6,923 - Unknown

[livebaseballscorecards.com](http://livebaseballscorecards.com)

|            |           |
|------------|-----------|
| <b>AB</b>  | <b>32</b> |
| <b>R</b>   | <b>5</b>  |
| <b>H</b>   | <b>11</b> |
| <b>RBI</b> | <b>5</b>  |
| <b>BB</b>  | <b>3</b>  |
| <b>SO</b>  | <b>5</b>  |
| <b>LOB</b> | <b>17</b> |



|       |        |
|-------|--------|
| 1B: 5 | SF: 0  |
| 2B: 4 | SAC: 1 |
| 3B: 0 | DP: 3  |
| HR: 2 | HBP: 0 |

|       |        |
|-------|--------|
| WP: 0 | PA: 36 |
| PB: 0 |        |
| SB: 0 |        |
| CS: 0 |        |

| Inning Stats                                  | R | H | E | K | S | H | LOB | BB | P | R | H | E | K | S | H  | LOB | BB | P    | ERA   | WHIP  |
|---|---|---|---|---|---|---|-----|----|---|---|---|---|---|---|----|-----|----|------|-------|-------|
| <b>Orlando Pena, R</b><br>ERA: 4.47 (1, 1)    | 0 | 1 | 0 | 3 | 3 | 0 | 0   | 0  | 0 | 3 | 3 | 0 | 1 | 5 | 2  | 1   | 0  | 0    | 5.79  | 1.714 |
| <b>John O'Donoghue, L</b><br>ERA: 4.48 (5, 1) | 0 | 0 | 0 | 0 | 0 | 0 | 0   | 0  | 0 | 0 | 0 | 0 | 0 | 5 | 9  | 0   | 0  | 0.00 | 0.750 |       |
| <b>Ken Sanders, R</b><br>ERA: 2.7 (7, 1)      | 0 | 0 | 0 | 0 | 0 | 0 | 0   | 0  | 0 | 0 | 0 | 0 | 0 | 9 | 17 | 0   | 0  | 4.50 | 1.500 |       |

| PITCHER                                       | IP  | WLS | BF | H | R | ER | SO | BB | IBB | HBP | BLK | WP | HR | S  | P  | ERA  | WHIP  |
|---|-----|-----|----|---|---|----|----|----|-----|-----|-----|----|----|----|----|------|-------|
| <b>Orlando Pena, R</b><br>ERA: 4.47 (1, 1)    | 4.2 | L   | 21 | 8 | 4 | 3  | 4  | 0  | 0   | 0   | 0   | 0  | 2  | 29 | 29 | 5.79 | 1.714 |
| <b>John O'Donoghue, L</b><br>ERA: 4.48 (5, 1) | 1.1 |     | 6  | 1 | 0 | 0  | 0  | 0  | 1   | 0   | 0   | 0  | 0  | 5  | 9  | 0.00 | 0.750 |
| <b>Ken Sanders, R</b><br>ERA: 2.7 (7, 1)      | 2.0 |     | 9  | 2 | 1 | 1  | 1  | 1  | 1   | 0   | 0   | 0  | 0  | 9  | 17 | 4.50 | 1.500 |



| Batter  | 1          | 2          | 3         | 4         | 5         | 6          | 7         | 8          | 9 | AB | R | H | RBI | BB | SO | LOB |
|---|------------|------------|-----------|-----------|-----------|------------|-----------|------------|---|----|---|---|-----|----|----|-----|
| Chico Salmon, R<br>OBP: 0.352, SLG: 0.408<br>(1, 4)<br>(8, 9)   | 0-0<br>F7  |            | 0-0<br>F2 | 0-0<br>2B |           | 0-0<br>F7  |           |            |   | 4  | 0 | 1 | 0   | 0  | 0  | 0   |
| Dick Howser, R<br>OBP: 0.332, SLG: 0.325<br>(1, 6)  | 0-0<br>F8  |            | 4-0<br>1B | 0-0<br>L6 |           | 0-0<br>L6  |           |            |   | 3  | 1 | 0 | 0   | 1  | 0  | 2   |
| Fred Whitfield, L<br>OBP: 0.301, SLG: 0.423<br>(1, 3)   | 0-0<br>3-1 |            | 0-3<br>K  | 0-0<br>F2 |           |            | 0-0<br>F7 |            |   | 4  | 0 | 0 | 0   | 0  | 1  | 3   |
| Leon Wagner, L<br>OBP: 0.326, SLG: 0.464<br>(1, 7)  |            | 4-0<br>1B  | 4-0<br>1B |           | 4-0<br>1B |            | 0-3<br>K  |            |   | 1  | 3 | 0 | 0   | 3  | 1  | 0   |
| Tito Francona, L<br>OBP: 0.373, SLG: 0.378<br>Larry Brown, R<br>OBP: 0.287, SLG: 0.371<br>(7, PR)<br>(8, 4) |            | 0-3<br>K   | 4-0<br>1B |           | 0-3<br>K  |            | 0-0<br>1B |            |   | 3  | 1 | 1 | 0   | 1  | 2  | 2   |
| Vic Davalillo, L<br>OBP: 0.301, SLG: 0.330<br>(1, 8)  |            | 0-0<br>1B  | 0-0<br>1B |           | 0-3<br>K  |            | 0-0<br>F6 |            |   | 4  | 1 | 2 | 3   | 0  | 1  | 2   |
| Joe Azcue, R<br>OBP: 0.330, SLG: 0.403<br>(1, 2)  |            | 0-0<br>E9  | 0-0<br>1B |           | 0-0<br>1B |            |           | 0-3<br>K   |   | 4  | 0 | 3 | 2   | 0  | 1  | 0   |
| Billy Moran, R<br>OBP: 0.289, SLG: 0.287<br>(1, 5)  |            | 0-0<br>5-3 |           | 0-3<br>K  |           | 0-0<br>4-3 |           | 0-0<br>6-3 |   | 4  | 0 | 0 | 0   | 0  | 1  | 2   |
| Sam McDowell, L<br>OBP: 0.163, SLG: 0.100<br>Don McMahon, R<br>OBP: 0.182, SLG: 0.182<br>(7, 1)             |            | 0-0<br>4-3 |           | 0-0<br>2B |           | 0-0<br>3-1 |           | 0-3<br>K   |   | 3  | 0 | 1 | 0   | 0  | 0  | 1   |
|   |            |            |           |           |           |            |           |            |   | 1  | 0 | 0 | 0   | 0  | 1  | 0   |

| Inning Stats | R: 0 | H: 0 | E: 0 | K: 0 | S: 3 | R: 2 | H: 2 | E: 1 | K: 1 | S: 7 | R: 3 | H: 2 | E: 0 | K: 1 | S: 6 | R: 0 | H: 2 | E: 0 | K: 1 | S: 7 | R: 1 | H: 1 | E: 0 | K: 2 | S: 8 | R: 0 | H: 0 | E: 0 | K: 0 | S: 3 | R: 0 | H: 1 | E: 0 | K: 1 | S: 6 | R: 0 | H: 0 | E: 0 | K: 2 | S: 7 | R: 0 | H: 0 | E: 0 | K: 2 | S: 7 | 1B: 7 | 2B: 1 | 3B: 0 | HR: 0 | SF: 0 | SAC: 0 | DP: 0 | HBP: 0 | WP: 0 | PB: 0 | SB: 1 | CS: 0 | PA: 36 |
|--------------|------|------|------|------|------|------|------|------|------|------|------|------|------|------|------|------|------|------|------|------|------|------|------|------|------|------|------|------|------|------|------|------|------|------|------|------|------|------|------|------|------|------|------|------|------|-------|-------|-------|-------|-------|--------|-------|--------|-------|-------|-------|-------|--------|
|--------------|------|------|------|------|------|------|------|------|------|------|------|------|------|------|------|------|------|------|------|------|------|------|------|------|------|------|------|------|------|------|------|------|------|------|------|------|------|------|------|------|------|------|------|------|------|-------|-------|-------|-------|-------|--------|-------|--------|-------|-------|-------|-------|--------|

| PITCHER                                 | IP  | WLS | BF | H | R | ER | SO | BB | IBB | HBP | BLK | WP | HR | S  | P  | ERA   | WHIP  |
|---|-----|-----|----|---|---|----|----|----|-----|-----|-----|----|----|----|----|-------|-------|
| Diego Segui, R<br>ERA: 4.21<br>(1, 1)   | 3.1 | L   | 19 | 6 | 5 | 4  | 3  | 4  | 0   | 0   | 0   | 0  | 0  | 21 | 37 | 10.80 | 3.000 |
| Moe Drabowsky, R<br>ERA: 5.63<br>(4, 1) | 0.2 |     | 2  | 0 | 0 | 0  | 0  | 0  | 0   | 0   | 0   | 0  | 0  | 2  | 2  | 0.00  | 0.000 |
| Wes Stock, R<br>ERA: 2.4<br>(5, 1)      | 2.0 |     | 8  | 1 | 1 | 1  | 2  | 1  | 0   | 0   | 0   | 0  | 0  | 11 | 15 | 4.50  | 1.000 |
| John Wyatt, R<br>ERA: 3.68<br>(7, 1)    | 2.0 |     | 7  | 1 | 0 | 0  | 3  | 0  | 0   | 0   | 0   | 0  | 0  | 13 | 13 | 0.00  | 0.500 |

BOTTOM

Kansas City Athletics @ Cleveland Indians  
Cleveland Municipal Stadium, Cleveland, OH

Wed Aug 19 1964, 7:05 PM EDT  
Att: 4,311 - Unknown

livebaseballscorecards.com

|     |    |
|-----|----|
| AB  | 31 |
| R   | 6  |
| H   | 8  |
| RBI | 5  |
| BB  | 5  |
| SO  | 8  |
| LOB | 12 |







| Batter   | 1   | 2                               | 3                            | 4                               | 5                            | 6                               | 7                            | 8                                | 9                            | AB R H RBI BB SO LOB            | TOP  |                                 |   |                                 |                              |                                 |                                  |                                    |                                  |        |
|--|---|---------------------------------|------------------------------|---------------------------------|------------------------------|---------------------------------|------------------------------|----------------------------------|------------------------------|---------------------------------|--|---------------------------------|---|---------------------------------|------------------------------|---------------------------------|----------------------------------|------------------------------------|----------------------------------|--------|
| Dick Green, R<br>OBP: 0.302, SLG: 0.385<br>(1, 4) X  | 0-0<br>3-1<br>1B  |                                 | 0-3<br>K                     |                                 | 0-0<br>5-3                   |                                 |                              | 0-3<br>K                         |                              | 4 0 1 0 0 2 0                   | <p>Kansas City Athletics @ Washington Senators<br/>D.C. Stadium, Washington, DC</p> <p>livebaseballscorecards.com</p> <p>AB 32<br/>R 3<br/>H 6<br/>RBI 3<br/>BB 2<br/>SO 3<br/>LOB 6</p>  |                                 |   |                                 |                              |                                 |                                  |                                    |                                  |        |
| Wayne Causey, L<br>OBP: 0.387, SLG: 0.394<br>(1, 6) X  | 0-0<br>3-1<br>1-2   |                                 |                              | 0-0<br>1B<br>3B                 | 0-0<br>6-3                   |                                 |                              | 0-0<br>1B                        |                              | 4 1 2 0 0 0 1                   |  |                                 |   |                                 |                              |                                 |                                  |                                    |                                  |        |
| Ed Charles, R<br>OBP: 0.328, SLG: 0.380<br>(1, 5) B B B  | 4-0<br>BB   |                                 |                              | 0-0<br>HR<br>1B                 | 0-0<br>F9                    |                                 |                              | 0-0<br>P4                        |                              | 3 1 1 1 1 0 1                   |  |                                 |   |                                 |                              |                                 |                                  |                                    |                                  |        |
| Rocky Colavito, R<br>OBP: 0.358, SLG: 0.543<br>(1, 9) X  | 0-0<br>F2   |                                 |                              | 0-0<br>3-H<br>1-H<br>HR         |                              | 0-0<br>6-3                      |                              | 0-0<br>6-3                       |                              | 4 1 1 2 0 0 2                   |  |                                 |   |                                 |                              |                                 |                                  |                                    |                                  |        |
| Jim Gentile, L<br>OBP: 0.388, SLG: 0.500<br>(1, 3) X   |   | 0-0<br>4-3                      |                              | 0-0<br>F9                       |                              | 0-0<br>F5                       |                              | 0-0<br>F3                        |                              | 4 0 0 0 0 0 0                   |  |                                 |   |                                 |                              |                                 |                                  |                                    |                                  |        |
| Doc Edwards, R<br>OBP: 0.248, SLG: 0.274<br>(1, 2) X   |   | 0-0<br>F8                       |                              | 0-0<br>F9                       |                              | 0-0<br>F9                       |                              | 0-0<br>P4                        |                              | 4 0 0 0 0 0 0                   |  |                                 |   |                                 |                              |                                 |                                  |                                    |                                  |        |
| Bert Campaneris, R<br>OBP: 0.327, SLG: 0.442<br>Jose Tartabull, L<br>OBP: 0.244, SLG: 0.241<br>(1, 7) (9, 7) X |   | 0-0<br>F9                       |                              | 0-0<br>2B                       |                              | 0-0<br>5-3                      |                              | 0-0<br>F8                        |                              | 4 0 1 0 0 0 0<br>0 0 0 0 0 0 0  |  |                                 |   |                                 |                              |                                 |                                  |                                    |                                  |        |
| Nelson Mathews, R<br>OBP: 0.298, SLG: 0.359<br>(1, 8) X  |   |                                 | 0-0<br>F9                    | 4-0<br>IBB                      |                              | 0-0<br>P3                       |                              |                                  |                              | 2 0 0 0 1 0 0                   |  |                                 |   |                                 |                              |                                 |                                  |                                    |                                  |        |
| John O'Donoghue, R<br>OBP: 0.190, SLG: 0.262<br>Moe Drabowsky, R<br>OBP: 0.025, SLG: 0.025<br>(1, 1) (5, 1) X  |   |                                 | 0-0<br>1-3                   | 0-3<br>K                        |                              | 0-0<br>F8                       |                              |                                  |                              | 2 0 0 0 0 1 2<br>1 0 0 0 0 0 0  |  |                                 |   |                                 |                              |                                 |                                  |                                    |                                  |        |
| <b>Inning Stats</b>  | R: 0<br>E: 0<br>K: 0<br>S: 3  | H: 1<br>LOB: 1<br>BB: 1<br>P: 7 | R: 0<br>E: 0<br>K: 0<br>S: 3 | H: 0<br>LOB: 0<br>BB: 0<br>P: 3 | R: 0<br>E: 0<br>K: 1<br>S: 5 | H: 0<br>LOB: 0<br>BB: 0<br>P: 5 | R: 3<br>E: 0<br>K: 1<br>S: 9 | H: 4<br>LOB: 2<br>BB: 1<br>P: 13 | R: 0<br>E: 0<br>K: 0<br>S: 3 | H: 0<br>LOB: 0<br>BB: 0<br>P: 3 | R: 0<br>E: 0<br>K: 0<br>S: 3   | H: 0<br>LOB: 0<br>BB: 0<br>P: 3 | R: 0<br>E: 0<br>K: 1<br>S: 6                          | H: 1<br>LOB: 1<br>BB: 0<br>P: 6 | R: 0<br>E: 0<br>K: 0<br>S: 3 | H: 0<br>LOB: 0<br>BB: 0<br>P: 3 | 1B: 3<br>2B: 1<br>3B: 1<br>HR: 1 | SF: 0<br>SAC: 0<br>DP: 0<br>HBP: 0 | WP: 0<br>PB: 0<br>SB: 0<br>CS: 0 | PA: 34 |
| <b>PITCHER</b><br>Claude Osteen, L<br>ERA: 3.34<br>(1, 1)  | IP 9.0<br>WLS L<br>BF 34<br>H 6<br>R 3<br>ER 3<br>SO 3<br>BB 1<br>IBB 1<br>HBP 0<br>BLK 0<br>WP 0<br>HR 1<br>S 38<br>P 46<br>ERA 3.00<br>WHIP 0.778 |                                 |                              |                                 |                              |                                 |                              |                                  |                              |                                 |  | <b>PITCHER</b>                  | IP WLS BF H R ER SO BB IBB HBP BLK WP HR S P ERA WHIP |                                 |                              |                                 |                                  |                                    |                                  |        |

| Batter | 1 | 2 | 3 | 4 | 5 | 6 | 7 | 8 | 9 | AB | R | H | RBI | BB | SO | LOB |
|--------|---|---|---|---|---|---|---|---|---|----|---|---|-----|----|----|-----|
|--------|---|---|---|---|---|---|---|---|---|----|---|---|-----|----|----|-----|

|  |                        |                        |                        |                        |                        |                        |                        |                        |                        |   |   |   |   |   |   |   |
|--|------------------------|------------------------|------------------------|------------------------|------------------------|------------------------|------------------------|------------------------|------------------------|---|---|---|---|---|---|---|
| <b>Ed Brinkman, R</b><br><small>OBP: 0.267, SLG: 0.345</small><br><b>Roy Sievers, R</b><br><small>OBP: 0.259, SLG: 0.336</small><br><small>(1, 6)</small>                                | <br><small>0-0</small> |                        | <br><small>0-3</small> |                        | <br><small>0-0</small> |                        | <br><small>0-3</small> |                        | <br><small>0-0</small> | 4 | 0 | 0 | 0 | 0 | 2 | 1 |
| <b>John Kennedy, R</b><br><small>OBP: 0.295, SLG: 0.352</small><br><small>(1, 5)</small>   | <br><small>0-0</small> |                        | <br><small>0-0</small> |                        | <br><small>0-0</small> |                        | <br><small>1-0</small> |                        |                        | 3 | 0 | 2 | 1 | 0 | 0 | 0 |
| <b>Chuck Hinton, R</b><br><small>OBP: 0.350, SLG: 0.438</small><br><small>(1, 7)</small>   | <br><small>0-0</small> |                        | <br><small>0-0</small> |                        | <br><small>4-0</small> |                        | <br><small>0-3</small> |                        |                        | 3 | 0 | 0 | 0 | 1 | 1 | 2 |
| <b>Don Lock, R</b><br><small>OBP: 0.353, SLG: 0.474</small><br><small>(1, 8)</small>   |                        | <br><small>0-0</small> |                        | <br><small>4-0</small> | <br><small>0-3</small> |                        | <br><small>0-3</small> |                        |                        | 3 | 1 | 1 | 1 | 1 | 2 | 3 |
| <b>Willie Kirkland, L</b><br><small>OBP: 0.293, SLG: 0.331</small><br><small>(1, 9)</small>  |                        | <br><small>0-0</small> |                        | <br><small>0-0</small> |                        | <br><small>0-0</small> |                        | <br><small>0-0</small> |                        | 4 | 0 | 2 | 0 | 0 | 0 | 1 |
| <b>Don Leppert, R</b><br><small>OBP: 0.214, SLG: 0.279</small><br><b>Mike Brumley, L</b><br><small>OBP: 0.307, SLG: 0.300</small><br><small>(6, PH)</small><br><small>(7, 2)</small>     |                        | <br><small>0-0</small> |                        | <br><small>0-0</small> |                        | <br><small>0-0</small> |                        | <br><small>0-0</small> |                        | 2 | 0 | 0 | 0 | 0 | 0 | 2 |
| <b>Dick Phillips, L</b><br><small>OBP: 0.313, SLG: 0.303</small><br><small>(1, 3)</small>  |                        | <br><small>0-0</small> |                        | <br><small>0-0</small> |                        | <br><small>4-0</small> |                        | <br><small>0-0</small> |                        | 3 | 0 | 0 | 0 | 1 | 0 | 2 |
| <b>Chuck Cottier, R</b><br><small>OBP: 0.257, SLG: 0.323</small><br><b>Don Blasingame, L</b><br><small>OBP: 0.315, SLG: 0.315</small><br><small>(6, PH)</small><br><small>(7, 4)</small> |                        | <br><small>0-0</small> |                        | <br><small>0-0</small> |                        | <br><small>0-0</small> |                        | <br><small>0-0</small> |                        | 2 | 1 | 1 | 0 | 0 | 0 | 1 |
| <b>Claude Osteen, L</b><br><small>OBP: 0.187, SLG: 0.254</small><br><b>Jim King, L</b><br><small>OBP: 0.346, SLG: 0.442</small><br><small>(9, PH)</small><br><small>(1, 1)</small>       |                        |                        | <br><small>0-3</small> |                        | <br><small>0-0</small> |                        | <br><small>0-0</small> |                        | <br><small>0-0</small> | 2 | 0 | 0 | 0 | 0 | 1 | 2 |
|  |                        |                        |                        |                        |                        |                        |                        |                        |                        | 1 | 0 | 0 | 0 | 0 | 0 | 0 |

|  |  |   |   |  |   |  |   |   |  |
|--|--|---|---|--|---|--|---|---|--|
| <b>Inning Stats</b><br>R: 0 H: 0<br>E: 0 LOB: 0<br>K: 0 BB: 0<br>S: 3 P: 3                               | R: 1 H: 2<br>E: 0 LOB: 1<br>K: 0 BB: 0<br>S: 5 P: 5  | R: 0 H: 1<br>E: 0 LOB: 1<br>K: 2 BB: 0<br>S: 8 P: 8 | R: 0 H: 0<br>E: 0 LOB: 1<br>K: 0 BB: 1<br>S: 3 P: 7 | R: 1 H: 2<br>E: 1 LOB: 2<br>K: 1 BB: 1<br>S: 7 P: 11 | R: 0 H: 2<br>E: 0 LOB: 2<br>K: 0 BB: 1<br>S: 4 P: 8 | R: 0 H: 0<br>E: 0 LOB: 1<br>K: 3 BB: 0<br>S: 9 P: 10 | R: 0 H: 0<br>E: 0 LOB: 0<br>K: 0 BB: 0<br>S: 3 P: 3 | R: 0 H: 0<br>E: 0 LOB: 0<br>K: 0 BB: 0<br>S: 3 P: 3 | 1B: 5 SF: 0<br>2B: 1 SAC: 1<br>3B: 0 DP: 1<br>HR: 1 HBP: 1 |
| <b>PITCHER</b><br><b>John O'Donoghue, L</b><br><small>ERA: 4.45</small><br><small>(1, 1)</small>         | <b>Moe Drabowsky, R</b><br><small>ERA: 5.44</small><br><small>(5, 1)</small>                             |   |   |  |   |  |   |   | WP: 0 PA: 37<br>PB: 0<br>SB: 1<br>CS: 0                    |
| IP WLS BF H R ER SO BB IBB HBP BLK WP HR S P ERA WHIP<br>4.2 0 21 5 2 2 2 2 2 0 0 0 0 1 23 31 3.86 1.500 | IP WLS BF H R ER SO BB IBB HBP BLK WP HR S P ERA WHIP<br>4.1 W 16 2 0 0 4 1 0 1 0 0 0 0 22 27 0.00 0.692 |   |   |  |   |  |   |   |  |

**BOTTOM**

**Kansas City Athletics @ Washington Senators**  
**D.C. Stadium, Washington, DC**  
 Fri Aug 21 1964, 7:05 PM EDT  
 Att. 3,649 - Unknown

[livebaseballscorecards.com](http://livebaseballscorecards.com)

|            |           |
|------------|-----------|
| <b>AB</b>  | <b>32</b> |
| <b>R</b>   | <b>2</b>  |
| <b>H</b>   | <b>7</b>  |
| <b>RBI</b> | <b>2</b>  |
| <b>BB</b>  | <b>3</b>  |
| <b>SO</b>  | <b>6</b>  |
| <b>LOB</b> | <b>15</b> |



| Batter  | 1   | 2                               | 3                            | 4                               | 5                            | 6                               | 7                            | 8                               | 9                            | AB R H RBI BB SO LOB            | TOP  |                                  |                              |                                 |                              |                                 |                              |                                 |                                  |                                    |                                  |        |
|---|---|---------------------------------|------------------------------|---------------------------------|------------------------------|---------------------------------|------------------------------|---------------------------------|------------------------------|---------------------------------|--|----------------------------------|------------------------------|---------------------------------|------------------------------|---------------------------------|------------------------------|---------------------------------|----------------------------------|------------------------------------|----------------------------------|--------|
| Dick Green, R (1, 4)<br>OBP: 0.300, SLG: 0.382      | 0-0 F9  |                                 | 0-0 F9                       |                                 |                              | 0-0 2B 1B                       | 0-0 5-3                      |                                 | 0-0 FC5-2                    | 5 1 1 0 0 0 2                   | <p>Kansas City Athletics @ Washington Senators</p> <p>D.C. Stadium, Washington, DC</p> <p>Sat Aug 22 1964, 3:33 AM EDT</p> <p>Att. 1,981 - Unknown</p> <p>livebaseballscorecards.com</p> |                                  |                              |                                 |                              |                                 |                              |                                 |                                  |                                    |                                  |        |
| Wayne Causey, L (1, 6)<br>OBP: 0.389, SLG: 0.405    | 0-3 K   |                                 |                              | 0-0 HR                          |                              | 0-0 1B 2B                       | 0-0 G6-4-3 1B                | 0-3 K                           | 5 2 3 1 0 2 2                |                                 |  |                                  |                              |                                 |                              |                                 |                              |                                 |                                  |                                    |                                  |        |
| Ed Charles, R (1, 5)<br>OBP: 0.327, SLG: 0.379      | 0-0 FC6-4 1B  |                                 |                              | 0-0 6-3                         |                              | 0-0 1-3                         | 0-0 G6-4-3 1-2f              |                                 | 4 0 1 0 0 0 3                |                                 |  |                                  |                              |                                 |                              |                                 |                              |                                 |                                  |                                    |                                  |        |
| Rocky Colavito, R (1, 9)<br>OBP: 0.358, SLG: 0.540  | 0-0 FC6-4 1-2f  |                                 |                              | 0-0 F5                          |                              | 0-0 HR 1B                       |                              | 0-0 L6                          | 4 1 1 2 0 0 1                |                                 |  |                                  |                              |                                 |                              |                                 |                              |                                 |                                  |                                    |                                  |        |
| Jim Gentile, L (1, 3)<br>OBP: 0.387, SLG: 0.495     |   | 0-3 K                           |                              | 0-0 G3                          |                              | 4-0 HR IBB                      |                              | 0-0 F5                          | 3 1 0 0 1 1 0                |                                 |  |                                  |                              |                                 |                              |                                 |                              |                                 |                                  |                                    |                                  |        |
| Doc Edwards, R (1, 2)<br>OBP: 0.248, SLG: 0.286     |   | 0-0 6-3                         |                              |                                 | 0-3 K                        | 0-0 HR 1-H 2-H                  |                              | 0-3 K                           | 4 1 1 3 0 2 0                |                                 |  |                                  |                              |                                 |                              |                                 |                              |                                 |                                  |                                    |                                  |        |
| Bert Campaneris, R (1, 7)<br>OBP: 0.325, SLG: 0.444 |   | 0-0 F7                          |                              |                                 | 0-0 2B                       |                                 | 0-3 K                        | 0-0 F5                          | 4 0 1 0 0 0 1 0              |                                 |  |                                  |                              |                                 |                              |                                 |                              |                                 |                                  |                                    |                                  |        |
| Jose Tartabull, L (9, 7)<br>OBP: 0.244, SLG: 0.241  |   |                                 |                              |                                 |                              |                                 |                              |                                 | 0 0 0 0 0 0 0 0              |                                 |  |                                  |                              |                                 |                              |                                 |                              |                                 |                                  |                                    |                                  |        |
| Nelson Mathews, R (1, 8)<br>OBP: 0.300, SLG: 0.361  |   |                                 | 0-3 K                        |                                 | 0-0 F7                       | 4-0 BB BB                       |                              | 0-0 1B FC5-2 2B                 | 3 0 1 0 1 1 1                |                                 |  |                                  |                              |                                 |                              |                                 |                              |                                 |                                  |                                    |                                  |        |
| Orlando Pena, R (1, 1)<br>OBP: 0.159, SLG: 0.169    |   |                                 | 0-0 5-3                      |                                 |                              |                                 | 0-3 K                        | 0-0 FC5-2                       | 3 0 0 0 0 2 2                |                                 |  |                                  |                              |                                 |                              |                                 |                              |                                 |                                  |                                    |                                  |        |
| Wes Stock, R (8, 1)<br>OBP: 0.235, SLG: 0.188       |   |                                 |                              |                                 |                              |                                 | 0-3 K                        | 0-0 2-3 1B                      | 1 0 1 0 0 0 0                |                                 |  |                                  |                              |                                 |                              |                                 |                              |                                 |                                  |                                    |                                  |        |
| <b>Inning Stats</b>                                 | R: 0<br>E: 0<br>K: 1<br>S: 6                          | H: 1<br>LOB: 1<br>BB: 0<br>P: 6 | R: 0<br>E: 0<br>K: 1<br>S: 5 | H: 0<br>LOB: 0<br>BB: 0<br>P: 5 | R: 0<br>E: 0<br>K: 1<br>S: 5 | H: 0<br>LOB: 0<br>BB: 0<br>P: 5 | R: 1<br>E: 0<br>K: 0<br>S: 4 | H: 1<br>LOB: 0<br>BB: 0<br>P: 4 | R: 0<br>E: 0<br>K: 2<br>S: 8 | H: 1<br>LOB: 1<br>BB: 0<br>P: 8 | R: 5<br>E: 0<br>K: 2<br>S: 11  | H: 4<br>LOB: 1<br>BB: 2<br>P: 19 | R: 0<br>E: 0<br>K: 0<br>S: 3 | H: 1<br>LOB: 0<br>BB: 0<br>P: 3 | R: 0<br>E: 0<br>K: 1<br>S: 5 | H: 0<br>LOB: 0<br>BB: 0<br>P: 5 | R: 0<br>E: 0<br>K: 1<br>S: 7 | H: 2<br>LOB: 2<br>BB: 0<br>P: 7 | 1B: 5<br>2B: 3<br>3B: 0<br>HR: 2 | SF: 0<br>SAC: 0<br>DP: 1<br>HBP: 0 | WP: 0<br>PB: 0<br>SB: 0<br>CS: 0 | PA: 38 |
| <b>PITCHER</b>                                      | IP WLS BF H R ER SO BB IBB HBP BLK WP HR S P ERA WHIP |                                 |                              |                                 |                              |                                 |                              |                                 |                              |                                 |  |                                  |                              |                                 |                              |                                 |                              |                                 |                                  |                                    |                                  |        |
| Buster Narum, R (1, 1)<br>ERA: 4.06                 | 5.1 L 24 7 6 6 5 0 1 0 0 0 0 2 33 37 10.12 1.312      |                                 |                              |                                 |                              |                                 |                              |                                 |                              |                                 |  |                                  |                              |                                 |                              |                                 |                              |                                 |                                  |                                    |                                  |        |
| Jim Hannan, R (6, 1)<br>ERA: 3.61                   | 1.2 6 1 0 0 2 1 0 0 0 0 0 0 9 13 0.00 1.200           |                                 |                              |                                 |                              |                                 |                              |                                 |                              |                                 |  |                                  |                              |                                 |                              |                                 |                              |                                 |                                  |                                    |                                  |        |
| Alan Koch, R (8, 1)<br>ERA: 5.16                    | 1.1 5 1 0 0 1 0 0 0 0 0 0 0 7 7 0.00 0.750            |                                 |                              |                                 |                              |                                 |                              |                                 |                              |                                 |  |                                  |                              |                                 |                              |                                 |                              |                                 |                                  |                                    |                                  |        |
| Dave Stenhouse, R (9, 1)<br>ERA: 4.97               | 0.2 3 1 0 0 1 0 0 0 0 0 0 0 5 5 0.00 1.500            |                                 |                              |                                 |                              |                                 |                              |                                 |                              |                                 |  |                                  |                              |                                 |                              |                                 |                              |                                 |                                  |                                    |                                  |        |

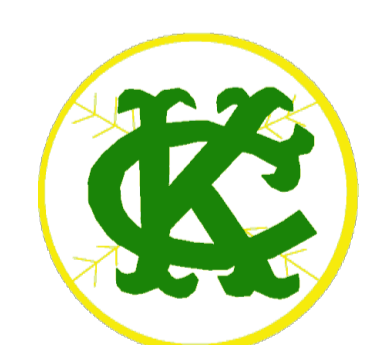



| Batter  | 1          | 2                  | 3         | 4             | 5                 | 6                 | 7             | 8                    | 9                    | AB R H RBI BB SO LOB |
|---|------------|--------------------|-----------|---------------|-------------------|-------------------|---------------|----------------------|----------------------|----------------------|
| Don Blasingame, L (1, 4)<br>OBP: 0.318, SLG: 0.321  | 0-0<br>4-3 |                    |           | 0-0<br>4-3    |                   | 0-0<br>1B 2B      |               | 0-0<br>FC6-4 1B      | 0-0<br>1-2 1B        | 5 0 3 0 0 0 0        |
| John Kennedy, R (1, 5)<br>OBP: 0.294, SLG: 0.350    | 0-3<br>K   |                    |           | 0-0<br>F8     |                   | 0-0<br>FC6-4 1B   |               | 0-0<br>FC6-4 2B 1-2f | 0-3<br>K             | 5 0 1 0 0 2 3        |
| Jim King, L (1, 9)<br>OBP: 0.347, SLG: 0.444        | 0-0<br>F9  |                    |           | 4-0<br>HR BB  |                   | 0-0<br>P6         |               | 0-0<br>1-3 2B        |                      | 3 1 1 0 1 0 2        |
| Willie Kirkland, L (1, 7)<br>OBP: 0.302, SLG: 0.354 |            | 0-0<br>G5-4-3 1B   |           | 0-0<br>1-H HR |                   | 0-3<br>K          |               | 4-0<br>BB            |                      | 3 1 2 2 1 1 2        |
| Don Lock, R (1, 8)<br>OBP: 0.350, SLG: 0.469        |            | 0-0<br>G5-4-3 1-2f |           | 0-3<br>K      |                   | 0-0<br>FC6-4 1-2f |               | 0-3<br>K             |                      | 4 0 0 0 0 2 6        |
| Dick Phillips, L (1, 3)<br>OBP: 0.312, SLG: 0.302   |            | 0-0<br>F8          |           |               | 0-0<br>3-1        |                   | 0-0<br>1-3 1B | 0-0<br>4-3           |                      | 4 0 1 0 0 0 3        |
| Mike Brumley, L (1, 2)<br>OBP: 0.304, SLG: 0.297    |            |                    | 0-0<br>F8 |               | 0-3<br>K          |                   | 0-0<br>1-3    |                      | 0-0<br>L1            | 3 0 0 0 0 1 1        |
| Joe Cunningham, L (9, PH)<br>OBP: 0.353, SLG: 0.287 |            |                    |           |               |                   |                   |               |                      |                      | 1 0 0 0 0 0 0        |
| Ed Brinkman, R (1, 6)<br>OBP: 0.269, SLG: 0.345     |            |                    | 0-3<br>K  |               | 4-0<br>FC4-6 BB   |                   | 0-0<br>F8     |                      | 0-0<br>FC3-6 1B      | 3 0 1 0 1 1 1        |
| Buster Narum, R (1, 1)<br>OBP: 0.020, SLG: 0.020    |            |                    | 0-3<br>K  |               | 0-0<br>FC4-6 1-2f |                   | 0-3<br>K      |                      | 0-0<br>FC3-6 1B 1-2f | 2 0 0 0 0 0 1 1      |
| Jim Hanther, K (6, 1)<br>OBP: 0.150, SLG: 0.158     |            |                    |           |               |                   |                   |               |                      |                      | 0 0 0 0 0 0 0 0      |
| Roy Sievers, R (7, PH)<br>OBP: 0.257, SLG: 0.333    |            |                    |           |               |                   |                   |               |                      |                      | 1 0 0 0 0 0 1 1      |
| Alan Koch, R (8, 1)<br>OBP: 0.267, SLG: 0.367       |            |                    |           |               |                   |                   |               |                      |                      | 0 0 0 0 0 0 0 0      |
| Dave Stenhouse, R (9, 1)<br>OBP: 0.440, SLG: 0.357  |            |                    |           |               |                   |                   |               |                      |                      | 0 0 0 0 0 0 0 0      |
| Fred Valentine, S (9, PH)<br>OBP: 0.316, SLG: 0.321 |            |                    |           |               |                   |                   |               |                      |                      | 1 0 0 0 0 0 0 1      |

BOTTOM

Kansas City Athletics @ Washington Senators  
D.C. Stadium, Washington, DC  
Sat Aug 22 1964, 3:33 AM EDT  
Att. 1,981 - Unknown

livebaseballscorecards.com

|     |    |
|-----|----|
| AB  | 35 |
| R   | 2  |
| H   | 9  |
| RBI | 2  |
| BB  | 3  |
| SO  | 9  |
| LOB | 21 |



|       |        |
|-------|--------|
| WP: 0 | PA: 38 |
| PB: 0 |        |
| SB: 0 |        |
| CS: 0 |        |

| Inning Stats                        | R: 0 | H: 0 | E: 0 | K: 1 | S: 5 | H: 0 | LOB: 0 | BB: 0 | P: 5 | R: 0 | H: 1 | E: 0 | K: 0 | S: 3 | R: 0 | H: 0 | E: 0  | K: 2 | S: 7 | R: 2 | H: 1 | E: 0 | K: 1 | S: 6 | R: 0 | H: 0 | E: 0 | K: 1 | S: 5 | R: 0 | H: 2 | E: 0 | K: 1 | S: 7 | R: 0 | H: 1 | E: 0 | K: 1 | S: 6 | R: 0 | H: 2 | E: 0 | K: 1 | S: 7 | R: 0 | H: 2 | E: 0 | K: 1 | S: 7 | R: 0 | H: 2 | E: 0 | K: 1 | S: 7 | 1B: 6 | SF: 0 | 2B: 2 | SAC: 0 | 3B: 0 | DP: 1 | HR: 1 | HBP: 0 | WP: 0 | PA: 38 |
|-------------------------------------|------|------|------|------|------|------|--------|-------|------|------|------|------|------|------|------|------|-------|------|------|------|------|------|------|------|------|------|------|------|------|------|------|------|------|------|------|------|------|------|------|------|------|------|------|------|------|------|------|------|------|------|------|------|------|------|-------|-------|-------|--------|-------|-------|-------|--------|-------|--------|
| PITCHER                             | IP   | WLS  | BF   | H    | R    | ER   | SO     | BB    | IBB  | HBP  | BLK  | WP   | HR   | S    | P    | ERA  | WHIP  |      |      |      |      |      |      |      |      |      |      |      |      |      |      |      |      |      |      |      |      |      |      |      |      |      |      |      |      |      |      |      |      |      |      |      |      |      |       |       |       |        |       |       |       |        |       |        |
| Orlando Pena, R (1, 1)<br>ERA: 4.39 | 7.1  | W    | 31   | 7    | 2    | 2    | 7      | 3     | 0    | 0    | 0    | 0    | 1    | 42   | 54   | 2.46 | 1.364 |      |      |      |      |      |      |      |      |      |      |      |      |      |      |      |      |      |      |      |      |      |      |      |      |      |      |      |      |      |      |      |      |      |      |      |      |      |       |       |       |        |       |       |       |        |       |        |
| Wes Stock, R (8, 1)<br>ERA: 2.41    | 1.2  | S    | 7    | 2    | 0    | 0    | 2      | 0     | 0    | 0    | 0    | 0    | 0    | 11   | 11   | 0.00 | 1.200 |      |      |      |      |      |      |      |      |      |      |      |      |      |      |      |      |      |      |      |      |      |      |      |      |      |      |      |      |      |      |      |      |      |      |      |      |      |       |       |       |        |       |       |       |        |       |        |

| PITCHER                             | IP  | WLS | BF | H | R | ER | SO | BB | IBB | HBP | BLK | WP | HR | S  | P  | ERA  | WHIP  |
|-------------------------------------|-----|-----|----|---|---|----|----|----|-----|-----|-----|----|----|----|----|------|-------|
| Orlando Pena, R (1, 1)<br>ERA: 4.39 | 7.1 | W   | 31 | 7 | 2 | 2  | 7  | 3  | 0   | 0   | 0   | 0  | 1  | 42 | 54 | 2.46 | 1.364 |
| Wes Stock, R (8, 1)<br>ERA: 2.41    | 1.2 | S   | 7  | 2 | 0 | 0  | 2  | 0  | 0   | 0   | 0   | 0  | 0  | 11 | 11 | 0.00 | 1.200 |

| Batter  | 1   | 2                               | 3                            | 4                               | 5                                 | 6                               | 7                            | 8                               | 9                            | AB R H RBI BB SO LOB             | TOP  |                                  |                              |                                 |                              |                                 |                              |                                 |                                  |                                    |                                  |        |
|---|---|---------------------------------|------------------------------|---------------------------------|-----------------------------------|---------------------------------|------------------------------|---------------------------------|------------------------------|----------------------------------|--|----------------------------------|------------------------------|---------------------------------|------------------------------|---------------------------------|------------------------------|---------------------------------|----------------------------------|------------------------------------|----------------------------------|--------|
| Dick Green, R (1, 4)<br>OBP: 0.303, SLG: 0.383      | 0-0<br>SH1-3<br>SF8<br>1B                             |                                 | 0-0<br>G1-6-3<br>1-2f        |                                 | 0-0<br>G3-6-3<br>1-3<br>3-H<br>1B |                                 | 0-0<br>1-6-3                 |                                 |                              | 4 1 2 1 0 0 1                    | <b>Kansas City Athletics @ Washington Senators</b><br><b>D.C. Stadium, Washington, DC</b><br>Sun Aug 23 1964, 3:33 AM EDT<br>Unknown<br><a href="http://livebaseballscorecards.com">livebaseballscorecards.com</a> |                                  |                              |                                 |                              |                                 |                              |                                 |                                  |                                    |                                  |        |
| Wayne Causey, L (1, 6)<br>OBP: 0.388, SLG: 0.403    | 0-0<br>SH1-3<br>1-2<br>1B                             |                                 | 0-0<br>3-1                   |                                 | 0-0<br>G3-6-3<br>1-2f             |                                 | 0-0<br>P6                    |                                 |                              | 4 0 1 0 0 0 2                    |  |                                  |                              |                                 |                              |                                 |                              |                                 |                                  |                                    |                                  |        |
| Ed Charles, R (1, 5)<br>OBP: 0.325, SLG: 0.376      | 0-0<br>SH1-3<br>1-2<br>2-3                            |                                 |                              | 0-0<br>F8                       |                                   | 0-0<br>F7                       |                              | 0-3<br>K                        |                              | 3 0 0 0 0 1 0                    |  |                                  |                              |                                 |                              |                                 |                              |                                 |                                  |                                    |                                  |        |
| Rocky Colavito, R (1, 9)<br>OBP: 0.357, SLG: 0.539  | 0-0<br>SF8<br>3-H                                     |                                 |                              | 0-0<br>F3                       |                                   | 0-0<br>5-3                      |                              | 0-0<br>G3<br>1B                 |                              | 3 0 1 1 0 0 0                    |  |                                  |                              |                                 |                              |                                 |                              |                                 |                                  |                                    |                                  |        |
| Jim Gentile, L (1, 3)<br>OBP: 0.386, SLG: 0.490     | 0-0<br>F8   |                                 |                              | 0-0<br>4-3                      |                                   | 4-0<br>2B<br>BB                 |                              | 0-0<br>G3<br>1-2f               |                              | 3 0 0 0 1 0 2                    |  |                                  |                              |                                 |                              |                                 |                              |                                 |                                  |                                    |                                  |        |
| Billy Bryan, L (1, 2)<br>OBP: 0.299, SLG: 0.522     |   | 0-0<br>1-3                      |                              |                                 | 0-0<br>HR                         |                                 | 0-0<br>1-3<br>2B             |                                 | 0-0<br>1B<br>2B              | 4 1 3 1 0 0 0                    |  |                                  |                              |                                 |                              |                                 |                              |                                 |                                  |                                    |                                  |        |
| Bert Campaneris, R (1, 7)<br>OBP: 0.333, SLG: 0.455 |   | 0-3<br>K                        |                              |                                 | 0-0<br>S<br>1B<br>2B              |                                 | 1-0<br>HBP                   |                                 | 0-0<br>F3                    | 2 1 1 0 0 1 0                    |  |                                  |                              |                                 |                              |                                 |                              |                                 |                                  |                                    |                                  |        |
| Jose Tartabull, L (7, 7)<br>OBP: 0.241, SLG: 0.238  |   | 0-3<br>K                        |                              |                                 | 4-0<br>1B<br>BB                   |                                 | 0-3<br>K                     |                                 | 0-3<br>K                     | 1 0 0 0 0 0 1                    |  |                                  |                              |                                 |                              |                                 |                              |                                 |                                  |                                    |                                  |        |
| Nelson Mathews, R (1, 8)<br>OBP: 0.299, SLG: 0.359  |   | 0-3<br>K                        |                              |                                 | 4-0<br>G1-6-3<br>BB               |                                 | 0-3<br>K                     |                                 | 0-3<br>K                     | 3 0 0 0 1 3 4                    |  |                                  |                              |                                 |                              |                                 |                              |                                 |                                  |                                    |                                  |        |
| Diego Segui, R (1, 1)<br>OBP: 0.234, SLG: 0.250     |   |                                 |                              | 4-0<br>BB                       |                                   | 0-3<br>K                        |                              | 0-3<br>K                        |                              | 3 0 1 0 1 2 2                    |  |                                  |                              |                                 |                              |                                 |                              |                                 |                                  |                                    |                                  |        |
| John Wyatt, R (9, 1)                                |   |                                 |                              |                                 |                                   |                                 |                              |                                 | 0-0<br>2-H<br>1B             | 0 0 0 0 0 0 0                    |  |                                  |                              |                                 |                              |                                 |                              |                                 |                                  |                                    |                                  |        |
| <b>Inning Stats</b>                                 | R: 1<br>E: 0<br>K: 0<br>S: 5                          | H: 2<br>LOB: 1<br>BB: 0<br>P: 5 | R: 0<br>E: 0<br>K: 2<br>S: 7 | H: 0<br>LOB: 0<br>BB: 0<br>P: 7 | R: 0<br>E: 0<br>K: 0<br>S: 2      | H: 0<br>LOB: 0<br>BB: 1<br>P: 6 | R: 0<br>E: 0<br>K: 0<br>S: 3 | H: 0<br>LOB: 0<br>BB: 0<br>P: 3 | R: 2<br>E: 0<br>K: 1<br>S: 7 | H: 3<br>LOB: 1<br>BB: 1<br>P: 11 | R: 0<br>E: 0<br>K: 1<br>S: 6   | H: 1<br>LOB: 3<br>BB: 1<br>P: 11 | R: 0<br>E: 0<br>K: 1<br>S: 5 | H: 0<br>LOB: 0<br>BB: 0<br>P: 5 | R: 0<br>E: 0<br>K: 1<br>S: 5 | H: 1<br>LOB: 0<br>BB: 0<br>P: 5 | R: 0<br>E: 0<br>K: 1<br>S: 6 | H: 2<br>LOB: 2<br>BB: 0<br>P: 6 | 1B: 5<br>2B: 3<br>3B: 0<br>HR: 1 | SF: 1<br>SAC: 1<br>DP: 3<br>HBP: 1 | WP: 0<br>PB: 0<br>SB: 1<br>CS: 0 | PA: 36 |
| <b>PITCHER</b>                                      | IP WLS BF H R ER SO BB IBB HBP BLK WP HR S P ERA WHIP |                                 |                              |                                 |                                   |                                 |                              |                                 |                              |                                  |  |                                  |                              |                                 |                              |                                 |                              |                                 |                                  |                                    |                                  |        |
| Bennie Daniels, R (1, 1)<br>ERA: 4.55               | 4.0 L 17 4 3 3 2 2 0 0 0 0 0 1 19 27 6.75 1.500       |                                 |                              |                                 |                                   |                                 |                              |                                 |                              |                                  |  |                                  |                              |                                 |                              |                                 |                              |                                 |                                  |                                    |                                  |        |
| Steve Ridzik, R (5, 1)<br>ERA: 2.67                 | 3.0 12 2 0 0 3 1 0 1 0 0 0 0 16 21 0.00 1.000         |                                 |                              |                                 |                                   |                                 |                              |                                 |                              |                                  |  |                                  |                              |                                 |                              |                                 |                              |                                 |                                  |                                    |                                  |        |
| Ron Kline, R (8, 1)<br>ERA: 2.08                    | 2.0 7 3 0 0 2 0 0 0 0 0 0 0 11 11 0.00 1.500          |                                 |                              |                                 |                                   |                                 |                              |                                 |                              |                                  |  |                                  |                              |                                 |                              |                                 |                              |                                 |                                  |                                    |                                  |        |

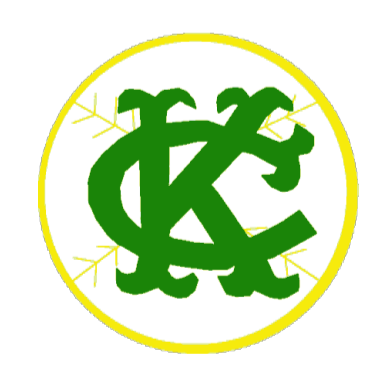

| Batter  | 1               | 2          | 3         | 4            | 5          | 6            | 7          | 8               | 9        | AB R H RBI BB SO LOB  |
|---|-----------------|------------|-----------|--------------|------------|--------------|------------|-----------------|----------|---|
| Ed Brinkman, R (1, 6)<br>OBP: 0.269, SLG: 0.342<br>Chuck Hinton, R (9, PH)<br>OBP: 0.350, SLG: 0.437  | 4-0<br>1B 1B BB |            | 0-3<br>K  |              | 0-0<br>F5  |              | 0-0<br>5-3 |                 | 0-3<br>K | 3 0 0 0 1 1 0<br>1 0 0 0 0 1 2  |
| Don Blasingame, L (1, 4)<br>OBP: 0.317, SLG: 0.320  | 0-0<br>1B 1B    |            | 0-0<br>P4 |              | 0-0<br>F7  |              | 0-0<br>F7  |                 |          | 4 0 1 0 0 0 0   |
| Jim King, L (1, 9)<br>OBP: 0.344, SLG: 0.439  | 0-0<br>F9       |            | 0-0<br>F8 |              |            | 0-0<br>P5    |            | 0-0<br>5-3      |          | 4 0 0 0 0 0 2   |
| Willie Kirkland, L (1, 7)<br>OBP: 0.301, SLG: 0.352   | 0-0<br>F3       |            |           | 0-0<br>F8    |            | 0-0<br>1B 1B |            | 0-3<br>K        |          | 4 1 1 0 0 1 2   |
| Don Lock, R (1, 8)<br>OBP: 0.352, SLG: 0.469  | 0-0<br>1B 1B    |            |           | 0-0<br>1-3   |            | 0-0<br>1B 1B |            | 0-3<br>K        |          | 4 0 2 0 0 1 0   |
| Dick Phillips, L (1, 3)<br>OBP: 0.320, SLG: 0.308   | 0-0<br>3-1      |            |           | 4-0<br>1B BB |            | 0-0<br>1B 1B |            |                 |          | 3 0 2 1 1 0 3   |
| Mike Brumley, L (1, 2)<br>OBP: 0.306, SLG: 0.300  |                 | 0-0<br>6-3 |           | 0-0<br>1B 1B |            | 0-0<br>F8    |            | 0-0<br>SH1-4 1B |          | 4 0 2 0 0 0 2   |
| John Kennedy, R (1, 5)<br>OBP: 0.292, SLG: 0.347  |                 | 0-0<br>F7  |           | 0-0<br>F5    |            | 0-0<br>P6    |            | 0-0<br>SH1-4    |          | 3 0 0 0 0 0 4   |
| Bennie Daniels, L (1, 1)<br>OBP: 0.220, SLG: 0.216<br>Steve Ridzik, R (5, 1)<br>OBP: 0.292, SLG: 0.304<br>Fred Valentine, S (7, PH)<br>OBP: 0.314, SLG: 0.319<br>Ron Kline, R (8, 1)<br>OBP: 0.333, SLG: 0.200<br>Don Zimmer, R (9, PH)<br>OBP: 0.306, SLG: 0.436 |                 | 0-0<br>P5  |           |              | 0-0<br>3-1 |              | 0-0<br>4-3 |                 | 0-3<br>K | 1 0 0 0 0 0 0<br>1 0 0 0 0 0 0<br>1 0 0 0 0 0 0<br>0 0 0 0 0 0 0<br>1 0 0 0 0 1 2 |

| Inning Stats | R: 0<br>E: 0<br>K: 5<br>S: 5 | H: 2<br>LOB: 3<br>BB: 1<br>P: 9 | R: 0<br>E: 0<br>K: 3<br>S: 3 | H: 0<br>LOB: 0<br>BB: 0<br>P: 3 | R: 0<br>E: 0<br>K: 1<br>S: 5 | H: 0<br>LOB: 0<br>BB: 0<br>P: 5 | R: 0<br>E: 0<br>K: 0<br>S: 4 | H: 1<br>LOB: 2<br>BB: 1<br>P: 8 | R: 0<br>E: 0<br>K: 0<br>S: 3 | H: 0<br>LOB: 0<br>BB: 0<br>P: 3 | R: 1<br>E: 0<br>K: 0<br>S: 6 | H: 3<br>LOB: 2<br>BB: 0<br>P: 6 | R: 0<br>E: 0<br>K: 0<br>S: 3 | H: 0<br>LOB: 0<br>BB: 0<br>P: 3 | R: 0<br>E: 0<br>K: 2<br>S: 7 | H: 0<br>LOB: 0<br>BB: 0<br>P: 7 | R: 0<br>E: 0<br>K: 2<br>S: 9 | H: 2<br>LOB: 2<br>BB: 0<br>P: 9 | 1B: 8<br>2B: 0<br>3B: 0<br>HR: 0 | SF: 0<br>SAC: 1<br>DP: 0<br>HBP: 0 |
|--------------|------------------------------|---------------------------------|------------------------------|---------------------------------|------------------------------|---------------------------------|------------------------------|---------------------------------|------------------------------|---------------------------------|------------------------------|---------------------------------|------------------------------|---------------------------------|------------------------------|---------------------------------|------------------------------|---------------------------------|----------------------------------|------------------------------------|
|--------------|------------------------------|---------------------------------|------------------------------|---------------------------------|------------------------------|---------------------------------|------------------------------|---------------------------------|------------------------------|---------------------------------|------------------------------|---------------------------------|------------------------------|---------------------------------|------------------------------|---------------------------------|------------------------------|---------------------------------|----------------------------------|------------------------------------|

| PITCHER                            | IP  | WLS | BF | H | R | ER | SO | BB | IBB | HBP | BLK | WP | HR | S  | P  | ERA  | WHIP  |
|------------------------------------|-----|-----|----|---|---|----|----|----|-----|-----|-----|----|----|----|----|------|-------|
| Diego Segui, R (1, 1)<br>ERA: 4.07 | 8.0 | W   | 33 | 7 | 1 | 1  | 3  | 2  | 0   | 0   | 0   | 0  | 0  | 37 | 45 | 1.12 | 1.125 |
| John Wyatt, R (9, 1)<br>ERA: 3.63  | 1.0 | S   | 4  | 1 | 0 | 0  | 2  | 0  | 0   | 0   | 0   | 0  | 0  | 8  | 8  | 0.00 | 1.000 |

**BOTTOM**

Kansas City Athletics @ Washington Senators  
D.C. Stadium, Washington, DC  
Sun Aug 23 1964, 3:33 AM EDT  
Unknown

|     |    |
|-----|----|
| AB  | 34 |
| R   | 1  |
| H   | 8  |
| RBI | 1  |
| BB  | 2  |
| SO  | 5  |
| LOB | 17 |



|       |        |
|-------|--------|
| WP: 0 | PA: 37 |
| PB: 0 | SB: 0  |
| CS: 0 |        |

| Batter   | 1   | 2                               | 3                            | 4                               | 5  | 6                                 | 7                                     | 8                               | 9                            | AB R H RBI BB SO LOB   | TOP   |                                  |                              |                                  |                              |                                 |                              |                                 |                                  |                                    |                                  |        |
|--|---|---------------------------------|------------------------------|---------------------------------|--|-----------------------------------|---------------------------------------|---------------------------------|------------------------------|--|---|----------------------------------|------------------------------|----------------------------------|------------------------------|---------------------------------|------------------------------|---------------------------------|----------------------------------|------------------------------------|----------------------------------|--------|
| Dick Green, R<br>OBP: 0.307, SLG: 0.386<br>(1, 4) X    | 0-0<br>1-3<br>①                                       |                                 |                              | X 0-0<br>P6<br>①                |  | X 0-0<br>SF7 BB<br>1-2<br>1B<br>① | X 0-0<br>1-3<br>2-H<br>3-H<br>1B<br>① |                                 | X 0-0<br>G4-6-3<br>1B<br>①   | 5 0 3 2 0 0 0  | <b>Kansas City Athletics @ Washington Senators</b><br><b>D.C. Stadium, Washington, DC</b><br>Sun Aug 23 1964, 3:38 AM EDT<br>Att. 5,128 - Unknown |                                  |                              |                                  |                              |                                 |                              |                                 |                                  |                                    |                                  |        |
| Wayne Causey, L<br>OBP: 0.388, SLG: 0.402<br>(1, 6) X  | 0-0<br>3-1<br>②                                       |                                 | X 0-0<br>1-3<br>②            |                                 | B B B B<br>4-0<br>SF7<br>1-2<br>2-3<br>BB<br>② | X 0-0<br>1-2<br>3-H<br>1B<br>②    |                                       | X 0-0<br>G4-6-3<br>1-2f<br>②    | 4 0 1 1 1 0 1                |  |   |                                  |                              |                                  |                              |                                 |                              |                                 |                                  |                                    |                                  |        |
| Ed Charles, R<br>OBP: 0.322, SLG: 0.374<br>(1, 5) X    | 0-0<br>5-3<br>③                                       |                                 | X 0-0<br>P4<br>③             |                                 | X 0-0<br>SF7<br>1-2<br>2-3<br>3-H<br>③         | X 0-0<br>F7<br>③                  |                                       |                                 | 3 0 0 1 0 0 2                |  |   |                                  |                              |                                  |                              |                                 |                              |                                 |                                  |                                    |                                  |        |
| Rocky Colavito, R<br>OBP: 0.356, SLG: 0.539<br>(1, 9)  |   | X 0-0<br>5-3<br>①               |                              | X 0-0<br>F8<br>①                |  | X 0-3<br>K<br>③                   |                                       | X 0-0<br>1B<br>2B<br>①          | 4 0 1 0 0 1 2                |  |   |                                  |                              |                                  |                              |                                 |                              |                                 |                                  |                                    |                                  |        |
| Jim Gentile, L<br>OBP: 0.384, SLG: 0.487<br>(1, 3)     |   | S S S<br>0-3<br>K<br>②          |                              | S S S<br>0-3<br>K<br>②          |  | X 0-0<br>L4<br>①                  |                                       | X 0-0<br>2-3<br>1B<br>①         | 4 0 1 0 0 2 0                |  |   |                                  |                              |                                  |                              |                                 |                              |                                 |                                  |                                    |                                  |        |
| Doc Edwards, R<br>OBP: 0.248, SLG: 0.298<br>(1, 2)     |   | X 0-0<br>5-3<br>③               |                              | X 0-0<br>HR<br>③                |  | X 0-0<br>6-3<br>②                 |                                       | X 0-0<br>F5<br>①                | 4 1 1 1 0 0 2                |  |   |                                  |                              |                                  |                              |                                 |                              |                                 |                                  |                                    |                                  |        |
| Bert Campaneris, R<br>OBP: 0.339, SLG: 0.456<br>(1, 7) |   |                                 | X 0-0<br>G5-6-3<br>1B<br>②   |                                 | X 0-0<br>6-3<br>③                              |                                   | X 0-0<br>WP<br>E<br>1B<br>1B<br>②     |                                 | X 0-0<br>F2<br>②             | 4 1 2 0 0 0 2  |   |                                  |                              |                                  |                              |                                 |                              |                                 |                                  |                                    |                                  |        |
| Nelson Mathews, R<br>OBP: 0.299, SLG: 0.358<br>(1, 8)  |   |                                 | X 0-0<br>G5-6-3<br>1-2f<br>② |                                 | X 0-0<br>BB<br>SF7<br>1B<br>1B<br>①            |                                   | X 0-0<br>E6<br>WP<br>1B<br>③          |                                 | X 0-3<br>K<br>③              | 4 2 1 0 0 1 4  |   |                                  |                              |                                  |                              |                                 |                              |                                 |                                  |                                    |                                  |        |
| Jose Santiago, R<br>(1, 1)                             |   |                                 | X 0-0<br>1-3<br>③            |                                 | X 0-0<br>F9<br>①                               |                                   | X 4-0<br>1-2<br>2-3<br>1B<br>BB<br>①  |                                 | S S S S<br>0-3<br>K<br>①     | 1 0 0 0 0 0 0 0<br>0 0 0 0 0 0 0 0<br>0 0 0 0 0 0 0 0<br>1 0 0 0 0 0 0 1<br>0 0 0 0 0 0 0 0<br>0 0 1 0 0 1 0 0<br>0 0 0 0 0 0 0 0<br>1 0 0 0 0 0 1 0 |   |                                  |                              |                                  |                              |                                 |                              |                                 |                                  |                                    |                                  |        |
| Ted Bowsfield, R<br>OBP: 0.174, SLG: 0.095<br>(4, 1)   |   |                                 |                              |                                 |  |                                   |                                       |                                 |                              |  |   |                                  |                              |                                  |                              |                                 |                              |                                 |                                  |                                    |                                  |        |
| Ken Sanders, R<br>(4, 1)                               |   |                                 |                              |                                 |  |                                   |                                       |                                 |                              |  |   |                                  |                              |                                  |                              |                                 |                              |                                 |                                  |                                    |                                  |        |
| George Alusik, R<br>OBP: 0.348, SLG: 0.354<br>(6, PH)  |   |                                 |                              |                                 |  |                                   |                                       |                                 |                              |  |   |                                  |                              |                                  |                              |                                 |                              |                                 |                                  |                                    |                                  |        |
| Moe Drabowsky, R<br>OBP: 0.025, SLG: 0.025<br>(6, 1)   |   |                                 |                              |                                 |  |                                   |                                       |                                 |                              |  |   |                                  |                              |                                  |                              |                                 |                              |                                 |                                  |                                    |                                  |        |
| Manny Jimenez, L<br>OBP: 0.300, SLG: 0.473<br>(7, PH)  |   |                                 |                              |                                 |  |                                   |                                       |                                 |                              |  |   |                                  |                              |                                  |                              |                                 |                              |                                 |                                  |                                    |                                  |        |
| John Wyatt, R<br>(7, 1)                                |   |                                 |                              |                                 |  |                                   |                                       |                                 |                              |  |   |                                  |                              |                                  |                              |                                 |                              |                                 |                                  |                                    |                                  |        |
| Jose Tartabull, L<br>OBP: 0.236, SLG: 0.235<br>(9, PH) |   |                                 |                              |                                 |  |                                   |                                       |                                 |                              |  |   |                                  |                              |                                  |                              |                                 |                              |                                 |                                  |                                    |                                  |        |
| <b>Inning Stats</b>                                    | R: 0<br>E: 0<br>K: 0<br>S: 3                          | H: 0<br>LOB: 0<br>BB: 0<br>P: 3 | R: 0<br>E: 0<br>K: 1<br>S: 5 | H: 0<br>LOB: 0<br>BB: 0<br>P: 5 | R: 0<br>E: 0<br>K: 0<br>S: 3                   | H: 1<br>LOB: 0<br>BB: 0<br>P: 3   | R: 0<br>E: 0<br>K: 0<br>S: 3          | H: 0<br>LOB: 0<br>BB: 0<br>P: 3 | R: 1<br>E: 0<br>K: 1<br>S: 6 | H: 1<br>LOB: 0<br>BB: 0<br>P: 6  | R: 1<br>E: 0<br>K: 1<br>S: 7  | H: 2<br>LOB: 2<br>BB: 1<br>P: 11 | R: 3<br>E: 1<br>K: 0<br>S: 7 | H: 3<br>LOB: 2<br>BB: 1<br>P: 11 | R: 0<br>E: 0<br>K: 1<br>S: 7 | H: 2<br>LOB: 2<br>BB: 0<br>P: 7 | R: 0<br>E: 0<br>K: 1<br>S: 5 | H: 1<br>LOB: 0<br>BB: 0<br>P: 5 | 1B: 8<br>2B: 1<br>3B: 0<br>HR: 1 | SF: 1<br>SAC: 0<br>DP: 2<br>HBP: 0 | WP: 1<br>PB: 0<br>SB: 0<br>CS: 0 | PA: 38 |
| <b>PITCHER</b>   | IP WLS BF H R ER SO BB IBB HBP BLK WP HR S P ERA WHIP |                                 |                              |                                 |  |                                   |                                       |                                 |                              |  |   |                                  |                              |                                  |                              |                                 |                              |                                 |                                  |                                    |                                  |        |
| Frank Kreuzer, L<br>ERA: 4.28<br>(1, 1)                | 5.1 W 20 4 2 2 2 1 0 0 0 0 1 23 27 3.38 0.938         |                                 |                              |                                 |  |                                   |                                       |                                 |                              |  |   |                                  |                              |                                  |                              |                                 |                              |                                 |                                  |                                    |                                  |        |
| Jim Hannan, R<br>ERA: 3.56<br>(6, 1)                   | 1.1 8 2 3 0 1 1 0 0 0 0 1 9 13 0.00 2.250             |                                 |                              |                                 |  |                                   |                                       |                                 |                              |  |   |                                  |                              |                                  |                              |                                 |                              |                                 |                                  |                                    |                                  |        |
| Ron Kline, R<br>ERA: 2.0<br>(7, 1)                     | 2.1 S 10 4 0 0 2 0 0 0 0 0 0 14 14 0.00 1.714         |                                 |                              |                                 |  |                                   |                                       |                                 |                              |  |   |                                  |                              |                                  |                              |                                 |                              |                                 |                                  |                                    |                                  |        |

livebaseballscorecards.com

|     |    |
|-----|----|
| AB  | 35 |
| R   | 5  |
| H   | 10 |
| RBI | 5  |
| BB  | 2  |
| SO  | 5  |
| LOB | 14 |



| Batter  | 1          | 2          | 3         | 4                  | 5          | 6          | 7               | 8            | 9 |
|---|------------|------------|-----------|--------------------|------------|------------|-----------------|--------------|---|
| Don Blasingame, L (1, 4)<br>OBP: 0.317, SLG: 0.322<br>Chuck Cottier, R (7, 4)<br>OBP: 0.264, SLG: 0.330   | 0-0<br>4-3 |            | 0-0<br>E3 | 0-0<br>1B 2B       |            | 0-0<br>P4  |                 | 0-0<br>1B    |   |
| Joe Cunningham, L (1, 3)<br>OBP: 0.350, SLG: 0.281  | 1-0<br>HBP |            | 0-3<br>K  | 0-3<br>K           |            | 0-0<br>5-3 |                 | 0-0<br>F8    |   |
| Chuck Hinton, R (1, 7)<br>OBP: 0.350, SLG: 0.436  | 0-0<br>P6  |            | 0-0<br>1B | 4-0<br>1B IBB      |            | 0-0<br>F9  |                 | 0-0<br>P4    |   |
| Willie Kirkland, L (1, 9)<br>OBP: 0.305, SLG: 0.371   | 0-0<br>F2  |            | 0-0<br>L6 | 0-0<br>FC6-4 1B    |            | 0-0<br>HR  |                 |              |   |
| Don Lock, R (1, 8)<br>OBP: 0.353, SLG: 0.466  |            | 0-0<br>6-3 |           | 0-0<br>FC6-4 1B    |            | 4-0<br>BB  |                 |              |   |
| Don Zimmer, R (1, 5)<br>OBP: 0.309, SLG: 0.439<br>John Kennedy, R (8, 5)<br>OBP: 0.292, SLG: 0.347  |            | 0-0<br>2B  |           | 4-0<br>1B BB       | 0-0<br>5-3 |            | 0-3<br>K        |              |   |
| Mike Brumley, L (1, 2)<br>OBP: 0.308, SLG: 0.303  |            | 0-0<br>2B  |           | 4-0<br>E 1B BB     | 0-0<br>6-3 |            | 0-0<br>P6       |              |   |
| Ed Brinkman, R (1, 6)<br>OBP: 0.271, SLG: 0.344   |            | 0-0<br>6-3 |           | 0-0<br>E7 FC6-2 1B | 0-3<br>K   |            | 0-0<br>SH1-4 1B |              |   |
| Frank Kreutzer, R (1, 1)<br>OBP: 0.083, SLG: 0.167<br>Jim Hannan, R (6, 1)<br>OBP: 0.143, SLG: 0.150<br>Ron Kline, R (7, 1)<br>OBP: 0.333, SLG: 0.200 |            | 0-0<br>F9  |           | 0-0<br>FC6-2 1B    |            | 0-3<br>K   |                 | 0-0<br>SH1-4 |   |

| Inning Stats | R: 0 | H: 0 | E: 0 | K: 0 | S: 3 | R: 1 | H: 2 | E: 0 | K: 0 | S: 5 | R: 0 | H: 1 | E: 1 | K: 1 | S: 6 | R: 5 | H: 3 | E: 1 | K: 1 | S: 8 | R: 0 | H: 0 | E: 0 | K: 1 | S: 5 | R: 1 | H: 1 | E: 0 | K: 1 | S: 6 | R: 1 | H: 2 | E: 1 | K: 0 | S: 5 |   |   |   |
|--------------|------|------|------|------|------|------|------|------|------|------|------|------|------|------|------|------|------|------|------|------|------|------|------|------|------|------|------|------|------|------|------|------|------|------|------|---|---|---|
|              | 0    | 0    | 0    | 0    | 3    | 1    | 2    | 0    | 0    | 5    | 0    | 1    | 1    | 1    | 6    | 3    | 3    | 0    | 1    | 6    | 0    | 0    | 0    | 1    | 5    | 1    | 1    | 0    | 1    | 10   | 2    | 2    | 1    | 5    | 1    | 2 | 0 | 5 |

| PITCHER                              | IP  | WLS | BF | H | R | ER | SO | BB | IBB | HBP | BLK | WP | HR | S  | P  | ERA   | WHIP  |
|--------------------------------------|-----|-----|----|---|---|----|----|----|-----|-----|-----|----|----|----|----|-------|-------|
| Jose Santiago, R (1, 1)<br>ERA: 5.18 | 3.0 | L   | 16 | 3 | 4 | 4  | 1  | 3  | 0   | 1   | 0   | 0  | 0  | 14 | 27 | 12.00 | 2.000 |
| Ted Bowsfield, L (4, 1)<br>ERA: 4.26 | 0.2 |     | 6  | 3 | 2 | 2  | 1  | 0  | 1   | 0   | 0   | 0  | 0  | 7  | 11 | 27.00 | 4.500 |
| Ken Sanders, R (4, 1)<br>ERA: 2.38   | 1.1 |     | 4  | 0 | 0 | 0  | 1  | 0  | 0   | 0   | 0   | 0  | 0  | 6  | 6  | 0.00  | 0.000 |
| Moe Drabowsky, R (6, 1)<br>ERA: 5.4  | 1.0 |     | 3  | 0 | 0 | 0  | 1  | 0  | 0   | 0   | 0   | 0  | 0  | 5  | 5  | 0.00  | 0.000 |
| John Wyatt, R (7, 1)<br>ERA: 3.74    | 2.0 |     | 10 | 3 | 2 | 2  | 1  | 1  | 0   | 0   | 0   | 0  | 1  | 11 | 15 | 9.00  | 2.000 |

**BOTTOM**

| AB | R | H | RBI | BB | SO | LOB |
|----|---|---|-----|----|----|-----|
| 4  | 1 | 1 | 1   | 0  | 0  | 0   |
| 1  | 0 | 1 | 1   | 0  | 0  | 0   |
| 4  | 0 | 0 | 0   | 0  | 2  | 4   |
| 4  | 0 | 1 | 0   | 1  | 0  | 2   |
| 4  | 1 | 2 | 3   | 0  | 0  | 2   |
| 2  | 1 | 0 | 0   | 2  | 0  | 2   |
| 3  | 2 | 1 | 0   | 1  | 1  | 1   |
| 0  | 0 | 0 | 0   | 0  | 0  | 0   |
| 3  | 0 | 1 | 1   | 1  | 0  | 1   |
| 4  | 2 | 2 | 2   | 0  | 1  | 1   |
| 2  | 1 | 0 | 0   | 0  | 0  | 3   |
| 1  | 0 | 0 | 0   | 0  | 1  | 0   |
| 0  | 0 | 0 | 0   | 0  | 0  | 0   |

**AB 32**  
**R 8**  
**H 9**  
**RBI 8**  
**BB 5**  
**SO 5**  
**LOB 16**



**Kansas City Athletics @ Washington Senators**  
**D.C. Stadium, Washington, DC**  
 Sun Aug 23 1964, 3:38 AM EDT  
 Att. 5,128 - Unknown

| WP | PA |
|----|----|
| 0  | 39 |

| Batter  | 1                            | 2                               | 3                            | 4                               | 5                            | 6                               | 7                            | 8                               | 9                             | AB                               | R                            | H                               | RBI                          | BB                              | SO                           | LOB                             | TOP                          |                                 |                                  |                                    |                                  |        |  |  |  |
|---|------------------------------|---------------------------------|------------------------------|---------------------------------|------------------------------|---------------------------------|------------------------------|---------------------------------|-------------------------------|----------------------------------|------------------------------|---------------------------------|------------------------------|---------------------------------|------------------------------|---------------------------------|------------------------------|---------------------------------|----------------------------------|------------------------------------|----------------------------------|--------|--|--|--|
| Albie Pearson, L<br>OBP: 0.308, SLG: 0.264<br>(1, 7) BB<br>(5, 8) BB  | 4-0<br>BB<br>G6-4-3          |                                 | 0-3<br>K                     |                                 | 0-0<br>BB<br>1B<br>1B        |                                 | 0-0<br>4-3                   |                                 |                               | 3                                | 1                            | 1                               | 1                            | 1                               | 1                            | 1                               |                              |                                 |                                  |                                    |                                  |        |  |  |  |
| Jim Piersall, R<br>OBP: 0.350, SLG: 0.373<br>Willie Smith, L<br>OBP: 0.309, SLG: 0.449<br>(1, 8) X<br>(5, PH)<br>(5, 7) | 0-0<br>G6-4-3<br>1-2f        |                                 |                              | 0-0<br>F2                       | 0-0<br>1B<br>BB<br>1B        |                                 | 0-0<br>F8                    |                                 |                               | 2                                | 0                            | 0                               | 0                            | 0                               | 0                            | 1                               |                              |                                 |                                  |                                    |                                  |        |  |  |  |
| Jim Fregosi, R<br>OBP: 0.386, SLG: 0.494<br>(1, 6) X  | 0-0<br>F7                    |                                 |                              | 0-0<br>L8                       | 0-3<br>K                     |                                 | 0-0<br>L9                    |                                 |                               | 4                                | 0                            | 0                               | 0                            | 0                               | 1                            | 3                               |                              |                                 |                                  |                                    |                                  |        |  |  |  |
| Joe Adcock, R<br>OBP: 0.354, SLG: 0.473<br>Vic Power, R<br>OBP: 0.270, SLG: 0.317<br>(1, 3)<br>(8, 3)                   |                              | 0-0<br>5-3                      |                              | 0-0<br>5-3                      | 4-0<br>1B<br>BB              |                                 | 0-0<br>F8                    |                                 |                               | 3                                | 0                            | 0                               | 1                            | 1                               | 0                            | 0                               |                              |                                 |                                  |                                    |                                  |        |  |  |  |
| Lou Clinton, R<br>OBP: 0.299, SLG: 0.380<br>(1, 9) X  |                              | 0-0<br>F2                       |                              |                                 | WP<br>BB                     |                                 | 0-0<br>1-3                   |                                 |                               | 3                                | 1                            | 1                               | 1                            | 1                               | 0                            | 0                               |                              |                                 |                                  |                                    |                                  |        |  |  |  |
| Felix Torres, R<br>OBP: 0.258, SLG: 0.415<br>(1, 5) X   |                              | 0-0<br>6-3                      |                              |                                 | WP<br>1B<br>2B               |                                 | 0-0<br>4-3                   |                                 |                               | 4                                | 1                            | 1                               | 0                            | 0                               | 0                            | 3                               |                              |                                 |                                  |                                    |                                  |        |  |  |  |
| Buck Rodgers, S<br>OBP: 0.301, SLG: 0.310<br>(1, 2) X   |                              |                                 | 0-0<br>CS<br>1B              |                                 | 0-0<br>F3<br>2-3<br>3-H      | 0-0<br>F7                       |                              | 0-0<br>F6                       |                               | 4                                | 0                            | 1                               | 0                            | 0                               | 0                            | 1                               |                              |                                 |                                  |                                    |                                  |        |  |  |  |
| Bobby Knoop, R<br>OBP: 0.287, SLG: 0.270<br>(1, 4) X  |                              |                                 | 0-0<br>F9<br>1-2             |                                 | 0-0<br>1B<br>1B              | 0-0<br>F8                       |                              | 0-3<br>K                        |                               | 4                                | 1                            | 1                               | 1                            | 0                               | 1                            | 1                               |                              |                                 |                                  |                                    |                                  |        |  |  |  |
| Dean Chance, R<br>OBP: 0.134, SLG: 0.094<br>Bob Lee, R<br>(1, 1)<br>(7, 1) X  |                              |                                 | 0-0<br>1B                    |                                 | 0-0<br>1B<br>BB<br>1B        | 0-3<br>K                        |                              | 0-3<br>K                        |                               | 3                                | 1                            | 2                               | 0                            | 0                               | 1                            | 0                               |                              |                                 |                                  |                                    |                                  |        |  |  |  |
|   |                              |                                 |                              |                                 |                              |                                 |                              |                                 |                               | 1                                | 0                            | 0                               | 0                            | 0                               | 1                            | 0                               |                              |                                 |                                  |                                    |                                  |        |  |  |  |
| <b>Inning Stats</b>   | R: 0<br>E: 0<br>K: 0<br>S: 2 | H: 0<br>LOB: 0<br>BB: 1<br>P: 6 | R: 0<br>E: 0<br>K: 0<br>S: 3 | H: 0<br>LOB: 0<br>BB: 0<br>P: 3 | R: 0<br>E: 0<br>K: 1<br>S: 6 | H: 2<br>LOB: 1<br>BB: 0<br>P: 6 | R: 0<br>E: 0<br>K: 0<br>S: 3 | H: 0<br>LOB: 0<br>BB: 0<br>P: 3 | R: 5<br>E: 0<br>K: 1<br>S: 11 | H: 6<br>LOB: 3<br>BB: 2<br>P: 19 | R: 0<br>E: 0<br>K: 1<br>S: 5 | H: 0<br>LOB: 0<br>BB: 0<br>P: 5 | R: 0<br>E: 0<br>K: 0<br>S: 3 | H: 0<br>LOB: 0<br>BB: 0<br>P: 3 | R: 0<br>E: 0<br>K: 0<br>S: 3 | H: 0<br>LOB: 0<br>BB: 0<br>P: 3 | R: 0<br>E: 0<br>K: 2<br>S: 7 | H: 0<br>LOB: 0<br>BB: 0<br>P: 7 | 1B: 7<br>2B: 1<br>3B: 0<br>HR: 0 | SF: 0<br>SAC: 0<br>DP: 1<br>HBP: 0 | WP: 1<br>PB: 0<br>SB: 0<br>CS: 1 | PA: 36 |  |  |  |
| <b>PITCHER</b>  | IP                           | WLS                             | BF                           | H                               | R                            | ER                              | SO                           | BB                              | IBB                           | HBP                              | BLK                          | WP                              | HR                           | S                               | P                            | ERA                             | WHIP                         |                                 |                                  |                                    |                                  |        |  |  |  |
| Bob Meyer, L<br>ERA: 4.91<br>(1, 1)   | 4.1                          | L                               | 19                           | 6                               | 5                            | 5                               | 1                            | 2                               | 0                             | 0                                | 0                            | 1                               | 0                            | 19                              | 27                           | 10.38                           | 1.846                        |                                 |                                  |                                    |                                  |        |  |  |  |
| Ken Sanders, R<br>ERA: 2.25<br>(5, 1)   | 0.2                          |                                 | 5                            | 2                               | 0                            | 0                               | 1                            | 1                               | 0                             | 0                                | 0                            | 0                               | 0                            | 6                               | 10                           | 0.00                            | 4.500                        |                                 |                                  |                                    |                                  |        |  |  |  |
| Moe Drabowsky, R<br>ERA: 5.32<br>(6, 1)   | 2.0                          |                                 | 6                            | 0                               | 0                            | 0                               | 1                            | 0                               | 0                             | 0                                | 0                            | 0                               | 0                            | 8                               | 8                            | 0.00                            | 0.000                        |                                 |                                  |                                    |                                  |        |  |  |  |
| Wes Stock, R<br>ERA: 2.35<br>(8, 1)   | 2.0                          |                                 | 6                            | 0                               | 0                            | 0                               | 2                            | 0                               | 0                             | 0                                | 0                            | 0                               | 0                            | 10                              | 10                           | 0.00                            | 0.000                        |                                 |                                  |                                    |                                  |        |  |  |  |

Los Angeles Angels @ Kansas City Athletics  
Municipal Stadium, Kansas City, MO  
Tue Aug 25 1964, 8:05 PM EDT  
Att. 4,749 - Unknown

livebaseballscorecards.com

|     |    |
|-----|----|
| AB  | 33 |
| R   | 5  |
| H   | 8  |
| RBI | 4  |
| BB  | 3  |
| SO  | 5  |
| LOB | 10 |





| Batter   | 1   | 2                               | 3                            | 4                               | 5                            | 6                               | 7                             | 8                                | 9                            | AB R H RBI BB SO LOB   | TOP  |                                 |                              |                                 |                              |                                 |                              |                                  |                                  |                                    |                                  |        |
|--|---|---------------------------------|------------------------------|---------------------------------|------------------------------|---------------------------------|-------------------------------|----------------------------------|------------------------------|--|--|---------------------------------|------------------------------|---------------------------------|------------------------------|---------------------------------|------------------------------|----------------------------------|----------------------------------|------------------------------------|----------------------------------|--------|
| Jim Piersall, R (1, 7)<br>OBP: 0.346, SLG: 0.369   | 0-0<br>4-3  |                                 | 0-0<br>F4                    |                                 | 0-0<br>SH3-4 WP<br>SF7<br>1B |                                 | 0-3<br>K                      |                                  | 0-3<br>K                     | 5 1 1 0 0 2 2  | <b>Los Angeles Angels @ Kansas City Athletics</b><br><b>Municipal Stadium, Kansas City, MO</b><br>Wed Aug 26 1964, 8:05 PM EDT<br>Att. 4,170 - Unknown |                                 |                              |                                 |                              |                                 |                              |                                  |                                  |                                    |                                  |        |
| Vic Power, R (1, 4)<br>OBP: 0.266, SLG: 0.313<br>(8, 3)  | 0-0<br>F3   |                                 | 0-0<br>6-3                   |                                 | 0-0<br>SH3-4<br>1-3          |                                 |                               | 0-0<br>5-3                       |                              | 3 0 0 0 0 0 0  |  |                                 |                              |                                 |                              |                                 |                              |                                  |                                  |                                    |                                  |        |
| Jim Fregosi, R (1, 6)<br>OBP: 0.387, SLG: 0.495  | 0-0<br>1B<br>1B                                       |                                 |                              | 0-0<br>1B<br>1B                 | 0-0<br>SF7<br>3-H            |                                 |                               | 0-0<br>5-3                       |                              | 3 1 2 1 0 0 0  |  |                                 |                              |                                 |                              |                                 |                              |                                  |                                  |                                    |                                  |        |
| Joe Adcock, R (1, 3)<br>OBP: 0.356, SLG: 0.474<br>Bobby Knoop, R (8, 4)<br>OBP: 0.287, SLG: 0.270  | 0-0<br>1-2<br>1B                                      |                                 |                              | 0-0<br>1-2<br>1B<br>1B          | 0-3<br>K                     |                                 |                               | 0-0<br>F3                        |                              | 4 1 2 0 0 1 0<br>0 0 0 0 0 0 0                                   |  |                                 |                              |                                 |                              |                                 |                              |                                  |                                  |                                    |                                  |        |
| Felix Torres, R (1, 5)<br>OBP: 0.258, SLG: 0.426   | 0-0<br>5-3  |                                 |                              | 0-3<br>K                        |                              | 0-3<br>K                        |                               | 0-0<br>HR                        |                              | 4 1 1 1 0 2 4  |  |                                 |                              |                                 |                              |                                 |                              |                                  |                                  |                                    |                                  |        |
| Lou Clinton, R (1, 9)<br>OBP: 0.302, SLG: 0.382  |   | 0-0<br>4-3                      |                              | 0-0<br>1-2<br>2-H<br>SF8<br>1B  |                              | 0-0<br>L9                       |                               | 0-0<br>SH5-3<br>1B               |                              | 4 1 2 1 0 0 0  |  |                                 |                              |                                 |                              |                                 |                              |                                  |                                  |                                    |                                  |        |
| Bob Perry, R (1, 8)<br>OBP: 0.317, SLG: 0.365  |   | 0-3<br>K                        |                              | 0-0<br>1-3<br>2-H<br>1B         |                              | 0-0<br>F4                       |                               | 0-0<br>SH5-3                     |                              | 3 0 1 1 0 1 0  |  |                                 |                              |                                 |                              |                                 |                              |                                  |                                  |                                    |                                  |        |
| Buck Rodgers, S (1, 2)<br>OBP: 0.301, SLG: 0.308   |   | 0-0<br>4-3                      |                              | 0-0<br>SF8<br>3-H               |                              | 0-0<br>F7                       |                               | 4-0<br>IBB                       |                              | 2 0 0 1 1 0 0  |  |                                 |                              |                                 |                              |                                 |                              |                                  |                                  |                                    |                                  |        |
| Aubrey Gatewood, R (1, 1)<br>OBP: 0.133, SLG: 0.133<br>Barry Latman, R (4, 1)<br>OBP: 0.135, SLG: 0.189<br>Willie Smith, L (9, PH)<br>OBP: 0.308, SLG: 0.447<br>Bob Duliba, R (9, 1) |   |                                 | 0-3<br>K                     | 0-3<br>K                        |                              | 0-0<br>4-3                      |                               | 0-0<br>L9                        |                              | 2 0 0 0 0 2 1<br>1 0 0 0 0 0 0<br>1 0 0 0 0 0 2<br>0 0 0 0 0 0 0 |  |                                 |                              |                                 |                              |                                 |                              |                                  |                                  |                                    |                                  |        |
| <b>Inning Stats</b>  | R: 0<br>E: 0<br>K: 0<br>S: 5                          | H: 2<br>LOB: 2<br>BB: 0<br>P: 5 | R: 0<br>E: 0<br>K: 1<br>S: 5 | H: 0<br>LOB: 0<br>BB: 0<br>P: 5 | R: 0<br>E: 0<br>K: 1<br>S: 5 | H: 0<br>LOB: 0<br>BB: 0<br>P: 5 | R: 3<br>E: 0<br>K: 2<br>S: 11 | H: 4<br>LOB: 1<br>BB: 0<br>P: 11 | R: 1<br>E: 0<br>K: 1<br>S: 6 | H: 1<br>LOB: 0<br>BB: 0<br>P: 6                                  | R: 0<br>E: 0<br>K: 1<br>S: 5   | H: 0<br>LOB: 0<br>BB: 0<br>P: 5 | R: 0<br>E: 0<br>K: 1<br>S: 5 | H: 0<br>LOB: 0<br>BB: 0<br>P: 5 | R: 0<br>E: 0<br>K: 0<br>S: 3 | H: 0<br>LOB: 0<br>BB: 0<br>P: 3 | R: 1<br>E: 0<br>K: 1<br>S: 7 | H: 2<br>LOB: 2<br>BB: 1<br>P: 11 | 1B: 8<br>2B: 0<br>3B: 0<br>HR: 1 | SF: 2<br>SAC: 2<br>DP: 0<br>HBP: 0 | WP: 1<br>PB: 0<br>SB: 0<br>CS: 0 | PA: 37 |
| <b>PITCHER</b>   | IP WLS BF H R ER SO BB IBB HBP BLK WP HR S P ERA WHIP |                                 |                              |                                 |                              |                                 |                               |                                  |                              |  |  |                                 |                              |                                 |                              |                                 |                              |                                  |                                  |                                    |                                  |        |
| John O'Donoghue, L (1, 1)<br>ERA: 4.52   | 4.0 L 18 6 3 3 4 0 0 0 0 0 0 0 26 26 6.75 1.500       |                                 |                              |                                 |                              |                                 |                               |                                  |                              |  |  |                                 |                              |                                 |                              |                                 |                              |                                  |                                  |                                    |                                  |        |
| Moe Drabowsky, R (5, 1)<br>ERA: 5.27   | 3.0 10 1 1 1 3 0 0 0 0 1 0 16 16 3.00 0.333           |                                 |                              |                                 |                              |                                 |                               |                                  |                              |  |  |                                 |                              |                                 |                              |                                 |                              |                                  |                                  |                                    |                                  |        |
| Ted Bowsfield, L (8, 1)<br>ERA: 4.28   | 1.2 8 2 1 1 0 0 0 1 0 0 1 7 11 5.40 1.200             |                                 |                              |                                 |                              |                                 |                               |                                  |                              |  |  |                                 |                              |                                 |                              |                                 |                              |                                  |                                  |                                    |                                  |        |
| Ken Sanders, R (9, 1)<br>ERA: 2.19   | 0.1 1 0 0 0 1 0 0 0 0 0 0 3 3 0.00 0.000              |                                 |                              |                                 |                              |                                 |                               |                                  |                              |  |  |                                 |                              |                                 |                              |                                 |                              |                                  |                                  |                                    |                                  |        |

livebaseballscorecards.com

|            |    |
|------------|----|
| <b>AB</b>  | 32 |
| <b>R</b>   | 5  |
| <b>H</b>   | 9  |
| <b>RBI</b> | 5  |
| <b>BB</b>  | 1  |
| <b>SO</b>  | 8  |
| <b>LOB</b> | 9  |





| Batter  | 1                  | 2         | 3               | 4         | 5              | 6 | 7      | 8      | 9      | AB R H RBI BB SO LOB |
|---|--------------------|-----------|-----------------|-----------|----------------|---|--------|--------|--------|----------------------|
| Dick Green, R (1, 4)<br>OBP: 0.306, SLG: 0.391      | 0-3 K              | 0-0 F6    |                 |           | 0-0 L4-3 1B    |   | 0-0 HR |        | 0-0 F7 | 5 1 2 1 0 1 3        |
| Wayne Causey, L (1, 6)<br>OBP: 0.389, SLG: 0.405    | 0-0 FC6-4 1B       |           | 0-0 G6-4-3 1B   |           | 0-0 L4-3 1-2   |   | 0-0 L8 |        |        | 4 0 2 0 0 0 1        |
| Ed Charles, R (1, 5)<br>OBP: 0.321, SLG: 0.370      | 0-0 FC6-4 1B       |           | 0-0 G6-4-3 1-2f |           | 0-3 K          |   |        | 0-0 F8 |        | 4 0 1 0 0 1 1        |
| Rocky Colavito, R (1, 9)<br>OBP: 0.358, SLG: 0.543  | 0-0 FC6-4 1-2f 2-3 |           | 0-0 L7          |           | 1-0 FC6-4 HBP  |   |        | 0-0 HR |        | 3 1 1 1 0 0 2        |
| Jim Gentile, L (1, 3)<br>OBP: 0.379, SLG: 0.479     | 0-3 K              |           |                 | 0-0 1B 1B | 0-0 F6         |   |        | 0-0 F8 |        | 4 0 1 0 0 1 3        |
| Billy Bryan, L (1, 2)<br>OBP: 0.296, SLG: 0.509     |                    | 0-3 K     |                 | 0-0 F5    | 0-3 K          |   |        | 0-0 F7 |        | 4 0 0 0 0 2 2        |
| Bert Campaneris, R (1, 7)<br>OBP: 0.348, SLG: 0.471 |                    | 0-0 6-3   |                 | 0-0 1B    | 0-0 FC6-4 1-2f |   |        | 0-0 L8 |        | 4 0 1 0 0 0 1        |
| Nelson Mathews, R (1, 8)<br>OBP: 0.296, SLG: 0.354  |                    | 0-0 1B 1B |                 | 0-3 K     | 0-3 K          |   | 0-3 K  | 0-0 F2 |        | 4 0 1 0 0 2 2        |
| John O'Donoghue, R (1, 1)<br>OBP: 0.209, SLG: 0.279 |                    | 0-0 1B    |                 | 0-0 F8    | 0-0 5-3        |   |        | 0-0 1B |        | 1 0 1 0 0 0 0        |
| Manny Jimenez, L (4, PH)<br>OBP: 0.302, SLG: 0.473  |                    |           |                 |           |                |   |        |        |        | 1 0 0 0 0 0 2        |
| Moe Drabowsky, R (5, 1)<br>OBP: 0.025, SLG: 0.025   |                    |           |                 |           |                |   |        |        |        | 0 0 0 0 0 0 0        |
| Ken Harrelson, R (7, PH)<br>OBP: 0.234, SLG: 0.324  |                    |           |                 |           |                |   |        |        |        | 1 0 0 0 0 0 0        |
| Ted Bowsfield, R (8, 1)<br>OBP: 0.174, SLG: 0.095   |                    |           |                 |           |                |   |        |        |        | 0 0 0 0 0 0 0        |
| Ken Sanders, R (9, 1)                               |                    |           |                 |           |                |   |        |        |        | 0 0 0 0 0 0 0        |
| Jose Tartabull, L (9, PH)<br>OBP: 0.244, SLG: 0.241 |                    | 1-3 1B    |                 |           |                |   |        |        |        | 1 0 1 0 0 0 0        |

**BOTTOM**

**Los Angeles Angels @ Kansas City Athletics**  
**Municipal Stadium, Kansas City, MO**  
 Wed Aug 26 1964, 8:05 PM EDT  
 Att. 4,170 - Unknown

|     |    |
|-----|----|
| AB  | 36 |
| R   | 2  |
| H   | 11 |
| RBI | 2  |
| BB  | 0  |
| SO  | 7  |
| LOB | 17 |



| Inning Stats | R: 0 | H: 2 | E: 0 | K: 2 | S: 9 | H: 2 | LOB: 2 | BB: 0 | P: 9 | R: 0 | H: 1 | E: 0 | K: 1 | S: 7 | H: 2 | LOB: 2 | BB: 0 | P: 7 | R: 0 | H: 2 | E: 0 | K: 1 | S: 7 | R: 0 | H: 1 | E: 0 | K: 1 | S: 5 | H: 0 | LOB: 1 | BB: 0 | P: 6 | R: 1 | H: 1 | E: 0 | K: 1 | S: 6 | H: 1 | LOB: 0 | BB: 0 | P: 6 | R: 1 | H: 1 | E: 0 | K: 0 | S: 4 | H: 1 | LOB: 0 | BB: 0 | P: 4 | R: 0 | H: 1 | E: 0 | K: 0 | S: 4 | H: 1 | LOB: 1 | BB: 0 | P: 4 | 1B: 9 | SF: 0 | 2B: 1 | SAC: 0 | 3B: 0 | DP: 2 | HR: 2 | HBP: 1 | WP: 0 | PA: 37 |
|--------------|------|------|------|------|------|------|--------|-------|------|------|------|------|------|------|------|--------|-------|------|------|------|------|------|------|------|------|------|------|------|------|--------|-------|------|------|------|------|------|------|------|--------|-------|------|------|------|------|------|------|------|--------|-------|------|------|------|------|------|------|------|--------|-------|------|-------|-------|-------|--------|-------|-------|-------|--------|-------|--------|
|--------------|------|------|------|------|------|------|--------|-------|------|------|------|------|------|------|------|--------|-------|------|------|------|------|------|------|------|------|------|------|------|------|--------|-------|------|------|------|------|------|------|------|--------|-------|------|------|------|------|------|------|------|--------|-------|------|------|------|------|------|------|------|--------|-------|------|-------|-------|-------|--------|-------|-------|-------|--------|-------|--------|

| PITCHER                                | IP  | WLS | BF | H | R | ER | SO | BB | IBB | HBP | BLK | WP | HR | S  | P  | ERA  | WHIP  |
|--|-----|-----|----|---|---|----|----|----|-----|-----|-----|----|----|----|----|------|-------|
| Aubrey Gatewood, R (1, 1)<br>ERA: 2.14 | 3.1 |     | 16 | 7 | 0 | 0  | 3  | 0  | 0   | 0   | 0   | 0  | 0  | 22 | 22 | 0.00 | 2.100 |
| Barry Latman, R (4, 1)<br>ERA: 3.85    | 4.2 | W   | 17 | 3 | 2 | 2  | 4  | 0  | 0   | 1   | 0   | 0  | 2  | 24 | 25 | 3.86 | 0.643 |
| Bob Duliba, R (9, 1)<br>ERA: 2.59      | 1.0 | S   | 4  | 1 | 0 | 0  | 0  | 0  | 0   | 0   | 0   | 0  | 0  | 4  | 4  | 0.00 | 1.000 |

| PITCHER | IP | WLS | BF | H | R | ER | SO | BB | IBB | HBP | BLK | WP | HR | S | P | ERA | WHIP |
|---------|----|-----|----|---|---|----|----|----|-----|-----|-----|----|----|---|---|-----|------|
|---------|----|-----|----|---|---|----|----|----|-----|-----|-----|----|----|---|---|-----|------|

| Batter  | 1   | 2                               | 3                            | 4                               | 5                            | 6                               | 7                            | 8                                | 9                            | AB R H RBI BB SO LOB            | TOP                          |                                 |                              |                                 |                              |                                 |                              |                                 |                                  |                                    |                                  |        |
|---|---|---------------------------------|------------------------------|---------------------------------|------------------------------|---------------------------------|------------------------------|----------------------------------|------------------------------|---------------------------------|------------------------------|---------------------------------|------------------------------|---------------------------------|------------------------------|---------------------------------|------------------------------|---------------------------------|----------------------------------|------------------------------------|----------------------------------|--------|
| Lenny Green, L<br>OBP: 0.316, SLG: 0.297<br>(1, 8) X  | 0-0<br>4-3  | 0-0<br>SF7                      |                              | 4-0<br>BB                       |                              |                                 | 0-0<br>1B                    |                                  | 0-0<br>HR                    | 3 2 2 2 1 0 0                   |                              |                                 |                              |                                 |                              |                                 |                              |                                 |                                  |                                    |                                  |        |
| Vic Power, R<br>OBP: 0.265, SLG: 0.311<br>(1, 4) X<br>(7, 3)  | 0-0<br>F4   | 0-0<br>F3                       |                              | 0-0<br>4-3                      |                              |                                 | 0-0<br>1B                    |                                  | 0-0<br>1-3                   | 5 0 1 0 0 0 3                   |                              |                                 |                              |                                 |                              |                                 |                              |                                 |                                  |                                    |                                  |        |
| Jim Fregosi, R<br>OBP: 0.383, SLG: 0.489<br>(1, 6) X  | 0-0<br>F9   |                                 | 0-0<br>F9                    |                                 | 0-0<br>5-3                   |                                 | 0-3<br>K                     |                                  | 0-0<br>6-3                   | 5 0 0 0 0 1 2                   |                              |                                 |                              |                                 |                              |                                 |                              |                                 |                                  |                                    |                                  |        |
| Willie Smith, L<br>OBP: 0.314, SLG: 0.470<br>(1, 7)   |   | 0-0<br>HR                       | 0-0<br>HR                    |                                 | 0-0<br>2B                    |                                 | 0-0<br>F7                    |                                  |                              | 4 2 3 1 0 0 2                   |                              |                                 |                              |                                 |                              |                                 |                              |                                 |                                  |                                    |                                  |        |
| Joe Adcock, R<br>OBP: 0.360, SLG: 0.487<br>Bobby Knoop, R<br>OBP: 0.287, SLG: 0.270<br>(1, 3)<br>(7, 4) |   | 0-0<br>HR                       | 0-0<br>G6-4-3<br>1B          |                                 | 0-3<br>K                     |                                 | 0-0<br>1B                    |                                  |                              | 4 1 3 3 0 1 1<br>0 0 0 0 0 0 0  |                              |                                 |                              |                                 |                              |                                 |                              |                                 |                                  |                                    |                                  |        |
| Felix Torres, R<br>OBP: 0.258, SLG: 0.423<br>(1, 5)   |   | 0-0<br>2B                       | 0-0<br>G6-4-3<br>1B          |                                 | 0-0<br>F6                    |                                 | 0-3<br>K                     |                                  |                              | 4 1 1 0 0 1 2                   |                              |                                 |                              |                                 |                              |                                 |                              |                                 |                                  |                                    |                                  |        |
| Lou Clinton, R<br>OBP: 0.304, SLG: 0.386<br>(1, 9)  |   | 0-0<br>1B                       |                              | 0-0<br>BB<br>HBP<br>1B          |                              | 0-0<br>F5                       |                              | 0-3<br>K                         |                              | 4 1 2 1 0 1 0                   |                              |                                 |                              |                                 |                              |                                 |                              |                                 |                                  |                                    |                                  |        |
| Buck Rodgers, S<br>OBP: 0.300, SLG: 0.308<br>(1, 2)   |   | 0-0<br>SF7<br>1B                |                              | 0-3<br>K                        |                              | 0-0<br>F9                       |                              | 0-0<br>5-3                       |                              | 4 0 1 0 0 1 1                   |                              |                                 |                              |                                 |                              |                                 |                              |                                 |                                  |                                    |                                  |        |
| George Brunet, R<br>Bob Lee, R<br>(1, 1)<br>(7, 1)  |   | 0-0<br>F2                       |                              | 1-0<br>BB<br>HBP                |                              | 0-0<br>L9                       |                              |                                  | 0-3<br>K                     | 2 0 0 0 0 0 2<br>1 0 0 0 0 1 0  |                              |                                 |                              |                                 |                              |                                 |                              |                                 |                                  |                                    |                                  |        |
| <b>Inning Stats</b>   | R: 0<br>E: 0<br>K: 0<br>S: 3                          | H: 0<br>LOB: 0<br>BB: 0<br>P: 3 | R: 4<br>E: 0<br>K: 0<br>S: 8 | H: 5<br>LOB: 1<br>BB: 0<br>P: 8 | R: 1<br>E: 0<br>K: 0<br>S: 4 | H: 2<br>LOB: 0<br>BB: 0<br>P: 4 | R: 0<br>E: 0<br>K: 1<br>S: 5 | H: 1<br>LOB: 2<br>BB: 1<br>P: 10 | R: 0<br>E: 0<br>K: 1<br>S: 6 | H: 1<br>LOB: 1<br>BB: 0<br>P: 6 | R: 0<br>E: 0<br>K: 0<br>S: 3 | H: 0<br>LOB: 0<br>BB: 0<br>P: 3 | R: 1<br>E: 0<br>K: 1<br>S: 7 | H: 3<br>LOB: 1<br>BB: 0<br>P: 7 | R: 0<br>E: 0<br>K: 2<br>S: 7 | H: 0<br>LOB: 0<br>BB: 0<br>P: 7 | R: 1<br>E: 0<br>K: 1<br>S: 6 | H: 1<br>LOB: 0<br>BB: 0<br>P: 6 | 1B: 7<br>2B: 3<br>3B: 0<br>HR: 3 | SF: 1<br>SAC: 0<br>DP: 1<br>HBP: 1 | WP: 0<br>PB: 0<br>SB: 0<br>CS: 0 | PA: 39 |
| <b>PITCHER</b>  | IP WLS BF H R ER SO BB IBB HBP BLK WP HR S P ERA WHIP |                                 |                              |                                 |                              |                                 |                              |                                  |                              |                                 |                              |                                 |                              |                                 |                              |                                 |                              |                                 |                                  |                                    |                                  |        |
| Diego Segui, R<br>ERA: 4.24<br>(1, 1)   | 1.0 L 8 5 4 4 0 0 0 0 0 0 0 1 8 8 36.00 5.000         |                                 |                              |                                 |                              |                                 |                              |                                  |                              |                                 |                              |                                 |                              |                                 |                              |                                 |                              |                                 |                                  |                                    |                                  |        |
| Ken Sanders, R<br>ERA: 2.51<br>(2, 1)   | 2.0 7 2 1 1 0 0 0 0 0 0 0 1 7 7 4.50 1.000            |                                 |                              |                                 |                              |                                 |                              |                                  |                              |                                 |                              |                                 |                              |                                 |                              |                                 |                              |                                 |                                  |                                    |                                  |        |
| Jose Santiago, R<br>ERA: 4.99<br>(4, 1)   | 4.0 17 5 1 1 3 1 0 1 0 0 0 0 21 26 2.25 1.500         |                                 |                              |                                 |                              |                                 |                              |                                  |                              |                                 |                              |                                 |                              |                                 |                              |                                 |                              |                                 |                                  |                                    |                                  |        |
| Ted Bowsfield, L<br>ERA: 4.24<br>(8, 1)   | 1.0 3 0 0 0 2 0 0 0 0 0 0 0 7 7 0.00 0.000            |                                 |                              |                                 |                              |                                 |                              |                                  |                              |                                 |                              |                                 |                              |                                 |                              |                                 |                              |                                 |                                  |                                    |                                  |        |
| John Wyatt, R<br>ERA: 3.79<br>(9, 1)  | 1.0 4 1 1 1 1 0 0 0 0 0 0 1 6 6 9.00 1.000            |                                 |                              |                                 |                              |                                 |                              |                                  |                              |                                 |                              |                                 |                              |                                 |                              |                                 |                              |                                 |                                  |                                    |                                  |        |

Los Angeles Angels @ Kansas City Athletics  
Municipal Stadium, Kansas City, MO  
Thu Aug 27 1964, 4:33 AM EDT  
Att. 2,599 - Unknown

livebaseballscorecards.com

|     |    |
|-----|----|
| AB  | 36 |
| R   | 7  |
| H   | 13 |
| RBI | 7  |
| BB  | 1  |
| SO  | 6  |
| LOB | 13 |



**BOTTOM**

**Los Angeles Angels @ Kansas City Athletics**  
**Municipal Stadium, Kansas City, MO**

Thu Aug 27 1964, 4:33 AM EDT  
 Att. 2,599 - Unknown

[livebaseballscores.com](http://livebaseballscores.com)

|            |           |
|------------|-----------|
| <b>AB</b>  | <b>33</b> |
| <b>R</b>   | <b>1</b>  |
| <b>H</b>   | <b>6</b>  |
| <b>RBI</b> | <b>1</b>  |
| <b>BB</b>  | <b>6</b>  |
| <b>SO</b>  | <b>8</b>  |
| <b>LOB</b> | <b>20</b> |



|     |   |     |    |
|-----|---|-----|----|
| WP: | 1 | PA: | 39 |
| PB: | 0 | SB: | 0  |
| CS: | 0 |     |    |

| AB | R | H | RBI | BB | SO | LOB |
|----|---|---|-----|----|----|-----|
| 4  | 0 | 1 | 0   | 1  | 1  | 1   |
| 3  | 0 | 1 | 0   | 2  | 0  | 1   |
| 5  | 0 | 0 | 0   | 0  | 2  | 6   |
| 3  | 0 | 1 | 0   | 1  | 0  | 1   |
| 3  | 0 | 1 | 0   | 1  | 1  | 1   |
| 3  | 0 | 0 | 0   | 1  | 1  | 4   |
| 4  | 0 | 0 | 0   | 0  | 2  | 3   |
| 4  | 0 | 1 | 0   | 0  | 1  | 2   |
| 0  | 0 | 0 | 0   | 0  | 0  | 0   |
| 0  | 0 | 0 | 0   | 0  | 0  | 0   |
| 1  | 0 | 0 | 0   | 0  | 0  | 0   |
| 1  | 0 | 0 | 0   | 0  | 0  | 1   |
| 1  | 1 | 1 | 1   | 0  | 0  | 0   |
| 0  | 0 | 0 | 0   | 0  | 0  | 0   |
| 1  | 0 | 0 | 0   | 0  | 0  | 0   |
| 0  | 0 | 0 | 0   | 0  | 0  | 0   |

| Batter  | 1      | 2      | 3         | 4            | 5       | 6      | 7                 | 8      | 9       |
|---|--------|--------|-----------|--------------|---------|--------|-------------------|--------|---------|
| Dick Green, R<br>OBP: 0.308, SLG: 0.389 (1, 4)      | 0-0 F8 |        | 4-0 1B BB |              | 0-3 K   |        | 0-0 FC6-4 1B      |        | 0-0 5-3 |
| Wayne Causey, L<br>OBP: 0.391, SLG: 0.405 (1, 6)    | 4-0 BB |        | 0-0 1B    |              | 4-0 BB  |        | 0-0 FC6-4 BB 1-2f |        | 0-0 F4  |
| Ed Charles, R<br>OBP: 0.318, SLG: 0.366 (1, 5)      | 0-0 F6 |        | 0-0 F8    |              | 0-3 K   |        | 0-0 F7            |        | 0-3 K   |
| Rocky Colavito, R<br>OBP: 0.359, SLG: 0.542 (1, 9)  | 0-0 F8 |        |           | 0-0 F8 WP 1B |         |        | 4-0 1-2 BB BB     |        |         |
| Jim Gentile, L<br>OBP: 0.380, SLG: 0.477 (1, 3)     |        | 0-3 K  |           | 0-0 1B       |         | 0-0 L9 | 4-0 1-2 2-3 BB    |        |         |
| Doc Edwards, R<br>OBP: 0.248, SLG: 0.294 (1, 2)     |        | 0-3 K  |           | 0-0 F7       |         | 4-0 BB | 0-0 1-3           |        |         |
| Bert Campaneris, R<br>OBP: 0.338, SLG: 0.456 (1, 7) |        | 0-0 F9 |           | 0-3 K        |         | 0-3 K  |                   | 0-0 F3 |         |
| Nelson Mathews, R<br>OBP: 0.296, SLG: 0.355 (1, 8)  |        |        | 0-0 5-3   |              | 0-0 2B  | 0-0 F7 |                   | 0-3 K  |         |
| Diego Segui, R<br>OBP: 0.234, SLG: 0.250 (1, 1)     |        |        |           |              |         |        | 0-0 HR            |        |         |
| Ken Sanders, R (2, 1)                               |        |        |           |              |         |        |                   |        |         |
| George Alusk, R<br>OBP: 0.347, SLG: 0.352 (3, PH)   |        |        | 0-0 L9    |              | 0-0 1-3 |        |                   | 0-0 F7 |         |
| Jose Santiago, R (4, 1)                             |        |        |           |              |         |        |                   |        |         |
| Ken Harrelson, R<br>OBP: 0.241, SLG: 0.358 (7, PH)  |        |        |           |              |         |        |                   |        |         |
| Ted Bowfield, R<br>OBP: 0.174, SLG: 0.095 (8, 1)    |        |        |           |              |         |        |                   |        |         |
| Jose Tartabull, L<br>OBP: 0.241, SLG: 0.238 (8, PH) |        |        |           |              |         |        |                   |        |         |
| John Wyatt, R (9, 1)                                |        |        |           |              |         |        |                   |        |         |

| Inning Stats | R: 0 | H: 0 | E: 0 | K: 0 | S: 3 | R: 0 | H: 0 | E: 0 | K: 2 | S: 7 | R: 0 | H: 1 | E: 0 | K: 0 | S: 4 | R: 0 | H: 1 | E: 0 | K: 1 | S: 6 | R: 0 | H: 1 | E: 0 | K: 2 | S: 8 | R: 0 | H: 1 | E: 0 | K: 1 | S: 6 | R: 1 | H: 2 | E: 0 | K: 0 | S: 5 | R: 0 | H: 0 | E: 0 | K: 1 | S: 5 | R: 0 | H: 0 | E: 0 | K: 1 | S: 5 | 1B: 4 | SF: 0 | 2B: 1 | 3B: 0 | HR: 1 | WP: 1 | PA: 39 |
|--------------|------|------|------|------|------|------|------|------|------|------|------|------|------|------|------|------|------|------|------|------|------|------|------|------|------|------|------|------|------|------|------|------|------|------|------|------|------|------|------|------|------|------|------|------|------|-------|-------|-------|-------|-------|-------|--------|
|--------------|------|------|------|------|------|------|------|------|------|------|------|------|------|------|------|------|------|------|------|------|------|------|------|------|------|------|------|------|------|------|------|------|------|------|------|------|------|------|------|------|------|------|------|------|------|-------|-------|-------|-------|-------|-------|--------|

| PITCHER                 | IP  | WLS | BF | H | R | ER | SO | BB | IBB | HBP | BLK | WP | HR | S  | P  | ERA  | WHIP  |
|-------------------------|-----|-----|----|---|---|----|----|----|-----|-----|-----|----|----|----|----|------|-------|
| George Brunet, L (1, 1) | 6.2 | W   | 32 | 6 | 1 | 1  | 6  | 6  | 0   | 0   | 0   | 1  | 1  | 38 | 62 | 1.35 | 1.800 |
| Bob Lee, R (7, 1)       | 2.1 | S   | 7  | 0 | 0 | 0  | 2  | 0  | 0   | 0   | 0   | 0  | 0  | 11 | 11 | 0.00 | 0.000 |

| PITCHER                 | IP  | WLS | BF | H | R | ER | SO | BB | IBB | HBP | BLK | WP | HR | S  | P  | ERA  | WHIP  |
|-------------------------|-----|-----|----|---|---|----|----|----|-----|-----|-----|----|----|----|----|------|-------|
| George Brunet, L (1, 1) | 6.2 | W   | 32 | 6 | 1 | 1  | 6  | 6  | 0   | 0   | 0   | 1  | 1  | 38 | 62 | 1.35 | 1.800 |
| Bob Lee, R (7, 1)       | 2.1 | S   | 7  | 0 | 0 | 0  | 2  | 0  | 0   | 0   | 0   | 0  | 0  | 11 | 11 | 0.00 | 0.000 |

| Batter  | 1   | 2                               | 3                            | 4                               | 5                            | 6                                | 7                            | 8                               | 9                            | AB R H RBI BB SO LOB             | TOP  |                              |                                 |                              |                                 |                              |                                 |                              |                                 |                                  |                                    |                                  |
|---|---|---------------------------------|------------------------------|---------------------------------|------------------------------|----------------------------------|------------------------------|---------------------------------|------------------------------|----------------------------------|--|------------------------------|---------------------------------|------------------------------|---------------------------------|------------------------------|---------------------------------|------------------------------|---------------------------------|----------------------------------|------------------------------------|----------------------------------|
| Chico Salmon, R (1, 9)<br>OBP: 0.343, SLG: 0.413  | 0-3<br>K  |                                 | 0-0<br>HR                    |                                 | 0-0<br>5-3                   |                                  | 0-3<br>K                     |                                 | 0-0<br>SH3-4                 | 4 1 1 1 0 2 0                    | <b>Cleveland Indians @ Kansas City Athletics</b><br>Municipal Stadium, Kansas City, MO<br>Fri Aug 28 1964, 8:05 PM EDT<br>Att. 4,543 - Unknown |                              |                                 |                              |                                 |                              |                                 |                              |                                 |                                  |                                    |                                  |
| Dick Howser, R (1, 6)<br>OBP: 0.332, SLG: 0.326   | 0-0<br>F2   |                                 | 0-0<br>WP S<br>1B            |                                 | 0-0<br>F7                    |                                  | 0-0<br>2B                    |                                 | 0-0<br>F4                    | 5 1 2 0 0 0 1                    |  |                              |                                 |                              |                                 |                              |                                 |                              |                                 |                                  |                                    |                                  |
| Bob Chance, L (1, 3)<br>OBP: 0.369, SLG: 0.475    | 0-0<br>3-1  |                                 | 0-3<br>K<br>1-3              |                                 | 0-3<br>K<br>BB               |                                  | 0-3<br>K                     |                                 | 4-0<br>BB                    | 4 0 0 0 1 3 2                    |  |                              |                                 |                              |                                 |                              |                                 |                              |                                 |                                  |                                    |                                  |
| Leon Wagner, L (1, 7)<br>OBP: 0.332, SLG: 0.473   |   | 0-0<br>1B<br>2B                 | 4-0<br>S<br>BB               |                                 | 4-0<br>FC5-4<br>BB           |                                  | 0-0<br>4-3                   |                                 | 0-0<br>F2                    | 3 1 1 0 2 0 3                    |  |                              |                                 |                              |                                 |                              |                                 |                              |                                 |                                  |                                    |                                  |
| John Romano, R (1, 2)<br>OBP: 0.331, SLG: 0.438   |   | 0-0<br>F8                       | 0-3<br>K<br>1-2<br>3-H       |                                 | 0-0<br>FC5-4<br>1-2f         |                                  |                              | 0-3<br>K                        |                              | 4 0 0 0 0 2 4                    |  |                              |                                 |                              |                                 |                              |                                 |                              |                                 |                                  |                                    |                                  |
| Max Alvis, R (1, 5)<br>OBP: 0.321, SLG: 0.443     |   | 0-3<br>K                        |                              | 0-0<br>F8                       |                              | 0-0<br>5-3                       |                              | 0-0<br>1B                       |                              | 4 0 1 0 0 1 1                    |  |                              |                                 |                              |                                 |                              |                                 |                              |                                 |                                  |                                    |                                  |
| Vic Davalillo, L (1, 8)<br>OBP: 0.301, SLG: 0.337 |   | 0-0<br>S<br>1B<br>2-H           |                              | 0-0<br>1B                       |                              | 0-0<br>4-3                       |                              | 0-0<br>F7                       |                              | 4 0 2 1 0 0 1                    |  |                              |                                 |                              |                                 |                              |                                 |                              |                                 |                                  |                                    |                                  |
| Woodie Held, R (1, 4)<br>OBP: 0.311, SLG: 0.425   |   | 0-0<br>5-3<br>1-2               |                              | 0-0<br>F6                       |                              | 0-0<br>F4                        |                              | 0-3<br>K                        |                              | 4 0 0 0 0 1 3                    |  |                              |                                 |                              |                                 |                              |                                 |                              |                                 |                                  |                                    |                                  |
| Sonny Siebert, R (1, 1)<br>OBP: 0.222, SLG: 0.371 |   |                                 | 0-0<br>F8                    | 0-0<br>F2                       |                              |                                  | 0-0<br>HR                    |                                 | 0-0<br>SH3-4<br>1B           | 4 1 2 1 0 0 1                    |  |                              |                                 |                              |                                 |                              |                                 |                              |                                 |                                  |                                    |                                  |
| <b>Inning Stats</b>                               | R: 0<br>E: 0<br>K: 1<br>S: 5                          | H: 0<br>LOB: 0<br>BB: 0<br>P: 5 | R: 1<br>E: 0<br>K: 1<br>S: 7 | H: 2<br>LOB: 1<br>BB: 0<br>P: 7 | R: 2<br>E: 0<br>K: 2<br>S: 9 | H: 2<br>LOB: 1<br>BB: 1<br>P: 13 | R: 0<br>E: 0<br>K: 0<br>S: 4 | H: 1<br>LOB: 1<br>BB: 0<br>P: 4 | R: 0<br>E: 0<br>K: 1<br>S: 6 | H: 0<br>LOB: 2<br>BB: 1<br>P: 10 |  | R: 0<br>E: 0<br>K: 0<br>S: 3 | H: 0<br>LOB: 0<br>BB: 0<br>P: 3 | R: 1<br>E: 0<br>K: 2<br>S: 9 | H: 2<br>LOB: 1<br>BB: 0<br>P: 9 | R: 0<br>E: 0<br>K: 2<br>S: 8 | H: 1<br>LOB: 1<br>BB: 0<br>P: 8 | R: 0<br>E: 0<br>K: 0<br>S: 4 | H: 1<br>LOB: 2<br>BB: 1<br>P: 8 | 1B: 5<br>2B: 2<br>3B: 0<br>HR: 2 | SF: 0<br>SAC: 1<br>DP: 0<br>HBP: 0 | WP: 1<br>PB: 1<br>SB: 4<br>CS: 0 |
| <b>PITCHER</b>                                    | IP WLS BF H R ER SO BB IBB HBP BLK WP HR S P ERA WHIP |                                 |                              |                                 |                              |                                  |                              |                                 |                              |                                  |  |                              |                                 |                              |                                 |                              |                                 |                              |                                 |                                  |                                    |                                  |
| Orlando Pena, R (1, 1)<br>ERA: 4.37               | 5.0 L 23 5 3 2 5 2 0 0 0 0 1 1 31 39 3.60 1.400       |                                 |                              |                                 |                              |                                  |                              |                                 |                              |                                  |  |                              |                                 |                              |                                 |                              |                                 |                              |                                 |                                  |                                    |                                  |
| Wes Stock, R (6, 1)<br>ERA: 2.37                  | 3.0 12 3 1 1 4 0 0 0 0 0 0 1 20 20 3.00 1.000         |                                 |                              |                                 |                              |                                  |                              |                                 |                              |                                  |  |                              |                                 |                              |                                 |                              |                                 |                              |                                 |                                  |                                    |                                  |
| John Wyatt, R (9, 1)<br>ERA: 3.75                 | 1.0 5 1 0 0 0 1 0 0 0 0 0 0 4 8 0.00 2.000            |                                 |                              |                                 |                              |                                  |                              |                                 |                              |                                  |  |                              |                                 |                              |                                 |                              |                                 |                              |                                 |                                  |                                    |                                  |

livebaseballscorecards.com

|            |    |
|------------|----|
| <b>AB</b>  | 36 |
| <b>R</b>   | 4  |
| <b>H</b>   | 9  |
| <b>RBI</b> | 3  |
| <b>BB</b>  | 3  |
| <b>SO</b>  | 9  |
| <b>LOB</b> | 16 |



| Batter  | 1              | 2                      | 3               | 4         | 5                   | 6 | 7 | 8          | 9 | AB R H RBI BB SO LOB |
|---|----------------|------------------------|-----------------|-----------|---------------------|---|---|------------|---|----------------------|
| Dick Green, R (1, 4)<br>OBP: 0.307, SLG: 0.388      | 0-0<br>6-3     |                        | 0-3<br>K        |           | 0-0<br>F8           |   |   | 0-0<br>1B  |   | 4 0 1 0 0 1 0        |
| Bert Campaneris, R (1, 7)<br>OBP: 0.336, SLG: 0.445 | 4-0<br>S<br>BB |                        | 0-0<br>L7       |           | 0-0<br>6-3          |   |   | 0-0<br>F8  |   | 3 0 0 0 1 0 2        |
| Wayne Causey, L (1, 6)<br>OBP: 0.390, SLG: 0.402    | 0-0<br>6-3     |                        | 4-0<br>2B<br>BB |           | 0-0<br>F8           |   |   | 0-0<br>F7  |   | 3 0 0 0 1 0 3        |
| Rocky Colavito, R (1, 9)<br>OBP: 0.362, SLG: 0.545  | 0-0<br>5-3     |                        | 0-0<br>2B       |           | 4-0<br>G4-6-3<br>BB |   |   | 0-0<br>1B  |   | 3 0 2 0 1 0 1        |
| Jim Gentile, L (1, 3)<br>OBP: 0.380, SLG: 0.476     |                | 0-0<br>2B<br>SF8<br>1B | 0-3<br>K        |           | 0-0<br>G4-6-3       |   |   | 0-0<br>4-3 |   | 3 1 1 0 0 1 3        |
| Manny Jimenez, L (8, PH)<br>OBP: 0.300, SLG: 0.470  |                |                        |                 |           |                     |   |   |            |   | 1 0 0 0 0 0 3        |
| John Wyatt, R (9, 1)                                |                |                        |                 |           |                     |   |   |            |   | 0 0 0 0 0 0 0        |
| Billy Bryan, L (1, 2)<br>OBP: 0.301, SLG: 0.515     |                | 0-0<br>1-3<br>2B       |                 | 0-3<br>K  |                     |   |   | 0-0<br>F8  |   | 4 0 2 0 0 1 0        |
| Ed Charles, R (1, 5)<br>OBP: 0.315, SLG: 0.363      |                | 0-0<br>SF8             |                 | 0-0<br>F9 |                     |   |   | 0-0<br>K   |   | 3 0 0 1 0 1 1        |
| Nelson Mathews, R (1, 8)<br>OBP: 0.293, SLG: 0.352  |                | 0-0<br>3-H<br>F9       |                 | 0-0<br>F8 |                     |   |   | 0-0<br>5-3 |   | 4 0 0 0 0 0 1        |
| Orlando Pena, R (1, 1)<br>OBP: 0.157, SLG: 0.167    |                | 0-0<br>F8              |                 |           | 0-3<br>K            |   |   | 0-0<br>1B  |   | 1 0 0 0 0 0 1        |
| George Alusik, R (5, PH)<br>OBP: 0.345, SLG: 0.351  |                |                        |                 |           |                     |   |   |            |   | 1 0 0 0 0 1 0        |
| Wes Stock, R (6, 1)<br>OBP: 0.235, SLG: 0.188       |                |                        |                 |           |                     |   |   |            |   | 0 0 0 0 0 0 0        |
| Jose Tartabull, L (8, PH)<br>OBP: 0.250, SLG: 0.247 |                |                        |                 |           |                     |   |   |            |   | 1 0 1 0 0 0 0        |
| Ken Harrelson, R (9, 3)<br>OBP: 0.241, SLG: 0.358   |                |                        |                 |           |                     |   |   |            |   | 0 0 0 0 0 0 0        |

**BOTTOM**

**Cleveland Indians @ Kansas City Athletics**  
**Municipal Stadium, Kansas City, MO**  
 Fri Aug 28 1964, 8:05 PM EDT  
 Att. 4,543 - Unknown

|            |           |
|------------|-----------|
| <b>AB</b>  | <b>31</b> |
| <b>R</b>   | <b>1</b>  |
| <b>H</b>   | <b>7</b>  |
| <b>RBI</b> | <b>1</b>  |
| <b>BB</b>  | <b>3</b>  |
| <b>SO</b>  | <b>5</b>  |
| <b>LOB</b> | <b>15</b> |



|  |   |   |  |   |   |   |   |   |   |  |   |
|--|---|---|--|---|---|---|---|---|---|--|---|
| <b>Inning Stats</b>                                    | R: 0 H: 0<br>E: 0 LOB: 1<br>K: 0 BB: 1<br>S: 3 P: 7   | R: 1 H: 2<br>E: 0 LOB: 1<br>K: 0 BB: 0<br>S: 5 P: 5 | R: 0 H: 1<br>E: 0 LOB: 2<br>K: 2 BB: 1<br>S: 8 P: 12 | R: 0 H: 0<br>E: 0 LOB: 0<br>K: 1 BB: 0<br>S: 5 P: 5 | R: 0 H: 0<br>E: 0 LOB: 0<br>K: 1 BB: 0<br>S: 5 P: 5 | R: 0 H: 0<br>E: 0 LOB: 0<br>K: 0 BB: 1<br>S: 2 P: 6 | R: 0 H: 0<br>E: 0 LOB: 0<br>K: 1 BB: 0<br>S: 5 P: 5 | R: 0 H: 3<br>E: 0 LOB: 3<br>K: 0 BB: 0<br>S: 6 P: 6 | R: 0 H: 1<br>E: 0 LOB: 0<br>K: 0 BB: 0<br>S: 3 P: 3 | 1B: 5 SF: 1<br>2B: 2 SAC: 0<br>3B: 0 DP: 2<br>HR: 0 HBP: 0 | WP: 0 PA: 35<br>PB: 0<br>SB: 1<br>CS: 0 |
| <b>PITCHER</b><br>Sonny Siebert, R (1, 1)<br>ERA: 2.97 | IP 9.0 WLS W BF 35 H 7 R 1 ER 1 SO 5 BB 3 IBB 0 HBP 0 BLK 0 WP 0 HR 0 S 42 P 54 ERA 1.00 WHIP 1.111 |   |  |   |   |   |   |   |   |  |   |

| Batter   | 1   | 2                               | 3                            | 4                               | 5                            | 6                                | 7                            | 8                               | 9                            | 10                              | 11                           | AB R H RBI BB SO LOB            | TOP  |                                 |                              |                                 |                              |                                 |                              |                                 |   |                                    |                                  |        |  |  |  |  |  |  |  |  |  |  |  |  |
|--|---|---------------------------------|------------------------------|---------------------------------|------------------------------|----------------------------------|------------------------------|---------------------------------|------------------------------|---------------------------------|------------------------------|---------------------------------|--|---------------------------------|------------------------------|---------------------------------|------------------------------|---------------------------------|------------------------------|---------------------------------|---|------------------------------------|----------------------------------|--------|--|--|--|--|--|--|--|--|--|--|--|--|
| Chico Salmon, R<br>OBP: 0.345, SLG: 0.409<br>(1, 9)    | 0-3<br>K  |                                 | 0-0<br>F7                    | 0-0<br>F2                       |                              |                                  | 0-0<br>1B                    |                                 |                              | 4-0<br>G4-3<br>BB               |                              | 4 0 1 0 1 1 0                   | <b>Cleveland Indians @ Kansas City Athletics</b><br>Municipal Stadium, Kansas City, MO<br>Sat Aug 29 1964, 4:33 AM EDT<br>Att: 9,677 - Unknown |                                 |                              |                                 |                              |                                 |                              |                                 |   |                                    |                                  |        |  |  |  |  |  |  |  |  |  |  |  |  |
| Dick Howser, R<br>OBP: 0.331, SLG: 0.324<br>(1, 6)     | 0-0<br>6-3  |                                 | 4-0<br>1B<br>BB              |                                 |                              | 0-0<br>F7                        | 0-0<br>G3                    |                                 |                              | 0-0<br>G4-3<br>1-2f             |                              | 4 1 0 0 1 0 2                   |  |                                 |                              |                                 |                              |                                 |                              |                                 |   |                                    |                                  |        |  |  |  |  |  |  |  |  |  |  |  |  |
| Fred Whitfield, L<br>OBP: 0.307, SLG: 0.440<br>(1, 3)  | 0-0<br>2B   |                                 | 0-0<br>1B<br>2B<br>1B        |                                 |                              | 0-0<br>F8                        |                              | 0-0<br>F8                       |                              | 0-0<br>HR                       |                              | 5 2 3 1 0 0 0                   |  |                                 |                              |                                 |                              |                                 |                              |                                 |   |                                    |                                  |        |  |  |  |  |  |  |  |  |  |  |  |  |
| Leon Wagner, L<br>OBP: 0.331, SLG: 0.470<br>(1, 7)     | 0-0<br>F8   |                                 | 0-0<br>2B<br>1B              |                                 |                              | 0-0<br>3-1                       |                              | 0-3<br>K                        |                              | 0-0<br>4-3                      |                              | 5 1 1 1 0 1 1                   |  |                                 |                              |                                 |                              |                                 |                              |                                 |   |                                    |                                  |        |  |  |  |  |  |  |  |  |  |  |  |  |
| Max Alvis, R<br>OBP: 0.319, SLG: 0.442<br>(1, 5)       |   | 0-0<br>5-3                      | 0-0<br>1B<br>2B              |                                 |                              | 0-0<br>L7                        |                              | 0-0<br>4-3                      |                              | 0-0<br>6-3                      |                              | 5 0 1 1 0 0 0                   |  |                                 |                              |                                 |                              |                                 |                              |                                 |   |                                    |                                  |        |  |  |  |  |  |  |  |  |  |  |  |  |
| Vic Davalillo, L<br>OBP: 0.302, SLG: 0.340<br>(1, 8)   |   | 0-0<br>2B                       | 0-0<br>1B                    |                                 |                              | 0-0<br>F7                        |                              | 0-0<br>E6                       |                              | 0-0<br>F9                       |                              | 5 0 2 1 0 0 0                   |  |                                 |                              |                                 |                              |                                 |                              |                                 |   |                                    |                                  |        |  |  |  |  |  |  |  |  |  |  |  |  |
| Joe Azcue, R<br>OBP: 0.324, SLG: 0.385<br>(1, 2)       |   | 0-0<br>F4                       | 0-0<br>F8                    |                                 |                              | 0-3<br>K                         |                              | 0-3<br>K                        |                              | 0-3<br>K                        |                              | 4 0 0 0 0 2 3                   |  |                                 |                              |                                 |                              |                                 |                              |                                 |   |                                    |                                  |        |  |  |  |  |  |  |  |  |  |  |  |  |
| Woodie Held, R<br>OBP: 0.310, SLG: 0.422<br>(1, 4)     |   | 0-3<br>K                        |                              | 0-0<br>F7                       |                              |                                  | 0-0<br>G1-6-3<br>1B          |                                 |                              | 0-3<br>K                        |                              | 4 0 1 0 0 2 1                   |  |                                 |                              |                                 |                              |                                 |                              |                                 |   |                                    |                                  |        |  |  |  |  |  |  |  |  |  |  |  |  |
| Luis Tiant, R<br>OBP: 0.038, SLG: 0.038<br>(1, 1)      |   |                                 | 0-3<br>K                     |                                 | 0-3<br>K                     |                                  | 0-0<br>G1-6-3<br>1-2f        |                                 |                              | 0-3<br>K                        |                              | 3 0 0 0 0 2 1                   |  |                                 |                              |                                 |                              |                                 |                              |                                 |   |                                    |                                  |        |  |  |  |  |  |  |  |  |  |  |  |  |
| Tito Francona, L<br>OBP: 0.377, SLG: 0.382<br>(10, PH) |   |                                 |                              |                                 |                              |                                  |                              |                                 |                              |                                 |                              | 1 0 0 0 0 1 0                   |  |                                 |                              |                                 |                              |                                 |                              |                                 |   |                                    |                                  |        |  |  |  |  |  |  |  |  |  |  |  |  |
| Don McMahon, R<br>OBP: 0.167, SLG: 0.167<br>(10, 1)    |   |                                 |                              |                                 |                              |                                  |                              |                                 |                              |                                 |                              | 0 0 0 0 0 0 0                   |  |                                 |                              |                                 |                              |                                 |                              |                                 |   |                                    |                                  |        |  |  |  |  |  |  |  |  |  |  |  |  |
| <b>Inning Stats</b>                                    | R: 0<br>E: 0<br>K: 1<br>S: 6  | H: 1<br>LOB: 1<br>BB: 0<br>P: 6 | R: 0<br>E: 0<br>K: 1<br>S: 6 | H: 1<br>LOB: 1<br>BB: 0<br>P: 6 | R: 3<br>E: 0<br>K: 1<br>S: 9 | H: 4<br>LOB: 2<br>BB: 1<br>P: 13 | R: 0<br>E: 0<br>K: 1<br>S: 5 | H: 0<br>LOB: 0<br>BB: 0<br>P: 5 | R: 0<br>E: 0<br>K: 0<br>S: 3 | H: 0<br>LOB: 0<br>BB: 0<br>P: 3 | R: 0<br>E: 0<br>K: 1<br>S: 5 | H: 0<br>LOB: 0<br>BB: 0<br>P: 5 | R: 0<br>E: 0<br>K: 1<br>S: 5   | H: 0<br>LOB: 0<br>BB: 0<br>P: 5 | R: 0<br>E: 1<br>K: 2<br>S: 7 | H: 0<br>LOB: 0<br>BB: 0<br>P: 7 | R: 0<br>E: 0<br>K: 1<br>S: 4 | H: 0<br>LOB: 0<br>BB: 1<br>P: 8 | R: 1<br>E: 0<br>K: 0<br>S: 4 | H: 1<br>LOB: 0<br>BB: 0<br>P: 4 | 1B: 5<br>2B: 3<br>3B: 0<br>HR: 1  | SF: 0<br>SAC: 0<br>DP: 2<br>HBP: 0 | WP: 0<br>PB: 0<br>SB: 0<br>CS: 0 | PA: 42 |  |  |  |  |  |  |  |  |  |  |  |  |
| <b>PITCHER</b>   | IP<br>WLS<br>BF<br>H<br>R<br>ER<br>SO<br>BB<br>IBB<br>HBP<br>BLK<br>WP<br>HR<br>S<br>P<br>ERA<br>WHIP |                                 |                              |                                 |                              |                                  |                              |                                 |                              |                                 |                              |                                 |  |                                 |                              |                                 |                              |                                 |                              |                                 | IP<br>WLS<br>BF<br>H<br>R<br>ER<br>SO<br>BB<br>IBB<br>HBP<br>BLK<br>WP<br>HR<br>S<br>P<br>ERA<br>WHIP |                                    |                                  |        |  |  |  |  |  |  |  |  |  |  |  |  |
| Moe Drabowsky, R<br>ERA: 5.2<br>(1, 1)                 | 7.0   | 29                              | 8                            | 3                               | 3                            | 5                                | 1                            | 0                               | 0                            | 0                               | 0                            | 0                               | 0  | 38                              | 42                           | 3.86                            | 1.286                        |                                 |                              |                                 |   |                                    |                                  |        |  |  |  |  |  |  |  |  |  |  |  |  |
| John Wyatt, R<br>ERA: 3.65<br>(8, 1)                   | 3.0   | 9                               | 0                            | 0                               | 0                            | 4                                | 1                            | 0                               | 0                            | 0                               | 0                            | 0                               | 0  | 16                              | 20                           | 0.00                            | 0.333                        |                                 |                              |                                 |   |                                    |                                  |        |  |  |  |  |  |  |  |  |  |  |  |  |
| Wes Stock, R<br>ERA: 2.45<br>(11, 1)                   | 1.0   | L 4                             | 1                            | 1                               | 1                            | 0                                | 0                            | 0                               | 0                            | 0                               | 0                            | 0                               | 1  | 4                               | 4                            | 9.00                            | 1.000                        |                                 |                              |                                 |   |                                    |                                  |        |  |  |  |  |  |  |  |  |  |  |  |  |

|     |    |
|-----|----|
| AB  | 40 |
| R   | 4  |
| H   | 9  |
| RBI | 4  |
| BB  | 2  |
| SO  | 9  |
| LOB | 8  |



livebaseballscorecards.com

| Batter   | 1   | 2   | 3  | 4   | 5   | 6  | 7   | 8   | 9   | 10  | 11  | AB R H RBI BB SO LOB                                       | BOTTOM   |   |   |      |       |
|--|---|---|--|---|---|--|---|---|---|---|---|--|--|---|---|------|-------|
| Dick Green, R<br>OBP: 0.306, SLG: 0.383<br>(1, 4)      | 4-0<br>CS<br>BB                                       |   | x 0-0<br>L7  |   | x 0-0<br>F9   |  | x 0-0<br>L7   |   |   | x 0-0<br>F3   |   | 4 0 0 0 1 0 0  | <b>Cleveland Indians @ Kansas City Athletics</b><br>Municipal Stadium, Kansas City, MO<br>Sat Aug 29 1964, 4:33 AM EDT<br>Att: 9,677 - Unknown |   |   |      |       |
| Bert Campaneris, R<br>OBP: 0.340, SLG: 0.447<br>(1, 7) | x 0-0<br>F9   |   | x 0-0  |   | x 0-0<br>5-3  |  | x 0-0   |   |   | x 0-0<br>F7   |   | 4 0 2 0 0 0 1  |  |   |   |      |       |
| John Wyatt, R<br>(8, 1)                                | x 0-0<br>F9   |   | x 0-0  |   |   |  | x 0-0   |   |   | x 0-0   |   | 0 0 0 0 0 0 0  |  |   |   |      |       |
| George Alusik, R<br>OBP: 0.344, SLG: 0.349<br>(10, PH) | x 1-2   |   | x 0-0<br>BB<br>1B                                    |   |   |  | x 0-0   |   |   | x 0-0   |   | 1 0 0 0 0 0 0  |  |   |   |      |       |
| Wes Stock, R<br>OBP: 0.235, SLG: 0.188<br>(11, 1)      | x 0-0   |   | x 0-0<br>1B<br>BB                                    |   |   |  | x 0-0   |   |   | x 0-3<br>K  |   | 0 0 0 0 0 0 0  |  |   |   |      |       |
| Wayne Causey, L<br>OBP: 0.390, SLG: 0.400<br>(1, 6)    | x 0-0<br>G3   |   | x 0-0<br>1B<br>BB                                    |   |   | BB<br>BB<br>SF8<br>BB                                | x 0-0<br>F8   |   |   |   |   | 3 1 0 0 2 1 1  |  |   |   |      |       |
| Rocky Colavito, R<br>OBP: 0.364, SLG: 0.545<br>(1, 9)  |   | x 0-0<br>HR<br>1B                                   | x 0-0<br>1-2<br>1B                                   |   |   | BB<br>BB<br>1-2<br>BB<br>BB                          | x 0-0<br>F4   |   |   | x 0-0   |   | 4 1 2 0 1 0 0  |  |   |   |      |       |
| Ken Harrelson, R<br>OBP: 0.239, SLG: 0.378<br>(1, 3)   |   | x 0-0<br>HR   | x 0-3<br>K   |   |   | 0-3<br>K   | x 0-0<br>F6   |   |   | x 0-0   |   | 5 1 1 2 0 2 4  |  |   |   |      |       |
| Billy Bryan, L<br>OBP: 0.298, SLG: 0.503<br>(1, 2)     |   | x 0-0<br>E4<br>2B                                   | x 0-0<br>F2  |   |   | BB<br>BB<br>1-2<br>2-3<br>BB                         | x 0-0<br>F9   |   |   | x 0-0   |   | 4 0 0 0 1 0 0  |  |   |   |      |       |
| Ed Charles, R<br>OBP: 0.317, SLG: 0.367<br>(1, 5)      |   | x 0-0<br>1-H<br>2B                                  | x 0-0<br>G4-6-3<br>1B                                |   |   | 0-0<br>SF8   | x 0-0<br>6-3  |   |   | x 0-0   |   | 3 0 2 1 0 0 0  |  |   |   |      |       |
| Nelson Mathews, R<br>OBP: 0.291, SLG: 0.349<br>(1, 8)  |   | x 0-0<br>6-3  | x 0-0<br>G4-6-3<br>1B                                |   |   | 0-3<br>K   | x 0-0<br>K  |   |   | x 0-3<br>K  |   | 4 0 0 0 0 2 4  |  |   |   |      |       |
| Moe Drabowsky, R<br>OBP: 0.024, SLG: 0.024<br>(1, 1)   |   | x 0-0<br>5-3  | x 0-0<br>K   |   |   | 0-3<br>K   | x 0-0<br>F9   |   |   | x 0-0<br>F8   |   | 2 0 0 0 0 1 1  |  |   |   |      |       |
| Manny Jimenez, L<br>OBP: 0.299, SLG: 0.468<br>(7, PH)  |   |   |  |   |   |  |   |   |   |   |   | 1 0 0 0 0 0 0  |  |   |   |      |       |
| Jose Tartabull, L<br>OBP: 0.247, SLG: 0.244<br>(8, 7)  |   |   |  |   |   |  |   |   |   |   |   | 1 0 0 0 0 0 0  |  |   |   |      |       |
| <b>Inning Stats</b>                                    | R: 0 H: 0<br>E: 0 LOB: 0<br>K: 0 BB: 1<br>S: 2 P: 6   | R: 2 H: 3<br>E: 1 LOB: 1<br>K: 0 BB: 0<br>S: 6 P: 6 | R: 0 H: 2<br>E: 0 LOB: 2<br>K: 1 BB: 1<br>S: 6 P: 10 | R: 0 H: 1<br>E: 0 LOB: 0<br>K: 0 BB: 0<br>S: 3 P: 3 | R: 0 H: 0<br>E: 0 LOB: 0<br>K: 1 BB: 0<br>S: 5 P: 5 | R: 1 H: 0<br>E: 0 LOB: 2<br>K: 2 BB: 3<br>S: 7 P: 19 | R: 0 H: 1<br>E: 0 LOB: 1<br>K: 0 BB: 0<br>S: 4 P: 4 | R: 0 H: 0<br>E: 0 LOB: 0<br>K: 0 BB: 0<br>S: 3 P: 3 | R: 0 H: 0<br>E: 0 LOB: 0<br>K: 1 BB: 0<br>S: 5 P: 5 | R: 0 H: 0<br>E: 0 LOB: 0<br>K: 1 BB: 0<br>S: 5 P: 5 | R: 0 H: 0<br>E: 0 LOB: 0<br>K: 0 BB: 0<br>S: 3 P: 3 | 1B: 5 SF: 1<br>2B: 1 SAC: 0<br>3B: 0 DP: 1<br>HR: 1 HBP: 0 | WP: 0 PA: 42<br>PB: 0<br>SB: 0<br>CS: 1  |   |   |      |       |
| <b>PITCHER</b>   | IP WLS BF H R ER SO BB IBB HBP BLK WP HR S P ERA WHIP |   |  |   |   |  |   |   |   |   |   |  |  |   |   |      |       |
| Luis Tiant, R<br>ERA: 2.58<br>(1, 1)                   | 9.0   | 36  | 7  | 3   | 3   | 5  | 5   | 0   | 0   | 0   | 0   | 0  | 0  | 0 | 0 | 3.00 | 1.333 |
| Don McMahon, R<br>ERA: 1.57<br>(10, 1)                 | 2.0   | 6   | 0  | 0   | 0   | 1  | 0   | 0   | 0   | 0   | 0   | 0  | 0  | 0 | 0 | 0.00 | 0.000 |

|     |    |
|-----|----|
| AB  | 36 |
| R   | 3  |
| H   | 7  |
| RBI | 3  |
| BB  | 5  |
| SO  | 6  |
| LOB | 11 |

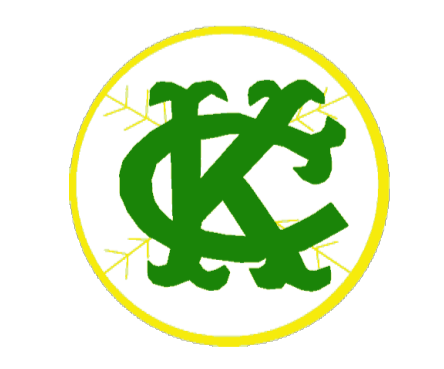

|    |   |    |    |
|----|---|----|----|
| WP | 0 | PA | 42 |
| PB | 0 |    |    |
| SB | 0 |    |    |
| CS | 1 |    |    |

livebaseballscorecards.com

| Batter   | 1                            | 2                               | 3                            | 4                               | 5                            | 6                               | 7                            | 8                                | 9                            | AB R H RBI BB SO LOB            | TOP   |                                 |                              |                                 |                              |                                  |                              |                                 |                                  |                                    |                                  |        |
|--|------------------------------|---------------------------------|------------------------------|---------------------------------|------------------------------|---------------------------------|------------------------------|----------------------------------|------------------------------|---------------------------------|---|---------------------------------|------------------------------|---------------------------------|------------------------------|----------------------------------|------------------------------|---------------------------------|----------------------------------|------------------------------------|----------------------------------|--------|
| Chico Salmon, R (1, 9)<br>OBP: 0.346, SLG: 0.429         | 0-0<br>FC5-2<br>3B           |                                 | 0-0<br>F7                    |                                 | 0-3<br>K                     |                                 | 0-0<br>5-3                   | 0-0<br>3B                        |                              | 5 0 2 2 0 1 1                   | <b>Cleveland Indians @ Kansas City Athletics</b><br>Municipal Stadium, Kansas City, MO<br>Sun Aug 30 1964, 4:33 AM EDT<br>Unknown |                                 |                              |                                 |                              |                                  |                              |                                 |                                  |                                    |                                  |        |
| Dick Howser, R (1, 6)<br>OBP: 0.331, SLG: 0.323          | 0-0<br>FC5-2<br>G5-4-3       |                                 | 0-0<br>FC4                   |                                 | 0-0<br>4-3                   |                                 | 0-0<br>1B                    | 2-H<br>3-H<br>4-0<br>BB          |                              | 4 0 1 0 1 0 2                   |   |                                 |                              |                                 |                              |                                  |                              |                                 |                                  |                                    |                                  |        |
| Bob Chance, L (1, 3)<br>OBP: 0.364, SLG: 0.467           | 0-0<br>G5-4-3                |                                 |                              | 0-0<br>6-3                      | 0-0<br>F8                    |                                 | 0-0<br>F6                    | 0-0<br>4-3                       |                              | 5 0 0 0 0 0 4                   |   |                                 |                              |                                 |                              |                                  |                              |                                 |                                  |                                    |                                  |        |
| Leon Wagner, L (1, 7)<br>OBP: 0.332, SLG: 0.470          |                              | 0-0<br>F8                       |                              | 0-3<br>K                        |                              | 0-0<br>1B                       | 0-0<br>FC6-4<br>1B           | 0-0<br>4-3                       |                              | 5 0 2 0 0 1 0                   |   |                                 |                              |                                 |                              |                                  |                              |                                 |                                  |                                    |                                  |        |
| Max Alvis, R (1, 5)<br>OBP: 0.324, SLG: 0.445            |                              | 0-0<br>6-3<br>WP<br>1B          |                              | 0-0<br>BB<br>1B                 |                              | 0-0<br>1B                       | 0-0<br>FC6-4                 | 0-0<br>4-3                       |                              | 5 1 3 0 0 0 2                   |   |                                 |                              |                                 |                              |                                  |                              |                                 |                                  |                                    |                                  |        |
| Joe Azcue, R (1, 2)<br>OBP: 0.321, SLG: 0.381            |                              | 0-0<br>6-3                      |                              | 0-0<br>BB<br>1B                 |                              | 0-0<br>F8                       |                              | 0-0<br>F8                        |                              | 5 0 1 0 0 1 3                   |   |                                 |                              |                                 |                              |                                  |                              |                                 |                                  |                                    |                                  |        |
| Vic Davalillo, L (1, 8)<br>OBP: 0.304, SLG: 0.338        |                              | 0-3<br>K                        |                              | 4-0<br>BB<br>1B                 |                              | 0-0<br>F5                       |                              | 4-0<br>2B<br>3B<br>BB            |                              | 2 1 0 0 2 1 3                   |   |                                 |                              |                                 |                              |                                  |                              |                                 |                                  |                                    |                                  |        |
| Woodie Held, R (1, 4)<br>OBP: 0.313, SLG: 0.423          |                              |                                 | 0-3<br>K                     |                                 | 4-0<br>BB                    |                                 | 0-0<br>FC6-4<br>1B           | 0-0<br>F8                        |                              | 2 0 1 1 1 1 0                   |   |                                 |                              |                                 |                              |                                  |                              |                                 |                                  |                                    |                                  |        |
| Ted Abernathy, R (6, 1)                                  |                              |                                 |                              |                                 | 1-2<br>2-3<br>3-H<br>BB      |                                 | 1-2<br>2-3<br>FC6-4<br>1B    |                                  |                              | 0 0 0 0 0 0 0                   |   |                                 |                              |                                 |                              |                                  |                              |                                 |                                  |                                    |                                  |        |
| Paul Dicken, R (8, PH)                                   |                              |                                 |                              |                                 |                              |                                 |                              |                                  |                              | 1 0 0 0 0 0 1                   |   |                                 |                              |                                 |                              |                                  |                              |                                 |                                  |                                    |                                  |        |
| Pedro Ramos, S (8, 1)<br>OBP: 0.220, SLG: 0.333          |                              |                                 |                              |                                 |                              |                                 |                              |                                  |                              | 0 0 0 0 0 0 0                   |   |                                 |                              |                                 |                              |                                  |                              |                                 |                                  |                                    |                                  |        |
| Jack Kralick, L (1, 1)<br>OBP: 0.196, SLG: 0.185         |                              |                                 | 0-0<br>FC4<br>1B             |                                 | 0-0<br>G3                    |                                 | 0-0<br>FC6-4                 | 0-0<br>3B<br>2B                  |                              | 2 0 1 0 0 0 3                   |   |                                 |                              |                                 |                              |                                  |                              |                                 |                                  |                                    |                                  |        |
| Gary Bell, R (5, 1)<br>OBP: 0.412, SLG: 0.375            |                              |                                 |                              |                                 |                              |                                 |                              |                                  |                              | 0 0 0 0 0 0 0                   |   |                                 |                              |                                 |                              |                                  |                              |                                 |                                  |                                    |                                  |        |
| Billy Moran, R (6, PH)<br>OBP: 0.299, SLG: 0.294         |                              |                                 |                              |                                 |                              |                                 |                              |                                  |                              | 2 1 1 0 0 0 3                   |   |                                 |                              |                                 |                              |                                  |                              |                                 |                                  |                                    |                                  |        |
| <b>Inning Stats</b>                                      | R: 0<br>E: 0<br>K: 0<br>S: 3 | H: 1<br>LOB: 0<br>BB: 0<br>P: 3 | R: 0<br>E: 0<br>K: 1<br>S: 6 | H: 1<br>LOB: 1<br>BB: 0<br>P: 6 | R: 0<br>E: 0<br>K: 1<br>S: 6 | H: 1<br>LOB: 1<br>BB: 0<br>P: 6 | R: 1<br>E: 0<br>K: 1<br>S: 7 | H: 2<br>LOB: 3<br>BB: 2<br>P: 15 | R: 0<br>E: 0<br>K: 1<br>S: 5 | H: 0<br>LOB: 0<br>BB: 0<br>P: 5 | R: 0<br>E: 0<br>K: 0<br>S: 6  | H: 3<br>LOB: 3<br>BB: 0<br>P: 6 | R: 0<br>E: 0<br>K: 0<br>S: 5 | H: 2<br>LOB: 2<br>BB: 0<br>P: 5 | R: 2<br>E: 0<br>K: 1<br>S: 7 | H: 2<br>LOB: 2<br>BB: 2<br>P: 15 | R: 0<br>E: 0<br>K: 0<br>S: 3 | H: 0<br>LOB: 0<br>BB: 0<br>P: 3 | 1B: 9<br>2B: 1<br>3B: 2<br>HR: 0 | SF: 0<br>SAC: 0<br>DP: 1<br>HBP: 0 | WP: 1<br>PB: 0<br>SB: 0<br>CS: 0 | PA: 42 |
| <b>PITCHER</b><br>John O'Donoghue, L (1, 1)<br>ERA: 4.43 | IP<br>9.0                    | WLS<br>W                        | BF<br>42                     | H<br>12                         | R<br>3                       | ER<br>3                         | SO<br>5                      | BB<br>4                          | IBB<br>0                     | HBP<br>0                        | BLK<br>0  | WP<br>1                         | HR<br>0                      | S<br>48                         | P<br>64                      | ERA<br>3.00                      | WHIP<br>1.778                |                                 |                                  |                                    |                                  |        |

livebaseballscorecards.com

|            |           |
|------------|-----------|
| <b>AB</b>  | <b>38</b> |
| <b>R</b>   | <b>3</b>  |
| <b>H</b>   | <b>12</b> |
| <b>RBI</b> | <b>3</b>  |
| <b>BB</b>  | <b>4</b>  |
| <b>SO</b>  | <b>5</b>  |
| <b>LOB</b> | <b>22</b> |





| Batter  | 1                       | 2                             | 3          | 4                | 5                       | 6                      | 7                        | 8                | 9 | AB | R | H | RBI | BB | SO | LOB |
|---|-------------------------|-------------------------------|------------|------------------|-------------------------|------------------------|--------------------------|------------------|---|----|---|---|-----|----|----|-----|
| <b>Bert Campaneris, R</b><br><small>(1, 6)<br/>OBP: 0.336, SLG: 0.438</small>   | 0-0<br>6-3              | 0-0<br>BB<br>1-2<br>1B        |            | 0-0<br>F7        | 0-3<br>K                |                        | 0-0<br>G6-3              |                  |   | 5  | 0 | 1 | 0   | 0  | 1  | 3   |
| <b>Wayne Causey, L</b><br><small>(1, 4)<br/>OBP: 0.392, SLG: 0.400</small>  | 0-0<br>F7               | 4-0<br>BB<br>1-2<br>2-3<br>BB |            | 0-0<br>1-2<br>1B |                         | 0-0<br>5-3<br>1B<br>1B |                          | 0-0<br>4-3       |   | 4  | 1 | 2 | 0   | 1  | 0  | 0   |
| <b>Ken Harrelson, R</b><br><small>(1, 7)<br/>OBP: 0.240, SLG: 0.374</small><br><b>Jose Tartabull, L</b><br><small>(7, 7)<br/>OBP: 0.256, SLG: 0.253</small> | 0-0<br>BB<br>HR<br>1B   | 0-0<br>F8                     |            | 0-3<br>K<br>2-3  |                         | 0-0<br>5-3<br>1-2      |                          | 0-0<br>WP<br>1B  |   | 4  | 1 | 1 | 0   | 0  | 1  | 6   |
| <b>Rocky Colavito, R</b><br><small>(1, 9)<br/>OBP: 0.363, SLG: 0.540</small>  | 4-0<br>1-2<br>HR<br>BB  |                               | 0-0<br>5-3 |                  | 0-0<br>5-3              | 0-0<br>F7              |                          | 0-0<br>F5<br>1-2 |   | 4  | 1 | 0 | 0   | 1  | 0  | 2   |
| <b>Jim Gentile, L</b><br><small>(1, 3)<br/>OBP: 0.385, SLG: 0.497</small>   | 0-0<br>1-H<br>2-H<br>HR |                               | 0-0<br>F9  |                  | 0-0<br>HR               | 0-0<br>PB<br>1B        |                          | 4-0<br>BB<br>BB  |   | 4  | 2 | 3 | 5   | 1  | 0  | 0   |
| <b>Doc Edwards, R</b><br><small>(1, 2)<br/>OBP: 0.251, SLG: 0.296</small>   | 0-0<br>F9               |                               | 0-0<br>1B  |                  | 0-0<br>E<br>HR<br>1B    | 0-0<br>1-3             |                          | 0-3<br>K         |   | 5  | 1 | 2 | 0   | 0  | 1  | 3   |
| <b>Ed Charles, R</b><br><small>(1, 5)<br/>OBP: 0.316, SLG: 0.365</small>  |                         | 0-0<br>F3                     | 0-0<br>4-3 |                  | 4-0<br>1-3<br>HR<br>BB  |                        | 0-0<br>5-3               |                  |   | 3  | 1 | 0 | 0   | 1  | 0  | 1   |
| <b>Nelson Mathews, R</b><br><small>(1, 8)<br/>OBP: 0.297, SLG: 0.365</small>  |                         | 4-0<br>FC1-6<br>BB            |            | 0-0<br>HR        | 0-0<br>1-H<br>3-H<br>HR |                        | 4-0<br>1B<br>BB          |                  |   | 2  | 2 | 2 | 4   | 2  | 0  | 0   |
| <b>John O'Donoghue, R</b><br><small>(1, 1)<br/>OBP: 0.234, SLG: 0.298</small>   |                         | 0-0<br>FC1-6<br>BB<br>1B      |            | 0-0<br>K<br>1B   | 0-3<br>K                |                        | 0-0<br>1-2<br>G6-3<br>1B |                  |   | 4  | 0 | 2 | 0   | 0  | 1  | 1   |

| Inning Stats | R | H | E | K | S | R | H | E | K | S | R | H | E | K | S | R | H | E | K  | S | R | H | E | K | S  | R | H | E | K  | S | 1B | SF | 2B | 3B | HR |
|--------------|---|---|---|---|---|---|---|---|---|---|---|---|---|---|---|---|---|---|----|---|---|---|---|---|----|---|---|---|----|---|----|----|----|----|----|
|              | 3 | 2 | 0 | 5 |   | 0 | 1 | 0 | 4 |   | 0 | 1 | 0 | 1 |   | 1 | 3 | 0 | 10 |   | 0 | 2 | 1 | 0 | 3  | 0 | 1 | 0 | 10 | 0 | 0  | 0  | 4  |    |    |
|              | 0 | 0 | 0 |   |   | 0 | 3 | 0 | 2 |   | 0 | 3 | 0 | 1 |   | 0 | 2 | 0 | 5  |   | 0 | 1 | 0 | 0 | 6  |   | 0 | 1 | 0  | 0 | 0  | 0  | 1  |    |    |
|              | 0 | 0 | 0 |   |   | 0 | 2 | 0 | 1 |   | 0 | 2 | 0 | 1 |   | 0 | 1 | 0 | 7  |   | 0 | 1 | 0 | 0 | 14 |   | 0 | 1 | 0  | 0 | 0  | 0  | 0  |    |    |
|              | 0 | 0 | 0 |   |   | 0 | 1 | 0 | 0 |   | 0 | 1 | 0 | 0 |   | 0 | 1 | 0 | 3  |   | 0 | 0 | 0 | 7 |    | 0 | 0 | 0 | 0  | 0 | 0  | 0  | 0  |    |    |
|              | 0 | 0 | 0 |   |   | 0 | 0 | 0 | 0 |   | 0 | 0 | 0 | 0 |   | 0 | 0 | 0 | 5  |   | 0 | 0 | 0 | 7 |    | 0 | 0 | 0 | 0  | 0 | 0  | 0  | 0  |    |    |
|              | 0 | 0 | 0 |   |   | 0 | 0 | 0 | 0 |   | 0 | 0 | 0 | 0 |   | 0 | 0 | 0 | 6  |   | 0 | 0 | 0 | 7 |    | 0 | 0 | 0 | 0  | 0 | 0  | 0  | 0  |    |    |

| PITCHER  | IP  | WLS | BF | H | R | ER | SO | BB | IBB | HBP | BLK | WP | HR | S  | P  | ERA   | WHIP  |
|--|-----|-----|----|---|---|----|----|----|-----|-----|-----|----|----|----|----|-------|-------|
| <b>Jack Kralick, L</b><br><small>(1, 1)<br/>ERA: 3.16</small>  | 4.0 | L   | 21 | 7 | 4 | 4  | 1  | 3  | 0   | 0   | 0   | 0  | 2  | 20 | 32 | 9.00  | 2.500 |
| <b>Gary Bell, R</b><br><small>(5, 1)<br/>ERA: 4.53</small>     | 1.0 |     | 7  | 3 | 4 | 4  | 2  | 1  | 0   | 0   | 0   | 0  | 2  | 10 | 14 | 36.00 | 4.000 |
| <b>Ted Abernathy, R</b><br><small>(6, 1)<br/>ERA: 4.11</small> | 2.0 |     | 9  | 3 | 1 | 1  | 0  | 1  | 0   | 0   | 0   | 0  | 0  | 8  | 12 | 4.50  | 2.000 |
| <b>Pedro Ramos, R</b><br><small>(8, 1)<br/>ERA: 4.89</small>   | 1.0 |     | 5  | 1 | 0 | 0  | 1  | 1  | 0   | 0   | 0   | 1  | 0  | 6  | 10 | 0.00  | 2.000 |

**BOTTOM**

**Cleveland Indians @ Kansas City Athletics**

Municipal Stadium, Kansas City, MO

Sun Aug 30 1964, 4:33 AM EDT  
Unknown

|            |           |
|------------|-----------|
| <b>AB</b>  | <b>36</b> |
| <b>R</b>   | <b>9</b>  |
| <b>H</b>   | <b>14</b> |
| <b>RBI</b> | <b>9</b>  |
| <b>BB</b>  | <b>6</b>  |
| <b>SO</b>  | <b>4</b>  |
| <b>LOB</b> | <b>16</b> |



|       |        |
|-------|--------|
| WP: 1 | PA: 42 |
| PB: 1 | SB: 0  |
| CS: 0 |        |

| Batter  | 1   | 2                               | 3                            | 4                                | 5                             | 6  | 7                            | 8                                | 9   | AB R H RBI BB SO LOB             | TOP  |                                  |                              |                                 |                              |                                  |                              |                                  |                                  |                                    |                                  |        |  |  |  |  |  |  |  |  |  |  |  |  |  |  |
|---|---|---------------------------------|------------------------------|----------------------------------|-------------------------------|--|------------------------------|----------------------------------|---|----------------------------------|--|----------------------------------|------------------------------|---------------------------------|------------------------------|----------------------------------|------------------------------|----------------------------------|----------------------------------|------------------------------------|----------------------------------|--------|--|--|--|--|--|--|--|--|--|--|--|--|--|--|
| Chico Salmon, R (1, 9)<br>OBP: 0.347, SLG: 0.426    | 0-0<br>5-3  |                                 | 0-0<br>F8                    |                                  | 4-0<br>FC5-4<br>BB            | 0-0<br>SF7-4<br>1B                       |                              | 0-0<br>FC6-4<br>1-2f             |   | 4 0 1 0 1 0 2                    | <b>Cleveland Indians @ Kansas City Athletics</b><br>Municipal Stadium, Kansas City, MO<br>Sun Aug 30 1964, 4:38 AM EDT<br>Att. 6,724 - Unknown |                                  |                              |                                 |                              |                                  |                              |                                  |                                  |                                    |                                  |        |  |  |  |  |  |  |  |  |  |  |  |  |  |  |
| Dick Howser, R (1, 6)<br>OBP: 0.332, SLG: 0.325     | 0-3<br>K  |                                 | 0-0<br>1B                    |                                  | 0-0<br>FC5-4<br>1B BB<br>1-2f | 0-0<br>SF7-4<br>1-2<br>3-H               |                              | 0-0<br>SH1-3<br>1B<br>1B         | 4 1 2 1 0 1 1                                   |                                  |  |                                  |                              |                                 |                              |                                  |                              |                                  |                                  |                                    |                                  |        |  |  |  |  |  |  |  |  |  |  |  |  |  |  |
| Bob Chance, L (1, 3)<br>OBP: 0.364, SLG: 0.465      | 0-3<br>K  |                                 | 0-3<br>K                     |                                  | 4-0<br>1B<br>BB<br>1-2        |  | 0-0<br>F8                    | 0-0<br>SH1-3<br>1B<br>1B         | 4 1 1 0 1 2 1                                   |                                  |  |                                  |                              |                                 |                              |                                  |                              |                                  |                                  |                                    |                                  |        |  |  |  |  |  |  |  |  |  |  |  |  |  |  |
| Leon Wagner, L (1, 7)<br>OBP: 0.331, SLG: 0.468     |   | 0-3<br>K                        |                              | 0-0<br>F2                        | 0-0<br>1B<br>BB<br>1-2<br>2-3 |  | 0-0<br>4-1                   | 0-0<br>SH1-3<br>1B               | 4 0 1 0 0 1 0                                   |                                  |  |                                  |                              |                                 |                              |                                  |                              |                                  |                                  |                                    |                                  |        |  |  |  |  |  |  |  |  |  |  |  |  |  |  |
| John Romano, R (1, 2)<br>OBP: 0.332, SLG: 0.433     |   | 0-3<br>K                        |                              | 4-0<br>FC6-4<br>BB               | 0-3<br>K                      |  | 0-0<br>1-3                   | 4-0<br>E<br>1B<br>IBB            | 3 0 0 0 2 2 3                                   |                                  |  |                                  |                              |                                 |                              |                                  |                              |                                  |                                  |                                    |                                  |        |  |  |  |  |  |  |  |  |  |  |  |  |  |  |
| Billy Moran, R (1, 5)<br>OBP: 0.300, SLG: 0.292     |   | 4-0<br>BB<br>1B<br>BB           |                              | 0-0<br>FC6-4<br>IHR<br>1-2f      | 0-0<br>1-6-3                  |  | 0-0<br>L5                    | 0-0<br>E2<br>1B                  | 2 1 0 0 1 0 4<br>1 0 0 0 0 0 0<br>1 0 1 2 0 0 0 |                                  |  |                                  |                              |                                 |                              |                                  |                              |                                  |                                  |                                    |                                  |        |  |  |  |  |  |  |  |  |  |  |  |  |  |  |
| Tito Francona, L (8, PH)<br>OBP: 0.376, SLG: 0.380  |   |                                 |                              |                                  |                               |  |                              | 1-3<br>2-H<br>3-H                |   |                                  |  |                                  |                              |                                 |                              |                                  |                              |                                  |                                  |                                    |                                  |        |  |  |  |  |  |  |  |  |  |  |  |  |  |  |
| Max Alvis, R (8, 5)<br>OBP: 0.326, SLG: 0.447       |   |                                 |                              |                                  |                               |  |                              |                                  |   |                                  |  |                                  |                              |                                 |                              |                                  |                              |                                  |                                  |                                    |                                  |        |  |  |  |  |  |  |  |  |  |  |  |  |  |  |
| Vic Davalillo, L (1, 8)<br>OBP: 0.309, SLG: 0.347   |   | 4-0<br>1B<br>BB<br>1-2          |                              | 0-0<br>IHR<br>1-H                |                               | 4-0<br>SH2-4<br>BB<br>BB                 |                              | 0-0<br>BB<br>1B                  | 0-3<br>K  | 3 2 2 2 2 1 2                    |  |                                  |                              |                                 |                              |                                  |                              |                                  |                                  |                                    |                                  |        |  |  |  |  |  |  |  |  |  |  |  |  |  |  |
| Woodie Held, R (1, 4)<br>OBP: 0.321, SLG: 0.423     |   | 0-0<br>1B<br>1-2<br>2-H         |                              | 4-0<br>BB                        |                               | 4-0<br>1B<br>SH2-4<br>SF7-4<br>BB<br>1-2 |                              | 4-0<br>FC6-4<br>BB<br>1-2        | 0-0<br>3-1                                      | 2 1 1 0 3 0 2                    |  |                                  |                              |                                 |                              |                                  |                              |                                  |                                  |                                    |                                  |        |  |  |  |  |  |  |  |  |  |  |  |  |  |  |
| Dick Donovan, L (1, 1)<br>OBP: 0.314, SLG: 0.238    |   |                                 | 0-3<br>K                     |                                  | 0-3<br>K                      |  | 0-0<br>SH2-4                 |                                  |   | 2 0 0 1 0 2 1                    |  |                                  |                              |                                 |                              |                                  |                              |                                  |                                  |                                    |                                  |        |  |  |  |  |  |  |  |  |  |  |  |  |  |  |
| Don McMahon, R (7, 1)<br>OBP: 0.167, SLG: 0.167     |   |                                 |                              |                                  |                               |  |                              |                                  |   | 0 0 0 0 0 0 0                    |  |                                  |                              |                                 |                              |                                  |                              |                                  |                                  |                                    |                                  |        |  |  |  |  |  |  |  |  |  |  |  |  |  |  |
| Fred Whitfield, L (8, PH)<br>OBP: 0.306, SLG: 0.438 |   |                                 |                              |                                  |                               |  |                              |                                  |   | 1 0 0 0 0 1 2                    |  |                                  |                              |                                 |                              |                                  |                              |                                  |                                  |                                    |                                  |        |  |  |  |  |  |  |  |  |  |  |  |  |  |  |
| Gary Bell, R (8, 1)<br>OBP: 0.412, SLG: 0.375       |   |                                 |                              |                                  |                               |  |                              |                                  |   | 0 0 0 0 0 0 0                    |  |                                  |                              |                                 |                              |                                  |                              |                                  |                                  |                                    |                                  |        |  |  |  |  |  |  |  |  |  |  |  |  |  |  |
| Sam McDowell, L (9, 1)<br>OBP: 0.159, SLG: 0.098    |   |                                 |                              |                                  |                               |  |                              |                                  |   | 0 0 0 0 0 0 0                    |  |                                  |                              |                                 |                              |                                  |                              |                                  |                                  |                                    |                                  |        |  |  |  |  |  |  |  |  |  |  |  |  |  |  |
| <b>Inning Stats</b>                                 | R: 0<br>E: 0<br>K: 2<br>S: 7                          | H: 0<br>LOB: 0<br>BB: 0<br>P: 7 | R: 0<br>E: 0<br>K: 2<br>S: 7 | H: 1<br>LOB: 2<br>BB: 2<br>P: 15 | R: 0<br>E: 0<br>K: 2<br>S: 8  | H: 1<br>LOB: 1<br>BB: 0<br>P: 8          | R: 2<br>E: 0<br>K: 1<br>S: 6 | H: 1<br>LOB: 1<br>BB: 2<br>P: 14 | R: 0<br>E: 0<br>K: 1<br>S: 6                    | H: 1<br>LOB: 3<br>BB: 2<br>P: 14 | R: 2<br>E: 0<br>K: 0<br>S: 3   | H: 1<br>LOB: 0<br>BB: 2<br>P: 11 | R: 0<br>E: 0<br>K: 0<br>S: 3 | H: 0<br>LOB: 0<br>BB: 0<br>P: 3 | R: 0<br>E: 0<br>K: 1<br>S: 6 | H: 1<br>LOB: 2<br>BB: 1<br>P: 10 | R: 2<br>E: 1<br>K: 1<br>S: 8 | H: 3<br>LOB: 2<br>BB: 1<br>P: 12 | 1B: 8<br>2B: 1<br>3B: 0<br>HR: 1 | SF: 1<br>SAC: 2<br>DP: 1<br>HBP: 0 | WP: 0<br>PB: 0<br>SB: 0<br>CS: 0 | PA: 44 |  |  |  |  |  |  |  |  |  |  |  |  |  |  |
| <b>PITCHER</b>                                      | IP WLS BF H R ER SO BB IBB HBP BLK WP HR S P ERA WHIP |                                 |                              |                                  |                               |  |                              |                                  |   |                                  |  |                                  |                              |                                 |                              |                                  |                              |                                  |                                  |                                    |                                  |        |  |  |  |  |  |  |  |  |  |  |  |  |  |  |
| Bob Meyer, L (1, 1)<br>ERA: 4.85                    | 4.1   |                                 | 22                           | 4                                | 2                             | 2  | 7                            | 6                                | 0   | 0                                | 0  | 0                                | 0                            | 30                              | 54                           | 4.15                             | 2.308                        |                                  |                                  |                                    |                                  |        |  |  |  |  |  |  |  |  |  |  |  |  |  |  |
| Jose Santiago, R (5, 1)<br>ERA: 5.2                 | 1.0   |                                 | 6                            | 1                                | 2                             | 2  | 1                            | 2                                | 0   | 0                                | 0  | 0                                | 0                            | 6                               | 14                           | 18.00                            | 3.000                        |                                  |                                  |                                    |                                  |        |  |  |  |  |  |  |  |  |  |  |  |  |  |  |
| John Wyatt, R (6, 1)<br>ERA: 3.64                   | 2.2   |                                 | 10                           | 2                                | 1                             | 1  | 1                            | 1                                | 0   | 0                                | 0  | 0                                | 0                            | 11                              | 15                           | 3.38                             | 1.125                        |                                  |                                  |                                    |                                  |        |  |  |  |  |  |  |  |  |  |  |  |  |  |  |
| Ted Bowsfield, L (9, 1)<br>ERA: 4.32                | 0.1   | L                               | 3                            | 1                                | 0                             | 0  | 0                            | 0                                | 1   | 0                                | 0  | 0                                | 0                            | 2                               | 6                            | 0.00                             | 3.000                        |                                  |                                  |                                    |                                  |        |  |  |  |  |  |  |  |  |  |  |  |  |  |  |
| Ken Sanders, R (9, 1)<br>ERA: 2.4                   | 0.2   |                                 | 3                            | 1                                | 1                             | 1  | 1                            | 0                                | 0   | 0                                | 0  | 0                                | 0                            | 5                               | 5                            | 13.50                            | 1.500                        |                                  |                                  |                                    |                                  |        |  |  |  |  |  |  |  |  |  |  |  |  |  |  |

|     |    |
|-----|----|
| AB  | 31 |
| R   | 6  |
| H   | 9  |
| RBI | 6  |
| BB  | 10 |
| SO  | 10 |
| LOB | 18 |



| Batter  | 1   | 2                               | 3                            | 4                               | 5                               | 6                                | 7                            | 8                               | 9                                   | AB                              | R                            | H                               | RBI                          | BB                              | SO                           | LOB                              | BOTTOM                            |  |                                    |                                  |        |
|---|---|---------------------------------|------------------------------|---------------------------------|---------------------------------|----------------------------------|------------------------------|---------------------------------|-------------------------------------|---------------------------------|------------------------------|---------------------------------|------------------------------|---------------------------------|------------------------------|----------------------------------|-----------------------------------|--|------------------------------------|----------------------------------|--------|
| Bert Campaneris, R<br>OBP: 0.346, SLG: 0.447<br>Dick Green, R<br>OBP: 0.305, SLG: 0.382                           | 0-0<br>FC4-6<br>1B  |                                 | 0-0<br>S<br>1B               |                                 | 0-0<br>SH5-3<br>SF9<br>BB<br>1B |                                  | 0-0<br>F9<br>1B              | 0-0<br>F9                       |                                     | 4                               | 2                            | 3                               | 0                            | 0                               | 0                            | 0                                |                                   | <b>Cleveland Indians @ Kansas City Athletics</b><br>Municipal Stadium, Kansas City, MO<br>Sun Aug 30 1964, 4:38 AM EDT<br>Att. 6,724 - Unknown<br><a href="http://livebaseballscorecards.com">livebaseballscorecards.com</a> |                                    |                                  |        |
| Wayne Causey, L<br>OBP: 0.395, SLG: 0.401   | 0-0<br>FC4-6<br>FC6-4<br>1-2f   |                                 | 4-0<br>1B<br>BB              |                                 | 4-0<br>SF9<br>SH5-3<br>BB       |                                  | 0-0<br>1B<br>1B              |                                 | 4-0<br>FC5-6<br>BB                  | 2                               | 1                            | 1                               | 0                            | 3                               | 0                            | 1                                |                                   |  |                                    |                                  |        |
| Manny Jimenez, L<br>OBP: 0.296, SLG: 0.463<br>Jose Tartabull, L<br>OBP: 0.250, SLG: 0.247                         | 0-0<br>FC6-4<br>1B<br>1-2f  |                                 | 0-3<br>K                     |                                 | 0-0<br>SH5-3<br>1-2<br>2-3      |                                  | 0-0<br>F8                    |                                 | 0-0<br>FC5-6<br>FC3-6<br>BB<br>1-2f | 2                               | 0                            | 0                               | 0                            | 0                               | 1                            | 3                                |                                   |  |                                    |                                  |        |
| Rocky Colavito, R<br>OBP: 0.367, SLG: 0.543   | 0-0<br>1-3<br>1B  |                                 | 0-0<br>1-2<br>2-H<br>1B      |                                 | 0-0<br>SF9<br>2-3<br>3-H        |                                  | 0-0<br>1-2<br>E<br>1B        |                                 | 4-0<br>FC3-6<br>BB<br>1-2           | 3                               | 1                            | 3                               | 2                            | 1                               | 0                            | 0                                |                                   |  |                                    |                                  |        |
| Jim Gentile, L<br>OBP: 0.383, SLG: 0.493  | 0-3<br>K  |                                 | 0-3<br>K                     |                                 | 0-0<br>F5                       |                                  | 0-0<br>1-2<br>2-H<br>E<br>1B |                                 | 0-0<br>FC3-6<br>1-2f<br>2-3         | 5                               | 0                            | 1                               | 1                            | 0                               | 2                            | 7                                |                                   |  |                                    |                                  |        |
| Billy Bryan, L<br>OBP: 0.297, SLG: 0.497<br>George Alusik, R<br>OBP: 0.342, SLG: 0.347                            |   | 0-0<br>F8                       | 0-0<br>F8                    |                                 |                                 |                                  | 0-0<br>F8                    | 0-0<br>E5<br>1B<br>1-3<br>2-H   | 0-3<br>K                            | 4                               | 0                            | 1                               | 1                            | 0                               | 0                            | 2                                |                                   |  |                                    |                                  |        |
| Ed Charles, R<br>OBP: 0.314, SLG: 0.362   |   | 0-0<br>F7                       |                              | 0-0<br>F8                       |                                 | 0-0<br>F7                        | 0-0<br>F3                    |                                 |                                     | 4                               | 0                            | 0                               | 0                            | 0                               | 0                            | 2                                |                                   |  |                                    |                                  |        |
| Nelson Mathews, R<br>OBP: 0.298, SLG: 0.372   |   | 0-0<br>HR                       |                              | 0-0<br>4-3                      |                                 | 0-0<br>1B                        |                              | 0-0<br>6-3                      |                                     | 4                               | 1                            | 2                               | 1                            | 0                               | 0                            | 0                                |                                   |  |                                    |                                  |        |
| Bob Meyer, R<br>Jose Santiago, R<br>John Wyatt, R<br>Ted Bowsfield, R<br>OBP: 0.174, SLG: 0.095<br>Ken Sanders, R |   | 0-3<br>K                        |                              | 0-0<br>4-3                      |                                 | 0-0<br>F9                        |                              | 0-3<br>K                        |                                     | 2                               | 0                            | 0                               | 0                            | 0                               | 1                            | 0                                |                                   |  |                                    |                                  |        |
| <b>Inning Stats</b>   | R: 0<br>E: 0<br>K: 1<br>S: 7  | H: 2<br>LOB: 2<br>BB: 0<br>P: 7 | R: 1<br>E: 0<br>K: 1<br>S: 6 | H: 1<br>LOB: 0<br>BB: 0<br>P: 6 | R: 1<br>E: 0<br>K: 2<br>S: 9    | H: 2<br>LOB: 2<br>BB: 1<br>P: 13 | R: 0<br>E: 0<br>K: 0<br>S: 3 | H: 0<br>LOB: 0<br>BB: 0<br>P: 3 | R: 1<br>E: 0<br>K: 0<br>S: 4        | H: 1<br>LOB: 1<br>BB: 0<br>P: 4 | R: 2<br>E: 1<br>K: 0<br>S: 7 | H: 4<br>LOB: 2<br>BB: 0<br>P: 7 | R: 0<br>E: 0<br>K: 1<br>S: 5 | H: 0<br>LOB: 0<br>BB: 0<br>P: 5 | R: 0<br>E: 0<br>K: 1<br>S: 5 | H: 0<br>LOB: 2<br>BB: 2<br>P: 13 | 1B: 10<br>2B: 0<br>3B: 0<br>HR: 1 |  | SF: 1<br>SAC: 1<br>DP: 0<br>HBP: 0 | WP: 0<br>PB: 0<br>SB: 1<br>CS: 0 | PA: 42 |
| <b>PITCHER</b>  | IP<br>WLS<br>BF<br>H<br>R<br>ER<br>SO<br>BB<br>IBB<br>HBP<br>BLK<br>WP<br>HR<br>S<br>P<br>ERA<br>WHIP |                                 |                              |                                 |                                 |                                  |                              |                                 |                                     |                                 |                              |                                 |                              |                                 |                              |                                  |                                   |  |                                    |                                  |        |
| Dick Donovan, R<br>ERA: 4.61  | (1, 1)<br>6.2   |                                 |                              |                                 |                                 |                                  |                              |                                 |                                     |                                 |                              |                                 |                              |                                 |                              |                                  |                                   |  |                                    |                                  |        |
| Don McMahon, R<br>ERA: 1.56   | (7, 1)<br>0.1   |                                 |                              |                                 |                                 |                                  |                              |                                 |                                     |                                 |                              |                                 |                              |                                 |                              |                                  |                                   |  |                                    |                                  |        |
| Gary Bell, R<br>ERA: 4.48   | (8, 1)<br>1.0   | W                               | 4                            | 0                               | 0                               | 0                                | 1                            | 1                               | 0                                   | 0                               | 0                            | 0                               | 0                            | 0                               | 0                            | 0                                |                                   |  |                                    |                                  |        |
| Sam McDowell, L<br>ERA: 3.25  | (9, 1)<br>1.0   | S                               | 4                            | 0                               | 0                               | 0                                | 1                            | 1                               | 0                                   | 0                               | 0                            | 0                               | 0                            | 0                               | 0                            | 0                                |                                   |  |                                    |                                  |        |



| Batter  | 1   | 2                               | 3                            | 4                                | 5                            | 6                                | 7                            | 8                                | 9                            | AB R H RBI BB SO LOB                            | TOP                          |                                 |                              |                                  |                              |                                 |                              |                                 |                                  |                                    |                                  |        |
|---|---|---------------------------------|------------------------------|----------------------------------|------------------------------|----------------------------------|------------------------------|----------------------------------|------------------------------|---|------------------------------|---------------------------------|------------------------------|----------------------------------|------------------------------|---------------------------------|------------------------------|---------------------------------|----------------------------------|------------------------------------|----------------------------------|--------|
| <b>Chuck Schilling, R</b> (1, 4)<br><small>OBP: 0.279, SLG: 0.235</small>   | 0-0<br>6-3  | 0-0<br>FC6-4                    |                              | 0-0<br>1B                        |                              | 0-0<br>5-3                       |                              | 0-0<br>F8                        |                              | 5 0 1 0 0 0 4                                   |                              |                                 |                              |                                  |                              |                                 |                              |                                 |                                  |                                    |                                  |        |
| <b>Carl Yastrzemski, L</b> (1, 8)<br><small>OBP: 0.382, SLG: 0.471</small>  | 4-0<br>BB   |                                 | 0-0<br>G4-6-3 BB             | 0-0<br>1B                        |                              | 4-0<br>FC6-4 BB                  |                              | 0-0<br>4-3                       |                              | 3 0 2 1 2 0 0                                   |                              |                                 |                              |                                  |                              |                                 |                              |                                 |                                  |                                    |                                  |        |
| <b>Felix Mantilla, R</b> (1, 7)<br><small>OBP: 0.324, SLG: 0.495</small>  | 0-0<br>L8   |                                 | 4-0<br>G4-6-3 BB             | 0-0<br>F8                        |                              | 0-0<br>FC6-4                     |                              | 0-0<br>5-3                       |                              | 4 0 0 0 1 0 6                                   |                              |                                 |                              |                                  |                              |                                 |                              |                                 |                                  |                                    |                                  |        |
| <b>Lee Thomas, L</b> (1, 9)<br><small>OBP: 0.321, SLG: 0.396</small>  | 0-0<br>4-3  |                                 | 0-0<br>G4-6-3                | 0-0<br>F7                        |                              | 0-0<br>HR                        |                              | 0-0<br>SH5-3 1B                  |                              | 5 1 2 1 0 0 3                                   |                              |                                 |                              |                                  |                              |                                 |                              |                                 |                                  |                                    |                                  |        |
| <b>Bob Tillman, R</b> (1, 2)<br><small>OBP: 0.360, SLG: 0.451</small>   |   | 0-3<br>K                        | 4-0<br>BB                    |                                  | 0-0<br>F9                    |                                  | 0-0<br>F2                    |                                  | 0-0<br>SH5-3                 | 3 0 0 0 1 1 0                                   |                              |                                 |                              |                                  |                              |                                 |                              |                                 |                                  |                                    |                                  |        |
| <b>Tony Horton, R</b> (1, 3)<br><small>OBP: 0.271, SLG: 0.330</small><br><b>Dick Williams, R</b> (9, 3)<br><small>OBP: 0.243, SLG: 0.409</small>  |   | 0-0<br>F4                       | 0-0<br>5-3                   |                                  | 0-3<br>K                     |                                  | 0-0<br>6-3                   |                                  | 0-0<br>5-3                   | 5 0 0 0 0 1 3<br>0 0 0 0 0 0 0                  |                              |                                 |                              |                                  |                              |                                 |                              |                                 |                                  |                                    |                                  |        |
| <b>Eddie Bressoud, R</b> (1, 6)<br><small>OBP: 0.372, SLG: 0.469</small>  |   | 4-0<br>BB 1B BB                 |                              | 0-0<br>L7                        |                              | 0-0<br>SH5-4 E 1B                |                              | 0-0<br>2B                        |                              | 4 1 2 0 1 0 1                                   |                              |                                 |                              |                                  |                              |                                 |                              |                                 |                                  |                                    |                                  |        |
| <b>Al Smith, R</b> (1, 5)<br><small>OBP: 0.246, SLG: 0.266</small>  |   | 4-0<br>1B BB                    |                              | 4-0<br>1B BB                     |                              | 0-0<br>E6 SH5-4                  |                              | 4-0<br>BB                        |                              | 1 1 0 0 3 0 1                                   |                              |                                 |                              |                                  |                              |                                 |                              |                                 |                                  |                                    |                                  |        |
| <b>Jack Lamabe, R</b> (1, 1)<br><small>OBP: 0.176, SLG: 0.167</small><br><b>Dalton Jones, L</b> (7, PH)<br><small>OBP: 0.286, SLG: 0.346</small><br><b>Dick Radatz, R</b> (7, 1)<br><small>OBP: 0.176, SLG: 0.182</small> |   | 0-0<br>FC6-4 1B                 |                              | 0-3<br>K                         |                              | 0-0<br>SH5-4                     |                              | 0-3<br>K                         |                              | 2 0 1 1 0 1 1<br>1 0 0 0 0 1 2<br>0 0 0 0 0 0 0 |                              |                                 |                              |                                  |                              |                                 |                              |                                 |                                  |                                    |                                  |        |
| <b>Inning Stats</b>   | R: 0<br>E: 0<br>K: 0<br>S: 3                          | H: 0<br>LOB: 1<br>BB: 1<br>P: 7 | R: 1<br>E: 0<br>K: 1<br>S: 6 | H: 1<br>LOB: 2<br>BB: 2<br>P: 14 | R: 0<br>E: 0<br>K: 0<br>S: 3 | H: 1<br>LOB: 2<br>BB: 2<br>P: 11 | R: 1<br>E: 0<br>K: 1<br>S: 7 | H: 2<br>LOB: 2<br>BB: 1<br>P: 11 | R: 0<br>E: 0<br>K: 1<br>S: 5 | H: 0<br>LOB: 0<br>BB: 0<br>P: 5                 | R: 0<br>E: 1<br>K: 0<br>S: 5 | H: 1<br>LOB: 3<br>BB: 1<br>P: 9 | R: 1<br>E: 0<br>K: 1<br>S: 7 | H: 2<br>LOB: 2<br>BB: 1<br>P: 11 | R: 0<br>E: 0<br>K: 0<br>S: 3 | H: 0<br>LOB: 0<br>BB: 0<br>P: 3 | R: 0<br>E: 0<br>K: 0<br>S: 4 | H: 1<br>LOB: 1<br>BB: 0<br>P: 4 | 1B: 6<br>2B: 1<br>3B: 0<br>HR: 1 | SF: 0<br>SAC: 2<br>DP: 1<br>HBP: 0 | WP: 0<br>PB: 0<br>SB: 0<br>CS: 0 | PA: 43 |
| <b>PITCHER</b>  | IP WLS BF H R ER SO BB IBB HBP BLK WP HR S P ERA WHIP |                                 |                              |                                  |                              |                                  |                              |                                  |                              |   |                              |                                 |                              |                                  |                              |                                 |                              |                                 |                                  |                                    |                                  |        |
| <b>Diego Segui, R</b> (1, 1)<br><small>ERA: 4.24</small><br><b>Wes Stock, R</b> (7, 1)<br><small>ERA: 2.44</small><br><b>John Wyatt, R</b> (8, 1)<br><small>ERA: 3.57</small>   | 6.2 L 34 7 3 3 3 7 0 0 0 0 1 33 61 4.05 2.100         |                                 |                              |                                  |                              |                                  |                              |                                  |                              |   |                              |                                 |                              |                                  |                              |                                 |                              |                                 |                                  |                                    |                                  |        |

**Boston Red Sox @ Kansas City Athletics**  
Municipal Stadium, Kansas City, MO

|     |    |
|-----|----|
| AB  | 33 |
| R   | 3  |
| H   | 8  |
| RBI | 3  |
| BB  | 8  |
| SO  | 4  |
| LOB | 21 |



Tue Sep 01 1964, 8:05 PM EDT  
Att. 2,694 - Unknown

[livebaseballscorecards.com](http://livebaseballscorecards.com)

| Batter   | 1                | 2               | 3         | 4                | 5                     | 6 | 7 | 8                              | 9 | AB | R | H | RBI | BB | SO | LOB |
|--|------------------|-----------------|-----------|------------------|-----------------------|---|---|--------------------------------|---|----|---|---|-----|----|----|-----|
| Bert Campaneris, R<br>OBP: 0.350, SLG: 0.451<br>(1, 7) | 0-0<br>6-3<br>1B | 0-0<br>L8       |           |                  | 0-0<br>2B             |   |   | 4-0<br>BB<br>E S<br>BB         |   | 3  | 0 | 1 | 0   | 1  | 0  | 1   |
| Wayne Causey, L<br>OBP: 0.398, SLG: 0.404<br>(1, 6)    | 0-0<br>HR<br>1B  |                 | 0-0<br>1B |                  | 0-0<br>G6-4-3<br>1B   |   |   | 0-0<br>F8<br>1-3               |   | 4  | 1 | 3 | 0   | 0  | 0  | 1   |
| Nelson Mathews, R<br>OBP: 0.298, SLG: 0.377<br>(1, 8)  | 0-0<br>1-H<br>HR |                 | 0-3<br>K  |                  | 0-0<br>G6-4-3<br>1-2f |   |   | 0-0<br>6-3                     |   | 4  | 1 | 1 | 2   | 0  | 1  | 3   |
| Rocky Colavito, R<br>OBP: 0.366, SLG: 0.541<br>(1, 9)  | 0-0<br>1B        |                 | 0-0<br>F8 |                  |                       |   |   | 0-0<br>L8                      |   | 4  | 0 | 1 | 0   | 0  | 0  | 2   |
| Jim Gentile, L<br>OBP: 0.382, SLG: 0.488<br>(1, 3)     | 4-0<br>BB        |                 | 0-3<br>K  |                  |                       |   |   | 0-0<br>4-3                     |   | 3  | 0 | 0 | 0   | 1  | 1  | 1   |
| Billy Bryan, L<br>OBP: 0.291, SLG: 0.486<br>(1, 2)     | 0-0<br>G3        |                 | 0-3<br>K  |                  |                       |   |   | 0-0<br>F9                      |   | 4  | 0 | 0 | 0   | 0  | 1  | 1   |
| Ed Charles, R<br>OBP: 0.315, SLG: 0.363<br>(1, 5)      |                  | 0-0<br>S<br>1B  |           | 0-0<br>G3<br>1B  |                       |   |   | 0-0<br>E5<br>FC6-4             |   | 4  | 0 | 2 | 0   | 0  | 0  | 0   |
| Dick Green, R<br>OBP: 0.303, SLG: 0.379<br>(1, 4)      |                  | 0-3<br>K<br>1-2 |           | 0-0<br>G3<br>1-2 |                       |   |   | 0-0<br>FC6-4<br>G6-4-3<br>1-2f |   | 3  | 0 | 0 | 0   | 0  | 1  | 3   |
| Diego Segui, R<br>OBP: 0.227, SLG: 0.242<br>(1, 1)     |                  | 0-3<br>K        |           | 0-3<br>K         |                       |   |   | 0-0<br>G6-4-3<br>1-2f          |   | 2  | 0 | 0 | 0   | 0  | 2  | 2   |
| Wes Stock, R<br>OBP: 0.235, SLG: 0.188<br>(7, 1)       |                  |                 |           |                  |                       |   |   |                                |   | 0  | 0 | 0 | 0   | 0  | 0  | 0   |
| Manny Jimenez, L<br>OBP: 0.295, SLG: 0.460<br>(7, PH)  |                  |                 |           |                  |                       |   |   |                                |   | 1  | 0 | 0 | 0   | 0  | 0  | 1   |
| John Wyatt, R<br>(8, 1)                                |                  |                 |           |                  |                       |   |   |                                |   | 0  | 0 | 0 | 0   | 0  | 0  | 0   |

| Inning Stats | R: 2 | H: 3 | E: 0 | K: 0 | S: 5 | H: 3 | LOB: 1 | BB: 1 | P: 9 | R: 0 | H: 1 | E: 0 | K: 2 | S: 8 | H: 1 | LOB: 1 | BB: 0 | P: 8 | R: 0 | H: 1 | E: 0 | K: 2 | S: 8 | H: 1 | LOB: 1 | BB: 0 | P: 8 | R: 0 | H: 2 | E: 0 | K: 0 | S: 3 | H: 0 | LOB: 0 | BB: 0 | P: 3 | R: 0 | H: 0 | E: 1 | K: 0 | S: 3 | H: 0 | LOB: 0 | BB: 0 | P: 3 | R: 0 | H: 0 | E: 0 | K: 0 | S: 3 | H: 0 | LOB: 1 | BB: 1 | P: 7 | R: 0 | H: 0 | E: 0 | K: 0 | S: 3 | H: 0 | LOB: 0 | BB: 0 | P: 3 |
|--------------|------|------|------|------|------|------|--------|-------|------|------|------|------|------|------|------|--------|-------|------|------|------|------|------|------|------|--------|-------|------|------|------|------|------|------|------|--------|-------|------|------|------|------|------|------|------|--------|-------|------|------|------|------|------|------|------|--------|-------|------|------|------|------|------|------|------|--------|-------|------|
|--------------|------|------|------|------|------|------|--------|-------|------|------|------|------|------|------|------|--------|-------|------|------|------|------|------|------|------|--------|-------|------|------|------|------|------|------|------|--------|-------|------|------|------|------|------|------|------|--------|-------|------|------|------|------|------|------|------|--------|-------|------|------|------|------|------|------|------|--------|-------|------|

| PITCHER                               | IP  | WLS | BF | H | R | ER | SO | BB | IBB | HBP | BLK | WP | HR | S  | P  | ERA  | WHIP  |
|---------------------------------------|-----|-----|----|---|---|----|----|----|-----|-----|-----|----|----|----|----|------|-------|
| Jack Lamabe, R<br>ERA: 5.24<br>(1, 1) | 6.0 | W   | 24 | 8 | 2 | 2  | 6  | 1  | 0   | 0   | 0   | 0  | 1  | 35 | 39 | 3.00 | 1.500 |
| Dick Radatz, R<br>ERA: 1.93<br>(7, 1) | 3.0 | S   | 10 | 0 | 0 | 0  | 0  | 1  | 0   | 0   | 0   | 0  | 0  | 9  | 13 | 0.00 | 0.333 |

**BOTTOM**

**Boston Red Sox @ Kansas City Athletics**  
**Municipal Stadium, Kansas City, MO**

Tue Sep 01 1964, 8:05 PM EDT  
 Att. 2,694 - Unknown

livebaseballscorecards.com

|            |           |
|------------|-----------|
| <b>AB</b>  | <b>32</b> |
| <b>R</b>   | <b>2</b>  |
| <b>H</b>   | <b>8</b>  |
| <b>RBI</b> | <b>2</b>  |
| <b>BB</b>  | <b>2</b>  |
| <b>SO</b>  | <b>6</b>  |
| <b>LOB</b> | <b>15</b> |



|              |               |
|--------------|---------------|
| <b>WP: 0</b> | <b>PA: 34</b> |
| <b>PB: 0</b> | <b>SAC: 0</b> |
| <b>SB: 2</b> | <b>DP: 2</b>  |
| <b>CS: 0</b> | <b>HBP: 0</b> |

| Batter   | 1   | 2   | 3   | 4   | 5   | 6   | 7  | 8   | 9  | AB R H RBI BB SO LOB | TOP   |   |
|--|---|---|---|---|---|---|--|---|--|----------------------|---|---|
| <b>Chuck Schilling, R</b> (1, 4)<br><small>OBP: 0.283, SLG: 0.241</small>  | 0-3<br>   |   | 0-0<br>   |   | 0-0<br>   |   | 0-0<br>  |   | 0-0<br>  | 5 0 2 0 0 1 0        | <b>Boston Red Sox @ Kansas City Athletics</b><br>Municipal Stadium, Kansas City, MO<br>Wed Sep 02 1964, 8:05 PM EDT<br>Att. 2,737 - Unknown |   |
| <b>Felix Mantilla, R</b> (1, 7)<br><small>OBP: 0.328, SLG: 0.505</small>   | 0-0<br>   |   | 0-0<br>   |   | 1-0<br>   |   | 0-0<br>  | 0-0<br>   | 4 1 2 1 0 0 2  |                      |   |   |
| <b>Carl Yastrzemski, L</b> (1, 8)<br><small>OBP: 0.384, SLG: 0.471</small>   | 4-0<br>   |   | 0-0<br>   |   | 0-0<br>   |   | 0-0<br>  | 0-0<br>   | 4 1 2 0 1 0 4  |                      |   |   |
| <b>Al Smith, R</b> (1, 5)<br><small>OBP: 0.244, SLG: 0.270</small>   | 0-0<br>   |   | 0-0<br>   |   |   |   | 0-3<br>  | 0-0<br>   | 5 1 1 0 0 1 6  |                      |   |   |
| <b>Lee Thomas, L</b> (1, 9)<br><small>OBP: 0.324, SLG: 0.411</small>   |   | 0-0<br>   |   | 0-0<br>   |   | 0-0<br>   |  | 0-0<br>   | 5 2 3 3 0 0 1  |                      |   |   |
| <b>Tony Horton, R</b> (1, 3)<br><small>OBP: 0.268, SLG: 0.324</small>  |   | 0-0<br>   |   | 0-0<br>   |   | 0-0<br>   |  | 0-0<br>   | 5 0 1 1 0 0 2  |                      |   |   |
| <b>Eddie Bressoud, R</b> (1, 6)<br><small>OBP: 0.369, SLG: 0.465</small>   |   | 0-3<br>   |   | 0-3<br>   |   | 0-0<br>   |  | 0-3<br>   | 4 0 0 0 0 3 1  |                      |   |   |
| <b>Bob Tillman, R</b> (1, 2)<br><small>OBP: 0.356, SLG: 0.446</small>  |   | 0-3<br>   |   | 0-0<br>   |   | 0-0<br>   |  | 0-3<br>   | 4 0 0 0 0 2 1  |                      |   |   |
| <b>Bill Monbouquette, R</b> (1, 1)<br><small>OBP: 0.194, SLG: 0.127</small><br><b>Jay Ritchie, R</b> (3, 1)<br><small>OBP: 0.250, SLG: 0.250</small><br><b>Ed Connolly, L</b> (4, 1)<br><small>OBP: 0.156, SLG: 0.083</small><br><b>Dalton Jones, L</b> (5, PH)<br><small>OBP: 0.285, SLG: 0.345</small><br><b>Dave Morehead, R</b> (5, 1)<br><small>OBP: 0.164, SLG: 0.118</small><br><b>Roman Mejias, R</b> (7, PH)<br><small>OBP: 0.263, SLG: 0.353</small><br><b>Pete Charton, L</b> (7, 1)<br><small>OBP: 0.306, SLG: 0.305</small> |   | 0-3<br>   | 0-3<br>   |   | 0-0<br>   |   | 4-0<br>  | 0-3<br>   | 1 0 0 0 0 1 0<br>0 0 0 0 0 0 0<br>0 0 0 0 0 0 0<br>1 0 0 0 0 0 0<br>0 0 0 0 0 0 0<br>0 0 0 0 1 0 0<br>0 0 0 0 0 0 0<br>1 0 0 0 0 1 0 |                      |   |   |
| <b>Inning Stats</b>  | R: 0 H: 0<br>E: 0 LOB: 1<br>K: 1 BB: 1<br>S: 5 P: 9   | R: 1 H: 1<br>E: 0 LOB: 0<br>K: 2 BB: 0<br>S: 8 P: 8 | R: 0 H: 2<br>E: 0 LOB: 2<br>K: 1 BB: 0<br>S: 7 P: 7 | R: 0 H: 0<br>E: 0 LOB: 0<br>K: 1 BB: 0<br>S: 5 P: 5 | R: 0 H: 1<br>E: 0 LOB: 2<br>K: 0 BB: 0<br>S: 4 P: 5 | R: 1 H: 2<br>E: 0 LOB: 1<br>K: 0 BB: 0<br>S: 5 P: 5 | R: 0 H: 1<br>E: 0 LOB: 2<br>K: 1 BB: 1<br>S: 6 P: 10 | R: 1 H: 1<br>E: 0 LOB: 0<br>K: 2 BB: 0<br>S: 8 P: 8 | R: 2 H: 3<br>E: 1 LOB: 2<br>K: 1 BB: 0<br>S: 9 P: 9  |                      |   | 1B: 7 SF: 0<br>2B: 1 SAC: 0<br>3B: 0 DP: 0<br>HR: 3 HBP: 1  |
| <b>PITCHER</b><br><b>Orlando Pena, R</b> (1, 1)<br><small>ERA: 4.36</small><br><b>Ken Sanders, R</b> (9, 1)<br><small>ERA: 2.35</small>  | IP WLS BF H R ER SO BB IBB HBP BLK WP HR S P ERA WHIP<br>8.2 W 41 11 5 4 9 2 0 1 0 0 3 56 65 4.15 1.500 |   |   |   |   |   |  |   |  |                      |   | IP WLS BF H R ER SO BB IBB HBP BLK WP HR S P ERA WHIP<br>0.1 S 1 0 0 0 0 0 0 0 0 0 0 1 1 0.00 0.000 |

| Batter  | 1          | 2               | 3                        | 4                          | 5               | 6         | 7          | 8               | 9          | AB | R | H | RBI | BB | SO | LOB |
|---|------------|-----------------|--------------------------|----------------------------|-----------------|-----------|------------|-----------------|------------|----|---|---|-----|----|----|-----|
| <b>Bert Campaneris, R</b><br>OBP: 0.354, SLG: 0.453<br>(1, 7)                       | 0-0<br>5-3 |                 | 0-0<br>1B WP<br>E<br>1B  | 0-0<br>SH3-4               | 0-0<br>1B       |           | 0-0<br>F8  |                 |            | 4  | 1 | 2 | 2   | 0  | 0  | 1   |
| <b>Wayne Causey, L</b><br>OBP: 0.398, SLG: 0.402<br>(1, 6)                          | 0-0<br>F8  |                 | 0-0<br>1B<br>E<br>1B     | 4-0<br>WP<br>E<br>1B<br>BB | 0-0<br>F5       |           | 0-0<br>5-3 |                 |            | 4  | 2 | 1 | 0   | 1  | 0  | 3   |
| <b>Rocky Colavito, R</b><br>OBP: 0.366, SLG: 0.538<br>(1, 9)                        | 0-0<br>6-3 |                 | 0-0<br>E5<br>1B<br>1B    | 0-0<br>WP<br>1B            | 0-3<br>K        |           |            | 4-0<br>HR<br>BB |            | 4  | 2 | 1 | 1   | 1  | 1  | 3   |
| <b>Jim Gentile, L</b><br>OBP: 0.394, SLG: 0.497<br>(1, 3)                           |            | 0-0<br>F7       | 0-0<br>1B<br>1B<br>1B    | 0-0<br>G3                  |                 | 4-0<br>BB |            | 0-0<br>HR       |            | 4  | 1 | 2 | 3   | 1  | 0  | 1   |
| <b>Doc Edwards, R</b><br>OBP: 0.254, SLG: 0.295<br>(1, 2)                           |            | 0-0<br>4-3      | 0-0<br>1B<br>1B          | 4-0<br>FC6-4<br>BB         |                 | 0-3<br>K  |            | 0-0<br>L9       |            | 4  | 0 | 1 | 1   | 1  | 1  | 1   |
| <b>Ed Charles, R</b><br>OBP: 0.316, SLG: 0.363<br>(1, 5)                            |            | 0-0<br>1B<br>1B | 0-0<br>1B<br>1B          | 0-0<br>FC6-4               |                 | 0-3<br>K  |            | 0-0<br>F6       |            | 5  | 0 | 2 | 0   | 0  | 1  | 3   |
| <b>Nelson Mathews, R</b><br>OBP: 0.299, SLG: 0.380<br>(1, 8)                        |            | 0-0<br>1B       | 0-0<br>F6                |                            | 0-0<br>1B<br>2B |           | 0-3<br>K   |                 | 0-0<br>6-3 | 5  | 1 | 2 | 0   | 0  | 1  | 4   |
| <b>Dick Green, R</b><br>OBP: 0.305, SLG: 0.383<br>(1, 4)                            |            |                 | 0-0<br>SH3-4<br>1B<br>2B |                            | 0-0<br>F9       |           | 0-0<br>1B  |                 |            | 4  | 1 | 2 | 0   | 0  | 0  | 4   |
| <b>Orlando Pena, R</b><br>OBP: 0.178, SLG: 0.191<br><b>Ken Sanders, R</b><br>(9, 1) |            |                 | 0-0<br>SH3-4             | 0-0<br>SH3-4<br>WP<br>2B   | 4-0<br>1B<br>BB |           | 0-3<br>K   |                 |            | 2  | 1 | 1 | 0   | 1  | 1  | 1   |
|   |            |                 |                          |                            |                 |           |            |                 |            | 0  | 0 | 0 | 0   | 0  | 0  | 0   |

| Inning Stats                                       | R: 0 | H: 0 | E: 0 | K: 0 | S: 3 | LOB: 0 | BB: 0 | P: 3 | R: 0 | H: 2 | E: 0 | K: 0 | S: 4 | LOB: 2 | BB: 0 | P: 4  | R: 4  | H: 6   | E: 1  | K: 0  | S: 10 | LOB: 3 | BB: 0  | P: 10 | R: 2   | H: 2  | E: 1  | K: 0  | S: 5  | LOB: 2 | BB: 2 | P: 13 | R: 1 | H: 2 | E: 0 | K: 1 | S: 7 | LOB: 2 | BB: 1 | P: 11 | R: 0 | H: 0 | E: 0 | K: 3 | S: 9 | LOB: 1 | BB: 1 | P: 13 | R: 0 | H: 1 | E: 0 | K: 1 | S: 6 | LOB: 1 | BB: 0 | P: 6 | R: 2 | H: 1 | E: 0 | K: 0 | S: 4 | LOB: 0 | BB: 1 | P: 8 |
|--|------|------|------|------|------|--------|-------|------|------|------|------|------|------|--------|-------|-------|-------|--------|-------|-------|-------|--------|--------|-------|--------|-------|-------|-------|-------|--------|-------|-------|------|------|------|------|------|--------|-------|-------|------|------|------|------|------|--------|-------|-------|------|------|------|------|------|--------|-------|------|------|------|------|------|------|--------|-------|------|
| <b>PITCHER</b>                                     | IP   | WLS  | BF   | H    | R    | ER     | SO    | BB   | IBB  | HBP  | BLK  | WP   | HR   | S      | P     | ERA   | WHIP  |        |       |       |       |        |        |       |        |       |       |       |       |        |       |       |      |      |      |      |      |        |       |       |      |      |      |      |      |        |       |       |      |      |      |      |      |        |       |      |      |      |      |      |      |        |       |      |
| <b>Bill Monbouquette, R</b><br>ERA: 4.97<br>(1, 1) | 2.1  | L    | 14   | 7    | 4    | 3      | 0     | 0    | 0    | 0    | 0    | 1    | 0    | 14     | 14    | 11.57 | 3.000 |        |       |       |       |        |        |       |        |       |       |       |       |        |       |       |      |      |      |      |      |        |       |       |      |      |      |      |      |        |       |       |      |      |      |      |      |        |       |      |      |      |      |      |      |        |       |      |
| <b>Jay Ritchie, R</b><br>ERA: 3.0<br>(3, 1)        | 1.0  |      | 7    | 3    | 2    | 1      | 0     | 1    | 0    | 0    | 0    | 0    | 0    | 6      | 10    | 9.00  | 4.000 |        |       |       |       |        |        |       |        |       |       |       |       |        |       |       |      |      |      |      |      |        |       |       |      |      |      |      |      |        |       |       |      |      |      |      |      |        |       |      |      |      |      |      |      |        |       |      |
| <b>Ed Connolly, L</b><br>ERA: 5.03<br>(4, 1)       | 0.2  |      | 3    | 0    | 0    | 0      | 0     | 1    | 0    | 0    | 0    | 1    | 0    | 2      | 6     | 0.00  | 1.500 |        |       |       |       |        |        |       |        |       |       |       |       |        |       |       |      |      |      |      |      |        |       |       |      |      |      |      |      |        |       |       |      |      |      |      |      |        |       |      |      |      |      |      |      |        |       |      |
| <b>Dave Morehead, R</b><br>ERA: 4.98<br>(5, 1)     | 2.0  |      | 10   | 2    | 1    | 1      | 4     | 2    | 0    | 0    | 0    | 0    | 0    | 16     | 24    | 4.50  | 2.000 |        |       |       |       |        |        |       |        |       |       |       |       |        |       |       |      |      |      |      |      |        |       |       |      |      |      |      |      |        |       |       |      |      |      |      |      |        |       |      |      |      |      |      |      |        |       |      |
| <b>Pete Charton, R</b><br>ERA: 7.44<br>(7, 1)      | 2.0  |      | 9    | 2    | 2    | 2      | 1     | 1    | 0    | 0    | 0    | 0    | 0    | 10     | 14    | 9.00  | 1.500 |        |       |       |       |        |        |       |        |       |       |       |       |        |       |       |      |      |      |      |      |        |       |       |      |      |      |      |      |        |       |       |      |      |      |      |      |        |       |      |      |      |      |      |      |        |       |      |
| <b>PITCHER</b>                                     | IP   | WLS  | BF   | H    | R    | ER     | SO    | BB   | IBB  | HBP  | BLK  | WP   | HR   | S      | P     | ERA   | WHIP  | 1B: 10 | 2B: 3 | 3B: 0 | HR: 1 | SF: 0  | SAC: 2 | DP: 0 | HBP: 0 | WP: 2 | PB: 0 | SB: 0 | CS: 0 | PA: 43 |       |       |      |      |      |      |      |        |       |       |      |      |      |      |      |        |       |       |      |      |      |      |      |        |       |      |      |      |      |      |      |        |       |      |

**BOTTOM**

**Boston Red Sox @ Kansas City Athletics**  
Municipal Stadium, Kansas City, MO

Wed Sep 02 1964, 8:05 PM EDT  
Att. 2,737 - Unknown

livebaseballscorecards.com

|            |           |
|------------|-----------|
| <b>AB</b>  | <b>36</b> |
| <b>R</b>   | <b>9</b>  |
| <b>H</b>   | <b>14</b> |
| <b>RBI</b> | <b>7</b>  |
| <b>BB</b>  | <b>5</b>  |
| <b>SO</b>  | <b>5</b>  |
| <b>LOB</b> | <b>21</b> |



| Batter   | 1   | 2                               | 3                            | 4                                | 5                            | 6                               | 7                            | 8                               | 9                            | AB R H RBI BB SO LOB             | TOP                          |                                  |                              |                                 |                              |                                 |                              |                                 |                                  |                                    |                                  |        |  |  |  |  |  |  |  |  |
|--|---|---------------------------------|------------------------------|----------------------------------|------------------------------|---------------------------------|------------------------------|---------------------------------|------------------------------|----------------------------------|------------------------------|----------------------------------|------------------------------|---------------------------------|------------------------------|---------------------------------|------------------------------|---------------------------------|----------------------------------|------------------------------------|----------------------------------|--------|--|--|--|--|--|--|--|--|
| <b>Chuck Schilling, R</b> (1, 4)<br><small>OBP: 0.282, SLG: 0.236</small>  | 0-0<br>   | 4-0<br>                         |                              | 0-0<br>                          |                              | 0-0<br>                         | 0-0<br>                      |                                 |                              | 3 0 0 0 1 0 2                    |                              |                                  |                              |                                 |                              |                                 |                              |                                 |                                  |                                    |                                  |        |  |  |  |  |  |  |  |  |
| <b>Felix Mantilla, R</b> (1, 7)<br><small>OBP: 0.334, SLG: 0.527</small>   | 0-0<br>   | 0-0<br>                         |                              |                                  | 0-0<br>                      | 0-0<br>                         |                              | 0-0<br>                         |                              | 5 2 4 3 0 0 2                    |                              |                                  |                              |                                 |                              |                                 |                              |                                 |                                  |                                    |                                  |        |  |  |  |  |  |  |  |  |
| <b>Carl Yastrzemski, L</b> (1, 8)<br><small>OBP: 0.384, SLG: 0.469</small>   | 0-0<br>   |                                 | 0-0<br>                      |                                  | 4-0<br>                      | 0-0<br>                         |                              | 0-0<br>                         |                              | 4 1 1 0 1 0 2                    |                              |                                  |                              |                                 |                              |                                 |                              |                                 |                                  |                                    |                                  |        |  |  |  |  |  |  |  |  |
| <b>Dick Stuart, R</b> (1, 3)<br><small>OBP: 0.313, SLG: 0.488</small>  | 0-0<br>   |                                 | 0-0<br>                      |                                  | 0-0<br>                      | 0-3<br>                         |                              | 0-3<br>                         |                              | 5 0 2 0 0 2 2                    |                              |                                  |                              |                                 |                              |                                 |                              |                                 |                                  |                                    |                                  |        |  |  |  |  |  |  |  |  |
| <b>Lee Thomas, L</b> (1, 9)<br><small>OBP: 0.327, SLG: 0.409</small>   | 0-0<br>   |                                 | 4-0<br>                      |                                  | 4-0<br>                      |                                 | 1-0<br>                      | 0-0<br>                         |                              | 2 0 0 0 2 0 2                    |                              |                                  |                              |                                 |                              |                                 |                              |                                 |                                  |                                    |                                  |        |  |  |  |  |  |  |  |  |
| <b>Frank Malzone, R</b> (1, 5)<br><small>OBP: 0.312, SLG: 0.367</small>  |   | 0-0<br>                         | 0-3<br>                      |                                  | 0-0<br>                      | 0-0<br>                         |                              | 4-0<br>                         |                              | 3 2 1 1 1 1 2                    |                              |                                  |                              |                                 |                              |                                 |                              |                                 |                                  |                                    |                                  |        |  |  |  |  |  |  |  |  |
| <b>Eddie Bressoud, R</b> (1, 6)<br><small>OBP: 0.367, SLG: 0.468</small>   |   | 0-3<br>                         |                              | 0-0<br>                          | 0-3<br>                      | 0-0<br>                         |                              | 0-0<br>                         |                              | 5 1 1 2 0 2 4                    |                              |                                  |                              |                                 |                              |                                 |                              |                                 |                                  |                                    |                                  |        |  |  |  |  |  |  |  |  |
| <b>Bob Tillman, R</b> (1, 2)<br><small>OBP: 0.359, SLG: 0.449</small>  |   | 4-0<br>                         |                              | 0-0<br>                          | 0-0<br>                      |                                 | 0-0<br>                      | 0-0<br>                         |                              | 4 0 2 0 1 0 3                    |                              |                                  |                              |                                 |                              |                                 |                              |                                 |                                  |                                    |                                  |        |  |  |  |  |  |  |  |  |
| <b>Earl Wilson, R</b> (1, 1)<br><small>OBP: 0.292, SLG: 0.462</small><br><b>Dick Radatz, R</b> (6, 1)<br><small>OBP: 0.167, SLG: 0.171</small> |   | 0-0<br>                         |                              | 0-0<br>                          |                              | 4-0<br>                         | 0-3<br>                      | 0-3<br>                         |                              | 2 1 0 1 1 0 2<br>2 0 0 0 0 2 2   |                              |                                  |                              |                                 |                              |                                 |                              |                                 |                                  |                                    |                                  |        |  |  |  |  |  |  |  |  |
| <b>Inning Stats</b>  | R: 0<br>E: 0<br>K: 0<br>S: 5                          | H: 2<br>LOB: 2<br>BB: 0<br>P: 5 | R: 1<br>E: 0<br>K: 1<br>S: 6 | H: 1<br>LOB: 2<br>BB: 2<br>P: 14 | R: 0<br>E: 0<br>K: 1<br>S: 5 | H: 0<br>LOB: 1<br>BB: 1<br>P: 9 | R: 0<br>E: 0<br>K: 0<br>S: 4 | H: 1<br>LOB: 1<br>BB: 0<br>P: 4 | R: 2<br>E: 0<br>K: 1<br>S: 7 | H: 2<br>LOB: 2<br>BB: 2<br>P: 15 | R: 1<br>E: 0<br>K: 1<br>S: 6 | H: 1<br>LOB: 1<br>BB: 1<br>P: 10 | R: 2<br>E: 0<br>K: 1<br>S: 7 | H: 2<br>LOB: 1<br>BB: 0<br>P: 8 | R: 1<br>E: 0<br>K: 1<br>S: 6 | H: 2<br>LOB: 0<br>BB: 0<br>P: 6 | R: 0<br>E: 0<br>K: 1<br>S: 5 | H: 0<br>LOB: 1<br>BB: 1<br>P: 9 | 1B: 7<br>2B: 2<br>3B: 0<br>HR: 3 | SF: 1<br>SAC: 1<br>DP: 1<br>HBP: 1 | WP: 1<br>PB: 0<br>SB: 0<br>CS: 1 | PA: 45 |  |  |  |  |  |  |  |  |
| <b>PITCHER</b>   | IP WLS BF H R ER SO BB IBB HBP BLK WP HR S P ERA WHIP |                                 |                              |                                  |                              |                                 |                              |                                 |                              |                                  |                              |                                  |                              |                                 |                              |                                 |                              |                                 |                                  |                                    |                                  |        |  |  |  |  |  |  |  |  |
| <b>Moe Drabowsky, R</b> (1, 1)<br><small>ERA: 5.24</small>   | 4.0   |                                 | 22                           | 6                                | 3                            | 3                               | 2                            | 4                               | 0                            | 0                                | 0                            | 1                                | 1                            | 22                              | 38                           | 6.75                            | 2.500                        |                                 |                                  |                                    |                                  |        |  |  |  |  |  |  |  |  |
| <b>Wes Stock, R</b> (5, 1)<br><small>ERA: 2.58</small>   | 2.0   |                                 | 10                           | 1                                | 2                            | 2                               | 2                            | 2                               | 0                            | 1                                | 0                            | 0                                | 0                            | 11                              | 20                           | 9.00                            | 1.500                        |                                 |                                  |                                    |                                  |        |  |  |  |  |  |  |  |  |
| <b>John Wyatt, R</b> (7, 1)<br><small>ERA: 3.67</small>  | 2.0   | L                               | 9                            | 4                                | 2                            | 2                               | 2                            | 0                               | 0                            | 0                                | 0                            | 0                                | 2                            | 13                              | 13                           | 9.00                            | 2.000                        |                                 |                                  |                                    |                                  |        |  |  |  |  |  |  |  |  |
| <b>Ken Sanders, R</b> (9, 1)<br><small>ERA: 2.2</small>  | 1.0   |                                 | 4                            | 0                                | 0                            | 0                               | 1                            | 1                               | 0                            | 0                                | 0                            | 0                                | 0                            | 5                               | 9                            | 0.00                            | 1.000                        |                                 |                                  |                                    |                                  |        |  |  |  |  |  |  |  |  |

**Boston Red Sox @ Kansas City Athletics**  
 Municipal Stadium, Kansas City, MO  
 Thu Sep 03 1964, 8:05 PM EDT  
 Att. 2,710 - Unknown

|     |    |
|-----|----|
| AB  | 35 |
| R   | 7  |
| H   | 11 |
| RBI | 7  |
| BB  | 7  |
| SO  | 7  |
| LOB | 23 |

|       |        |
|-------|--------|
| WP: 1 | PA: 45 |
| PB: 0 |        |
| SB: 0 |        |
| CS: 1 |        |

| PITCHER          | IP  | WLS | BF | H | R | ER | SO | BB | IBB | HBP | BLK | WP | HR | S  | P  | ERA  | WHIP  |
|------------------|-----|-----|----|---|---|----|----|----|-----|-----|-----|----|----|----|----|------|-------|
| Moe Drabowsky, R | 4.0 |     | 22 | 6 | 3 | 3  | 2  | 4  | 0   | 0   | 0   | 1  | 1  | 22 | 38 | 6.75 | 2.500 |
| Wes Stock, R     | 2.0 |     | 10 | 1 | 2 | 2  | 2  | 2  | 0   | 1   | 0   | 0  | 0  | 11 | 20 | 9.00 | 1.500 |
| John Wyatt, R    | 2.0 | L   | 9  | 4 | 2 | 2  | 2  | 0  | 0   | 0   | 0   | 0  | 2  | 13 | 13 | 9.00 | 2.000 |
| Ken Sanders, R   | 1.0 |     | 4  | 0 | 0 | 0  | 1  | 1  | 0   | 0   | 0   | 0  | 0  | 5  | 9  | 0.00 | 1.000 |



| Batter  | 1                     | 2                  | 3          | 4               | 5         | 6                  | 7          | 8         | 9         | AB | R | H | RBI | BB | SO | LOB |
|---|-----------------------|--------------------|------------|-----------------|-----------|--------------------|------------|-----------|-----------|----|---|---|-----|----|----|-----|
| Bert Campaneris, R (1, 7)<br>OBP: 0.355, SLG: 0.451 | 0-0<br>G4-6-3<br>1B   | 0-0<br>FC6-4       |            | 0-0<br>1B       |           | 0-3<br>K           |            | 0-3<br>K  |           | 5  | 0 | 2 | 1   | 0  | 2  | 3   |
| Wayne Causey, L (1, 6)<br>OBP: 0.398, SLG: 0.402    | 0-0<br>G4-6-3<br>1-2f |                    | 0-0<br>F8  | 0-0<br>1B       |           | 0-0<br>1B          |            | 0-0<br>1B | 0-0<br>F8 | 5  | 0 | 2 | 2   | 0  | 0  | 1   |
| Rocky Colavito, R (1, 9)<br>OBP: 0.367, SLG: 0.535  | 4-0<br>S<br>BB        |                    | 0-0<br>E6  | 0-0<br>L7       |           | 0-3<br>K           |            | 4-0<br>BB |           | 3  | 0 | 0 | 0   | 2  | 1  | 3   |
| Jim Gentile, L (1, 3)<br>OBP: 0.382, SLG: 0.491     | 4-0<br>1-2<br>BB      |                    | 0-0<br>F5  |                 | 0-0<br>F4 |                    | 0-3<br>K   | 0-3<br>K  |           | 4  | 0 | 0 | 0   | 1  | 2  | 2   |
| Billy Bryan, L (1, 2)<br>OBP: 0.289, SLG: 0.495     | 0-0<br>L5             |                    | 0-0<br>1-3 |                 | 0-0<br>HR |                    | 0-3<br>K   | 0-0<br>F8 |           | 5  | 1 | 1 | 1   | 0  | 1  | 4   |
| Ed Charles, R (1, 5)<br>OBP: 0.318, SLG: 0.373      |                       | 0-0<br>1B<br>3B    |            | 0-0<br>1B<br>3B | 0-0<br>F6 |                    | 0-0<br>6-3 |           |           | 4  | 2 | 2 | 0   | 0  | 0  | 0   |
| Nelson Mathews, R (1, 8)<br>OBP: 0.298, SLG: 0.379  |                       | 0-0<br>5-3         |            | 0-0<br>1-3      | 0-0<br>F4 |                    |            | 0-0<br>1B |           | 4  | 0 | 1 | 0   | 0  | 0  | 2   |
| Dick Green, R (1, 4)<br>OBP: 0.307, SLG: 0.384      |                       | 0-0<br>FC6-4<br>1B |            | 0-0<br>L4       |           | 0-0<br>SH1-4<br>1B |            | 0-0<br>F3 |           | 4  | 1 | 2 | 1   | 0  | 0  | 2   |
| Moe Drabowsky, R (1, 1)<br>OBP: 0.045, SLG: 0.023   |                       | 0-0<br>F3          |            | 4-0<br>1B       |           | 0-0<br>SH1-4       |            | 0-0<br>L7 |           | 1  | 1 | 0 | 0   | 1  | 0  | 1   |
| Wes Stock, R (5, 1)<br>OBP: 0.235, SLG: 0.188       |                       |                    |            |                 |           |                    |            |           |           | 0  | 0 | 0 | 0   | 0  | 0  | 0   |
| John Wyatt, R (7, 1)                                |                       |                    |            |                 |           |                    |            |           |           | 0  | 0 | 0 | 0   | 0  | 0  | 0   |
| Manny Jimenez, L (8, PH)<br>OBP: 0.293, SLG: 0.458  |                       |                    |            |                 |           |                    |            |           |           | 1  | 0 | 0 | 0   | 0  | 0  | 1   |
| Ken Sanders, R (9, 1)                               |                       |                    |            |                 |           |                    |            |           |           | 0  | 0 | 0 | 0   | 0  | 0  | 0   |

| Inning Stats | R: 0 | H: 1 | E: 0 | K: 0 | S: 3 | H: 2 | LOB: 2 | BB: 2 | P: 11 | R: 1 | H: 2 | E: 0 | K: 0 | S: 5 | H: 2 | LOB: 1 | BB: 0 | P: 5 | R: 0 | H: 0 | E: 1 | K: 0 | S: 4 | H: 0 | LOB: 1 | BB: 0 | P: 4 | R: 2 | H: 3 | E: 0 | K: 0 | S: 6 | H: 1 | LOB: 0 | BB: 0 | P: 4 | R: 1 | H: 2 | E: 0 | K: 2 | S: 9 | H: 2 | LOB: 1 | BB: 0 | P: 9 | R: 0 | H: 0 | E: 0 | K: 2 | S: 7 | H: 0 | LOB: 0 | BB: 0 | P: 7 | R: 0 | H: 1 | E: 0 | K: 1 | S: 6 | H: 1 | LOB: 1 | BB: 0 | P: 6 | R: 0 | H: 0 | E: 0 | K: 1 | S: 5 | H: 0 | LOB: 1 | BB: 1 | P: 9 | 1B: 7 | SF: 0 | 2B: 0 | SAC: 1 | 3B: 2 | DP: 1 | HR: 1 | HBP: 0 | WP: 0 | PA: 41 |
|--------------|------|------|------|------|------|------|--------|-------|-------|------|------|------|------|------|------|--------|-------|------|------|------|------|------|------|------|--------|-------|------|------|------|------|------|------|------|--------|-------|------|------|------|------|------|------|------|--------|-------|------|------|------|------|------|------|------|--------|-------|------|------|------|------|------|------|------|--------|-------|------|------|------|------|------|------|------|--------|-------|------|-------|-------|-------|--------|-------|-------|-------|--------|-------|--------|
|--------------|------|------|------|------|------|------|--------|-------|-------|------|------|------|------|------|------|--------|-------|------|------|------|------|------|------|------|--------|-------|------|------|------|------|------|------|------|--------|-------|------|------|------|------|------|------|------|--------|-------|------|------|------|------|------|------|------|--------|-------|------|------|------|------|------|------|------|--------|-------|------|------|------|------|------|------|------|--------|-------|------|-------|-------|-------|--------|-------|-------|-------|--------|-------|--------|

| PITCHER                            | IP  | WLS | BF | H | R | ER | SO | BB | IBB | HBP | BLK | WP | HR | S  | P  | ERA  | WHIP  |
|------------------------------------|-----|-----|----|---|---|----|----|----|-----|-----|-----|----|----|----|----|------|-------|
| Earl Wilson, R (1, 1)<br>ERA: 4.78 | 5.0 |     | 26 | 8 | 5 | 5  | 0  | 3  | 0   | 0   | 0   | 0  | 1  | 23 | 35 | 9.00 | 2.200 |
| Dick Radatz, R (6, 1)<br>ERA: 1.87 | 4.0 | W   | 15 | 2 | 0 | 0  | 6  | 1  | 0   | 0   | 0   | 0  | 0  | 26 | 30 | 0.00 | 0.750 |

BOTTOM

Boston Red Sox @ Kansas City Athletics  
Municipal Stadium, Kansas City, MO  
Thu Sep 03 1964, 8:05 PM EDT  
Att. 2,710 - Unknown

livebaseballscorecards.com

|     |    |
|-----|----|
| AB  | 36 |
| R   | 5  |
| H   | 10 |
| RBI | 5  |
| BB  | 4  |
| SO  | 6  |
| LOB | 19 |



| Batter   | 1                            | 2                               | 3                            | 4                               | 5                            | 6                               | 7                            | 8                               | 9                            | 10                              | AB                           | R                               | H                            | RBI                             | BB                           | SO                              | LOB                          | TOP                             |                              |                                  |                                   |                                    |                                  |        |  |
|--|------------------------------|---------------------------------|------------------------------|---------------------------------|------------------------------|---------------------------------|------------------------------|---------------------------------|------------------------------|---------------------------------|------------------------------|---------------------------------|------------------------------|---------------------------------|------------------------------|---------------------------------|------------------------------|---------------------------------|------------------------------|----------------------------------|-----------------------------------|------------------------------------|----------------------------------|--------|--|
| Tony Kubek, L (1, 6)<br>OBP: 0.281, SLG: 0.338   | G5-4-3<br>1B                 |                                 | G4-6-3<br>1-2f               |                                 | P4                           |                                 | FC4-6<br>1B                  |                                 | F8                           | F7                              | 6                            | 0                               | 1                            | 0                               | 0                            | 0                               | 6                            |                                 |                              |                                  |                                   |                                    |                                  |        |  |
| Bobby Richardson, R (1, 4)<br>OBP: 0.285, SLG: 0.332   | G5-4-3<br>1-2f               |                                 |                              | 6-3                             | F3                           |                                 |                              |                                 |                              | 1B<br>2B                        | 5                            | 1                               | 2                            | 1                               | 0                            | 0                               | 2                            |                                 |                              |                                  |                                   |                                    |                                  |        |  |
| Roger Maris, L (1, 9)<br>OBP: 0.372, SLG: 0.462  | F5                           |                                 |                              | HR<br>1B                        |                              | G6-4-3<br>BB                    |                              | F7                              |                              | 1B<br>BB<br>1B                  | 4                            | 2                               | 2                            | 0                               | 1                            | 0                               | 2                            |                                 |                              |                                  |                                   |                                    |                                  |        |  |
| Mickey Mantle, S (1, 7)<br>Mel Stottmyre, R (8, PR)<br>Hector Lopez, R (8, 7)<br>OBP: 0.420, SLG: 0.596<br>OBP: 0.235, SLG: 0.188<br>OBP: 0.318, SLG: 0.429  |                              | 6-3                             |                              | HR                              |                              | G6-4-3<br>1-2f                  |                              | 1B<br>1B                        |                              | BB<br>1B<br>2B<br>BB            | 4                            | 1                               | 2                            | 2                               | 0                            | 0                               | 1                            |                                 |                              |                                  |                                   |                                    |                                  |        |  |
| Elston Howard, R (1, 2)<br>OBP: 0.355, SLG: 0.432  |                              | K                               |                              | HR                              |                              | 4-3                             |                              | F3                              |                              | BB<br>2B<br>1B                  | 5                            | 2                               | 2                            | 2                               | 0                            | 1                               | 1                            |                                 |                              |                                  |                                   |                                    |                                  |        |  |
| Tom Tresh, S (1, 8)<br>OBP: 0.354, SLG: 0.413  |                              | 1B                              |                              | 5-3                             |                              |                                 |                              | 1B<br>2B                        |                              | 2B<br>FC4-2<br>BB               | 4                            | 1                               | 2                            | 1                               | 1                            | 0                               | 1                            |                                 |                              |                                  |                                   |                                    |                                  |        |  |
| Joe Pepitone, L (1, 3)<br>OBP: 0.279, SLG: 0.405   |                              | F9                              |                              | P6                              |                              |                                 |                              | FC4-6<br>1B<br>1B               |                              | FC4-2<br>2B                     | 5                            | 1                               | 3                            | 2                               | 0                            | 0                               | 1                            |                                 |                              |                                  |                                   |                                    |                                  |        |  |
| Clete Boyer, R (1, 5)<br>OBP: 0.264, SLG: 0.305  |                              |                                 | G4-6-3<br>1B                 |                                 | SH5-3<br>1B                  |                                 | P4                           |                                 | F3                           | FC4-2                           | 5                            | 0                               | 2                            | 0                               | 0                            | 0                               | 4                            |                                 |                              |                                  |                                   |                                    |                                  |        |  |
| Whitey Ford, L (1, 1)<br>Johnny Blanchard, L (7, PH)<br>Pedro Gonzalez, R (7, PR)<br>Pete Mikkelsen, R (7, 1)<br>Phil Linz, R (10, PH)<br>Bill Stafford, R (10, 1)<br>OBP: 0.258, SLG: 0.151<br>OBP: 0.329, SLG: 0.425<br>OBP: 0.333, SLG: 0.379<br>OBP: 0.325, SLG: 0.373<br>OBP: 0.077, SLG: 0.154 |                              |                                 | K                            |                                 | SH5-3                        |                                 | FC4-6<br>1B                  |                                 | K                            | F5                              | 1                            | 0                               | 0                            | 0                               | 0                            | 1                               | 1                            |                                 |                              |                                  |                                   |                                    |                                  |        |  |
| <b>Inning Stats</b>  | R: 0<br>E: 0<br>K: 0<br>S: 3 | H: 1<br>LOB: 0<br>BB: 0<br>P: 3 | R: 0<br>E: 0<br>K: 1<br>S: 6 | H: 1<br>LOB: 1<br>BB: 0<br>P: 6 | R: 0<br>E: 0<br>K: 1<br>S: 5 | H: 1<br>LOB: 0<br>BB: 0<br>P: 5 | R: 3<br>E: 0<br>K: 0<br>S: 6 | H: 3<br>LOB: 0<br>BB: 0<br>P: 6 | R: 0<br>E: 0<br>K: 0<br>S: 4 | H: 1<br>LOB: 1<br>BB: 0<br>P: 4 | R: 0<br>E: 0<br>K: 0<br>S: 2 | H: 0<br>LOB: 0<br>BB: 1<br>P: 6 | R: 2<br>E: 0<br>K: 0<br>S: 7 | H: 4<br>LOB: 2<br>BB: 0<br>P: 7 | R: 0<br>E: 0<br>K: 0<br>S: 4 | H: 2<br>LOB: 2<br>BB: 0<br>P: 4 | R: 0<br>E: 0<br>K: 1<br>S: 5 | H: 0<br>LOB: 0<br>BB: 5<br>P: 5 | R: 4<br>E: 0<br>K: 0<br>S: 7 | H: 4<br>LOB: 2<br>BB: 2<br>P: 15 | 1B: 12<br>2B: 3<br>3B: 0<br>HR: 2 | SF: 0<br>SAC: 1<br>DP: 3<br>HBP: 0 | WP: 0<br>PB: 0<br>SB: 0<br>CS: 0 | PA: 46 |  |
| <b>PITCHER</b>   | IP                           | WLS                             | BF                           | H                               | R                            | ER                              | SO                           | BB                              | IBB                          | HBP                             | BLK                          | WP                              | HR                           | S                               | P                            | ERA                             | WHIP                         |                                 |                              |                                  |                                   |                                    |                                  |        |  |
| John O'Donoghue, L (1, 1)<br>ERA: 4.55   | 6.0                          |                                 | 25                           | 9                               | 5                            | 5                               | 2                            | 1                               | 0                            | 0                               | 0                            | 0                               | 2                            | 28                              | 32                           | 7.50                            | 1.667                        |                                 |                              |                                  |                                   |                                    |                                  |        |  |
| Wes Stock, R (7, 1)<br>ERA: 2.52   | 2.0                          |                                 | 9                            | 4                               | 0                            | 0                               | 0                            | 0                               | 0                            | 0                               | 0                            | 0                               | 0                            | 9                               | 9                            | 0.00                            | 2.000                        |                                 |                              |                                  |                                   |                                    |                                  |        |  |
| Ted Bowsfield, L (9, 1)<br>ERA: 4.55   | 1.0                          | L                               | 6                            | 2                               | 3                            | 3                               | 1                            | 1                               | 0                            | 0                               | 0                            | 0                               | 0                            | 7                               | 11                           | 27.00                           | 3.000                        |                                 |                              |                                  |                                   |                                    |                                  |        |  |
| John Wyatt, R (10, 1)<br>ERA: 3.75   | 0.0                          |                                 | 2                            | 1                               | 0                            | 0                               | 0                            | 1                               | 0                            | 0                               | 0                            | 0                               | 0                            | 1                               | 5                            | ∞                               | ∞                            |                                 |                              |                                  |                                   |                                    |                                  |        |  |
| Ken Sanders, R (10, 1)<br>ERA: 2.08  | 1.0                          |                                 | 4                            | 1                               | 1                            | 1                               | 0                            | 0                               | 0                            | 0                               | 0                            | 0                               | 0                            | 4                               | 4                            | 9.00                            | 1.000                        |                                 |                              |                                  |                                   |                                    |                                  |        |  |

**New York Yankees @ Kansas City Athletics**  
Municipal Stadium, Kansas City, MO

Fri Sep 04 1964, 8:05 PM EDT  
Att: 9,900 - Unknown

|     |    |
|-----|----|
| AB  | 42 |
| R   | 9  |
| H   | 17 |
| RBI | 9  |
| BB  | 3  |
| SO  | 3  |
| LOB | 21 |



**BOTTOM**

**New York Yankees @ Kansas City Athletics**  
 Municipal Stadium, Kansas City, MO

livebaseballscores.com

|            |           |
|------------|-----------|
| <b>AB</b>  | <b>39</b> |
| <b>R</b>   | <b>7</b>  |
| <b>H</b>   | <b>11</b> |
| <b>RBI</b> | <b>7</b>  |
| <b>BB</b>  | <b>7</b>  |
| <b>SO</b>  | <b>5</b>  |
| <b>LOB</b> | <b>13</b> |



|           |          |           |           |
|-----------|----------|-----------|-----------|
| <b>WP</b> | <b>2</b> | <b>PA</b> | <b>46</b> |
| <b>PB</b> | <b>0</b> |           |           |
| <b>SB</b> | <b>0</b> |           |           |
| <b>CS</b> | <b>0</b> |           |           |

Fri Sep 04 1964, 8:05 PM EDT  
 Att. 9,900 - Unknown

| Batter  | 1                         | 2                  | 3                | 4                | 5                         | 6                       | 7                           | 8                | 9          | 10               | AB | R | H | RBI | BB | SO | LOB |
|---|---------------------------|--------------------|------------------|------------------|---------------------------|-------------------------|-----------------------------|------------------|------------|------------------|----|---|---|-----|----|----|-----|
| <b>Bert Campaneris, R</b> (1, 7)<br>OBP: 0.349, SLG: 0.440  | 0-0<br>5-3                |                    | 0-0<br>5-3       |                  | 0-0<br>6-3                | 0-0<br>1-2<br>2-H<br>1B |                             | 0-0<br>1-3       |            | 0-0<br>F3        | 6  | 0 | 1 | 1   | 0  | 0  | 0   |
| <b>Wayne Causey, L</b> (1, 6)<br>OBP: 0.398, SLG: 0.403     | 0-0<br>WP<br>G1-2-3<br>2B |                    | 4-0<br>HR<br>BB  |                  | 0-0<br>F8                 | 0-0<br>F7               |                             |                  | 0-0<br>3-1 |                  | 4  | 1 | 1 | 0   | 1  | 0  | 2   |
| <b>Rocky Colavito, R</b> (1, 9)<br>OBP: 0.369, SLG: 0.533   | 4-0<br>BB<br>BB           |                    | 0-0<br>F8        |                  | 4-0<br>BB<br>BB           |                         | 4-0<br>G6-4-3<br>BB         |                  | 0-0<br>F9  |                  | 2  | 0 | 0 | 0   | 3  | 0  | 1   |
| <b>Ken Harrelson, R</b> (1, 3)<br>OBP: 0.262, SLG: 0.432    | 4-0<br>1-2<br>2-3<br>BB   |                    | 0-0<br>1-H<br>HR |                  | 4-0<br>1-2<br>FC5-4<br>BB |                         | 0-0<br>1-2f<br>G6-4-3<br>BB |                  | 0-0<br>HR  |                  | 3  | 2 | 2 | 3   | 2  | 0  | 1   |
| <b>Doc Edwards, R</b> (1, 2)<br>OBP: 0.251, SLG: 0.292      | 0-0<br>G1-2-3             |                    | 0-3<br>K         |                  | 0-0<br>FC5-4              |                         | 0-0<br>1-2f<br>WP<br>1B     |                  | 0-3<br>K   |                  | 3  | 0 | 0 | 0   | 0  | 1  | 5   |
| <b>Billy Bryan, L</b> (7, PH)<br>OBP: 0.291, SLG: 0.495     | 0-0<br>3-Hf               |                    |                  |                  |                           |                         |                             |                  |            |                  | 2  | 1 | 1 | 0   | 0  | 1  | 0   |
| <b>Ed Charles, R</b> (1, 5)<br>OBP: 0.318, SLG: 0.372       |                           | 0-3<br>K           |                  | 0-0<br>5-3       |                           | 0-0<br>L6               |                             | 0-0<br>1-H<br>1B |            | 4-0<br>HR<br>BB  | 4  | 1 | 1 | 1   | 1  | 1  | 0   |
| <b>Nelson Mathews, R</b> (1, 8)<br>OBP: 0.299, SLG: 0.385   |                           | 0-0<br>5-3         |                  | 0-0<br>5-3<br>1B |                           | 0-0<br>P4               |                             | 0-0<br>5-3       |            | 0-0<br>HR<br>1-H | 5  | 1 | 2 | 2   | 0  | 0  | 1   |
| <b>Dick Green, R</b> (1, 4)<br>OBP: 0.308, SLG: 0.385       |                           | 0-0<br>FC6-4<br>1B |                  | 0-0<br>5-3       |                           | 0-0<br>1-2<br>1B<br>1B  |                             | 0-0<br>6-3       |            | 0-0<br>F6        | 5  | 1 | 2 | 0   | 0  | 0  | 1   |
| <b>John O'Donoghue, R</b> (1, 1)<br>OBP: 0.240, SLG: 0.300  |                           | 0-0<br>FC6-4       |                  | 0-3<br>K         |                           | 0-0<br>1-2<br>1B<br>1B  |                             | 0-0<br>3-1       |            | 0-3<br>K         | 3  | 0 | 1 | 0   | 0  | 1  | 2   |
| <b>Wes Stock, R</b> (7, 1)<br>OBP: 0.235, SLG: 0.188        |                           |                    |                  |                  |                           |                         |                             |                  |            |                  | 0  | 0 | 0 | 0   | 0  | 0  | 0   |
| <b>Manny Jimenez, L</b> (8, PH)<br>OBP: 0.292, SLG: 0.455   |                           |                    |                  |                  |                           |                         |                             |                  |            |                  | 1  | 0 | 0 | 0   | 0  | 0  | 0   |
| <b>Ted Bowfield, R</b> (8, 1)<br>OBP: 0.174, SLG: 0.095     |                           |                    |                  |                  |                           |                         |                             |                  |            |                  | 0  | 0 | 0 | 0   | 0  | 0  | 0   |
| <b>John Wyatt, R</b> (10, 1)<br>OBP: 0.174, SLG: 0.095      |                           |                    |                  |                  |                           |                         |                             |                  |            |                  | 0  | 0 | 0 | 0   | 0  | 0  | 0   |
| <b>Ken Sanders, R</b> (10, 1)<br>OBP: 0.174, SLG: 0.095     |                           |                    |                  |                  |                           |                         |                             |                  |            |                  | 0  | 0 | 0 | 0   | 0  | 0  | 0   |
| <b>Jose Tartabull, L</b> (10, PH)<br>OBP: 0.247, SLG: 0.244 |                           |                    |                  |                  |                           |                         |                             |                  |            |                  | 1  | 0 | 0 | 0   | 0  | 1  | 0   |

| Inning Stats | R: 0 | H: 1 | E: 0 | K: 0 | S: 3 | R: 0 | H: 1 | E: 0 | K: 1 | S: 6 | R: 2 | H: 1 | E: 0 | K: 1 | S: 6 | R: 0 | H: 1 | E: 0 | K: 0 | S: 3 | R: 1 | H: 3 | E: 0 | K: 0 | S: 6 | R: 0 | H: 2 | E: 0 | K: 0 | S: 4 | R: 0 | H: 0 | E: 0 | K: 0 | S: 3 | R: 1 | H: 1 | E: 0 | K: 1 | S: 6 | R: 2 | H: 1 | E: 0 | K: 1 | S: 6 | 1B: 7 | SF: 0 | 2B: 1 | SAC: 0 | 3B: 0 | DP: 2 | HR: 3 | HBP: 0 | WP: 2 | PA: 46 |
|--------------|------|------|------|------|------|------|------|------|------|------|------|------|------|------|------|------|------|------|------|------|------|------|------|------|------|------|------|------|------|------|------|------|------|------|------|------|------|------|------|------|------|------|------|------|------|-------|-------|-------|--------|-------|-------|-------|--------|-------|--------|
|--------------|------|------|------|------|------|------|------|------|------|------|------|------|------|------|------|------|------|------|------|------|------|------|------|------|------|------|------|------|------|------|------|------|------|------|------|------|------|------|------|------|------|------|------|------|------|-------|-------|-------|--------|-------|-------|-------|--------|-------|--------|

| PITCHER                                      | IP  | WLS | BF | H | R | ER | SO | BB | IBB | HBP | BLK | WP | HR | S  | P  | ERA   | WHIP  |
|--|-----|-----|----|---|---|----|----|----|-----|-----|-----|----|----|----|----|-------|-------|
| <b>Whitey Ford, L</b> (1, 1)<br>ERA: 2.28    | 6.0 |     | 29 | 7 | 3 | 3  | 3  | 5  | 0   | 0   | 0   | 1  | 1  | 30 | 50 | 4.50  | 2.000 |
| <b>Pete Mikkelsen, R</b> (7, 1)<br>ERA: 3.79 | 3.0 | W   | 12 | 3 | 2 | 2  | 1  | 1  | 0   | 0   | 0   | 1  | 1  | 13 | 17 | 6.00  | 1.333 |
| <b>Bill Stafford, R</b> (10, 1)<br>ERA: 2.43 | 1.0 | S   | 5  | 1 | 2 | 2  | 1  | 1  | 0   | 0   | 0   | 0  | 1  | 6  | 10 | 18.00 | 2.000 |

| Batter | 1 | 2 | 3 | 4 | 5 | 6 | 7 | 8 | 9 | AB R H RBI BB SO LOB | TOP |
|--------|---|---|---|---|---|---|---|---|---|----------------------|-----|
|--------|---|---|---|---|---|---|---|---|---|----------------------|-----|

|  |                                   |                               |                      |                    |              |                     |                       |            |  |  |  |
|--|-----------------------------------|-------------------------------|----------------------|--------------------|--------------|---------------------|-----------------------|------------|--|--|--|
| Tony Kubek, L<br>OBP: 0.280, SLG: 0.336 (1, 6) X           | 0-0<br>FC4-6 BB<br>HR<br>1B       | 0-0<br>F8                     |                      | 0-0<br>4-3         |              | 0-0<br>4-3          |                       | 0-0<br>L4  |  | 5 1 1 0 0 0 1  |  |
| Bobby Richardson, R<br>OBP: 0.288, SLG: 0.333 (1, 4) B B B | 4-0<br>FC4-6<br>1-2<br>BB         | 0-0<br>PB 1B<br>WP 1B         |                      | 0-0<br>5-3         |              | 0-0<br>1B 1B        |                       | 0-0<br>F3  |  | 4 1 2 0 1 0 0  |  |
| Roger Maris, L<br>OBP: 0.372, SLG: 0.461 (1, 9) X          | 0-0<br>FC4-6<br>1-2f<br>2-3<br>HR | 0-0<br>WP PB<br>1-2 2-H<br>1B |                      | 0-0<br>BB<br>HR 1B |              | 0-0<br>L8           |                       | 0-0<br>L8  |  | 5 2 2 1 0 0 3  |  |
| Mickey Mantle, S<br>OBP: 0.425, SLG: 0.605 (1, 7) X        | 0-0<br>HR                         | 4-0<br>WP<br>1-2 2-3<br>BB    |                      | 4-0<br>HR<br>BB    |              | 0-0<br>1-3<br>1B    |                       | 0-0<br>F9  |  | 3 2 2 3 2 0 0<br>0 0 0 0 0 0 0                                   |  |
| Hector Lopez, R<br>OBP: 0.318, SLG: 0.429 (9, 7)           | 0-0<br>HR                         | 0-0<br>L4                     |                      | 0-0<br>HR<br>BB    |              | 0-0<br>F5           |                       | 0-0<br>4-3 |  | 5 1 1 3 0 0 4  |  |
| Joe Pepitone, L<br>OBP: 0.278, SLG: 0.409 (1, 3) X         | 0-0<br>4-3                        | 0-0<br>L4                     |                      | 0-0<br>HR          |              | 0-0<br>F5           |                       | 0-0<br>4-3 |  | 5 1 1 3 0 0 4  |  |
| Tom Tresh, S<br>OBP: 0.354, SLG: 0.410 (1, 8) S S S        | 0-3<br>K                          |                               | 4-0<br>FC5-4<br>BB   | 0-3<br>K           |              | 4-0<br>G6-4-3<br>BB |                       | 0-0<br>3-1 |  | 3 0 0 0 2 2 0  |  |
| Elston Howard, R<br>OBP: 0.354, SLG: 0.432 (1, 2)          |                                   | 0-0<br>E9<br>1B<br>2B         | 0-0<br>FC5-4<br>1-2f |                    | 0-0<br>4-3   |                     | 0-0<br>G6-4-3<br>1-2f |            |  | 4 1 1 0 0 0 2  |  |
| Clete Boyer, R<br>OBP: 0.264, SLG: 0.304 (1, 5) X          |                                   | 0-0<br>4-3                    | 0-0<br>L8            |                    | 0-0<br>1-6-3 |                     | 0-0<br>1B             |            |  | 4 0 1 0 0 0 2  |  |
| Al Downing, R<br>OBP: 0.184, SLG: 0.181 (1, 1) X           |                                   | 0-0<br>1B<br>1B               | 0-3<br>K             |                    | 0-0<br>4-3   |                     | 0-0<br>P4             |            |  | 2 1 1 1 0 1 1<br>0 0 0 0 0 0 0<br>2 0 0 0 0 0 1<br>0 0 0 0 0 0 0 |  |
| Stan Williams, R<br>OBP: 0.150, SLG: 0.200 (3, 1)          |                                   |                               |                      |                    |              |                     |                       |            |  |  |  |
| Ralph Terry, R<br>OBP: 0.229, SLG: 0.188 (3, 1)            |                                   |                               |                      |                    |              |                     |                       |            |  |  |  |
| Hal Reniff, R<br>OBP: 0.111, SLG: 0.111 (8, 1)             |                                   |                               |                      |                    |              |                     |                       |            |  |  |  |

| Inning Stats | R: 3<br>E: 0<br>K: 1<br>S: 7 | H: 2<br>LOB: 0<br>BB: 1<br>P: 11 | R: 3<br>E: 1<br>K: 0<br>S: 7 | H: 4<br>LOB: 2<br>BB: 1<br>P: 11 | R: 0<br>E: 0<br>K: 1<br>S: 5 | H: 0<br>LOB: 1<br>BB: 1<br>P: 9 | R: 3<br>E: 0<br>K: 1<br>S: 7 | H: 2<br>LOB: 0<br>BB: 1<br>P: 11 | R: 0<br>E: 0<br>K: 0<br>S: 3 | H: 0<br>LOB: 0<br>BB: 0<br>P: 3 | R: 0<br>E: 0<br>K: 0<br>S: 5 | H: 2<br>LOB: 2<br>BB: 0<br>P: 5 | R: 0<br>E: 0<br>K: 0<br>S: 3 | H: 1<br>LOB: 1<br>BB: 1<br>P: 7 | R: 0<br>E: 0<br>K: 0<br>S: 3 | H: 0<br>LOB: 0<br>BB: 0<br>P: 3 | R: 0<br>E: 0<br>K: 0<br>S: 3 | H: 0<br>LOB: 0<br>BB: 0<br>P: 3 | 1B: 8<br>2B: 1<br>3B: 0<br>HR: 2 | SF: 0<br>SAC: 0<br>DP: 1<br>HBP: 0 | WP: 2<br>PB: 1<br>SB: 0<br>CS: 0 | PA: 42 |
|--------------|------------------------------|----------------------------------|------------------------------|----------------------------------|------------------------------|---------------------------------|------------------------------|----------------------------------|------------------------------|---------------------------------|------------------------------|---------------------------------|------------------------------|---------------------------------|------------------------------|---------------------------------|------------------------------|---------------------------------|----------------------------------|------------------------------------|----------------------------------|--------|
|--------------|------------------------------|----------------------------------|------------------------------|----------------------------------|------------------------------|---------------------------------|------------------------------|----------------------------------|------------------------------|---------------------------------|------------------------------|---------------------------------|------------------------------|---------------------------------|------------------------------|---------------------------------|------------------------------|---------------------------------|----------------------------------|------------------------------------|----------------------------------|--------|

| PITCHER                               | IP  | WLS | BF | H | R | ER | SO | BB | IBB | HBP | BLK | WP | HR | S  | P  | ERA   | WHIP  |
|---------------------------------------|-----|-----|----|---|---|----|----|----|-----|-----|-----|----|----|----|----|-------|-------|
| Blue Moon Odom, R<br>ERA: 27.0 (1, 1) | 2.0 |     | 14 | 6 | 6 | 6  | 1  | 2  | 0   | 0   | 0   | 2  | 1  | 14 | 22 | 27.00 | 4.000 |
| Jose Santiago, R<br>ERA: 5.12 (3, 1)  | 1.0 |     | 4  | 0 | 0 | 0  | 1  | 1  | 0   | 0   | 0   | 0  | 0  | 5  | 9  | 0.00  | 1.000 |
| Ken Sanders, R<br>ERA: 3.1 (4, 1)     | 3.0 | L   | 14 | 4 | 3 | 3  | 1  | 1  | 0   | 0   | 0   | 0  | 1  | 15 | 19 | 9.00  | 1.667 |
| Moe Drabowsky, R<br>ERA: 5.17 (7, 1)  | 2.0 |     | 7  | 1 | 0 | 0  | 0  | 1  | 0   | 0   | 0   | 0  | 0  | 6  | 10 | 0.00  | 1.000 |
| Ted Bowsfield, L<br>ERA: 4.5 (9, 1)   | 1.0 |     | 3  | 0 | 0 | 0  | 0  | 0  | 0   | 0   | 0   | 0  | 0  | 3  | 3  | 0.00  | 0.000 |

| PITCHER | IP | WLS | BF | H | R | ER | SO | BB | IBB | HBP | BLK | WP | HR | S | P | ERA | WHIP |
|---------|----|-----|----|---|---|----|----|----|-----|-----|-----|----|----|---|---|-----|------|
|---------|----|-----|----|---|---|----|----|----|-----|-----|-----|----|----|---|---|-----|------|

**New York Yankees @ Kansas City Athletics**  
 Municipal Stadium, Kansas City, MO  
 Sat Sep 05 1964, 8:05 PM EDT  
 Att: 18,759 - Unknown

|            |           |
|------------|-----------|
| <b>AB</b>  | <b>37</b> |
| <b>R</b>   | <b>9</b>  |
| <b>H</b>   | <b>11</b> |
| <b>RBI</b> | <b>8</b>  |
| <b>BB</b>  | <b>5</b>  |
| <b>SO</b>  | <b>3</b>  |
| <b>LOB</b> | <b>14</b> |



| WP | PA |
|----|----|
| 2  | 42 |

BOTTOM

New York Yankees @ Kansas City Athletics  
Municipal Stadium, Kansas City, MO

|     |    |
|-----|----|
| AB  | 34 |
| R   | 7  |
| H   | 9  |
| RBI | 7  |
| BB  | 7  |
| SO  | 4  |
| LOB | 13 |



|    |   |    |    |
|----|---|----|----|
| WP | 0 | PA | 42 |
| PB | 0 |    |    |
| SB | 0 |    |    |
| CS | 0 |    |    |

|     |       |      |       |
|-----|-------|------|-------|
| ERA | 22.50 | WHIP | 3.000 |
| ERA | 4.25  |      |       |
| ERA | 3.60  |      | 1.400 |
| ERA | 2.72  |      | 0.000 |

Sat Sep 05 1964, 8:05 PM EDT  
Att. 18,759 - Unknown

livebaseballscorecards.com

AB R H RBI BB SO LOB

|   |   |   |   |   |   |   |
|---|---|---|---|---|---|---|
| 5 | 2 | 2 | 1 | 0 | 0 | 1 |
| 5 | 1 | 2 | 2 | 0 | 0 | 1 |
| 4 | 1 | 1 | 0 | 1 | 0 | 2 |
| 4 | 0 | 0 | 0 | 1 | 2 | 1 |
| 4 | 2 | 1 | 2 | 0 | 0 | 2 |
| 1 | 0 | 0 | 0 | 0 | 1 | 0 |
| 4 | 0 | 2 | 0 | 1 | 0 | 0 |
| 2 | 0 | 1 | 1 | 2 | 0 | 0 |
| 3 | 0 | 0 | 1 | 0 | 1 | 4 |
| 0 | 0 | 0 | 0 | 0 | 0 | 0 |
| 0 | 1 | 0 | 0 | 1 | 0 | 0 |
| 1 | 0 | 0 | 0 | 0 | 0 | 2 |
| 0 | 0 | 0 | 0 | 0 | 0 | 0 |
| 0 | 0 | 0 | 0 | 1 | 0 | 0 |
| 0 | 0 | 0 | 0 | 0 | 0 | 0 |
| 0 | 0 | 0 | 0 | 0 | 0 | 0 |
| 1 | 0 | 0 | 0 | 0 | 0 | 0 |
| 0 | 0 | 0 | 0 | 0 | 0 | 0 |

1B: 6 SF: 1  
2B: 1 SAC: 0  
3B: 1 DP: 1  
HR: 1 HBP: 0

|     |     |    |   |   |    |    |    |     |     |     |    |    |    |    |       |       |
|-----|-----|----|---|---|----|----|----|-----|-----|-----|----|----|----|----|-------|-------|
| IP  | WLS | BF | H | R | ER | SO | BB | IBB | HBP | BLK | WP | HR | S  | P  | ERA   | WHIP  |
| 2.0 |     | 12 | 4 | 5 | 5  | 1  | 2  | 0   | 0   | 0   | 0  | 1  | 12 | 20 | 22.50 | 3.000 |
| 0.1 |     | 4  | 0 | 0 | 0  | 0  | 3  | 0   | 0   | 0   | 0  | 0  | 1  | 13 | 0.00  | 9.000 |
| 5.0 | W   | 22 | 5 | 2 | 2  | 1  | 2  | 0   | 0   | 0   | 0  | 0  | 22 | 30 | 3.60  | 1.400 |
| 1.2 | S   | 4  | 0 | 0 | 0  | 2  | 0  | 0   | 0   | 0   | 0  | 0  | 8  | 8  | 0.00  | 0.000 |

| Batter  | 1            | 2       | 3   | 4            | 5            | 6              | 7                      | 8                  | 9 |
|---|--------------|---------|---|--------------|--------------|----------------|------------------------|--------------------|---|
| Bert Campaneris, R (1, 7)<br>OBP: 0.350, SLG: 0.457   | 0-0 F6<br>1B |         | 0-0 1B<br>3B                                | 0-0 6-3      |              | 0-0 F9<br>1B   |                        | 0-0 1B<br>2B       |   |
| Wayne Causey, L (1, 6)<br>OBP: 0.398, SLG: 0.403  | 0-0 4-3      |         | 0-0 BB<br>FC6-4<br>1B                       | 0-0 F7<br>1B |              | 0-0 4-1<br>1-2 |                        | 0-0 G1-4-3<br>1B   |   |
| Rocky Colavito, R (1, 9)<br>OBP: 0.369, SLG: 0.530  | 0-0 1B       |         | 4-0 FC6-4<br>1-2<br>BB<br>BB                | 0-0 L7       |              | 0-0 5-3        |                        | 0-0 G1-4-3<br>1-2f |   |
| Ken Harrelson, R (1, 3)<br>OBP: 0.260, SLG: 0.418   | 0-3 K        |         | 4-0 FC6-4<br>1-2<br>2-3<br>BB               |              | 0-0 5-3      |                | 0-0 5-3                | 0-3 K              |   |
| Doc Edwards, R (1, 2)<br>OBP: 0.251, SLG: 0.302   |              | 0-0 HR  | 0-0 FC6-4<br>1-2f<br>2-3<br>3-H<br>BB<br>BB |              | 0-0 F3       |                | 0-0 F8                 | 0-3 K              |   |
| Billy Bryan, L (9, PH)<br>OBP: 0.289, SLG: 0.492  |              |         |   |              |              |                |                        |                    |   |
| Ed Charles, R (1, 5)<br>OBP: 0.321, SLG: 0.373  |              | 0-0 5-3 | 4-0 BB<br>1-2<br>BB                         |              | 0-0 1B<br>1B |                | 0-0 BB<br>1B           | 0-0 5-3            |   |
| Nelson Mathews, R (1, 8)<br>OBP: 0.303, SLG: 0.385  |              | 0-0 5-3 | 4-0 1-2<br>2-3<br>3-H<br>BB                 |              | 0-0 1B       |                | 4-0 FC6-4<br>1-2<br>BB |                    |   |
| Dick Green, R (1, 4)<br>OBP: 0.305, SLG: 0.382  |              | 0-0 P4  | 0-0 SF8<br>3-H                              |              | 0-3 K        |                | 0-0 FC6-4<br>1-2f      |                    |   |
| Blue Moon Odom, R (1, 1)<br>Jose Santiago, R (3, 1)<br>Manny Jimenez, L (3, PH)<br>Ken Sanders, R (4, 1)<br>Jose Tartabull, L (6, PH)<br>Moe Drabowsky, R (7, 1)<br>Jim Gentile, L (8, PH)<br>Ted Bowsfield, R (9, 1) |              |         | 4-0 3B<br>BB                                |              |              | 4-0 4-1<br>BB  |                        | 0-0 4-3            |   |

Inning Stats R: 0 H: 1 E: 0 K: 1 S: 6 L: 1 LOB: 1 BB: 0 P: 6 R: 1 E: 0 K: 0 S: 4 H: 1 LOB: 0 BB: 0 P: 4 R: 5 H: 2 E: 0 K: 0 S: 5 L: 2 LOB: 2 BB: 5 P: 25 R: 0 H: 0 E: 0 K: 0 S: 3 L: 0 LOB: 0 BB: 0 P: 3 R: 0 H: 2 E: 0 K: 1 S: 7 L: 2 LOB: 2 BB: 0 P: 7 R: 0 H: 0 E: 0 K: 0 S: 3 L: 0 LOB: 1 BB: 1 P: 7 R: 0 H: 1 E: 0 K: 0 S: 4 L: 1 LOB: 2 BB: 1 P: 8 R: 1 H: 2 E: 0 K: 0 S: 4 L: 2 LOB: 0 BB: 0 P: 4 R: 0 H: 0 E: 0 K: 2 S: 7 L: 0 LOB: 0 BB: 0 P: 7

|                                      |     |     |    |   |   |    |    |    |     |     |     |    |    |    |    |       |       |
|--------------------------------------|-----|-----|----|---|---|----|----|----|-----|-----|-----|----|----|----|----|-------|-------|
| PITCHER                              | IP  | WLS | BF | H | R | ER | SO | BB | IBB | HBP | BLK | WP | HR | S  | P  | ERA   | WHIP  |
| Al Downing, L (1, 1)<br>ERA: 3.42    | 2.0 |     | 12 | 4 | 5 | 5  | 1  | 2  | 0   | 0   | 0   | 0  | 1  | 12 | 20 | 22.50 | 3.000 |
| Stan Williams, R (3, 1)<br>ERA: 4.25 | 0.1 |     | 4  | 0 | 0 | 0  | 0  | 3  | 0   | 0   | 0   | 0  | 0  | 1  | 13 | 0.00  | 9.000 |
| Ralph Terry, R (3, 1)<br>ERA: 4.51   | 5.0 | W   | 22 | 5 | 2 | 2  | 1  | 2  | 0   | 0   | 0   | 0  | 0  | 22 | 30 | 3.60  | 1.400 |
| Hal Reniff, R (8, 1)<br>ERA: 2.72    | 1.2 | S   | 4  | 0 | 0 | 0  | 2  | 0  | 0   | 0   | 0   | 0  | 0  | 8  | 8  | 0.00  | 0.000 |

| Batter   | 1   | 2                               | 3                            | 4                               | 5                            | 6                               | 7                            | 8                               | 9                            | AB R H RBI BB SO LOB            | TOP  |                                 |                              |   |                              |                                 |                              |                                 |                                  |                                    |                                  |        |
|--|---|---------------------------------|------------------------------|---------------------------------|------------------------------|---------------------------------|------------------------------|---------------------------------|------------------------------|---------------------------------|--|---------------------------------|------------------------------|---|------------------------------|---------------------------------|------------------------------|---------------------------------|----------------------------------|------------------------------------|----------------------------------|--------|
| Tony Kubek, L (1, 6)<br>OBP: 0.279, SLG: 0.343       | 0-0<br>HR   |                                 | 0-3<br>K                     |                                 | 0-0<br>1-3                   |                                 | 0-0<br>1-3                   |                                 | 0-0<br>F7                    | 5 1 1 1 0 1 4                   | <b>New York Yankees @ Kansas City Athletics</b><br>Municipal Stadium, Kansas City, MO<br>Sun Sep 06 1964, 4:33 AM EDT<br>Att. 21,372 - Sunny<br><a href="http://livebaseballscorecards.com">livebaseballscorecards.com</a> |                                 |                              |   |                              |                                 |                              |                                 |                                  |                                    |                                  |        |
| Bobby Richardson, R (1, 4)<br>OBP: 0.291, SLG: 0.336 | 0-0<br>F9   |                                 |                              | 0-0<br>S<br>1B                  |                              | 0-0<br>WP<br>1B                 |                              | 0-0<br>4-3<br>WP<br>1B          | 4 2 3 0 0 0 0                |                                 |  |                                 |                              |   |                              |                                 |                              |                                 |                                  |                                    |                                  |        |
| Roger Maris, L (1, 9)<br>OBP: 0.371, SLG: 0.459      | 0-3<br>K  |                                 | 0-3<br>K                     | 0-3<br>1-2<br>K                 |                              | 0-0<br>2-H<br>1B                |                              | 0-0<br>4-3                      | 4 0 1 1 0 2 2                |                                 |  |                                 |                              |   |                              |                                 |                              |                                 |                                  |                                    |                                  |        |
| Mickey Mantle, S (1, 7)<br>OBP: 0.421, SLG: 0.598    | 0-0<br>F7   |                                 | 0-3<br>K                     | 0-3<br>K                        |                              | 0-0<br>F4                       |                              | 0-0<br>FC4<br>S                 | 4 0 0 1 0 1 2                |                                 |  |                                 |                              |   |                              |                                 |                              |                                 |                                  |                                    |                                  |        |
| Joe Pepitone, L (1, 3)<br>OBP: 0.276, SLG: 0.406     |   | 0-3<br>K                        |                              | 0-0<br>F7                       |                              | 0-0<br>F7                       |                              | 0-3<br>K                        | 4 0 0 0 0 2 3                |                                 |  |                                 |                              |   |                              |                                 |                              |                                 |                                  |                                    |                                  |        |
| Tom Tresh, S (1, 8)<br>OBP: 0.352, SLG: 0.407        |   | 0-0<br>F8                       |                              | 0-3<br>K                        |                              | 0-3<br>K                        |                              | 0-0<br>F2<br>1-2                | 4 0 0 0 0 2 2                |                                 |  |                                 |                              |   |                              |                                 |                              |                                 |                                  |                                    |                                  |        |
| Elston Howard, R (1, 2)<br>OBP: 0.357, SLG: 0.437    |   | 0-3<br>K                        |                              | 0-0<br>1-3<br>1B                |                              | 0-0<br>2B                       |                              | 0-0<br>WP<br>1B                 | 4 0 3 0 0 1 0                |                                 |  |                                 |                              |   |                              |                                 |                              |                                 |                                  |                                    |                                  |        |
| Clete Boyer, R (1, 5)<br>OBP: 0.264, SLG: 0.304      |   |                                 | 0-3<br>K                     | 0-0<br>1-2<br>1B                |                              | 0-0<br>L4                       |                              | 0-3<br>K                        | 4 0 1 0 0 2 2                |                                 |  |                                 |                              |   |                              |                                 |                              |                                 |                                  |                                    |                                  |        |
| Rollie Sheldon, R (1, 1)<br>OBP: 0.103, SLG: 0.103   |   |                                 | 0-3<br>K                     | 0-0<br>1-2<br>2-3               |                              | 0-3<br>K                        |                              | 0-3<br>K                        | 4 0 0 0 0 3 4                |                                 |  |                                 |                              |   |                              |                                 |                              |                                 |                                  |                                    |                                  |        |
| Pedro Ramos, S (9, 1)<br>OBP: 0.220, SLG: 0.333      |   |                                 |                              |                                 |                              |                                 |                              |                                 | 0 0 0 0 0 0 0                |                                 |  |                                 |                              |   |                              |                                 |                              |                                 |                                  |                                    |                                  |        |
| <b>Inning Stats</b>                                  | R: 1<br>E: 0<br>K: 1<br>S: 6                          | H: 1<br>LOB: 0<br>BB: 0<br>P: 6 | R: 0<br>E: 0<br>K: 2<br>S: 7 | H: 0<br>LOB: 0<br>BB: 0<br>P: 7 | R: 0<br>E: 0<br>K: 3<br>S: 9 | H: 0<br>LOB: 0<br>BB: 0<br>P: 9 | R: 0<br>E: 0<br>K: 2<br>S: 8 | H: 1<br>LOB: 1<br>BB: 0<br>P: 8 | R: 0<br>E: 0<br>K: 1<br>S: 7 | H: 2<br>LOB: 2<br>BB: 0<br>P: 7 | R: 1<br>E: 1<br>K: 1<br>S: 7   | H: 2<br>LOB: 1<br>BB: 0<br>P: 7 | R: 0<br>E: 0<br>K: 1<br>S: 6 | H: 1<br>LOB: 1<br>BB: 0<br>P: 6                       | R: 1<br>E: 0<br>K: 1<br>S: 7 | H: 1<br>LOB: 1<br>BB: 0<br>P: 7 | R: 0<br>E: 0<br>K: 2<br>S: 8 | H: 1<br>LOB: 1<br>BB: 0<br>P: 8 | 1B: 7<br>2B: 1<br>3B: 0<br>HR: 1 | SF: 0<br>SAC: 0<br>DP: 0<br>HBP: 0 | WP: 3<br>PB: 0<br>SB: 2<br>CS: 0 | PA: 37 |
| <b>PITCHER</b>                                       | IP WLS BF H R ER SO BB IBB HBP BLK WP HR S P ERA WHIP |                                 |                              |                                 |                              |                                 |                              |                                 |                              |                                 |  |                                 | <b>PITCHER</b>               | IP WLS BF H R ER SO BB IBB HBP BLK WP HR S P ERA WHIP |                              |                                 |                              |                                 |                                  |                                    |                                  |        |
| Diego Segui, R (1, 1)<br>ERA: 4.2                    | 8.0 L 33 8 3 3 12 0 0 0 0 2 1 57 57 3.38 1.000        |                                 |                              |                                 |                              |                                 |                              |                                 |                              |                                 |  |                                 |                              |   |                              |                                 |                              |                                 |                                  |                                    |                                  |        |
| Wes Stock, R (9, 1)<br>ERA: 2.52                     | 0.0 1 1 0 0 0 0 0 0 0 0 0 0 1 1 ∞ ∞                   |                                 |                              |                                 |                              |                                 |                              |                                 |                              |                                 |  |                                 |                              |   |                              |                                 |                              |                                 |                                  |                                    |                                  |        |
| Moe Drabowsky, R (9, 1)<br>ERA: 5.14                 | 1.0 3 0 0 0 0 2 0 0 0 0 1 0 7 7 0.00 0.000            |                                 |                              |                                 |                              |                                 |                              |                                 |                              |                                 |  |                                 |                              |   |                              |                                 |                              |                                 |                                  |                                    |                                  |        |

**New York Yankees @ Kansas City Athletics**  
Municipal Stadium, Kansas City, MO  
Sun Sep 06 1964, 4:33 AM EDT  
Att. 21,372 - Sunny

|     |    |
|-----|----|
| AB  | 37 |
| R   | 3  |
| H   | 9  |
| RBI | 3  |
| BB  | 0  |
| SO  | 14 |
| LOB | 19 |



| Batter   | 1         | 2                          | 3         | 4         | 5          | 6         | 7                     | 8         | 9                                 | AB | R | H | RBI | BB | SO | LOB |
|--|-----------|----------------------------|-----------|-----------|------------|-----------|-----------------------|-----------|-----------------------------------|----|---|---|-----|----|----|-----|
| <b>Bert Campaneris, R</b> (1, 7)<br>OBP: 0.343, SLG: 0.446 | 0-0<br>F3 |                            | 0-0<br>L6 |           |            | 0-0<br>F3 |                       | 0-0<br>F8 |                                   | 4  | 0 | 0 | 0   | 0  | 0  | 1   |
| <b>Wayne Causey, L</b> (1, 6)<br>OBP: 0.398, SLG: 0.407    | 0-0<br>F7 |                            |           | 0-0<br>3B |            | 0-0<br>L3 |                       |           | 4-0<br>1B<br>BB                   | 3  | 1 | 1 | 0   | 1  | 0  | 0   |
| <b>Rocky Colavito, R</b> (1, 9)<br>OBP: 0.372, SLG: 0.532  | 0-0<br>1B |                            |           | 0-0<br>F3 |            |           | 0-0<br>G3-6-3<br>1B   |           | 0-0<br>1B<br>G3-6-3               | 4  | 1 | 3 | 0   | 0  | 0  | 1   |
| <b>Jim Gentile, L</b> (1, 3)<br>OBP: 0.380, SLG: 0.487     | 0-0<br>F3 |                            |           | 0-0<br>F5 |            |           | 0-0<br>G3-6-3<br>1-2f |           | 0-0<br>G3-6-3<br>1B<br>1-3<br>2-H | 4  | 0 | 1 | 1   | 0  | 0  | 3   |
| <b>Jose Tartabull, L</b> (9, PR)<br>OBP: 0.255, SLG: 0.244 |           |                            |           |           |            |           |                       |           |                                   | 0  | 0 | 0 | 0   | 0  | 0  | 0   |
| <b>Billy Bryan, L</b> (1, 2)<br>OBP: 0.293, SLG: 0.490     |           | 4-0<br>BB<br>FC5-4<br>BB   |           | 0-3<br>K  |            |           | 0-0<br>1B             |           | 0-0<br>G3-6-3<br>1-2f             | 3  | 0 | 1 | 0   | 1  | 1  | 2   |
| <b>Ed Charles, R</b> (1, 5)<br>OBP: 0.319, SLG: 0.370      |           | 0-0<br>FC5-4<br>CS<br>1-2f |           |           | 0-0<br>5-3 |           | 0-0<br>F9             |           | 0-0<br>P6                         | 4  | 0 | 0 | 0   | 0  | 0  | 3   |
| <b>Nelson Mathews, R</b> (1, 8)<br>OBP: 0.301, SLG: 0.383  |           | 0-3<br>K<br>1-2            |           |           | 0-0<br>5-3 |           |                       | 0-0<br>F9 |                                   | 3  | 0 | 0 | 0   | 0  | 1  | 1   |
| <b>Dick Green, R</b> (1, 4)<br>OBP: 0.305, SLG: 0.381      |           |                            | 0-3<br>K  |           | 0-0<br>1-3 |           |                       | 0-0<br>1B |                                   | 3  | 0 | 1 | 0   | 0  | 1  | 0   |
| <b>Diego Segui, R</b> (1, 1)<br>OBP: 0.221, SLG: 0.234     |           |                            | 0-3<br>K  |           |            | 0-3<br>K  |                       | 0-0<br>F5 |                                   | 2  | 0 | 0 | 0   | 0  | 2  | 0   |
| <b>Manny Jimenez, L</b> (8, PH)<br>OBP: 0.289, SLG: 0.451  |           |                            |           |           |            |           |                       |           |                                   | 1  | 0 | 0 | 0   | 0  | 0  | 1   |
| <b>Wes Stock, R</b> (9, 1)<br>OBP: 0.235, SLG: 0.188       |           |                            |           |           |            |           |                       |           |                                   | 0  | 0 | 0 | 0   | 0  | 0  | 0   |
| <b>Moe Drabowsky, R</b> (9, 1)<br>OBP: 0.045, SLG: 0.023   |           |                            |           |           |            |           |                       |           |                                   | 0  | 0 | 0 | 0   | 0  | 0  | 0   |

| Inning Stats                                 | R: 0 | H: 1 | E: 0 | LOB: 1 | K: 0 | BB: 0 | S: 4 | P: 4 | R: 0 | H: 0 | E: 0 | LOB: 0 | K: 1 | BB: 1 | S: 4 | P: 8 | R: 0  | H: 0 | E: 0 | LOB: 0 | K: 2 | BB: 0 | S: 7 | P: 7 | R: 0 | H: 1 | E: 0 | LOB: 1 | K: 1 | BB: 0 | S: 6 | P: 6 | R: 0 | H: 0 | E: 0 | LOB: 0 | K: 0 | BB: 0 | S: 3 | P: 3 | R: 0 | H: 0 | E: 0 | LOB: 0 | K: 1 | BB: 0 | S: 5 | P: 5 | R: 0 | H: 2 | E: 0 | LOB: 1 | K: 0 | BB: 0 | S: 4 | P: 4 | R: 0 | H: 1 | E: 0 | LOB: 1 | K: 0 | BB: 0 | S: 4 | P: 4 | R: 2 | H: 2 | E: 0 | LOB: 1 | K: 0 | BB: 1 | S: 4 | P: 8 | 1B: 6 | SF: 0 | 2B: 0 | SAC: 0 | 3B: 1 | DP: 2 | HR: 0 | HBP: 0 | WP: 0 | PA: 33 |
|--|------|------|------|--------|------|-------|------|------|------|------|------|--------|------|-------|------|------|-------|------|------|--------|------|-------|------|------|------|------|------|--------|------|-------|------|------|------|------|------|--------|------|-------|------|------|------|------|------|--------|------|-------|------|------|------|------|------|--------|------|-------|------|------|------|------|------|--------|------|-------|------|------|------|------|------|--------|------|-------|------|------|-------|-------|-------|--------|-------|-------|-------|--------|-------|--------|
| <b>PITCHER</b>                               | IP   | WLS  | BF   | H      | R    | ER    | SO   | BB   | IBB  | HBP  | BLK  | WP     | HR   | S     | P    | ERA  | WHIP  |      |      |        |      |       |      |      |      |      |      |        |      |       |      |      |      |      |      |        |      |       |      |      |      |      |      |        |      |       |      |      |      |      |      |        |      |       |      |      |      |      |      |        |      |       |      |      |      |      |      |        |      |       |      |      |       |       |       |        |       |       |       |        |       |        |
| <b>Rollie Sheldon, R</b> (1, 1)<br>ERA: 3.63 | 8.0  | W    | 29   | 5      | 1    | 1     | 5    | 2    | 0    | 0    | 0    | 0      | 0    | 37    | 45   | 1.12 | 0.875 |      |      |        |      |       |      |      |      |      |      |        |      |       |      |      |      |      |      |        |      |       |      |      |      |      |      |        |      |       |      |      |      |      |      |        |      |       |      |      |      |      |      |        |      |       |      |      |      |      |      |        |      |       |      |      |       |       |       |        |       |       |       |        |       |        |
| <b>Pedro Ramos, R</b> (9, 1)<br>ERA: 5.17    | 1.0  | S    | 4    | 2      | 1    | 1     | 0    | 0    | 0    | 0    | 0    | 0      | 0    | 4     | 4    | 9.00 | 2.000 |      |      |        |      |       |      |      |      |      |      |        |      |       |      |      |      |      |      |        |      |       |      |      |      |      |      |        |      |       |      |      |      |      |      |        |      |       |      |      |      |      |      |        |      |       |      |      |      |      |      |        |      |       |      |      |       |       |       |        |       |       |       |        |       |        |

**BOTTOM**

**New York Yankees @ Kansas City Athletics**  
**Municipal Stadium, Kansas City, MO**  
 Sun Sep 06 1964, 4:33 AM EDT  
 Att. 21,372 - Sunny

|            |           |
|------------|-----------|
| <b>AB</b>  | <b>31</b> |
| <b>R</b>   | <b>2</b>  |
| <b>H</b>   | <b>7</b>  |
| <b>RBI</b> | <b>1</b>  |
| <b>BB</b>  | <b>2</b>  |
| <b>SO</b>  | <b>5</b>  |
| <b>LOB</b> | <b>12</b> |



|              |               |
|--------------|---------------|
| <b>WP: 0</b> | <b>PA: 33</b> |
| <b>PB: 0</b> |               |
| <b>SB: 0</b> |               |
| <b>CS: 1</b> |               |
| <b>ERA</b>   | <b>WHIP</b>   |

| Batter   | 1   | 2   | 3   | 4   | 5   | 6   | 7   | 8  | 9   | AB R H RBI BB SO LOB   | TOP  |  |
|--|---|---|---|---|---|---|---|--|---|--|--|--|
| Lenny Green, L<br>OBP: 0.318, SLG: 0.283<br>(1, 8) X   | 0-0<br>F9   |   | 0-0<br>G3   |   | 4-0<br>G4-6-3<br>BB   |   | 0-0<br>F7   | 4-0<br>BB<br>1-2<br>2-3<br>3-H                                   |   | 3 0 0 0 2 0 0  |  |  |
| Luis Aparicio, R<br>OBP: 0.314, SLG: 0.365<br>(1, 6) X   | 0-0<br>S<br>1B  |   | 0-0<br>F8   |   | 0-0<br>G4-6-3<br>1-2f   |   | 0-0<br>F4   | 0-0<br>F8  |   | 5 0 1 0 0 0 4  |  |  |
| Norm Siebern, L<br>OBP: 0.380, SLG: 0.369<br>(1, 3) X  | 0-0<br>F6<br>1-2  |   |   | 0-0<br>1B<br>SF7<br>1B  |   | 0-0<br>F8   |   | 0-0<br>4-3<br>3B<br>1B   | 0-0<br>4-3  | 5 2 2 0 0 0 1  |  |  |
| Boog Powell, L<br>OBP: 0.384, SLG: 0.603<br>Jackie Brandt, R<br>OBP: 0.296, SLG: 0.373<br>(1, 7) B B B B<br>(8, 7) B | 4-0<br>BB   |   |   | 0-0<br>SF7<br>1B<br>1-3   |   | 0-0<br>HR   |   | 0-0<br>4-3<br>1-2  | 0-0<br>5-3  | 3 1 2 1 1 0 1<br>1 0 0 0 0 0 0   |  |  |
| Brooks Robinson, R<br>OBP: 0.348, SLG: 0.493<br>(1, 5) X   | 0-0<br>F6   |   |   | 0-3<br>K<br>S S S   |   | 0-0<br>1B<br>1B   |   | 0-0<br>2B<br>3B<br>2-H   | 0-0<br>6-3  | 5 1 2 1 0 1 4  |  |  |
| Sam Bowens, R<br>OBP: 0.329, SLG: 0.471<br>(1, 9) X  |   | 0-0<br>6-3  |   | 0-0<br>SF7<br>1-2<br>3-H  |   | 0-0<br>F4   |   | 0-0<br>1-3   |   | 3 0 0 1 0 0 2  |  |  |
| Charlie Lau, L<br>OBP: 0.335, SLG: 0.402<br>(1, 2) X   |   | 0-0<br>F4   |   | 0-0<br>F8   |   | 0-0<br>1B<br>1-3  |   | 4-0<br>2B<br>PB<br>IBB   |   | 3 1 1 0 1 0 1  |  |  |
| Jerry Adair, R<br>OBP: 0.283, SLG: 0.332<br>(1, 4) X   |   | 0-0<br>F8   |   |   | 0-0<br>S<br>E<br>2B   | 0-0<br>F9   |   | 0-0<br>PB<br>1-3<br>3-H<br>2B                                    |   | 4 1 2 1 0 0 2  |  |  |
| Wally Bunker, R<br>OBP: 0.152, SLG: 0.083<br>(1, 1) X  |   |   | 0-0<br>F7   |   | 0-0<br>F9<br>2-H  |   | 0-3<br>K2-3   | 4-0<br>PB<br>BB  |   | 3 0 0 0 1 1 0  |  |  |
| <b>Inning Stats</b>  | R: 0<br>E: 0<br>K: 0<br>S: 4<br>H: 1<br>LOB: 2<br>BB: 1<br>P: 8 | R: 0<br>E: 0<br>K: 0<br>S: 3<br>H: 0<br>LOB: 0<br>BB: 0<br>P: 3 | R: 0<br>E: 0<br>K: 0<br>S: 3<br>H: 0<br>LOB: 0<br>BB: 0<br>P: 3 | R: 1<br>E: 0<br>K: 1<br>S: 7<br>H: 2<br>LOB: 1<br>BB: 0<br>P: 7 | R: 1<br>E: 0<br>K: 0<br>S: 3<br>H: 1<br>LOB: 0<br>BB: 1<br>P: 7 | R: 1<br>E: 0<br>K: 0<br>S: 6<br>H: 3<br>LOB: 2<br>BB: 0<br>P: 6 | R: 0<br>E: 0<br>K: 1<br>S: 5<br>H: 0<br>LOB: 0<br>BB: 0<br>P: 5 | R: 3<br>E: 0<br>K: 0<br>S: 6<br>H: 3<br>LOB: 3<br>BB: 3<br>P: 18 | R: 0<br>E: 0<br>K: 0<br>S: 3<br>H: 0<br>LOB: 0<br>BB: 0<br>P: 3 | 1B: 6<br>2B: 2<br>3B: 1<br>HR: 1<br>SF: 1<br>SAC: 0<br>DP: 1<br>HBP: 0 | WP: 0<br>PB: 1<br>SB: 2<br>CS: 0<br>PA: 41 |  |
| <b>PITCHER</b>   | IP WLS BF H R ER SO BB IBB HBP BLK WP HR S P ERA WHIP           |   |   |   |   |   |   |  |   |  |  |  |
| Orlando Pena, R<br>ERA: 4.34<br>(1, 1)   | 7.0 L 30 8 4 3 2 2 0 0 0 0 0 1 32 40 3.86 1.429                 |   |   |   |   |   |   |  |   |  |  |  |
| Ted Bowsfield, L<br>ERA: 4.57<br>(8, 1)  | 0.1 2 1 0 0 0 0 0 0 0 0 0 0 2 2 0.00 3.000                      |   |   |   |   |   |   |  |   |  |  |  |
| Ken Sanders, R<br>ERA: 3.43<br>(8, 1)  | 0.2 6 1 2 2 0 2 1 0 0 0 0 0 3 15 27.00 4.500                    |   |   |   |   |   |   |  |   |  |  |  |
| Jose Santiago, R<br>ERA: 5.04<br>(9, 1)  | 1.0 3 0 0 0 0 0 0 0 0 0 0 0 3 3 0.00 0.000                      |   |   |   |   |   |   |  |   |  |  |  |

Baltimore Orioles @ Kansas City Athletics  
Municipal Stadium, Kansas City, MO  
Mon Sep 07 1964, 4:33 AM EDT  
Unknown

livebaseballscorecards.com

|     |    |
|-----|----|
| AB  | 35 |
| R   | 6  |
| H   | 10 |
| RBI | 4  |
| BB  | 5  |
| SO  | 2  |
| LOB | 15 |







| Batter  | 1  | 2                               | 3                            | 4                               | 5                            | 6                               | 7  | 8                               | 9                            | AB R H RBI BB SO LOB            | TOP                          |                                 |                              |                                 |                              |                                 |                              |                                 |                                  |                                    |                                  |  |
|---|--|---------------------------------|------------------------------|---------------------------------|------------------------------|---------------------------------|--|---------------------------------|------------------------------|---------------------------------|------------------------------|---------------------------------|------------------------------|---------------------------------|------------------------------|---------------------------------|------------------------------|---------------------------------|----------------------------------|------------------------------------|----------------------------------|--|
| Jackie Brandt, R (1, 8)<br>OBP: 0.293, SLG: 0.369   | 0-0<br>F7  |                                 | 0-0<br>6-3                   |                                 | 0-0<br>F8                    |                                 |  | 0-0<br>5-3                      |                              | 4 0 0 0 0 0 1                   |                              |                                 |                              |                                 |                              |                                 |                              |                                 |                                  |                                    |                                  |  |
| Luis Aparicio, R (1, 6)<br>OBP: 0.314, SLG: 0.364   | 0-0<br>6-3<br>1B   |                                 | 0-0<br>5-3                   |                                 | 0-0<br>5-3                   |                                 |  | 0-0<br>F8                       |                              | 4 0 1 0 0 0 1                   |                              |                                 |                              |                                 |                              |                                 |                              |                                 |                                  |                                    |                                  |  |
| Earl Robison, R (1, 7)<br>OBP: 0.306, SLG: 0.410    | 0-0<br>6-3<br>1-2<br>1B  |                                 |                              | 0-0<br>2B<br>1B                 |                              | 0-0<br>G4-3<br>1B               |  |                                 | 0-3<br>K                     | 4 1 2 0 0 1 1                   |                              |                                 |                              |                                 |                              |                                 |                              |                                 |                                  |                                    |                                  |  |
| Brooks Robinson, R (1, 5)<br>OBP: 0.346, SLG: 0.490 | 0-0<br>F3  |                                 |                              | 0-3<br>K                        |                              | 0-3<br>K                        |  |                                 | 0-0<br>F6                    | 4 0 0 0 0 2 3                   |                              |                                 |                              |                                 |                              |                                 |                              |                                 |                                  |                                    |                                  |  |
| Sam Bowens, R (1, 9)<br>OBP: 0.326, SLG: 0.466      |  | 0-0<br>F6                       |                              | 0-3<br>K                        |                              | 0-0<br>G4-3<br>1-2f             |  |                                 | 0-3<br>K                     | 4 0 0 0 0 2 2                   |                              |                                 |                              |                                 |                              |                                 |                              |                                 |                                  |                                    |                                  |  |
| John Orsino, R (1, 3)<br>OBP: 0.291, SLG: 0.363     |  | 0-0<br>E5<br>G5-3<br>1B         |                              | 0-0<br>1-H<br>2B                |                              |                                 | 4-0<br>BB<br>BB<br>BB<br>BB<br>FC6-4<br>BB |                                 |                              | 2 0 1 1 1 0 0                   |                              |                                 |                              |                                 |                              |                                 |                              |                                 |                                  |                                    |                                  |  |
| Jerry Adair, R (1, 4)<br>OBP: 0.283, SLG: 0.332     |  |                                 | 0-0<br>1-2<br>1B             |                                 | 0-0<br>5-3                   |                                 | 0-0<br>FC6-4<br>G5-4-3<br>1-2f             |                                 |                              | 3 0 1 0 0 0 2                   |                              |                                 |                              |                                 |                              |                                 |                              |                                 |                                  |                                    |                                  |  |
| Dick Brown, R (1, 2)<br>OBP: 0.301, SLG: 0.406      |  | 0-0<br>G5-3<br>2-3f             |                              |                                 | 0-0<br>1-3<br>1B             |                                 | 0-0<br>G5-4-3<br>1-2f                      |                                 |                              | 3 0 1 0 0 0 3                   |                              |                                 |                              |                                 |                              |                                 |                              |                                 |                                  |                                    |                                  |  |
| Dave McNally, R (1, 1)<br>OBP: 0.204, SLG: 0.156    |  |                                 | 0-0<br>F9                    |                                 | 0-0<br>1-3                   |                                 |  | 0-0<br>F2                       |                              | 0 0 0 0 0 0 0                   |                              |                                 |                              |                                 |                              |                                 |                              |                                 |                                  |                                    |                                  |  |
| Dave Vineyard, R (1, 1)<br>OBP: 0.250, SLG: 0.182   |  |                                 |                              |                                 |                              |                                 |  |                                 |                              | 2 0 0 0 0 0 1                   |                              |                                 |                              |                                 |                              |                                 |                              |                                 |                                  |                                    |                                  |  |
| Stu Miller, R (7, 1)<br>OBP: 0.125, SLG: 0.250      |  |                                 |                              |                                 |                              |                                 |  |                                 |                              | 0 0 0 0 0 0 0                   |                              |                                 |                              |                                 |                              |                                 |                              |                                 |                                  |                                    |                                  |  |
| Bob Johnson, R (8, PH)<br>OBP: 0.294, SLG: 0.378    |  |                                 |                              |                                 |                              |                                 |  |                                 |                              | 1 0 0 0 0 0 0                   |                              |                                 |                              |                                 |                              |                                 |                              |                                 |                                  |                                    |                                  |  |
| Sam Jones, R (8, 1)                                 |  |                                 |                              |                                 |                              |                                 |  |                                 |                              | 0 0 0 0 0 0 0                   |                              |                                 |                              |                                 |                              |                                 |                              |                                 |                                  |                                    |                                  |  |
| <b>Inning Stats</b>                                 | R: 0<br>E: 0<br>K: 0<br>S: 4   | H: 1<br>LOB: 1<br>BB: 0<br>P: 4 | R: 0<br>E: 1<br>K: 0<br>S: 4 | H: 1<br>LOB: 1<br>BB: 0<br>P: 4 | R: 0<br>E: 0<br>K: 0<br>S: 3 | H: 0<br>LOB: 0<br>BB: 0<br>P: 3 | R: 1<br>E: 0<br>K: 2<br>S: 9               | H: 2<br>LOB: 1<br>BB: 0<br>P: 9 | R: 0<br>E: 0<br>K: 0<br>S: 4 | H: 1<br>LOB: 1<br>BB: 0<br>P: 4 | R: 0<br>E: 0<br>K: 1<br>S: 5 | H: 1<br>LOB: 0<br>BB: 0<br>P: 5 | R: 0<br>E: 0<br>K: 0<br>S: 2 | H: 0<br>LOB: 0<br>BB: 1<br>P: 6 | R: 0<br>E: 0<br>K: 0<br>S: 3 | H: 0<br>LOB: 0<br>BB: 0<br>P: 3 | R: 0<br>E: 0<br>K: 2<br>S: 7 | H: 0<br>LOB: 0<br>BB: 0<br>P: 7 | 1B: 5<br>2B: 1<br>3B: 0<br>HR: 0 | SF: 0<br>SAC: 0<br>DP: 3<br>HBP: 0 | WP: 0<br>PB: 0<br>SB: 0<br>CS: 0 | PA: 32   |
| <b>PITCHER</b><br>Bob Meyer, L (1, 1)<br>ERA: 4.31  | IP: 9.0<br>WLS: W<br>BF: 32<br>H: 6<br>R: 1<br>ER: 1<br>SO: 5<br>BB: 1<br>IBB: 0<br>HBP: 0<br>BLK: 0<br>WP: 0<br>HR: 0<br>S: 41<br>P: 45<br>ERA: 1.00<br>WHIP: 0.778 |                                 |                              |                                 |                              |                                 |  |                                 |                              |                                 |                              |                                 |                              |                                 |                              |                                 |                              |                                 |                                  |                                    | <b>PITCHER</b>                   | IP: 9.0<br>WLS: W<br>BF: 32<br>H: 6<br>R: 1<br>ER: 1<br>SO: 5<br>BB: 1<br>IBB: 0<br>HBP: 0<br>BLK: 0<br>WP: 0<br>HR: 0<br>S: 41<br>P: 45<br>ERA: 1.00<br>WHIP: 0.778 |

Baltimore Orioles @ Kansas City Athletics  
Municipal Stadium, Kansas City, MO  
Mon Sep 07 1964, 4:38 AM EDT  
Att. 15,358 - Unknown

livebaseballscorecards.com

|     |    |
|-----|----|
| AB  | 31 |
| R   | 1  |
| H   | 6  |
| RBI | 1  |
| BB  | 1  |
| SO  | 5  |
| LOB | 14 |



| Batter  | 1                            | 2          | 3 | 4 | 5          | 6 | 7                       | 8 | 9 |
|---|------------------------------|------------|---|---|------------|---|-------------------------|---|---|
| Bert Campaneris, R (1, 7)<br>OBP: 0.339, SLG: 0.434<br>Jose Tartabull, L (8, 7)<br>OBP: 0.253, SLG: 0.242 | 0-0<br>1B<br>2B<br>1B        | 4-0<br>BB  |   |   | 0-0<br>6-3 |   | 0-3<br>K                |   |   |
| Wayne Causey, L (1, 6)<br>OBP: 0.400, SLG: 0.407  | 0-0<br>2B<br>1-3<br>HR<br>1B | 0-0<br>4-3 |   |   | 0-3<br>K   |   | 0-0<br>4-3              |   |   |
| Rocky Colavito, R (1, 9)<br>OBP: 0.370, SLG: 0.530  | 0-0<br>1-3<br>HR<br>2B       |            |   |   | 0-3<br>K   |   | 0-0<br>1B               |   |   |
| Jim Gentile, L (1, 3)<br>OBP: 0.384, SLG: 0.510   | 0-0<br>2-H<br>3-H<br>HR      |            |   |   | 0-0<br>HR  |   | 0-0<br>BB<br>1B         |   |   |
| Doc Edwards, R (1, 2)<br>OBP: 0.247, SLG: 0.298   | 0-0<br>F7                    |            |   |   | 0-0<br>5-3 |   | 0-3<br>K                |   |   |
| Ed Charles, R (1, 5)<br>OBP: 0.316, SLG: 0.367  | 0-3<br>K                     |            |   |   | 0-0<br>6-3 |   | 0-3<br>K                |   |   |
| Nelson Mathews, R (1, 8)<br>OBP: 0.301, SLG: 0.386  | 0-3<br>K                     |            |   |   | 0-3<br>K   |   | 4-0<br>1B<br>1-2<br>BB  |   |   |
| Dick Green, R (1, 4)<br>OBP: 0.305, SLG: 0.383  |                              |            |   |   | 0-0<br>1-3 |   | 0-0<br>1-3<br>2-H<br>1B |   |   |
| Bob Meyer, R (1, 1)   |                              |            |   |   | 0-3<br>K   |   | 0-0<br>G3               |   |   |

| Inning Stats                     | R: 4<br>E: 0<br>K: 2<br>S: 11      | H: 4<br>LOB: 0<br>BB: 0<br>P: 11 | R: 0<br>E: 0<br>K: 2<br>S: 7 | H: 0<br>LOB: 1<br>BB: 1<br>P: 11 | R: 1<br>E: 0<br>K: 1<br>S: 6 | H: 1<br>LOB: 0<br>BB: 0<br>P: 6 | R: 0<br>E: 0<br>K: 2<br>S: 7 | H: 0<br>LOB: 0<br>BB: 0<br>P: 7 | R: 0<br>E: 0<br>K: 2<br>S: 7 | H: 0<br>LOB: 0<br>BB: 0<br>P: 7 | R: 1<br>E: 0<br>K: 2<br>S: 9 | H: 2<br>LOB: 2<br>BB: 1<br>P: 13 | R: 0<br>E: 0<br>K: 2<br>S: 8 | H: 1<br>LOB: 1<br>BB: 0<br>P: 8 | R: 0<br>E: 0<br>K: 1<br>S: 5 | H: 0<br>LOB: 0<br>BB: 0<br>P: 5 |
|----------------------------------|------------------------------------|----------------------------------|------------------------------|----------------------------------|------------------------------|---------------------------------|------------------------------|---------------------------------|------------------------------|---------------------------------|------------------------------|----------------------------------|------------------------------|---------------------------------|------------------------------|---------------------------------|
| 1B: 5<br>2B: 1<br>3B: 0<br>HR: 2 | SF: 0<br>SAC: 0<br>DP: 0<br>HBP: 0 | WP: 0<br>PB: 0<br>SB: 0<br>CS: 0 |                              |                                  |                              |                                 |                              |                                 |                              |                                 |                              |                                  |                              |                                 |                              |                                 |

| PITCHER                              | IP  | WLS | BF | H | R | ER | SO | BB | IBB | HBP | BLK | WP | HR | S  | P  | ERA  | WHIP  |
|--------------------------------------|-----|-----|----|---|---|----|----|----|-----|-----|-----|----|----|----|----|------|-------|
| Dave McNally, L (1, 1)<br>ERA: 3.94  | 0.0 | L   | 4  | 4 | 4 | 4  | 0  | 0  | 0   | 0   | 0   | 0  | 1  | 4  | 4  | ∞    | ∞     |
| Dave Vineyard, R (1, 1)<br>ERA: 3.86 | 6.0 |     | 23 | 3 | 2 | 2  | 11 | 2  | 0   | 0   | 0   | 0  | 1  | 43 | 51 | 3.00 | 0.833 |
| Stu Miller, R (7, 1)<br>ERA: 2.85    | 1.0 |     | 4  | 1 | 0 | 0  | 2  | 0  | 0   | 0   | 0   | 0  | 0  | 8  | 8  | 0.00 | 1.000 |
| Sam Jones, R (8, 1)<br>ERA: 6.0      | 1.0 |     | 3  | 0 | 0 | 0  | 1  | 0  | 0   | 0   | 0   | 0  | 0  | 5  | 5  | 0.00 | 0.000 |

**BOTTOM**

**Baltimore Orioles @ Kansas City Athletics**  
Municipal Stadium, Kansas City, MO

Mon Sep 07 1964, 4:38 AM EDT  
Att. 15,358 - Unknown

livebaseballscorecards.com

|     |    |
|-----|----|
| AB  | 32 |
| R   | 6  |
| H   | 8  |
| RBI | 6  |
| BB  | 2  |
| SO  | 14 |
| LOB | 6  |



|       |        |
|-------|--------|
| WP: 0 | PA: 34 |
| PB: 0 |        |
| SB: 0 |        |
| CS: 0 |        |

| Batter   | 1   | 2   | 3   | 4   | 5   | 6   | 7   | 8   | 9   | AB R H RBI BB SO LOB                                       | TOP                                     |  |
|--|---|---|---|---|---|---|---|---|---|--|---|--|
| <b>Bert Campaneris, R</b> (1, 7)<br>OBP: 0.337, SLG: 0.427 | 4-0<br>BB<br>5-3                                      |   | 0-0<br>FC1-4<br>1-2f                                |   | 0-0<br>F8   |   | 0-0<br>F8   |   |   | 3 0 0 0 1 0 2  |   |  |
| <b>Wayne Causey, L</b> (1, 6)<br>OBP: 0.397, SLG: 0.404    | 0-0<br>F6   |   | 0-0<br>F8   |   | 0-0<br>F7   |   | 0-0<br>F3   |   |   | 4 0 0 0 0 0 3  |   |  |
| <b>Tommie Reynolds, R</b> (1, 5)<br>OBP: 0.313, SLG: 0.310 | 0-0<br>5-3<br>1-2                                     |   | 0-3<br>K  |   |   | 0-0<br>E6<br>1B                                     |   | 0-3<br>K  |   | 4 1 0 0 0 2 2  |   |  |
| <b>Rocky Colavito, R</b> (1, 9)<br>OBP: 0.367, SLG: 0.525  | 0-0<br>F8   |   |   | 0-0<br>L8   |   | 0-0<br>F7   |   | 0-0<br>F6   |   | 4 0 0 0 0 0 2  |   |  |
| <b>Jim Gentile, L</b> (1, 3)<br>OBP: 0.385, SLG: 0.509     |   | 0-0<br>4-3  |   | 0-0<br>WP<br>1B                                     |   | 0-0<br>1B<br>1B                                     |   | 0-3<br>K  |   | 4 0 2 0 0 1 0  |   |  |
| <b>Billy Bryan, L</b> (1, 2)<br>OBP: 0.288, SLG: 0.477     |   | 0-0<br>F8   |   | 0-0<br>F5<br>1-2                                    |   | 0-0<br>1B<br>1B                                     |   | 0-3<br>K  | 3 0 1 1 0 0 1                                       |  |   |  |
| <b>Ken Harrelson, R</b> (9, PH)<br>OBP: 0.258, SLG: 0.415  |   |   |   | 1-2   |   | 1-2<br>3-H<br>1B                                    |   |   | 1 0 0 0 0 1 0                                       |  |   |  |
| <b>Nelson Mathews, R</b> (1, 8)<br>OBP: 0.302, SLG: 0.393  |   | 0-0<br>HR   |   | 0-0<br>6-3  |   | 0-3<br>K  |   | 0-0<br>1B   | 4 1 2 1 0 1 3                                       |  |   |  |
| <b>Dick Green, R</b> (1, 4)<br>OBP: 0.305, SLG: 0.382      |   | 0-0<br>2-3  |   |   | 0-0<br>1B   | 0-0<br>5-3  |   | 0-0<br>F9   | 4 0 1 0 0 0 3                                       |  |   |  |
| <b>John O'Donoghue, R</b> (1, 1)<br>OBP: 0.256, SLG: 0.314 |   |   | 0-0<br>FC1-4<br>1B                                  |   | 0-0<br>F7   |   | 0-0<br>F6   | 0-0<br>F8   | 1 0 1 0 0 0 0                                       |  |   |  |
| <b>Jose Santiago, R</b> (4, 1)<br>OBP: 0.250, SLG: 0.239   |   |   |   |   |   |   |   |   | 0 0 0 0 0 0 0                                       |  |   |  |
| <b>Jose Tartabull, L</b> (5, PH)                           |   |   |   |   |   |   |   |   | 1 0 0 0 0 0 1                                       |  |   |  |
| <b>Ken Sanders, R</b> (5, 1)                               |   |   |   |   |   |   |   |   | 0 0 0 0 0 0 0                                       |  |   |  |
| <b>Larry Stahl, L</b> (7, PH)                              |   |   |   |   |   |   |   |   | 1 0 0 0 0 0 0                                       |  |   |  |
| <b>Moe Drabowsky, R</b> (7, 1)<br>OBP: 0.045, SLG: 0.023   |   |   |   |   |   |   |   |   | 0 0 0 0 0 0 0                                       |  |   |  |
| <b>Doc Edwards, R</b> (9, PH)<br>OBP: 0.246, SLG: 0.297    |   |   |   |   |   |   |   |   | 1 0 0 0 0 0 1                                       |  |   |  |
| <b>Inning Stats</b>  | R: 0 H: 0<br>E: 0 LOB: 1<br>K: 0 BB: 1<br>S: 3 P: 7   | R: 1 H: 1<br>E: 0 LOB: 0<br>K: 0 BB: 0<br>S: 4 P: 4 | R: 0 H: 1<br>E: 0 LOB: 1<br>K: 1 BB: 0<br>S: 6 P: 6 | R: 0 H: 1<br>E: 0 LOB: 1<br>K: 0 BB: 0<br>S: 4 P: 4 | R: 0 H: 1<br>E: 0 LOB: 1<br>K: 0 BB: 0<br>S: 4 P: 4 | R: 1 H: 2<br>E: 1 LOB: 2<br>K: 1 BB: 0<br>S: 8 P: 8 | R: 0 H: 0<br>E: 0 LOB: 0<br>K: 2 BB: 0<br>S: 3 P: 3 | R: 0 H: 0<br>E: 0 LOB: 0<br>K: 1 BB: 0<br>S: 6 P: 6 | R: 0 H: 1<br>E: 0 LOB: 1<br>K: 1 BB: 0<br>S: 6 P: 6 | 1B: 6 SF: 0<br>2B: 0 SAC: 0<br>3B: 0 DP: 0<br>HR: 1 HBP: 0 | WP: 1 PA: 36<br>PB: 0<br>SB: 0<br>CS: 0 |  |
| <b>PITCHER</b>   | IP WLS BF H R ER SO BB IBB HBP BLK WP HR S P ERA WHIP |   |   |   |   |   |   |   |   |  |   |  |
| <b>Wally Bunker, R</b> (1, 1)<br>ERA: 2.59                 | 7.0 W 29 6 2 1 2 1 0 0 0 0 1 1 32 36 1.29 1.000       |   |   |   |   |   |   |   |   |  |   |  |
| <b>Harvey Haddix, L</b> (8, 1)<br>ERA: 2.25                | 2.0 S 7 1 0 0 3 0 0 0 0 0 0 0 13 13 0.00 0.500        |   |   |   |   |   |   |   |   |  |   |  |

**Kansas City Athletics @ Baltimore Orioles**  
**Memorial Stadium, Baltimore, MD**  
 Fri Sep 11 1964, 7:05 PM EDT  
 Unknown

[livebaseballscorecards.com](http://livebaseballscorecards.com)

|            |    |
|------------|----|
| <b>AB</b>  | 35 |
| <b>R</b>   | 2  |
| <b>H</b>   | 7  |
| <b>RBI</b> | 2  |
| <b>BB</b>  | 1  |
| <b>SO</b>  | 5  |
| <b>LOB</b> | 18 |

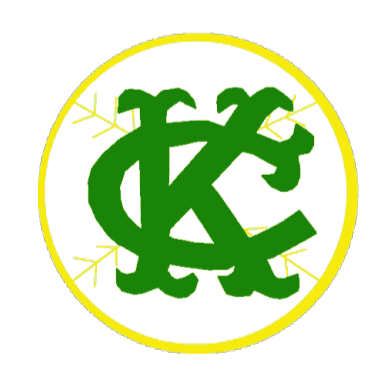

| Batter   | 1       | 2         | 3              | 4         | 5       | 6       | 7       | 8     | 9 |
|--|---------|-----------|----------------|-----------|---------|---------|---------|-------|---|
| Jackie Brandt, R<br>OBP: 0.297, SLG: 0.371 (1, 8)        | 0-0 F6  | 0-0 E7    |                | 4-0 2B    |         | 0-0 2-3 |         | 0-3 K |   |
| Luis Aparicio, R<br>OBP: 0.314, SLG: 0.365 (1, 6)        | 0-0 6-3 | 0-0 5-3   |                | 1-1 1B    |         | 4-0 BB  |         |       |   |
| Boog Powell, L<br>OBP: 0.391, SLG: 0.614 (1, 7)          | 0-0 F6  |           | 0-0 4-3        | 4-0 BB 1B |         | 0-0 F8  |         |       |   |
| Norm Siebern, L<br>OBP: 0.379, SLG: 0.364 (6, PH) (7, 3) |         |           |                | BB 1B     |         |         |         |       |   |
| Brooks Robinson, R<br>OBP: 0.355, SLG: 0.501 (1, 5)      |         | 0-0 E 2B  | 0-0 FC5-4 1B   | 0-0 BB 1B |         | 0-0 F7  |         |       |   |
| Sam Bowers, R<br>OBP: 0.327, SLG: 0.469 (1, 9)           |         | 0-0 E5 2B | 0-0 FC5-4 E 1B | 4-0 BB    |         | 0-0 4-3 |         |       |   |
| Bob Johnson, R<br>OBP: 0.287, SLG: 0.368 (1, 3)          |         | 0-3 K     | 0-0 E6         | 0-0 F9    |         | 0-0 6-3 |         |       |   |
| Russ Snyder, L<br>OBP: 0.352, SLG: 0.333 (7, 7)          |         |           | 1-2            |           |         |         |         |       |   |
| Jerry Adair, R<br>OBP: 0.281, SLG: 0.332 (1, 4)          |         | 0-0 1B 2B | 0-3 K          |           | 0-0 3-1 |         | 0-0 4-3 |       |   |
| John Orsino, R<br>OBP: 0.293, SLG: 0.356 (1, 2)          |         | 0-0 F8    |                | 0-0 E5    | 0-0 F6  |         | 0-3 K   |       |   |
| Wally Bunker, R<br>OBP: 0.159, SLG: 0.081 (1, 1)         |         | 4-0 E 1B  |                | 0-0 P1-3  | 0-0 4-3 |         | 0-3 K   |       |   |
| Harvey Haddix, L<br>(8, 1)                               |         |           |                | 1-2       |         |         |         |       |   |

| AB | R | H | RBI | BB | SO | LOB |
|----|---|---|-----|----|----|-----|
| 4  | 1 | 1 | 1   | 1  | 1  | 0   |
| 3  | 1 | 1 | 1   | 1  | 0  | 2   |
| 2  | 0 | 0 | 0   | 1  | 0  | 0   |
| 1  | 0 | 0 | 0   | 0  | 0  | 1   |
| 4  | 1 | 3 | 1   | 0  | 0  | 1   |
| 3  | 1 | 0 | 0   | 1  | 0  | 2   |
| 3  | 0 | 0 | 0   | 0  | 1  | 6   |
| 1  | 0 | 0 | 0   | 0  | 0  | 0   |
| 4  | 1 | 1 | 2   | 0  | 1  | 2   |
| 4  | 0 | 0 | 0   | 0  | 1  | 1   |
| 2  | 0 | 0 | 0   | 1  | 0  | 1   |
| 1  | 0 | 0 | 0   | 0  | 1  | 0   |

| AB  | 32 |
|-----|----|
| R   | 5  |
| H   | 6  |
| RBI | 5  |
| BB  | 5  |
| SO  | 5  |
| LOB | 16 |

| Inning Stats |                           | R: 0 | H: 0 | E: 0 | K: 0 | S: 3 | R: 3 | H: 3 | E: 2 | K: 1 | S: 9 | R: 0 | H: 1 | E: 1 | K: 1 | S: 7 | R: 2 | H: 2 | E: 1 | K: 0 | S: 5 | R: 0 | H: 0 | E: 0 | K: 0 | S: 3 | R: 0 | H: 0 | E: 0 | K: 0 | S: 3 | R: 0 | H: 0  | E: 0 | K: 3 | S: 9 | R: 0 | H: 0 | E: 0 | K: 3 | S: 9 |  |  |  |  |
|--------------|---------------------------|------|------|------|------|------|------|------|------|------|------|------|------|------|------|------|------|------|------|------|------|------|------|------|------|------|------|------|------|------|------|------|-------|------|------|------|------|------|------|------|------|--|--|--|--|
| IP           | 3.2                       | WLS  | L    | BF   | 22   | H    | 6    | R    | 5    | ER   | 3    | SO   | 2    | BB   | 3    | IBB  | 0    | HBP  | 0    | BLK  | 0    | WP   | 0    | HR   | 0    | S    | 23   | P    | 35   | ERA  | 7.36 | WHIP | 2.455 |      |      |      |      |      |      |      |      |  |  |  |  |
| PITCHER      | John O'Donoghue, L (1, 1) |      |      |      |      |      |      |      |      |      |      |      |      |      |      |      |      |      |      |      |      |      |      |      |      |      |      |      |      |      |      |      |       |      |      |      |      |      |      |      |      |  |  |  |  |
|              | Jose Santiago, R (4, 1)   |      |      |      |      |      |      |      |      |      |      |      |      |      |      |      |      |      |      |      |      |      |      |      |      |      |      |      |      |      |      |      |       |      |      |      |      |      |      |      |      |  |  |  |  |
|              | Ken Sanders, R (5, 1)     |      |      |      |      |      |      |      |      |      |      |      |      |      |      |      |      |      |      |      |      |      |      |      |      |      |      |      |      |      |      |      |       |      |      |      |      |      |      |      |      |  |  |  |  |
|              | Moe Drabowsky, R (7, 1)   |      |      |      |      |      |      |      |      |      |      |      |      |      |      |      |      |      |      |      |      |      |      |      |      |      |      |      |      |      |      |      |       |      |      |      |      |      |      |      |      |  |  |  |  |

**Kansas City Athletics @ Baltimore Orioles**  
**Memorial Stadium, Baltimore, MD**  
 Fri Sep 11 1964, 7:05 PM EDT  
 Unknown

[livebaseballscorecards.com](http://livebaseballscorecards.com)

**WP: 0 PA: 37**  
**PB: 0 SB: 0**  
**CS: 0**



| Batter  | 1   | 2   | 3  | 4   | 5   | 6  | 7  | 8   | 9   | AB R H RBI BB SO LOB                                       | TOP   |
|---|---|---|--|---|---|--|--|---|---|--|---|
| Bert Campaneris, R (1, 7)<br>OBP: 0.333, SLG: 0.418<br>Jose Tartabull, L (8, 7)<br>OBP: 0.250, SLG: 0.239 | 0-3<br>K  | 0-0<br>6-3  |  | 0-3<br>K  |   | 4-0<br>2B BB   |  | 0-3<br>K  |   | 4 1 0 1 1 3 1<br>0 0 0 0 0 0 0                             | <b>Kansas City Athletics @ Baltimore Orioles</b><br><b>Memorial Stadium, Baltimore, MD</b><br>Fri Sep 11 1964, 7:05 PM EDT<br>Att. 21,622 - Unknown |
| Wayne Causey, L (1, 6)<br>OBP: 0.400, SLG: 0.413  | 0-0<br>HR 2B  |   | 0-0<br>2B 2B   | 0-0<br>F7   |   | 0-0<br>1B SH1-4 2B                                   |  | 0-0<br>1B   |   | 5 3 4 3 0 0 1  |   |
| Rocky Colavito, R (1, 9)<br>OBP: 0.369, SLG: 0.531  | 0-0<br>HR   |   | 0-0<br>6-3   |   | 0-0<br>6-3  | 0-0<br>SH1-4 1B                                      |  | 4-0<br>BB   |   | 4 1 2 2 1 0 1  |   |
| Jim Gentile, L (1, 3)<br>OBP: 0.386, SLG: 0.508   | 0-0<br>1B 1B  |   | 4-0<br>2B BB   |   | 0-3<br>K  | 0-0<br>SH1-4   |  | 0-0<br>F5   |   | 3 0 1 1 1 1 1  |   |
| Nelson Mathews, R (1, 8)<br>OBP: 0.301, SLG: 0.391  | 0-0<br>1-2 1B   |   | 0-0<br>F2  |   | 0-0<br>F2   | 0-0<br>F6  |  | 0-0<br>F9   |   | 5 0 1 0 0 0 3  |   |
| Doc Edwards, R (1, 2)<br>OBP: 0.253, SLG: 0.303   | 0-0<br>F9   |   | 0-0<br>1-3 2-H 2B                                    |   | 0-0<br>F9   | 0-0<br>WP 1B BB                                      | 4-0<br>FC4-6 BB                                      | 0-3<br>K  |   | 4 1 2 1 1 1 2  |   |
| Tommie Reynolds, R (1, 5)<br>OBP: 0.296, SLG: 0.290<br>Ed Charles, R (7, 5)<br>OBP: 0.318, SLG: 0.368     | 0-0<br>4-3  |   | 0-3<br>K   |   | 0-0<br>F4   | 0-3<br>K   |  | 0-0<br>1B   |   | 4 0 0 0 0 2 6<br>1 0 1 0 0 0 0                             |   |
| Dick Green, R (1, 4)<br>OBP: 0.306, SLG: 0.382  |   | 0-0<br>F4   |  | 0-0<br>1B   |   | 0-0<br>BB WP 2B 1B                                   | 0-0<br>FC4-6   | 0-0<br>F7   |   | 5 1 2 0 0 0 2  |   |
| Blue Moon Odom, R (1, 1)  |   | 0-3<br>K  |  | 0-3<br>K  |   | 4-0<br>BB 2B BB                                      | 0-3<br>K   |   |   | 3 1 0 0 1 3 2  |   |
| <b>Inning Stats</b>   | R: 2 H: 4<br>E: 0 LOB: 2<br>K: 1 BB: 0<br>S: 9 P: 9   | R: 0 H: 0<br>E: 0 LOB: 0<br>K: 1 BB: 0<br>S: 5 P: 5 | R: 1 H: 2<br>E: 0 LOB: 2<br>K: 1 BB: 1<br>S: 7 P: 11 | R: 0 H: 1<br>E: 0 LOB: 1<br>K: 2 BB: 0<br>S: 8 P: 8 | R: 0 H: 0<br>E: 0 LOB: 0<br>K: 1 BB: 0<br>S: 5 P: 5 | R: 5 H: 4<br>E: 0 LOB: 1<br>K: 0 BB: 2<br>S: 7 P: 15 | R: 0 H: 0<br>E: 0 LOB: 1<br>K: 2 BB: 1<br>S: 7 P: 11 | R: 0 H: 1<br>E: 0 LOB: 1<br>K: 1 BB: 1<br>S: 5 P: 9 | R: 0 H: 1<br>E: 0 LOB: 1<br>K: 1 BB: 0<br>S: 6 P: 6 | 1B: 8 SF: 0<br>2B: 4 SAC: 1<br>3B: 0 DP: 0<br>HR: 1 HBP: 0 |   |
| <b>PITCHER</b>  | IP WLS BF H R ER SO BB IBB HBP BLK WP HR S P ERA WHIP |   |  |   |   |  |  |   |   |  |   |
| Dave Vineyard, R (1, 1)<br>ERA: 4.2   | 2.2 L 15 6 3 3 2 1 0 0 0 0 0 1 18 22 10.12 2.625      |   |  |   |   |  |  |   |   |  |   |
| Chuck Estrada, R (3, 1)<br>ERA: 5.13  | 0.1 1 0 0 0 1 0 0 0 0 0 0 0 3 3 0.00 0.000            |   |  |   |   |  |  |   |   |  |   |
| Stu Miller, R (4, 1)<br>ERA: 3.2  | 2.1 12 3 4 4 3 2 0 0 0 1 0 16 24 15.43 2.143          |   |  |   |   |  |  |   |   |  |   |
| Harvey Haddix, L (6, 1)<br>ERA: 2.35  | 0.2 4 2 1 1 0 0 0 0 0 0 0 0 4 4 13.50 3.000           |   |  |   |   |  |  |   |   |  |   |
| Sam Jones, R (7, 1)<br>ERA: 3.0   | 3.0 12 2 0 0 4 2 0 0 0 0 0 0 18 26 0.00 1.333         |   |  |   |   |  |  |   |   |  |   |

livebaseballscores.com

|     |    |
|-----|----|
| AB  | 38 |
| R   | 8  |
| H   | 13 |
| RBI | 8  |
| BB  | 5  |
| SO  | 10 |
| LOB | 19 |



| Batter  | 1          | 2          | 3               | 4          | 5          | 6                            | 7 | 8                        | 9 |
|---|------------|------------|-----------------|------------|------------|------------------------------|---|--------------------------|---|
| <b>Jackie Brandt, R</b> (1, 8)<br><small>OBP: 0.298, SLG: 0.370</small><br><b>Stu Miller, R</b> (4, 1)<br><small>OBP: 0.125, SLG: 0.250</small><br><b>Harvey Haddix, L</b> (6, 1)<br><b>Russ Snyder, L</b> (6, PH)<br><small>OBP: 0.347, SLG: 0.328</small><br><b>Sam Jones, R</b> (7, 1) | 4-0<br>BB  |            | 0-3<br>1-2<br>K |            |            | 0-0<br>5-3                   |   | 4-0<br>1-3<br>BB         |   |
| <b>Luis Aparicio, R</b> (1, 6)<br><small>OBP: 0.312, SLG: 0.362</small>   | 0-3<br>K   |            | 0-3<br>K        |            |            | 0-0<br>F6                    |   | 0-0<br>1-3               |   |
| <b>Norm Siebern, L</b> (1, 3)<br><small>OBP: 0.378, SLG: 0.362</small>  | 0-0<br>F8  |            | 0-3<br>K        |            |            | 4-0<br>BB                    |   | 0-0<br>4-3               |   |
| <b>Boog Powell, L</b> (1, 7)<br><small>OBP: 0.390, SLG: 0.609</small>   | 0-0<br>6-3 |            |                 | 0-0<br>4-3 |            | 0-0<br>F4                    |   | 4-0<br>1B<br>BB          |   |
| <b>Brooks Robinson, R</b> (1, 5)<br><small>OBP: 0.356, SLG: 0.500</small>   |            | 0-0<br>6-3 |                 | 0-0<br>6-3 |            | 4-0<br>G3-6-1<br>1B<br>BB    |   | 0-0<br>1-2<br>G6-3<br>1B |   |
| <b>Sam Bowens, R</b> (1, 9)<br><small>OBP: 0.326, SLG: 0.467</small>  |            | 0-3<br>K   |                 | 0-3<br>K   |            | 0-0<br>1-2<br>G3-6-1<br>1B   |   | 0-0<br>F3                |   |
| <b>Charlie Lau, L</b> (1, 2)<br><small>OBP: 0.328, SLG: 0.397</small>   |            | 0-3<br>K   |                 |            | 0-0<br>G3  | 0-0<br>1-2f<br>2-3<br>G3-6-1 |   | 0-0<br>1-2f<br>G6-3      |   |
| <b>Jerry Adair, R</b> (1, 4)<br><small>OBP: 0.279, SLG: 0.330</small>   |            | 0-0<br>F4  |                 |            | 0-0<br>6-3 | 0-0<br>6-3                   |   |                          |   |
| <b>Dave Vineyard, R</b> (1, 1)<br><small>OBP: 0.250, SLG: 0.182</small><br><b>Chuck Estrada, R</b> (3, 1)<br><small>OBP: 0.143, SLG: 0.143</small><br><b>Lenny Green, L</b> (3, PH)<br><small>OBP: 0.314, SLG: 0.275</small><br>(4, 8)  |            |            | 4-0<br>WP<br>BB |            | 0-0<br>6-3 |                              |   | 0-0<br>4-3               |   |

|    |   |   |     |    |    |     |
|----|---|---|-----|----|----|-----|
| AB | R | H | RBI | BB | SO | LOB |
| 1  | 0 | 0 | 0   | 1  | 1  | 1   |
| 0  | 0 | 0 | 0   | 0  | 0  | 0   |
| 0  | 0 | 0 | 0   | 0  | 0  | 0   |
| 1  | 0 | 0 | 0   | 0  | 0  | 0   |
| 0  | 0 | 0 | 0   | 1  | 0  | 0   |

|   |   |   |   |   |   |   |
|---|---|---|---|---|---|---|
| 4 | 0 | 0 | 0 | 0 | 2 | 3 |
|---|---|---|---|---|---|---|

|   |   |   |   |   |   |   |
|---|---|---|---|---|---|---|
| 3 | 0 | 0 | 0 | 1 | 1 | 3 |
|---|---|---|---|---|---|---|

|   |   |   |   |   |   |   |
|---|---|---|---|---|---|---|
| 3 | 0 | 0 | 0 | 1 | 0 | 2 |
|---|---|---|---|---|---|---|

|   |   |   |   |   |   |   |
|---|---|---|---|---|---|---|
| 3 | 0 | 1 | 0 | 1 | 0 | 0 |
|---|---|---|---|---|---|---|

|   |   |   |   |   |   |   |
|---|---|---|---|---|---|---|
| 4 | 0 | 1 | 0 | 0 | 2 | 2 |
|---|---|---|---|---|---|---|

|   |   |   |   |   |   |   |
|---|---|---|---|---|---|---|
| 4 | 0 | 0 | 0 | 0 | 1 | 4 |
|---|---|---|---|---|---|---|

|   |   |   |   |   |   |   |
|---|---|---|---|---|---|---|
| 3 | 0 | 0 | 0 | 0 | 0 | 2 |
|---|---|---|---|---|---|---|

|   |   |   |   |   |   |   |
|---|---|---|---|---|---|---|
| 0 | 0 | 0 | 0 | 0 | 0 | 0 |
| 0 | 0 | 0 | 0 | 0 | 0 | 0 |
| 2 | 0 | 0 | 0 | 1 | 0 | 0 |

**BOTTOM**

**Kansas City Athletics @ Baltimore Orioles**  
 Memorial Stadium, Baltimore, MD

livebaseballscores.com

|            |           |
|------------|-----------|
| <b>AB</b>  | <b>28</b> |
| <b>R</b>   | <b>0</b>  |
| <b>H</b>   | <b>2</b>  |
| <b>RBI</b> | <b>0</b>  |
| <b>BB</b>  | <b>6</b>  |
| <b>SO</b>  | <b>7</b>  |
| <b>LOB</b> | <b>17</b> |



|       |        |
|-------|--------|
| WP: 2 | PA: 34 |
| PB: 0 |        |
| SB: 0 |        |
| CS: 0 |        |

| Inning Stats | R | H | E | K | S | R | H | E | K | S | R | H | E | K | S | R | H | E | K | S  | R | H | E | K | S | R | H | E | K | S | R | H | E | K | S |   |   |   |
|--------------|---|---|---|---|---|---|---|---|---|---|---|---|---|---|---|---|---|---|---|----|---|---|---|---|---|---|---|---|---|---|---|---|---|---|---|---|---|---|
|              | 0 | 0 | 0 | 1 | 9 | 0 | 0 | 0 | 2 | 8 | 0 | 0 | 0 | 3 | 5 | 0 | 0 | 0 | 1 | 13 | 0 | 0 | 0 | 0 | 3 | 0 | 0 | 0 | 0 | 0 | 0 | 0 | 0 | 0 | 0 | 0 | 0 | 0 |

|   |           |            |           |          |          |           |           |           |            |            |            |           |           |          |          |            |             |
|---|-----------|------------|-----------|----------|----------|-----------|-----------|-----------|------------|------------|------------|-----------|-----------|----------|----------|------------|-------------|
| <b>PITCHER</b>  | <b>IP</b> | <b>WLS</b> | <b>BF</b> | <b>H</b> | <b>R</b> | <b>ER</b> | <b>SO</b> | <b>BB</b> | <b>IBB</b> | <b>HBP</b> | <b>BLK</b> | <b>WP</b> | <b>HR</b> | <b>S</b> | <b>P</b> | <b>ERA</b> | <b>WHIP</b> |
| <b>Blue Moon Odom, R</b> (1, 1)<br><small>ERA: 4.91</small> | 9.0       | W          | 34        | 2        | 0        | 0         | 7         | 6         | 0          | 0          | 0          | 2         | 0         | 42       | 66       | 0.00       | 0.889       |

|                |           |            |           |          |          |           |           |           |            |            |            |           |           |          |          |            |             |
|----------------|-----------|------------|-----------|----------|----------|-----------|-----------|-----------|------------|------------|------------|-----------|-----------|----------|----------|------------|-------------|
| <b>PITCHER</b> | <b>IP</b> | <b>WLS</b> | <b>BF</b> | <b>H</b> | <b>R</b> | <b>ER</b> | <b>SO</b> | <b>BB</b> | <b>IBB</b> | <b>HBP</b> | <b>BLK</b> | <b>WP</b> | <b>HR</b> | <b>S</b> | <b>P</b> | <b>ERA</b> | <b>WHIP</b> |
|----------------|-----------|------------|-----------|----------|----------|-----------|-----------|-----------|------------|------------|------------|-----------|-----------|----------|----------|------------|-------------|

Fri Sep 11 1964, 7:05 PM EDT  
 Att. 21,622 - Unknown

| Batter  | 1   | 2   | 3   | 4   | 5  | 6   | 7   | 8   | 9   | AB R H RBI BB SO LOB                                       | TOP                                     |  |
|---|---|---|---|---|--|---|---|---|---|--|---|--|
| Bert Campaneris, R (1, 7)<br>OBP: 0.327, SLG: 0.409<br>Jose Tartabull, L (8, 7)<br>OBP: 0.250, SLG: 0.239 | 0-0<br>1-6-3  |   | 0-0<br>F8   |   | 0-0<br>F3  |   |   | 0-0<br>F6   |   | 4 0 0 0 0 0 3<br>0 0 0 0 0 0 0                             |   |  |
| Wayne Causey, L (1, 6)<br>OBP: 0.399, SLG: 0.411  | 4-0<br>BB   |   | 0-0<br>F7   |   |  | 0-0<br>4-3  |   | 0-0<br>4-3  |   | 3 0 0 0 1 0 1  |   |  |
| Rocky Colavito, R (1, 9)<br>OBP: 0.369, SLG: 0.528  | 0-0<br>F8   |   |   | 0-0<br>F6   |  | 0-0<br>F4   |   |   | 4-0<br>S<br>BB                                      | 3 0 0 0 1 0 1  |   |  |
| Jim Gentile, L (1, 3)<br>OBP: 0.385, SLG: 0.504   | 0-0<br>F2   |   |   | 0-3<br>K  |  | 4-0<br>BB   |   |   | 0-0<br>F8<br>1-2                                    | 3 0 0 0 1 1 2  |   |  |
| Nelson Mathews, R (1, 8)<br>OBP: 0.299, SLG: 0.388  |   | 0-3<br>K  |   | 0-0<br>5-3  |  | 0-0<br>5-3  |   |   | 0-0<br>F7   | 4 0 0 0 0 1 2  |   |  |
| Doc Edwards, R (1, 2)<br>OBP: 0.253, SLG: 0.306   |   | 0-0<br>F2   |   |   | 0-0<br>SH1-4<br>2B                                   |   | 0-3<br>K  |   | 0-0<br>6-3  | 4 0 1 0 0 1 1  |   |  |
| Ed Charles, R (1, 5)<br>OBP: 0.316, SLG: 0.366  |   | 0-3<br>K  |   |   | 0-3<br>K   |   | 0-0<br>F9   |   |   | 3 0 0 0 0 2 1  |   |  |
| Dick Green, R (1, 4)<br>OBP: 0.306, SLG: 0.380  |   |   | 0-3<br>K  |   | 4-0<br>SH1-4<br>BB                                   |   | 0-0<br>6-3  |   |   | 2 0 0 0 1 1 0  |   |  |
| Bob Meyer, R (1, 1)<br>OBP: 0.306, SLG: 0.380   |   |   | 4-0<br>BB   |   | 0-0<br>SH1-4   |   | 0-3<br>K2-3   |   |   | 1 0 0 0 1 1 0  |   |  |
| <b>Inning Stats</b>   | R: 0 H: 0<br>E: 0 LOB: 1<br>K: 0 BB: 1<br>S: 3 P: 7   | R: 0 H: 0<br>E: 0 LOB: 0<br>K: 2 BB: 0<br>S: 7 P: 7 | R: 0 H: 0<br>E: 0 LOB: 1<br>K: 1 BB: 1<br>S: 5 P: 9 | R: 0 H: 0<br>E: 0 LOB: 0<br>K: 1 BB: 0<br>S: 5 P: 5 | R: 0 H: 1<br>E: 0 LOB: 2<br>K: 1 BB: 1<br>S: 6 P: 10 | R: 0 H: 0<br>E: 0 LOB: 1<br>K: 0 BB: 1<br>S: 3 P: 7 | R: 0 H: 0<br>E: 0 LOB: 0<br>K: 1 BB: 0<br>S: 5 P: 5 | R: 0 H: 0<br>E: 0 LOB: 0<br>K: 1 BB: 0<br>S: 5 P: 5 | R: 0 H: 0<br>E: 0 LOB: 1<br>K: 0 BB: 1<br>S: 3 P: 7 | 1B: 0 SF: 0<br>2B: 1 SAC: 1<br>3B: 0 DP: 0<br>HR: 0 HBP: 0 | WP: 0 PA: 33<br>PB: 0<br>SB: 1<br>CS: 0 |  |
| <b>PITCHER</b><br>Frank Bertaina, L (1, 1)<br>ERA: 1.69   | IP WLS BF H R ER SO BB IBB HBP BLK WP HR S P ERA WHIP | 9.0 W 33 1 0 0 7 5 0 0 0 0 0 0 42 62 0.00 0.667     |   |   |  |   |   |   |   |  |   |  |

**Kansas City Athletics @ Baltimore Orioles**  
 Memorial Stadium, Baltimore, MD  
 Sat Sep 12 1964, 7:05 PM EDT  
 Att. 13,162 - Unknown

|     |    |
|-----|----|
| AB  | 27 |
| R   | 0  |
| H   | 1  |
| RBI | 0  |
| BB  | 5  |
| SO  | 7  |
| LOB | 11 |

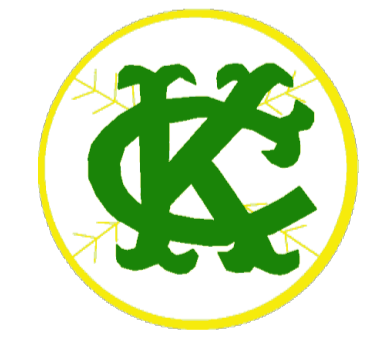



| Batter  | 1          | 2         | 3         | 4                | 5                  | 6                              | 7            | 8                         | 9 | AB | R | H | RBI | BB | SO | LOB |
|---|------------|-----------|-----------|------------------|--------------------|--------------------------------|--------------|---------------------------|---|----|---|---|-----|----|----|-----|
| Jackie Brandt, R<br>OBP: 0.295, SLG: 0.368<br>(1, 8)<br>(9, 7)  | 0-0<br>G3  |           | 0-0<br>F6 |                  | 0-0<br>F9          |                                |              | 0-0<br>SF9                |   | 3  | 0 | 0 | 1   | 0  | 0  | 1   |
| Luis Aparicio, R<br>OBP: 0.312, SLG: 0.360<br>(1, 6)  | 0-0<br>5-3 |           |           | 4-0<br>S<br>BB   |                    | 0-0<br>F4                      |              | 0-0<br>6-3                |   | 3  | 0 | 0 | 0   | 1  | 0  | 1   |
| Boog Powell, L<br>OBP: 0.389, SLG: 0.606<br>Lenny Green, L<br>OBP: 0.314, SLG: 0.275<br>(1, 7)<br>(9, 8)  | 0-3<br>K   |           |           | 0-0<br>F7<br>1-2 |                    | 4-0<br>G4-6-3<br>BB            |              |                           |   | 2  | 0 | 0 | 0   | 1  | 1  | 1   |
| Brooks Robinson, R<br>OBP: 0.355, SLG: 0.498<br>(1, 5)  |            | 0-0<br>F9 |           | 4-0<br>BB        |                    | 0-0<br>G4-6-3<br>1-2f          |              |                           |   | 2  | 0 | 0 | 0   | 1  | 0  | 1   |
| Sam Bowers, R<br>OBP: 0.326, SLG: 0.465<br>(1, 9)   |            | 0-3<br>K  |           | 0-0<br>F3        |                    | 4-0<br>4-3<br>2-1<br>SH3<br>BB |              |                           |   | 2  | 0 | 0 | 0   | 1  | 1  | 2   |
| Bob Johnson, R<br>OBP: 0.289, SLG: 0.366<br>Norm Siebern, L<br>OBP: 0.378, SLG: 0.362<br>(1, 3)<br>(9, 3)   |            | 4-0<br>BB |           | 0-3<br>K         |                    | 0-0<br>SH3                     |              |                           |   | 1  | 0 | 0 | 0   | 1  | 1  | 2   |
| Jerry Adair, R<br>OBP: 0.278, SLG: 0.328<br>(1, 4)  |            | 0-3<br>K  |           |                  | 0-0<br>F9          |                                | 0-0<br>4-3   |                           |   | 3  | 0 | 0 | 0   | 0  | 1  | 2   |
| John Orsino, R<br>OBP: 0.298, SLG: 0.362<br>Bob Saverine, S<br>OBP: 0.237, SLG: 0.176<br>Dick Brown, R<br>OBP: 0.296, SLG: 0.398<br>(1, 2)<br>(8, PR)<br>(9, 2) |            |           | 0-0<br>F8 |                  | 4-0<br>SH2-4<br>BB |                                | 0-0<br>2-1   | 0-0<br>SH5-4<br>SF9<br>2B |   | 2  | 0 | 1 | 0   | 1  | 0  | 0   |
| Frank Bertaina, L<br>(1, 1)   |            |           | 0-0<br>L5 |                  | 0-0<br>SH2-4       |                                | 0-0<br>SH5-4 |                           |   | 1  | 0 | 0 | 0   | 0  | 0  | 0   |

| Inning Stats                                   | R: 0 | H: 0 | E: 0 | LOB: 0 | K: 1 | BB: 0 | S: 5 | P: 5 | R: 0 | H: 0 | E: 0 | LOB: 1 | K: 2 | BB: 1 | S: 7 | P: 11 | R: 0 | H: 0 | E: 0 | LOB: 0 | K: 0 | BB: 0 | S: 3 | P: 3 | R: 0 | H: 0 | E: 0 | LOB: 2 | K: 1 | BB: 2 | S: 5 | P: 13 | R: 0 | H: 0 | E: 0 | LOB: 1 | K: 0 | BB: 1 | S: 3 | P: 7 | R: 0 | H: 0 | E: 0 | LOB: 0 | K: 0 | BB: 1 | S: 2 | P: 6 | R: 0 | H: 0 | E: 0 | LOB: 1 | K: 0 | BB: 1 | S: 2 | P: 6 | R: 1 | H: 1 | E: 0 | LOB: 1 | K: 0 | BB: 0 | S: 4 | P: 4 | 1B: 0 | SF: 1 | 2B: 1 | SAC: 3 | 3B: 0 | DP: 1 | HR: 0 | HBP: 0 | WP: 0 | PA: 29 |
|--|------|------|------|--------|------|-------|------|------|------|------|------|--------|------|-------|------|-------|------|------|------|--------|------|-------|------|------|------|------|------|--------|------|-------|------|-------|------|------|------|--------|------|-------|------|------|------|------|------|--------|------|-------|------|------|------|------|------|--------|------|-------|------|------|------|------|------|--------|------|-------|------|------|-------|-------|-------|--------|-------|-------|-------|--------|-------|--------|
| PITCHER<br>Bob Meyer, L<br>ERA: 3.96<br>(1, 1) | IP   | WLS  | BF   | H      | R    | ER    | SO   | BB   | IBB  | HBP  | BLK  | WP     | HR   | S     | P    | ERA   | WHIP | IP   | WLS  | BF     | H    | R     | ER   | SO   | BB   | IBB  | HBP  | BLK    | WP   | HR    | S    | P     | ERA  | WHIP |      |        |      |       |      |      |      |      |      |        |      |       |      |      |      |      |      |        |      |       |      |      |      |      |      |        |      |       |      |      |       |       |       |        |       |       |       |        |       |        |

BOTTOM

Kansas City Athletics @ Baltimore Orioles  
Memorial Stadium, Baltimore, MD  
Sat Sep 12 1964, 7:05 PM EDT  
Att. 13,162 - Unknown

livebaseballscorecards.com

|     |    |
|-----|----|
| AB  | 19 |
| R   | 1  |
| H   | 1  |
| RBI | 1  |
| BB  | 6  |
| SO  | 4  |
| LOB | 10 |



| Batter   | 1   | 2                                    | 3                            | 4                                | 5                            | 6                               | 7                            | 8                               | 9                            | AB R H RBI BB SO LOB                            | TOP   |                                 |                              |                                 |                              |                                  |                              |                                  |                                  |                                    |                                  |        |  |  |  |  |  |  |  |  |  |  |  |  |  |  |
|--|---|--------------------------------------|------------------------------|----------------------------------|------------------------------|---------------------------------|------------------------------|---------------------------------|------------------------------|---|---|---------------------------------|------------------------------|---------------------------------|------------------------------|----------------------------------|------------------------------|----------------------------------|----------------------------------|------------------------------------|----------------------------------|--------|--|--|--|--|--|--|--|--|--|--|--|--|--|--|
| Bert Campaneris, R (1, 5)<br>OBP: 0.330, SLG: 0.413<br>John Wyatt, R (7, 1)  | 0-0<br>6-3  | 0-0<br>BB<br>1-2<br>2B<br>1B         | 0-0<br>5-3                   |                                  | 0-0<br>5-3                   |                                 | 0-0<br>1-3                   |                                 | 0-0<br>SH2-4<br>2-3          | 5 1 1 0 0 0 5<br>0 0 0 0 0 0 0                  |   |                                 |                              |                                 |                              |                                  |                              |                                  |                                  |                                    |                                  |        |  |  |  |  |  |  |  |  |  |  |  |  |  |  |
| Wayne Causey, L (1, 6)<br>OBP: 0.399, SLG: 0.411   | 0-0<br>WP<br>1B<br>1B                                 | 4-0<br>2B<br>1-2<br>2-3<br>1B<br>BB  |                              | 0-0<br>F9<br>2B                  |                              | 0-0<br>1B<br>4-3<br>1B          |                              | 0-0<br>4-3                      | 0-3<br>K                     | 5 3 3 0 1 1 1                                   |   |                                 |                              |                                 |                              |                                  |                              |                                  |                                  |                                    |                                  |        |  |  |  |  |  |  |  |  |  |  |  |  |  |  |
| Rocky Colavito, R (1, 9)<br>OBP: 0.371, SLG: 0.534<br>George Alusik, R (6, 9)<br>OBP: 0.343, SLG: 0.345  | 4-0<br>1B<br>1-2<br>BB                                | 0-0<br>1B<br>1-3<br>2-H<br>3-H<br>2B |                              | 0-0<br>L3                        |                              | 0-0<br>1B<br>1-3<br>1B          |                              | 0-3<br>K                        | 4-0<br>BB                    | 3 0 2 2 1 0 1<br>1 0 0 0 1 1 0                  |   |                                 |                              |                                 |                              |                                  |                              |                                  |                                  |                                    |                                  |        |  |  |  |  |  |  |  |  |  |  |  |  |  |  |
| Jim Gentile, L (1, 3)<br>OBP: 0.382, SLG: 0.496  | 0-3<br>K  | 0-0<br>F4                            |                              | 0-0<br>F9<br>2-3                 |                              | 0-0<br>4-3                      |                              | 4-0<br>E<br>BB                  | 0-0<br>F4                    | 5 0 0 1 1 1 7                                   |   |                                 |                              |                                 |                              |                                  |                              |                                  |                                  |                                    |                                  |        |  |  |  |  |  |  |  |  |  |  |  |  |  |  |
| Nelson Mathews, R (1, 8)<br>OBP: 0.301, SLG: 0.389   | 0-0<br>BB<br>1-3<br>2-H<br>1B                         | 0-0<br>2-3<br>3-H<br>1B              |                              | 0-0<br>L7                        |                              | 0-0<br>6-3                      |                              | 0-0<br>E5<br>1-2                |                              | 5 0 2 2 0 0 2                                   |   |                                 |                              |                                 |                              |                                  |                              |                                  |                                  |                                    |                                  |        |  |  |  |  |  |  |  |  |  |  |  |  |  |  |
| Tommy Reynolds, R (1, 7)<br>OBP: 0.299, SLG: 0.273<br>Jose Tartabull, L (9, 9)<br>OBP: 0.250, SLG: 0.239   | 4-0<br>1B<br>1-2<br>BB                                | 0-3<br>K                             |                              |                                  |                              | 0-0<br>F8                       |                              | 0-0<br>F3                       | 0-0<br>4-3                   | 4 0 0 0 1 1 4<br>0 0 0 0 0 0 0                  |   |                                 |                              |                                 |                              |                                  |                              |                                  |                                  |                                    |                                  |        |  |  |  |  |  |  |  |  |  |  |  |  |  |  |
| Dick Green, R (1, 4)<br>OBP: 0.313, SLG: 0.391   | 0-0<br>F9   |                                      |                              | 0-0<br>5-3                       |                              | 0-0<br>1B<br>1B                 |                              | 0-0<br>2B                       | 0-0<br>3B<br>3B              | 5 1 3 0 0 0 3                                   | AB 42<br>R 7<br>H 15<br>RBI 7<br>BB 6<br>SO 5<br>LOB 26                               |                                 |                              |                                 |                              |                                  |                              |                                  |                                  |                                    |                                  |        |  |  |  |  |  |  |  |  |  |  |  |  |  |  |
| Billy Bryan, L (1, 2)<br>OBP: 0.287, SLG: 0.476  |   | 0-0<br>4-3                           |                              | 0-0<br>E9<br>4-3                 |                              | 0-3<br>K                        |                              | 0-0<br>F8                       | 0-0<br>2B<br>3B              | 5 1 1 1 0 1 2                                   |   |                                 |                              |                                 |                              |                                  |                              |                                  |                                  |                                    |                                  |        |  |  |  |  |  |  |  |  |  |  |  |  |  |  |
| Orlando Pena, R (1, 1)<br>OBP: 0.192, SLG: 0.205<br>Moe Drabowsky, R (5, 1)<br>OBP: 0.045, SLG: 0.023<br>Ed Charles, R (7, PH)<br>OBP: 0.321, SLG: 0.374 |   | 0-0<br>BB<br>1B<br>2B<br>1B          |                              | 0-0<br>4-3                       |                              | 0-0<br>1B<br>1-2<br>1B          |                              | 4-0<br>BB                       | 0-0<br>SH2-4<br>3-H<br>2B    | 3 1 2 0 0 0 1<br>0 0 0 0 0 0 0<br>1 0 1 1 1 0 0 |  |                                 |                              |                                 |                              |                                  |                              |                                  |                                  |                                    |                                  |        |  |  |  |  |  |  |  |  |  |  |  |  |  |  |
| Inning Stats   | R: 1<br>E: 0<br>K: 1<br>S: 7                          | H: 2<br>LOB: 3<br>BB: 2<br>P: 15     | R: 3<br>E: 0<br>K: 1<br>S: 9 | H: 4<br>LOB: 2<br>BB: 1<br>P: 13 | R: 0<br>E: 1<br>K: 0<br>S: 4 | H: 0<br>LOB: 1<br>BB: 0<br>P: 4 | R: 0<br>E: 0<br>K: 0<br>S: 4 | H: 1<br>LOB: 1<br>BB: 0<br>P: 4 | R: 0<br>E: 0<br>K: 1<br>S: 7 | H: 2<br>LOB: 2<br>BB: 0<br>P: 7                 | R: 1<br>E: 0<br>K: 0<br>S: 4  | H: 2<br>LOB: 0<br>BB: 0<br>P: 4 | R: 0<br>E: 0<br>K: 0<br>S: 4 | H: 1<br>LOB: 2<br>BB: 1<br>P: 8 | R: 0<br>E: 1<br>K: 1<br>S: 6 | H: 0<br>LOB: 2<br>BB: 1<br>P: 10 | R: 2<br>E: 0<br>K: 1<br>S: 8 | H: 3<br>LOB: 2<br>BB: 1<br>P: 12 | 1B: 9<br>2B: 4<br>3B: 2<br>HR: 0 | SF: 0<br>SAC: 1<br>DP: 0<br>HBP: 0 | WP: 1<br>PB: 0<br>SB: 0<br>CS: 0 | PA: 49 |  |  |  |  |  |  |  |  |  |  |  |  |  |  |
| PITCHER  | IP WLS BF H R ER SO BB IBB HBP BLK WP HR S P ERA WHIP |                                      |                              |                                  |                              |                                 |                              |                                 |                              |   |   |                                 |                              |                                 |                              |                                  |                              |                                  |                                  |                                    |                                  |        |  |  |  |  |  |  |  |  |  |  |  |  |  |  |
| Dave Gray, R (1, 1)<br>ERA: 9.0  | 1.1   |                                      | 12                           | 5                                | 4                            | 4                               | 1                            | 3                               | 0                            | 0   | 0   | 1                               | 0                            | 11                              | 23                           | 27.00                            | 6.000                        |                                  |                                  |                                    |                                  |        |  |  |  |  |  |  |  |  |  |  |  |  |  |  |
| Jay Ritchie, R (2, 1)<br>ERA: 2.65   | 3.2   |                                      | 16                           | 4                                | 0                            | 0                               | 2                            | 0                               | 0                            | 0   | 0   | 0                               | 0                            | 20                              | 20                           | 0.00                             | 1.091                        |                                  |                                  |                                    |                                  |        |  |  |  |  |  |  |  |  |  |  |  |  |  |  |
| Jack Lamabe, R (6, 1)<br>ERA: 5.69   | 3.0   | L                                    | 16                           | 5                                | 3                            | 3                               | 1                            | 2                               | 0                            | 0   | 0   | 0                               | 0                            | 16                              | 24                           | 9.00                             | 2.333                        |                                  |                                  |                                    |                                  |        |  |  |  |  |  |  |  |  |  |  |  |  |  |  |
| Bob Heffner, R (9, 1)<br>ERA: 4.1  | 1.0   |                                      | 5                            | 1                                | 0                            | 0                               | 1                            | 1                               | 0                            | 0   | 0   | 0                               | 0                            | 6                               | 10                           | 0.00                             | 2.000                        |                                  |                                  |                                    |                                  |        |  |  |  |  |  |  |  |  |  |  |  |  |  |  |

**Kansas City Athletics @ Boston Red Sox**  
**Fenway Park, Boston, MA**  
 Mon Sep 14 1964, 7:05 PM EDT  
 Att. 2,056 - Unknown

[livebaseballscorecards.com](http://livebaseballscorecards.com)

| Batter  | 1          | 2                             | 3                                 | 4                | 5                      | 6         | 7 | 8                    | 9             | AB | R | H | RBI | BB | SO | LOB |
|---|------------|-------------------------------|-----------------------------------|------------------|------------------------|-----------|---|----------------------|---------------|----|---|---|-----|----|----|-----|
| Felix Mantilla, R (1, 4)<br>OBP: 0.346, SLG: 0.529<br>Jack Lamabe, R (6, 1)<br>OBP: 0.164, SLG: 0.154<br>Bob Heffner, R (9, 1)<br>OBP: 0.179, SLG: 0.237<br>Russ Nixon, L (9, PH)<br>OBP: 0.293, SLG: 0.291 | 0-0<br>6-3 |                               | 0-0<br>F4                         |                  | 0-0<br>6-3             | 0-3<br>K  |   | 0-0<br>2-3           | 3 0 0 1 0 0 0 |    |   |   |     |    |    |     |
| Tony Conigliaro, R (1, 7)<br>OBP: 0.345, SLG: 0.530   | 0-0<br>6-3 |                               | 0-0<br>BB<br>1B                   |                  | 0-0<br>E<br>2B         | 0-0<br>F4 |   | 4-0<br>FC6-4<br>BB   | 4 2 2 0 1 0 1 |    |   |   |     |    |    |     |
| Carl Yastrzemski, L (1, 8)<br>OBP: 0.380, SLG: 0.463  | 0-3<br>K   |                               | 4-0<br>1B<br>1-2<br>9-1-2-5<br>BB |                  | 4-0<br>E<br>BB         | 0-3<br>K  |   | 0-0<br>FC6-4<br>1-2f | 3 1 0 0 2 2 1 |    |   |   |     |    |    |     |
| Dick Stuart, R (1, 3)<br>OBP: 0.320, SLG: 0.502<br>Dick Williams, R (8, 3)<br>OBP: 0.247, SLG: 0.406  |            | 0-3<br>K                      | 0-0<br>1-3<br>2-H<br>1B           |                  | 0-0<br>E6<br>4-3<br>1B | 0-0<br>F5 |   | 0-0<br>F5            | 4 1 2 2 0 1 0 |    |   |   |     |    |    |     |
| Lee Thomas, L (1, 9)<br>OBP: 0.319, SLG: 0.395  |            | 0-0<br>F6                     | 0-0<br>9-1-2-5                    |                  | 0-0<br>4-3             | 0-0<br>F7 |   | 0-0<br>F7            | 0 0 0 0 0 0 0 |    |   |   |     |    |    |     |
| Frank Malzone, R (1, 5)<br>OBP: 0.312, SLG: 0.361   |            | 0-0<br>1B<br>1B               |                                   | 0-0<br>F7        | 4-0<br>BB              |           |   | 0-0<br>5-3           | 4 0 0 1 0 0 2 |    |   |   |     |    |    |     |
| Eddie Bressoud, R (1, 6)<br>OBP: 0.369, SLG: 0.463  |            | 0-0<br>FC5<br>1B<br>1-2<br>1B |                                   | 0-3<br>K         | 0-3<br>K               |           |   | 0-0<br>F2            | 3 1 1 0 1 0 0 |    |   |   |     |    |    |     |
| Bob Tillman, R (1, 2)<br>OBP: 0.352, SLG: 0.434   |            | 0-0<br>1-2<br>2-H<br>1B       |                                   | 0-3<br>K         |                        | 0-0<br>1B |   | 0-0<br>F2            | 4 0 1 0 0 2 1 |    |   |   |     |    |    |     |
| Dave Gray, R (1, 1)<br>OBP: 1.000, SLG: 1.000<br>Jay Ritchie, R (2, 1)<br>OBP: 0.167, SLG: 0.167<br>Dalton Jones, L (5, PH)<br>OBP: 0.282, SLG: 0.353   |            | 0-0<br>FC5<br>2-3f            |                                   | 0-0<br>6-3<br>3B |                        | 0-0<br>L6 |   | 0-0<br>4-3           | 4 0 2 1 0 1 0 |    |   |   |     |    |    |     |

| Inning Stats | R: 0 | H: 0 | E: 0 | K: 1 | S: 5 | H: 0 | LOB: 0 | BB: 0 | P: 5 | R: 1 | H: 3 | E: 0 | K: 1 | S: 8 | H: 2 | LOB: 1 | BB: 0 | P: 8 | R: 0 | H: 0 | E: 0 | K: 2 | S: 7 | H: 0 | LOB: 0 | BB: 0 | P: 7 | R: 4 | H: 3 | E: 1 | K: 1 | S: 8 | H: 1 | LOB: 1 | BB: 0 | P: 6 | R: 0 | H: 0 | E: 0 | K: 1 | S: 5 | H: 0 | LOB: 0 | BB: 0 | P: 5 | R: 0 | H: 0 | E: 0 | K: 0 | S: 3 | H: 0 | LOB: 0 | BB: 0 | P: 3 | R: 0 | H: 0 | E: 0 | K: 0 | S: 3 | H: 0 | LOB: 1 | BB: 1 | P: 7 | 1B: 7 | 2B: 2 | 3B: 1 | HR: 0 | SF: 0 | SAC: 0 | DP: 1 | HBP: 0 | WP: 0 | PB: 0 | SB: 0 | CS: 0 | PA: 39 |
|--------------|------|------|------|------|------|------|--------|-------|------|------|------|------|------|------|------|--------|-------|------|------|------|------|------|------|------|--------|-------|------|------|------|------|------|------|------|--------|-------|------|------|------|------|------|------|------|--------|-------|------|------|------|------|------|------|------|--------|-------|------|------|------|------|------|------|------|--------|-------|------|-------|-------|-------|-------|-------|--------|-------|--------|-------|-------|-------|-------|--------|
|--------------|------|------|------|------|------|------|--------|-------|------|------|------|------|------|------|------|--------|-------|------|------|------|------|------|------|------|--------|-------|------|------|------|------|------|------|------|--------|-------|------|------|------|------|------|------|------|--------|-------|------|------|------|------|------|------|------|--------|-------|------|------|------|------|------|------|------|--------|-------|------|-------|-------|-------|-------|-------|--------|-------|--------|-------|-------|-------|-------|--------|

| PITCHER                              | IP  | WLS | BF | H | R | ER | SO | BB | IBB | HBP | BLK | WP | HR | S  | P  | ERA  | WHIP  |
|--------------------------------------|-----|-----|----|---|---|----|----|----|-----|-----|-----|----|----|----|----|------|-------|
| Orlando Pena, R (1, 1)<br>ERA: 4.42  | 4.1 |     | 22 | 8 | 6 | 4  | 4  | 2  | 0   | 0   | 0   | 0  | 0  | 28 | 36 | 8.31 | 2.308 |
| Moe Drabowsky, R (5, 1)<br>ERA: 5.02 | 1.2 |     | 7  | 1 | 0 | 0  | 2  | 1  | 0   | 0   | 0   | 0  | 0  | 10 | 14 | 0.00 | 1.200 |
| John Wyatt, R (7, 1)<br>ERA: 3.63    | 3.0 | W   | 10 | 0 | 0 | 0  | 1  | 1  | 0   | 0   | 0   | 0  | 0  | 11 | 15 | 0.00 | 0.333 |

BOTTOM

Kansas City Athletics @ Boston Red Sox  
Fenway Park, Boston, MA  
Mon Sep 14 1964, 7:05 PM EDT  
Att. 2,056 - Unknown

livebaseballscorecards.com

|     |    |
|-----|----|
| AB  | 35 |
| R   | 6  |
| H   | 9  |
| RBI | 5  |
| BB  | 4  |
| SO  | 7  |
| LOB | 9  |



| Batter   | 1   | 2   | 3   | 4   | 5   | 6   | 7   | 8   | 9   | AB R H RBI BB SO LOB   | TOP  |
|--|---|---|---|---|---|---|---|---|---|--|--|
| <b>Bert Campaneris, R</b><br>OBP: 0.329, SLG: 0.415<br>(1, 7)<br>(8, 6)  | 0-0<br>F7   |   | 0-3<br>K  |   |   | 0-0<br>2B   |   | 0-0<br>L8   |   | 4 0 1 0 0 1 0  |  |
| <b>Wayne Causey, L</b><br>OBP: 0.397, SLG: 0.408<br><b>Tommie Reynolds, R</b><br>OBP: 0.299, SLG: 0.284<br>(8, PH)<br>(8, 7)   | 0-0<br>F7   |   | 0-3<br>K  |   |   | 0-0<br>F8   |   | 0-0<br>1B   |   | 3 0 0 0 0 1 1<br>1 0 1 0 0 0 0   |  |
| <b>Rocky Colavito, R</b><br>OBP: 0.370, SLG: 0.531<br>(1, 9)<br>BB<br>BB<br>BB   | 4-0<br>WP<br>BB   |   |   |   | 0-0<br>F6   |   | 0-0<br>5-3  |   | 0-3<br>K  | 3 0 0 0 1 1 2  |  |
| <b>Jim Gentile, L</b><br>OBP: 0.382, SLG: 0.494<br><b>Larry Stahl, L</b><br>(9, PH)<br>(1, 3)<br>(9, PH)   | 0-3<br>K<br>1-2   |   | 0-3<br>K  |   | 0-3<br>K  |   | 4-0<br>BB   |   | 0-0<br>L9   | 2 0 0 0 1 2 1<br>1 0 0 0 0 0 0   |  |
| <b>Nelson Mathews, R</b><br>OBP: 0.301, SLG: 0.387<br>(1, 8)   |   |   | 0-3<br>K  |   | 4-0<br>BB   |   | 0-0<br>F6   |   | 0-3<br>K  | 3 0 0 0 1 2 2  |  |
| <b>Ed Charles, R</b><br>OBP: 0.322, SLG: 0.373<br>(1, 5)   |   |   | 4-0<br>BB   |   | 0-0<br>F8   |   | 4-0<br>BB<br>G5-4-3   |   | 0-0<br>5-3  | 2 0 0 0 2 0 1  |  |
| <b>Dick Green, R</b><br>OBP: 0.311, SLG: 0.388<br>(1, 4)   |   |   | 0-3<br>K  |   | 0-3<br>K  |   | 0-0<br>G5-4-3<br>1-2f   |   |   | 3 0 0 0 0 2 2  |  |
| <b>Dave Duncan, R</b><br>OBP: 0.063, SLG: 0.063<br>(1, 2)  |   |   | 0-0<br>6-3  |   | 0-3<br>K  |   | 0-3<br>K  |   |   | 3 0 0 0 0 2 1  |  |
| <b>John O'Donoghue, R</b><br>OBP: 0.256, SLG: 0.308<br><b>George Alusik, R</b><br>OBP: 0.342, SLG: 0.343<br><b>Lew Krausse, R</b><br>(5, PH)<br>(5, 1)<br><b>Jose Santiago, R</b><br>(6, 1)<br><b>Ken Harrelson, R</b><br>OBP: 0.256, SLG: 0.411<br><b>Ken Sanders, R</b><br>(8, PH)<br>(8, 1) |   |   | 0-0<br>1-3  |   | 0-3<br>K  |   |   |   | 0-0<br>F5   | 1 0 0 0 0 0 0<br>1 0 0 0 0 1 0<br>0 0 0 0 0 0 0<br>0 0 0 0 0 0 0<br>1 0 0 0 0 0 0<br>0 0 0 0 0 0 0 |  |
| <b>Inning Stats</b>  | R: 0<br>E: 0<br>K: 1<br>S: 5<br>H: 0<br>LOB: 1<br>BB: 1<br>P: 9   | R: 0<br>E: 0<br>K: 2<br>S: 7<br>H: 0<br>LOB: 1<br>BB: 1<br>P: 11        | R: 0<br>E: 0<br>K: 2<br>S: 7<br>H: 0<br>LOB: 0<br>BB: 0<br>P: 7 | R: 0<br>E: 0<br>K: 1<br>S: 5<br>H: 0<br>LOB: 1<br>BB: 1<br>P: 9 | R: 0<br>E: 0<br>K: 3<br>S: 9<br>H: 0<br>LOB: 0<br>BB: 0<br>P: 9 | R: 0<br>E: 0<br>K: 0<br>S: 4<br>H: 1<br>LOB: 2<br>BB: 1<br>P: 8 | R: 0<br>E: 0<br>K: 1<br>S: 4<br>H: 0<br>LOB: 0<br>BB: 1<br>P: 8 | R: 0<br>E: 0<br>K: 1<br>S: 6<br>H: 1<br>LOB: 1<br>BB: 0<br>P: 6 | R: 0<br>E: 0<br>K: 1<br>S: 5<br>H: 0<br>LOB: 0<br>BB: 0<br>P: 5 | 1B: 1<br>2B: 1<br>3B: 0<br>HR: 0<br>SF: 0<br>SAC: 0<br>DP: 1<br>HBP: 0                             | WP: 1<br>PB: 0<br>SB: 0<br>CS: 0<br>PA: 33 |
| <b>PITCHER</b><br><b>Ed Connolly, L</b><br>ERA: 4.3<br>(1, 1)  | IP: 9.0<br>WLS: W<br>BF: 33<br>H: 2<br>R: 0<br>ER: 0<br>SO: 12<br>BB: 5<br>IBB: 0<br>HBP: 0<br>BLK: 0<br>WP: 1<br>HR: 0<br>S: 52<br>P: 72<br>ERA: 0.00<br>WHIP: 0.778 | <b>PITCHER</b><br>IP WLS BF H R ER SO BB IBB HBP BLK WP HR S P ERA WHIP |   |   |   |   |   |   |   |  |  |

**Kansas City Athletics @ Boston Red Sox**  
Fenway Park, Boston, MA  
Tue Sep 15 1964, 7:05 PM EDT  
Att. 2,776 - Unknown

|     |    |
|-----|----|
| AB  | 28 |
| R   | 0  |
| H   | 2  |
| RBI | 0  |
| BB  | 5  |
| SO  | 12 |
| LOB | 10 |



|       |        |
|-------|--------|
| WP: 1 | PA: 33 |
| PB: 0 |        |
| SB: 0 |        |
| CS: 0 |        |

livebaseballscorecards.com

| Batter  | 1          | 2          | 3               | 4            | 5             | 6                | 7             | 8         | 9 |
|---|------------|------------|-----------------|--------------|---------------|------------------|---------------|-----------|---|
| <b>Felix Mantilla, R</b><br>OBP: 0.347, SLG: 0.536 (1, 4) X       | 0-0<br>5-3 |            | 0-0<br>F8       | 0-0<br>HR    |               | 0-0<br>G4-6-3 1B |               | 0-0<br>F3 |   |
| <b>Tony Conigliaro, R</b><br>OBP: 0.348, SLG: 0.534 (1, 7) X      | 0-0<br>2B  |            | 0-0<br>E6 1B    | 0-0<br>5-3   |               | 0-0<br>G4-6-3 1B |               | 0-3<br>K  |   |
| <b>Carl Yastrzemski, L</b><br>OBP: 0.382, SLG: 0.464 (1, 8) S S S | 0-3<br>K   |            | 4-0<br>FC6-4 BB |              | 0-0<br>2B     | 0-0<br>G4-6-3    |               | 4-0<br>BB |   |
| <b>Dick Stuart, R</b><br>OBP: 0.318, SLG: 0.497 (1, 3) X          |            | 0-0<br>6-3 | 0-0<br>FC6-4    |              | 0-0<br>6-3    | 0-0<br>6-3       |               | 0-3<br>K  |   |
| <b>Frank Malzone, R</b><br>OBP: 0.313, SLG: 0.366 (1, 5) X        |            | 0-0<br>F2  |                 | 0-0<br>F8    | 0-0<br>1B 2B  |                  | 0-0<br>PB 2B  |           |   |
| <b>Lee Thomas, L</b><br>OBP: 0.322, SLG: 0.400 (1, 9) X           |            | 0-0<br>1B  |                 | 0-0<br>F6    | 0-0<br>BB 1B  |                  | 0-0<br>4-3 2B |           |   |
| <b>Eddie Bressoud, R</b><br>OBP: 0.368, SLG: 0.464 (1, 6) S S S   | 0-3<br>K   |            | 0-0<br>2B       | 0-0<br>2B    | 0-0<br>F3     |                  | 0-0<br>4-3    |           |   |
| <b>Bob Tillman, R</b><br>OBP: 0.355, SLG: 0.437 (1, 2) S S S      |            |            | 4-0<br>SH3-4 BB | 0-0<br>1B 2B | 4-0<br>1-2 BB |                  | 0-3<br>K      |           |   |
| <b>Ed Connolly, L</b><br>OBP: 0.188, SLG: 0.133 (1, 1) X          |            |            | 0-0<br>SH3-4    | 0-0<br>HR 1B | 0-0<br>F2     |                  | 0-3<br>K      |           |   |

| Inning Stats | R: 0<br>E: 0<br>K: 1<br>S: 5 | H: 1<br>LOB: 0<br>BB: 0<br>P: 5 | R: 0<br>E: 0<br>K: 1<br>S: 6 | H: 1<br>LOB: 1<br>BB: 0<br>P: 6 | R: 1<br>E: 1<br>K: 0<br>S: 4 | H: 1<br>LOB: 2<br>BB: 2<br>P: 12 | R: 4<br>E: 0<br>K: 0<br>S: 7 | H: 4<br>LOB: 0<br>BB: 0<br>P: 7 | R: 2<br>E: 0<br>K: 0<br>S: 6 | H: 3<br>LOB: 2<br>BB: 1<br>P: 10 | R: 0<br>E: 0<br>K: 0<br>S: 4 | H: 2<br>LOB: 1<br>BB: 0<br>P: 4 | R: 1<br>E: 0<br>K: 2<br>S: 9 | H: 2<br>LOB: 1<br>BB: 0<br>P: 9 | R: 0<br>E: 0<br>K: 2<br>S: 7 | H: 0<br>LOB: 1<br>BB: 1<br>P: 11 |
|--------------|------------------------------|---------------------------------|------------------------------|---------------------------------|------------------------------|----------------------------------|------------------------------|---------------------------------|------------------------------|----------------------------------|------------------------------|---------------------------------|------------------------------|---------------------------------|------------------------------|----------------------------------|
|--------------|------------------------------|---------------------------------|------------------------------|---------------------------------|------------------------------|----------------------------------|------------------------------|---------------------------------|------------------------------|----------------------------------|------------------------------|---------------------------------|------------------------------|---------------------------------|------------------------------|----------------------------------|

| PITCHER                                       | IP  | WLS | BF | H | R | ER | SO | BB | IBB | HBP | BLK | WP | HR | S  | P  | ERA   | WHIP  |
|---|-----|-----|----|---|---|----|----|----|-----|-----|-----|----|----|----|----|-------|-------|
| <b>John O'Donoghue, L</b><br>ERA: 4.73 (1, 1) | 4.0 | L   | 20 | 7 | 5 | 4  | 2  | 2  | 0   | 0   | 0   | 0  | 1  | 22 | 30 | 9.00  | 2.250 |
| <b>Lew Krausse, R</b><br>ERA: 33.75 (5, 1)    | 1.0 |     | 9  | 5 | 2 | 2  | 0  | 1  | 0   | 0   | 0   | 0  | 0  | 8  | 12 | 18.00 | 6.000 |
| <b>Jose Santiago, R</b><br>ERA: 5.0 (6, 1)    | 2.0 |     | 7  | 2 | 1 | 1  | 2  | 0  | 0   | 0   | 0   | 0  | 0  | 11 | 11 | 4.50  | 1.000 |
| <b>Ken Sanders, R</b><br>ERA: 3.0 (8, 1)      | 1.0 |     | 4  | 0 | 0 | 0  | 2  | 1  | 0   | 0   | 0   | 0  | 0  | 7  | 11 | 0.00  | 1.000 |

**BOTTOM**

**Kansas City Athletics @ Boston Red Sox**  
Fenway Park, Boston, MA  
Tue Sep 15 1964, 7:05 PM EDT  
Att. 2,776 - Unknown

| AB | R | H | RBI | BB | SO | LOB |
|----|---|---|-----|----|----|-----|
| 5  | 1 | 2 | 2   | 0  | 0  | 1   |
| 5  | 0 | 3 | 0   | 0  | 1  | 0   |
| 3  | 1 | 1 | 0   | 2  | 1  | 2   |
| 5  | 0 | 0 | 0   | 0  | 1  | 5   |
| 4  | 2 | 2 | 1   | 0  | 0  | 0   |
| 4  | 0 | 3 | 2   | 0  | 0  | 0   |
| 4  | 1 | 1 | 0   | 0  | 1  | 3   |
| 2  | 2 | 1 | 1   | 2  | 1  | 1   |
| 3  | 1 | 1 | 1   | 0  | 1  | 3   |

|            |           |
|------------|-----------|
| <b>AB</b>  | <b>35</b> |
| <b>R</b>   | <b>8</b>  |
| <b>H</b>   | <b>14</b> |
| <b>RBI</b> | <b>7</b>  |
| <b>BB</b>  | <b>4</b>  |
| <b>SO</b>  | <b>6</b>  |
| <b>LOB</b> | <b>15</b> |



| WP | PA |
|----|----|
| 0  | 40 |

| 1B | SF | WP | PA |
|----|----|----|----|
| 6  | 0  | 0  | 40 |
| 7  | 0  | 0  | 40 |
| 0  | 1  | 0  | 40 |
| 0  | 1  | 0  | 40 |
| 1  | 0  | 0  | 40 |

| Batter  | 1   | 2                               | 3                            | 4                               | 5                            | 6                               | 7                                  | 8                               | 9                                    | AB R H RBI BB SO LOB                            | TOP                          |                                 |                              |                                 |                              |                                 |                              |                                 |                                  |                                    |   |        |
|---|---|---------------------------------|------------------------------|---------------------------------|------------------------------|---------------------------------|------------------------------------|---------------------------------|--------------------------------------|---|------------------------------|---------------------------------|------------------------------|---------------------------------|------------------------------|---------------------------------|------------------------------|---------------------------------|----------------------------------|------------------------------------|---|--------|
| Bert Campaneris, R<br>OBP: 0.327, SLG: 0.412<br>(1, 7)<br>(6, 5)<br>(8, 6)  | 0-0<br>F5   |                                 | 0-0<br>G4-6-3<br>1B          |                                 | 0-0<br>4-3                   |                                 |                                    | 0-0<br>F8                       |                                      | 4 0 1 0 0 0 0                                   |                              |                                 |                              |                                 |                              |                                 |                              |                                 |                                  |                                    |   |        |
| Wayne Causey, L<br>OBP: 0.395, SLG: 0.406<br>Larry Stahl, L<br>(8, PH)<br>(8, 7)  | 0-3<br>K  |                                 | 0-0<br>G4-6-3<br>1-2f        |                                 |                              | 0-0<br>F4                       |                                    | 0-0<br>G3                       |                                      | 3 0 0 0 0 1 2<br>1 0 0 0 0 0 0                  |                              |                                 |                              |                                 |                              |                                 |                              |                                 |                                  |                                    |   |        |
| Rocky Colavito, R<br>OBP: 0.371, SLG: 0.531<br>(1, 9)   | 0-0<br>1B   |                                 |                              | 0-0<br>F6                       |                              | 0-0<br>L9                       |                                    | 0-0<br>1B                       |                                      | 4 0 2 0 0 0 0                                   |                              |                                 |                              |                                 |                              |                                 |                              |                                 |                                  |                                    |   |        |
| Jim Gentile, L<br>OBP: 0.383, SLG: 0.496<br>(1, 3)  | 0-3<br>K  |                                 |                              | 0-0<br>1B<br>2B                 |                              | 0-0<br>FC6-4<br>1B              |                                    | 0-0<br>F9                       |                                      | 4 1 2 0 0 1 2                                   |                              |                                 |                              |                                 |                              |                                 |                              |                                 |                                  |                                    |   |        |
| Nelson Mathews, R<br>OBP: 0.300, SLG: 0.386<br>(1, 8)   |   | 0-0<br>L8                       |                              | 0-3<br>K                        |                              | 0-0<br>FC6-4<br>1-2f            |                                    |                                 | 0-0<br>FC6-4<br>1B                   | 4 0 1 0 0 1 2                                   |                              |                                 |                              |                                 |                              |                                 |                              |                                 |                                  |                                    |   |        |
| Ed Charles, R<br>OBP: 0.323, SLG: 0.373<br>Tommy Reynolds, R<br>OBP: 0.304, SLG: 0.290<br>(8, 5)  |   | 0-0<br>6-3                      |                              | 0-0<br>FC6-4<br>1B              |                              |                                 | 0-0<br>G3-6-1<br>1B                |                                 | 0-0<br>FC6-4<br>1B<br>1-2f           | 2 0 1 1 0 0 0<br>2 0 1 0 0 0 1                  |                              |                                 |                              |                                 |                              |                                 |                              |                                 |                                  |                                    |   |        |
| Dick Green, R<br>OBP: 0.312, SLG: 0.389<br>(1, 4)   |   | 0-3<br>K                        |                              | 0-0<br>FC6-4<br>1-2f            |                              |                                 | 0-0<br>G3-6-1<br>1B                |                                 | 0-0<br>FC6-4<br>1B<br>1-2            | 4 0 2 0 0 1 1                                   |                              |                                 |                              |                                 |                              |                                 |                              |                                 |                                  |                                    |   |        |
| Billy Bryan, L<br>OBP: 0.288, SLG: 0.471<br>Ted Bowsfield, R<br>OBP: 0.174, SLG: 0.095<br>Ken Harrelson, R<br>OBP: 0.254, SLG: 0.408<br>(9, PH) |   |                                 | 4-0<br>FC1-6<br>BB           |                                 | 0-3<br>K                     |                                 | 0-0<br>G3-6-1<br>1B<br>1-2f<br>2-3 |                                 | 0-0<br>FC6-4<br>FC6-4<br>1-2f<br>2-3 | 2 0 0 0 1 1 2<br>0 0 0 0 0 0 0<br>1 0 0 0 0 0 2 |                              |                                 |                              |                                 |                              |                                 |                              |                                 |                                  |                                    |   |        |
| Blue Moon Odom, R<br>(1, 1)<br>Moe Drabowsky, R<br>OBP: 0.045, SLG: 0.023<br>Dave Duncan, R<br>OBP: 0.056, SLG: 0.056<br>(7, PH)<br>(7, 2)      |   |                                 | 0-0<br>FC1-6<br>1B<br>1-2f   |                                 | 0-3<br>K                     |                                 | 0-0<br>F5                          |                                 | 0-0<br>FC6-4<br>1-2f                 | 2 0 0 0 0 1 1<br>0 0 0 0 0 0 0<br>2 0 0 0 0 0 3 |                              |                                 |                              |                                 |                              |                                 |                              |                                 |                                  |                                    |   |        |
| <b>Inning Stats</b>   | R: 0<br>E: 0<br>K: 2<br>S: 8  | H: 1<br>LOB: 1<br>BB: 0<br>P: 8 | R: 0<br>E: 0<br>K: 1<br>S: 5 | H: 0<br>LOB: 0<br>BB: 0<br>P: 5 | R: 0<br>E: 0<br>K: 0<br>S: 3 | H: 1<br>LOB: 1<br>BB: 1<br>P: 7 | R: 1<br>E: 0<br>K: 1<br>S: 7       | H: 2<br>LOB: 1<br>BB: 0<br>P: 7 | R: 0<br>E: 0<br>K: 2<br>S: 7         | H: 0<br>LOB: 0<br>BB: 0<br>P: 7                 | R: 0<br>E: 0<br>K: 0<br>S: 4 | H: 1<br>LOB: 1<br>BB: 0<br>P: 4 | R: 0<br>E: 0<br>K: 0<br>S: 4 | H: 2<br>LOB: 1<br>BB: 0<br>P: 4 | R: 0<br>E: 0<br>K: 0<br>S: 4 | H: 1<br>LOB: 1<br>BB: 0<br>P: 4 | R: 0<br>E: 0<br>K: 0<br>S: 5 | H: 2<br>LOB: 2<br>BB: 0<br>P: 5 | 1B: 9<br>2B: 1<br>3B: 0<br>HR: 0 | SF: 0<br>SAC: 0<br>DP: 2<br>HBP: 0 | WP: 0<br>PB: 0<br>SB: 0<br>CS: 0  | PA: 36 |
| <b>PITCHER</b><br>Bill Monbouquette, R<br>ERA: 4.39<br>(1, 1)   | IP: 9.0<br>WLS: W<br>BF: 36<br>H: 10<br>R: 1<br>ER: 1<br>SO: 6<br>BB: 1<br>IBB: 0<br>HBP: 0<br>BLK: 0<br>WP: 0<br>HR: 0<br>S: 47<br>P: 51<br>ERA: 1.00<br>WHIP: 1.222 |                                 |                              |                                 |                              |                                 |                                    |                                 |                                      |   |                              |                                 |                              |                                 |                              |                                 |                              |                                 |                                  |                                    | <b>PITCHER</b><br>IP: 9.0<br>WLS: W<br>BF: 36<br>H: 10<br>R: 1<br>ER: 1<br>SO: 6<br>BB: 1<br>IBB: 0<br>HBP: 0<br>BLK: 0<br>WP: 0<br>HR: 0<br>S: 47<br>P: 51<br>ERA: 1.00<br>WHIP: 1.222 |        |

**Kansas City Athletics @ Boston Red Sox**  
**Fenway Park, Boston, MA**  
 Wed Sep 16 1964, 3:33 AM EDT  
 Att. 1,287 - Unknown

|     |    |
|-----|----|
| AB  | 35 |
| R   | 1  |
| H   | 10 |
| RBI | 1  |
| BB  | 1  |
| SO  | 6  |
| LOB | 16 |



| Batter  | 1          | 2          | 3               | 4                  | 5                      | 6                     | 7         | 8         | 9 |
|---|------------|------------|-----------------|--------------------|------------------------|-----------------------|-----------|-----------|---|
| <b>Felix Mantilla, R</b><br>OBP: 0.348, SLG: 0.536 (1, 4)       | 0-0<br>2B  |            | 0-0<br>HR       | 0-0<br>F7          |                        | 0-0<br>F8             |           | 0-0<br>F7 |   |
| <b>Tony Conigliaro, R</b><br>OBP: 0.351, SLG: 0.550 (1, 7)      | 0-0<br>F7  |            | 0-0<br>HR       | 0-0<br>F7          |                        | 4-0<br>1B<br>WP<br>BB |           | 0-0<br>HR |   |
| <b>Carl Yastrzemski, L</b><br>OBP: 0.381, SLG: 0.462 (1, 8)     | 0-0<br>L7  |            | 0-0<br>4-3      |                    | 0-0<br>4-3             | 0-0<br>WP<br>2B<br>1B |           | 0-0<br>1B |   |
| <b>Roman Mejias, R</b><br>OBP: 0.304, SLG: 0.362 (8, PH) (9, 8) |            |            |                 |                    |                        |                       |           |           |   |
| <b>Dick Stuart, R</b><br>OBP: 0.318, SLG: 0.504 (1, 3)          | 0-0<br>2B  |            | 0-0<br>F5       |                    | 0-0<br>HR              | 0-3<br>K              |           | 0-0<br>L8 |   |
| <b>Lee Thomas, L</b><br>OBP: 0.323, SLG: 0.402 (1, 9)           | 0-0<br>4-3 |            | 0-0<br>2B<br>1B |                    | 0-0<br>1-3             | 0-0<br>2B             |           | 0-0<br>F6 |   |
| <b>Frank Malzone, R</b><br>OBP: 0.315, SLG: 0.369 (1, 5)        |            | 0-0<br>6-3 | 0-0<br>2B       |                    | 0-0<br>1B<br>HR<br>1B  | 0-0<br>L9             |           |           |   |
| <b>Al Smith, R</b><br>OBP: 0.259, SLG: 0.315 (7, 5)             |            |            | 1-3<br>2B       |                    |                        |                       |           |           |   |
| <b>Eddie Bressoud, R</b><br>OBP: 0.369, SLG: 0.464 (1, 6)       |            | 0-0<br>1B  | 0-0<br>L8       |                    | 0-0<br>1-2<br>HR<br>1B |                       | 0-0<br>F3 |           |   |
| <b>Bob Tillman, R</b><br>OBP: 0.357, SLG: 0.445 (1, 2)          |            | 0-3<br>K   |                 | 0-0<br>FC5-6<br>1B | 0-0<br>HR              |                       | 0-0<br>F9 |           |   |
| <b>Bill Monbouquette, R</b><br>OBP: 0.169, SLG: 0.109 (1, 1)    |            | 0-3<br>K   |                 | 0-0<br>FC5-6       | 0-3<br>K               |                       | 0-3<br>K  |           |   |

| AB | R | H | RBI | BB | SO | LOB |
|----|---|---|-----|----|----|-----|
| 5  | 2 | 2 | 0   | 0  | 0  | 1   |
| 4  | 3 | 2 | 3   | 1  | 0  | 2   |
| 4  | 1 | 1 | 0   | 0  | 0  | 1   |
| 1  | 0 | 1 | 0   | 0  | 0  | 0   |
| 5  | 1 | 2 | 2   | 0  | 1  | 2   |
| 5  | 0 | 2 | 1   | 0  | 0  | 2   |
| 4  | 1 | 2 | 0   | 0  | 0  | 1   |
| 0  | 0 | 0 | 0   | 0  | 0  | 0   |
| 4  | 1 | 2 | 0   | 0  | 0  | 2   |
| 4  | 1 | 2 | 3   | 0  | 1  | 1   |
| 4  | 0 | 0 | 0   | 0  | 3  | 2   |

**BOTTOM**

**Kansas City Athletics @ Boston Red Sox**  
Fenway Park, Boston, MA

Wed Sep 16 1964, 3:33 AM EDT  
Att. 1,287 - Unknown

|            |           |
|------------|-----------|
| <b>AB</b>  | <b>40</b> |
| <b>R</b>   | <b>10</b> |
| <b>H</b>   | <b>16</b> |
| <b>RBI</b> | <b>9</b>  |
| <b>BB</b>  | <b>1</b>  |
| <b>SO</b>  | <b>5</b>  |
| <b>LOB</b> | <b>14</b> |



| Inning Stats | R | H | E | K | S  | P | 1B | 2B | 3B | HR | SF | DP | CS |
|--------------|---|---|---|---|----|---|----|----|----|----|----|----|----|
|              | 1 | 2 | 0 | 0 | 5  |   | 0  | 0  | 0  | 0  | 0  | 0  | 0  |
|              | 0 | 1 | 0 | 2 | 8  |   | 0  | 0  | 0  | 0  | 0  | 0  | 0  |
|              | 2 | 4 | 0 | 0 | 7  |   | 2  | 0  | 0  | 0  | 0  | 0  | 0  |
|              | 0 | 1 | 0 | 0 | 4  |   | 0  | 0  | 0  | 0  | 0  | 0  | 0  |
|              | 4 | 4 | 0 | 1 | 9  |   | 4  | 0  | 0  | 0  | 0  | 0  | 0  |
|              | 2 | 2 | 0 | 1 | 11 |   | 2  | 1  | 0  | 0  | 0  | 0  | 0  |
|              | 0 | 0 | 0 | 0 | 5  |   | 0  | 0  | 0  | 0  | 0  | 0  | 0  |
|              | 1 | 2 | 0 | 0 | 5  |   | 1  | 0  | 0  | 0  | 0  | 0  | 0  |

| PITCHER                                      | IP  | WLS | BF | H  | R | ER | SO | BB | IBB | HBP | BLK | WP | HR | S  | P  | ERA   | WHIP  |
|--|-----|-----|----|----|---|----|----|----|-----|-----|-----|----|----|----|----|-------|-------|
| <b>Blue Moon Odom, R</b><br>ERA: 6.89 (1, 1) | 4.2 | L   | 25 | 11 | 6 | 6  | 2  | 0  | 0   | 0   | 0   | 0  | 2  | 29 | 29 | 11.57 | 2.357 |
| <b>Moe Drabowsky, R</b><br>ERA: 5.15 (5, 1)  | 1.1 |     | 8  | 3  | 3 | 3  | 2  | 1  | 0   | 0   | 0   | 1  | 1  | 11 | 15 | 20.25 | 3.000 |
| <b>Ted Bowsfield, L</b><br>ERA: 4.6 (7, 1)   | 2.0 |     | 8  | 2  | 1 | 1  | 1  | 0  | 0   | 0   | 0   | 0  | 1  | 10 | 10 | 4.50  | 1.000 |

| WP | PA | ERA | WHIP |
|----|----|-----|------|
| 1  | 41 |     |      |
| 0  |    |     |      |
| 0  |    |     |      |

| Batter  | 1   | 2                               | 3                            | 4                               | 5                            | 6                               | 7                            | 8                               | 9                            | AB R H RBI BB SO LOB   | TOP  |                                 |                              |                                 |                              |                                 |                                  |                                    |                                  |        |
|---|---|---------------------------------|------------------------------|---------------------------------|------------------------------|---------------------------------|------------------------------|---------------------------------|------------------------------|--|--|---------------------------------|------------------------------|---------------------------------|------------------------------|---------------------------------|----------------------------------|------------------------------------|----------------------------------|--------|
| Bert Campaneris, R (1, 7)<br>OBP: 0.326, SLG: 0.409   | 0-0<br>L7   |                                 | 0-0<br>BB<br>1B              |                                 | 0-0<br>L9                    |                                 | 0-0<br>1-3                   |                                 |                              | 4 0 1 0 0 0 0  | <b>Kansas City Athletics @ New York Yankees</b><br>Yankee Stadium, Bronx, NY<br>Fri Sep 18 1964, 7:05 PM EDT<br>Att. 16,094 - Unknown - 76 F |                                 |                              |                                 |                              |                                 |                                  |                                    |                                  |        |
| Wayne Causey, L (1, 6)<br>OBP: 0.393, SLG: 0.403  | 0-0<br>4-3  |                                 | 0-0<br>F8                    |                                 | 0-0<br>6-3                   |                                 |                              | 0-0<br>F7                       |                              | 4 0 0 0 0 0 1  |  |                                 |                              |                                 |                              |                                 |                                  |                                    |                                  |        |
| Rocky Colavito, R (1, 9)<br>OBP: 0.374, SLG: 0.532  | 0-0<br>FC4-6<br>1B  |                                 | 4-0<br>1-2<br>BB             |                                 | 0-0<br>L8                    |                                 |                              | 0-0<br>G4-6-3<br>1B             |                              | 3 0 2 0 1 0 0  |  |                                 |                              |                                 |                              |                                 |                                  |                                    |                                  |        |
| Jim Gentile, L (1, 3)<br>OBP: 0.380, SLG: 0.491   | 0-0<br>FC4-6<br>1-2f  |                                 | 0-0<br>F2                    |                                 | 0-3<br>K                     |                                 |                              | 0-0<br>G4-6-3<br>1-2f           |                              | 4 0 0 0 0 1 4  |  |                                 |                              |                                 |                              |                                 |                                  |                                    |                                  |        |
| Nelson Mathews, R (1, 8)<br>OBP: 0.302, SLG: 0.389  |   | 0-0<br>5-3<br>2B                | 0-0<br>F8                    |                                 | 0-0<br>1B<br>1B              |                                 |                              | 0-3<br>K                        |                              | 4 0 2 0 0 1 2  |  |                                 |                              |                                 |                              |                                 |                                  |                                    |                                  |        |
| Ed Charles, R (1, 5)<br>OBP: 0.322, SLG: 0.373  |   | 0-3<br>K2-3                     |                              | 0-0<br>5-3                      |                              | 0-0<br>FC6<br>1B                |                              | 0-0<br>6-3                      |                              | 4 0 1 0 0 1 1  |  |                                 |                              |                                 |                              |                                 |                                  |                                    |                                  |        |
| Dick Green, R (1, 4)<br>OBP: 0.314, SLG: 0.389  |   | 0-0<br>5-3<br>1B                |                              | 0-0<br>6-3                      |                              | 0-0<br>FC6<br>1-2f              |                              | 4-0<br>FC5-4<br>BB              |                              | 3 0 1 0 1 0 2  |  |                                 |                              |                                 |                              |                                 |                                  |                                    |                                  |        |
| Doc Edwards, R (1, 2)<br>OBP: 0.251, SLG: 0.301   |   | 0-0<br>5-3<br>1-2<br>2-3        |                              | 0-0<br>F9                       |                              | 0-0<br>5-3                      |                              | 0-0<br>FC5-4<br>1-2f            |                              | 4 0 0 0 0 0 3  |  |                                 |                              |                                 |                              |                                 |                                  |                                    |                                  |        |
| Bob Meyer, R (1, 1)<br>Jose Santiago, R (3, 1)<br>Tommy Reynolds, R (5, PH)<br>Moe Drabowsky, R (5, 1)<br>George Alusik, R (7, PH)<br>Ken Sanders, R (7, 1) |   | 0-3<br>K                        |                              | 0-0<br>F8                       |                              | 0-0<br>6-3                      |                              |                                 |                              | 1 0 0 0 0 0 1 2<br>0 0 0 0 0 0 0 0<br>1 0 0 0 0 0 0 0<br>0 0 0 0 0 0 0 0<br>1 0 0 0 0 0 0 0<br>0 0 0 0 0 0 0 0 |  |                                 |                              |                                 |                              |                                 |                                  |                                    |                                  |        |
| <b>Inning Stats</b>   | R: 0<br>E: 0<br>K: 0<br>S: 4  | H: 1<br>LOB: 1<br>BB: 0<br>P: 4 | R: 0<br>E: 0<br>K: 2<br>S: 9 | H: 2<br>LOB: 2<br>BB: 0<br>P: 9 | R: 0<br>E: 0<br>K: 0<br>S: 4 | H: 1<br>LOB: 2<br>BB: 1<br>P: 8 | R: 0<br>E: 0<br>K: 0<br>S: 3 | H: 0<br>LOB: 0<br>BB: 0<br>P: 3 | R: 0<br>E: 0<br>K: 1<br>S: 7 | H: 2<br>LOB: 2<br>BB: 0<br>P: 7  | R: 0<br>E: 0<br>K: 0<br>S: 3   | H: 0<br>LOB: 0<br>BB: 0<br>P: 3 | R: 0<br>E: 0<br>K: 0<br>S: 3 | H: 1<br>LOB: 0<br>BB: 0<br>P: 3 | R: 0<br>E: 0<br>K: 1<br>S: 5 | H: 0<br>LOB: 1<br>BB: 1<br>P: 9 | 1B: 6<br>2B: 1<br>3B: 0<br>HR: 0 | SF: 0<br>SAC: 0<br>DP: 1<br>HBP: 0 | WP: 0<br>PB: 0<br>SB: 0<br>CS: 0 | PA: 35 |
| <b>PITCHER</b><br>Whitey Ford, L (1, 1)<br>ERA: 2.23  | IP 9.0<br>WLS W<br>BF 35<br>H 7<br>R 0<br>ER 0<br>SO 4<br>BB 2<br>IBB 0<br>HBP 0<br>BLK 0<br>WP 0<br>HR 0<br>S 41<br>P 49<br>ERA 0.00<br>WHIP 1.000 |                                 |                              |                                 |                              |                                 |                              |                                 |                              |  |  |                                 |                              |                                 |                              |                                 |                                  |                                    |                                  |        |

livebaseballscorecards.com

|            |    |
|------------|----|
| <b>AB</b>  | 33 |
| <b>R</b>   | 0  |
| <b>H</b>   | 7  |
| <b>RBI</b> | 0  |
| <b>BB</b>  | 2  |
| <b>SO</b>  | 4  |
| <b>LOB</b> | 15 |





| Batter  | 1      | 2            | 3            | 4                | 5             | 6       | 7          | 8       | 9 | AB | R | H | RBI | BB | SO | LOB |
|---|--------|--------------|--------------|------------------|---------------|---------|------------|---------|---|----|---|---|-----|----|----|-----|
| Tony Kubek, L (1, 6)<br>OBP: 0.274, SLG: 0.342                              | 0-3 K  | 0-0 WP 3B    |              | 0-3 K            |               | 0-0 F6  |            | 0-0 5-3 |   | 5  | 1 | 1 | 3   | 0  | 2  | 1   |
| Bobby Richardson, R (1, 4)<br>OBP: 0.287, SLG: 0.328                        | 0-3 K  | 0-0 1B       |              | 0-0 3-1 BB 1B    |               | 0-0 5-3 |            | 4-0 BB  |   | 4  | 0 | 2 | 0   | 1  | 1  | 0   |
| Roger Maris, L (1, 8)<br>OBP: 0.371, SLG: 0.462                             | 4-0 BB | 0-0 4-3      |              | 4-0 3-1 BB       |               |         | 0-0 F8     | 0-0 F8  |   | 3  | 0 | 0 | 0   | 2  | 0  | 2   |
| Mickey Mantle, S (1, 9)<br>OBP: 0.416, SLG: 0.584<br>Roger Repoz, L (7, PR) | 0-0 F2 |              |              | 0-0 3-1          |               |         | 0-0 1B 2B  |         |   | 4  | 0 | 2 | 1   | 0  | 0  | 3   |
| Elston Howard, R (1, 2)<br>OBP: 0.361, SLG: 0.448                           |        | 0-0 G6-3 1B  | 0-0 FC6-4 1B | 0-3 K            |               |         | 0-0 1B 1B  |         |   | 4  | 0 | 2 | 1   | 0  | 1  | 3   |
| Tom Tresh, S (1, 7)<br>OBP: 0.340, SLG: 0.395                               |        | 0-0 G6-3 1B  | 4-0 FC4-6 BB |                  | 0-0 F9        |         | 0-0 1-3    |         |   | 3  | 0 | 0 | 0   | 1  | 0  | 3   |
| Pedro Gonzalez, R (1, 3)<br>OBP: 0.348, SLG: 0.387<br>Mike Hegan, L (8, 3)  |        | 4-0 BB 3B BB | 0-3 K        |                  | 0-0 G6-4-3 1B |         | 0-0 2-3 1B |         |   | 3  | 1 | 2 | 0   | 1  | 1  | 2   |
| Clete Boyer, R (1, 5)<br>OBP: 0.272, SLG: 0.307                             |        | 4-0 BB 3B BB | 0-0 FC4-6    |                  | 0-0 G6-4-3    |         | 0-0 F3     |         |   | 3  | 1 | 0 | 0   | 1  | 0  | 6   |
| Whitey Ford, L (1, 1)<br>OBP: 0.275, SLG: 0.155                             |        | 4-0 BB 3B BB |              | 4-0 BB 1B 3-1 BB |               | 0-0 4-3 |            | 0-0 F7  |   | 2  | 2 | 0 | 0   | 2  | 0  | 0   |

| Inning Stats | R: 0 | H: 0 | E: 0 | K: 2 | S: 7 | LOB: 1 | BB: 11 | P: 11 |
|--------------|------|------|------|------|------|--------|--------|-------|
|              | R: 4 | H: 3 | E: 0 | K: 0 | S: 5 | LOB: 1 | BB: 3  | P: 17 |
|              | R: 0 | H: 1 | E: 0 | K: 1 | S: 6 | LOB: 2 | BB: 1  | P: 10 |
|              | R: 1 | H: 1 | E: 0 | K: 2 | S: 8 | LOB: 2 | BB: 2  | P: 16 |
|              | R: 0 | H: 1 | E: 0 | K: 0 | S: 3 | LOB: 0 | BB: 0  | P: 3  |
|              | R: 1 | H: 3 | E: 0 | K: 0 | S: 6 | LOB: 3 | BB: 0  | P: 6  |
|              | R: 0 | H: 0 | E: 0 | K: 0 | S: 3 | LOB: 0 | BB: 1  | P: 7  |

| PITCHER                              | IP  | WLS | BF | H | R | ER | SO | BB | IBB | HBP | BLK | WP | HR | S  | P  | ERA   | WHIP  |
|--------------------------------------|-----|-----|----|---|---|----|----|----|-----|-----|-----|----|----|----|----|-------|-------|
| Bob Meyer, L (1, 1)<br>ERA: 4.34     | 2.0 | L   | 13 | 4 | 4 | 4  | 2  | 4  | 0   | 0   | 0   | 1  | 0  | 13 | 29 | 18.00 | 4.000 |
| Jose Santiago, R (3, 1)<br>ERA: 4.98 | 2.0 |     | 10 | 1 | 1 | 1  | 3  | 3  | 0   | 0   | 0   | 0  | 0  | 13 | 25 | 4.50  | 2.000 |
| Moe Drabowsky, R (5, 1)<br>ERA: 5.08 | 2.0 |     | 6  | 1 | 0 | 0  | 0  | 0  | 0   | 0   | 0   | 0  | 0  | 6  | 6  | 0.00  | 0.500 |
| Ken Sanders, R (7, 1)<br>ERA: 3.12   | 2.0 |     | 10 | 3 | 1 | 1  | 0  | 1  | 0   | 0   | 0   | 0  | 0  | 9  | 13 | 4.50  | 2.000 |

**BOTTOM**

**Kansas City Athletics @ New York Yankees**  
 Yankee Stadium, Bronx, NY

Fri Sep 18 1964, 7:05 PM EDT  
 Att: 16,094 - Unknown - 76 F

livebaseballscorecards.com

|            |           |
|------------|-----------|
| <b>AB</b>  | <b>31</b> |
| <b>R</b>   | <b>6</b>  |
| <b>H</b>   | <b>9</b>  |
| <b>RBI</b> | <b>5</b>  |
| <b>BB</b>  | <b>8</b>  |
| <b>SO</b>  | <b>5</b>  |
| <b>LOB</b> | <b>20</b> |



|       |        |       |        |
|-------|--------|-------|--------|
| 1B: 7 | SF: 0  | WP: 1 | PA: 39 |
| 2B: 1 | SAC: 0 | PB: 0 |        |
| 3B: 1 | DP: 2  | SB: 0 |        |
| HR: 0 | HBP: 0 | CS: 0 |        |

| Batter  | 1   | 2                                | 3                            | 4                               | 5                            | 6                               | 7                            | 8                                | 9                            | AB R H RBI BB SO LOB             | TOP   |                                 |                              |   |                              |                                 |                              |                                 |                                  |                                    |                                  |        |
|---|---|----------------------------------|------------------------------|---------------------------------|------------------------------|---------------------------------|------------------------------|----------------------------------|------------------------------|----------------------------------|---|---------------------------------|------------------------------|---|------------------------------|---------------------------------|------------------------------|---------------------------------|----------------------------------|------------------------------------|----------------------------------|--------|
| <b>Bert Campaneris, R</b> (1, 7)<br>OBP: 0.332, SLG: 0.413  | 0-0<br>CS<br>1B                                       |                                  | 0-0<br>1B                    |                                 | 0-0<br>E6<br>PB WP<br>1-3    | 0-0<br>F3                       |                              |                                  | 0-0<br>1B<br>1-2             | 5 0 3 0 0 0 3                    | <b>Kansas City Athletics @ New York Yankees</b><br><b>Yankee Stadium, Bronx, NY</b><br>Sat Sep 19 1964, 3:33 AM EDT<br>Att. 9,458 - Overcast - 61 F |                                 |                              |   |                              |                                 |                              |                                 |                                  |                                    |                                  |        |
| <b>Wayne Causey, L</b> (1, 6)<br>OBP: 0.393, SLG: 0.402     | 4-0<br>BB<br>1-2<br>BB                                |                                  | 0-0<br>F3                    |                                 | 0-0<br>F8<br>1-2<br>3-H      |                                 |                              | 0-0<br>G3<br>1B                  | 4 0 1 0 1 0 4                |                                  |   |                                 |                              |   |                              |                                 |                              |                                 |                                  |                                    |                                  |        |
| <b>Rocky Colavito, R</b> (1, 9)<br>OBP: 0.371, SLG: 0.528   | 0-0<br>F2   |                                  | 0-0<br>F3                    |                                 | 0-0<br>L7<br>2-3             |                                 |                              | 0-0<br>F8<br>3-H                 | 4 0 0 1 0 0 4                |                                  |   |                                 |                              |   |                              |                                 |                              |                                 |                                  |                                    |                                  |        |
| <b>Jim Gentile, L</b> (1, 3)<br>OBP: 0.384, SLG: 0.491      | 4-0<br>1-2<br>BB                                      |                                  |                              | 4-0<br>BB<br>1B<br>BB           | 4-0<br>BB                    |                                 |                              | 0-0<br>G3<br>1-2                 | 2 1 1 0 3 0 1                |                                  |   |                                 |                              |   |                              |                                 |                              |                                 |                                  |                                    |                                  |        |
| <b>Nelson Mathews, R</b> (1, 8)<br>OBP: 0.299, SLG: 0.385   | 0-3<br>K  |                                  |                              | 0-3<br>K                        | 0-3<br>K                     |                                 |                              | 0-0<br>FC6-4<br>1B<br>1-2f       | 5 0 0 0 0 4 8                |                                  |   |                                 |                              |   |                              |                                 |                              |                                 |                                  |                                    |                                  |        |
| <b>Ed Charles, R</b> (1, 5)<br>OBP: 0.320, SLG: 0.370       |   | 0-0<br>F6                        |                              | 0-0<br>F5                       |                              | 0-0<br>5-3                      |                              | 0-0<br>5-3                       | 4 0 0 0 0 0 1                |                                  |   |                                 |                              |   |                              |                                 |                              |                                 |                                  |                                    |                                  |        |
| <b>Dick Green, R</b> (1, 4)<br>OBP: 0.313, SLG: 0.386       |   | 0-0<br>F7                        |                              | 4-0<br>1B<br>1-2<br>BB          |                              | 0-0<br>F4                       |                              | 0-0<br>F5                        | 3 0 0 0 1 0 0                |                                  |   |                                 |                              |   |                              |                                 |                              |                                 |                                  |                                    |                                  |        |
| <b>Doc Edwards, R</b> (1, 2)<br>OBP: 0.252, SLG: 0.302      |   | 0-3<br>K                         |                              | 0-0<br>K                        |                              | 0-0<br>E3<br>2B                 |                              | 0-0<br>5-3                       | 2 0 1 1 0 1 0                |                                  |   |                                 |                              |   |                              |                                 |                              |                                 |                                  |                                    |                                  |        |
| <b>Billy Bryan, L</b> (6, PH)<br>OBP: 0.285, SLG: 0.467     |   |                                  |                              | 1-3<br>2-H<br>1B                |                              | 0-0<br>E<br>WP<br>1B            |                              | 0-0<br>F9<br>1B<br>SF7<br>1B     | 2 0 0 0 0 0 0                |                                  |   |                                 |                              |   |                              |                                 |                              |                                 |                                  |                                    |                                  |        |
| <b>Diego Segui, R</b> (1, 1)<br>OBP: 0.211, SLG: 0.224      |   |                                  | 0-3<br>K                     |                                 | 0-0<br>K                     |                                 | 0-0<br>K                     |                                  | 1 0 0 0 0 0 1 0              |                                  |   |                                 |                              |   |                              |                                 |                              |                                 |                                  |                                    |                                  |        |
| <b>Wes Stock, R</b> (3, 1)<br>OBP: 0.211, SLG: 0.167        |   |                                  |                              |                                 |                              |                                 |                              |                                  | 0 0 0 0 0 0 0 0              |                                  |   |                                 |                              |   |                              |                                 |                              |                                 |                                  |                                    |                                  |        |
| <b>Tommie Reynolds, R</b> (5, PH)<br>OBP: 0.350, SLG: 0.290 |   |                                  |                              |                                 |                              |                                 |                              |                                  | 1 1 1 0 0 0 0 0              |                                  |   |                                 |                              |   |                              |                                 |                              |                                 |                                  |                                    |                                  |        |
| <b>Orlando Pena, R</b> (5, 1)<br>OBP: 0.192, SLG: 0.205     |   |                                  |                              |                                 |                              |                                 |                              |                                  | 0 0 0 0 0 0 0 0              |                                  |   |                                 |                              |   |                              |                                 |                              |                                 |                                  |                                    |                                  |        |
| <b>Larry Stahl, L</b> (6, PH)<br>OBP: 0.250, SLG: 0.500     |   |                                  |                              |                                 |                              |                                 |                              |                                  | 1 0 1 0 0 0 0 0              |                                  |   |                                 |                              |   |                              |                                 |                              |                                 |                                  |                                    |                                  |        |
| <b>John Wyatt, R</b> (6, 1)<br>OBP: 0.250, SLG: 0.500       |   |                                  |                              |                                 |                              |                                 |                              |                                  | 0 0 0 0 0 0 0 0              |                                  |   |                                 |                              |   |                              |                                 |                              |                                 |                                  |                                    |                                  |        |
| <b>Manny Jimenez, L</b> (9, PH)<br>OBP: 0.290, SLG: 0.444   |   |                                  |                              |                                 |                              |                                 |                              |                                  | 1 0 1 0 0 0 0 0              |                                  |   |                                 |                              |   |                              |                                 |                              |                                 |                                  |                                    |                                  |        |
| <b>Jose Tartabull, L</b> (9, PR)<br>OBP: 0.250, SLG: 0.239  |   |                                  |                              |                                 |                              |                                 |                              |                                  | 0 1 0 0 0 0 0 0              |                                  |   |                                 |                              |   |                              |                                 |                              |                                 |                                  |                                    |                                  |        |
| <b>Inning Stats</b>   | R: 0<br>E: 0<br>K: 1<br>S: 5                          | H: 1<br>LOB: 2<br>BB: 2<br>P: 13 | R: 0<br>E: 0<br>K: 1<br>S: 5 | H: 0<br>LOB: 0<br>BB: 0<br>P: 5 | R: 0<br>E: 0<br>K: 1<br>S: 6 | H: 1<br>LOB: 1<br>BB: 0<br>P: 6 | R: 1<br>E: 0<br>K: 1<br>S: 5 | H: 1<br>LOB: 2<br>BB: 2<br>P: 13 | R: 1<br>E: 1<br>K: 1<br>S: 7 | H: 1<br>LOB: 2<br>BB: 1<br>P: 11 | R: 0<br>E: 1<br>K: 0<br>S: 5  | H: 1<br>LOB: 2<br>BB: 0<br>P: 5 | R: 0<br>E: 0<br>K: 1<br>S: 6 | H: 1<br>LOB: 1<br>BB: 0<br>P: 6                       | R: 0<br>E: 0<br>K: 0<br>S: 3 | H: 0<br>LOB: 0<br>BB: 0<br>P: 3 | R: 1<br>E: 0<br>K: 0<br>S: 6 | H: 3<br>LOB: 2<br>BB: 0<br>P: 6 | 1B: 8<br>2B: 1<br>3B: 0<br>HR: 0 | SF: 1<br>SAC: 0<br>DP: 0<br>HBP: 0 | WP: 1<br>PB: 1<br>SB: 0<br>CS: 1 | PA: 41 |
| <b>PITCHER</b>  | IP WLS BF H R ER SO BB IBB HBP BLK WP HR S P ERA WHIP |                                  |                              |                                 |                              |                                 |                              |                                  |                              |                                  |   |                                 | <b>PITCHER</b>               | IP WLS BF H R ER SO BB IBB HBP BLK WP HR S P ERA WHIP |                              |                                 |                              |                                 |                                  |                                    |                                  |        |
| <b>Al Downing, L</b> (1, 1)<br>ERA: 3.33                    | 5.0 W 23 4 2 1 5 5 0 0 0 0 1 0 28 48 1.80 1.800       |                                  |                              |                                 |                              |                                 |                              |                                  |                              |                                  |   |                                 |                              |   |                              |                                 |                              |                                 |                                  |                                    |                                  |        |
| <b>Ralph Terry, R</b> (6, 1)<br>ERA: 4.43                   | 4.0 S 18 5 1 1 1 0 0 0 0 0 0 0 20 20 2.25 1.250       |                                  |                              |                                 |                              |                                 |                              |                                  |                              |                                  |   |                                 |                              |   |                              |                                 |                              |                                 |                                  |                                    |                                  |        |

livebaseballscorecards.com

|            |           |
|------------|-----------|
| <b>AB</b>  | <b>35</b> |
| <b>R</b>   | <b>3</b>  |
| <b>H</b>   | <b>9</b>  |
| <b>RBI</b> | <b>2</b>  |
| <b>BB</b>  | <b>5</b>  |
| <b>SO</b>  | <b>6</b>  |
| <b>LOB</b> | <b>21</b> |



| Batter  | 1               | 2                  | 3                              | 4                | 5                      | 6                 | 7         | 8                  | 9 |
|---|-----------------|--------------------|--------------------------------|------------------|------------------------|-------------------|-----------|--------------------|---|
| Tony Kubek, L<br>OBP: 0.276, SLG: 0.341<br>(1, 6)   | 0-0<br>6-3      |                    | 0-0<br>1B<br>1B                | 1-0<br>HBP       | 0-0<br>L8              |                   |           | 0-0<br>SH1-3       |   |
| Bobby Richardson, R<br>OBP: 0.291, SLG: 0.332<br>(1, 4)   | 0-0<br>HR<br>1B |                    | 0-0<br>S<br>1B<br>1B           | 0-0<br>1B        |                        | 0-0<br>F6         |           | 0-0<br>HR<br>1B    |   |
| Roger Maris, L<br>OBP: 0.369, SLG: 0.466<br>(1, 8)  | 0-0<br>F8       |                    | 0-0<br>6-3                     | 0-0<br>F4        |                        | 0-0<br>G3         |           | 0-0<br>HR          |   |
| Mickey Mantle, S<br>OBP: 0.418, SLG: 0.593<br>Roger Repoz, L<br>(8, PR)<br>(9, 9)   | 0-0<br>HR       |                    | 4-0<br>BB<br>1B<br>1B<br>IBB   | 0-0<br>F2        |                        | 0-0<br>P5         |           | 0-0<br>4-3<br>2B   |   |
| Elston Howard, R<br>OBP: 0.361, SLG: 0.447<br>(1, 2)  | 0-0<br>6-3      |                    | 0-0<br>BB<br>1B<br>1B          |                  | 0-0<br>1-3<br>BB<br>1B |                   | 0-0<br>F9 | 0-0<br>4-3         |   |
| Joe Pepitone, L<br>OBP: 0.276, SLG: 0.408<br>(1, 3)   |                 | 0-3<br>K           | 4-0<br>1B<br>BB                | 0-0<br>F8        |                        | 0-0<br>4-3        |           | 0-0<br>4-3         |   |
| Hector Lopez, R<br>OBP: 0.322, SLG: 0.431<br>(1, 7)   |                 | 0-0<br>5-3         | 0-3<br>K                       | 4-0<br>1-3<br>BB |                        | 4-0<br>BB         |           |                    |   |
| Clete Boyer, R<br>OBP: 0.274, SLG: 0.308<br>(1, 5)  |                 | 0-0<br>FC4-6<br>1B | 0-0<br>1-2<br>2-H<br>3-H<br>1B | 0-0<br>1-3       |                        | 0-0<br>1-2<br>2-3 |           | 0-0<br>1-3         |   |
| Al Downing, R<br>OBP: 0.193, SLG: 0.190<br>Johnny Blanchard, L<br>OBP: 0.328, SLG: 0.425<br>Mike Hegan, L<br>Ralph Terry, R<br>OBP: 0.250, SLG: 0.212<br>(1, 1)<br>(5, PH)<br>(5, PR)<br>(6, 1) |                 | 0-0<br>FC4-6       | 0-3<br>K                       | 4-0<br>BB        |                        | 0-0<br>1-2<br>2-3 |           | 0-0<br>SH1-3<br>1B |   |

| Inning Stats | R: 2 | H: 2 | E: 0 | LOB: 0 | K: 0 | S: 5 | P: 5 | R: 0 | H: 1 | E: 0 | LOB: 1 | K: 1 | S: 6 | R: 3 | H: 4 | E: 0 | LOB: 3 | K: 1 | S: 8 | R: 0 | H: 1 | E: 0 | LOB: 2 | K: 1 | S: 6 | R: 0 | H: 1 | E: 0 | LOB: 3 | K: 0 | S: 4 | R: 0 | H: 0 | E: 0 | LOB: 0 | K: 0 | S: 3 | R: 0 | H: 0 | E: 0 | LOB: 1 | K: 0 | S: 3 | R: 3 | H: 4 | E: 0 | LOB: 2 | K: 0 | S: 7 |
|--------------|------|------|------|--------|------|------|------|------|------|------|--------|------|------|------|------|------|--------|------|------|------|------|------|--------|------|------|------|------|------|--------|------|------|------|------|------|--------|------|------|------|------|------|--------|------|------|------|------|------|--------|------|------|
|--------------|------|------|------|--------|------|------|------|------|------|------|--------|------|------|------|------|------|--------|------|------|------|------|------|--------|------|------|------|------|------|--------|------|------|------|------|------|--------|------|------|------|------|------|--------|------|------|------|------|------|--------|------|------|

| PITCHER                               | IP  | WLS | BF | H | R | ER | SO | BB | IBB | HBP | BLK | WP | HR | S  | P  | ERA   | WHIP  |
|---------------------------------------|-----|-----|----|---|---|----|----|----|-----|-----|-----|----|----|----|----|-------|-------|
| Diego Segui, R<br>ERA: 4.5<br>(1, 1)  | 2.1 | L   | 14 | 6 | 5 | 5  | 1  | 0  | 1   | 0   | 0   | 0  | 1  | 15 | 19 | 19.29 | 2.571 |
| Wes Stock, R<br>ERA: 2.37<br>(3, 1)   | 1.2 |     | 8  | 2 | 0 | 0  | 2  | 1  | 0   | 1   | 0   | 0  | 0  | 10 | 15 | 0.00  | 1.800 |
| Orlando Pena, R<br>ERA: 4.4<br>(5, 1) | 1.0 |     | 6  | 1 | 0 | 0  | 0  | 2  | 0   | 0   | 0   | 0  | 0  | 4  | 12 | 0.00  | 3.000 |
| John Wyatt, R<br>ERA: 3.77<br>(6, 1)  | 3.0 |     | 14 | 4 | 3 | 3  | 0  | 1  | 0   | 0   | 0   | 0  | 1  | 13 | 17 | 9.00  | 1.667 |

**BOTTOM**

**Kansas City Athletics @ New York Yankees**  
Yankee Stadium, Bronx, NY

Sat Sep 19 1964, 3:33 AM EDT  
Att. 9,458 - Overcast - 61 F

| AB | R | H | RBI | BB | SO | LOB |
|----|---|---|-----|----|----|-----|
| 3  | 1 | 1 | 0   | 0  | 0  | 3   |
| 5  | 3 | 4 | 1   | 0  | 0  | 0   |
| 5  | 1 | 1 | 2   | 0  | 0  | 5   |
| 4  | 2 | 2 | 2   | 1  | 0  | 2   |
| 0  | 0 | 0 | 0   | 0  | 0  | 0   |
| 5  | 0 | 2 | 2   | 0  | 0  | 1   |
| 4  | 0 | 0 | 0   | 1  | 1  | 3   |
| 2  | 0 | 0 | 0   | 2  | 1  | 3   |
| 4  | 0 | 2 | 1   | 0  | 0  | 3   |
| 2  | 0 | 0 | 0   | 0  | 1  | 1   |
| 0  | 0 | 0 | 0   | 1  | 0  | 0   |
| 0  | 0 | 0 | 0   | 0  | 0  | 0   |
| 1  | 1 | 1 | 0   | 0  | 0  | 0   |

| AB  | 35 |
|-----|----|
| R   | 8  |
| H   | 13 |
| RBI | 8  |
| BB  | 5  |
| SO  | 3  |
| LOB | 21 |

| 1B | SF | 2B | SAC | 3B | DP | HR | HBP |
|----|----|----|-----|----|----|----|-----|
| 10 | 0  | 1  | 1   | 0  | 0  | 2  | 1   |

| WP | PA |
|----|----|
| 0  | 42 |

WP: 0 PA: 42  
PB: 0 SB: 1 CS: 0



| Batter  | 1                            | 2                               | 3                            | 4                               | 5                            | 6                               | 7                            | 8                               | 9                            | AB R H RBI BB SO LOB  | TOP   |                              |                                 |                              |                                 |                              |                                 |                                  |                                    |                                  |         |    |     |    |   |   |    |    |    |     |     |     |    |    |   |   |     |      |
|---|------------------------------|---------------------------------|------------------------------|---------------------------------|------------------------------|---------------------------------|------------------------------|---------------------------------|------------------------------|---|---|------------------------------|---------------------------------|------------------------------|---------------------------------|------------------------------|---------------------------------|----------------------------------|------------------------------------|----------------------------------|---------|----|-----|----|---|---|----|----|----|-----|-----|-----|----|----|---|---|-----|------|
| <b>Bert Campaneris, R</b><br>OBP: 0.326, SLG: 0.406<br>(1, 7)<br>(4, 6)   | 0-0<br>F3                    |                                 | 0-3<br>K                     |                                 |                              | 0-0<br>F8                       |                              |                                 | 0-0<br>F7                    | 4 0 0 0 0 1 0   | <b>Kansas City Athletics @ New York Yankees</b><br>Yankee Stadium, Bronx, NY<br>Sun Sep 20 1964, 3:33 AM EDT<br>Att. 15,674 - Cloudy - 63 F |                              |                                 |                              |                                 |                              |                                 |                                  |                                    |                                  |         |    |     |    |   |   |    |    |    |     |     |     |    |    |   |   |     |      |
| <b>Dick Green, R</b><br>OBP: 0.314, SLG: 0.386<br>(1, 4)  | 0-0<br>CS<br>1B              |                                 |                              | 0-3<br>K                        |                              |                                 | 0-0<br>L6                    |                                 |                              | 3 0 1 0 0 1 0   |   |                              |                                 |                              |                                 |                              |                                 |                                  |                                    |                                  |         |    |     |    |   |   |    |    |    |     |     |     |    |    |   |   |     |      |
| <b>Wayne Causey, L</b><br>OBP: 0.393, SLG: 0.401<br><b>Ken Harrelson, R</b><br>OBP: 0.252, SLG: 0.405<br>(4, PR)<br>(4, 7)  | 0-0<br>F7                    |                                 |                              | 1-0<br>G6-4-3<br>HBP            |                              |                                 | 0-3<br>K                     |                                 |                              | 1 0 0 0 0 0 1<br>1 0 0 0 0 1 0  |   |                              |                                 |                              |                                 |                              |                                 |                                  |                                    |                                  |         |    |     |    |   |   |    |    |    |     |     |     |    |    |   |   |     |      |
| <b>Rocky Colavito, R</b><br>OBP: 0.369, SLG: 0.525<br>(1, 9)  |                              | 0-0<br>F8                       |                              | 0-0<br>G6-4-3<br>1-2f           |                              |                                 | 0-0<br>F8                    |                                 |                              | 3 0 0 0 0 0 1   |   |                              |                                 |                              |                                 |                              |                                 |                                  |                                    |                                  |         |    |     |    |   |   |    |    |    |     |     |     |    |    |   |   |     |      |
| <b>Jim Gentile, L</b><br>OBP: 0.382, SLG: 0.488<br>(1, 3)   |                              | 0-0<br>F5                       |                              |                                 | 0-0<br>F9                    |                                 |                              | 0-0<br>3-1                      |                              | 3 0 0 0 0 0 0   |   |                              |                                 |                              |                                 |                              |                                 |                                  |                                    |                                  |         |    |     |    |   |   |    |    |    |     |     |     |    |    |   |   |     |      |
| <b>Billy Bryan, L</b><br>OBP: 0.286, SLG: 0.465<br>(1, 2)   |                              | 0-0<br>FC5-4<br>1B              |                              |                                 | 0-0<br>P6                    |                                 |                              | 0-0<br>4-3                      |                              | 3 0 1 0 0 0 0   |   |                              |                                 |                              |                                 |                              |                                 |                                  |                                    |                                  |         |    |     |    |   |   |    |    |    |     |     |     |    |    |   |   |     |      |
| <b>Ed Charles, R</b><br>OBP: 0.318, SLG: 0.367<br>(1, 5)  |                              | 0-0<br>FC5-4<br>1-2f            |                              |                                 | 0-0<br>F9                    |                                 |                              | 0-0<br>F7                       |                              | 3 0 0 0 0 0 1   |   |                              |                                 |                              |                                 |                              |                                 |                                  |                                    |                                  |         |    |     |    |   |   |    |    |    |     |     |     |    |    |   |   |     |      |
| <b>Nelson Mathews, R</b><br>OBP: 0.298, SLG: 0.383<br>(1, 8)  |                              |                                 | 0-3<br>K                     |                                 |                              | 0-0<br>6-3                      |                              |                                 | 0-0<br>5-3                   | 3 0 0 0 0 1 0   |   |                              |                                 |                              |                                 |                              |                                 |                                  |                                    |                                  |         |    |     |    |   |   |    |    |    |     |     |     |    |    |   |   |     |      |
| <b>John O'Donoghue, R</b><br>OBP: 0.245, SLG: 0.302<br><b>Wes Stock, R</b><br>OBP: 0.211, SLG: 0.167<br><b>Manny Jimenez, L</b><br>OBP: 0.289, SLG: 0.442<br><b>Ted Bowsfield, R</b><br>OBP: 0.174, SLG: 0.095<br><b>Larry Stahl, L</b><br>OBP: 0.200, SLG: 0.400<br>(1, 1)<br>(5, 1)<br>(6, PH)<br>(6, 1)<br>(9, PH) |                              |                                 | 0-0<br>5-3                   |                                 |                              | 0-0<br>4-3                      |                              |                                 | 0-3<br>K                     | 1 0 0 0 0 0 0<br>0 0 0 0 0 0 0<br>1 0 0 0 0 0 0<br>0 0 0 0 0 0 0<br>1 0 0 0 0 1 0 |   |                              |                                 |                              |                                 |                              |                                 |                                  |                                    |                                  |         |    |     |    |   |   |    |    |    |     |     |     |    |    |   |   |     |      |
| <b>Inning Stats</b>   | R: 0<br>E: 0<br>K: 0<br>S: 3 | H: 1<br>LOB: 0<br>BB: 0<br>P: 3 | R: 0<br>E: 0<br>K: 0<br>S: 4 | H: 1<br>LOB: 1<br>BB: 0<br>P: 4 | R: 0<br>E: 0<br>K: 2<br>S: 7 | H: 0<br>LOB: 0<br>BB: 0<br>P: 7 | R: 0<br>E: 0<br>K: 1<br>S: 4 | H: 0<br>LOB: 1<br>BB: 0<br>P: 5 | R: 0<br>E: 0<br>K: 0<br>S: 3 | H: 0<br>LOB: 0<br>BB: 0<br>P: 3   |   | R: 0<br>E: 0<br>K: 1<br>S: 5 | H: 0<br>LOB: 0<br>BB: 0<br>P: 5 | R: 0<br>E: 0<br>K: 0<br>S: 3 | H: 0<br>LOB: 0<br>BB: 0<br>P: 3 | R: 0<br>E: 0<br>K: 1<br>S: 5 | H: 0<br>LOB: 0<br>BB: 0<br>P: 5 | 1B: 2<br>2B: 0<br>3B: 0<br>HR: 0 | SF: 0<br>SAC: 0<br>DP: 1<br>HBP: 1 | WP: 0<br>PB: 0<br>SB: 0<br>CS: 1 | PA: 28  |    |     |    |   |   |    |    |    |     |     |     |    |    |   |   |     |      |
| <b>PITCHER</b><br><b>Jim Bouton, R</b><br>ERA: 2.76<br>(1, 1)   | IP<br>9.0                    | WLS<br>W                        | BF<br>28                     | H<br>2                          | R<br>0                       | ER<br>0                         | SO<br>5                      | BB<br>0                         | IBB<br>0                     | HBP<br>1  | BLK<br>0  | WP<br>0                      | HR<br>0                         | S<br>37                      | P<br>38                         | ERA<br>0.00                  | WHIP<br>0.222                   |                                  |                                    |                                  | PITCHER | IP | WLS | BF | H | R | ER | SO | BB | IBB | HBP | BLK | WP | HR | S | P | ERA | WHIP |

|            |    |
|------------|----|
| <b>AB</b>  | 27 |
| <b>R</b>   | 0  |
| <b>H</b>   | 2  |
| <b>RBI</b> | 0  |
| <b>BB</b>  | 0  |
| <b>SO</b>  | 5  |
| <b>LOB</b> | 3  |

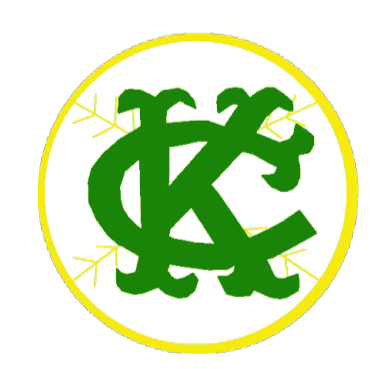

| Batter   | 1          | 2                             | 3                               | 4                | 5                       | 6                                | 7         | 8          | 9 |
|--|------------|-------------------------------|---------------------------------|------------------|-------------------------|----------------------------------|-----------|------------|---|
| Tony Kubek, L (1, 6)<br>OBP: 0.275, SLG: 0.340                             | 0-3<br>K   |                               | 0-0<br>5-3                      |                  | 0-0<br>G3               | 0-0<br>F9                        |           | 0-0<br>1B  |   |
| Bobby Richardson, R (1, 4)<br>OBP: 0.293, SLG: 0.333                       | 0-0<br>5-3 |                               | 0-0<br>1B<br>1B                 |                  | 0-0<br>1B<br>1B         | 0-0<br>SH4-3                     |           | 0-0<br>F7  |   |
| Roger Maris, L (1, 8)<br>OBP: 0.369, SLG: 0.464                            | 0-0<br>4-3 |                               | 0-0<br>FC5-4<br>1B              |                  | 0-0<br>P6               | 0-0<br>P4                        |           |            |   |
| Mickey Mantle, S (1, 9)<br>OBP: 0.416, SLG: 0.589<br>Roger Repoz, L (8, 9) |            | 0-0<br>6-3                    | 0-0<br>FC5-4                    |                  | 4-0<br>1B<br>1-2<br>BB  |                                  | 0-0<br>L8 |            |   |
| Elston Howard, R (1, 2)<br>OBP: 0.362, SLG: 0.447                          |            | 4-0<br>FC6-4<br>BB            |                                 | 0-0<br>F8        | 0-0<br>1-3<br>2-H<br>1B |                                  | 0-0<br>L9 |            |   |
| Hector Lopez, R (1, 7)<br>OBP: 0.321, SLG: 0.429                           |            | 0-0<br>FC6-4<br>FC4-6<br>1-2f |                                 | 0-3<br>K         | 0-0<br>F5               |                                  | 0-0<br>1B |            |   |
| Joe Pepitone, L (1, 3)<br>OBP: 0.278, SLG: 0.409                           |            | 0-0<br>FC4-6<br>1-2f          |                                 | 0-0<br>3B<br>1B  |                         | 0-0<br>E<br>SH4-3<br>1B          | 0-0<br>F5 |            |   |
| Clete Boyer, R (1, 5)<br>OBP: 0.276, SLG: 0.314                            |            |                               | 0-0<br>5-3<br>SH1-4<br>1B<br>1B | 0-0<br>1-H<br>3B |                         | 0-0<br>FC5<br>SH4-3<br>E<br>1-2  |           | 0-0<br>5-3 |   |
| Jim Bouton, R (1, 1)<br>OBP: 0.126, SLG: 0.138                             |            |                               | 0-0<br>SH1-4<br>1-2             | 0-0<br>5-3       |                         | 0-0<br>E1<br>SH4-3<br>1-2<br>2-3 |           | 0-0<br>1-3 |   |

| Inning Stats | R: 0 | H: 0 | E: 0 | K: 1 | S: 5   | LOB: 0 | BB: 0 | P: 5 |
|--------------|------|------|------|------|--|--------|-------|------|
|              | R: 0 | H: 0 | E: 0 | K: 0 | S: 3 <td>LOB: 1</td> <td>BB: 1</td> <td>P: 7 </td> | LOB: 1 | BB: 1 | P: 7 |
|              | R: 1 | H: 3 | E: 0 | K: 0 | S: 6 <td>LOB: 2</td> <td>BB: 0</td> <td>P: 6 </td> | LOB: 2 | BB: 0 | P: 6 |
|              | R: 1 | H: 2 | E: 0 | K: 1 | S: 7 <td>LOB: 1</td> <td>BB: 0</td> <td>P: 7 </td> | LOB: 1 | BB: 0 | P: 7 |
|              | R: 1 | H: 2 | E: 0 | K: 0 | S: 5 <td>LOB: 2</td> <td>BB: 1</td> <td>P: 9 </td> | LOB: 2 | BB: 1 | P: 9 |
|              | R: 1 | H: 1 | E: 2 | K: 0 | S: 6 <td>LOB: 2</td> <td>BB: 0</td> <td>P: 6 </td> | LOB: 2 | BB: 0 | P: 6 |
|              | R: 0 | H: 1 | E: 0 | K: 0 | S: 4 <td>LOB: 1</td> <td>BB: 0</td> <td>P: 4 </td> | LOB: 1 | BB: 0 | P: 4 |
|              | R: 0 | H: 1 | E: 0 | K: 0 | S: 4 <td>LOB: 1</td> <td>BB: 0</td> <td>P: 4 </td> | LOB: 1 | BB: 0 | P: 4 |

| PITCHER                                | IP  | WLS | BF | H | R | ER | SO | BB | IBB | HBP | BLK | WP | HR | S  | P  | ERA  | WHIP  |
|--|-----|-----|----|---|---|----|----|----|-----|-----|-----|----|----|----|----|------|-------|
| John O'Donoghue, L (1, 1)<br>ERA: 4.76 | 4.2 | L   | 23 | 7 | 3 | 3  | 2  | 2  | 0   | 0   | 0   | 0  | 0  | 25 | 33 | 5.79 | 1.929 |
| Wes Stock, R (5, 1)<br>ERA: 2.37       | 0.1 |     | 1  | 0 | 0 | 0  | 0  | 0  | 0   | 0   | 0   | 0  | 0  | 1  | 1  | 0.00 | 0.000 |
| Ted Bowsfield, L (6, 1)<br>ERA: 4.47   | 3.0 |     | 14 | 3 | 1 | 0  | 0  | 0  | 0   | 0   | 0   | 0  | 0  | 14 | 14 | 0.00 | 1.000 |

**BOTTOM**

**Kansas City Athletics @ New York Yankees**  
 Yankee Stadium, Bronx, NY

Sun Sep 20 1964, 3:33 AM EDT  
 Att. 15,674 - Cloudy - 63 F

| AB | R | H | RBI | BB | SO | LOB |
|----|---|---|-----|----|----|-----|
| 5  | 0 | 1 | 0   | 0  | 1  | 4   |
| 4  | 1 | 2 | 2   | 0  | 0  | 1   |
| 4  | 0 | 1 | 0   | 0  | 0  | 3   |
| 3  | 0 | 0 | 0   | 1  | 0  | 2   |
| 0  | 0 | 0 | 0   | 0  | 0  | 0   |
| 3  | 0 | 1 | 1   | 1  | 0  | 0   |
| 4  | 0 | 1 | 0   | 0  | 1  | 3   |
| 4  | 2 | 2 | 0   | 0  | 0  | 2   |
| 4  | 1 | 2 | 1   | 0  | 0  | 1   |
| 3  | 0 | 0 | 0   | 0  | 0  | 3   |

| AB  | 34 |
|-----|----|
| R   | 4  |
| H   | 10 |
| RBI | 4  |
| BB  | 2  |
| SO  | 2  |
| LOB | 19 |

WP: 0 PA: 38  
 PB: 0  
 SB: 0  
 CS: 0



| 1B | 2B | 3B | HR | SF | SAC | DP | HBP |
|----|----|----|----|----|-----|----|-----|
| 9  | 0  | 1  | 0  | 0  | 0   | 0  | 0   |

| Batter   | 1   | 2                                       | 3                                       | 4                                       | 5                                     | 6                                   | 7                            | 8   | 9                                       | AB R H RBI BB SO LOB                            | TOP                          |                                 |                              |                                 |                              |                                  |                              |                                 |                                   |                                    |  |
|--|---|---|---|---|---------------------------------------|-------------------------------------|------------------------------|---|---|---|------------------------------|---------------------------------|------------------------------|---------------------------------|------------------------------|----------------------------------|------------------------------|---------------------------------|-----------------------------------|------------------------------------|--|
| Rich Rollins, R<br>OBP: 0.334, SLG: 0.408<br>(1, 5)<br>BB  | 4-0<br>FC5-4<br>BB  | 0-0<br>FC6-4<br>1B                      | 0-0<br>F7                               |   | 0-0<br>F7                             |                                     |                              | 0-0<br>HBP<br>1B  |   | 4 2 2 0 1 0 1                                   |                              |                                 |                              |                                 |                              |                                  |                              |                                 |                                   |                                    |  |
| Zoilo Versalles, R<br>OBP: 0.312, SLG: 0.445<br>Jerry Kindall, R<br>OBP: 0.239, SLG: 0.263<br>(1, 6)<br>(8, 4)                                   | 0-0<br>FC5-4<br>HR  | 0-0<br>FC6-4<br>1B                      | 0-0<br>1B                               |   |                                       | 0-0<br>E<br>1B                      |                              | 1-0<br>FC5-4<br>HBP<br>1B   |   | 4 1 3 0 0 0 1<br>0 0 0 0 0 0 0                  |                              |                                 |                              |                                 |                              |                                  |                              |                                 |                                   |                                    |  |
| Tony Oliva, L<br>OBP: 0.358, SLG: 0.558<br>(1, 9)  | 0-0<br>HR   | 0-0<br>FC6-4<br>BB<br>1B                | 0-0<br>F8                               |   |                                       | 0-0<br>F5                           |                              | 0-0<br>FC5-4<br>1B  |   | 5 2 2 3 0 0 5                                   |                              |                                 |                              |                                 |                              |                                  |                              |                                 |                                   |                                    |  |
| Harmon Killebrew, R<br>OBP: 0.382, SLG: 0.561<br>Don Mincher, L<br>OBP: 0.307, SLG: 0.571<br>(1, 7)<br>(8, 3)                                    | 0-0<br>E5<br>HR<br>1B   | 4-0<br>1B<br>1B<br>BB                   |   | 0-0<br>5-3                              |                                       | 0-0<br>F8                           |                              | 0-0<br>FC5-4  |   | 4 1 1 0 1 0 3<br>0 0 0 0 0 0 0                  |                              |                                 |                              |                                 |                              |                                  |                              |                                 |                                   |                                    |  |
| Jimmie Hall, L<br>OBP: 0.341, SLG: 0.487<br>(1, 8)   | 0-0<br>HR   | 0-0<br>1B<br>1B                         |   | 0-3<br>K                                |                                       | 0-3<br>K                            |                              | 0-3<br>K  |   | 5 1 2 4 0 3 3                                   |                              |                                 |                              |                                 |                              |                                  |                              |                                 |                                   |                                    |  |
| Bob Allison, R<br>OBP: 0.401, SLG: 0.553<br>(1, 3)<br>(8, 7)   | 0-0<br>1B<br>1B   | 0-3<br>K                                |   | 0-0<br>HR                               |                                       |                                     | 0-0<br>SF9<br>3B             | 0-3<br>K  |   | 5 2 3 1 0 2 4                                   |                              |                                 |                              |                                 |                              |                                  |                              |                                 |                                   |                                    |  |
| Earl Battey, R<br>OBP: 0.337, SLG: 0.406<br>(1, 2)   | 0-0<br>1B   | 0-0<br>1B                               |   | 0-0<br>F8                               |                                       |                                     | 0-0<br>SF9                   |   | 0-0<br>F7                               | 4 0 2 1 0 0 0                                   |                              |                                 |                              |                                 |                              |                                  |                              |                                 |                                   |                                    |  |
| Bill Bethea, R<br>OBP: 0.364, SLG: 0.333<br>(1, 4)<br>(8, 6)   | 0-0<br>F8   |   |   |   | 0-0<br>F8                             |                                     | 0-0<br>6-3                   |   | 0-0<br>5-3                              | 5 0 1 0 0 0 2                                   |                              |                                 |                              |                                 |                              |                                  |                              |                                 |                                   |                                    |  |
| Camilo Pascual, R<br>OBP: 0.232, SLG: 0.241<br>Al Worthington, R<br>OBP: 0.063, SLG: 0.063<br>Johnny Klippstein, R<br>(1, 1)<br>(6, 1)<br>(9, 1) | 0-0<br>4-3  |   |   |   | 0-0<br>FC1-6<br>1B                    |                                     | 0-0<br>6-3                   |   | 0-0<br>3-1                              | 3 0 0 0 0 0 3<br>2 0 0 0 0 0 0<br>0 0 0 0 0 0 0 |                              |                                 |                              |                                 |                              |                                  |                              |                                 |                                   |                                    |  |
| <b>Inning Stats</b>  | R: 4<br>E: 1<br>K: 0<br>S: 8  | H: 5<br>LOB: 2<br>BB: 1<br>P: 12        | R: 2<br>E: 0<br>K: 1<br>S: 8            | H: 4<br>LOB: 2<br>BB: 1<br>P: 12        | R: 0<br>E: 0<br>K: 0<br>S: 5          | H: 2<br>LOB: 2<br>BB: 0<br>P: 5     | R: 1<br>E: 0<br>K: 1<br>S: 6 | H: 1<br>LOB: 0<br>BB: 0<br>P: 6   | R: 0<br>E: 0<br>K: 0<br>S: 3            | H: 0<br>LOB: 0<br>BB: 0<br>P: 3                 | R: 0<br>E: 1<br>K: 1<br>S: 6 | H: 1<br>LOB: 1<br>BB: 0<br>P: 6 | R: 1<br>E: 0<br>K: 0<br>S: 4 | H: 1<br>LOB: 0<br>BB: 0<br>P: 4 | R: 1<br>E: 0<br>K: 2<br>S: 9 | H: 2<br>LOB: 2<br>BB: 0<br>P: 10 | R: 0<br>E: 0<br>K: 0<br>S: 3 | H: 0<br>LOB: 0<br>BB: 0<br>P: 3 | 1B: 12<br>2B: 0<br>3B: 1<br>HR: 3 | SF: 1<br>SAC: 0<br>DP: 0<br>HBP: 1 | WP: 0<br>PA: 45<br>PB: 0<br>SB: 0<br>CS: 0 |
| <b>PITCHER</b>   | IP<br>WLS<br>BF<br>H<br>R<br>ER<br>SO<br>BB<br>IBB<br>HBP<br>BLK<br>WP<br>HR<br>S<br>P<br>ERA<br>WHIP | Blue Moon Odom, R<br>ERA: 9.0<br>(1, 1) | Moe Drabowsky, R<br>ERA: 5.14<br>(1, 1) | Jose Santiago, R<br>ERA: 4.83<br>(3, 1) | Ken Sanders, R<br>ERA: 3.67<br>(7, 1) | Wes Stock, R<br>ERA: 2.34<br>(8, 1) | <b>PITCHER</b>               | IP<br>WLS<br>BF<br>H<br>R<br>ER<br>SO<br>BB<br>IBB<br>HBP<br>BLK<br>WP<br>HR<br>S<br>P<br>ERA<br>WHIP | Ted Bowsfield, L<br>ERA: 4.43<br>(9, 1) |   |                              |                                 |                              |                                 |                              |                                  |                              |                                 |                                   |                                    |  |

**Minnesota Twins @ Kansas City Athletics**  
 Municipal Stadium, Kansas City, MO  
 Tue Sep 22 1964, 8:05 PM EDT  
 Att. 3,028 - Unknown

|            |    |
|------------|----|
| <b>AB</b>  | 41 |
| <b>R</b>   | 9  |
| <b>H</b>   | 16 |
| <b>RBI</b> | 9  |
| <b>BB</b>  | 2  |
| <b>SO</b>  | 5  |
| <b>LOB</b> | 22 |



| Batter   | 1          | 2                                 | 3          | 4         | 5          | 6                     | 7          | 8          | 9               | AB | R | H | RBI | BB | SO | LOB |
|--|------------|-----------------------------------|------------|-----------|------------|-----------------------|------------|------------|-----------------|----|---|---|-----|----|----|-----|
| Bert Campaneris, R<br>OBP: 0.319, SLG: 0.396<br>(1, 6)   | 0-0<br>5-3 |                                   | 0-0<br>5-3 |           | 0-0<br>6-3 | 0-0<br>F3             |            | 0-0<br>F7  |                 | 5  | 0 | 0 | 0   | 0  | 0  | 3   |
| Dick Green, R<br>OBP: 0.312, SLG: 0.391<br>(1, 4)  | 0-0<br>F9  |                                   | 0-0<br>6-3 |           | 0-3<br>K   |                       | 0-0<br>HR  | 0-0<br>1-3 |                 | 5  | 1 | 1 | 1   | 0  | 1  | 1   |
| Larry Stahl, L<br>OBP: 0.100, SLG: 0.200<br>(1, 7)   | 0-3<br>K   |                                   | 0-3<br>K   |           |            | 0-0<br>4-3            | 0-0<br>1-3 |            | 0-0<br>G3       | 5  | 0 | 0 | 0   | 0  | 2  | 0   |
| Rocky Colavito, R<br>OBP: 0.369, SLG: 0.522<br>(1, 9)  |            | 0-3<br>K                          |            | 0-3<br>K  |            | 4-0<br>1B<br>3B<br>BB | 0-0<br>6-3 |            | 4-0<br>HR<br>BB | 3  | 2 | 0 | 0   | 2  | 2  | 0   |
| Jim Gentile, L<br>OBP: 0.388, SLG: 0.498<br>(1, 3)   |            | 4-0<br>1B<br>BB                   |            | 0-0<br>HR |            | 0-0<br>3B<br>1B       | 4-0<br>BB  |            | 4-0<br>HR<br>BB | 2  | 4 | 2 | 1   | 3  | 0  | 0   |
| Ed Charles, R<br>OBP: 0.322, SLG: 0.375<br>(1, 5)  |            | 0-0<br>1B<br>1B                   |            | 0-0<br>F8 |            | 4-0<br>3B<br>BB       | 4-0<br>BB  |            | 0-0<br>HR       | 3  | 2 | 2 | 3   | 2  | 0  | 0   |
| Nelson Mathews, R<br>OBP: 0.297, SLG: 0.382<br>Billy Bryan, L (9, PH)<br>OBP: 0.289, SLG: 0.481<br>(1, 8)  |            | 0-0<br>BB<br>1B                   |            | 0-0<br>E5 |            | 0-3<br>K              | 0-3<br>K   |            | 0-0<br>HR       | 4  | 0 | 1 | 1   | 0  | 2  | 5   |
| Doc Edwards, R<br>OBP: 0.254, SLG: 0.301<br>Dave Duncan, R<br>OBP: 0.150, SLG: 0.250<br>(1, 2)   |            | 4-0<br>1B<br>BB                   |            | 0-0<br>F9 |            | 0-0<br>3B             |            | 0-0<br>1B  |                 | 1  | 0 | 0 | 0   | 1  | 0  | 1   |
| Blue Moon Odum, R<br>Moe Drabowsky, R<br>Manny Jimenez, L<br>Jose Santiago, R<br>Ken Hargettson, R<br>Ken Sanders, R<br>Wes Stock, R<br>Jose Tartabull, L<br>Ted Bowditch, R<br>(9, 1) |            | 0-0<br>G5-4-3<br>1-2<br>2-3<br>BB |            | 0-0<br>F9 |            | 0-0<br>F9             |            | 0-3<br>K   |                 | 0  | 0 | 0 | 0   | 0  | 0  | 0   |

**BOTTOM**

**Minnesota Twins @ Kansas City Athletics**  
**Municipal Stadium, Kansas City, MO**  
 Tue Sep 22 1964, 8:05 PM EDT  
 Att. 3,028 - Unknown

livebaseballscorecards.com

|            |           |
|------------|-----------|
| <b>AB</b>  | <b>34</b> |
| <b>R</b>   | <b>10</b> |
| <b>H</b>   | <b>9</b>  |
| <b>RBI</b> | <b>10</b> |
| <b>BB</b>  | <b>9</b>  |
| <b>SO</b>  | <b>8</b>  |
| <b>LOB</b> | <b>14</b> |



| Inning Stats | R: 0 | H: 0 | E: 0 | K: 1 | S: 5 | LOB: 0 | BB: 0 | P: 5 | R: 1 | H: 2 | E: 0 | K: 1 | S: 6 | LOB: 2 | BB: 2 | P: 14 | R: 0 | H: 0 | E: 0 | K: 1 | S: 5 | LOB: 0 | BB: 0 | P: 5 | R: 1 | H: 1 | E: 1 | K: 1 | S: 7 | LOB: 1 | BB: 0 | P: 7 | R: 0 | H: 0 | E: 0 | K: 1 | S: 5 | LOB: 0 | BB: 0 | P: 5 | R: 3 | H: 2 | E: 0 | K: 1 | S: 7 | LOB: 2 | BB: 3 | P: 19 | R: 1 | H: 1 | E: 0 | K: 1 | S: 6 | LOB: 2 | BB: 2 | P: 14 | R: 0 | H: 1 | E: 0 | K: 1 | S: 6 | LOB: 1 | BB: 0 | P: 6 | R: 4 | H: 2 | E: 0 | K: 0 | S: 3 | LOB: 0 | BB: 2 | P: 11 | 1B: 4 | 2B: 0 | 3B: 1 | HR: 4 | SF: 0 | SAC: 0 | DP: 1 | HBP: 0 | WP: 0 | PA: 43 |
|--------------|------|------|------|------|------|--------|-------|------|------|------|------|------|------|--------|-------|-------|------|------|------|------|------|--------|-------|------|------|------|------|------|------|--------|-------|------|------|------|------|------|------|--------|-------|------|------|------|------|------|------|--------|-------|-------|------|------|------|------|------|--------|-------|-------|------|------|------|------|------|--------|-------|------|------|------|------|------|------|--------|-------|-------|-------|-------|-------|-------|-------|--------|-------|--------|-------|--------|
|--------------|------|------|------|------|------|--------|-------|------|------|------|------|------|------|--------|-------|-------|------|------|------|------|------|--------|-------|------|------|------|------|------|------|--------|-------|------|------|------|------|------|------|--------|-------|------|------|------|------|------|------|--------|-------|-------|------|------|------|------|------|--------|-------|-------|------|------|------|------|------|--------|-------|------|------|------|------|------|------|--------|-------|-------|-------|-------|-------|-------|-------|--------|-------|--------|-------|--------|

| PITCHER                                     | IP  | WLS | BF | H | R | ER | SO | BB | IBB | HBP | BLK | WP | HR | S  | P  | ERA   | WHIP  |
|---|-----|-----|----|---|---|----|----|----|-----|-----|-----|----|----|----|----|-------|-------|
| Camilo Pascual, R<br>ERA: 3.47<br>(1, 1)    | 5.2 |     | 27 | 5 | 5 | 5  | 6  | 5  | 0   | 0   | 0   | 0  | 1  | 34 | 54 | 7.94  | 1.765 |
| Al Worthington, R<br>ERA: 2.13<br>(6, 1)    | 2.2 |     | 15 | 3 | 4 | 4  | 2  | 4  | 0   | 0   | 0   | 0  | 2  | 15 | 31 | 13.50 | 2.625 |
| Johnny Klippstein, R<br>ERA: 2.71<br>(9, 1) | 0.0 | L   | 1  | 1 | 1 | 1  | 0  | 0  | 0   | 0   | 0   | 0  | 1  | 1  | 1  | ∞     | ∞     |

| PITCHER | IP | WLS | BF | H | R | ER | SO | BB | IBB | HBP | BLK | WP | HR | S | P | ERA | WHIP |
|---------|----|-----|----|---|---|----|----|----|-----|-----|-----|----|----|---|---|-----|------|
|---------|----|-----|----|---|---|----|----|----|-----|-----|-----|----|----|---|---|-----|------|

| Batter   | 1   | 2                               | 3                            | 4                               | 5                            | 6                                | 7                            | 8                               | 9                            | AB R H RBI BB SO LOB            | TOP  |                                 |                              |                                 |                              |                                 |                                  |                                    |                                  |        |
|--|---|---------------------------------|------------------------------|---------------------------------|------------------------------|----------------------------------|------------------------------|---------------------------------|------------------------------|---------------------------------|--|---------------------------------|------------------------------|---------------------------------|------------------------------|---------------------------------|----------------------------------|------------------------------------|----------------------------------|--------|
| Rich Rollins, R<br>OBP: 0.334, SLG: 0.411 (1, 5) X     | 0-0<br>5-3  |                                 | 0-0<br>FC1                   |                                 | 0-0<br>F5                    |                                  | 0-0<br>3B                    |                                 |                              | 4 0 1 0 0 0 0                   | <b>Minnesota Twins @ Kansas City Athletics</b><br>Municipal Stadium, Kansas City, MO<br>Wed Sep 23 1964, 8:05 PM EDT<br>Att. 2,048 - Unknown |                                 |                              |                                 |                              |                                 |                                  |                                    |                                  |        |
| Zoilo Versalles, R<br>OBP: 0.311, SLG: 0.446 (1, 6) X  | 0-0<br>F3   |                                 | 0-0<br>2B                    |                                 | 0-3<br>K                     |                                  | 0-0<br>F3                    |                                 |                              | 4 0 1 0 0 1 1                   |  |                                 |                              |                                 |                              |                                 |                                  |                                    |                                  |        |
| Tony Oliva, L<br>OBP: 0.359, SLG: 0.557 (1, 9) X       | 0-0<br>4-3  |                                 | 0-3<br>K                     |                                 | 4-0<br>BB                    |                                  |                              | 0-0<br>1B                       |                              | 3 0 1 0 1 1 1                   |  |                                 |                              |                                 |                              |                                 |                                  |                                    |                                  |        |
| Harmon Killebrew, R<br>OBP: 0.382, SLG: 0.559 (1, 7) X |   | 0-0<br>F3                       |                              | 0-0<br>1B                       | 0-0<br>F3                    |                                  |                              | 0-3<br>K                        |                              | 4 1 1 0 0 1 2                   |  |                                 |                              |                                 |                              |                                 |                                  |                                    |                                  |        |
| Jimmie Hall, L<br>OBP: 0.340, SLG: 0.485 (1, 8) S      |   | 0-3<br>K                        |                              | 0-0<br>1B                       |                              | 0-0<br>F4                        |                              | 0-0<br>F3                       |                              | 4 0 1 0 0 1 1                   |  |                                 |                              |                                 |                              |                                 |                                  |                                    |                                  |        |
| Bob Allison, R<br>OBP: 0.404, SLG: 0.553 (1, 3) B      |   | 4-0<br>BB                       |                              | 4-0<br>BB                       |                              | 1-0<br>HBP                       |                              | 0-0<br>3-1                      |                              | 0 0 0 0 2 0 0                   |  |                                 |                              |                                 |                              |                                 |                                  |                                    |                                  |        |
| Don Mincher, L<br>OBP: 0.306, SLG: 0.569 (8, 3) B      |   |                                 |                              | 1-2<br>BB                       |                              | G5-4-3<br>HBP                    |                              |                                 |                              | 1 0 0 0 0 0 1                   |  |                                 |                              |                                 |                              |                                 |                                  |                                    |                                  |        |
| Earl Battey, R<br>OBP: 0.334, SLG: 0.403 (1, 2) X      |   | 0-0<br>F9                       |                              | 0-0<br>SF7                      |                              | 0-0<br>G5-4-3                    |                              |                                 |                              | 3 0 0 1 0 0 2                   |  |                                 |                              |                                 |                              |                                 |                                  |                                    |                                  |        |
| Bill Bethea, R<br>OBP: 0.333, SLG: 0.250 (1, 4) B      |   |                                 | 4-0<br>FC1                   |                                 | 0-0<br>6-3                   |                                  | 0-3<br>K                     |                                 | 0-0<br>F7                    | 3 1 0 0 1 1 2                   |  |                                 |                              |                                 |                              |                                 |                                  |                                    |                                  |        |
| Dave Boswell, R (1, 1) X                               |   |                                 | 0-0<br>SH5-4                 |                                 | 0-0<br>4-3                   |                                  | 0-0<br>F8                    |                                 | 0-3<br>K                     | 3 0 0 0 0 1 2                   |  |                                 |                              |                                 |                              |                                 |                                  |                                    |                                  |        |
| Jim Perry, S (9, 1)                                    |   |                                 |                              |                                 |                              |                                  |                              |                                 |                              | 0 0 0 0 0 0 0                   |  |                                 |                              |                                 |                              |                                 |                                  |                                    |                                  |        |
| Bill Pleis, L (9, 1)                                   |   |                                 |                              |                                 |                              |                                  |                              |                                 |                              | 0 0 0 0 0 0 0                   |  |                                 |                              |                                 |                              |                                 |                                  |                                    |                                  |        |
| Mudcat Grant, R (9, 1)                                 |   |                                 |                              |                                 |                              |                                  |                              |                                 |                              | 0 0 0 0 0 0 0                   |  |                                 |                              |                                 |                              |                                 |                                  |                                    |                                  |        |
| <b>Inning Stats</b>                                    | R: 0<br>E: 0<br>K: 0<br>S: 3                          | H: 0<br>LOB: 0<br>BB: 0<br>P: 3 | R: 0<br>E: 0<br>K: 1<br>S: 5 | H: 0<br>LOB: 1<br>BB: 1<br>P: 9 | R: 1<br>E: 0<br>K: 1<br>S: 6 | H: 1<br>LOB: 1<br>BB: 1<br>P: 10 | R: 1<br>E: 0<br>K: 0<br>S: 5 | H: 2<br>LOB: 2<br>BB: 1<br>P: 9 | R: 0<br>E: 0<br>K: 1<br>S: 5 | H: 0<br>LOB: 1<br>BB: 1<br>P: 9 | R: 0<br>E: 0<br>K: 1<br>S: 6   | H: 1<br>LOB: 1<br>BB: 0<br>P: 6 | R: 0<br>E: 0<br>K: 1<br>S: 6 | H: 1<br>LOB: 1<br>BB: 0<br>P: 6 | R: 0<br>E: 0<br>K: 1<br>S: 5 | H: 0<br>LOB: 0<br>BB: 0<br>P: 5 | 1B: 3<br>2B: 1<br>3B: 1<br>HR: 0 | SF: 1<br>SAC: 1<br>DP: 1<br>HBP: 1 | WP: 0<br>PB: 0<br>SB: 1<br>CS: 0 | PA: 36 |
| <b>PITCHER</b>   | IP WLS BF H R ER SO BB IBB HBP BLK WP HR S P ERA WHIP |                                 |                              |                                 |                              |                                  |                              |                                 |                              |                                 |  |                                 |                              |                                 |                              |                                 |                                  |                                    |                                  |        |
| Low Krausse, R (1, 1) ERA: 8.59                        | 6.0 L 25 3 2 2 3 4 0 1 0 0 0 0 26 43 3.00 1.167       |                                 |                              |                                 |                              |                                  |                              |                                 |                              |                                 |  |                                 |                              |                                 |                              |                                 |                                  |                                    |                                  |        |
| John Wyatt, R (7, 1) ERA: 3.71                         | 2.0 8 2 0 0 2 0 0 0 0 0 0 0 12 12 0.00 1.000          |                                 |                              |                                 |                              |                                  |                              |                                 |                              |                                 |  |                                 |                              |                                 |                              |                                 |                                  |                                    |                                  |        |
| Wes Stock, R (9, 1) ERA: 2.32                          | 1.0 3 0 0 0 1 0 0 0 0 0 0 0 5 5 0.00 0.000            |                                 |                              |                                 |                              |                                  |                              |                                 |                              |                                 |  |                                 |                              |                                 |                              |                                 |                                  |                                    |                                  |        |

livebaseballscorecards.com

|     |    |
|-----|----|
| AB  | 29 |
| R   | 2  |
| H   | 5  |
| RBI | 1  |
| BB  | 4  |
| SO  | 6  |
| LOB | 12 |





| Batter   | 1          | 2         | 3          | 4                     | 5          | 6         | 7         | 8          | 9                    | AB | R | H | RBI | BB | SO | LOB |
|--|------------|-----------|------------|-----------------------|------------|-----------|-----------|------------|----------------------|----|---|---|-----|----|----|-----|
| Bert Campaneris, R<br>OBP: 0.314, SLG: 0.389<br>(1, 6)   | 0-3<br>K   |           | 0-0<br>F2  |                       |            | 0-0<br>F8 |           | 0-3<br>K   |                      | 4  | 0 | 0 | 0   | 0  | 2  | 1   |
| Dick Green, R<br>OBP: 0.312, SLG: 0.396<br>(1, 4)  | 0-0<br>F6  |           |            | 0-0<br>1-3            |            | 0-3<br>K  |           |            | 0-0<br>HR            | 4  | 1 | 1 | 1   | 0  | 1  | 0   |
| Larry Stahl, L<br>OBP: 0.286, SLG: 0.357<br>(1, 7)   | 0-0<br>5-3 |           |            | 0-0<br>G5-4-3<br>1B   |            |           | 0-0<br>1B |            | 0-0<br>FC1-6<br>1B   | 4  | 0 | 3 | 0   | 0  | 0  | 0   |
| Rocky Colavito, R<br>OBP: 0.369, SLG: 0.520<br>(1, 9)  |            | 0-0<br>1B |            | 0-0<br>G5-4-3<br>1-2f |            |           | 0-3<br>K  |            | 0-0<br>F9            | 4  | 0 | 1 | 0   | 0  | 1  | 3   |
| Jim Gentile, L<br>OBP: 0.385, SLG: 0.493<br>Ted Bowsfield, R<br>OBP: 0.174, SLG: 0.095<br>(1, 3)<br>(9, PR)  |            | 0-0<br>F5 |            |                       | 0-0<br>3-1 |           | 0-0<br>F8 |            | 0-0<br>FC1-6<br>1-2f | 4  | 0 | 0 | 0   | 0  | 0  | 3   |
| Ed Charles, R<br>OBP: 0.322, SLG: 0.374<br>Billy Bryan, L<br>OBP: 0.288, SLG: 0.479<br>(1, 5)<br>(9, PH)   |            | 0-0<br>F3 |            |                       | 4-0<br>BB  |           | 0-3<br>K  |            | 0-0<br>F6            | 2  | 0 | 0 | 0   | 1  | 1  | 2   |
| Nelson Mathews, R<br>OBP: 0.296, SLG: 0.380<br>(1, 8)  |            | 0-0<br>F8 |            |                       | 0-3<br>K   |           |           | 0-0<br>6-3 |                      | 3  | 0 | 0 | 0   | 0  | 1  | 2   |
| Dave Duncan, R<br>OBP: 0.130, SLG: 0.217<br>(1, 2)   |            |           | 0-0<br>5-3 |                       | 0-3<br>K   |           |           | 0-3<br>K   |                      | 3  | 0 | 0 | 0   | 0  | 2  | 1   |
| Lew Krausse, R<br>Jose Tartabull, L<br>John Wyatt, R<br>Manny Jimenez, L<br>Wayne Causey, L<br>Wes Stock, R<br>(1, 1)<br>(6, PH)<br>(7, 1)<br>(8, PH)<br>(8, PR)<br>(9, 1) |            |           | 0-3<br>K   |                       |            | 0-0<br>F3 |           | 4-0<br>BB  |                      | 1  | 0 | 0 | 0   | 0  | 1  | 0   |

| Inning Stats | R: 0 | H: 0 | E: 0 | K: 1 | S: 5 | R: 0 | H: 1 | E: 0 | K: 0 | S: 4 | R: 0 | H: 0 | E: 0 | K: 1 | S: 5 | R: 0 | H: 1 | E: 0 | K: 0 | S: 3 | R: 0 | H: 0 | E: 0 | K: 2 | S: 7 | R: 0 | H: 0 | E: 0 | K: 1 | S: 5 | R: 0 | H: 1 | E: 0 | K: 2 | S: 8 | R: 0 | H: 0 | E: 0 | K: 2 | S: 7 | R: 1 | H: 2 | E: 0 | K: 0 | S: 5 | 1B: 4 | 2B: 0 | 3B: 0 | HR: 1 | SF: 0 | SAC: 0 | DP: 1 | HBP: 0 | WP: 0 | PB: 0 | SB: 0 | CS: 0 | PA: 33 |
|--------------|------|------|------|------|------|------|------|------|------|------|------|------|------|------|------|------|------|------|------|------|------|------|------|------|------|------|------|------|------|------|------|------|------|------|------|------|------|------|------|------|------|------|------|------|------|-------|-------|-------|-------|-------|--------|-------|--------|-------|-------|-------|-------|--------|
|--------------|------|------|------|------|------|------|------|------|------|------|------|------|------|------|------|------|------|------|------|------|------|------|------|------|------|------|------|------|------|------|------|------|------|------|------|------|------|------|------|------|------|------|------|------|------|-------|-------|-------|-------|-------|--------|-------|--------|-------|-------|-------|-------|--------|

| PITCHER                                | IP  | WLS | BF | H | R | ER | SO | BB | IBB | HBP | BLK | WP | HR | S  | P  | ERA  | WHIP  |
|--|-----|-----|----|---|---|----|----|----|-----|-----|-----|----|----|----|----|------|-------|
| Dave Boswell, R<br>ERA: 3.27<br>(1, 1) | 8.0 | W   | 30 | 5 | 1 | 1  | 9  | 2  | 0   | 0   | 0   | 0  | 1  | 46 | 54 | 1.12 | 0.875 |
| Jim Perry, R<br>ERA: 3.66<br>(9, 1)    | 0.1 |     | 1  | 0 | 0 | 0  | 0  | 0  | 0   | 0   | 0   | 0  | 0  | 1  | 1  | 0.00 | 0.000 |
| Bill Pleis, L<br>ERA: 4.01<br>(9, 1)   | 0.1 | S   | 1  | 0 | 0 | 0  | 0  | 0  | 0   | 0   | 0   | 0  | 0  | 1  | 1  | 0.00 | 0.000 |
| Mudcat Grant, R<br>ERA: 3.84<br>(9, 1) | 0.1 | S   | 1  | 0 | 0 | 0  | 0  | 0  | 0   | 0   | 0   | 0  | 0  | 1  | 1  | 0.00 | 0.000 |

BOTTOM

Minnesota Twins @ Kansas City Athletics  
Municipal Stadium, Kansas City, MO  
Wed Sep 23 1964, 8:05 PM EDT  
Att. 2,048 - Unknown

|     |    |
|-----|----|
| AB  | 31 |
| R   | 1  |
| H   | 5  |
| RBI | 1  |
| BB  | 2  |
| SO  | 9  |
| LOB | 13 |



|       |        |       |        |
|-------|--------|-------|--------|
| 1B: 4 | SF: 0  | WP: 0 | PA: 33 |
| 2B: 0 | SAC: 0 | PB: 0 |        |
| 3B: 0 | DP: 1  | SB: 0 |        |
| HR: 1 | HBP: 0 | CS: 0 |        |

livebaseballscores.com

| Batter   | 1   | 2   | 3   | 4   | 5   | 6   | 7   | 8   | 9  | AB R H RBI BB SO LOB  | TOP                                     |  |
|--|---|---|---|---|---|---|---|---|--|---|---|--|
| Don Buford, S (1, 4)<br>OBP: 0.339, SLG: 0.353         | 0-0 SH<br>G6-4-3<br>1B                                | 0-0 1B<br>1-2<br>1B                                   |   | 0-0 1B  |   | 0-0 4-3<br>1-2 2-3<br>1B                            |   | 0-0 F9<br>2   |  | 5 1 3 0 0 0 2   |   |  |
| Floyd Robinson, L (1, 9)<br>OBP: 0.383, SLG: 0.412     | 0-0 SH<br>G6-4-3<br>1-3                               | 0-0 CS<br>1-3 2-H<br>1B                               |   | 0-0 1-3<br>3  |   | 0-0 G6-4-3<br>2-H 3-H<br>1B                         |   | 0-0 G3<br>3   |  | 4 0 2 3 0 0 1   |   |  |
| Ron Hansen, R (1, 6)<br>OBP: 0.339, SLG: 0.408         | 0-0 G6-4-3<br>1-2f<br>3-H                             | 0-3 K<br>1-2<br>2                                     |   |   | 0-0 HR  | 0-0 G6-4-3<br>1-2f                                  |   | 4-0 SH1-3<br>BB<br>BBB                              |  | 4 2 1 1 1 1 4   |   |  |
| Bill Skowron, R (1, 3)<br>OBP: 0.325, SLG: 0.435       | 0-0 4-3<br>3  |   | 0-0 5-3<br>1  |   | 0-0 G4-6-3<br>1B                                    |   | 0-0 HR  | 0-0 SH1-3<br>1-2<br>1                               |  | 3 0 1 0 0 0 0<br>1 1 1 1 0 0 0                              |   |  |
| Tom McCraw, L (5, PR)<br>OBP: 0.325, SLG: 0.375 (5, 3) |   |   |   |   |   |   |   |   |  |   |   |  |
| Pete Ward, L (1, 5)<br>OBP: 0.348, SLG: 0.470          |   | 0-0 HR<br>1B<br>1B                                    | 0-0 E1  |   | 0-0 G4-6-3<br>1-2f                                  |   | 0-0 1B  | 0-0 FC6-4<br>2-H<br>1B                              |  | 5 1 3 1 0 0 1   |   |  |
| Dave Nicholson, R (1, 7)<br>OBP: 0.329, SLG: 0.368     |   | 0-0 HR<br>1-2<br>1B                                   | 0-0 F3<br>2   |   | 0-0 HR  |   | 0-3 K<br>1  | 0-3 K<br>2  | 0-3 K<br>2   | 5 2 2 1 0 2 3   |   |  |
| Ken Berry, R (1, 8)<br>OBP: 0.455, SLG: 0.667          |   | 0-0 HR<br>1-H 2-H                                     | 0-0 F7<br>3   |   | 0-0 F3<br>3   |   | 0-3 K<br>2  | 0-0 FC6-4<br>1-2f<br>3                              |  | 5 1 1 3 0 1 4   |   |  |
| Cam Carreon, R (1, 2)<br>OBP: 0.318, SLG: 0.321        |   | 0-0 1B<br>1B<br>1B                                    |   | 0-0 E6<br>G4-6-3                                    |   | 0-0 4-3<br>1B<br>1B                                 | 0-3 K<br>3  |   |  | 4 2 2 0 0 1 1   |   |  |
| Juan Pizarro, L (1, 1)<br>OBP: 0.211, SLG: 0.318       |   | 0-3 K<br>1  |   | 0-0 G4-6-3<br>1-2f<br>1                             |   | 0-0 4-3<br>1B<br>1B                                 |   | 0-0 F6<br>1   |  | 4 1 1 0 0 1 2   |   |  |
| <b>Inning Stats</b>                                    | R: 1 H: 1<br>E: 1 LOB: 0<br>K: 0 BB: 0<br>S: 4 P: 4   | R: 4 H: 6<br>E: 0 LOB: 2<br>K: 2 BB: 0<br>S: 12 P: 12 | R: 0 H: 0<br>E: 1 LOB: 1<br>K: 0 BB: 0<br>S: 4 P: 4 | R: 0 H: 1<br>E: 1 LOB: 1<br>K: 0 BB: 0<br>S: 4 P: 4 | R: 2 H: 3<br>E: 0 LOB: 1<br>K: 0 BB: 0<br>S: 5 P: 5 | R: 2 H: 3<br>E: 0 LOB: 0<br>K: 0 BB: 0<br>S: 5 P: 5 | R: 1 H: 2<br>E: 0 LOB: 1<br>K: 3 BB: 0<br>S: 11 P: 11 | R: 0 H: 0<br>E: 0 LOB: 0<br>K: 0 BB: 0<br>S: 3 P: 3 | R: 1 H: 1<br>E: 0 LOB: 1<br>K: 1 BB: 1<br>S: 6 P: 10 | 1B: 13 SF: 0<br>2B: 1 SAC: 2<br>3B: 0 DP: 5<br>HR: 4 HBP: 0 | WP: 0 PA: 43<br>PB: 0<br>SB: 0<br>CS: 1 |  |
| <b>PITCHER</b>   | IP WLS BF H R ER SO BB IBB HBP BLK WP HR S P ERA WHIP |   |   |   |   |   |   |   |  |   |   |  |
| John O'Donoghue, L (1, 1)<br>ERA: 5.0                  | 1.0 L 8 5 5 5 0 0 0 0 0 0 0 1 8 8 45.00 5.000         |   |   |   |   |   |   |   |  |   |   |  |
| Jose Santiago, R (2, 1)<br>ERA: 4.81                   | 4.0 17 6 2 2 2 0 0 0 0 0 0 2 21 21 4.50 1.500         |   |   |   |   |   |   |   |  |   |   |  |
| Moe Drabowsky, R (6, 1)<br>ERA: 5.25                   | 2.0 10 5 3 3 3 0 0 0 0 0 0 1 16 16 13.50 2.500        |   |   |   |   |   |   |   |  |   |   |  |
| Ted Bowsfield, L (8, 1)<br>ERA: 4.43                   | 2.0 8 1 1 1 1 1 0 0 0 0 0 0 9 13 4.50 1.000           |   |   |   |   |   |   |   |  |   |   |  |

Chicago White Sox @ Kansas City Athletics  
Municipal Stadium, Kansas City, MO

Fri Sep 25 1964, 8:05 PM EDT  
Att. 3,758 - Unknown

|     |    |
|-----|----|
| AB  | 40 |
| R   | 11 |
| H   | 17 |
| RBI | 10 |
| BB  | 1  |
| SO  | 6  |
| LOB | 18 |



| Batter  | 1            | 2 | 3            | 4                    | 5                           | 6            | 7                            | 8           | 9                          | AB R H RBI BB SO LOB   |
|---|--------------|---|--------------|----------------------|-----------------------------|--------------|------------------------------|-------------|----------------------------|--|
| <b>Bert Campaneris, R</b><br>OBP: 0.309, SLG: 0.383<br>(1, 7)<br>(2, 6)   | 0-0 5-3<br>① |   |              | 0-0 6-3<br>①         | 0-3 K<br>③                  |              | 0-0 F9<br>③                  |             |                            | 4 0 0 0 0 1 4  |
| <b>Dick Green, R</b><br>OBP: 0.311, SLG: 0.395<br><b>Ken Harrelson, R</b><br>OBP: 0.259, SLG: 0.411<br>(1, 4)<br>(2, 7) | 0-0 5-3<br>② |   |              | 0-0 FC6-5<br>2B      |                             | 0-3 K<br>①   |                              | 0-3 K<br>①  |                            | 1 0 0 0 0 0 0<br>3 0 1 0 0 2 0   |
| <b>Rocky Colavito, R</b><br>OBP: 0.366, SLG: 0.516<br>(1, 9)  | 0-0 F7<br>③  |   |              | 0-0 FC6-5<br>BB<br>② |                             | 0-0 6-3<br>② |                              | 0-0 F7<br>② |                            | 4 0 0 0 0 0 1  |
| <b>Jim Gentile, L</b><br>OBP: 0.394, SLG: 0.489<br>(1, 3)   |              |   | 0-3 K<br>①   | 4-0<br>1-2 BB        |                             | 0-0 3-1<br>③ |                              | 0-0 G3<br>③ |                            | 3 0 0 0 1 1 0  |
| <b>Ed Charles, R</b><br>OBP: 0.324, SLG: 0.380<br>(1, 5)  |              |   | 0-0 F3<br>②  | 0-0 G3<br>③          |                             |              | 0-0 HR                       |             | 0-0 FC5-4<br>1B            | 4 1 2 1 0 0 2  |
| <b>Nelson Mathews, R</b><br>OBP: 0.295, SLG: 0.379<br>(1, 8)  |              |   | 0-0 F6<br>③  |                      | 0-0 F9<br>①                 |              | 0-0 BB<br>1B                 |             | 0-0 FC5-4<br>FC6-4<br>1-2f | 4 0 1 0 0 0 1  |
| <b>Wayne Causey, L</b><br>OBP: 0.392, SLG: 0.399<br>(1, 6)<br>(2, 4)  |              |   | 0-0 F7<br>①  |                      | 4-0<br>BB BB BB<br>1B<br>BB |              | 0-0 F7<br>①                  |             | 0-0 FC6-4<br>HR<br>1-2f    | 3 1 0 0 1 0 2  |
| <b>Dave Duncan, R</b><br>OBP: 0.148, SLG: 0.333<br>(1, 2)   |              |   | 0-0 F9<br>②  |                      | 0-0 F3<br>②                 |              | 0-0 F7<br>②                  |             | 0-0 HR<br>1-H              | 4 1 1 2 0 0 2  |
| <b>John O'Donoghue, R</b><br>OBP: 0.246, SLG: 0.302<br><b>Jose Santiago, R</b><br>(1, 1)<br>(2, 1)                      |              |   | 0-0 4-3<br>③ |                      | 0-0<br>1-2<br>1B            |              | 4-0<br>BB BB BB<br>1-2<br>BB |             | 0-0 F6<br>③                | 0 0 0 0 0 0 0<br>1 0 0 0 0 0 0<br>1 0 1 0 0 0 0<br>0 0 0 0 0 0 0<br>0 0 0 0 0 1 0 0<br>0 0 0 0 0 0 0 0<br>0 0 0 0 0 0 0 0<br>1 0 0 0 0 0 0 0 |

| BOTTOM  |   |      |        |      |        |      |        |      |        |      |        |      |        |      |        |       |        |       |        |        |      |        |      |        |      |        |      |        |      |        |      |        |      |        |      |        |       |        |       |  |      |       |      |       |      |       |      |       |      |       |      |       |      |       |      |       |       |       |       |  |      |      |      |      |      |      |      |       |      |      |      |      |      |      |      |      |       |        |       |  |   |         |    |     |    |   |   |    |    |    |     |     |     |    |    |   |   |     |      |   |     |   |    |   |   |   |   |   |   |   |   |   |   |    |    |      |       |
|---|---|------|--------|------|--------|------|--------|------|--------|------|--------|------|--------|------|--------|-------|--------|-------|--------|--------|------|--------|------|--------|------|--------|------|--------|------|--------|------|--------|------|--------|------|--------|-------|--------|-------|--|------|-------|------|-------|------|-------|------|-------|------|-------|------|-------|------|-------|------|-------|-------|-------|-------|--|------|------|------|------|------|------|------|-------|------|------|------|------|------|------|------|------|-------|--------|-------|--|---|---------|----|-----|----|---|---|----|----|----|-----|-----|-----|----|----|---|---|-----|------|---|-----|---|----|---|---|---|---|---|---|---|---|---|---|----|----|------|-------|
| <p><b>Chicago White Sox @ Kansas City Athletics</b><br/>Municipal Stadium, Kansas City, MO</p> <p>Fri Sep 25 1964, 8:05 PM EDT<br/>Att. 3,758 - Unknown</p>   |   |      |        |      |        |      |        |      |        |      |        |      |        |      |        |       |        |       |        |        |      |        |      |        |      |        |      |        |      |        |      |        |      |        |      |        |       |        |       |  |      |       |      |       |      |       |      |       |      |       |      |       |      |       |      |       |       |       |       |  |      |      |      |      |      |      |      |       |      |      |      |      |      |      |      |      |       |        |       |  |   |         |    |     |    |   |   |    |    |    |     |     |     |    |    |   |   |     |      |   |     |   |    |   |   |   |   |   |   |   |   |   |   |    |    |      |       |
| <p><b>AB 33</b><br/><b>R 3</b><br/><b>H 6</b><br/><b>RBI 3</b><br/><b>BB 3</b><br/><b>SO 4</b><br/><b>LOB 12</b></p>  |  |      |        |      |        |      |        |      |        |      |        |      |        |      |        |       |        |       |        |        |      |        |      |        |      |        |      |        |      |        |      |        |      |        |      |        |       |        |       |  |      |       |      |       |      |       |      |       |      |       |      |       |      |       |      |       |       |       |       |  |      |      |      |      |      |      |      |       |      |      |      |      |      |      |      |      |       |        |       |  |   |         |    |     |    |   |   |    |    |    |     |     |     |    |    |   |   |     |      |   |     |   |    |   |   |   |   |   |   |   |   |   |   |    |    |      |       |
| <p><b>Inning Stats</b></p> <table border="1"> <tr> <td>R: 0</td><td>H: 0</td><td>R: 0</td><td>H: 0</td><td>R: 0</td><td>H: 1</td><td>R: 0</td><td>H: 0</td><td>R: 0</td><td>H: 0</td><td>R: 0</td><td>H: 2</td><td>R: 0</td><td>H: 0</td><td>R: 2</td><td>H: 2</td><td>1B: 3</td><td>SF: 0</td><td>WP: 0</td><td>PA: 36</td> </tr> <tr> <td>E: 0</td><td>LOB: 0</td><td>E: 0</td><td>LOB: 0</td><td>E: 0</td><td>LOB: 2</td><td>E: 0</td><td>LOB: 2</td><td>E: 0</td><td>LOB: 0</td><td>E: 0</td><td>LOB: 2</td><td>E: 0</td><td>LOB: 0</td><td>E: 0</td><td>LOB: 0</td><td>2B: 1</td><td>SAC: 0</td><td>PB: 0</td><td></td> </tr> <tr> <td>K: 0</td><td>BB: 0</td><td>K: 1</td><td>BB: 0</td><td>K: 0</td><td>BB: 1</td><td>K: 0</td><td>BB: 1</td><td>K: 1</td><td>BB: 0</td><td>K: 0</td><td>BB: 1</td><td>K: 1</td><td>BB: 0</td><td>K: 0</td><td>BB: 0</td><td>3B: 0</td><td>DP: 0</td><td>SB: 0</td><td></td> </tr> <tr> <td>S: 3</td><td>P: 3</td><td>S: 5</td><td>P: 5</td><td>S: 3</td><td>P: 8</td><td>S: 4</td><td>P: 10</td><td>S: 5</td><td>P: 5</td><td>S: 5</td><td>P: 9</td><td>S: 5</td><td>P: 5</td><td>S: 5</td><td>P: 5</td><td>HR: 2</td><td>HBP: 0</td><td>CS: 0</td><td></td> </tr> </table> | R: 0  | H: 0 | R: 0   | H: 0 | R: 0   | H: 1 | R: 0   | H: 0 | R: 0   | H: 0 | R: 0   | H: 2 | R: 0   | H: 0 | R: 2   | H: 2  | 1B: 3  | SF: 0 | WP: 0  | PA: 36 | E: 0 | LOB: 0 | E: 0 | LOB: 0 | E: 0 | LOB: 2 | E: 0 | LOB: 2 | E: 0 | LOB: 0 | E: 0 | LOB: 2 | E: 0 | LOB: 0 | E: 0 | LOB: 0 | 2B: 1 | SAC: 0 | PB: 0 |  | K: 0 | BB: 0 | K: 1 | BB: 0 | K: 0 | BB: 1 | K: 0 | BB: 1 | K: 1 | BB: 0 | K: 0 | BB: 1 | K: 1 | BB: 0 | K: 0 | BB: 0 | 3B: 0 | DP: 0 | SB: 0 |  | S: 3 | P: 3 | S: 5 | P: 5 | S: 3 | P: 8 | S: 4 | P: 10 | S: 5 | P: 5 | S: 5 | P: 9 | S: 5 | P: 5 | S: 5 | P: 5 | HR: 2 | HBP: 0 | CS: 0 |  | <table border="1"> <thead> <tr> <th>PITCHER</th> <th>IP</th> <th>WLS</th> <th>BF</th> <th>H</th> <th>R</th> <th>ER</th> <th>SO</th> <th>BB</th> <th>IBB</th> <th>HBP</th> <th>BLK</th> <th>WP</th> <th>HR</th> <th>S</th> <th>P</th> <th>ERA</th> <th>WHIP</th> </tr> </thead> <tbody> <tr> <td><b>Juan Pizarro, L</b><br/>ERA: 2.54<br/>(1, 1)</td> <td>9.0</td> <td>W</td> <td>36</td> <td>6</td> <td>3</td> <td>3</td> <td>4</td> <td>3</td> <td>0</td> <td>0</td> <td>0</td> <td>0</td> <td>2</td> <td>41</td> <td>53</td> <td>3.00</td> <td>1.000</td> </tr> </tbody> </table> | PITCHER | IP | WLS | BF | H | R | ER | SO | BB | IBB | HBP | BLK | WP | HR | S | P | ERA | WHIP | <b>Juan Pizarro, L</b><br>ERA: 2.54<br>(1, 1) | 9.0 | W | 36 | 6 | 3 | 3 | 4 | 3 | 0 | 0 | 0 | 0 | 2 | 41 | 53 | 3.00 | 1.000 |
| R: 0  | H: 0  | R: 0 | H: 0   | R: 0 | H: 1   | R: 0 | H: 0   | R: 0 | H: 0   | R: 0 | H: 2   | R: 0 | H: 0   | R: 2 | H: 2   | 1B: 3 | SF: 0  | WP: 0 | PA: 36 |        |      |        |      |        |      |        |      |        |      |        |      |        |      |        |      |        |       |        |       |  |      |       |      |       |      |       |      |       |      |       |      |       |      |       |      |       |       |       |       |  |      |      |      |      |      |      |      |       |      |      |      |      |      |      |      |      |       |        |       |  |   |         |    |     |    |   |   |    |    |    |     |     |     |    |    |   |   |     |      |   |     |   |    |   |   |   |   |   |   |   |   |   |   |    |    |      |       |
| E: 0  | LOB: 0  | E: 0 | LOB: 0 | E: 0 | LOB: 2 | E: 0 | LOB: 2 | E: 0 | LOB: 0 | E: 0 | LOB: 2 | E: 0 | LOB: 0 | E: 0 | LOB: 0 | 2B: 1 | SAC: 0 | PB: 0 |        |        |      |        |      |        |      |        |      |        |      |        |      |        |      |        |      |        |       |        |       |  |      |       |      |       |      |       |      |       |      |       |      |       |      |       |      |       |       |       |       |  |      |      |      |      |      |      |      |       |      |      |      |      |      |      |      |      |       |        |       |  |   |         |    |     |    |   |   |    |    |    |     |     |     |    |    |   |   |     |      |   |     |   |    |   |   |   |   |   |   |   |   |   |   |    |    |      |       |
| K: 0  | BB: 0   | K: 1 | BB: 0  | K: 0 | BB: 1  | K: 0 | BB: 1  | K: 1 | BB: 0  | K: 0 | BB: 1  | K: 1 | BB: 0  | K: 0 | BB: 0  | 3B: 0 | DP: 0  | SB: 0 |        |        |      |        |      |        |      |        |      |        |      |        |      |        |      |        |      |        |       |        |       |  |      |       |      |       |      |       |      |       |      |       |      |       |      |       |      |       |       |       |       |  |      |      |      |      |      |      |      |       |      |      |      |      |      |      |      |      |       |        |       |  |   |         |    |     |    |   |   |    |    |    |     |     |     |    |    |   |   |     |      |   |     |   |    |   |   |   |   |   |   |   |   |   |   |    |    |      |       |
| S: 3  | P: 3  | S: 5 | P: 5   | S: 3 | P: 8   | S: 4 | P: 10  | S: 5 | P: 5   | S: 5 | P: 9   | S: 5 | P: 5   | S: 5 | P: 5   | HR: 2 | HBP: 0 | CS: 0 |        |        |      |        |      |        |      |        |      |        |      |        |      |        |      |        |      |        |       |        |       |  |      |       |      |       |      |       |      |       |      |       |      |       |      |       |      |       |       |       |       |  |      |      |      |      |      |      |      |       |      |      |      |      |      |      |      |      |       |        |       |  |   |         |    |     |    |   |   |    |    |    |     |     |     |    |    |   |   |     |      |   |     |   |    |   |   |   |   |   |   |   |   |   |   |    |    |      |       |
| PITCHER   | IP  | WLS  | BF     | H    | R      | ER   | SO     | BB   | IBB    | HBP  | BLK    | WP   | HR     | S    | P      | ERA   | WHIP   |       |        |        |      |        |      |        |      |        |      |        |      |        |      |        |      |        |      |        |       |        |       |  |      |       |      |       |      |       |      |       |      |       |      |       |      |       |      |       |       |       |       |  |      |      |      |      |      |      |      |       |      |      |      |      |      |      |      |      |       |        |       |  |   |         |    |     |    |   |   |    |    |    |     |     |     |    |    |   |   |     |      |   |     |   |    |   |   |   |   |   |   |   |   |   |   |    |    |      |       |
| <b>Juan Pizarro, L</b><br>ERA: 2.54<br>(1, 1)   | 9.0   | W    | 36     | 6    | 3      | 3    | 4      | 3    | 0      | 0    | 0      | 0    | 2      | 41   | 53     | 3.00  | 1.000  |       |        |        |      |        |      |        |      |        |      |        |      |        |      |        |      |        |      |        |       |        |       |  |      |       |      |       |      |       |      |       |      |       |      |       |      |       |      |       |       |       |       |  |      |      |      |      |      |      |      |       |      |      |      |      |      |      |      |      |       |        |       |  |   |         |    |     |    |   |   |    |    |    |     |     |     |    |    |   |   |     |      |   |     |   |    |   |   |   |   |   |   |   |   |   |   |    |    |      |       |

| Batter  | 1   | 2  | 3   | 4   | 5   | 6   | 7   | 8  | 9  | AB R H RBI BB SO LOB  | TOP                                     |  |         |   |
|---|---|--|---|---|---|---|---|--|--|---|---|--|---------|---|
| Don Buford, S<br>OBP: 0.342, SLG: 0.355 (1, 4)  | 0-0<br>E<br>1B<br>SF8<br>1B                           | 0-0<br>F8  |   | 0-0<br>WP<br>S<br>1B                                |   | 0-0<br>F8   |   |  | 0-0<br>1B<br>S<br>WP<br>1B                           | 5 3 3 1 0 0 4   |   |  |         |   |
| Floyd Robinson, L<br>OBP: 0.385, SLG: 0.413 (1, 9)<br>(9, 7)  | 0-0<br>E8<br>G1-4-3<br>1-3<br>1B                      |  | 0-0<br>5-3  | 4-0<br>2-H<br>1B                                    |   | 0-0<br>F8   |   |  | 0-0<br>1B<br>WP<br>G1-2-3<br>1B                      | 4 0 2 0 1 0 1   |   |  |         |   |
| Ron Hansen, R<br>OBP: 0.339, SLG: 0.408 (1, 6)  | 0-0<br>SF8<br>3-H<br>1B                               |  | 0-0<br>1B<br>1B                                     | 0-0<br>1-3  |   |   | 0-0<br>6-3  |  | 4-0<br>G1-2-3<br>1B<br>1-2<br>3-H<br>BB              | 3 0 1 1 1 0 1   |   |  |         |   |
| Bill Skowron, R<br>OBP: 0.326, SLG: 0.434 (1, 3)<br>Tom McCraw, L<br>OBP: 0.326, SLG: 0.375 (5, 3)  | 0-0<br>G1-4-3<br>1-2f<br>1B                           |  | 0-0<br>1-2<br>1B                                    | 0-0<br>6-3  |   | 0-0<br>F6   |   | 0-0<br>6-3   | 0-0<br>G1-2-3<br>1B<br>1-2<br>2-3                    | 3 0 1 0 0 0 1<br>2 0 1 0 0 0 0                              |   |  |         |   |
| Pete Ward, L<br>OBP: 0.347, SLG: 0.467 (1, 5)   |   | 0-0<br>1B<br>BB<br>1B                                | 0-0<br>F7   | 0-0<br>F7   |   | 0-0<br>F7   |   | 0-0<br>6-3   | 0-0<br>G1-2-3<br>1-2<br>2-3<br>3-Hf                  | 5 0 1 0 0 0 5   |   |  |         |   |
| Dave Nicholson, R<br>OBP: 0.329, SLG: 0.364 (1, 7)<br>Smoky Burgess, L<br>OBP: 0.307, SLG: 0.324 (9, PH)<br>Jim Landis, R<br>OBP: 0.305, SLG: 0.272 (9, PR)<br>(9, 8) |   | 4-0<br>1B<br>BB                                      | 0-0<br>4-3  | 0-3<br>K  |   | 0-3<br>K  |   | 0-3<br>K   | 4-0<br>IBB   | 3 0 0 0 1 2 2<br>0 0 0 0 1 0 0<br>0 0 0 0 0 0 0             |   |  |         |   |
| Ken Berry, R<br>OBP: 0.533, SLG: 0.667 (1, 8)<br>Mary Staehle, L<br>OBP: 0.400, SLG: 0.400 (9, PH)<br>Mike Hershberger, R<br>OBP: 0.304, SLG: 0.284 (9, 9)            |   | 0-0<br>1-2<br>2-3<br>1B                              | 0-0<br>4-3  | 0-0<br>4-3  |   | 0-0<br>SH3-4<br>2B<br>1B                            |   | 4-0<br>BB  | 0-0<br>1-3   | 3 1 2 0 1 0 0<br>1 0 0 0 0 0 3<br>0 0 0 0 0 0 0             |   |  |         |   |
| Cam Carreon, R<br>OBP: 0.322, SLG: 0.325 (1, 2)<br>J.C. Martin, L<br>OBP: 0.244, SLG: 0.282 (7, 2)  |   | 0-3<br>K   | 0-0<br>K<br>1B<br>1B                                | 0-0<br>G3<br>1B<br>1B                               |   | 0-0<br>SH3-4  |   | 0-0<br>F8  |  | 2 1 1 0 0 1 3<br>1 0 0 0 0 0 1                              |   |  |         |   |
| Gary Peters, L<br>OBP: 0.231, SLG: 0.373 (1, 1)<br>Hoyt Wilhelm, R<br>OBP: 0.190, SLG: 0.150 (7, 1)   |   | 0-0<br>F3  | 0-0<br>F3   | 0-0<br>G3   |   | 0-0<br>2B   |   | 0-3<br>K   |  | 3 0 1 1 0 0 4<br>1 0 0 0 0 1 1                              |   |  |         |   |
| Inning Stats  | R: 1 H: 2<br>E: 1 LOB: 0<br>K: 0 BB: 0<br>S: 4 P: 4   | R: 0 H: 2<br>E: 0 LOB: 3<br>K: 1 BB: 1<br>S: 7 P: 11 | R: 0 H: 2<br>E: 0 LOB: 2<br>K: 0 BB: 0<br>S: 5 P: 5 | R: 2 H: 2<br>E: 0 LOB: 1<br>K: 0 BB: 1<br>S: 5 P: 9 | R: 0 H: 0<br>E: 0 LOB: 0<br>K: 1 BB: 0<br>S: 5 P: 5 | R: 1 H: 2<br>E: 0 LOB: 1<br>K: 0 BB: 0<br>S: 5 P: 5 | R: 0 H: 0<br>E: 0 LOB: 0<br>K: 0 BB: 0<br>S: 3 P: 3 | R: 0 H: 0<br>E: 0 LOB: 1<br>K: 2 BB: 1<br>S: 7 P: 11 | R: 1 H: 3<br>E: 0 LOB: 3<br>K: 0 BB: 2<br>S: 5 P: 13 | 1B: 12 SF: 1<br>2B: 1 SAC: 1<br>3B: 0 DP: 2<br>HR: 0 HBP: 0 | WP: 2 PA: 43<br>PB: 0<br>SB: 2<br>CS: 0 |  |         |   |
| PITCHER   | IP WLS BF H R ER SO BB IBB HBP BLK WP HR S P ERA WHIP |  |   |   |   |   |   |  |  |   |   |  | PITCHER | IP WLS BF H R ER SO BB IBB HBP BLK WP HR S P ERA WHIP |
| Bob Meyer, L<br>ERA: 4.37 (1, 1)  | 3.2 L 19 8 3 2 1 1 0 0 0 0 0 0 20 24 4.91 2.455       |  |   |   |   |   |   |  |  |   |   |  |         |   |
| Orlando Pena, R<br>ERA: 4.37 (4, 1)   | 1.1 5 0 0 0 1 1 0 0 0 0 1 0 6 10 0.00 0.750           |  |   |   |   |   |   |  |  |   |   |  |         |   |
| John Wyatt, R<br>ERA: 3.72 (6, 1)   | 2.0 8 2 1 1 0 0 0 0 0 0 0 0 8 8 4.50 1.000            |  |   |   |   |   |   |  |  |   |   |  |         |   |
| Moe Drabowsky, R<br>ERA: 5.24 (8, 1)  | 2.0 11 3 1 1 2 2 1 0 0 0 1 0 12 24 4.50 2.500         |  |   |   |   |   |   |  |  |   |   |  |         |   |

Chicago White Sox @ Kansas City Athletics  
Municipal Stadium, Kansas City, MO  
Sat Sep 26 1964, 8:05 PM EDT  
Att. 2,508 - Unknown

|     |    |
|-----|----|
| AB  | 36 |
| R   | 5  |
| H   | 13 |
| RBI | 3  |
| BB  | 5  |
| SO  | 4  |
| LOB | 26 |



|       |        |
|-------|--------|
| WP: 2 | PA: 43 |
| PB: 0 |        |
| SB: 2 |        |
| CS: 0 |        |

| Batter   | 1   | 2                           | 3          | 4                           | 5                        | 6                          | 7               | 8          | 9                | AB | R | H | RBI | BB | SO | LOB |   |
|--|---|-----------------------------|------------|-----------------------------|--------------------------|----------------------------|-----------------|------------|------------------|----|---|---|-----|----|----|-----|---|
| Bert Campaneris, R<br>OBP: 0.308, SLG: 0.380<br>(1, 6)   | 0-0<br>1B<br>1B   |                             | 0-0<br>5-3 |                             | 0-0<br>1-3               |                            | 0-3<br>K        |            |                  | 4  | 0 | 1 | 0   | 0  | 1  | 1   |   |
| Wayne Causey, L<br>OBP: 0.390, SLG: 0.396<br>(1, 4)  | 0-0<br>F5   |                             | 0-0<br>F7  |                             |                          | 0-0<br>4-3                 |                 | 0-0<br>6-3 |                  | 4  | 0 | 0 | 0   | 0  | 0  | 1   |   |
| Ken Harrelson, R<br>OBP: 0.259, SLG: 0.406<br>(1, 7)   | 0-0<br>G6-4-3<br>1-3<br>1B  |                             | 0-0<br>F7  |                             |                          | 0-0<br>1-3                 |                 | 0-0<br>6-3 |                  | 4  | 0 | 1 | 0   | 0  | 0  | 0   |   |
| Rocky Colavito, R<br>OBP: 0.364, SLG: 0.513<br>(1, 9)  | 0-0<br>G6-4-3<br>1-2f   |                             |            | 0-0<br>F6                   |                          | 0-0<br>6-3                 |                 | 0-0<br>5-3 |                  | 4  | 0 | 0 | 0   | 0  | 0  | 2   |   |
| Jim Gentile, L<br>OBP: 0.387, SLG: 0.490<br>(1, 3)   |   | 4-0<br>BB<br>BB<br>BB<br>BB |            | 0-0<br>BB<br>1B             |                          |                            | 0-3<br>K        |            | 0-0<br>5-3<br>1B | 3  | 0 | 2 | 0   | 1  | 1  | 0   |   |
| Ed Charles, R<br>OBP: 0.325, SLG: 0.386<br>(1, 5)  |   | 0-0<br>G4-3<br>1-2f         |            | 4-0<br>BB<br>BB<br>BB<br>BB |                          | 0-0<br>G1-4-3<br>1-2<br>BB |                 | 0-0<br>HR  | 0-0<br>F3        | 3  | 1 | 1 | 1   | 1  | 0  | 2   |   |
| Nelson Mathews, R<br>OBP: 0.297, SLG: 0.384<br>(1, 8)  |   | 0-0<br>2B                   |            | 0-0<br>G1-4-3<br>1-2f       |                          |                            | 0-0<br>2B<br>2B |            | 0-0<br>5-3       | 4  | 1 | 2 | 0   | 0  | 0  | 3   |   |
| Dave Duncan, R<br>OBP: 0.194, SLG: 0.333<br>(1, 2)   |   | 4-0<br>BB<br>BB<br>BB       |            |                             | 0-0<br>4-3-2-4<br>1B     |                            | 0-3<br>K        |            | 0-0<br>5-3       | 3  | 0 | 1 | 0   | 1  | 1  | 2   |   |
| Bob Meyer, R<br>Orlando Pena, R<br>George Alusik, R<br>John Wyatt, R<br>Doc Edwards, R<br>Lew Krausse, R<br>Moe Drabowsky, R | (1, 1)<br>(4, 1)<br>(5, PH)<br>(6, 1)<br>(7, PH)<br>(7, PR)<br>(8, 1) | 0-3<br>K                    |            |                             | 0-0<br>6-4-3-2-4<br>1-2f |                            | 0-0<br>2B       |            |                  | 1  | 0 | 0 | 0   | 0  | 0  | 1   | 2 |

| Inning Stats | R: 0 | H: 2 | E: 0 | K: 0 | S: 4 | H: 1 | LOB: 1 | BB: 0 | P: 4 | R: 0 | H: 1 | E: 0 | K: 1 | S: 5 | H: 0 | LOB: 0 | BB: 0 | P: 3 | R: 0 | H: 1 | E: 0 | K: 0 | S: 3 | H: 0 | LOB: 0 | BB: 0 | P: 3 | R: 0 | H: 1 | E: 0 | K: 3 | S: 12 | H: 0 | LOB: 0 | BB: 0 | P: 3 | R: 2 | H: 3 | E: 0 | K: 3 | S: 12 | H: 0 | LOB: 1 | BB: 0 | P: 12 | R: 0 | H: 0 | E: 0 | K: 0 | S: 3 | H: 0 | LOB: 0 | BB: 0 | P: 3 | R: 0 | H: 1 | E: 0 | K: 0 | S: 4 | H: 1 | LOB: 1 | BB: 0 | P: 4 | 1B: 5 | 2B: 4 | 3B: 0 | HR: 1 | SF: 0 | SAC: 0 | DP: 4 | HBP: 0 | WP: 0 | PB: 0 | SB: 0 | CS: 0 | PA: 35 |
|--------------|------|------|------|------|------|------|--------|-------|------|------|------|------|------|------|------|--------|-------|------|------|------|------|------|------|------|--------|-------|------|------|------|------|------|-------|------|--------|-------|------|------|------|------|------|-------|------|--------|-------|-------|------|------|------|------|------|------|--------|-------|------|------|------|------|------|------|------|--------|-------|------|-------|-------|-------|-------|-------|--------|-------|--------|-------|-------|-------|-------|--------|
|--------------|------|------|------|------|------|------|--------|-------|------|------|------|------|------|------|------|--------|-------|------|------|------|------|------|------|------|--------|-------|------|------|------|------|------|-------|------|--------|-------|------|------|------|------|------|-------|------|--------|-------|-------|------|------|------|------|------|------|--------|-------|------|------|------|------|------|------|------|--------|-------|------|-------|-------|-------|-------|-------|--------|-------|--------|-------|-------|-------|-------|--------|

| PITCHER                                | IP  | WLS | BF | H | R | ER | SO | BB | IBB | HBP | BLK | WP | HR | S  | P  | ERA  | WHIP  |
|--|-----|-----|----|---|---|----|----|----|-----|-----|-----|----|----|----|----|------|-------|
| Gary Peters, L<br>ERA: 2.45<br>(1, 1)  | 6.2 | W   | 27 | 8 | 2 | 2  | 3  | 3  | 0   | 0   | 0   | 0  | 1  | 30 | 42 | 2.70 | 1.650 |
| Hoyt Wilhelm, R<br>ERA: 2.11<br>(7, 1) | 2.1 | S   | 8  | 1 | 0 | 0  | 1  | 0  | 0   | 0   | 0   | 0  | 0  | 10 | 10 | 0.00 | 0.429 |

**BOTTOM**

**Chicago White Sox @ Kansas City Athletics**  
Municipal Stadium, Kansas City, MO

Sat Sep 26 1964, 8:05 PM EDT  
Att. 2,508 - Unknown

|     |    |
|-----|----|
| AB  | 32 |
| R   | 2  |
| H   | 9  |
| RBI | 2  |
| BB  | 3  |
| SO  | 4  |
| LOB | 14 |



| Batter  | 1   | 2   | 3  | 4   | 5  | 6   | 7   | 8   | 9   | AB R H RBI BB SO LOB            | TOP   |                                 |                              |                                 |                              |                                 |                              |                                 |                                  |                                    |                                  |        |
|---|---|---|--|---|--|---|---|---|---|---------------------------------|---|---------------------------------|------------------------------|---------------------------------|------------------------------|---------------------------------|------------------------------|---------------------------------|----------------------------------|------------------------------------|----------------------------------|--------|
| Mike Hershberger, R<br>OBP: 0.305, SLG: 0.284<br>(1, 9) X   | 0-0<br>FC6-4<br>1B  | 4-0<br>FC4-2 BB<br>1-2 2-3 BB   | 0-3<br>K   |   | 0-3<br>K   |   | 0-0<br>6-3                                    |   |   | 4 1 1 0 1 2 4                   |   |                                 |                              |                                 |                              |                                 |                              |                                 |                                  |                                    |                                  |        |
| Don Buford, S<br>OBP: 0.342, SLG: 0.357<br>(1, 4) X   | 0-0<br>FC6-4 WP<br>1-4-3 1B<br>1-2f   | 4-0<br>BB FC4-2<br>1-2 2-3 BB<br>3-H  |  | 0-0<br>4-3  |  | 0-0<br>4-3<br>2B  |   | 0-0<br>F9   |   | 4 1 1 1 1 0 1                   |   |                                 |                              |                                 |                              |                                 |                              |                                 |                                  |                                    |                                  |        |
| Floyd Robinson, L<br>OBP: 0.383, SLG: 0.411<br>(1, 7) X   | 0-0<br>1-4-3<br>1-3   | 0-0<br>FC4-2 BB<br>1-2 2-3 BB<br>3-Hf   |  | 0-0<br>S<br>1B  |  | 0-0<br>F9   |   | 0-0<br>6-3  |   | 5 0 1 0 0 0 5                   |   |                                 |                              |                                 |                              |                                 |                              |                                 |                                  |                                    |                                  |        |
| Pete Ward, L<br>OBP: 0.347, SLG: 0.465<br>(1, 5) X  | 0-0<br>1B<br>3-H  | 4-0<br>1B BB<br>1-2 2-3 BB<br>3-H   |  | 0-3<br>K<br>1-2   |  | 0-0<br>4-3<br>2-3   |   | 0-0<br>4-3  |   | 4 0 1 2 1 1 2                   |   |                                 |                              |                                 |                              |                                 |                              |                                 |                                  |                                    |                                  |        |
| Tom McCraw, L<br>OBP: 0.325, SLG: 0.371<br>(1, 3) X   | 0-0<br>3-1  | 0-0<br>F5   |  | 0-3<br>K  |  | 4-0<br>BB   |   | 0-0<br>F8   |   | 4 0 0 0 1 1 5                   |   |                                 |                              |                                 |                              |                                 |                              |                                 |                                  |                                    |                                  |        |
| Ron Hansen, R<br>OBP: 0.338, SLG: 0.406<br>(1, 6)   |   |   |  |   |  | 0-0<br>6-3  |   | 0-0<br>5-3  |   | 5 1 1 0 0 1 5                   |   |                                 |                              |                                 |                              |                                 |                              |                                 |                                  |                                    |                                  |        |
| Ken Berry, R<br>OBP: 0.500, SLG: 0.563<br>(1, 8)  |   | 0-0<br>E<br>1B<br>1-2 1B  | 0-0<br>L4  |   | 0-0<br>F7  |   | 4-0<br>SH3-4 BB                               |   | 0-0<br>F8   | 4 1 1 0 1 0 0                   | AB 36<br>R 5<br>H 10<br>RBI 5<br>BB 5<br>SO 5<br>LOB 25 |                                 |                              |                                 |                              |                                 |                              |                                 |                                  |                                    |                                  |        |
| Cam Carreon, R<br>OBP: 0.330, SLG: 0.333<br>(1, 2)  |   | 0-0<br>E1<br>BB 1B<br>1-2 BB<br>2-3   | 0-0<br>SH3-4<br>1B   |   | 0-0<br>1B<br>1B  |   | 0-0<br>F7                                     |   |   | 4 1 2 0 0 0 3                   |   |                                 |                              |                                 |                              |                                 |                              |                                 |                                  |                                    |                                  |        |
| Joe Horlen, R<br>OBP: 0.191, SLG: 0.167<br>(1, 1)   |   | 0-0<br>BB BB<br>1-2 FC4-2<br>2-H 3-H 1B   | 0-0<br>SH3-4   |   | 0-0<br>1B  |   | 0-0<br>SH3-4                                  |   |   | 2 0 2 2 0 0 0                   |   |                                 |                              |                                 |                              |                                 |                              |                                 |                                  |                                    |                                  |        |
| Inning Stats  | R: 1<br>E: 1<br>K: 0<br>S: 5  | H: 2<br>LOB: 1<br>BB: 0<br>P: 5   | R: 4<br>E: 1<br>K: 0<br>S: 7   | H: 3<br>LOB: 3<br>BB: 3<br>P: 19  | R: 0<br>E: 0<br>K: 1<br>S: 6   | H: 1<br>LOB: 1<br>BB: 0<br>P: 6   | R: 0<br>E: 0<br>K: 2<br>S: 8                  | H: 1<br>LOB: 1<br>BB: 0<br>P: 8   | R: 0<br>E: 0<br>K: 1<br>S: 7  | H: 2<br>LOB: 2<br>BB: 0<br>P: 7 | R: 0<br>E: 0<br>K: 0<br>S: 4                            | H: 1<br>LOB: 2<br>BB: 1<br>P: 8 | R: 0<br>E: 0<br>K: 0<br>S: 3 | H: 0<br>LOB: 1<br>BB: 1<br>P: 7 | R: 0<br>E: 0<br>K: 0<br>S: 3 | H: 0<br>LOB: 0<br>BB: 0<br>P: 3 | R: 0<br>E: 0<br>K: 1<br>S: 5 | H: 0<br>LOB: 0<br>BB: 0<br>P: 5 | 1B: 9<br>2B: 1<br>3B: 0<br>HR: 0 | SF: 0<br>SAC: 2<br>DP: 0<br>HBP: 0 | WP: 1<br>PB: 0<br>SB: 1<br>CS: 0 | PA: 43 |
| PITCHER<br>Blue Moon Odom, R<br>ERA: 10.06<br>Jose Santiago, R<br>ERA: 4.69<br>Diego Segui, R<br>ERA: 4.46<br>John Wyatt, R<br>ERA: 3.66<br>Ted Bowsfield, L<br>ERA: 4.39 | IP<br>WLS<br>BF<br>H<br>R<br>ER<br>SO<br>BB<br>IBB<br>HBP<br>BLK<br>WP<br>HR<br>S<br>P<br>ERA<br>WHIP | 1.0<br>L<br>11<br>5<br>5<br>3<br>0<br>2<br>0<br>0<br>0<br>1<br>0<br>9<br>17<br>27.00<br>7.000 | 2.0<br>8<br>1<br>0<br>0<br>1<br>1<br>0<br>0<br>0<br>0<br>0<br>9<br>13<br>0.00<br>1.000 | 4.0<br>9<br>3<br>0<br>0<br>3<br>0<br>0<br>0<br>0<br>0<br>0<br>15<br>15<br>0.00<br>1.500 | 6.0<br>9<br>1<br>0<br>0<br>0<br>2<br>0<br>0<br>0<br>0<br>0<br>7<br>15<br>0.00<br>1.500 | 8.0<br>3<br>0<br>0<br>0<br>0<br>0<br>0<br>0<br>0<br>0<br>0<br>3<br>3<br>0.00<br>0.000 | PITCHER<br>Wes Stock, R<br>ERA: 2.3<br>(9, 1) | IP<br>WLS<br>BF<br>H<br>R<br>ER<br>SO<br>BB<br>IBB<br>HBP<br>BLK<br>WP<br>HR<br>S<br>P<br>ERA<br>WHIP | 1.0<br>3<br>0<br>0<br>0<br>0<br>1<br>0<br>0<br>0<br>0<br>0<br>5<br>5<br>0.00<br>0.000 |                                 |   |                                 |                              |                                 |                              |                                 |                              |                                 |                                  |                                    |                                  |        |

Chicago White Sox @ Kansas City Athletics  
Municipal Stadium, Kansas City, MO  
Sun Sep 27 1964, 4:33 AM EDT  
Att. 4,903 - Unknown

livebaseballscorecards.com



| Batter  | 1         | 2        | 3                         | 4          | 5          | 6                   | 7          | 8          | 9                 | AB | R | H | RBI | BB | SO | LOB |
|---|-----------|----------|---------------------------|------------|------------|---------------------|------------|------------|-------------------|----|---|---|-----|----|----|-----|
| Bert Campaneris, R<br>OBP: 0.307, SLG: 0.378<br>(1, 6)  | 0-3<br>K  |          | 0-0<br>BB E<br>1-3<br>1B  |            | 0-0<br>2-3 |                     |            | 0-0<br>F8  |                   | 4  | 0 | 1 | 0   | 0  | 1  | 0   |
| Wayne Causey, L<br>OBP: 0.387, SLG: 0.394<br>(1, 4)   | 0-0<br>L4 |          | 0-0<br>SF8                |            | 0-0<br>4-3 |                     |            | 0-0<br>F7  |                   | 3  | 0 | 0 | 1   | 0  | 0  | 0   |
| Larry Stahl, L<br>OBP: 0.333, SLG: 0.389<br>(1, 8)  | 0-0<br>1B |          | 0-0<br>E3<br>1-2<br>BB    |            |            | 0-0<br>4-3          |            |            | 0-0<br>WP E<br>1B | 4  | 1 | 2 | 0   | 0  | 0  | 1   |
| Rocky Colavito, R<br>OBP: 0.366, SLG: 0.513<br>(1, 9)   | 0-0<br>1B |          | 4-0<br>BB                 |            |            | 0-0<br>G6-4-3<br>1B |            |            | 0-0<br>E5<br>1B   | 3  | 1 | 2 | 0   | 1  | 0  | 1   |
| Jim Gentile, L<br>OBP: 0.387, SLG: 0.490<br>Ken Harrelson, R<br>OBP: 0.252, SLG: 0.394<br>(1, 3)  |           | 0-3<br>K | 0-0<br>F3                 |            |            | 0-0<br>G6-4-3       |            |            | 0-0<br>1-3        | 0  | 0 | 0 | 0   | 0  | 0  | 0   |
| Ed Charles, R<br>OBP: 0.324, SLG: 0.385<br>(1, 5)   |           | 0-3<br>K |                           | 0-0<br>6-3 |            |                     | 0-3<br>K   |            | 0-0<br>5-3<br>1B  | 4  | 0 | 1 | 2   | 0  | 2  | 0   |
| Tommie Reynolds, R<br>OBP: 0.291, SLG: 0.276<br>(1, 7)  |           | 0-3<br>K |                           | 0-3<br>K   |            |                     | 0-0<br>6-3 |            | 0-0<br>5-3        | 4  | 0 | 0 | 0   | 0  | 2  | 1   |
| Dave Duncan, R<br>OBP: 0.200, SLG: 0.324<br>(1, 2)  |           |          | 0-0<br>FC4-6<br>1B        |            | 0-0<br>5-3 |                     | 0-0<br>F3  |            | 0-0<br>1-3        | 4  | 0 | 1 | 0   | 0  | 0  | 1   |
| Blue Moon Odum, R<br>Jose Santiago, R<br>Jose Tartabull, L<br>Diego Segura, R<br>Manny Jimenez, L<br>John Wyatt, R<br>Ted Bowfield, R<br>Billy Bryan, L<br>Wes Stock, R<br>(1, 1) |           |          | 0-0<br>FC4-6<br>1B<br>SF8 |            |            | 0-0<br>F9           |            | 0-0<br>4-3 |                   | 0  | 0 | 0 | 0   | 0  | 0  | 0   |

| Inning Stats                                    | R: 0 | H: 2 | E: 0 | LOB: 2 | K: 1 | BB: 0 | S: 6 | P: 6 | R: 0 | H: 0 | E: 0 | LOB: 0 | K: 3 | BB: 0 | S: 9 | P: 9 | R: 1 | H: 2 | E: 1 | LOB: 3 | K: 0 | BB: 1 | S: 6 | P: 10 | R: 0 | H: 0 | E: 0 | LOB: 0 | K: 1 | BB: 0 | S: 5 | P: 5 | R: 0 | H: 1 | E: 0 | LOB: 0 | K: 0 | BB: 0 | S: 3 | P: 3 | R: 0 | H: 0 | E: 0 | LOB: 0 | K: 1 | BB: 0 | S: 5 | P: 5 | R: 0 | H: 0 | E: 0 | LOB: 0 | K: 0 | BB: 0 | S: 3 | P: 3 | R: 2 | H: 2 | E: 1 | LOB: 1 | K: 0 | BB: 0 | S: 6 | P: 6 | 1B: 7 | SF: 1 | 2B: 0 | SAC: 0 | 3B: 0 | DP: 1 | HR: 0 | HBP: 0 | WP: 1 | PA: 35 |
|---|------|------|------|--------|------|-------|------|------|------|------|------|--------|------|-------|------|------|------|------|------|--------|------|-------|------|-------|------|------|------|--------|------|-------|------|------|------|------|------|--------|------|-------|------|------|------|------|------|--------|------|-------|------|------|------|------|------|--------|------|-------|------|------|------|------|------|--------|------|-------|------|------|-------|-------|-------|--------|-------|-------|-------|--------|-------|--------|
| PITCHER<br>Joe Horlen, R<br>ERA: 1.96<br>(1, 1) | IP   | WLS  | BF   | H      | R    | ER    | SO   | BB   | IBB  | HBP  | BLK  | WP     | HR   | S     | P    | ERA  | WHIP | IP   | WLS  | BF     | H    | R     | ER   | SO    | BB   | IBB  | HBP  | BLK    | WP   | HR    | S    | P    | ERA  | WHIP | IP   | WLS    | BF   | H     | R    | ER   | SO   | BB   | IBB  | HBP    | BLK  | WP    | HR   | S    | P    | ERA  | WHIP |        |      |       |      |      |      |      |      |        |      |       |      |      |       |       |       |        |       |       |       |        |       |        |

**BOTTOM**

**Chicago White Sox @ Kansas City Athletics**  
Municipal Stadium, Kansas City, MO

Sun Sep 27 1964, 4:33 AM EDT  
Att. 4,903 - Unknown

livebaseballscorecards.com

**AB 33**  
**R 3**  
**H 7**  
**RBI 3**  
**BB 1**  
**SO 6**  
**LOB 11**



| Batter   | 1                             | 2                                | 3                            | 4                               | 5                            | 6                               | 7                            | 8                               | 9                            | 10                               | 11                           | 12                              | 13                           | 14                              | 15                           | AB                              | R                            | H                                | RBI                          | BB                              | SO                           | LOB                             | TOP                              |                                    |                                  |        |
|--|-------------------------------|----------------------------------|------------------------------|---------------------------------|------------------------------|---------------------------------|------------------------------|---------------------------------|------------------------------|----------------------------------|------------------------------|---------------------------------|------------------------------|---------------------------------|------------------------------|---------------------------------|------------------------------|----------------------------------|------------------------------|---------------------------------|------------------------------|---------------------------------|----------------------------------|------------------------------------|----------------------------------|--------|
| Bert Campaneris, R<br>OBP: 0.310, SLG: 0.388   | 0-0<br>HR<br>2B               | 0-0<br>F4                        |                              |                                 | 0-0<br>1-3                   |                                 | 0-0<br>5-3                   |                                 | 0-0<br>2B                    |                                  | 0-0<br>1B                    |                                 |                              | 0-3<br>K                        |                              | 7                               | 1                            | 3                                | 2                            | 0                               | 1                            | 1                               |                                  |                                    |                                  |        |
| Wayne Causey, L<br>OBP: 0.385, SLG: 0.390  | 0-0<br>F5                     |                                  | 0-0<br>F9                    |                                 | 4-0<br>HR<br>BB              |                                 | 0-0<br>1-3                   |                                 | 0-0<br>F8                    |                                  | 0-0<br>F6                    |                                 |                              | 0-3<br>K                        |                              | 6                               | 1                            | 0                                | 0                            | 1                               | 1                            | 5                               |                                  |                                    |                                  |        |
| Larry Stahl, L<br>OBP: 0.360, SLG: 0.625   | 0-0<br>HR                     |                                  | 4-0<br>G5-4-3<br>BB          |                                 | 0-0<br>HR                    |                                 | 0-0<br>4-3                   |                                 | 0-0<br>K                     |                                  | 0-0<br>F9                    |                                 |                              | 0-0<br>1-3                      |                              | 6                               | 2                            | 2                                | 4                            | 1                               | 1                            | 0                               |                                  |                                    |                                  |        |
| Rocky Colavito, R<br>OBP: 0.369, SLG: 0.518  | 0-0<br>1B                     |                                  | 0-0<br>G5-4-3                |                                 | 0-0<br>4-3                   |                                 | 0-0<br>F4                    |                                 | 0-0<br>BB                    |                                  | 0-0<br>BB                    |                                 | 4-0<br>CS<br>BB              |                                 | HR                           | 5                               | 1                            | 2                                | 1                            | 2                               | 0                            | 1                               |                                  |                                    |                                  |        |
| Jim Gentile, L<br>OBP: 0.384, SLG: 0.483   | 0-3<br>K                      |                                  | 0-0<br>F5                    |                                 | 0-0<br>F5                    |                                 | 4-6<br>5-3<br>BB             |                                 | 0-0<br>F2                    |                                  | 0-0<br>F4                    |                                 | 0-3<br>K                     |                                 | 0-0<br>F8                    | 6                               | 0                            | 0                                | 0                            | 1                               | 2                            | 3                               |                                  |                                    |                                  |        |
| Ed Charles, R<br>OBP: 0.322, SLG: 0.382  | 0-3<br>K                      |                                  | 0-0<br>1B                    |                                 | 0-0<br>1B                    |                                 | 0-0<br>5-3                   |                                 | 0-0<br>6-3                   |                                  | 0-0<br>F4                    |                                 | 0-0<br>F9                    |                                 | 0-0<br>F8                    | 7                               | 0                            | 1                                | 0                            | 0                               | 1                            | 3                               |                                  |                                    |                                  |        |
| Tommy Reynolds, R<br>OBP: 0.290, SLG: 0.268  |                               | 0-0<br>5-3<br>1B                 |                              | 0-0<br>F7                       |                              | 0-3<br>K                        |                              | 4-0<br>WP<br>2B<br>BB           |                              | 0-0<br>6-3                       |                              | 0-3<br>K                        |                              | 0-0<br>F8                       | 6                            | 1                               | 1                            | 0                                | 1                            | 2                               | 2                            |                                 |                                  |                                    |                                  |        |
| Dave Duncan, R<br>OBP: 0.184, SLG: 0.297   |                               | 0-0<br>5-3                       |                              | 0-3<br>K                        |                              | 0-3<br>K                        |                              | 0-0<br>WP<br>2B<br>1B           |                              | 0-0<br>4-3                       |                              | 4-0<br>BB<br>BB                 |                              |                                 |                              | 3                               | 0                            | 0                                | 0                            | 0                               | 2                            | 3                               |                                  |                                    |                                  |        |
| Billy Bryan, L<br>OBP: 0.289, SLG: 0.479   |                               | 1-2                              |                              | 0-0<br>K                        |                              | 0-3<br>K                        |                              | 1-2<br>2B<br>1B                 |                              | 0-0<br>4-3                       |                              | 0-0<br>BB                       |                              |                                 |                              | 1                               | 0                            | 1                                | 0                            | 0                               | 0                            | 0                               |                                  |                                    |                                  |        |
| Nelson Mathews, R<br>OBP: 0.297, SLG: 0.384  |                               | 0-3<br>K                         |                              | 0-0<br>K                        |                              | 0-0<br>6-3                      |                              | 0-3<br>K                        |                              | 0-3<br>1B<br>BB                  |                              | 0-3<br>K                        |                              |                                 |                              | 0                               | 1                            | 0                                | 0                            | 0                               | 0                            | 0                               |                                  |                                    |                                  |        |
| Doc Edwards, R<br>OBP: 0.261, SLG: 0.306   |                               | 0-3<br>K                         |                              | 0-0<br>K                        |                              | 0-0<br>6-3                      |                              | 0-0<br>K                        |                              | 0-3<br>1B<br>BB                  |                              | 0-3<br>K                        |                              |                                 |                              | 1                               | 0                            | 0                                | 0                            | 0                               | 1                            | 1                               |                                  |                                    |                                  |        |
| Law Krieger, R<br>John Wyatt, R<br>Jose Tatis, L<br>Mike D'Onofrio, R<br>Jose Santiago, R<br>George Alcock, R<br>Bud Boggs, L<br>Henry Jimenez, L<br>Wes Stock, R<br>Ken Hargrett, R<br>John O'Donoghue, R |                               | 0-0<br>K                         |                              | 0-0<br>G3                       |                              | 0-0<br>6-3                      |                              | 0-0<br>K                        |                              | 0-0<br>1B<br>BB                  |                              | 0-0<br>K                        |                              |                                 |                              | 1                               | 0                            | 0                                | 0                            | 0                               | 1                            | 1                               |                                  |                                    |                                  |        |
| Inning Stats   | R: 2<br>E: 0<br>K: 2<br>S: 10 | H: 3<br>LOB: 1<br>BB: 0<br>P: 10 | R: 0<br>E: 0<br>K: 1<br>S: 6 | H: 1<br>LOB: 1<br>BB: 0<br>P: 6 | R: 0<br>E: 0<br>K: 1<br>S: 6 | H: 1<br>LOB: 1<br>BB: 0<br>P: 6 | R: 0<br>E: 0<br>K: 0<br>S: 4 | H: 0<br>LOB: 0<br>BB: 1<br>P: 8 | R: 0<br>E: 0<br>K: 0<br>S: 7 | H: 0<br>LOB: 1<br>BB: 1<br>P: 11 | R: 0<br>E: 0<br>K: 0<br>S: 3 | H: 0<br>LOB: 0<br>BB: 0<br>P: 3 | R: 0<br>E: 0<br>K: 1<br>S: 5 | H: 0<br>LOB: 1<br>BB: 1<br>P: 9 | R: 0<br>E: 0<br>K: 1<br>S: 4 | H: 0<br>LOB: 1<br>BB: 1<br>P: 8 | R: 0<br>E: 0<br>K: 2<br>S: 7 | H: 0<br>LOB: 1<br>BB: 1<br>P: 11 | R: 0<br>E: 0<br>K: 2<br>S: 7 | H: 0<br>LOB: 1<br>BB: 1<br>P: 7 | R: 1<br>E: 0<br>K: 0<br>S: 4 | H: 1<br>LOB: 0<br>BB: 0<br>P: 4 | 1B: 5<br>2B: 2<br>3B: 0<br>HR: 3 | SF: 0<br>SAC: 0<br>DP: 1<br>HBP: 0 | WP: 1<br>PB: 0<br>SB: 0<br>CS: 1 | PA: 61 |
| PITCHER  | IP                            | WLS                              | BF                           | H                               | R                            | ER                              | SO                           | BB                              | IBB                          | HBP                              | BLK                          | WP                              | HR                           | S                               | P                            | ERA                             | WHIP                         |                                  |                              |                                 |                              |                                 |                                  |                                    |                                  |        |
| Dave Boswell, R<br>ERA: 4.5  | (1, 1)                        | 5.0                              | 22                           | 6                               | 4                            | 4                               | 4                            | 2                               | 0                            | 0                                | 0                            | 0                               | 2                            | 28                              | 36                           | 7.20                            | 1.600                        |                                  |                              |                                 |                              |                                 |                                  |                                    |                                  |        |
| Jim Perry, R<br>ERA: 3.61  | (6, 1)                        | 3.1                              | 12                           | 0                               | 1                            | 1                               | 2                            | 2                               | 0                            | 0                                | 0                            | 0                               | 0                            | 14                              | 22                           | 2.70                            | 0.600                        |                                  |                              |                                 |                              |                                 |                                  |                                    |                                  |        |
| Al Worthington, R<br>ERA: 2.2  | (9, 1)                        | 0.1                              | 3                            | 2                               | 1                            | 1                               | 1                            | 0                               | 0                            | 0                                | 0                            | 1                               | 0                            | 5                               | 5                            | 27.00                           | 6.000                        |                                  |                              |                                 |                              |                                 |                                  |                                    |                                  |        |
| Bill Pleis, L<br>ERA: 3.91   | (9, 1)                        | 1.1                              | 5                            | 0                               | 0                            | 0                               | 1                            | 1                               | 0                            | 0                                | 0                            | 0                               | 0                            | 6                               | 10                           | 0.00                            | 0.750                        |                                  |                              |                                 |                              |                                 |                                  |                                    |                                  |        |
| Johnny Klippstein, R<br>ERA: 2.89  | (11, 1)                       | 0.2                              | 4                            | 1                               | 0                            | 0                               | 0                            | 1                               | 0                            | 0                                | 0                            | 0                               | 0                            | 3                               | 7                            | 0.00                            | 3.000                        |                                  |                              |                                 |                              |                                 |                                  |                                    |                                  |        |
| PITCHER  | IP                            | WLS                              | BF                           | H                               | R                            | ER                              | SO                           | BB                              | IBB                          | HBP                              | BLK                          | WP                              | HR                           | S                               | P                            | ERA                             | WHIP                         |                                  |                              |                                 |                              |                                 |                                  |                                    |                                  |        |
| Gerry Arrigo, L<br>ERA: 3.93   | (11, 1)                       | 1.1                              | 4                            | 0                               | 0                            | 0                               | 1                            | 1                               | 0                            | 0                                | 0                            | 0                               | 0                            | 5                               | 9                            | 0.00                            | 0.750                        |                                  |                              |                                 |                              |                                 |                                  |                                    |                                  |        |
| Dwight Siebler, R<br>ERA: 5.23   | (13, 1)                       | 2.0                              | 7                            | 0                               | 0                            | 0                               | 4                            | 1                               | 0                            | 0                                | 0                            | 0                               | 0                            | 14                              | 18                           | 0.00                            | 0.500                        |                                  |                              |                                 |                              |                                 |                                  |                                    |                                  |        |
| Jim Kaat, L<br>ERA: 3.18   | (15, 1)                       | 1.0                              | 4                            | 1                               | 1                            | 1                               | 0                            | 0                               | 0                            | 0                                | 0                            | 0                               | 1                            | 4                               | 4                            | 9.00                            | 1.000                        |                                  |                              |                                 |                              |                                 |                                  |                                    |                                  |        |

Kansas City Athletics @ Minnesota Twins  
Metropolitan Stadium, Bloomington, MI  
Tue Sep 29 1964, 4:33 AM EDT  
Att. 2,999 - Unknown

|     |    |
|-----|----|
| AB  | 53 |
| R   | 7  |
| H   | 10 |
| RBI | 7  |
| BB  | 8  |
| SO  | 13 |
| LOB | 22 |







| Batter  | 1                            | 2                               | 3                            | 4                               | 5                            | 6                               | 7                             | 8                                | 9                            | AB R H RBI BB SO LOB            | TOP                          |                                 |                              |                                 |                              |                                 |                              |                                 |                              |                                 |                                  |                                    |                                  |        |    |     |     |     |    |    |   |   |     |      |
|---|------------------------------|---------------------------------|------------------------------|---------------------------------|------------------------------|---------------------------------|-------------------------------|----------------------------------|------------------------------|---------------------------------|------------------------------|---------------------------------|------------------------------|---------------------------------|------------------------------|---------------------------------|------------------------------|---------------------------------|------------------------------|---------------------------------|----------------------------------|------------------------------------|----------------------------------|--------|----|-----|-----|-----|----|----|---|---|-----|------|
| Bert Campaneris, R (1, 6)<br>OBP: 0.306, SLG: 0.382   | 0-0<br>F7                    |                                 | 0-0<br>F7                    |                                 | 0-0<br>G1-6-3                |                                 |                               | 0-0<br>6-3                       |                              | 4 0 0 0 0 0 1                   |                              |                                 |                              |                                 |                              |                                 |                              |                                 |                              |                                 |                                  |                                    |                                  |        |    |     |     |     |    |    |   |   |     |      |
| Wayne Causey, L (1, 4)<br>OBP: 0.383, SLG: 0.388      | 0-0<br>6-3                   |                                 |                              | 0-0<br>6-3                      |                              | 0-0<br>4-3                      |                               | 0-0<br>6-3                       |                              | 4 0 0 0 0 0 0                   |                              |                                 |                              |                                 |                              |                                 |                              |                                 |                              |                                 |                                  |                                    |                                  |        |    |     |     |     |    |    |   |   |     |      |
| Larry Stahl, L (1, 8)<br>OBP: 0.379, SLG: 0.607       | 0-0<br>F8                    |                                 |                              | 0-0<br>1B<br>1B                 |                              | 0-0<br>6-3                      |                               |                                  | 0-0<br>1B                    | 4 1 2 0 0 0 0                   |                              |                                 |                              |                                 |                              |                                 |                              |                                 |                              |                                 |                                  |                                    |                                  |        |    |     |     |     |    |    |   |   |     |      |
| Rocky Colavito, R (1, 9)<br>OBP: 0.368, SLG: 0.516    |                              | 0-0<br>5-3                      |                              | 0-0<br>1B<br>1-2<br>1B          |                              | 0-0<br>5-3                      |                               | 0-0<br>F7                        |                              | 4 0 1 0 0 0 1                   |                              |                                 |                              |                                 |                              |                                 |                              |                                 |                              |                                 |                                  |                                    |                                  |        |    |     |     |     |    |    |   |   |     |      |
| Jim Gentile, L (1, 3)<br>OBP: 0.381, SLG: 0.479       |                              | 0-0<br>F8                       |                              | 0-3<br>K                        |                              |                                 | 0-0<br>F8                     |                                  | 0-0<br>F7                    | 4 0 0 0 0 1 3                   |                              |                                 |                              |                                 |                              |                                 |                              |                                 |                              |                                 |                                  |                                    |                                  |        |    |     |     |     |    |    |   |   |     |      |
| Ed Charles, R (1, 5)<br>OBP: 0.323, SLG: 0.382        |                              | 0-0<br>FC5-4<br>1B              |                              | 0-0<br>1-3<br>2-H<br>1B         |                              |                                 | 0-0<br>F3                     |                                  | 0-0<br>F9                    | 4 0 2 1 0 0 1                   |                              |                                 |                              |                                 |                              |                                 |                              |                                 |                              |                                 |                                  |                                    |                                  |        |    |     |     |     |    |    |   |   |     |      |
| Tommy Reynolds, R (1, 7)<br>OBP: 0.281, SLG: 0.259    |                              | 0-0<br>FC5-4                    |                              | 0-3<br>K                        |                              |                                 | 0-0<br>E5<br>FC6-4            |                                  |                              | 3 0 0 0 0 1 3                   |                              |                                 |                              |                                 |                              |                                 |                              |                                 |                              |                                 |                                  |                                    |                                  |        |    |     |     |     |    |    |   |   |     |      |
| Dave Duncan, R (1, 2)<br>OBP: 0.195, SLG: 0.282       |                              |                                 | 0-0<br>L4                    |                                 | 4-0<br>FC5-6<br>BB           |                                 | 0-0<br>FC6-4                  |                                  |                              | 2 0 0 0 1 0 1                   |                              |                                 |                              |                                 |                              |                                 |                              |                                 |                              |                                 |                                  |                                    |                                  |        |    |     |     |     |    |    |   |   |     |      |
| Diego Segui, R (1, 1)<br>OBP: 0.205, SLG: 0.217       |                              |                                 | 0-0<br>1-3                   |                                 | 0-0<br>FC5-6                 |                                 |                               | 0-0<br>F6                        |                              | 2 0 0 0 0 0 1                   |                              |                                 |                              |                                 |                              |                                 |                              |                                 |                              |                                 |                                  |                                    |                                  |        |    |     |     |     |    |    |   |   |     |      |
| Jose Tartabull, L (8, PH)<br>OBP: 0.238, SLG: 0.227   |                              |                                 |                              |                                 |                              |                                 |                               |                                  |                              | 1 0 0 0 0 0 0                   |                              |                                 |                              |                                 |                              |                                 |                              |                                 |                              |                                 |                                  |                                    |                                  |        |    |     |     |     |    |    |   |   |     |      |
| John Wyatt, R (8, 1)                                  |                              |                                 |                              |                                 |                              |                                 |                               |                                  |                              | 0 0 0 0 0 0 0                   |                              |                                 |                              |                                 |                              |                                 |                              |                                 |                              |                                 |                                  |                                    |                                  |        |    |     |     |     |    |    |   |   |     |      |
| Moe Drabowsky, R (8, 1)<br>OBP: 0.045, SLG: 0.023     |                              |                                 |                              |                                 |                              |                                 |                               |                                  |                              | 0 0 0 0 0 0 0                   |                              |                                 |                              |                                 |                              |                                 |                              |                                 |                              |                                 |                                  |                                    |                                  |        |    |     |     |     |    |    |   |   |     |      |
| <b>Inning Stats</b>                                   | R: 0<br>E: 0<br>K: 0<br>S: 3 | H: 0<br>LOB: 0<br>BB: 0<br>P: 3 | R: 0<br>E: 0<br>K: 0<br>S: 4 | H: 1<br>LOB: 1<br>BB: 0<br>P: 4 | R: 0<br>E: 0<br>K: 0<br>S: 3 | H: 0<br>LOB: 0<br>BB: 0<br>P: 3 | R: 1<br>E: 0<br>K: 2<br>S: 10 | H: 3<br>LOB: 2<br>BB: 0<br>P: 10 | R: 0<br>E: 0<br>K: 0<br>S: 2 | H: 0<br>LOB: 0<br>BB: 1<br>P: 6 | R: 0<br>E: 0<br>K: 0<br>S: 3 | H: 0<br>LOB: 0<br>BB: 0<br>P: 3 | R: 0<br>E: 1<br>K: 0<br>S: 4 | H: 0<br>LOB: 1<br>BB: 0<br>P: 4 | R: 0<br>E: 0<br>K: 0<br>S: 3 | H: 0<br>LOB: 0<br>BB: 0<br>P: 3 | R: 0<br>E: 0<br>K: 0<br>S: 4 | H: 1<br>LOB: 1<br>BB: 0<br>P: 4 | R: 0<br>E: 0<br>K: 0<br>S: 4 | H: 1<br>LOB: 1<br>BB: 0<br>P: 4 | 1B: 5<br>2B: 0<br>3B: 0<br>HR: 0 | SF: 0<br>SAC: 0<br>DP: 1<br>HBP: 0 | WP: 0<br>PB: 0<br>SB: 0<br>CS: 0 | PA: 33 |    |     |     |     |    |    |   |   |     |      |
| <b>PITCHER</b><br>Mudcat Grant, R (1, 1)<br>ERA: 3.65 | IP<br>9.0                    | WLS<br>W                        | BF<br>33                     | H<br>5                          | R<br>1                       | ER<br>1                         | SO<br>2                       | BB<br>1                          | IBB<br>0                     | HBP<br>0                        | BLK<br>0                     | WP<br>0                         | HR<br>0                      | S<br>36                         | P<br>40                      | ERA<br>1.00                     | WHIP<br>0.667                |                                 |                              |                                 |                                  |                                    |                                  |        |    |     |     |     |    |    |   |   |     |      |
| <b>PITCHER</b>  |                              |                                 |                              |                                 |                              |                                 |                               |                                  |                              |                                 |                              |                                 |                              |                                 |                              |                                 |                              | IP                              | WLS                          | BF                              | H                                | R                                  | ER                               | SO     | BB | IBB | HBP | BLK | WP | HR | S | P | ERA | WHIP |

**Kansas City Athletics @ Minnesota Twins**  
 Metropolitan Stadium, Bloomington, MI  
 Wed Sep 30 1964, 8:05 PM EDT  
 Att. 2,780 - Unknown

livebaseballscorecards.com

|            |    |
|------------|----|
| <b>AB</b>  | 32 |
| <b>R</b>   | 1  |
| <b>H</b>   | 5  |
| <b>RBI</b> | 1  |
| <b>BB</b>  | 1  |
| <b>SO</b>  | 2  |
| <b>LOB</b> | 11 |



| Batter  | 1                      | 2                  | 3         | 4         | 5               | 6                     | 7          | 8         | 9 | AB | R | H | RBI | BB | SO | LOB |
|---|------------------------|--------------------|-----------|-----------|-----------------|-----------------------|------------|-----------|---|----|---|---|-----|----|----|-----|
| Rich Rollins, R<br>OBP: 0.334, SLG: 0.408<br>(1, 5)   | 0-0<br>1B<br>2B        | 0-0<br>2-H<br>1B   |           | 0-0<br>F7 |                 |                       | 0-0<br>6-3 |           |   | 4  | 1 | 2 | 1   | 0  | 0  | 0   |
| Zoilo Versalles, R<br>OBP: 0.309, SLG: 0.436<br>(1, 6)  | 0-0<br>2-H<br>1B<br>1B | 0-3<br>K<br>1-2    |           |           | 0-0<br>F9       |                       | 0-0<br>6-3 |           |   | 4  | 1 | 1 | 1   | 0  | 1  | 1   |
| Tony Oliva, L<br>OBP: 0.356, SLG: 0.547<br>(1, 9)   | 0-0<br>1-H<br>1B       | 0-0<br>G3          |           |           | 0-0<br>CS<br>1B |                       | 0-0<br>F9  |           |   | 4  | 0 | 2 | 1   | 0  | 0  | 1   |
| Harmon Killebrew, R<br>OBP: 0.380, SLG: 0.551<br>Jerry Kindall, R<br>OBP: 0.239, SLG: 0.263<br>(1, 7)<br>(9, 4) | 0-0<br>1-2<br>F7       |                    | 0-3<br>K  |           | 0-3<br>K<br>1-2 |                       |            | 0-3<br>K  |   | 4  | 0 | 0 | 0   | 0  | 3  | 2   |
| Jimmie Hall, L<br>OBP: 0.339, SLG: 0.489<br>(1, 8)  | 0-3<br>K               |                    | 0-0<br>HR |           |                 | 0-0<br>G4-6-3<br>1B   |            | 0-0<br>F6 |   | 4  | 1 | 2 | 1   | 0  | 1  | 1   |
| Don Mincher, L<br>OBP: 0.297, SLG: 0.555<br>(1, 3)  | 4-0<br>BB              |                    | 0-3<br>K  |           |                 | 0-0<br>G4-6-3<br>1-2f |            | 0-0<br>HR |   | 3  | 1 | 1 | 1   | 1  | 1  | 1   |
| Earl Battey, R<br>OBP: 0.342, SLG: 0.404<br>(1, 2)  | 0-0<br>F3              |                    | 0-0<br>F7 |           |                 | 0-0<br>1B             |            | 0-0<br>1B |   | 4  | 0 | 2 | 0   | 0  | 0  | 2   |
| Jay Ward, R<br>OBP: 0.333, SLG: 0.278<br>(1, 4)<br>(9, 7)   |                        | 0-0<br>SH3-4<br>1B |           | 0-3<br>K  |                 | 0-0<br>F4             |            | 0-0<br>F8 |   | 4  | 1 | 1 | 0   | 0  | 1  | 2   |
| Mudcat Grant, R<br>OBP: 0.233, SLG: 0.313<br>(1, 1)   |                        | 0-0<br>SH3-4       |           | 0-0<br>L3 |                 |                       | 0-0<br>E8  |           |   | 2  | 1 | 0 | 0   | 0  | 0  | -1  |

| Inning Stats                           | R: 2 | H: 3 | E: 0 | K: 1 | S: 8 | LOB: 2 | BB: 1 | P: 12 | R: 1 | H: 2 | E: 0 | K: 1 | S: 7 | LOB: 1 | BB: 0 | P: 7 | R: 1  | H: 1  | E: 0 | K: 2 | S: 8 | LOB: 0 | BB: 0 | P: 8 | R: 0 | H: 0 | E: 0 | K: 1 | S: 5 | LOB: 0 | BB: 0 | P: 5 | R: 0 | H: 1 | E: 0 | K: 1 | S: 5 | LOB: 1 | BB: 0 | P: 5 | R: 0 | H: 2 | E: 0 | K: 0 | S: 4 | LOB: 1 | BB: 0 | P: 4 | R: 1 | H: 0 | E: 1 | K: 0 | S: 4 | LOB: 0 | BB: 0 | P: 4 | R: 1 | H: 2 | E: 0 | K: 1 | S: 7 | LOB: 1 | BB: 0 | P: 7 |
|--|------|------|------|------|------|--------|-------|-------|------|------|------|------|------|--------|-------|------|-------|-------|------|------|------|--------|-------|------|------|------|------|------|------|--------|-------|------|------|------|------|------|------|--------|-------|------|------|------|------|------|------|--------|-------|------|------|------|------|------|------|--------|-------|------|------|------|------|------|------|--------|-------|------|
| PITCHER                                | IP   | WLS  | BF   | H    | R    | ER     | SO    | BB    | IBB  | HBP  | BLK  | WP   | HR   | S      | P     | ERA  | WHIP  |       |      |      |      |        |       |      |      |      |      |      |      |        |       |      |      |      |      |      |      |        |       |      |      |      |      |      |      |        |       |      |      |      |      |      |      |        |       |      |      |      |      |      |      |        |       |      |
| Diego Segui, R<br>ERA: 4.48<br>(1, 1)  | 7.0  | L    | 30   | 9    | 5    | 4      | 6     | 1     | 0    | 0    | 0    | 0    | 0    | 1      | 41    | 45   | 5.14  | 1.429 |      |      |      |        |       |      |      |      |      |      |      |        |       |      |      |      |      |      |      |        |       |      |      |      |      |      |      |        |       |      |      |      |      |      |      |        |       |      |      |      |      |      |      |        |       |      |
| John Wyatt, R<br>ERA: 3.69<br>(8, 1)   | 0.2  |      | 3    | 1    | 1    | 1      | 1     | 0     | 0    | 0    | 0    | 0    | 0    | 1      | 5     | 5    | 13.50 | 1.500 |      |      |      |        |       |      |      |      |      |      |      |        |       |      |      |      |      |      |      |        |       |      |      |      |      |      |      |        |       |      |      |      |      |      |      |        |       |      |      |      |      |      |      |        |       |      |
| Moe Drabowsky, R<br>ERA: 5.3<br>(8, 1) | 0.1  |      | 2    | 1    | 0    | 0      | 0     | 0     | 0    | 0    | 0    | 0    | 0    | 0      | 2     | 2    | 0.00  | 3.000 |      |      |      |        |       |      |      |      |      |      |      |        |       |      |      |      |      |      |      |        |       |      |      |      |      |      |      |        |       |      |      |      |      |      |      |        |       |      |      |      |      |      |      |        |       |      |

**BOTTOM**

**Kansas City Athletics @ Minnesota Twins**  
Metropolitan Stadium, Bloomington, MI

|     |    |
|-----|----|
| AB  | 33 |
| R   | 6  |
| H   | 11 |
| RBI | 5  |
| BB  | 1  |
| SO  | 7  |
| LOB | 9  |



|       |        |
|-------|--------|
| WP: 0 | PA: 35 |
| PB: 0 |        |
| SB: 2 |        |
| CS: 1 |        |
| 1B: 8 | SF: 0  |
| 2B: 2 | SAC: 1 |
| 3B: 0 | DP: 2  |
| HR: 2 | HBP: 0 |
| WP: 0 | PA: 35 |
| ERA   | WHIP   |

Wed Sep 30 1964, 8:05 PM EDT  
Att. 2,780 - Unknown

[livebaseballscorecards.com](http://livebaseballscorecards.com)

| Batter   | 1  | 2  | 3   | 4   | 5   | 6   | 7   | 8   | 9   | 10  | 11  | 12  | AB R H RBI BB SO LOB  | TOP   |   |
|--|--|--|---|---|---|---|---|---|---|---|---|---|---|---|---|
| Bert Campaneris, R<br>OBP: 0.306, SLG: 0.386<br>(1, 6)   | 0-0<br>E5<br>G3 S<br>4-3   | 4-0<br>BB<br>1-2<br>2-3                              |   |   | 0-0<br>1-3  |   | 0-3<br>K  | 0-0<br>F6   |   |   | 0-0<br>3B   |   | 5 1 1 0 1 1 2   | <b>Kansas City Athletics @ Minnesota Twins</b><br>Metropolitan Stadium, Bloomington, MI<br>Thu Oct 01 1964, 4:33 AM EDT<br>Att: 2,728 - Unknown |   |
| Wayne Causey, L<br>OBP: 0.381, SLG: 0.385<br>(1, 4)  | 0-0<br>G3<br>1-3   | 0-3<br>K   |   |   | 0-0<br>1B<br>1B                                     |   | 0-0<br>F7   |   | 0-0<br>F9   |   | 0-0<br>F5   |   | 6 0 1 0 0 1 5   |   |   |
| Larry Stahl, L<br>OBP: 0.343, SLG: 0.618<br>(1, 8)   | 0-0<br>4-3   |  |   |   | 0-3<br>K  |   |   | 0-0<br>E3<br>E 2B                                     | 0-3<br>K  |   |   | 0-0<br>HR   | 6 2 1 2 0 3 1   |   |   |
| Rocky Colavito, R<br>OBP: 0.367, SLG: 0.513<br>(1, 9)  | 4-0<br>BB<br>3-H   |  |   |   | 0-0<br>F2   |   |   | 0-0<br>E6<br>E 2B                                     | 0-0<br>F3   |   |   | 0-0<br>F3   | 5 1 1 0 1 0 1   |   |   |
| Jim Gentile, L<br>OBP: 0.378, SLG: 0.474<br>(1, 3)   | 0-3<br>K   |  |   |   | 0-0<br>FC5-4<br>1B                                  |   |   | 0-0<br>F7   |   |   |   | 0-0<br>F7   | 6 0 1 0 0 2 5   |   |   |
| Ed Charles, R<br>OBP: 0.324, SLG: 0.384<br>(1, 5)  |  |  |   |   | 0-0<br>FC5-4<br>1B                                  |   |   | 0-0<br>E5<br>E 2B<br>1-2<br>2-3<br>1B                 |   | 0-0<br>F8   |   | 0-0<br>FC5<br>2B                                    | 6 1 2 0 0 1 3   |   |   |
| Tommie Reynolds, R<br>OBP: 0.294, SLG: 0.278<br>(1, 7)   |  |  |   |   | 0-3<br>K  |   |   | 0-0<br>1B<br>1-3<br>2-H<br>3-H<br>2B                  |   | 0-0<br>5-3  |   | 0-0<br>FC5<br>2-3                                   | 5 0 2 2 1 1 1   |   |   |
| Dave Duncan, R<br>OBP: 0.196, SLG: 0.273<br>(1, 2)   |  |  |   |   | 0-0<br>K<br>G4-6-3<br>1B                            |   |   | 0-3<br>K  |   |   |   | 0-3<br>K  | 5 0 1 0 0 3 4   |   |   |
| Orlando Pena, R<br>John Wyatt, R<br>Jose Tartabull, L<br>Ted Brownfield, R<br>Manny Jimenez, L<br>Lew Krause, R<br>Wes Stock, R<br>George Alujk, R<br>Moe Drabowsky, R |  |  |   |   | 0-0<br>K<br>G4-6-3                                  |   |   | 0-3<br>K  |   |   |   | 0-3<br>K  | 2 0 1 0 0 0 1<br>1 0 0 0 0 0 1<br>1 0 0 0 0 0 0<br>1 0 0 1 0 0 0<br>0 0 0 0 0 0 0<br>0 0 0 0 0 0 0<br>0 0 0 0 0 0 0<br>1 0 0 0 0 0 1<br>0 0 0 0 0 0 0 |   |   |
| <b>Inning Stats</b>  | R: 1 H: 0<br>E: 1 LOB: 1<br>K: 1 BB: 1<br>S: 6 P: 10   | R: 0 H: 3<br>E: 0 LOB: 3<br>K: 2 BB: 1<br>S: 9 P: 13 | R: 0 H: 1<br>E: 0 LOB: 1<br>K: 1 BB: 0<br>S: 6 P: 6 | R: 0 H: 1<br>E: 0 LOB: 0<br>K: 1 BB: 0<br>S: 5 P: 5 | R: 0 H: 2<br>E: 0 LOB: 2<br>K: 2 BB: 0<br>S: 9 P: 9 | R: 0 H: 0<br>E: 0 LOB: 0<br>K: 1 BB: 1<br>S: 4 P: 8 | R: 0 H: 0<br>E: 0 LOB: 0<br>K: 2 BB: 0<br>S: 7 P: 7 | R: 3 H: 2<br>E: 3 LOB: 2<br>K: 1 BB: 0<br>S: 10 P: 10 | R: 0 H: 0<br>E: 0 LOB: 0<br>K: 1 BB: 0<br>S: 5 P: 5 | R: 0 H: 0<br>E: 0 LOB: 0<br>K: 0 BB: 0<br>S: 3 P: 3 | R: 0 H: 1<br>E: 0 LOB: 1<br>K: 2 BB: 0<br>S: 8 P: 8 | R: 1 H: 2<br>E: 0 LOB: 1<br>K: 0 BB: 0<br>S: 5 P: 5 | 1B: 8 SF: 0<br>2B: 2 SAC: 0<br>3B: 1 DP: 2<br>HR: 1 HBP: 0  |   | WP: 0 PA: 52<br>PB: 0<br>SB: 1<br>CS: 1 |
| <b>PITCHER</b><br>Camilo Pascual, R<br>ERA: 3.27<br>(1, 1)   | IP 12.0 WLS L BF 52 H 12 R 5 ER 1 SO 14 BB 3 IBB 0 HBP 0 BLK 0 WP 0 HR 1 S 77 P 89 ERA 0.75 WHIP 1.250 |  |   |   |   |   |   |   |   |   |   |   |   |   |   |

|     |    |
|-----|----|
| AB  | 49 |
| R   | 5  |
| H   | 12 |
| RBI | 5  |
| BB  | 3  |
| SO  | 14 |
| LOB | 23 |



| Batter   | 1                     | 2          | 3         | 4               | 5                            | 6                        | 7                     | 8                    | 9         | 10                 | 11                      | 12                    |
|--|-----------------------|------------|-----------|-----------------|------------------------------|--------------------------|-----------------------|----------------------|-----------|--------------------|-------------------------|-----------------------|
| Rich Rollins, R<br>OBP: 0.334, SLG: 0.407<br>(1, 5)  | 4-0<br>BB HBP<br>BB   |            | 0-3<br>K  |                 | 0-0<br>E<br>3B<br>1B         | 0-0<br>SH1-4             |                       |                      | 0-3<br>K  |                    | 0-0<br>L1               |                       |
| Zolo Versailles, R<br>OBP: 0.309, SLG: 0.434<br>(1, 6)   | 1-0<br>BB<br>HBP      |            | 0-3<br>K  |                 | 0-0<br>E1<br>3B<br>1B        | 0-0<br>CS<br>1B          |                       |                      | 0-3<br>K  |                    | 0-0<br>FC6-4<br>1B<br>S |                       |
| Tony Oliva, L<br>OBP: 0.359, SLG: 0.555<br>(1, 9)  | 0-3<br>K              |            | 0-0<br>HR |                 | 0-0<br>E<br>3B               | 4-0<br>BB                |                       |                      | 0-0<br>F5 |                    | 0-0<br>1B               |                       |
| Harmon Killebrew, R<br>OBP: 0.379, SLG: 0.549<br>Mudcat Grant, R<br>OBP: 0.233, SLG: 0.313<br>Ron Henry, R<br>OBP: 0.167, SLG: 0.350<br>(1, 7)<br>(10, PR)<br>(11, 2)  | 0-3<br>K              |            | 0-3<br>K  |                 | 0-0<br>E4<br>WP<br>3B<br>3-H | 0-0<br>CS                | 0-0<br>6-3            |                      |           |                    | 0-3<br>K                |                       |
| Jimmie Hall, L<br>OBP: 0.341, SLG: 0.487<br>(1, 8)   | 4-0<br>BB<br>BB<br>BB |            |           | 0-0<br>L4       | 0-3<br>K                     |                          | 0-0<br>G6-4-3<br>1B   |                      |           | 4-0<br>IBB         |                         | 0-0<br>4-3            |
| Don Mincher, L<br>OBP: 0.297, SLG: 0.554<br>(1, 3)   | 0-0<br>L4             |            |           | 0-0<br>1B<br>1B | 0-0<br>F7                    |                          | 0-0<br>G6-4-3<br>1-2f |                      |           | 0-3<br>K           |                         | 0-0<br>2B             |
| Earl Battey, R<br>OBP: 0.346, SLG: 0.406<br>Rich Reese, L<br>(8, PR)<br>Jerry Zimmerman, R<br>OBP: 0.278, SLG: 0.225<br>Frank Kostro, R<br>OBP: 0.306, SLG: 0.413<br>Jerry Kindall, R<br>OBP: 0.238, SLG: 0.261<br>(1, 2)<br>(9, 2)<br>(10, PH)<br>(11, 4) |                       | 0-3<br>K   |           | 0-0<br>1B<br>1B | 0-0<br>1B<br>BB              | 4-0<br>BB<br>BB<br>BB    |                       | 0-0<br>F8-4-3<br>1B  |           | 0-0<br>F8          |                         | 0-0<br>F9             |
| Jay Ward, R<br>OBP: 0.296, SLG: 0.217<br>(1, 4)<br>(11, 7)   |                       | 0-3<br>K   |           | 0-3<br>K        | 0-0<br>F7                    |                          | 0-3<br>K              |                      | 0-3<br>K  |                    | 0-3<br>K                | 4-0<br>BB<br>BB<br>BB |
| Camilo Pascual, R<br>OBP: 0.245, SLG: 0.255<br>Johnny Goryl, R<br>OBP: 0.218, SLG: 0.177<br>(1, 1)<br>(12, PH)   |                       | 0-0<br>4-3 |           | 0-0<br>F8       |                              | 0-0<br>SH1-4<br>1B<br>1B |                       | 0-0<br>F8-4-3<br>1-2 |           | 0-0<br>FC6-4<br>1B |                         | 0-0<br>G3             |

| AB | R | H | RBI | BB | SO | LOB |
|----|---|---|-----|----|----|-----|
| 4  | 1 | 1 | 0   | 1  | 2  | 1   |
| 5  | 1 | 1 | 0   | 0  | 2  | 2   |
| 5  | 2 | 3 | 3   | 1  | 1  | 2   |
| 5  | 0 | 1 | 1   | 0  | 2  | 2   |
| 0  | 0 | 0 | 0   | 0  | 0  | 0   |
| 1  | 0 | 0 | 0   | 0  | 1  | 2   |
| 4  | 0 | 1 | 0   | 2  | 1  | 1   |
| 6  | 0 | 2 | 0   | 0  | 1  | 7   |
| 3  | 0 | 2 | 0   | 1  | 1  | 0   |
| 0  | 0 | 0 | 0   | 0  | 0  | 0   |
| 0  | 0 | 0 | 0   | 0  | 0  | 2   |
| 1  | 0 | 0 | 0   | 0  | 0  | 1   |
| 5  | 0 | 0 | 0   | 1  | 4  | 7   |
| 5  | 0 | 2 | 0   | 0  | 0  | 3   |
| 1  | 0 | 0 | 0   | 0  | 0  | 2   |

| AB | R | H  | RBI | BB | SO | LOB |
|----|---|----|-----|----|----|-----|
| 46 | 4 | 13 | 4   | 6  | 15 | 32  |

| Inning Stats | R: 0  | H: 0  | E: 0  | K: 2  | S: 7  | LOB: 3 | BB: 2 | P: 16  |
|--------------|-------|-------|-------|-------|-------|--------|-------|--------|
|              | R: 0  | H: 0  | E: 0  | K: 2  | S: 7  | LOB: 0 | BB: 0 | P: 7   |
|              | R: 1  | H: 1  | E: 0  | K: 3  | S: 10 | LOB: 0 | BB: 0 | P: 10  |
|              | R: 0  | H: 2  | E: 0  | K: 1  | S: 7  | LOB: 2 | BB: 0 | P: 7   |
|              | R: 3  | H: 2  | E: 2  | K: 1  | S: 9  | LOB: 2 | BB: 1 | P: 13  |
|              | R: 0  | H: 2  | E: 0  | K: 0  | S: 3  | LOB: 1 | BB: 1 | P: 7   |
|              | R: 0  | H: 1  | E: 0  | K: 0  | S: 3  | LOB: 0 | BB: 0 | P: 3   |
|              | R: 0  | H: 1  | E: 0  | K: 1  | S: 5  | LOB: 1 | BB: 0 | P: 5   |
|              | R: 0  | H: 0  | E: 0  | K: 2  | S: 7  | LOB: 0 | BB: 0 | P: 7   |
|              | R: 0  | H: 1  | E: 0  | K: 2  | S: 8  | LOB: 2 | BB: 1 | P: 12  |
|              | R: 0  | H: 2  | E: 0  | K: 1  | S: 7  | LOB: 2 | BB: 0 | P: 7   |
|              | R: 0  | H: 1  | E: 0  | K: 0  | S: 4  | LOB: 2 | BB: 1 | P: 8   |
|              | 1B: 9 | 2B: 3 | 3B: 1 | HR: 1 | SF: 0 | SAC: 1 | DP: 2 | HBP: 1 |

| PITCHER                                  | IP  | WLS | BF | H | R | ER | SO | BB | IBB | HBP | BLK | WP | HR | S  | P  | ERA  | WHIP  |
|--|-----|-----|----|---|---|----|----|----|-----|-----|-----|----|----|----|----|------|-------|
| Orlando Pena, R<br>ERA: 4.41<br>(1, 1)   | 4.1 |     | 23 | 5 | 4 | 3  | 9  | 2  | 0   | 1   | 0   | 1  | 1  | 38 | 47 | 6.23 | 1.615 |
| John Wyatt, R<br>ERA: 3.64<br>(5, 1)     | 1.2 |     | 7  | 2 | 0 | 0  | 0  | 2  | 0   | 0   | 0   | 0  | 0  | 5  | 13 | 0.00 | 2.400 |
| Ted Bowsfield, L<br>ERA: 4.28<br>(7, 1)  | 1.0 |     | 3  | 1 | 0 | 0  | 0  | 0  | 0   | 0   | 0   | 0  | 0  | 3  | 3  | 0.00 | 1.000 |
| Wes Stock, R<br>ERA: 2.2<br>(8, 1)       | 3.0 |     | 11 | 2 | 0 | 0  | 5  | 0  | 1   | 0   | 0   | 0  | 0  | 20 | 24 | 0.00 | 0.667 |
| Moe Drabowsky, R<br>ERA: 5.24<br>(11, 1) | 2.0 | W   | 10 | 3 | 0 | 0  | 1  | 1  | 0   | 0   | 0   | 0  | 0  | 11 | 15 | 0.00 | 2.000 |

| PITCHER | IP | WLS | BF | H | R | ER | SO | BB | IBB | HBP | BLK | WP | HR | S | P | ERA | WHIP |
|---------|----|-----|----|---|---|----|----|----|-----|-----|-----|----|----|---|---|-----|------|
|         |    |     |    |   |   |    |    |    |     |     |     |    |    |   |   |     |      |

**Kansas City Athletics @ Minnesota Twins**  
 Metropolitan Stadium, Bloomington, MI  
 Thu Oct 01 1964, 4:33 AM EDT  
 Att. 2,728 - Unknown



| WP | PA |
|----|----|
| 1  | 55 |

| Batter  | 1          | 2                | 3          | 4         | 5                | 6         | 7                  | 8               | 9                       | AB R H RBI BB SO LOB  |
|---|------------|------------------|------------|-----------|------------------|-----------|--------------------|-----------------|-------------------------|---|
| Bert Campaneris, R (1, 6)<br>OBP: 0.304, SLG: 0.382 | 0-0<br>5-3 |                  | 0-0<br>5-3 |           | 0-0<br>1-2<br>1B |           | 0-0<br>FC4<br>1-2f |                 | 0-0<br>6-3<br>2-3       | 5 0 1 0 0 0 3   |
| Larry Stahl, L (1, 7)<br>OBP: 0.300, SLG: 0.538     | 0-0<br>F2  |                  | 0-0<br>1-3 |           | 0-3<br>K         |           |                    | 0-0<br>4-3      | 0-0<br>F6               | 5 0 0 0 0 1 3   |
| Nelson Mathews, R (1, 8)<br>OBP: 0.297, SLG: 0.383  | 0-3<br>K   |                  |            | 0-0<br>F3 |                  | 0-0<br>F5 |                    | 0-0<br>BB<br>1B |                         | 4 0 1 0 0 1 0   |
| Rocky Colavito, R (1, 9)<br>OBP: 0.368, SLG: 0.513  |            | 0-0<br>2B<br>1B  |            | 0-0<br>F9 |                  | 0-0<br>F8 |                    | 0-0<br>BB<br>1B |                         | 4 1 2 0 0 0 0   |
| Jim Gentile, L (1, 3)<br>OBP: 0.375, SLG: 0.470     |            | 0-3<br>K         |            | 0-3<br>K  |                  | 0-3<br>K  |                    | 0-0<br>F6       |                         | 4 0 0 0 0 3 3   |
| Ed Charles, R (1, 5)<br>OBP: 0.325, SLG: 0.385      |            | 0-0<br>F9        |            |           | 0-0<br>1B<br>2B  |           | 0-0<br>F8          | 4-0<br>BB       |                         | 3 1 1 0 1 0 1   |
| Wayne Causey, L (1, 4)<br>OBP: 0.382, SLG: 0.390    |            | 0-0<br>1-H<br>2B |            |           | 0-0<br>1-3       |           | 0-0<br>2B          | 0-3<br>K        |                         | 4 0 2 1 0 1 4   |
| Dave Duncan, R (1, 2)<br>OBP: 0.184, SLG: 0.255     |            | 0-3<br>K         |            |           | 0-3<br>K2-3      |           | 0-3<br>K           | 4-0<br>BB       | 4-0<br>6-3<br>6-3<br>BB | 3 0 0 0 0 3 3<br>0 0 0 0 1 0 0  |
| Jose Tartabull, L (9, PH)<br>OBP: 0.243, SLG: 0.224 |            |                  |            |           |                  |           |                    |                 |                         |   |
| Jose Santiago, R (1, 1)                             |            |                  | 0-0<br>4-3 |           | 0-0<br>2-H<br>1B |           | 4-0<br>FC4<br>BB   |                 | 0-0<br>6-3              | 1 0 0 0 0 0 0<br>1 0 1 1 0 0 0<br>0 0 0 0 0 0 0<br>0 0 0 0 0 1 0 0<br>0 0 0 0 0 0 0 0<br>0 0 0 0 0 0 0 0<br>1 0 0 0 0 0 0 1 |

**TOP**

**Kansas City Athletics @ Chicago White Sox**  
Comiskey Park, Chicago, IL  
Fri Oct 02 1964, 8:05 PM EDT  
Unknown

|     |    |
|-----|----|
| AB  | 35 |
| R   | 2  |
| H   | 8  |
| RBI | 2  |
| BB  | 3  |
| SO  | 9  |
| LOB | 18 |

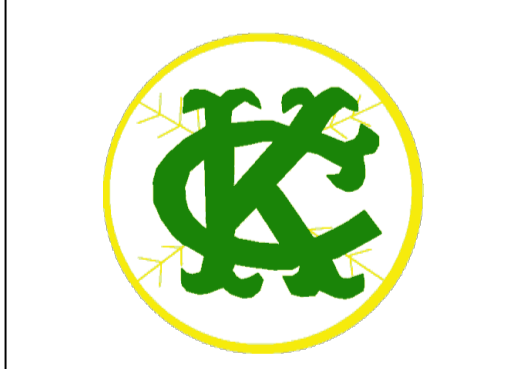

| Inning Stats | R: 0 | H: 0 | E: 0 | K: 1 | S: 5 | P: 5 | R: 1 | H: 2 | E: 0 | K: 2 | S: 9 | P: 9 | R: 0 | H: 0 | E: 0 | K: 0 | S: 3 | P: 3 | R: 0 | H: 0 | E: 0 | K: 1 | S: 5 | P: 5 | R: 1 | H: 3 | E: 0 | K: 2 | S: 10 | P: 10 | R: 0 | H: 0 | E: 0 | K: 1 | S: 5 | P: 5 | R: 0 | H: 1 | E: 0 | K: 1 | S: 6 | P: 10 | R: 0 | H: 2 | E: 0 | K: 1 | S: 7 | P: 11 | R: 0 | H: 0 | E: 0 | K: 0 | S: 3 | P: 7 | 1B: 5 | 2B: 3 | 3B: 0 | HR: 0 | SF: 0 | SAC: 0 | DP: 0 | HBP: 0 | WP: 0 | PA: 38 |
|--------------|------|------|------|------|------|------|------|------|------|------|------|------|------|------|------|------|------|------|------|------|------|------|------|------|------|------|------|------|-------|-------|------|------|------|------|------|------|------|------|------|------|------|-------|------|------|------|------|------|-------|------|------|------|------|------|------|-------|-------|-------|-------|-------|--------|-------|--------|-------|--------|
|--------------|------|------|------|------|------|------|------|------|------|------|------|------|------|------|------|------|------|------|------|------|------|------|------|------|------|------|------|------|-------|-------|------|------|------|------|------|------|------|------|------|------|------|-------|------|------|------|------|------|-------|------|------|------|------|------|------|-------|-------|-------|-------|-------|--------|-------|--------|-------|--------|

| PITCHER                             | IP  | WLS | BF | H | R | ER | SO | BB | IBB | HBP | BLK | WP | HR | S  | P  | ERA  | WHIP  |
|-------------------------------------|-----|-----|----|---|---|----|----|----|-----|-----|-----|----|----|----|----|------|-------|
| Juan Pizarro, L (1, 1)<br>ERA: 2.56 | 5.0 | W   | 20 | 5 | 2 | 2  | 6  | 0  | 0   | 0   | 0   | 0  | 0  | 32 | 32 | 3.60 | 1.000 |
| Hoyt Wilhelm, R (6, 1)<br>ERA: 2.0  | 4.0 | S   | 18 | 3 | 0 | 0  | 3  | 3  | 0   | 0   | 0   | 0  | 0  | 21 | 33 | 0.00 | 1.500 |

| PITCHER | IP | WLS | BF | H | R | ER | SO | BB | IBB | HBP | BLK | WP | HR | S | P | ERA | WHIP |
|---------|----|-----|----|---|---|----|----|----|-----|-----|-----|----|----|---|---|-----|------|
|---------|----|-----|----|---|---|----|----|----|-----|-----|-----|----|----|---|---|-----|------|

| Batter   | 1          | 2                   | 3          | 4                              | 5                    | 6         | 7          | 8          | 9 |
|--|------------|---------------------|------------|--------------------------------|----------------------|-----------|------------|------------|---|
| Tom McCraw, L<br>OBP: 0.321, SLG: 0.368<br>(1, 7)<br>(8, 3)  | 0-3<br>K   |                     | 0-0<br>1-3 | 0-0<br>F7                      |                      | 0-3<br>K  |            |            |   |
| Don Buford, S<br>OBP: 0.339, SLG: 0.353<br>Mike Hershberger, R<br>OBP: 0.306, SLG: 0.284<br>(1, 4)<br>(8, 9) | 0-0<br>4-3 |                     | 0-0<br>1B  |                                | 0-0<br>B3            |           | 0-3<br>K   |            |   |
| Floyd Robinson, L<br>OBP: 0.383, SLG: 0.408<br>(1, 9)<br>(8, 7)  | 0-0<br>4-1 |                     | 0-0<br>4-3 |                                | 4-0<br>5-3 1B<br>BB  |           | 0-0<br>1B  |            |   |
| Pete Ward, L<br>OBP: 0.349, SLG: 0.473<br>(1, 5)   |            | 0-0<br>4-3 1B<br>2B |            | 0-3<br>K                       | 0-0<br>5-3 1B<br>1-2 |           | 0-3<br>K   |            |   |
| Bill Skowron, R<br>OBP: 0.323, SLG: 0.429<br>Al Weis, S<br>OBP: 0.302, SLG: 0.306<br>(1, 3)<br>(8, 4)        |            | 0-0<br>4-3          |            | 0-3<br>K                       | 0-0<br>5-3           |           | 0-0<br>4-3 |            |   |
| Ron Hansen, R<br>OBP: 0.342, SLG: 0.408<br>(1, 6)  |            | 0-0<br>3-H<br>1B    |            | 0-0<br>1B<br>1B                | 4-0<br>1B            |           | 0-0<br>4-3 |            |   |
| Ken Berry, R<br>OBP: 0.407, SLG: 0.435<br>(1, 8)   |            | 0-3<br>K            |            | 0-0<br>1B<br>1B                | 0-0<br>F8            |           | 0-0<br>6-3 |            |   |
| Cam Carreon, R<br>OBP: 0.323, SLG: 0.319<br>J.C. Martin, L<br>OBP: 0.243, SLG: 0.280<br>(1, 2)<br>(6, 2)     |            | 0-0<br>6-3          |            | 4-0<br>1B<br>1-2<br>BB         |                      | 0-0<br>F7 |            | 0-0<br>4-3 |   |
| Juan Pizarro, L<br>OBP: 0.217, SLG: 0.322<br>Hoyt Wilhelm, R<br>OBP: 0.182, SLG: 0.143<br>(1, 1)<br>(6, 1)   |            |                     | 0-0<br>F6  | 0-0<br>1-3<br>2-H<br>3-H<br>1B |                      | 0-3<br>K  |            |            |   |

| Inning Stats | R: 0 | H: 0 | E: 0 | K: 1 | S: 5  | LOB: 0 | BB: 0 | P: 5  |
|--------------|------|------|------|------|-------|--------|-------|-------|
|              | R: 1 | H: 2 | E: 0 | K: 1 | S: 7  | LOB: 1 | BB: 0 | P: 7  |
|              | R: 0 | H: 1 | E: 0 | K: 0 | S: 4  | LOB: 1 | BB: 0 | P: 4  |
|              | R: 2 | H: 3 | E: 0 | K: 2 | S: 10 | LOB: 2 | BB: 1 | P: 14 |
|              | R: 0 | H: 1 | E: 0 | K: 0 | S: 4  | LOB: 3 | BB: 2 | P: 12 |
|              | R: 0 | H: 0 | E: 0 | K: 2 | S: 7  | LOB: 0 | BB: 0 | P: 7  |
|              | R: 0 | H: 1 | E: 0 | K: 2 | S: 8  | LOB: 1 | BB: 0 | P: 8  |
|              | R: 0 | H: 0 | E: 0 | K: 0 | S: 3  | LOB: 0 | BB: 0 | P: 3  |

| PITCHER                                 |     |    |    |   |    |    |    |     |     | PITCHER |    |    |    |    |      |       |    |     |    |   |   |    |    |    |     |     |     |    |    |   |   |     |      |  |
|---|-----|----|----|---|----|----|----|-----|-----|---------|----|----|----|----|------|-------|----|-----|----|---|---|----|----|----|-----|-----|-----|----|----|---|---|-----|------|--|
| IP                                      | WLS | BF | H  | R | ER | SO | BB | IBB | HBP | BLK     | WP | HR | S  | P  | ERA  | WHIP  | IP | WLS | BF | H | R | ER | SO | BB | IBB | HBP | BLK | WP | HR | S | P | ERA | WHIP |  |
| Jose Santiago, R<br>ERA: 4.73<br>(1, 1) | 4.0 | L  | 19 | 6 | 3  | 3  | 4  | 1   | 0   | 0       | 0  | 0  | 26 | 30 | 6.75 | 1.750 |    |     |    |   |   |    |    |    |     |     |     |    |    |   |   |     |      |  |
| John Wyatt, R<br>ERA: 3.59<br>(5, 1)    | 2.0 |    | 9  | 1 | 0  | 0  | 2  | 1   | 1   | 0       | 0  | 0  | 11 | 19 | 0.00 | 1.000 |    |     |    |   |   |    |    |    |     |     |     |    |    |   |   |     |      |  |
| Ted Bowsfield, L<br>ERA: 4.2<br>(7, 1)  | 2.0 |    | 7  | 1 | 0  | 0  | 2  | 0   | 0   | 0       | 0  | 0  | 11 | 11 | 0.00 | 0.500 |    |     |    |   |   |    |    |    |     |     |     |    |    |   |   |     |      |  |

**BOTTOM**

**Kansas City Athletics @ Chicago White Sox**  
Comiskey Park, Chicago, IL  
Fri Oct 02 1964, 8:05 PM EDT  
Unknown

|    |   |   |     |    |    |     |
|----|---|---|-----|----|----|-----|
| AB | R | H | RBI | BB | SO | LOB |
| 4  | 0 | 0 | 0   | 0  | 2  | 2   |
| 4  | 0 | 1 | 0   | 0  | 1  | 0   |
| 0  | 0 | 0 | 0   | 0  | 0  | 0   |
| 3  | 0 | 1 | 0   | 1  | 0  | 1   |
| 4  | 1 | 2 | 0   | 0  | 2  | 1   |
| 4  | 0 | 0 | 0   | 0  | 1  | 4   |
| 0  | 0 | 0 | 0   | 0  | 0  | 0   |
| 3  | 1 | 2 | 1   | 1  | 0  | 0   |
| 4  | 1 | 1 | 0   | 0  | 1  | 4   |
| 1  | 0 | 0 | 0   | 1  | 0  | 1   |
| 2  | 0 | 0 | 0   | 0  | 0  | 0   |
| 2  | 0 | 1 | 2   | 0  | 0  | 0   |
| 1  | 0 | 0 | 0   | 0  | 1  | 0   |

|     |    |
|-----|----|
| AB  | 32 |
| R   | 3  |
| H   | 8  |
| RBI | 3  |
| BB  | 3  |
| SO  | 8  |
| LOB | 13 |



| Batter   | 1   | 2                               | 3                            | 4                               | 5                            | 6                                | 7                            | 8                               | 9                            | AB R H RBI BB SO LOB            | TOP                          |                                 |                              |                                 |                              |                                 |                              |                                 |                                   |                                    |                                  |        |  |  |  |  |  |
|--|---|---------------------------------|------------------------------|---------------------------------|------------------------------|----------------------------------|------------------------------|---------------------------------|------------------------------|---------------------------------|------------------------------|---------------------------------|------------------------------|---------------------------------|------------------------------|---------------------------------|------------------------------|---------------------------------|-----------------------------------|------------------------------------|----------------------------------|--------|--|--|--|--|--|
| Bert Campaneris, R (1, 6)<br>OBP: 0.304, SLG: 0.380  | 0-0 L1  |                                 | 0-0 F5                       |                                 | 0-0 WP 1B                    | 0-0 SH2-4                        |                              | 0-0 5-3                         |                              | 4 1 1 0 0 0 1                   |                              |                                 |                              |                                 |                              |                                 |                              |                                 |                                   |                                    |                                  |        |  |  |  |  |  |
| Ed Charles, R (1, 5)<br>OBP: 0.324, SLG: 0.384   | 0-0 F2  |                                 | 0-3 K                        |                                 | 0-0 1B 1B                    | 0-0 FC6-5                        |                              | 0-3 K                           |                              | 5 0 1 1 0 2 2                   |                              |                                 |                              |                                 |                              |                                 |                              |                                 |                                   |                                    |                                  |        |  |  |  |  |  |
| Nelson Mathews, R (1, 8)<br>OBP: 0.296, SLG: 0.381   | 0-0 F8  |                                 | 0-3 K                        |                                 | 0-0 F7                       | 0-0 1B                           |                              | 0-0 5-3                         |                              | 5 0 1 0 0 1 2                   |                              |                                 |                              |                                 |                              |                                 |                              |                                 |                                   |                                    |                                  |        |  |  |  |  |  |
| Rocky Colavito, R (1, 9)<br>OBP: 0.368, SLG: 0.512   |   | 0-0 3-1                         |                              | 0-0 1B 1B                       | 0-0 1B                       | 0-0 F8                           |                              | 0-0 F8                          |                              | 5 0 2 0 0 0 2                   |                              |                                 |                              |                                 |                              |                                 |                              |                                 |                                   |                                    |                                  |        |  |  |  |  |  |
| Jim Gentile, L (1, 3)<br>OBP: 0.374, SLG: 0.468  |   | 0-0 1B 1B                       |                              | 0-3 K                           | 0-3 K                        |                                  | 0-3 K                        |                                 |                              | 4 0 1 0 0 3 3                   |                              |                                 |                              |                                 |                              |                                 |                              |                                 |                                   |                                    |                                  |        |  |  |  |  |  |
| Doc Edwards, R (1, 2)<br>OBP: 0.265, SLG: 0.310  |   | 0-0 FC5-4                       |                              | 0-0 1B                          |                              | 0-0 E5                           |                              | 0-3 K                           |                              | 3 1 2 0 0 0 0                   |                              |                                 |                              |                                 |                              |                                 |                              |                                 |                                   |                                    |                                  |        |  |  |  |  |  |
| Wes Stock, R (6, 1)<br>OBP: 0.200, SLG: 0.158  |   | 1-2 1B                          |                              | 1-2 1B                          |                              | 1B 2B                            |                              |                                 |                              | 1 0 0 0 0 1 0                   |                              |                                 |                              |                                 |                              |                                 |                              |                                 |                                   |                                    |                                  |        |  |  |  |  |  |
| Tommie Reynolds, R (1, 7)<br>OBP: 0.292, SLG: 0.277  |   | 0-3 K                           |                              | 0-3 K                           |                              | 0-0 2B 1B                        |                              | 0-0 6-3                         |                              | 4 1 1 0 0 2 4                   |                              |                                 |                              |                                 |                              |                                 |                              |                                 |                                   |                                    |                                  |        |  |  |  |  |  |
| Wayne Causey, L (1, 4)<br>OBP: 0.381, SLG: 0.390   |   | 0-0 FC5-4                       |                              | 0-0 G3                          |                              | 0-0 1B 2B                        |                              | 0-0 6-3                         |                              | 4 1 1 1 0 0 4                   |                              |                                 |                              |                                 |                              |                                 |                              |                                 |                                   |                                    |                                  |        |  |  |  |  |  |
| Lew Krausse, R (1, 1)<br>George Alusik, R (5, PH)<br>Ted Bowsfield, R (5, 1)<br>Billy Bryan, L (6, PH) |   |                                 | 4-0 BB                       |                                 | 0-0 6-3                      | 0-0 FC6-5 SH2-4                  |                              | 0-3 K                           |                              | 0 0 0 0 1 0 0                   |                              |                                 |                              |                                 |                              |                                 |                              |                                 |                                   |                                    |                                  |        |  |  |  |  |  |
|  |   |                                 |                              |                                 |                              | 2-H 3-H 1B                       |                              |                                 |                              | 1 0 0 0 0 0 0                   |                              |                                 |                              |                                 |                              |                                 |                              |                                 |                                   |                                    |                                  |        |  |  |  |  |  |
|  |   |                                 |                              |                                 |                              |                                  |                              |                                 |                              | 0 0 0 0 0 0 0                   |                              |                                 |                              |                                 |                              |                                 |                              |                                 |                                   |                                    |                                  |        |  |  |  |  |  |
|  |   |                                 |                              |                                 |                              |                                  |                              |                                 |                              | 2 0 1 2 0 1 0                   |                              |                                 |                              |                                 |                              |                                 |                              |                                 |                                   |                                    |                                  |        |  |  |  |  |  |
| <b>Inning Stats</b>  | R: 0<br>E: 0<br>K: 0<br>S: 3                          | H: 0<br>LOB: 0<br>BB: 0<br>P: 3 | R: 0<br>E: 0<br>K: 1<br>S: 7 | H: 2<br>LOB: 2<br>BB: 0<br>P: 7 | R: 0<br>E: 0<br>K: 2<br>S: 7 | H: 0<br>LOB: 1<br>BB: 1<br>P: 11 | R: 0<br>E: 0<br>K: 2<br>S: 9 | H: 2<br>LOB: 2<br>BB: 0<br>P: 9 | R: 1<br>E: 0<br>K: 1<br>S: 8 | H: 3<br>LOB: 2<br>BB: 0<br>P: 8 | R: 3<br>E: 1<br>K: 0<br>S: 8 | H: 4<br>LOB: 2<br>BB: 0<br>P: 8 | R: 0<br>E: 0<br>K: 2<br>S: 7 | H: 0<br>LOB: 0<br>BB: 0<br>P: 7 | R: 0<br>E: 0<br>K: 1<br>S: 5 | H: 0<br>LOB: 0<br>BB: 0<br>P: 5 | R: 0<br>E: 0<br>K: 1<br>S: 5 | H: 0<br>LOB: 0<br>BB: 0<br>P: 5 | 1B: 10<br>2B: 1<br>3B: 0<br>HR: 0 | SF: 0<br>SAC: 1<br>DP: 0<br>HBP: 0 | WP: 1<br>PB: 0<br>SB: 0<br>CS: 0 | PA: 40 |  |  |  |  |  |
| <b>PITCHER</b>   | IP WLS BF H R ER SO BB IBB HBP BLK WP HR S P ERA WHIP |                                 |                              |                                 |                              |                                  |                              |                                 |                              |                                 |                              |                                 |                              |                                 |                              |                                 |                              |                                 |                                   |                                    |                                  |        |  |  |  |  |  |
| Gary Peters, L (1, 1)<br>ERA: 2.5  | 5.0   |                                 | 26                           | 9                               | 4                            | 3                                | 6                            | 1                               | 0                            | 0                               | 0                            | 1                               | 0                            | 37                              | 41                           | 5.40                            | 2.000                        |                                 |                                   |                                    |                                  |        |  |  |  |  |  |
| Eddie Fisher, R (6, 1)<br>ERA: 3.02  | 3.0   |                                 | 11                           | 2                               | 0                            | 0                                | 3                            | 0                               | 0                            | 0                               | 0                            | 0                               | 0                            | 17                              | 17                           | 0.00                            | 0.667                        |                                 |                                   |                                    |                                  |        |  |  |  |  |  |
| Hoyt Wilhelm, R (9, 1)<br>ERA: 1.99  | 1.0   | W                               | 3                            | 0                               | 0                            | 0                                | 1                            | 0                               | 0                            | 0                               | 0                            | 0                               | 0                            | 5                               | 5                            | 0.00                            | 0.000                        |                                 |                                   |                                    |                                  |        |  |  |  |  |  |

**Kansas City Athletics @ Chicago White Sox**  
Comiskey Park, Chicago, IL

|     |    |
|-----|----|
| AB  | 38 |
| R   | 4  |
| H   | 11 |
| RBI | 4  |
| BB  | 1  |
| SO  | 10 |
| LOB | 18 |

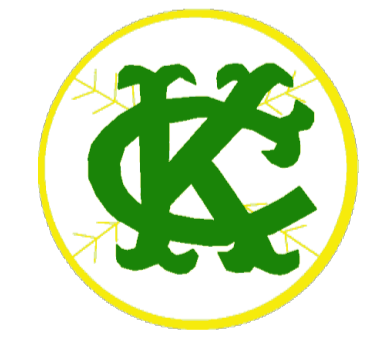

Fri Oct 02 1964, 8:05 PM EDT  
Att: 13,489 - Unknown

livebaseballscorecards.com



| Batter   | 1                 | 2                   | 3          | 4                             | 5                    | 6                               | 7                           | 8                   | 9                              | AB | R | H | RBI | BB | SO | LOB |
|--|-------------------|---------------------|------------|-------------------------------|----------------------|---------------------------------|-----------------------------|---------------------|--------------------------------|----|---|---|-----|----|----|-----|
| Tom McCraw, L (1, 7)<br>OBP: 0.322, SLG: 0.367     | 0-0<br>PB S<br>1B | 0-0<br>4-1          |            | 0-0<br>4-3                    |                      |                                 | 4-0<br>FC1-5 S<br>BB        | 0-3<br>K            |                                | 4  | 1 | 1 | 0   | 1  | 1  | 4   |
| Don Buford, S (1, 4)<br>OBP: 0.339, SLG: 0.352     | 0-3<br>K<br>1-3   |                     | 0-0<br>4-3 |                               | 0-3<br>K             |                                 | 1-0<br>FC1-5<br>HBP<br>1-2  |                     | 0-0<br>PB<br>1B                | 4  | 1 | 1 | 0   | 0  | 2  | 1   |
| Floyd Robinson, L (1, 9)<br>OBP: 0.365, SLG: 0.407 | 4-0<br>1B<br>BB   |                     | 0-0<br>5-3 |                               | 0-0<br>FC6-4<br>1B   |                                 | 0-0<br>FC1-5<br>1-2<br>2-3f |                     | 4-0<br>1B<br>IBB<br>1-3        | 3  | 0 | 1 | 0   | 2  | 0  | 2   |
| Pete Ward, L (1, 5)<br>OBP: 0.350, SLG: 0.472      | 0-0<br>1-3<br>1B  |                     | 0-0<br>F7  |                               | 0-0<br>F6            |                                 | 0-0<br>F5                   |                     | 4-0<br>1-2<br>IBB              | 4  | 0 | 1 | 1   | 1  | 0  | 3   |
| Bill Skowron, R (1, 3)<br>OBP: 0.324, SLG: 0.431   | 0-3<br>K          |                     |            | 0-0<br>1B<br>2B               | 0-0<br>FC6-4<br>1-2f |                                 | 0-3<br>K                    |                     | 0-0<br>1-2<br>2-3<br>3-H<br>1B | 5  | 1 | 2 | 1   | 0  | 2  | 5   |
| Ron Hansen, R (1, 6)<br>OBP: 0.344, SLG: 0.409     | 0-0<br>F7         |                     |            | 4-0<br>1B<br>WP<br>BB         |                      | 0-0<br>WP<br>SH1-4<br>SF8<br>1B |                             | 0-0<br>SH1-4<br>1B  |                                | 3  | 2 | 2 | 0   | 1  | 0  | 2   |
| Ken Berry, R (1, 8)<br>OBP: 0.448, SLG: 0.520      |                   | 0-0<br>SH1-3<br>2B  |            | 0-0<br>WP<br>1-3<br>2-H<br>1B |                      | 0-0<br>SH1-4<br>1-2             |                             | 0-0<br>SH1-4<br>1-2 |                                | 2  | 0 | 2 | 1   | 0  | 0  | 0   |
| J.C. Martin, L (1, 2)<br>OBP: 0.240, SLG: 0.278    |                   | 0-0<br>SH1-3<br>2-3 |            | 0-0<br>F7<br>1-3<br>3-H       |                      | 0-0<br>SF8<br>2-H               |                             | 0-3<br>K            |                                | 2  | 0 | 0 | 1   | 0  | 1  | 2   |
| Gary Peters, L (1, 1)<br>OBP: 0.228, SLG: 0.367    |                   | 0-0<br>1-3          |            | 0-3<br>K2-3                   |                      | 0-3<br>K                        |                             | 4-0<br>IBB          |                                | 2  | 0 | 0 | 0   | 0  | 1  | 2   |
| Eddie Fisher, R (6, 1)<br>OBP: 0.167, SLG: 0.167   |                   |                     |            |                               |                      |                                 |                             |                     |                                | 1  | 0 | 0 | 0   | 0  | 1  | 0   |
| Smoky Burgess, L (8, PH)<br>OBP: 0.311, SLG: 0.324 |                   |                     |            |                               |                      |                                 |                             |                     |                                | 0  | 0 | 0 | 0   | 1  | 0  | 0   |
| Jim Hicks, R (8, PR)                               |                   |                     |            |                               |                      |                                 |                             |                     |                                | 0  | 0 | 0 | 0   | 0  | 0  | 0   |
| Hoyt Wilhelm, R (9, 1)<br>OBP: 0.182, SLG: 0.143   |                   |                     |            |                               |                      |                                 |                             |                     |                                | 0  | 0 | 0 | 0   | 0  | 0  | 0   |

| Inning Stats | R: 1 | H: 2 | E: 0 | K: 2 | S: 9 | H: 2 | LOB: 2 | BB: 1 | P: 13 | R: 0 | H: 1 | E: 0 | K: 0 | S: 4 | R: 0 | H: 0 | E: 0 | K: 0 | S: 3 | R: 2 | H: 2 | E: 0 | K: 1 | S: 7 | R: 0 | H: 1 | E: 0 | K: 1 | S: 6 | R: 1 | H: 1 | E: 0 | K: 1 | S: 6 | R: 0 | H: 0 | E: 0 | K: 1 | S: 5 | R: 0 | H: 1 | E: 0 | K: 2 | S: 8 | R: 1 | H: 2 | E: 0 | K: 0 | S: 2 | 1B: 8 | SF: 1 | 2B: 2 | 3B: 0 | HR: 0 |
|--------------|------|------|------|------|------|------|--------|-------|-------|------|------|------|------|------|------|------|------|------|------|------|------|------|------|------|------|------|------|------|------|------|------|------|------|------|------|------|------|------|------|------|------|------|------|------|------|------|------|------|------|-------|-------|-------|-------|-------|
|--------------|------|------|------|------|------|------|--------|-------|-------|------|------|------|------|------|------|------|------|------|------|------|------|------|------|------|------|------|------|------|------|------|------|------|------|------|------|------|------|------|------|------|------|------|------|------|------|------|------|------|------|-------|-------|-------|-------|-------|

| PITCHER                              | IP  | WLS | BF | H | R | ER | SO | BB | IBB | HBP | BLK | WP | HR | S  | P  | ERA  | WHIP  |
|--------------------------------------|-----|-----|----|---|---|----|----|----|-----|-----|-----|----|----|----|----|------|-------|
| Lew Krausse, R (1, 1)<br>ERA: 7.36   | 4.0 |     | 19 | 5 | 3 | 3  | 3  | 2  | 0   | 0   | 0   | 1  | 0  | 23 | 31 | 6.75 | 1.750 |
| Ted Bowsfield, L (5, 1)<br>ERA: 4.17 | 1.0 |     | 4  | 1 | 0 | 0  | 1  | 0  | 0   | 0   | 0   | 0  | 0  | 6  | 6  | 0.00 | 1.000 |
| Wes Stock, R (6, 1)<br>ERA: 2.3      | 3.0 | L   | 18 | 4 | 2 | 2  | 4  | 1  | 3   | 1   | 0   | 1  | 0  | 21 | 38 | 6.00 | 1.667 |

**BOTTOM**

**Kansas City Athletics @ Chicago White Sox**  
Comiskey Park, Chicago, IL

Fri Oct 02 1964, 8:05 PM EDT  
Att. 13,489 - Unknown

|     |    |
|-----|----|
| AB  | 30 |
| R   | 5  |
| H   | 10 |
| RBI | 4  |
| BB  | 6  |
| SO  | 8  |
| LOB | 21 |



| WP | PA |
|----|----|
| 3  | 41 |

| Batter   | 1  | 2                               | 3                            | 4                               | 5                            | 6                               | 7                            | 8                               | 9                            | AB R H RBI BB SO LOB            | TOP                          |  |                              |                                 |                              |                                 |                              |                                 |                                  |                                    |                                  |        |
|--|--|---------------------------------|------------------------------|---------------------------------|------------------------------|---------------------------------|------------------------------|---------------------------------|------------------------------|---------------------------------|------------------------------|--|------------------------------|---------------------------------|------------------------------|---------------------------------|------------------------------|---------------------------------|----------------------------------|------------------------------------|----------------------------------|--------|
| <b>Bert Campaneris, R</b> (1, 6)<br>OBP: 0.303, SLG: 0.376 | 0-0<br>E4<br>3-1   |                                 | 0-0<br>1-3                   |                                 |                              | 0-3<br>K                        |                              |                                 | 4-0<br>BB                    | 3 0 0 0 1 1 1                   |                              |  |                              |                                 |                              |                                 |                              |                                 |                                  |                                    |                                  |        |
| <b>Wayne Causey, L</b> (1, 4)<br>OBP: 0.379, SLG: 0.388    | 0-0<br>3-1<br>1-2  |                                 |                              | 0-0<br>4-3                      |                              |                                 | 0-0<br>F8                    |                                 | 0-0<br>F8                    | 4 0 0 0 0 0 2                   |                              |  |                              |                                 |                              |                                 |                              |                                 |                                  |                                    |                                  |        |
| <b>Larry Stahl, L</b> (1, 7)<br>OBP: 0.279, SLG: 0.500     | 0-3<br>K   |                                 |                              | 0-0<br>4-3                      |                              |                                 | 0-0<br>L5                    |                                 |                              | 3 0 0 0 0 1 0                   |                              |  |                              |                                 |                              |                                 |                              |                                 |                                  |                                    |                                  |        |
| <b>Rocky Colavito, R</b> (1, 9)<br>OBP: 0.367, SLG: 0.509  |  | 0-0<br>F9                       |                              | 0-0<br>6-3                      |                              |                                 | 0-3<br>K                     |                                 |                              | 3 0 0 0 0 1 0                   |                              |  |                              |                                 |                              |                                 |                              |                                 |                                  |                                    |                                  |        |
| <b>Jim Gentile, L</b> (1, 3)<br>OBP: 0.372, SLG: 0.465     |  | 0-0<br>F5                       |                              |                                 | 0-0<br>6-3                   |                                 |                              | 0-0<br>L3                       |                              | 3 0 0 0 0 0 0                   |                              |  |                              |                                 |                              |                                 |                              |                                 |                                  |                                    |                                  |        |
| <b>Ed Charles, R</b> (1, 5)<br>OBP: 0.322, SLG: 0.382      |  | 0-3<br>K                        |                              |                                 | 0-0<br>6-3                   |                                 |                              | 0-0<br>4-3                      |                              | 3 0 0 0 0 1 0                   |                              |  |                              |                                 |                              |                                 |                              |                                 |                                  |                                    |                                  |        |
| <b>Nelson Mathews, R</b> (1, 8)<br>OBP: 0.294, SLG: 0.379  |  |                                 | 0-0<br>1-3                   |                                 | 0-3<br>K                     |                                 |                              | 0-0<br>5-3                      |                              | 3 0 0 0 0 1 0                   |                              |  |                              |                                 |                              |                                 |                              |                                 |                                  |                                    |                                  |        |
| <b>Dave Duncan, R</b> (1, 2)<br>OBP: 0.212, SLG: 0.280     |  |                                 | 0-0<br>1B                    |                                 |                              | 0-0<br>6-3                      |                              |                                 | 0-0<br>G4-6-3<br>1B          | 3 0 2 0 0 0 0                   |                              |  |                              |                                 |                              |                                 |                              |                                 |                                  |                                    |                                  |        |
| <b>John O'Donoghue, R</b> (1, 1)<br>OBP: 0.236, SLG: 0.291 |  |                                 | 0-3<br>K                     |                                 |                              | 0-3<br>K                        |                              |                                 | 0-0<br>G4-6-3                | 1 0 0 0 0 1 1                   |                              |  |                              |                                 |                              |                                 |                              |                                 |                                  |                                    |                                  |        |
| <b>Jose Tartabull, L</b> (6, PH)<br>OBP: 0.240, SLG: 0.222 |  |                                 |                              |                                 |                              |                                 |                              |                                 | 1-2f                         | 1 0 0 0 0 1 0                   |                              |  |                              |                                 |                              |                                 |                              |                                 |                                  |                                    |                                  |        |
| <b>Orlando Pena, R</b> (6, 1)<br>OBP: 0.200, SLG: 0.213    |  |                                 |                              |                                 |                              |                                 |                              |                                 |                              | 0 0 0 0 0 0 0                   |                              |  |                              |                                 |                              |                                 |                              |                                 |                                  |                                    |                                  |        |
| <b>Manny Jimenez, L</b> (9, PH)<br>OBP: 0.293, SLG: 0.436  |  |                                 |                              |                                 |                              |                                 |                              |                                 |                              | 1 0 0 0 0 0 1                   |                              |  |                              |                                 |                              |                                 |                              |                                 |                                  |                                    |                                  |        |
| <b>Inning Stats</b>  | R: 0<br>E: 1<br>K: 1<br>S: 5   | H: 0<br>LOB: 0<br>BB: 0<br>P: 5 | R: 0<br>E: 0<br>K: 1<br>S: 5 | H: 0<br>LOB: 0<br>BB: 0<br>P: 5 | R: 0<br>E: 0<br>K: 1<br>S: 6 | H: 1<br>LOB: 1<br>BB: 0<br>P: 6 | R: 0<br>E: 0<br>K: 1<br>S: 3 | H: 0<br>LOB: 0<br>BB: 0<br>P: 3 | R: 0<br>E: 0<br>K: 1<br>S: 5 | H: 0<br>LOB: 0<br>BB: 0<br>P: 5 | R: 0<br>E: 0<br>K: 2<br>S: 7 | H: 0<br>LOB: 0<br>BB: 0<br>P: 7  | R: 0<br>E: 0<br>K: 1<br>S: 5 | H: 0<br>LOB: 0<br>BB: 0<br>P: 5 | R: 0<br>E: 0<br>K: 0<br>S: 3 | H: 0<br>LOB: 0<br>BB: 0<br>P: 3 | R: 0<br>E: 0<br>K: 0<br>S: 3 | H: 1<br>LOB: 1<br>BB: 1<br>P: 7 | 1B: 2<br>2B: 0<br>3B: 0<br>HR: 0 | SF: 0<br>SAC: 0<br>DP: 1<br>HBP: 0 | WP: 0<br>PB: 0<br>SB: 0<br>CS: 0 | PA: 29 |
| <b>PITCHER</b><br><b>Joe Horlen, R</b> (1, 1)<br>ERA: 1.88 | IP: 9.0<br>WLS: W<br>BF: 29<br>H: 2<br>R: 0<br>ER: 0<br>SO: 7<br>BB: 1<br>IBB: 0<br>HBP: 0<br>BLK: 0<br>WP: 0<br>HR: 0<br>S: 42<br>P: 46<br>ERA: 0.00<br>WHIP: 0.333 |                                 |                              |                                 |                              |                                 |                              |                                 |                              |                                 |                              | <b>PITCHER</b><br>IP: WLS: BF: H: R: ER: SO: BB: IBB: HBP: BLK: WP: HR: S: P: ERA: WHIP: |                              |                                 |                              |                                 |                              |                                 |                                  |                                    |                                  |        |

**Kansas City Athletics @ Chicago White Sox**  
 Comiskey Park, Chicago, IL  
 Sat Oct 03 1964, 4:33 AM EDT  
 Att. 3,388 - Unknown

|     |    |
|-----|----|
| AB  | 28 |
| R   | 0  |
| H   | 2  |
| RBI | 0  |
| BB  | 1  |
| SO  | 7  |
| LOB | 5  |



| Batter   | 1          | 2              | 3                  | 4                        | 5                | 6                    | 7          | 8                  | 9 |
|--|------------|----------------|--------------------|--------------------------|------------------|----------------------|------------|--------------------|---|
| Mike Hershberger, R (1, 9)<br>OBP: 0.309, SLG: 0.290 | 0-0<br>6-3 |                | 0-0<br>FC4-6<br>1B | 0-0<br>2-H<br>3B         |                  | 4-0<br>WP<br>S<br>BB |            | 0-0<br>F7          |   |
| Floyd Robinson, L (1, 7)<br>OBP: 0.385, SLG: 0.405   | 0-0<br>4-3 |                | 0-0<br>FC4-6<br>1B | 0-0<br>4-3               |                  | 4-0<br>BB            |            | 4-0<br>1B<br>BB    |   |
| Ron Hansen, R (1, 6)<br>OBP: 0.346, SLG: 0.413       | 0-0<br>5-3 |                | 4-0<br>1B<br>BB    |                          | 0-0<br>SF9<br>3B | 0-0<br>1-3           |            | 0-0<br>1B<br>1B    |   |
| Bill Skowron, R (1, 3)<br>OBP: 0.323, SLG: 0.430     |            | 0-0<br>6-3     | 0-0<br>E<br>1B     |                          | 0-0<br>SF9       |                      | 0-0<br>F8  | 0-0<br>FC4-6<br>1B |   |
| Tom McCraw, L (8, 3)<br>OBP: 0.323, SLG: 0.369       |            |                | 1-3<br>2-H<br>1B   |                          | 3-H<br>K         |                      | 0-0<br>E3  | 0-0<br>FC4-6<br>1B |   |
| Pete Ward, L (1, 5)<br>OBP: 0.348, SLG: 0.475        |            | 0-0<br>HR      | 0-0<br>E4          |                          | 0-3<br>K         |                      | 0-0<br>E3  | 0-0<br>FC4-6       |   |
| Ken Berry, R (1, 8)<br>OBP: 0.455, SLG: 0.500        |            | 0-0<br>E<br>1B | 0-0<br>6-3         |                          | 4-0<br>BB        |                      | 0-0<br>4-3 |                    |   |
| Al Weis, S (1, 4)<br>OBP: 0.299, SLG: 0.302          |            | 0-0<br>E5      |                    | 0-0<br>6-3               | 0-0<br>L5        |                      | 0-0<br>F7  |                    |   |
| Cam Carreon, R (1, 2)<br>OBP: 0.330, SLG: 0.326      |            | 0-0<br>G5-4-3  |                    | 0-0<br>SH1-4<br>3B<br>1B |                  | 0-0<br>F3            |            | 0-0<br>BB<br>1B    |   |
| Joe Horten, R (1, 1)<br>OBP: 0.183, SLG: 0.159       |            |                | 0-0<br>5-3         | 0-0<br>SH1-4             |                  | 0-0<br>6-3           |            | 0-0<br>F9          |   |

| Inning Stats | R: 0   | H: 0  | E: 0 | K: 0   | S: 3  | R: 1 | H: 2   | E: 1  | K: 0  | S: 5   | R: 2  | H: 2 | E: 1   | K: 0  | S: 6  | R: 1   | H: 1  | E: 0  | K: 1   | S: 6  | R: 0 | H: 0   | E: 0  | K: 0  | S: 3   | R: 0  | H: 0 | E: 1   | K: 0  | S: 4  | R: 2   | H: 3   | E: 0  | K: 0   | S: 6  | R: 0  | H: 0  | E: 1  | K: 0  | S: 4   |       |        |
|--------------|--------|-------|------|--------|-------|------|--------|-------|-------|--------|-------|------|--------|-------|-------|--------|-------|-------|--------|-------|------|--------|-------|-------|--------|-------|------|--------|-------|-------|--------|--------|-------|--------|-------|-------|-------|-------|-------|--------|-------|--------|
|              | LOB: 0 | BB: 0 | P: 3 | LOB: 1 | BB: 0 | P: 5 | LOB: 2 | BB: 1 | P: 10 | LOB: 1 | BB: 0 | P: 5 | LOB: 1 | BB: 1 | P: 10 | LOB: 2 | BB: 2 | P: 11 | LOB: 1 | BB: 0 | P: 4 | LOB: 2 | BB: 2 | P: 11 | LOB: 1 | BB: 0 | P: 4 | LOB: 2 | BB: 1 | P: 10 | LOB: 0 | SAC: 1 | DP: 1 | HBP: 0 | 1B: 7 | 2B: 0 | 3B: 2 | HR: 1 | SF: 1 | SAC: 1 | DP: 1 | HBP: 0 |

| PITCHER                                | IP  | WLS | BF | H | R | ER | SO | BB | IBB | HBP | BLK | WP | HR | S  | P  | ERA  | WHIP  |
|--|-----|-----|----|---|---|----|----|----|-----|-----|-----|----|----|----|----|------|-------|
| John O'Donoghue, L (1, 1)<br>ERA: 4.92 | 5.0 | L   | 25 | 7 | 5 | 4  | 1  | 2  | 0   | 0   | 0   | 0  | 1  | 25 | 33 | 7.20 | 1.800 |
| Orlando Pena, R (6, 1)<br>ERA: 4.43    | 3.0 |     | 16 | 3 | 2 | 2  | 0  | 3  | 0   | 0   | 0   | 1  | 0  | 13 | 25 | 6.00 | 2.000 |

**BOTTOM**

**Kansas City Athletics @ Chicago White Sox**  
Comiskey Park, Chicago, IL

Sat Oct 03 1964, 4:33 AM EDT  
Att. 3,388 - Unknown

|     |    |
|-----|----|
| AB  | 34 |
| R   | 7  |
| H   | 10 |
| RBI | 6  |
| BB  | 5  |
| SO  | 1  |
| LOB | 17 |



| WP | HR | S | P | ERA  | WHIP  |
|----|----|---|---|------|-------|
| 1  | 0  | 0 | 0 | 4.92 | 1.800 |
| 0  | 0  | 0 | 0 | 4.43 | 2.000 |

| Batter  | 1  | 2                               | 3                            | 4                               | 5                                 | 6                               | 7                            | 8                               | 9  | AB R H RBI BB SO LOB             | TOP                          |                                 |  |                                  |                                  |                                    |                                  |        |
|---|--|---------------------------------|------------------------------|---------------------------------|-----------------------------------|---------------------------------|------------------------------|---------------------------------|--|----------------------------------|------------------------------|---------------------------------|--|----------------------------------|----------------------------------|------------------------------------|----------------------------------|--------|
| Bert Campaneris, R (1, 6)<br>OBP: 0.306, SLG: 0.375   | 0-0<br>FC6-4<br>1B   |                                 | 0-0<br>F4                    |                                 |                                   | 0-0<br>6-3                      |                              |                                 | 1-0<br>BB<br>BB<br>HBP                             | 3 0 1 0 0 0 0                    |                              |                                 |  |                                  |                                  |                                    |                                  |        |
| Larry Stahl, L (1, 7)<br>OBP: 0.277, SLG: 0.478       | 0-0<br>FC6-4<br>BB<br>1-2f   |                                 |                              | 0-3<br>K                        |                                   |                                 | 0-0<br>1B                    |                                 | 0-0<br>F6  | 4 0 1 0 0 1 2                    |                              |                                 |  |                                  |                                  |                                    |                                  |        |
| Ken Harrelson, R (1, 3)<br>OBP: 0.263, SLG: 0.388     | 4-0<br>G6-4-3<br>BB<br>1-2   |                                 |                              | 0-0<br>1-3                      |                                   |                                 | 0-3<br>K                     |                                 | 4-0<br>BB<br>BB<br>1-2                             | 2 0 0 0 2 1 1                    |                              |                                 |  |                                  |                                  |                                    |                                  |        |
| Rocky Colavito, R (1, 9)<br>OBP: 0.366, SLG: 0.507    | 0-0<br>G6-4-3<br>1-2f  |                                 |                              | 0-0<br>G3                       |                                   |                                 | 0-3<br>K                     |                                 | 4-0<br>BB<br>BB<br>BB<br>1-2<br>2-3<br>FC6-4<br>BB | 3 0 0 0 1 1 3                    |                              |                                 |  |                                  |                                  |                                    |                                  |        |
| Ed Charles, R (1, 5)<br>OBP: 0.322, SLG: 0.379        |  | 0-0<br>F2                       |                              |                                 | 4-0<br>BB<br>BB<br>BB<br>CS<br>BB |                                 | 0-3<br>K                     |                                 | 0-0<br>FC6-4<br>1-2f                               | 3 0 0 0 1 1 4                    |                              |                                 |  |                                  |                                  |                                    |                                  |        |
| Nelson Mathews, R (1, 8)<br>OBP: 0.293, SLG: 0.377    |  | 0-0<br>5-3                      |                              |                                 | 0-3<br>K<br>1-2                   |                                 |                              | 0-0<br>F5                       |  | 3 0 0 0 0 1 1                    |                              |                                 |  |                                  |                                  |                                    |                                  |        |
| Dave Duncan, R (1, 2)<br>OBP: 0.200, SLG: 0.264       |  | 0-0<br>5-3                      |                              |                                 | 0-0<br>6-3                        |                                 |                              | 0-0<br>4-3                      |  | 3 0 0 0 0 0 0                    |                              |                                 |  |                                  |                                  |                                    |                                  |        |
| Wayne Causey, L (1, 4)<br>OBP: 0.377, SLG: 0.386      |  |                                 | 0-0<br>G3                    |                                 |                                   | 0-0<br>6-3                      |                              | 0-0<br>F8                       |  | 3 0 0 0 0 0 0                    |                              |                                 |  |                                  |                                  |                                    |                                  |        |
| Diego Segui, R (1, 1)<br>OBP: 0.200, SLG: 0.211       |  |                                 | 0-3<br>K                     |                                 |                                   | 0-3<br>K                        |                              |                                 | 0-3<br>K   | 2 0 0 0 0 2 0                    |                              |                                 |  |                                  |                                  |                                    |                                  |        |
| Ted Bowsfield, R (7, 1)<br>OBP: 0.174, SLG: 0.095     |  |                                 |                              |                                 |                                   |                                 |                              |                                 |  | 0 0 0 0 0 0 0                    |                              |                                 |  |                                  |                                  |                                    |                                  |        |
| Jose Tartabull, L (9, PH)<br>OBP: 0.238, SLG: 0.220   |  |                                 |                              |                                 |                                   |                                 |                              |                                 |  | 1 0 0 0 0 1 0                    |                              |                                 |  |                                  |                                  |                                    |                                  |        |
| <b>Inning Stats</b>                                   | R: 0<br>E: 0<br>K: 0<br>S: 3   | H: 1<br>LOB: 1<br>BB: 1<br>P: 7 | R: 0<br>E: 0<br>K: 0<br>S: 3 | H: 0<br>LOB: 0<br>BB: 0<br>P: 3 | R: 0<br>E: 0<br>K: 1<br>S: 5      | H: 0<br>LOB: 0<br>BB: 0<br>P: 5 | R: 0<br>E: 0<br>K: 1<br>S: 5 | H: 0<br>LOB: 0<br>BB: 0<br>P: 5 | R: 0<br>E: 0<br>K: 3<br>S: 10                      | H: 1<br>LOB: 1<br>BB: 0<br>P: 10 | R: 0<br>E: 0<br>K: 0<br>S: 3 | H: 0<br>LOB: 0<br>BB: 0<br>P: 3 | R: 0<br>E: 0<br>K: 1<br>S: 5   | H: 0<br>LOB: 3<br>BB: 2<br>P: 14 | 1B: 2<br>2B: 1<br>3B: 0<br>HR: 0 | SF: 0<br>SAC: 0<br>DP: 2<br>HBP: 1 | WP: 0<br>PB: 0<br>SB: 0<br>CS: 1 | PA: 32 |
| <b>PITCHER</b><br>Bruce Howard, R (1, 1)<br>ERA: 0.81 | IP: 9.0<br>WLS: W<br>BF: 32<br>H: 2<br>R: 0<br>ER: 0<br>SO: 8<br>BB: 4<br>IBB: 0<br>HBP: 1<br>BLK: 0<br>WP: 0<br>HR: 0<br>S: 43<br>P: 60<br>ERA: 0.00<br>WHIP: 0.667 |                                 |                              |                                 |                                   |                                 |                              |                                 |  |                                  |                              | <b>PITCHER</b>                  | IP: WLS: BF: H: R: ER: SO: BB: IBB: HBP: BLK: WP: HR: S: P: ERA: WHIP: |                                  |                                  |                                    |                                  |        |

**Kansas City Athletics @ Chicago White Sox**  
 Comiskey Park, Chicago, IL  
 Sun Oct 04 1964, 4:33 AM EDT  
 Att. 6,232 - Unknown

|     |    |
|-----|----|
| AB  | 27 |
| R   | 0  |
| H   | 2  |
| RBI | 0  |
| BB  | 4  |
| SO  | 8  |
| LOB | 11 |



| Batter  | 1          | 2         | 3               | 4                          | 5                | 6                            | 7                  | 8                   | 9 | AB | R | H | RBI | BB | SO | LOB |
|---|------------|-----------|-----------------|----------------------------|------------------|------------------------------|--------------------|---------------------|---|----|---|---|-----|----|----|-----|
| Tom McCraw, L<br>OBP: 0.325, SLG: 0.367<br>(1, 7)<br>(7, 3)   | 0-0<br>F6  |           |                 | 4-0<br>F7<br>S<br>1B<br>BB |                  | 4-0<br>WP<br>E<br>BB         | 0-0<br>F5          |                     |   | 2  | 2 | 0 | 0   | 2  | 0  | 0   |
| Don Buford, S<br>OBP: 0.337, SLG: 0.348<br>(1, 4)   | 0-0<br>4-3 |           |                 | 0-0<br>F7<br>1-3           |                  | 0-0<br>E8<br>1B<br>1-H<br>1B | 0-0<br>1-3         |                     |   | 4  | 1 | 0 | 0   | 0  | 0  | 1   |
| Floyd Robinson, L<br>OBP: 0.388, SLG: 0.408<br>(1, 9)<br>(7, 7)   | 0-0<br>3-1 |           |                 | 0-0<br>S<br>1B             |                  | 0-0<br>FC6-4<br>HR<br>1B     | 0-0<br>FC1-6<br>1B |                     |   | 4  | 1 | 3 | 1   | 0  | 0  | 0   |
| Pete Ward, L<br>OBP: 0.348, SLG: 0.473<br>(1, 5)  |            | 0-0<br>F6 |                 | 0-3<br>K<br>1-2            |                  | 0-0<br>FC6-4<br>1B           | 0-0<br>FC1-6       |                     |   | 4  | 0 | 1 | 1   | 0  | 1  | 2   |
| Bill Skowron, R<br>OBP: 0.322, SLG: 0.428<br>Mike Hershberger, R<br>OBP: 0.308, SLG: 0.290<br>(1, 3)<br>(6, PR)<br>(7, 9) |            | 0-3<br>K  |                 | 0-3<br>K                   |                  | 0-0<br>FC6-4<br>HR           |                    | 0-0<br>F9           |   | 3  | 0 | 0 | 0   | 0  | 2  | 3   |
| Ron Hansen, R<br>OBP: 0.347, SLG: 0.419<br>(1, 6)   |            | 0-0<br>F6 |                 |                            | 0-0<br>5-3       | 0-0<br>HR                    |                    | 0-0<br>G6-4-3<br>1B |   | 4  | 1 | 2 | 3   | 0  | 0  | 0   |
| Ken Berry, R<br>OBP: 0.459, SLG: 0.500<br>(1, 8)  |            |           | 0-0<br>CS<br>1B |                            | 0-0<br>FC6<br>1B | 0-3<br>K                     |                    | 0-0<br>G6-4-3       |   | 4  | 0 | 2 | 0   | 0  | 1  | 2   |
| J.C. Martin, L<br>OBP: 0.241, SLG: 0.279<br>(1, 2)  |            |           | 0-0<br>F9       |                            | 0-0<br>F8        | 0-0<br>1B                    |                    |                     |   | 3  | 0 | 1 | 0   | 0  | 0  | 2   |
| Bruce Howard, S<br>(1, 1)   |            |           | 0-3<br>K        |                            | 0-0<br>FC6       | 0-0<br>F9                    |                    |                     |   | 3  | 0 | 0 | 0   | 0  | 1  | 3   |

| Inning Stats | R: 0  | H: 0  | E: 0   | LOB: 0 | K: 0  | BB: 0 | S: 3   | P: 3  | R: 0   | H: 0  | E: 0  | LOB: 0 | K: 1   | BB: 0 | S: 5  | P: 5  | R: 0   | H: 1  | E: 0   | LOB: 1 | K: 1  | BB: 0 | S: 5   | P: 5  | R: 1  | H: 1  | E: 0   | LOB: 1 | K: 2   | BB: 1 | S: 8  | P: 12 | R: 0   | H: 1  | E: 0  | LOB: 1 | K: 0   | BB: 0 | S: 4   | P: 4  | R: 5  | H: 4  | E: 1   | LOB: 1 | K: 1  | BB: 1 | S: 10  | P: 14 | R: 0   | H: 1 | E: 0 | LOB: 1 | K: 0 | BB: 0 | S: 3 | P: 3 | R: 0 | H: 1 | E: 0 | LOB: 0 | K: 0 | BB: 0 | S: 3 | P: 3 |
|--------------|-------|-------|--------|--------|-------|-------|--------|-------|--------|-------|-------|--------|--------|-------|-------|-------|--------|-------|--------|--------|-------|-------|--------|-------|-------|-------|--------|--------|--------|-------|-------|-------|--------|-------|-------|--------|--------|-------|--------|-------|-------|-------|--------|--------|-------|-------|--------|-------|--------|------|------|--------|------|-------|------|------|------|------|------|--------|------|-------|------|------|
| 1B: 8        | SF: 0 | 2B: 1 | SAC: 0 | 3B: 0  | DP: 2 | HR: 1 | HBP: 0 | WP: 1 | PA: 34 | 1B: 8 | SF: 0 | 2B: 1  | SAC: 0 | 3B: 0 | DP: 2 | HR: 1 | HBP: 0 | WP: 1 | PA: 34 | 1B: 8  | SF: 0 | 2B: 1 | SAC: 0 | 3B: 0 | DP: 2 | HR: 1 | HBP: 0 | WP: 1  | PA: 34 | 1B: 8 | SF: 0 | 2B: 1 | SAC: 0 | 3B: 0 | DP: 2 | HR: 1  | HBP: 0 | WP: 1 | PA: 34 | 1B: 8 | SF: 0 | 2B: 1 | SAC: 0 | 3B: 0  | DP: 2 | HR: 1 | HBP: 0 | WP: 1 | PA: 34 |      |      |        |      |       |      |      |      |      |      |        |      |       |      |      |

| PITCHER                                | IP  | WLS | BF | H | R | ER | SO | BB | IBB | HBP | BLK | WP | HR | S  | P  | ERA  | WHIP  |
|--|-----|-----|----|---|---|----|----|----|-----|-----|-----|----|----|----|----|------|-------|
| Diego Segui, R<br>ERA: 4.56<br>(1, 1)  | 6.0 | L   | 27 | 7 | 6 | 5  | 5  | 2  | 0   | 0   | 0   | 1  | 1  | 35 | 43 | 7.50 | 1.500 |
| Ted Bowsfield, L<br>ERA: 4.1<br>(7, 1) | 2.0 |     | 7  | 2 | 0 | 0  | 0  | 0  | 0   | 0   | 0   | 0  | 0  | 7  | 7  | 0.00 | 1.000 |

**BOTTOM**

**Kansas City Athletics @ Chicago White Sox**  
Comiskey Park, Chicago, IL

Sun Oct 04 1964, 4:33 AM EDT  
Att. 6,232 - Unknown

|     |    |
|-----|----|
| AB  | 32 |
| R   | 6  |
| H   | 9  |
| RBI | 5  |
| BB  | 2  |
| SO  | 5  |
| LOB | 13 |

