

**New York Giants - 1954**





Brooklyn Dodgers @ New York Giants  
 Polo Grounds, New York, NY  
 Wed Apr 14 1954, 3:33 AM EST  
 Att. 32,436 - Unknown

livebaseballscorecards.com

AB	36
R	6
H	12
RBI	5
BB	7
SO	4
LOB	22



WP:	0	PA:	45
PB:	0		
SB:	1		
CS:	0		

Batter	1	2	3	4	5	6	7	8	9	AB	R	H	RBI	BB	SO	LOB
Jim Gilliam, S OBP: 0.400, SLG: 0.625 (1, 4)	0-0 F9	0-1 1B		1-0 HR	2-2 F9		3-2 L3			5	1	2	1	0	0	2
Pee Wee Reese, R OBP: 0.600, SLG: 0.667 (1, 6)	0-2 BLK	1-1 1B		3-3 K		4-2 SH1-4 1B BB		3-3 K		4	1	2	1	1	2	0
Duke Snider, L OBP: 0.500, SLG: 0.500 (1, 8)	0-3 K	4-0 1B		0-0 6-3		0-1 F8-5 SH1-4 1B		4-1 BB		3	0	1	0	2	1	0
Jackie Robinson, R OBP: 0.375, SLG: 0.167 (1, 7) Don Thompson, L (8, 7)	4-2 FC6-4 BB	2-1 F7		4-2 BB		0-0 SH1-4		1-1 L7		2	0	0	0	2	0	4
Roy Campanella, R OBP: 0.333, SLG: 1.000 (1, 2)	1-0 FC6-4		1-1 F7	2-1 2-3		4-0 IBB		0-1 4-3		4	0	0	0	1	0	3
Gil Hodges, R OBP: 0.444, SLG: 1.000 (1, 3)		1-0 FC1-4 BB SF8 1B	0-0 HR		0-1 1B FC1-6-4 2B		0-2 F8-5		0-1 5-3	5	3	3	1	0	0	3
Carl Furillo, R OBP: 0.444, SLG: 0.375 (1, 9)		4-1 FC1-4 BB	2-2 S 1B		0-0 FC1-6-4 1B		3-2 L8		3-1 1B	4	0	3	0	1	0	0
Billy Cox, R OBP: 0.222, SLG: 0.333 (1, 5)		1-2 FC1-4 1B	1-0 F4		0-0 F4		1-0 2B		1-0 F6	5	1	1	0	0	0	6
Don Newcombe, L (1, 1)		1-0 SF8	2-3 K		1-0 FC1-6-4		2-2 F7		2-1 4-3	4	0	0	2	0	1	4

Inning Stats	R: 1	H: 1	E: 0	K: 1	S: 10	P: 15	R: 2	H: 3	E: 0	K: 0	S: 12	P: 26	R: 1	H: 2	E: 0	K: 1	S: 11	P: 17	R: 1	H: 1	E: 0	K: 1	S: 10	P: 20	R: 1	H: 2	E: 0	K: 0	S: 8	P: 11	R: 0	H: 1	E: 0	K: 0	S: 8	P: 16	R: 0	H: 1	E: 0	K: 0	S: 12	P: 21	R: 0	H: 0	E: 0	K: 1	S: 8	P: 16	R: 0	H: 1	E: 0	K: 0	S: 7	P: 13	1B: 7	SF: 1	2B: 3	SAC: 1	3B: 1	DP: 1	HR: 2	HBP: 0	WP: 0	PA: 45
--------------	------	------	------	------	-------	-------	------	------	------	------	-------	-------	------	------	------	------	-------	-------	------	------	------	------	-------	-------	------	------	------	------	------	-------	------	------	------	------	------	-------	------	------	------	------	-------	-------	------	------	------	------	------	-------	------	------	------	------	------	-------	-------	-------	-------	--------	-------	-------	-------	--------	-------	--------

PITCHER	IP	WLS	BF	H	R	ER	SO	BB	IBB	HBP	BLK	WP	HR	S	P	ERA	WHIP
Ruben Gomez, R ERA: 16.2 (1, 1)	1.2	L	11	4	3	3	1	2	0	0	1	0	0	20	33	16.20	3.600
Al Corwin, R ERA: 6.75 (2, 1)	1.1		7	2	1	1	1	1	0	0	0	0	1	13	25	6.75	2.250
Larry Jansen, R ERA: 9.0 (4, 1)	2.0		10	3	2	2	1	1	0	0	0	0	1	18	31	9.00	2.000
Mario Picone, R ERA: (6, 1)	3.0		13	2	0	0	1	2	1	0	0	0	0	28	53	0.00	1.333
Hoyt Wilhelm, R ERA: (9, 1)	1.0		4	1	0	0	0	0	0	0	0	0	0	7	13	0.00	1.000



Batter	1	2	3	4	5	6	7	8	9	AB R H RBI BB SO LOB	TOP
Davey Williams, R OBP: 0.167, SLG: 0.091 (1, 4) X	0-0 G1-6-3 1B		0-0 G3		0-0 G5-3 2-3f					3 0 1 0 0 0 2	<b>New York Giants @ Philadelphia Phillies</b> Connie Mack Stadium, Philadelphia, PA Thu Apr 15 1954, 3:33 AM EST Att. 15,345 - Unknown <a href="http://livebaseballscorecards.com">livebaseballscorecards.com</a>
Alvin Dark, R OBP: 0.364, SLG: 0.636 (1, 6) X	0-0 G1-6-3 1-2f			0-0 2B 1B		0-0 F7				3 0 1 0 0 0 1	
Hank Thompson, L OBP: 0.545, SLG: 1.000 (1, 5) X	0-0 F2			0-0 F2		0-0 3B				3 0 1 0 0 0 1	
Monte Irvin, R (1, 7)		0-0 6-3		0-0 P4		0-0 1-3				3 0 0 0 0 0 2	
Willie Mays, R OBP: 0.273, SLG: 0.818 (1, 8)		0-0 P6		0-0 1-3 2B		0-0 L4				3 0 1 0 0 0 1	
Whitey Lockman, L (1, 3)		4-0 BB		0-0 F7		0-0 L9				2 0 0 0 1 0 2	
Bill Taylor, L OBP: 0.250, SLG: 0.250 (1, 9)		0-0 1-3			0-0 G5-3 1B 1B		0-0 4-3			3 0 1 0 0 0 1	
Ebba St. Claire, S OBP: 0.400, SLG: 0.625 (1, 2)			0-0 P6		0-0 F9		0-0 1B			3 0 1 0 0 0 1	
Ron Samford, R (7, PR)										0 0 0 0 0 0 0	
Wes Westrum, R (7, 2)										0 0 0 0 0 0 0	
Johnny Antonelli, L OBP: 0.333, SLG: 0.333 (1, 1)			0-0 1-3		0-0 1-2 1B		0-0 4-3			3 0 1 0 0 0 1	
<b>Inning Stats</b>	R: 0 H: 1 E: 0 LOB: 0 K: 0 BB: 0 S: 3 P: 3	R: 0 H: 0 E: 0 LOB: 1 K: 0 BB: 1 S: 3 P: 7	R: 0 H: 0 E: 0 LOB: 0 K: 0 BB: 0 S: 3 P: 3	R: 0 H: 2 E: 0 LOB: 2 K: 0 BB: 0 S: 5 P: 5	R: 0 H: 2 E: 0 LOB: 1 K: 0 BB: 0 S: 4 P: 4	R: 0 H: 1 E: 0 LOB: 1 K: 0 BB: 0 S: 4 P: 4	R: 0 H: 1 E: 0 LOB: 1 K: 0 BB: 0 S: 4 P: 4			1B: 5 SF: 0 2B: 1 SAC: 0 3B: 1 DP: 2 HR: 0 HBP: 0	WP: 0 PA: 27 PB: 0 SB: 0 CS: 0
<b>PITCHER</b> Murry Dickson, R (1, 1) ERA:	IP WLS BF H R ER SO BB IBB HBP BLK WP HR S P ERA WHIP	7.0 W 27 7 0 0 0 1 0 0 0 0 0 0 26 30 0.00 1.143									



Batter	1	2	3	4	5	6	7	8	9	AB	R	H	RBI	BB	SO	LOB
Willie Jones, R OBP: 0.818, SLG: 1.250 (1, 5)	0-0 F9		0-0 1B			4-0 SH3-4 1B BB				2	1	1	0	1	0	0
Richie Ashburn, L OBP: 0.091, SLG: 0.091 (1, 8)	0-0 6-3		0-3 K			0-0 SH3-4				2	0	0	0	0	1	2
Earl Torgeson, L (1, 3)	0-3 K			0-3 K		0-0 4-3				3	0	0	0	0	2	1
Del Ennis, R OBP: 0.417, SLG: 0.400 (1, 7)		0-0 F7		0-3 K		0-0 1B 1B				3	0	1	1	0	1	0
Granny Hamner, R OBP: 0.417, SLG: 0.417 (1, 4)		0-0 4-3		0-0 6-3		0-0 3-H 1B				3	0	1	0	0	0	0
Mel Clark, R OBP: 0.143, SLG: 0.143 (1, 9)		0-0 6-3			0-0 4-3	0-0 G3				3	0	0	0	0	0	2
Ted Kazanski, R (1, 6)			0-0 L7		0-0 E1 PB SF9		0-0			3	1	0	0	0	0	0
Stan Lopata, R OBP: 0.500, SLG: 0.714 (1, 2)			4-0 1B BB		0-0 SF9		2-H			0	0	0	1	1	0	0
Murry Dickson, R (1, 1)			0-3 K		0-0 4-3					2	0	0	0	0	1	1

<b>Inning Stats</b>	R: 0 E: 0 K: 1 S: 5	H: 0 LOB: 0 BB: 0 P: 5	R: 0 E: 0 K: 0 S: 3	H: 0 LOB: 0 BB: 0 P: 3	R: 0 E: 0 K: 2 S: 8	H: 1 LOB: 2 BB: 1 P: 12	R: 0 E: 0 K: 2 S: 7	H: 0 LOB: 0 BB: 0 P: 7	R: 1 E: 1 K: 0 S: 4	H: 0 LOB: 0 BB: 0 P: 4	R: 1 E: 0 K: 0 S: 5	H: 2 LOB: 2 BB: 1 P: 9	R: 0 E: 0 K: 0 S: 0	H: 0 LOB: 0 BB: 0 P: 0	1B: 3 2B: 0 3B: 0 HR: 0	SF: 1 SAC: 1 DP: 0 HBP: 0
---------------------	------------------------------	---------------------------------	------------------------------	---------------------------------	------------------------------	----------------------------------	------------------------------	---------------------------------	------------------------------	---------------------------------	------------------------------	---------------------------------	------------------------------	---------------------------------	----------------------------------	------------------------------------

<b>PITCHER</b> Johnny Antonelli, L ERA: 1.5 (1, 1)	IP: 6.0 WLS: L BF: 25 H: 3 R: 2 ER: 1 SO: 5 BB: 2 IBB: 0 HBP: 0 BLK: 0 WP: 0 HR: 0 S: 32 P: 40 ERA: 1.50 WHIP: 0.833	<b>PITCHER</b>	IP: 0 WLS: 0 BF: 0 H: 0 R: 0 ER: 0 SO: 0 BB: 0 IBB: 0 HBP: 0 BLK: 0 WP: 0 HR: 0 S: 0 P: 0 ERA: 0 WHIP: 0
--	--	----------------	--

**BOTTOM**

**New York Giants @ Philadelphia Phillies**  
**Connie Mack Stadium, Philadelphia, PA**  
 Thu Apr 15 1954, 3:33 AM EST  
 Att. 15,345 - Unknown

<b>AB</b>	<b>21</b>
<b>R</b>	<b>2</b>
<b>H</b>	<b>3</b>
<b>RBI</b>	<b>2</b>
<b>BB</b>	<b>2</b>
<b>SO</b>	<b>5</b>
<b>LOB</b>	<b>6</b>



WP: 0 PB: 1 SB: 0 CS: 0	PA: 25
----------------------------------	--------

livebaseballscorecards.com







Batter	1	2	3	4	5	6	7	8	9	AB R H RBI BB SO LOB	TOP											
Dick Smith, R OBP: 0.429, SLG: 0.545 (1, 5) X	0-0 HR 2B		FC1-6 BB 1-2f			4-0 BB		0-0 P5		3 1 1 0 2 0 2												
Bob Skinner, L OBP: 0.273, SLG: 0.273 (1, 3) X	0-0 P4		FC1-6 BB 1-2f	0-0 1B		0-3 K		0-3 K		5 1 1 0 0 2 3												
Gail Henley, L OBP: 0.250, SLG: 0.571 (1, 9) X	0-0 HR 2-H		CI BB 1-2	0-0 L6		0-0 F2		4-0 1B BB		3 2 1 2 1 0 2												
Frank Thomas, R OBP: 0.320, SLG: 0.409 (1, 8) X	0-0 5-3		CI BB 1-2	0-0 K		0-0 L6		0-0 1B		4 1 1 0 1 1 2												
Hal Rice, L OBP: 0.261, SLG: 0.200 (1, 7) X	0-0 F2		CI BB 1-2 2-3	0-0 K		0-0 L6		0-3 K		4 1 0 1 1 2 3												
Toby Atwell, L OBP: 0.400, SLG: 0.182 (1, 2)		4-0 E 1B BB	1-0 1B HBP		0-0 F8		0-3 K2-3		0-0 F7	3 1 0 1 1 1 2												
Curt Roberts, R OBP: 0.400, SLG: 0.500 (1, 4)		0-0 E5 1B	4-0 SH3-4 1B BB		0-0 2-3 1B		0-0 6-3			3 0 2 1 1 0 0												
Gair Allie, R OBP: 0.227, SLG: 0.190 (1, 6)		0-0 4-3	0-0 SH3-4 1B		0-0 2-3			0-3 K		4 0 1 2 0 1 2												
Cal Hogue, R (1, 1)		0-0 1-3	0-0 SH3-4		0-3 K			0-0 F7		2 0 0 0 0 1 2												
Johnny Hetki, R (5, 1)			1-2 2-3							1 0 0 0 0 0 0												
<b>Inning Stats</b>	R: 2 E: 0 K: 0 S: 5	H: 2 LOB: 0 BB: 0 P: 5	R: 0 E: 1 K: 0 S: 3	H: 1 LOB: 1 BB: 1 P: 7	R: 5 E: 1 K: 0 S: 5	H: 1 LOB: 2 BB: 4 P: 22	R: 0 E: 0 K: 1 S: 6	H: 1 LOB: 1 BB: 0 P: 6	R: 0 E: 0 K: 1 S: 6	H: 1 LOB: 1 BB: 0 P: 6	R: 0 E: 0 K: 2 S: 7	H: 0 LOB: 0 BB: 0 P: 7	R: 0 E: 0 K: 1 S: 5	H: 0 LOB: 0 BB: 0 P: 5	R: 0 E: 0 K: 2 S: 8	H: 1 LOB: 2 BB: 1 P: 12	1B: 5 2B: 1 3B: 0 HR: 1	SF: 0 SAC: 1 DP: 0 HBP: 1	WP: 0 PB: 0 SB: 0 CS: 0	PA: 42		
<b>PITCHER</b>	IP WLS BF H R ER SO BB IBB HBP BLK WP HR S P ERA WHIP	IP WLS BF H R ER SO BB IBB HBP BLK WP HR S P ERA WHIP	IP WLS BF H R ER SO BB IBB HBP BLK WP HR S P ERA WHIP	IP WLS BF H R ER SO BB IBB HBP BLK WP HR S P ERA WHIP	IP WLS BF H R ER SO BB IBB HBP BLK WP HR S P ERA WHIP	IP WLS BF H R ER SO BB IBB HBP BLK WP HR S P ERA WHIP	IP WLS BF H R ER SO BB IBB HBP BLK WP HR S P ERA WHIP	IP WLS BF H R ER SO BB IBB HBP BLK WP HR S P ERA WHIP	IP WLS BF H R ER SO BB IBB HBP BLK WP HR S P ERA WHIP	IP WLS BF H R ER SO BB IBB HBP BLK WP HR S P ERA WHIP	IP WLS BF H R ER SO BB IBB HBP BLK WP HR S P ERA WHIP	IP WLS BF H R ER SO BB IBB HBP BLK WP HR S P ERA WHIP	IP WLS BF H R ER SO BB IBB HBP BLK WP HR S P ERA WHIP	IP WLS BF H R ER SO BB IBB HBP BLK WP HR S P ERA WHIP	IP WLS BF H R ER SO BB IBB HBP BLK WP HR S P ERA WHIP	IP WLS BF H R ER SO BB IBB HBP BLK WP HR S P ERA WHIP	IP WLS BF H R ER SO BB IBB HBP BLK WP HR S P ERA WHIP	IP WLS BF H R ER SO BB IBB HBP BLK WP HR S P ERA WHIP	IP WLS BF H R ER SO BB IBB HBP BLK WP HR S P ERA WHIP	IP WLS BF H R ER SO BB IBB HBP BLK WP HR S P ERA WHIP		
Jim Hearn, R ERA: 15.43 (1, 1)	2.1 L 13 3 5 5 0 3 0 0 0 0 1 10 22 19.29 2.571																					
Don Liddle, L ERA: (3, 1)	0.0 3 0 0 0 0 0 2 0 1 0 0 0 0 9 ∞ ∞																					
Al Corwin, R ERA: 3.0 (3, 1)	1.2 7 2 2 1 1 0 0 0 0 0 0 0 9 9 5.40 1.200																					
Hoyt Wilhelm, R ERA: (5, 1)	4.0 14 1 0 0 5 1 0 0 0 0 0 0 23 27 0.00 0.500																					
Mary Grissom, R ERA: (9, 1)	1.0 5 1 0 0 0 2 1 0 0 0 0 0 8 12 0.00 2.000																					

Pittsburgh Pirates @ New York Giants  
Polo Grounds, New York, NY  
Mon Apr 19 1954, 3:33 AM EST  
Att. 6,380 - Unknown

AB	32
R	7
H	7
RBI	7
BB	7
SO	8
LOB	18



WP: 0	PA: 42
PB: 0	
SB: 0	
CS: 0	



Batter	1	2	3	4	5	6	7	8	9	AB R H RBI BB SO LOB	TOP	
Dick Smith, R (1, 5) OBP: 0.368, SLG: 0.400	4-0 FC6-4 BB	0-0 P5		0-0 G6-4-3 1-2f		0-0 F8			0-0 5-3	4 0 0 0 1 0 2		
Bob Skinner, L (1, 3) OBP: 0.375, SLG: 0.333	0-0 FC6-4 1B 1-2f		4-0 BB 1B	0-0 1B		0-0 1B			0-0 4-3	4 2 2 0 1 0 1		
Gail Henley, L (1, 9) OBP: 0.385, SLG: 0.500	4-0 1B 1-2 BB		4-0 BB 1B BB	0-0 1-3		0-0 P6			0-0 1B	3 0 1 0 2 0 2		
Frank Thomas, R (1, 8) OBP: 0.333, SLG: 0.407	0-3 K		0-0 BB 1B 1-2 2-H		0-0 1B 1B			0-0 1-3	0-0 5-3	5 0 2 1 0 1 3		
Hal Rice, L (1, 7) OBP: 0.296, SLG: 0.217	0-0 1-3 2-H 1B		4-0 1-2 2-3 BB		0-3 K			0-0 F8		3 0 1 1 1 1 1		
Jack Shepard, R (1, 2) OBP: 0.222, SLG: 0.125	0-3 K		0-3 K		0-0 1-2 1B			0-0 F3		4 0 1 0 0 2 5		
Curt Roberts, R (1, 4) OBP: 0.345, SLG: 0.423		0-0 F8	0-0 F2		0-0 F8			0-0 F7		4 0 0 0 0 0 5		
Gair Allie, R (1, 6) OBP: 0.240, SLG: 0.174 Dick Cole, R (8, PH) (8, 6)		4-0 BB	0-3 K		0-3 K			0-0 L4		2 0 0 0 1 2 5 1 0 0 0 0 0 0		
Paul LaPalme, L (1, 1) OBP: 0.250, SLG: 0.250 Walker Cooper, R (8, PH) Nelson King, R (8, 1)		0-3 K		0-0 G6-4-3 1B		0-0 P3		0-0 F9		3 0 1 0 0 1 1 1 0 0 0 0 0 0 0 0 0 0 0 0 0		
<b>Inning Stats</b>	R: 1 E: 0 K: 2 S: 8 H: 1 LOB: 2 BB: 2 P: 16	R: 0 E: 0 K: 1 S: 5 H: 0 LOB: 1 BB: 1 P: 9	R: 1 E: 0 K: 2 S: 8 H: 1 LOB: 3 BB: 3 P: 20	R: 0 E: 0 K: 0 S: 4 H: 2 LOB: 1 BB: 0 P: 4	R: 0 E: 0 K: 2 S: 9 H: 2 LOB: 2 BB: 0 P: 9	R: 0 E: 0 K: 0 S: 4 H: 1 LOB: 1 BB: 0 P: 4	R: 0 E: 0 K: 0 S: 3 H: 0 LOB: 0 BB: 0 P: 3	R: 0 E: 0 K: 0 S: 3 H: 0 LOB: 0 BB: 0 P: 3	R: 0 E: 0 K: 0 S: 4 H: 1 LOB: 1 BB: 0 P: 4	1B: 8 2B: 0 3B: 0 HR: 0 SF: 0 SAC: 0 DP: 1 HBP: 0	WP: 0 PB: 0 SB: 0 CS: 0 PA: 40	
<b>PITCHER</b> Johnny Antonelli, L (1, 1) ERA: 1.8	IP WLS BF H R ER SO BB IBB HBP BLK WP HR S P ERA WHIP											<b>PITCHER</b> IP WLS BF H R ER SO BB IBB HBP BLK WP HR S P ERA WHIP
	9.0 W 40 8 2 2 7 6 0 0 0 0 0 0 48 72 2.00 1.556											

Pittsburgh Pirates @ New York Giants  
Polo Grounds, New York, NY  
Tue Apr 20 1954, 3:33 AM EST  
Att. 6,865 - Unknown

livebaseballscorecards.com

AB	34
R	2
H	8
RBI	2
BB	6
SO	7
LOB	25



Batter	1	2	3	4	5	6	7	8	9
Davey Williams, R OBP: 0.154, SLG: 0.083 (1, 4)	0-0 6-3 ①		0-0 F8 ①		0-0 F7 ②		0-0 4-3 ①	0-0 1-2 3-H 1B ②	
Alvin Dark, R OBP: 0.308, SLG: 0.538 (1, 6)	0-0 F9 ②		0-0 E 2B ②		0-0 1B ③		0-0 F5 ②	0-0 1-3 ③	
Willie Mays, R OBP: 0.280, SLG: 0.625 (1, 8)	0-0 5-3 ③		0-0 E6 G6-4-3 2-3 ③		0-0 F7 ③		0-0 4-3 ③		
Monte Irvin, R OBP: 0.304, SLG: 0.545 (1, 9) (9, 7)		4-0 BB 1B BB ③	0-0 G6-4-3 1-2f ③		0-0 SH2-3 1B ③		0-0 1B 1B SF9 1B ③		
Hank Thompson, L OBP: 0.522, SLG: 0.625 (1, 5)		4-0 1B 1-2 BLK BB ③		0-0 6-3 ①		0-0 SH2-3 1-2 ①		0-0 SF9 1B 1B SF7 1B ①	
Bobby Hofman, R (1, 3) Don Mueller, L OBP: 0.333, SLG: 0.375 (8, PH) (9, 9)		0-3 K ①		0-0 F5 ②		0-0 1-3 ②		0-0 1B 1-2 2-3 1B ①	
Whitey Lockman, L OBP: 0.304, SLG: 0.450 (1, 7) (9, 3)		0-0 F8 ②		0-0 E3 ③		0-0 1B 2-H 1B ③		0-0 SF9 2-3 3-H ②	
Ray Katt, R OBP: 0.500, SLG: 0.667 (1, 2)		0-0 BLK 1-3 2-H 1B ③		0-0 F4 ③		0-0 1-3 1B ③		0-0 SF7 3-H ②	
Johnny Antonelli, L OBP: 0.286, SLG: 0.286 (1, 1)		0-0 F9 1-2 3-H ③		0-0 F8 ①		0-0 4-3 ③		0-0 1B 1-3 1B ③	

AB	R	H	RBI	BB	SO	LOB
5	0	1	1	0	0	0
5	0	2	0	0	0	2
4	0	0	0	0	0	2
3	3	2	0	1	0	2
2	2	1	0	1	0	0
3	0	0	0	0	1	3
1	1	1	0	0	0	0
3	0	1	2	0	0	2
3	0	2	2	0	0	1
4	0	1	0	0	0	3

Inning	R	H	E	K	S	P	BB	IBB	HBP	BLK	WP	HR	S	P	ERA	WHIP
1	0	0	0	0	3	4	0	0	0	0	0	0	30	38	3.86	1.143
2	2	1	0	1	6	4	2	0	0	1	0	0	8	8	27.00	5.000
3	0	0	0	0	0	4	0	0	0	0	0	0	0	0		
4	0	0	0	0	0	4	0	0	0	0	0	0	0	0		
5	1	3	0	0	6	4	1	0	0	0	0	0	6	6		
6	0	0	0	0	3	3	0	0	0	0	0	0	3	3		
7	0	0	0	0	0	3	0	0	0	0	0	0	0	0		
8	3	5	0	0	8	8	3	0	0	0	0	0	8	8		
9	0	0	0	0	0	0	0	0	0	0	0	0	0	0		

PITCHER	IP	WLS	BF	H	R	ER	SO	BB	IBB	HBP	BLK	WP	HR	S	P	ERA	WHIP
Paul LaPalme, L ERA: 4.5 (1, 1)	7.0	L	30	6	3	3	1	2	0	0	1	0	0	30	38	3.86	1.143
Nelson King, R ERA: 13.5 (8, 1)	1.0		8	5	3	3	0	0	0	0	0	0	0	8	8	27.00	5.000

BOTTOM

Pittsburgh Pirates @ New York Giants  
Polo Grounds, New York, NY  
Tue Apr 20 1954, 3:33 AM EST  
Att. 6,865 - Unknown

livebaseballscorecards.com

AB	33
R	6
H	11
RBI	5
BB	2
SO	1
LOB	15



WP	PA
0	38
PB	0
SB	0
CS	0

**New York Giants @ Pittsburgh Pirates**  
 Forbes Field, Pittsburgh, PA  
 Wed Apr 21 1954, 3:33 AM EST  
 Att. 13,552 - Unknown

[livebaseballscorecards.com](http://livebaseballscorecards.com)

<b>AB</b>	<b>33</b>
<b>R</b>	<b>4</b>
<b>H</b>	<b>9</b>
<b>RBI</b>	<b>4</b>
<b>BB</b>	<b>2</b>
<b>SO</b>	<b>5</b>
<b>LOB</b>	<b>17</b>



AB	R	H	RBI	BB	SO	LOB
4	0	1	0	0	0	3
4	1	1	0	0	0	2
4	0	1	1	0	2	1
3	1	0	0	1	0	3
4	1	2	2	0	0	0
3	0	1	1	0	1	2
3	0	0	0	1	0	1
4	0	1	0	0	0	4
0	0	0	0	0	0	0
1	0	0	0	0	1	0
1	0	1	0	0	0	0
0	0	0	0	0	0	0
1	1	1	0	0	0	0
0	0	0	0	0	0	0
1	0	0	0	0	1	1

Batter	1	2	3	4	5	6	7	8	9	AB	R	H	RBI	BB	SO	LOB					
<b>Davey Williams, R</b> (1, 4) OBP: 0.194, SLG: 0.107	0-0 1B		0-0 E5 G4-6-3		0-0 FC6-4 1-2f		1-0 SH3-4 HBP		0-0 F8	4	0	1	0	0	0	3					
<b>Alvin Dark, R</b> (1, 6) OBP: 0.300, SLG: 0.500	0-0 1-3		0-0 G4-6-3			0-0 FC3-6 1B 2B	0-0 SH3-4		0-0 FC5-4	4	1	1	0	0	0	2					
<b>Willie Mays, R</b> (1, 8) OBP: 0.276, SLG: 0.571	0-3 K			0-3 K		0-0 FC3-6 1B	0-0 6-3			4	0	1	1	0	2	1					
<b>Hank Thompson, L</b> (1, 5) OBP: 0.481, SLG: 0.526		4-0 3B BB		0-0 6-3		0-0 FC3-6 2B	0-0 F8			3	1	0	0	1	0	3					
<b>Don Mueller, L</b> (1, 9) OBP: 0.364, SLG: 0.550		0-0 SF8 3B		0-0 F7		0-0 1-3 3-H 2B		0-0 F7	4	1	2	2	0	0	0	0					
<b>Monte Irvin, R</b> (1, 7) OBP: 0.296, SLG: 0.520		0-0 SF8			0-0 1B 1B	0-0 1-3		0-3 K	3	0	1	1	0	1	2						
<b>Whitey Lockman, L</b> (1, 3) OBP: 0.296, SLG: 0.391		0-0 F7		0-0 F9		4-0 FC5-4 IBB		0-0 6-3	3	0	0	0	1	0	1						
<b>Ray Katt, R</b> (1, 2) <b>Ron Samford, R</b> (9, PR)		0-0 5-3		0-0 F9		0-0 FC5-4			4	0	1	0	0	0	0	4					
<b>Larry Jansen, R</b> (1, 1) <b>Harvey Gentry, L</b> (5, PH) <b>Windy McCall, L</b> (5, 1) <b>Dusty Rhodes, L</b> (7, PH) <b>Don Liddle, L</b> (7, 1) <b>Ebba St. Claire, S</b> (9, PH)			0-3 K		0-0 FC6-4 1B		0-0 SH3-4 HBP 6-3 1B		0-3 K	1	0	0	0	0	1	0					
<b>Inning Stats</b>	R: 0 E: 0 K: 1 S: 5	H: 1 LOB: 0 BB: 0 P: 5	R: 2 E: 0 K: 0 S: 4	H: 1 LOB: 0 BB: 1 P: 8	R: 0 E: 1 K: 1 S: 5	H: 0 LOB: 0 BB: 0 P: 5	R: 0 E: 0 K: 1 S: 5	H: 2 LOB: 2 BB: 0 P: 5	R: 1 E: 0 K: 0 S: 6	H: 3 LOB: 3 BB: 1 P: 10	R: 1 E: 0 K: 0 S: 4	H: 1 LOB: 1 BB: 0 P: 5	R: 0 E: 0 K: 1 S: 5	H: 0 LOB: 0 BB: 0 P: 5	R: 0 E: 0 K: 1 S: 6	H: 1 LOB: 1 BB: 0 P: 6	1B: 7 2B: 1 3B: 1 HR: 0	SF: 1 SAC: 1 DP: 1 HBP: 1	WP: 0 PB: 0 SB: 0 CS: 0	PA: 38	
<b>PITCHER</b>	IP	WLS	BF	H	R	ER	SO	BB	IBB	HBP	BLK	WP	HR	S	P	ERA	WHIP				
<b>Max Surkont, R</b> (1, 1) ERA: 8.25	8.0	W	34	8	4	4	4	1	1	1	0	0	0	39	48	4.50	1.125				
<b>Johnny Hetki, R</b> (9, 1) ERA: 2.0	1.0	S	4	1	0	0	1	0	0	0	0	0	0	6	6	0.00	1.000				

BOTTOM

New York Giants @ Pittsburgh Pirates  
Forbes Field, Pittsburgh, PA  
Wed Apr 21 1954, 3:33 AM EST  
Att. 13,552 - Unknown

livebaseballscorecards.com

AB 31  
R 5  
H 8  
RBI 4  
BB 5  
SO 5  
LOB 16



WP: 0 PA: 37  
PB: 0  
SB: 0  
CS: 0

AB R H RBI BB SO LOB

5 0 0 0 0 1 3

3 1 1 0 1 0 1

4 1 1 0 0 1 1

3 2 1 3 0 1 1

3 0 1 1 1 0 1

3 1 2 0 1 1 0

3 0 1 0 0 0 1

1 0 0 0 0 0 2

3 0 0 0 0 0 2  
0 0 0 0 1 0 0  
0 0 0 0 0 0 0  
0 0 0 0 0 0 0

1B: 6 SF: 0  
2B: 0 SAC: 0  
3B: 1 DP: 1  
HR: 1 HBP: 1

WP: 0 PA: 37  
PB: 0  
SB: 0  
CS: 0

1B: 6 SF: 0  
2B: 0 SAC: 0  
3B: 1 DP: 1  
HR: 1 HBP: 1

WP: 0 PA: 37  
PB: 0  
SB: 0  
CS: 0

Batter	1	2	3	4	5	6	7	8	9
Dick Smith, R OBP: 0.292, SLG: 0.300 (1, 5)	0-3 K	0-0 F7		0-0 FC1-6		0-0 5-3		0-0 F8	
Bob Skinner, L OBP: 0.400, SLG: 0.333 (1, 3)	0-0 1B HR 1B		0-0 5-3	0-0 L8			4-0 FC1-6 BB		
Gail Henley, L OBP: 0.353, SLG: 0.429 (1, 9)	0-0 1-2 HR 1B		0-0 4-3		0-3 K		0-0 FC1-6		
Frank Thomas, R OBP: 0.353, SLG: 0.500 (1, 8)	0-0 1-H 2-H HR		1-0 3B HBP		0-0 P4		0-3 K		
Hal Rice, L OBP: 0.323, SLG: 0.308 (1, 7)	0-0 L9		0-0 1-H 3B		4-0 1B BB		0-0 P6		
Toby Atwell, L OBP: 0.474, SLG: 0.286 (1, 2)	0-3 K		4-0 BB		0-0 1-2 1B			0-0 G4-6-3 BB 1B	
Curt Roberts, R OBP: 0.364, SLG: 0.414 (1, 4)		0-0 1-3 1B	0-0 1-3		0-3 K2-3			4-0 G4-6-3 BB	
Gair Allie, R OBP: 0.250, SLG: 0.192 Dick Cole, R (8, PH) (9, 6)		0-0 F1		0-0 FC4-6 1B		0-0 F8		0-0 G4-6-3 1-2f 2-3	
Max Surkont, R Sid Gordon, R Vern Law, R Johnny Hetki, R (1, 1) (8, PH) (8, PR) (9, 1)		0-0 1-3		0-0 FC4-6 FC1-6		0-0 F7		4-0 BB	

Inning Stats	R: 3	H: 3	E: 0	K: 2	S: 10	LOB: 0	BB: 0	P: 10
	R: 0	H: 1	E: 0	K: 0	S: 4	LOB: 1	BB: 0	P: 4
	R: 1	H: 1	E: 0	K: 0	S: 4	LOB: 2	BB: 1	P: 9
	R: 0	H: 1	E: 0	K: 0	S: 4	LOB: 1	BB: 0	P: 4
	R: 0	H: 1	E: 0	K: 2	S: 8	LOB: 2	BB: 1	P: 12
	R: 0	H: 0	E: 0	K: 0	S: 3	LOB: 0	BB: 0	P: 3
	R: 0	H: 0	E: 0	K: 1	S: 5	LOB: 1	BB: 1	P: 9
	R: 1	H: 1	E: 1	K: 0	S: 3	LOB: 1	BB: 2	P: 11

PITCHER	IP	WLS	BF	H	R	ER	SO	BB	IBB	HBP	BLK	WP	HR	S	P	ERA	WHIP
Larry Jansen, R ERA: 9.0 (1, 1)	4.0		20	6	4	4	2	1	0	1	0	0	1	22	27	9.00	1.750
Windy McCall, L ERA: (5, 1)	2.0		8	1	0	0	2	1	0	0	0	0	0	11	15	0.00	1.000
Don Liddle, L ERA: 9.0 (7, 1)	2.0	L	9	1	1	0	1	3	0	0	0	0	0	8	20	0.00	2.000

PITCHER	IP	WLS	BF	H	R	ER	SO	BB	IBB	HBP	BLK	WP	HR	S	P	ERA	WHIP
Larry Jansen, R ERA: 9.0 (1, 1)	4.0		20	6	4	4	2	1	0	1	0	0	1	22	27	9.00	1.750
Windy McCall, L ERA: (5, 1)	2.0		8	1	0	0	2	1	0	0	0	0	0	11	15	0.00	1.000
Don Liddle, L ERA: 9.0 (7, 1)	2.0	L	9	1	1	0	1	3	0	0	0	0	0	8	20	0.00	2.000

Batter	1	2	3	4	5	6	7	8	9	AB R H RBI BB SO LOB	TOP	
Ron Samford, R (1, 4) Dusty Rhodes, L (8, PH) OBP: 0.500, SLG: 0.333 Billy Gardner, R (8, 4) OBP: 1.000, SLG: 1.000	0-3 ① K		0-0 ② 5-3		0-0 ③ 5-3			4-0 E 1B E BB	0-0 1B	3 0 0 0 0 1 0 0 1 0 0 1 0 0 1 0 1 0 0 0 0		
Alvin Dark, R (1, 6) OBP: 0.314, SLG: 0.486	0-0 ② 6-3		0-0 ③ 6-3			0-0 E 1B		0-0 E E SF7 1B	0-0 ③ P4	5 1 2 0 0 0 1		
Willie Mays, R (1, 8) OBP: 0.303, SLG: 0.625	0-0 1B			0-0 G4-6-3 3B		0-0 F9		0-0 FC4-6 E		4 1 2 0 0 0 3		
Hank Thompson, L (1, 5) OBP: 0.484, SLG: 0.500	0-0 1B			4-0 G4-6-3 BB		0-0 E3		0-0 FC4 FC4-6		3 0 1 1 1 0 3		
Don Mueller, L (1, 9) OBP: 0.308, SLG: 0.478	0-0 ③ 1-3			0-0 ① ② G4-6-3		0-0 ② F8		0-0 ① SF7		3 0 0 1 0 0 5		
Whitey Lockman, L (1, 3) OBP: 0.258, SLG: 0.333		0-0 ① G3		0-0 ③ 1-3		0-0 ③ P5		0-0 ② FC4-6		4 0 0 0 0 0 4		
Monte Irvin, R (1, 7) OBP: 0.323, SLG: 0.586		0-0 G5-4-3 1B			0-0 4-3 3B		0-0 ① F9	0-0 ③ F8		4 1 2 0 0 0 2		
Ray Katt, R (1, 2) OBP: 0.250, SLG: 0.273		0-0 ② ③ G5-4-3			0-0 ① 1-3		0-0 ② F8		0-0 ① F8	4 0 0 0 0 0 2		
Ruben Gomez, R (1, 1) Al Corwin, R (3, 1) Harvey Gentry, L (5, PH) OBP: 0.500, SLG: 0.333 Windy McCall, L (5, 1) Bill Taylor, L (7, PH) OBP: 0.167, SLG: 0.167 Jim Heenan, R (7, 1) Ebba St. Claire, S (9, PH) OBP: 0.450, SLG: 0.429			0-0 ① F8		0-0 ② 4-3		0-0 ③ F7		0-0 ② P5	1 0 0 0 0 0 0 0 0 0 0 0 0 0 1 0 0 1 0 0 0 0 0 0 0 0 0 0 1 0 0 0 0 0 0 0 0 0 0 0 0 0 1 0 0 0 0 0 0		
<b>Inning Stats</b>	R: 0 H: 2 E: 0 LOB: 2 K: 1 BB: 0 S: 7 P: 7	R: 0 H: 1 E: 0 LOB: 0 K: 0 BB: 0 S: 3 P: 3	R: 0 H: 0 E: 0 LOB: 0 K: 0 BB: 0 S: 3 P: 3	R: 1 H: 1 E: 0 LOB: 0 K: 0 BB: 1 S: 3 P: 7	R: 1 H: 1 E: 0 LOB: 0 K: 0 BB: 0 S: 4 P: 4	R: 0 H: 1 E: 1 LOB: 2 K: 0 BB: 0 S: 5 P: 5	R: 0 H: 0 E: 0 LOB: 0 K: 0 BB: 0 S: 3 P: 3	R: 2 H: 1 E: 2 LOB: 2 K: 0 BB: 1 S: 6 P: 10	R: 0 H: 1 E: 0 LOB: 1 K: 0 BB: 0 S: 4 P: 4	1B: 6 SF: 1 2B: 0 SAC: 0 3B: 2 DP: 2 HR: 0 HBP: 0	WP: 0 PA: 38 PB: 0 SB: 0 CS: 0	
<b>PITCHER</b> George O'Donnell, R (1, 1) ERA: 3.0	IP WLS BF H R ER SO BB IBB HBP BLK WP HR S P ERA WHIP	9.0 W 38 8 4 3 1 2 0 0 0 0 0 0 38 46 3.00 1.111										

**New York Giants @ Pittsburgh Pirates**  
 Forbes Field, Pittsburgh, PA  
 Thu Apr 22 1954, 3:33 AM EST  
 Att. 3,296 - Unknown

[livebaseballscorecards.com](http://livebaseballscorecards.com)

<b>AB</b>	35
<b>R</b>	4
<b>H</b>	8
<b>RBI</b>	3
<b>BB</b>	2
<b>SO</b>	1
<b>LOB</b>	20





BOTTOM

New York Giants @ Pittsburgh Pirates  
Forbes Field, Pittsburgh, PA  
Thu Apr 22 1954, 3:33 AM EST  
Att. 3,296 - Unknown

livebaseballscorecards.com

AB 33  
R 7  
H 10  
RBI 7  
BB 3  
SO 5  
LOB 11



WP: 0 PA: 37  
PB: 0  
SB: 0  
CS: 0

AB R H RBI BB SO LOB

4 1 0 0 1 0 0

4 2 4 0 0 0 0

3 1 1 0 0 0 2

4 1 1 1 0 1 3

4 1 1 3 0 0 2

3 0 1 0 1 1 0

4 0 1 2 0 0 1

3 1 1 1 1 0 0

4 0 0 0 0 3 3

1B: 6 SF: 0  
2B: 1 SAC: 1  
3B: 1 DP: 0  
HR: 2 HBP: 0

Batter	1	2	3	4	5	6	7	8	9
Dick Smith, R OBP: 0.276, SLG: 0.250 (1, 5) BBB	4-0 SH5-3 1B HR BB		0-0 1-3	0-0 G3		0-0 5-3		0-0 P5	
Bob Skinner, L OBP: 0.500, SLG: 0.591 (1, 3) X	0-0 SH5-3 1-2 HR 1B		0-0 1B 1B 2B	0-0 3B		0-0 1B			
Gail Henley, L OBP: 0.350, SLG: 0.412 (1, 9) X	0-0 SH5-3 1-2 2-3		0-0 BB 1B 1B 2-3	0-0 4-3		0-0 G3			
Frank Thomas, R OBP: 0.342, SLG: 0.471 (1, 8) SSS	0-3 K		0-0 1-2 3-H 1B 1B	0-0 P4		0-0 P4			
Hal Rice, L OBP: 0.314, SLG: 0.400 (1, 7) X	0-0 2-H 3-H HR		0-0 F5		0-0 P6		0-0 P3		
Toby Atwell, L OBP: 0.478, SLG: 0.294 (1, 2) X	0-0 F7		4-0 1B 1-2 2-3 BB	0-3 K		0-0 E9 FC5 1B			
Curt Roberts, R OBP: 0.351, SLG: 0.394 (1, 4) X		0-0 F9	0-0 1-3 2-H 3-H BB 1B	0-0 P4		0-0 FC5			
Gair Allie, R OBP: 0.281, SLG: 0.310 (1, 6) X		0-0 6-3	4-0 1-2 BB			0-0 HR		0-0 F7	
George O'Donnell, R (1, 1) X		0-0 4-3	0-3 K			0-3 K		0-3 K	

Inning Stats	R: 3	H: 2	E: 0	K: 1	S: 7	LOB: 0	BB: 11	P: 11
	R: 0	H: 0	E: 0	K: 0	S: 3	LOB: 0	BB: 0	P: 3
	R: 3	H: 4	E: 0	K: 1	S: 9	LOB: 3	BB: 2	P: 17
	R: 0	H: 1	E: 0	K: 0	S: 4	LOB: 1	BB: 0	P: 4
	R: 0	H: 0	E: 0	K: 1	S: 5	LOB: 0	BB: 0	P: 5
	R: 1	H: 2	E: 0	K: 1	S: 7	LOB: 1	BB: 0	P: 7
	R: 0	H: 1	E: 1	K: 0	S: 4	LOB: 1	BB: 0	P: 4
	R: 0	H: 0	E: 0	K: 1	S: 5	LOB: 0	BB: 0	P: 5

PITCHER	IP	WLS	BF	H	R	ER	SO	BB	IBB	HBP	BLK	WP	HR	S	P	ERA	WHIP
Ruben Gomez, R ERA: 18.69 (1, 1)	2.2	L	16	6	6	6	1	2	0	0	0	0	1	16	24	20.25	3.000
Al Corwin, R ERA: 2.08 (3, 1)	1.1		6	1	0	0	1	1	0	0	0	0	0	7	11	0.00	1.500
Windy McCall, L ERA: 2.25 (5, 1)	2.0		8	2	1	1	2	0	0	0	0	0	1	12	12	4.50	1.000
Jim Hearn, R ERA: 8.31 (7, 1)	2.0		7	1	0	0	1	0	0	0	0	0	0	9	9	0.00	0.500

Batter	1	2	3	4	5	6	7	8	9	AB R H RBI BB SO LOB	TOP																								
Willie Jones, R OBP: 0.459, SLG: 0.576 (1, 5) X	0-0 F6 ①		0-0 1B X		0-0 F9 ③			0-0 5-3 ①		4 0 1 0 0 0 2																									
Richie Ashburn, L OBP: 0.229, SLG: 0.167 (1, 8) B B B	4-0 CS BB X		0-0 G3 ③			0-0 4-3 ①		0-3 K ②		3 0 0 0 1 1 1																									
Earl Torgeson, L OBP: 0.405, SLG: 0.500 (1, 3) B B B	4-0 FC5-4 1-2 BB X			4-0 G6-4-3 BB X		0-0 F3 ②		0-0 1B X		2 0 1 0 2 0 0																									
Del Ennis, R OBP: 0.324, SLG: 0.571 (1, 7) X	0-0 FC5-4 1-2f ③			0-0 G6-4-3 1-2f ① ②		0-0 F3 ③		0-0 F8 ③		4 0 0 0 0 0 3																									
Granny Hamner, R OBP: 0.472, SLG: 0.438 (1, 4) X		0-0 1-3 ①		0-0 6-3 ③			0-0 6-3 ①		0-0 6-3 ①	4 0 0 0 0 0 0																									
Johnny Wyrostek, L OBP: 0.150, SLG: 0.211 (1, 9) X		0-0 1-3 ②			0-0 G3 ①		0-0 2B X		0-0 F8 ②	4 0 1 0 0 0 0																									
Smoky Burgess, L OBP: 0.353, SLG: 0.529 (1, 2) X		0-0 F8 ③			0-0 F7 ②		0-0 1-3 ②		0-0 F5 ③	4 0 0 0 0 0 1																									
Bobby Morgan, R OBP: 0.455, SLG: 0.143 (1, 6) S S S S			0-3 K ①		4-0 BB BB BB BB		4-0 BB BB			1 0 0 0 2 1 0																									
Robin Roberts, S (1, 1) X			0-0 3-1 ②		4-0 1-2 BB BB BB		0-3 K ③			2 0 0 0 1 1 2																									
<b>Inning Stats</b>	R: 0 E: 0 K: 0 S: 2 H: 0 LOB: 1 BB: 2 P: 10	R: 0 E: 0 K: 0 S: 3 H: 0 LOB: 0 BB: 0 P: 3	R: 0 E: 0 K: 1 S: 6 H: 1 LOB: 1 BB: 0 P: 6	R: 0 E: 0 K: 0 S: 2 H: 0 LOB: 0 BB: 1 P: 6	R: 0 E: 0 K: 0 S: 3 H: 0 LOB: 2 BB: 2 P: 11	R: 0 E: 0 K: 1 S: 6 H: 0 LOB: 0 BB: 1 P: 3	R: 0 E: 0 K: 1 S: 6 H: 1 LOB: 2 BB: 1 P: 10	R: 0 E: 0 K: 1 S: 6 H: 1 LOB: 1 BB: 0 P: 6	R: 0 E: 0 K: 0 S: 3 H: 0 LOB: 0 BB: 0 P: 3	1B: 2 2B: 1 3B: 0 HR: 0 SF: 0 SAC: 0 DP: 1 HBP: 0	WP: 0 PB: 0 SB: 0 CS: 1 PA: 34																								
<b>PITCHER</b> Mary Grissom, R ERA: (1, 1)	IP 9.0	WLS W	BF 34	H 3	R 0	ER 0	SO 3	BB 6	IBB 0	HBP 0	BLK 0	WP 0	HR 0	S 34	P 58	ERA 0.00	WHIP 1.000	<b>PITCHER</b>	IP 9.0	WLS W	BF 34	H 3	R 0	ER 0	SO 3	BB 6	IBB 0	HBP 0	BLK 0	WP 0	HR 0	S 34	P 58	ERA 0.00	WHIP 1.000

Philadelphia Phillies @ New York Giants  
Polo Grounds, New York, NY  
Sat Apr 24 1954, 3:33 AM EST  
Att. 6,865 - Unknown

[livebaseballscorecards.com](http://livebaseballscorecards.com)

AB	28
R	0
H	3
RBI	0
BB	6
SO	3
LOB	9



Batter	1	2	3	4	5	6	7	8	9	AB R H RBI BB SO LOB
Whitey Lockman, L (1, 3) OBP: 0.257, SLG: 0.419	0-0 F3 		0-0 4-3 		0-0 HR 		0-0 1-3 			4 1 1 1 0 0 0
Alvin Dark, R (1, 6) OBP: 0.308, SLG: 0.487	0-0 2B 		0-0 F8 		0-0 F7 			0-0 5-3 		4 0 1 0 0 0 0
Hank Thompson, L (1, 5) OBP: 0.457, SLG: 0.440	0-3 K 			0-0 F8 	4-0 BB 			0-0 4-3 		3 0 0 0 1 1 1
Willie Mays, R (1, 8) OBP: 0.297, SLG: 0.583	0-0 F2 			0-0 1B 	0-0 F3 			0-0 F7 		4 0 1 0 0 0 2
Don Mueller, L (1, 9) OBP: 0.310, SLG: 0.462		0-0 6-3 		0-0 1B 		0-0 F4 				3 0 1 0 0 0 0
Monte Irvin, R (1, 7) OBP: 0.353, SLG: 0.581		0-0 1B 		4-0 IBB 		0-0 F7 				2 0 1 0 1 0 0
Bobby Hofman, R (1, 4)		0-0 F9 		0-0 F3 		0-0 F8 				3 0 0 0 0 0 4
Wes Westrum, R (1, 2)		0-0 F3 		0-0 F4 			0-0 4-3 			3 0 0 0 0 0 4
Marv Grissom, R (1, 1)			0-3 K 		0-0 1-3 		0-0 1-3 			3 0 0 0 0 1 0

Inning Stats	R: 0	H: 1	E: 0	LOB: 1	K: 1	BB: 0	S: 6	P: 6	R: 0	H: 1	E: 0	LOB: 1	K: 0	BB: 0	S: 4	P: 4	R: 0	H: 0	E: 0	LOB: 0	K: 1	BB: 0	S: 5	P: 5	R: 0	H: 2	E: 0	LOB: 3	K: 0	BB: 1	S: 5	P: 9	R: 1	H: 1	E: 0	LOB: 1	K: 0	BB: 1	S: 4	P: 8	R: 0	H: 0	E: 0	LOB: 0	K: 0	BB: 0	S: 3	P: 3	R: 0	H: 0	E: 0	LOB: 0	K: 0	BB: 0	S: 3	P: 3	R: 0	H: 0	E: 0	LOB: 0	K: 0	BB: 0	S: 3	P: 3
PITCHER Robin Roberts, R (1, 1) ERA: 1.85	IP	WLS	BF	H	R	ER	SO	BB	IBB	HBP	BLK	WP	HR	S	P	ERA	WHIP	IP	WLS	BF	H	R	ER	SO	BB	IBB	HBP	BLK	WP	HR	S	P	ERA	WHIP	IP	WLS	BF	H	R	ER	SO	BB	IBB	HBP	BLK	WP	HR	S	P	ERA	WHIP													

**BOTTOM**

**Philadelphia Phillies @ New York Giants**  
Polo Grounds, New York, NY

Sat Apr 24 1954, 3:33 AM EST  
Att. 6,865 - Unknown

AB	29
R	1
H	5
RBI	1
BB	2
SO	2
LOB	11

1B: 3	SF: 0	WP: 0	PA: 31
2B: 1	SAC: 0	PB: 0	
3B: 0	DP: 0	SB: 1	
HR: 1	HBP: 0	CS: 0	

[livebaseballscorecards.com](http://livebaseballscorecards.com)

Batter	1	2	3	4	5	6	7	8	9	AB R H RBI BB SO LOB	TOP									
Willie Jones, R (1, 5) OBP: 0.439, SLG: 0.541	0-0 SH5-3 1B		0-0 F3		0-0 5-3			0-3 K		4 0 1 0 0 1 0										
Richie Ashburn, L (1, 8) OBP: 0.263, SLG: 0.188	0-0 SH5-3 1-2		0-0 1B		0-0 F7			4-0 E BB		2 0 1 0 1 0 0										
Earl Torgeson, L (1, 3) OBP: 0.390, SLG: 0.472	0-0 4-3		0-0 BB 1-3 1B		0-0 3-1			0-0 E5 G4-6-3 1-2		4 0 1 0 0 0 2										
Del Ennis, R (1, 7) OBP: 0.317, SLG: 0.526	0-0 F7		4-0 BB 1-2		0-0 F8			0-0 G4-6-3 1-2f		3 0 0 0 1 0 3										
Granny Hamner, R (1, 4) OBP: 0.425, SLG: 0.389		0-0 F9	0-0 F8		0-0 F3			0-3 K		4 0 0 0 0 1 3										
Johnny Wyrostek, L (1, 9) OBP: 0.167, SLG: 0.182		4-0 E9 BB	0-0 G3		0-3 K			0-3 K		3 0 0 0 1 2 3										
Smoky Burgess, L (1, 2) OBP: 0.333, SLG: 0.500		0-0 E9 1B		0-0 P6			0-0 F3		0-0 F3	1 0 0 0 0 0 1										
Stan Lopata, R (2, 2) OBP: 0.368, SLG: 0.357		1-3								2 0 0 0 0 0 0										
Danny Schell, R (9, PH) OBP: 0.250, SLG: 0.500										1 0 0 0 0 0 0										
Bobby Morgan, R (1, 6) OBP: 0.500, SLG: 0.300		0-0		0-0 6-3			0-0			3 0 2 0 0 0 0										
Curt Simmons, L (1, 1) OBP: 0.200, SLG: 0.200		0-0 1B					0-0													
		0-3 K		0-0 6-3			0-0 G6-3 1B			3 0 0 0 0 1 3										
							0-0 G6-3 1-2f													
<b>Inning Stats</b>	R: 0 E: 0 K: 0 S: 4	H: 1 LOB: 1 BB: 0 P: 4	R: 0 E: 1 K: 1 S: 6	H: 1 LOB: 2 BB: 1 P: 10	R: 0 E: 0 K: 0 S: 5	H: 2 LOB: 3 BB: 1 P: 9	R: 0 E: 0 K: 0 S: 3	H: 0 LOB: 0 BB: 0 P: 3	R: 0 E: 0 K: 1 S: 5	H: 0 LOB: 0 BB: 0 P: 5	R: 0 E: 0 K: 0 S: 3	H: 1 LOB: 0 BB: 0 P: 3	R: 0 E: 1 K: 1 S: 5	H: 0 LOB: 1 BB: 1 P: 9	R: 0 E: 0 K: 2 S: 7	H: 0 LOB: 0 BB: 0 P: 7	1B: 5 2B: 0 3B: 0 HR: 0	SF: 0 SAC: 1 DP: 2 HBP: 0	WP: 0 PB: 0 SB: 0 CS: 0	PA: 34
<b>PITCHER</b> Sal Maglie, R (1, 1) ERA: 2.22	IP: 9.0 WLS: W BF: 34 H: 5 R: 0 ER: 0 SO: 5 BB: 3 IBB: 0 HBP: 0 BLK: 0 WP: 0 HR: 0 S: 41 P: 53 ERA: 0.00 WHIP: 0.889																			
<b>PITCHER</b>	IP	WLS	BF	H	R	ER	SO	BB	IBB	HBP	BLK	WP	HR	S	P	ERA	WHIP			

Philadelphia Phillies @ New York Giants  
Polo Grounds, New York, NY  
Sun Apr 25 1954, 3:33 AM EDT  
Unknown

livebaseballscorecards.com

AB 30  
R 0  
H 5  
RBI 0  
BB 3  
SO 5  
LOB 15



Batter	1	2	3	4	5	6	7	8	9
Whitey Lockman, L (1, 3) OBP: 0.282, SLG: 0.412	0-3 K ①		0-0 4-3 ③			0-0 FC4-6 1B		4-0 1B BB	
Alvin Dark, R (1, 6) OBP: 0.302, SLG: 0.465	0-0 F7 ②			0-0 F8 ①		0-0 FC4-6 1-2f		0-0 1B E 1B	
Hank Thompson, L (1, 5) OBP: 0.410, SLG: 0.379	0-3 K ③			0-3 K ②		0-0 4-3 ③		0-0 F2 ①	
Willie Mays, R (1, 8) OBP: 0.317, SLG: 0.575		0-0 4-3 ①		0-0 6-3 ③		0-0 G4-6-3 1B		0-0 E 1-2 2-H FC6-2 1B	
Monte Irvin, R (1, 7) OBP: 0.316, SLG: 0.514		0-0 6-3 ②		0-0 6-3 ①		0-0 G4-6-3 1-2f		0-0 E4 1-3 2-H	
Davey Williams, R (1, 4) OBP: 0.229, SLG: 0.188		0-0 1B		0-0 1-3 ②		0-0 E 2B		0-0 FC6-2 ②	
Don Mueller, L (1, 9) OBP: 0.333, SLG: 0.467		0-0 4-3 ③		0-0 1B		0-0 E7 2-H 1B		0-0 6-3 ③	
Wes Westrum, R (1, 2)			0-3 K ①		0-0 F7 ③		4-0 IBB		
Sal Maglie, R (1, 1) OBP: 0.111, SLG: 0.111			0-3 K ②			0-0 4-3 ①	0-0 1-3 ③		

Inning Stats	R: 0	H: 0	E: 0	K: 2	S: 7	LOB: 0	BB: 0	P: 7
	R: 0	H: 1	E: 0	K: 0	S: 4	LOB: 1	BB: 0	P: 4
	R: 0	H: 0	E: 0	K: 2	S: 7	LOB: 0	BB: 0	P: 7
	R: 0	H: 0	E: 0	K: 1	S: 5	LOB: 0	BB: 0	P: 5
	R: 0	H: 1	E: 0	K: 0	S: 4	LOB: 1	BB: 0	P: 4
	R: 1	H: 3	E: 1	K: 0	S: 5	LOB: 2	BB: 1	P: 9
	R: 2	H: 2	E: 1	K: 0	S: 6	LOB: 2	BB: 1	P: 10

PITCHER	IP	WLS	BF	H	R	ER	SO	BB	IBB	HBP	BLK	WP	HR	S	P	ERA	WHIP
Curt Simmons, L (1, 1) ERA: 0.69	8.0	L	34	8	3	2	5	1	1	0	0	0	0	42	50	2.25	1.125

AB R H RBI BB SO LOB

3	1	1	0	1	1	0
4	1	1	0	0	0	1
4	0	0	0	0	2	3
4	0	2	1	0	0	0
4	0	0	0	0	0	2
4	1	2	0	0	0	2
4	0	2	1	0	0	3
2	0	0	0	1	1	1
3	0	0	0	0	1	2

WP: 0	PA: 34
PB: 0	SB: 0
CS: 0	

**Philadelphia Phillies @ New York Giants**  
 Polo Grounds, New York, NY  
 Sun Apr 25 1954, 3:33 AM EDT  
 Unknown

AB	32
R	3
H	8
RBI	2
BB	2
SO	5
LOB	14



Batter	1	2	3	4	5	6	7	8	9	AB R H RBI BB SO LOB	TOP																									
Willie Jones, R (1, 5) OBP: 0.400, SLG: 0.488	0-0 F7		0-0 P4		0-0 F8			0-3 K		4 0 0 0 0 1 1																										
Richie Ashburn, L (1, 8) OBP: 0.262, SLG: 0.171	4-0 FC6-4 BB		0-0 E5			0-0 5-3		0-0 5-3		3 0 0 0 1 0 0																										
Earl Torgeson, L (1, 3) OBP: 0.400, SLG: 0.475	0-0 F7		0-0 F8			0-0 1B			0-0 BB 1B	4 0 2 0 0 0 2																										
Del Ennis, R (1, 7) OBP: 0.289, SLG: 0.476	0-0 FC6-4 1-2f			0-0 5-3		0-0 F7			0-0 F8	4 0 0 0 0 0 3																										
Granny Hamner, R (1, 4) OBP: 0.409, SLG: 0.359		0-3 K		0-0 6-3		0-0 F3			4-0 BB BB BB L4-3 BB	3 0 0 0 1 1 1																										
Mel Clark, R (1, 9) OBP: 0.100, SLG: 0.200		0-0 6-3		0-0 1-3			0-0 6-3		0-0 L4-3 1-2	4 0 0 0 0 0 2																										
Stan Lopata, R (1, 2) OBP: 0.409, SLG: 0.375		0-0 FC5-4 1B			4-0 BB BB BB FC4 BB		0-0 F8			2 0 1 0 1 0 0																										
Bobby Morgan, R (1, 6) OBP: 0.412, SLG: 0.231		0-0 FC5-4 1-2f			0-0 FC4 1-2f		0-0 F7			3 0 0 0 0 0 2																										
Murry Dickson, R (1, 1) OBP: 0.250, SLG: 0.286			0-0 1-3		0-0 F8			0-3 K		2 0 0 0 0 0 1																										
Karl Drews, R (6, 1)										0 0 0 0 0 0 0																										
Stan Jok, R (8, PH)										1 0 0 0 0 1 0																										
Bob Greenwood, R (8, 1)										0 0 0 0 0 0 0																										
<b>Inning Stats</b>	R: 0 E: 0 K: 0 S: 3	H: 0 LOB: 1 BB: 1 P: 7	R: 0 E: 0 K: 1 S: 6	H: 1 LOB: 1 BB: 0 P: 6	R: 0 E: 1 K: 0 S: 4	H: 0 LOB: 1 BB: 0 P: 4	R: 0 E: 0 K: 0 S: 3	H: 0 LOB: 1 BB: 1 P: 7	R: 0 E: 0 K: 0 S: 4	H: 1 LOB: 1 BB: 0 P: 4	R: 0 E: 0 K: 0 S: 3	H: 0 LOB: 0 BB: 0 P: 3	R: 0 E: 0 K: 2 S: 7	H: 0 LOB: 0 BB: 0 P: 7	R: 0 E: 0 K: 0 S: 3	H: 1 LOB: 1 BB: 1 P: 7	1B: 3 2B: 1 3B: 0 HR: 0	SF: 0 SAC: 0 DP: 1 HBP: 0	WP: 0 PB: 0 SB: 0 CS: 0	PA: 33																
<b>PITCHER</b> Johnny Antonelli, L (1, 1) ERA: 1.13	IP: 9.0 WLS: W BF: 33 H: 3 R: 0 ER: 0 SO: 3 BB: 3 IBB: 0 HBP: 0 BLK: 0 WP: 0 HR: 0 S: 36 P: 48 ERA: 0.00 WHIP: 0.667																																			
<b>PITCHER</b>	IP	WLS	BF	H	R	ER	SO	BB	IBB	HBP	BLK	WP	HR	S	P	ERA	WHIP																			

Philadelphia Phillies @ New York Giants  
Polo Grounds, New York, NY  
Sun Apr 25 1954, 3:38 AM EDT  
Att. 22,778 - Unknown

AB	30
R	0
H	3
RBI	0
BB	3
SO	3
LOB	12



Batter	1	2	3	4	5	6	7	8	9	AB	R	H	RBI	BB	SO	LOB
Whitey Lockman, L (1, 3) OBP: 0.302, SLG: 0.447	0-0 F8		0-0 1B 1B		0-0 P3		0-0 2B			4	0	2	1	0	0	0
Alvin Dark, R (1, 6) OBP: 0.298, SLG: 0.447	0-0 6-3		0-0 F7		0-0 HR 1B		0-0 5-3			4	1	1	0	0	0	4
Hank Thompson, L (1, 5) OBP: 0.419, SLG: 0.485	0-0 L3		0-0 1B		0-0 HR		0-3 K			4	1	2	2	0	1	2
Willie Mays, R (1, 8) OBP: 0.289, SLG: 0.523		0-3 K		0-0 F2		0-0 F8		0-0 F9		4	0	0	0	0	1	2
Don Mueller, L (1, 9) OBP: 0.324, SLG: 0.441		0-0 4-3		0-0 HR 1B		0-0 4-3		0-0 F7		4	1	1	0	0	0	0
Monte Irvin, R (1, 7) OBP: 0.310, SLG: 0.564		0-0 F7		0-0 HR		0-3 K		0-0 6-3		4	1	1	2	0	1	0
Davey Williams, R (1, 4) OBP: 0.205, SLG: 0.167			0-0 L4		0-0 L4		0-0 5-3		0-0 E8	4	0	0	0	0	0	0
Wes Westrum, R (1, 2) OBP: 0.400, SLG: 0.143			4-0 1B BB		0-0 1B		0-0 P5		4-0 BB	2	1	1	0	2	0	0
Johnny Antonelli, L (1, 1) OBP: 0.364, SLG: 0.364			0-0 1B 1B		0-0 G3		0-0 2B 1B		0-0 F7	4	0	2	0	0	0	3

Inning Stats	R: 0	H: 0	E: 0	K: 0	S: 3	LOB: 0	BB: 0	P: 3	R: 0	H: 0	E: 0	K: 1	S: 5	LOB: 0	BB: 0	P: 5	R: 1	H: 3	E: 0	K: 0	S: 5	LOB: 3	BB: 1	P: 9	R: 2	H: 3	E: 0	K: 0	S: 6	LOB: 1	BB: 0	P: 6	R: 2	H: 2	E: 0	K: 1	S: 5	LOB: 0	BB: 0	P: 5	R: 0	H: 0	E: 0	K: 1	S: 5	LOB: 0	BB: 0	P: 5	R: 0	H: 2	E: 0	K: 1	S: 7	LOB: 2	BB: 0	P: 7	R: 0	H: 0	E: 1	K: 0	S: 4	LOB: 2	BB: 1	P: 8
1B: 7	SF: 0	2B: 1	SAC: 0	3B: 0	DP: 0	HR: 2	HBP: 0	WP: 0	PA: 36																																																							

PITCHER	IP	WLS	BF	H	R	ER	SO	BB	IBB	HBP	BLK	WP	HR	S	P	ERA	WHIP
Murry Dickson, R (1, 1) ERA: 3.43	5.0	L	23	8	5	5	1	1	0	0	0	0	2	24	28	9.00	1.800
Karl Drews, R (6, 1) ERA:	2.0		8	2	0	0	2	0	0	0	0	0	0	12	12	0.00	1.000
Bob Greenwood, R (8, 1) ERA:	1.0		5	0	0	0	0	1	0	0	0	0	0	4	8	0.00	1.000

**BOTTOM**

**Philadelphia Phillies @ New York Giants**  
Polo Grounds, New York, NY

Sun Apr 25 1954, 3:38 AM EDT  
Att. 22,778 - Unknown

[livebaseballscorecards.com](http://livebaseballscorecards.com)

<b>AB</b>	<b>34</b>
<b>R</b>	<b>5</b>
<b>H</b>	<b>10</b>
<b>RBI</b>	<b>5</b>
<b>BB</b>	<b>2</b>
<b>SO</b>	<b>3</b>
<b>LOB</b>	<b>11</b>



New York Giants @ Milwaukee Braves  
Milwaukee County Stadium, Milwaukee, WI

Tue Apr 27 1954, 4:33 AM EDT  
Att. 24,143 - Unknown

AB	35
R	2
H	9
RBI	2
BB	6
SO	2
LOB	22



Batter	1	2	3	4	5	6	7	8	9	AB R H RBI BB SO LOB
Whitey Lockman, L (1, 3) OBP: 0.333, SLG: 0.452	0-0 4-3 1B		0-0 4-3 1B		0-0 6-3 1B		0-0 G1-6-3 1B	4-0 1-2 BB		4 0 2 0 1 0 0
Alvin Dark, R (1, 6) OBP: 0.308, SLG: 0.431	0-0 4-3 1-2		4-0 1B BB		0-0 1B		0-0 G1-6-3 1-2f	0-0 P4		4 0 1 0 1 0 5
Hank Thompson, L (1, 5) OBP: 0.438, SLG: 0.472	0-3 K		0-0 1-3 BB 1B		0-0 4-3		4-0 WP BB	4-0 G4-6-3 BB		3 0 1 0 2 1 2
Willie Mays, R (1, 8) OBP: 0.300, SLG: 0.500	0-0 P3		4-0 1-2 BB		0-0 FC6-4 1B		0-0 P6 1-2	0-0 G4-6-3 1-2f		4 0 1 0 1 0 3
Don Mueller, L (1, 9) OBP: 0.310, SLG: 0.410		0-0 6-3 1B	0-0 F5		0-0 FC6-4 1B		0-0 6-3	0-0 4-3		5 1 1 0 0 0 4
Monte Irvin, R (1, 7) OBP: 0.283, SLG: 0.512		0-0 6-3 1-2		0-0 5-3		0-0 E4 FC6-4	0-0 6-3			4 0 0 0 0 0 2
Davey Williams, R (1, 4) OBP: 0.209, SLG: 0.175		0-0 6-3		0-0 6-3		0-0 FC6-4 PB 1B	0-0 BB 1B			4 1 1 0 0 0 3
Wes Westrum, R (1, 2) OBP: 0.333, SLG: 0.111		0-0 5-3		0-0 F2		0-0 PB 1B	4-0 1B BB			2 0 0 0 0 0 1
Dusty Rhodes, L (6, PH) OBP: 0.600, SLG: 0.500						1-2 3-H 1B	1-2 BB			1 0 1 1 0 0 0
Ray Katt, R (6, 2) OBP: 0.308, SLG: 0.273										0 0 0 0 1 0 0
Ron Samford, R (8, PR)										0 0 0 0 0 0 0
Ebba St. Claire, S (8, 2) OBP: 0.450, SLG: 0.429										0 0 0 0 0 0 0
Larry Jansen, R (1, 1)			0-0 4-3		0-3 K		0-0 3-1	0-0 1-3 2-H 1B		2 0 0 0 0 1 0
Harvey Gentry, L (8, PH) OBP: 0.400, SLG: 0.250										1 0 0 0 0 0 2
Hoyt Wilhelm, R (6, 1)										0 0 0 0 0 0 0
Bill Taylor, L (8, PH) OBP: 0.286, SLG: 0.286										1 0 1 1 0 0 0
Billy Gardner, R (8, PR) OBP: 1.000, SLG: 1.000										0 0 0 0 0 0 0
Al Corwin, R (8, 1)										0 0 0 0 0 0 0

Inning Stats	R: 0 E: 0 K: 1 S: 6	H: 1 LOB: 1 BB: 0 P: 6	R: 0 E: 0 K: 0 S: 4	H: 1 LOB: 1 BB: 0 P: 4	R: 0 E: 0 K: 0 S: 4	H: 1 LOB: 3 BB: 2 P: 12	R: 0 E: 0 K: 0 S: 3	H: 0 LOB: 0 BB: 0 P: 3	R: 0 E: 0 K: 1 S: 6	H: 1 LOB: 1 BB: 0 P: 6	R: 1 E: 1 K: 0 S: 6	H: 2 LOB: 2 BB: 0 P: 6	R: 0 E: 0 K: 0 S: 3	H: 1 LOB: 1 BB: 1 P: 7	R: 1 E: 0 K: 0 S: 5	H: 2 LOB: 3 BB: 2 P: 13	R: 0 E: 0 K: 0 S: 2	H: 0 LOB: 0 BB: 1 P: 6	1B: 9 2B: 0 3B: 0 HR: 0	SF: 0 SAC: 0 DP: 2 HBP: 0	WP: 1 PB: 1 SB: 0 CS: 0	PA: 41
--------------	------------------------------	---------------------------------	------------------------------	---------------------------------	------------------------------	----------------------------------	------------------------------	---------------------------------	------------------------------	---------------------------------	------------------------------	---------------------------------	------------------------------	---------------------------------	------------------------------	----------------------------------	------------------------------	---------------------------------	----------------------------------	------------------------------------	----------------------------------	--------

PITCHER	IP	WLS	BF	H	R	ER	SO	BB	IBB	HBP	BLK	WP	HR	S	P	ERA	WHIP
Bob Buhl, R (1, 1) ERA: 5.89	7.2		36	9	2	1	2	4	0	0	0	1	0	36	52	1.17	1.696
Dave Jolly, R (8, 1) ERA: 1.08	1.1	W	5	0	0	0	0	2	0	0	0	0	0	3	11	0.00	1.500

WP: 1	PA: 41
-------	--------



Batter	1	2	3	4	5	6	7	8	9	AB	R	H	RBI	BB	SO	LOB	
Jack Dittmer, L (1, 4) OBP: 0.182, SLG: 0.406	0-3 K		0-0 2B		0-0 E6		0-0 FC5-4			4	0	1	0	0	1	1	
Danny O'Connell, R (1, 5) OBP: 0.417, SLG: 0.467	0-0 1B		0-0 F7		0-0 G6-4-3		0-0 4-3			4	0	1	0	0	0	3	
Eddie Mathews, L (1, 7) OBP: 0.391, SLG: 0.667	0-0 G6-3			0-3 K	0-0 F9			4-0 1B S 1B BB		3	1	0	0	1	1	1	
Andy Pafko, R (1, 8) OBP: 0.500, SLG: 0.565		0-0 1B		0-0 1B 4-3 1B 1B		4-0 F7 SH1-4 BB		0-0 F7		3	1	2	0	1	0	1	
Joe Adcock, R (1, 3) OBP: 0.442, SLG: 0.649		0-0 P4		0-0 4-3		0-0 SH1-4		0-0 5-3		3	0	0	0	0	0	3	
Hank Aaron, R (1, 9) OBP: 0.404, SLG: 0.558		0-0 F2		0-0 BB 1B 1B		0-0 F7		0-0 1B 1B		4	1	2	0	0	0	2	
Johnny Logan, R (1, 6) OBP: 0.319, SLG: 0.512		0-0 G3		4-0 1B BB 1-2		0-0 F7		0-0 1B		3	0	1	1	1	0	2	
Del Crandall, R (1, 2) OBP: 0.250, SLG: 0.286			0-0 F8		0-0 1B		0-3 K FC5-4		0-0 F7		4	0	1	2	0	1	2
Bob Buhl, R (1, 1)			0-0 P4		0-3 K		0-0 F3			3	0	0	0	0	1	3	
Dave Jolly, R (8, 1)										0	0	0	0	0	0	0	

Inning Stats	R: 0	H: 1	E: 0	LOB: 0	K: 1	S: 5	P: 5	R: 0	H: 1	E: 0	LOB: 1	K: 0	BB: 0	S: 4	P: 4	R: 0	H: 1	E: 0	LOB: 1	K: 0	BB: 0	S: 4	P: 4	R: 2	H: 3	E: 0	LOB: 2	K: 2	BB: 1	S: 10	P: 14	R: 0	H: 0	E: 1	LOB: 0	K: 0	BB: 0	S: 3	P: 3	R: 0	H: 0	E: 0	LOB: 1	K: 0	BB: 1	S: 3	P: 7	R: 0	H: 0	E: 2	LOB: 1	K: 1	BB: 0	S: 6	P: 6	R: 1	H: 2	E: 0	LOB: 2	K: 0	BB: 1	S: 5	P: 9
Larry Jansen, R (1, 1) ERA: 6.55	IP	WLS	BF	H	R	ER	SO	BB	IBB	HBP	BLK	WP	HR	S	P	ERA	WHIP																																														
Hoyt Wilhelm, R ERA:	(6, 1)	2.0	8	0	0	0	1	1	0	0	0	0	0	9	13	0.00	0.500																																														
Al Corwin, R ERA: 3.38	(8, 1)	1.0	L	6	2	1	1	0	1	0	0	0	0	5	9	9.00	3.000																																														

**BOTTOM**

**New York Giants @ Milwaukee Braves**  
Milwaukee County Stadium, Milwaukee, WI

Tue Apr 27 1954, 4:33 AM EDT  
Att. 24,143 - Unknown

AB	31
R	3
H	8
RBI	3
BB	3
SO	4
LOB	18

WP: 0 PA: 35  
PB: 0  
SB: 1  
CS: 0



1B	2B	3B	HR	SF	SAC	DP	HBP	WP	HR	S	P	ERA	WHIP
7	1	0	0	0	1	2	0	0	0	0	0	3.60	1.400
0	0	0	0	0	0	0	0	0	0	0	0	0.00	0.500
0	0	0	0	0	0	0	0	0	0	0	0	9.00	3.000

**New York Giants @ Milwaukee Braves**  
 Milwaukee County Stadium, Milwaukee, WI

Wed Apr 28 1954, 4:33 AM EDT  
 Att: 11,468 - Unknown

AB	34
R	3
H	7
RBI	3
BB	5
SO	0
LOB	15



WP:	0	PA:	39
PB:	0		
SB:	0		
CS:	0		

AB R H RBI BB SO LOB

4	0	0	0	1	0	0
4	0	1	2	1	0	0
5	0	1	0	0	0	3
4	0	0	0	0	0	1
4	0	3	0	0	0	0
3	1	0	0	1	0	2
3	1	1	0	1	0	2
3	0	0	0	1	0	4
3	1	1	1	0	0	3
1	0	0	0	0	0	0

Batter	1	2	3	4	5	6	7	8	9
<b>Whitey Lockman, L</b> (1, 3) OBP: 0.321, SLG: 0.413	0-0 1-3		0-0 4-3		0-0 4-3		BB 4-0 2B 1-2 BB		0-0 P4
<b>Alvin Dark, R</b> (1, 6) OBP: 0.316, SLG: 0.436	0-0 1-3		0-0 G3			0-0 5-3	0-0 2B		4-0 BB
<b>Willie Mays, R</b> (1, 8) OBP: 0.291, SLG: 0.472	0-0 5-3		0-0 1B			0-0 5-3	0-0 5-3		0-0 5-3
<b>Hank Thompson, L</b> (1, 5) OBP: 0.404, SLG: 0.425		0-0 3-1	0-0 4-3			0-0 P6		0-0 P4	
<b>Don Mueller, L</b> (1, 9) OBP: 0.348, SLG: 0.442				0-0 L9			0-0 FC1-6 1B	0-0 BB 1B	
<b>Monte Irvin, R</b> (1, 7) OBP: 0.280, SLG: 0.478		4-0 BB 1B		0-0 6-3			0-0 FC1-6 1B	0-0 F8	
<b>Davey Williams, R</b> (1, 4) OBP: 0.234, SLG: 0.186				0-0 6-3			0-0 1B 2B 1B	4-0 BB	
<b>Wes Westrum, R</b> (1, 2) OBP: 0.313, SLG: 0.083		4-0 BB			0-0 F8		0-0 F7	0-0 F7	
<b>Ruben Gomez, R</b> (1, 1) OBP: 0.250, SLG: 0.250					0-0 6-3		0-0 BB 2B 1B		0-0 G3
<b>Hoyt Wilhelm, R</b> (7, 1)									

Inning Stats	R: 0	H: 0	E: 0	K: 0	S: 3	P: 3	R: 0	H: 1	E: 0	K: 0	S: 4	P: 12	R: 0	H: 1	E: 0	K: 0	S: 4	P: 4	R: 0	H: 0	E: 0	K: 0	S: 3	P: 3	R: 0	H: 0	E: 0	K: 0	S: 3	P: 3	R: 3	H: 4	E: 0	K: 0	S: 7	P: 11	R: 0	H: 1	E: 0	K: 0	S: 4	P: 8	R: 0	H: 0	E: 0	K: 0	S: 3	P: 7	1B: 6	2B: 1	3B: 0	HR: 0	SF: 0	SAC: 0	DP: 0	HBP: 0	WP: 0	PA: 39
--------------	------	------	------	------	------	------	------	------	------	------	------	-------	------	------	------	------	------	------	------	------	------	------	------	------	------	------	------	------	------	------	------	------	------	------	------	-------	------	------	------	------	------	------	------	------	------	------	------	------	-------	-------	-------	-------	-------	--------	-------	--------	-------	--------

PITCHER	IP	WLS	BF	H	R	ER	SO	BB	IBB	HBP	BLK	WP	HR	S	P	ERA	WHIP
<b>Lew Burdette, R</b> (1, 1) ERA: 3.22	6.2	L	29	6	3	3	0	3	0	0	0	0	0	26	38	4.05	1.350
<b>Ray Crone, R</b> (7, 1) ERA: 2.45	0.1		1	0	0	0	0	0	0	0	0	0	0	1	1	0.00	0.000
<b>Ernie Johnson, R</b> (8, 1) ERA: 1.93	2.0		9	1	0	0	0	2	0	0	0	0	0	7	15	0.00	1.500

PITCHER	IP	WLS	BF	H	R	ER	SO	BB	IBB	HBP	BLK	WP	HR	S	P	ERA	WHIP
---------	----	-----	----	---	---	----	----	----	-----	-----	-----	----	----	---	---	-----	------

**BOTTOM**

**New York Giants @ Milwaukee Braves**  
**Milwaukee County Stadium, Milwaukee, WI**

Wed Apr 28 1954, 4:33 AM EDT  
 Att. 11,468 - Unknown

[livebaseballscorecards.com](http://livebaseballscorecards.com)

<b>AB</b>	<b>34</b>
<b>R</b>	<b>1</b>
<b>H</b>	<b>8</b>
<b>RBI</b>	<b>1</b>
<b>BB</b>	<b>2</b>
<b>SO</b>	<b>1</b>
<b>LOB</b>	<b>13</b>



WP:	1	PA:	36
PB:	0		
SB:	0		
CS:	0		

AB	R	H	RBI	BB	SO	LOB
4	0	1	0	0	0	3
4	0	0	0	0	1	1
3	0	0	0	1	0	0
4	0	0	0	0	0	1
4	0	2	0	0	0	0
4	1	1	0	0	0	2
4	0	2	0	0	0	2
3	0	1	1	0	0	1
0	0	0	0	0	0	0
0	0	0	0	0	0	0
0	0	0	0	1	0	0
2	0	0	0	0	0	1
0	0	0	0	0	0	0
2	0	1	0	0	0	2

Batter	1	2	3	4	5	6	7	8	9
<b>Jack Dittmer, L</b> (1, 4) OBP: 0.189, SLG: 0.389	0-0 F9 		0-0 1B		0-0 G3 		0-0 P3 		
<b>Danny O'Connell, R</b> (1, 5) OBP: 0.385, SLG: 0.429	0-0 F8 		0-0 1-3 			0-3 K2-3 		0-0 1-3 	
<b>Eddie Mathews, L</b> (1, 7) OBP: 0.380, SLG: 0.619	0-0 5-3 			0-0 G3 		4-0 G6-4-3 BB 		0-0 F8 	
<b>Andy Pafko, R</b> (1, 8) OBP: 0.433, SLG: 0.481		0-0 5-3 		0-0 F8 		0-0 G6-4-3 1-2f 		0-0 F7 	
<b>Joe Adcock, R</b> (1, 3) OBP: 0.447, SLG: 0.634		0-0 1B		0-0 1B		0-0 F2 		0-0 F2 	
<b>Hank Aaron, R</b> (1, 9) OBP: 0.392, SLG: 0.553		0-0 F8 		0-0 F3 		0-0 1B 2B		0-0 F7 	
<b>Johnny Logan, R</b> (1, 6) OBP: 0.333, SLG: 0.511		0-0 1-3 			0-0 G1 1B		0-0 5-3 		0-0 WP 1B
<b>Del Crandall, R</b> (1, 2) OBP: 0.257, SLG: 0.290 <b>Sibby Sisti, R</b> (7, PR)			0-0 F8 		0-0 G1 1-2		0-0 1B 2-H 1B		4-0 BB 1-2
<b>Ernie Johnson, R</b> (8, 1) OBP: 0.500, SLG: 0.500 <b>George Metkovich, L</b> (9, PH) OBP: 0.214, SLG: 0.250			0-0 G3		0-0 F9 		0-0 1-3 1B		0-0 F8 
<b>Lew Burdette, R</b> (1, 1) <b>Ray Crone, R</b> (7, 1) <b>Charlie White, L</b> (7, PH) OBP: 0.333, SLG: 0.625 (8, 2)									

Inning Stats	R: 0	H: 0	E: 0	K: 0	S: 3	R: 0	H: 1	E: 0	K: 0	S: 4	R: 0	H: 1	E: 0	K: 0	S: 4	R: 0	H: 1	E: 0	K: 0	S: 4	R: 0	H: 0	E: 0	K: 1	S: 4	R: 1	H: 3	E: 0	K: 0	S: 6	R: 0	H: 0	E: 0	K: 0	S: 3	R: 0	H: 1	E: 0	K: 0	S: 4	1B: 7	2B: 1	3B: 0	HR: 0	SF: 0	SAC: 0	DP: 1	HBP: 0	WP: 1	PB: 0	SB: 0	CS: 0
--------------	------	------	------	------	------	------	------	------	------	------	------	------	------	------	------	------	------	------	------	------	------	------	------	------	------	------	------	------	------	------	------	------	------	------	------	------	------	------	------	------	-------	-------	-------	-------	-------	--------	-------	--------	-------	-------	-------	-------

PITCHER	IP	WLS	BF	H	R	ER	SO	BB	IBB	HBP	BLK	WP	HR	S	P	ERA	WHIP
<b>Ruben Gomez, R</b> (1, 1) ERA: 7.84	6.0	W	22	4	0	0	1	1	0	0	0	0	0	23	27	0.00	0.833
<b>Hoyt Wilhelm, R</b> (7, 1) ERA: 0.9	3.0	S	14	4	1	1	0	1	0	0	0	1	0	13	17	3.00	1.667

PITCHER	IP	WLS	BF	H	R	ER	SO	BB	IBB	HBP	BLK	WP	HR	S	P	ERA	WHIP
---------	----	-----	----	---	---	----	----	----	-----	-----	-----	----	----	---	---	-----	------

Batter	1	2	3	4	5	6	7	8	9	AB	R	H	RBI	BB	SO	LOB	TOP																						
Whitey Lockman, L (1, 3) OBP: 0.321, SLG: 0.413											0	0	0	0	0	0	0																						
Alvin Dark, R (1, 6) OBP: 0.316, SLG: 0.436											0	0	0	0	0	0	0	0																					
Willie Mays, R (1, 8) OBP: 0.291, SLG: 0.472											0	0	0	0	0	0	0	0																					
Hank Thompson, L (1, 5) OBP: 0.404, SLG: 0.425											0	0	0	0	0	0	0	0																					
Don Mueller, L (1, 9) OBP: 0.348, SLG: 0.442											0	0	0	0	0	0	0	0																					
Monte Irvin, R (1, 7) OBP: 0.280, SLG: 0.478											0	0	0	0	0	0	0	0																					
Davey Williams, R (1, 4) OBP: 0.234, SLG: 0.186											0	0	0	0	0	0	0	0																					
Wes Westrum, R (1, 2) OBP: 0.313, SLG: 0.083											0	0	0	0	0	0	0	0																					
Sal Maglie, R (1, 1) OBP: 0.111, SLG: 0.111											0	0	0	0	0	0	0	0																					
<b>Inning Stats</b>											1B: 0	SF: 0	WP: 0	PA: 0																									
<b>PITCHER</b>	IP	WLS	BF	H	R	ER	SO	BB	IBB	HBP	BLK	WP	HR	S	P	ERA	WHIP	<b>PITCHER</b>	IP	WLS	BF	H	R	ER	SO	BB	IBB	HBP	BLK	WP	HR	S	P	ERA	WHIP				
Bob Rush, R (1, 1) ERA: 4.15	0.0		0	0	0	0	0	0	0	0	0	0	0	0	0	∞	∞																						

**New York Giants @ Chicago Cubs**  
 Wrigley Field, Chicago, IL  
 Fri Apr 30 1954, 3:33 AM CDT  
 Att. 7,151 - Unknown

[livebaseballscorecards.com](http://livebaseballscorecards.com)

**AB** 0  
**R** 0  
**H** 0  
**RBI** 0  
**BB** 0  
**SO** 0  
**LOB** 0









Batter	1	2	3	4	5	6	7	8	9	AB R H RBI BB SO LOB	TOP																
Davey Williams, R (1, 4) OBP: 0.230, SLG: 0.164	0-0 F8			0-0 2B 1B	0-0 F3		0-0 4-3			4 1 1 0 0 0 1																	
Alvin Dark, R (1, 6) OBP: 0.296, SLG: 0.397	0-0 G4-6-3 1B			0-0 1-3	0-0 F8		0-0 F7			4 0 1 0 0 0 2																	
Hank Thompson, L (1, 5) OBP: 0.424, SLG: 0.469	0-0 G4-6-3 1-2f			0-0 2B		0-3 K				4 1 1 1 0 2 1																	
Monte Irvin, R (1, 7) OBP: 0.313, SLG: 0.526		0-3 K		0-0 2B		0-0 HR		0-3 BB		3 2 2 2 1 1 0																	
Don Mueller, L (1, 9) OBP: 0.350, SLG: 0.456		0-0 1-3		0-0 G5-4-3 1B		0-0 F9		0-0 F9		4 0 1 1 0 0 1																	
Willie Mays, R (1, 8) OBP: 0.261, SLG: 0.439		0-0 5-3		0-0 G5-4-3 1-2f		4-0 BB		0-0 F9		3 0 0 0 1 0 2																	
Whitey Lockman, L (1, 3) OBP: 0.284, SLG: 0.400			0-0 3-1		0-0 HR		0-0 F4		0-0 F3	4 1 1 1 0 0 1																	
Wes Westrum, R (1, 2) OBP: 0.333, SLG: 0.286			0-0 F7		0-0 HR		0-0 SH2-4 1B		0-0 F9	4 1 2 1 0 0 0																	
Johnny Antonelli, L (1, 1) OBP: 0.308, SLG: 0.308			0-3 K		0-3 K		0-0 SH2-4		0-3 K	2 0 0 0 0 2 0																	
Jim Hearn, R (5, 1)										0 0 0 0 0 0 0																	
Mario Picone, R (8, 1)										0 0 0 0 0 0 0																	
Bobby Hofman, R (9, PH)										1 0 0 0 0 1 0																	
<b>Inning Stats</b>	R: 0 E: 0 K: 0 S: 3	H: 1 LOB: 0 BB: 0 P: 3	R: 0 E: 0 K: 1 S: 5	H: 0 LOB: 0 BB: 0 P: 5	R: 0 E: 0 K: 1 S: 5	H: 0 LOB: 0 BB: 0 P: 5	R: 3 E: 0 K: 0 S: 6	H: 4 LOB: 0 BB: 0 P: 6	R: 2 E: 0 K: 1 S: 7	H: 2 LOB: 0 BB: 0 P: 7	R: 1 E: 0 K: 1 S: 6	H: 1 LOB: 1 BB: 1 P: 10	R: 0 E: 0 K: 0 S: 4	H: 1 LOB: 1 BB: 0 P: 4	R: 0 E: 0 K: 1 S: 5	H: 0 LOB: 1 BB: 1 P: 9	R: 0 E: 0 K: 1 S: 5	H: 0 LOB: 0 BB: 0 P: 5	1B: 4 2B: 2 3B: 0 HR: 3	SF: 0 SAC: 1 DP: 2 HBP: 0	WP: 0 PB: 0 SB: 0 CS: 0	PA: 36					
<b>PITCHER</b>	IP WLS BF H R ER SO BB IBB HBP BLK WP HR S P ERA WHIP																										
Gerry Staley, R (1, 1) ERA: 6.29	5.0	20	7	5	5	3	0	0	0	0	0	2	26	26	9.00	1.400											
Al Brazle, L (6, 1) ERA: 4.32	4.0	W	16	2	1	1	3	2	0	0	0	0	1	20	28	2.25	1.000										

**New York Giants @ St. Louis Cardinals**  
 Sportsman's Park, St. Louis, MO  
 Sun May 02 1954, 4:33 AM EDT  
 Unknown

[livebaseballscorecards.com](http://livebaseballscorecards.com)

<b>AB</b>	33
<b>R</b>	6
<b>H</b>	9
<b>RBI</b>	6
<b>BB</b>	2
<b>SO</b>	6
<b>LOB</b>	8





Batter	1	2	3	4	5	6	7	8	9
Wally Moon, L OBP: 0.446, SLG: 0.607 (1, 8)	0-0 HR	0-0 F3		0-0 3-1		0-0 5-3		0-0 HR BB 1B	
Red Schoendienst, S OBP: 0.271, SLG: 0.250 (1, 4)	4-0 FC6-4 BB 1B BB		0-0 5-3		0-0 E6 HR	0-0 F7		4-0 1-2 HR BB	
Stan Musial, L OBP: 0.500, SLG: 0.839 (1, 9)	4-0 FC6-4 1-2 BB		0-0 HR		0-0 1-H HR	0-0 1B		0-0 1-H 2-H HR	
Ray Jablonski, R OBP: 0.400, SLG: 0.530 (1, 5)	0-0 FC6-4 1B 1-2 2-3		0-0 5-3		0-0 2B FC4-2 1B	0-0 F3		0-0 F8	
Rip Repulski, R OBP: 0.347, SLG: 0.441 (1, 7)	0-3 K		0-3 K		0-0 FC4-2 1-3 2B		0-0 5-3	0-0 1B E 1B	
Tom Alston, L OBP: 0.373, SLG: 0.565 (1, 3)	0-0 1-2 3-H 1B			0-0 HR	4-0 FC4-2 BB		0-0 1B 1B	0-0 E5 CS 1-H 1B	
Alex Grammas, R OBP: 0.273, SLG: 0.240 Solly Hemus, L OBP: 0.600, SLG: 0.455 (5, PH) (6, 6)	0-3 K		0-0 6-3		0-0 FC4-2 1-2 2-3 3-H		0-0 1-2 1B	0-0 F3 2-3	
Del Rice, R OBP: 0.345, SLG: 0.385 (1, 2)		0-3 K		4-0 SH BB	0-3 K		0-0 F7		
Gerry Staley, R Peanuts Lowrey, R OBP: 0.375, SLG: 0.714 Al Brazle, L (6, 1)		0-0 F8		0-0 SH 1-2	0-3 K		0-0 F4		

Inning Stats	R: 2	H: 2	E: 0	K: 2	S: 9	LOB: 2	BB: 2	P: 17
	R: 0	H: 0	E: 0	K: 1	S: 5	LOB: 0	BB: 0	P: 5
	R: 1	H: 1	E: 0	K: 1	S: 6	LOB: 0	BB: 0	P: 6
	R: 1	H: 1	E: 0	K: 0	S: 4	LOB: 1	BB: 1	P: 8
	R: 2	H: 3	E: 1	K: 2	S: 11	LOB: 3	BB: 1	P: 15
	R: 0	H: 1	E: 0	K: 0	S: 4	LOB: 1	BB: 0	P: 4
	R: 0	H: 2	E: 0	K: 0	S: 5	LOB: 2	BB: 0	P: 5
	R: 4	H: 4	E: 1	K: 0	S: 6	LOB: 0	BB: 1	P: 10

PITCHER	IP	WLS	BF	H	R	ER	SO	BB	IBB	HBP	BLK	WP	HR	S	P	ERA	WHIP
Johnny Antonelli, L ERA: 2.57 (1, 1)	4.0		22	6	6	5	4	3	0	0	0	0	4	27	39	11.25	2.250
Jim Hearn, R ERA: 9.39 (5, 1)	3.1	L	20	8	4	4	2	2	0	0	0	0	1	22	30	10.80	3.000
Mario Picone, R ERA: (8, 1)	0.2		1	0	0	0	0	0	0	0	0	0	0	1	1	0.00	0.000

**BOTTOM**

**New York Giants @ St. Louis Cardinals**  
Sportsman's Park, St. Louis, MO

Sun May 02 1954, 4:33 AM EDT  
Unknown

AB	37
R	10
H	14
RBI	9
BB	5
SO	6
LOB	22

WP: 0 PA: 43  
PB: 0  
SB: 0  
CS: 1



AB	R	H	RBI	BB	SO	LOB
5	2	2	1	0	0	1
3	3	0	0	2	0	0
4	3	4	6	1	0	0
5	0	1	0	0	0	3
5	1	2	0	0	2	2
4	1	4	2	1	0	0
2	0	0	0	0	1	2
3	0	1	0	0	0	4
3	0	0	0	1	2	5
1	0	0	0	0	0	0
1	0	0	0	0	1	3
1	0	0	0	0	0	2

1B	2B	3B	HR	SF	SAC	DP	HBP
8	1	0	5	0	1	0	0

Batter	1	2	3	4	5	6	7	8	9	AB R H RBI BB SO LOB	TOP														
Whitey Lockman, L (1, 3) OBP: 0.306, SLG: 0.387	4-0 BB		4-0 FC6-4 BB	4-0 2B 1B BB	0-0 F7			0-3 K		2 1 0 0 3 1 0															
Alvin Dark, R (1, 6) OBP: 0.276, SLG: 0.370	0-0 F9		0-0 FC6-4 FC5 BB 1-2f	0-0 F9		0-0 F7		0-0 F7		5 0 0 0 0 0 3															
Hank Thompson, L (1, 5) OBP: 0.423, SLG: 0.472	0-0 F9		4-0 1-2 BB	0-0 1-3 1B 2B		0-0 F6		0-0 F8		4 1 1 0 1 0 1															
Monte Irvin, R (1, 7) OBP: 0.319, SLG: 0.508	0-0 1-3		0-0 FC5 2-3f	4-0 1B 1B BB		0-0 1B 1B		0-0 F3		4 1 1 0 1 0 3															
Don Mueller, L (1, 9) OBP: 0.400, SLG: 0.548		0-0 2B		SF9 3B 1B		0-0 1-2 1B		0-0 HBP 1B 1B		5 3 5 2 0 0 0															
Willie Mays, R (1, 8) OBP: 0.257, SLG: 0.429		0-0 6-3		SF9 1B 1B		0-0 F4		0-3 K		4 0 1 3 0 1 4															
Ebba St. Claire, S (1, 2) OBP: 0.500, SLG: 0.444		0-0 4-3		HR 1B 1B		0-3 K		1-0 1B HBP		4 1 2 0 0 1 1															
Joey Amalfitano, R (9, PR)										0 0 0 0 0 0 0	AB 38														
Wes Westrum, R (9, 2) OBP: 0.333, SLG: 0.286										0 0 0 0 0 0 0	R 9														
Ron Samford, R (1, 4)		0-0 6-3		0-0 1-2 HR 1B		0-0 K		0-0 F2		1 0 0 0 0 0 1	H 13														
Dusty Rhodes, L (4, PH) OBP: 0.571, SLG: 0.500										1 1 1 0 0 0 0	RBI 9														
Hoyt Wilhelm, R (4, 1)										2 0 0 0 0 1 0	BB 5														
Larry Jansen, R (7, 1) OBP: 0.250, SLG: 0.250										1 0 1 1 0 0 0	SO 4														
Don Liddle, L (1, 1)										1 0 0 0 0 0 0	LOB 15														
Bill Taylor, L (4, PH) OBP: 0.375, SLG: 0.286			0-0 4-3	0-0 1-H 2-H HR		0-0 F2		0-0 F8		0 0 0 0 0 0 0															
Bobby Hofman, R (4, PH) OBP: 0.077, SLG: 0.308										4 1 1 3 0 0 2															
<b>Inning Stats</b>	R: 0 E: 0 K: 0 S: 3	H: 0 LOB: 1 BB: 1 P: 7	R: 0 E: 0 K: 0 S: 4	H: 1 LOB: 1 BB: 0 P: 4	R: 0 E: 0 K: 0 S: 3	H: 0 LOB: 2 BB: 2 P: 11	R: 8 E: 0 K: 0 S: 10	H: 8 LOB: 2 BB: 2 P: 18	R: 0 E: 0 K: 1 S: 5	H: 0 LOB: 0 BB: 0 P: 5	R: 0 E: 0 K: 1 S: 5	H: 0 LOB: 0 BB: 0 P: 5	R: 0 E: 0 K: 1 S: 5	H: 0 LOB: 0 BB: 0 P: 5	R: 0 E: 0 K: 1 S: 5	H: 0 LOB: 0 BB: 0 P: 5	R: 1 E: 0 K: 1 S: 7	H: 2 LOB: 2 BB: 0 P: 8	1B: 9 2B: 2 3B: 1 HR: 1	SF: 1 SAC: 0 DP: 0 HBP: 1	WP: 0 PB: 0 SB: 0 CS: 0	PA: 45			
<b>PITCHER</b>	IP WLS BF H R ER SO BB IBB HBP BLK WP HR S P ERA WHIP																								
Joe Presko, R (1, 1) ERA: 4.26	3.1		17	4	3	3	0	3	0	0	0	0	0	14	26	8.10	2.100								
Royce Lint, L (4, 1) ERA: 8.22	0.1	L	6	3	3	3	0	2	0	0	0	0	1	4	12	81.00	15.000								
Mel Wright, R (4, 1) ERA: 14.73	2.1		10	4	2	2	1	0	0	0	0	0	0	12	12	7.71	1.714								
Tom Poholsky, R (7, 1) ERA: 7.2	1.0		3	0	0	0	1	0	0	0	0	0	0	5	5	0.00	0.000								
Cot Deal, R (8, 1) ERA: 7.59	2.0		9	2	1	1	2	0	0	1	0	0	0	12	13	4.50	1.000								

**New York Giants @ St. Louis Cardinals**  
 Sportsman's Park, St. Louis, MO  
 Sun May 02 1954, 4:38 AM EDT  
 Att. 26,662 - Unknown

[livebaseballscorecards.com](http://livebaseballscorecards.com)

AB 38  
 R 9  
 H 13  
 RBI 9  
 BB 5  
 SO 4  
 LOB 15



Batter	1	2	3	4	5	6	7	8	9	AB	R	H	RBI	BB	SO	LOB
Wally Moon, L OBP: 0.443, SLG: 0.585 (1, 8)	0-0 4-3 H	1-0 HBP		0-0 F4		0-3 K		0-0 G1-6-3 1B		4	0	1	0	0	1	1
Red Schoendienst, S OBP: 0.280, SLG: 0.304 (1, 4)	0-0 3-1 2B	0-0 F8			0-0 HR	0-0 4-3		0-0 G1-6-3 1-2f		5	2	2	0	0	0	3
Stan Musial, L OBP: 0.507, SLG: 0.917 (1, 9)	4-0 3-1 2B BB		0-0 F8		0-0 HR		0-0 HR		0-0 P3	4	3	2	3	1	0	0
Ray Jablonski, R OBP: 0.413, SLG: 0.577 (1, 5)	0-0 3-1 1-2 2-3		0-0 E S 1B		0-0 HR		0-0 G5-4-3 1B		0-0 4-3	5	1	3	1	0	0	2
Rip Repulski, R OBP: 0.338, SLG: 0.417 (1, 7)	4-0 2B BB		0-0 F9	1-3	0-3 K		0-0 G5-4-3 1-2f		0-3 K2-3	4	1	0	0	1	2	2
Tom Alston, L OBP: 0.400, SLG: 0.583 (1, 3)	0-0 1-H 2-H 3-H 2B		4-0 BB BB		0-0 F6		4-0 BB BB			2	0	1	3	2	0	0
Alex Grammas, R OBP: 0.259, SLG: 0.226 (1, 6)	0-0 F8		0-0 F8		0-3 K		4-0 BB BB			3	0	0	0	0	1	3
Tom Poholsky, R (7, 1)										0	0	0	0	0	0	0
Peanuts Lowrey, R (7, PH)										0	0	0	0	1	0	0
Cot Deal, S (8, 1)										0	0	0	0	0	0	0
Bill Sarni, R (1, 2)		0-0 5-3		0-0 F8		0-0 F8		0-0 1-3		2	0	0	0	0	0	0
Solly Hemus, L (6, PH)										2	0	0	0	0	0	2
Joe Presko, R (1, 1)		0-0 F9		0-0 1-3		0-0 2B		0-3 K		1	0	0	0	0	0	0
Royce Lint, L (4, 1)										0	0	0	0	0	0	0
Mel Wright, R (4, 1)										0	0	0	0	0	0	0
Joe Frazier, L (6, PH)										1	0	1	0	0	0	0
Stu Miller, R (6, PR)										0	0	0	0	0	0	0
Del Rice, R (7, 2)										1	0	0	0	0	1	0

Inning Stats	R: 3	H: 2	E: 0	K: 5	LOB: 1	BB: 2	P: 13	R: 0	H: 0	E: 0	K: 3	LOB: 1	BB: 0	P: 4	R: 0	H: 1	E: 0	K: 4	LOB: 2	BB: 1	P: 8	R: 0	H: 0	E: 0	K: 3	LOB: 0	BB: 0	P: 3	R: 3	H: 3	E: 0	K: 10	LOB: 0	BB: 0	P: 10	R: 0	H: 1	E: 0	K: 6	LOB: 1	BB: 0	P: 6	R: 1	H: 2	E: 0	K: 4	LOB: 2	BB: 2	P: 12	R: 0	H: 1	E: 0	K: 5	LOB: 0	BB: 0	P: 5	R: 0	H: 0	E: 0	K: 5	LOB: 0	BB: 0	P: 5
--------------	------	------	------	------	--------	-------	-------	------	------	------	------	--------	-------	------	------	------	------	------	--------	-------	------	------	------	------	------	--------	-------	------	------	------	------	-------	--------	-------	-------	------	------	------	------	--------	-------	------	------	------	------	------	--------	-------	-------	------	------	------	------	--------	-------	------	------	------	------	------	--------	-------	------

PITCHER	IP	WLS	BF	H	R	ER	SO	BB	IBB	HBP	BLK	WP	HR	S	P	ERA	WHIP
Don Liddle, L (1, 1)	3.0		16	3	3	3	0	3	0	0	0	0	0	12	25	9.00	2.000
Hoyt Wilhelm, R (4, 1)	3.0		15	6	4	4	3	0	0	0	0	0	3	21	21	12.00	2.000
Larry Jansen, R (7, 1)	3.0	W	10	1	0	0	2	2	0	0	0	0	0	12	20	0.00	1.000

**BOTTOM**

**New York Giants @ St. Louis Cardinals**  
Sportsman's Park, St. Louis, MO

Sun May 02 1954, 4:38 AM EDT  
Att. 26,662 - Unknown

AB	R	H	RBI	BB	SO	LOB
35	7	10	7	5	5	13

livebaseballscorecards.com



WP	HR	S	P	ERA	WHIP
0	0	0	0	0	0

Batter	1	2	3	4	5	6	7	8	9	AB R H RBI BB SO LOB	TOP							
Whitey Lockman, L (1, 3) OBP: 0.306, SLG: 0.387											0 0 0 0 0 0 0 0	<p style="text-align: center;"><b>New York Giants @ St. Louis Cardinals</b></p> <p style="text-align: center;">Sportsman's Park, St. Louis, MO</p> <p style="text-align: center;">Mon May 03 1954, 4:33 AM EDT Att. 5,480 - Unknown</p> <p style="text-align: right;"><a href="http://livebaseballscorecards.com">livebaseballscorecards.com</a></p>						
Alvin Dark, R (1, 6) OBP: 0.276, SLG: 0.370											0 0 0 0 0 0 0 0							
Hank Thompson, L (1, 5) OBP: 0.423, SLG: 0.472											0 0 0 0 0 0 0 0							
Monte Irvin, R (1, 7) OBP: 0.319, SLG: 0.508											0 0 0 0 0 0 0 0							
Don Mueller, L (1, 9) OBP: 0.400, SLG: 0.548											0 0 0 0 0 0 0 0							
Willie Mays, R (1, 8) OBP: 0.257, SLG: 0.429											0 0 0 0 0 0 0 0							
Davey Williams, R (1, 4) OBP: 0.230, SLG: 0.164											0 0 0 0 0 0 0 0		<b>AB</b> 0 <b>R</b> 0 <b>H</b> 0 <b>RBI</b> 0 <b>BB</b> 0 <b>SO</b> 0 <b>LOB</b> 0					
Wes Westrum, R (1, 2) OBP: 0.333, SLG: 0.286											0 0 0 0 0 0 0 0							
Ruben Gomez, R (1, 1) OBP: 0.250, SLG: 0.250											0 0 0 0 0 0 0 0							
<b>Inning Stats</b>											1B: 0 SF: 0 2B: 0 SAC: 0 3B: 0 DP: 0 HR: 0 HBP: 0 WP: 0 PA: 0 PB: 0 SB: 0 CS: 0							
<b>PITCHER</b> Vic Raschi, R (1, 1) ERA: 5.26	IP	WLS	BF	H	R	ER	SO	BB	IBB	HBP	BLK	WP	HR	S	P	ERA	WHIP	<b>PITCHER</b> IP WLS BF H R ER SO BB IBB HBP BLK WP HR S P ERA WHIP



Batter	1	2	3	4	5	6	7	8	9	AB R H RBI BB SO LOB	TOP											
Whitey Lockman, L (1, 3) OBP: 0.284, SLG: 0.352	0-0 1B 1B	0-0 4-3		0-0 G3			0-0 4-3		0-0 3-1	5 1 1 0 0 0 3												
Alvin Dark, R (1, 6) OBP: 0.274, SLG: 0.358	0-0 F7		0-0 1B		0-0 5-3		0-0 1B			4 0 2 0 0 0 1												
Willie Mays, R (1, 8) OBP: 0.268, SLG: 0.423	0-0 1B 1-3 1B		0-0 F8		0-0 F4		0-0 F8			4 0 1 0 0 0 2												
Monte Irvin, R (1, 7) OBP: 0.299, SLG: 0.507	0-0 F3		0-0 F9		0-0 F8			0-0 5-3		4 0 0 0 0 0 3												
Don Mueller, L (1, 9) OBP: 0.397, SLG: 0.522	0-0 FC6-4 1-2 3-H 1B		0-0 F4		0-0 6-3			4-0 1B BB		3 0 1 1 1 0 1												
Davey Williams, R (1, 4) OBP: 0.217, SLG: 0.159	0-0 FC6-4 1-2f		0-0 F9		0-0 1-3			0-0 1-2 1B G4-6-3		4 0 1 0 0 0 2												
Hank Thompson, L (1, 5) OBP: 0.456, SLG: 0.508		0-0 2B		0-0 SH1 BB 1B		4-0 BB		0-0 1-2f G4-6-3		3 0 2 0 1 0 2												
Wes Westrum, R (1, 2) OBP: 0.324, SLG: 0.231		0-0 F3		4-0 SH1 BB		0-0 F9		0-0 F6		3 0 0 0 1 0 2												
Sal Maglie, R (1, 1) OBP: 0.067, SLG: 0.067		0-0 G3		0-0 SH1			0-0 F9		0-0 F7	1 0 0 0 0 0 1												
Billy Gardner, R (7, PH) OBP: 0.667, SLG: 0.667				1-2 2-3						1 0 0 0 0 0 0												
Mario Picone, R (7, 1)										0 0 0 0 0 0 0												
Bobby Hofman, R (9, PH) OBP: 0.071, SLG: 0.286										1 0 0 0 0 0 0												
<b>Inning Stats</b>	R: 1 E: 0 K: 0 S: 6	H: 3 LOB: 2 BB: 0 P: 6	R: 0 E: 0 K: 0 S: 4	H: 1 LOB: 1 BB: 0 P: 4	R: 0 E: 0 K: 0 S: 4	H: 1 LOB: 1 BB: 0 P: 4	R: 0 E: 0 K: 0 S: 4	H: 1 LOB: 2 BB: 1 P: 8	R: 0 E: 0 K: 0 S: 3	H: 0 LOB: 0 BB: 0 P: 3	R: 0 E: 0 K: 0 S: 3	H: 0 LOB: 1 BB: 1 P: 7	R: 0 E: 0 K: 0 S: 4	H: 1 LOB: 1 BB: 0 P: 4	R: 0 E: 0 K: 0 S: 3	H: 1 LOB: 1 BB: 1 P: 7	R: 0 E: 0 K: 0 S: 3	H: 0 LOB: 0 BB: 0 P: 3	1B: 7 2B: 1 3B: 0 HR: 0	SF: 0 SAC: 1 DP: 1 HBP: 0	WP: 0 PB: 0 SB: 0 CS: 0	PA: 37
<b>PITCHER</b> Fred Baczewski, L (1, 1) ERA: 6.3	IP: 9.0 WLS: W BF: 37 H: 8 R: 1 ER: 1 SO: 0 BB: 3 IBB: 0 HBP: 0 BLK: 0 WP: 0 HR: 0 S: 34 P: 46 ERA: 1.00 WHIP: 1.222											<b>PITCHER</b>	IP: 9.0 WLS: W BF: 37 H: 8 R: 1 ER: 1 SO: 0 BB: 3 IBB: 0 HBP: 0 BLK: 0 WP: 0 HR: 0 S: 34 P: 46 ERA: 1.00 WHIP: 1.222									

**New York Giants @ Cincinnati Redlegs**  
 Crosley Field, Cincinnati, OH  
 Wed May 05 1954, 3:33 AM EDT  
 Att. 4,671 - Unknown

[livebaseballscorecards.com](http://livebaseballscorecards.com)

**AB 33**  
**R 1**  
**H 8**  
**RBI 1**  
**BB 3**  
**SO 0**  
**LOB 17**



Batter	1	2	3	4	5	6	7	8	9	AB	R	H	RBI	BB	SO	LOB
<b>Chuck Harmon, R</b> <small>OBP: 0.360, SLG: 0.500</small> (1, 5)	0-0 	0-0 		0-0 		0-0 		0-0 		5	1	2	2	0	0	1
<b>Roy McMillan, R</b> <small>OBP: 0.293, SLG: 0.254</small> (1, 6)	0-0 	0-0 		0-0 		0-0 		0-0 		5	0	1	0	0	0	3
<b>Gus Bell, L</b> <small>OBP: 0.337, SLG: 0.463</small> (1, 8)	0-0 		0-0 	0-0 		0-0 				4	1	2	3	0	0	1
<b>Ted Kluszewski, L</b> <small>OBP: 0.398, SLG: 0.594</small> (1, 3)	0-0 		0-0 	0-0 		0-0 				4	1	3	1	0	0	0
<b>Jim Greengrass, R</b> <small>OBP: 0.366, SLG: 0.581</small> (1, 7)	0-3 		4-0 	0-0 		0-0 				3	0	0	0	1	1	4
<b>Johnny Temple, R</b> <small>OBP: 0.451, SLG: 0.429</small> (1, 4)		0-0 	0-0 		0-0 		0-0 			4	0	1	0	0	0	0
<b>Lloyd Merriman, L</b> <small>OBP: 0.273, SLG: 0.333</small> (1, 9)		0-0 	0-0 		0-0 		0-0 			4	1	1	0	0	0	2
<b>Ed Bailey, L</b> <small>OBP: 0.364, SLG: 0.481</small> (1, 2)		0-0 		0-0 	0-0 		0-3 			4	2	2	1	0	1	0
<b>Fred Baczewski, L</b> <small>OBP: 0.143, SLG: 0.143</small> (1, 1)		0-3 		0-3 		0-0 		0-0 		4	1	1	0	0	2	2

Inning Stats	R: 0	H: 2	E: 0	K: 1	S: 7	R: 2	H: 3	E: 0	K: 1	S: 8	R: 0	H: 1	E: 0	K: 0	S: 4	R: 4	H: 4	E: 0	K: 1	S: 9	R: 0	H: 0	E: 0	K: 0	S: 3	R: 1	H: 3	E: 0	K: 0	S: 6	R: 0	H: 0	E: 0	K: 1	S: 5	R: 0	H: 0	E: 0	K: 0	S: 3
	LOB: 2	BB: 0	P: 7	LOB: 1	BB: 0	P: 8	LOB: 2	BB: 1	P: 8	LOB: 0	BB: 0	P: 9	LOB: 0	BB: 0	P: 3	LOB: 2	BB: 0	P: 6	LOB: 0	BB: 0	P: 5	LOB: 0	BB: 0	P: 3	LOB: 0	SAC: 0	DP: 0	HBP: 0	1B: 7	2B: 2	3B: 2	HR: 2	SF: 0	SAC: 0	DP: 0	HBP: 0	WP: 0	PB: 0	SB: 1	CS: 0

PITCHER	IP	WLS	BF	H	R	ER	SO	BB	IBB	HBP	BLK	WP	HR	S	P	ERA	WHIP
<b>Sal Maglie, R</b> <small>ERA: 3.05</small> (1, 1)	6.0	L	32	13	7	7	3	1	0	0	0	0	2	37	41	10.50	2.333
<b>Mario Picone, R</b> <small>ERA: 3.86</small> (7, 1)	2.0		6	0	0	0	1	0	0	0	0	0	0	8	8	0.00	0.000

**BOTTOM**

**New York Giants @ Cincinnati Redlegs**  
 Crosley Field, Cincinnati, OH

Wed May 05 1954, 3:33 AM EDT  
 Att. 4,671 - Unknown

<b>AB</b>	<b>37</b>
<b>R</b>	<b>7</b>
<b>H</b>	<b>13</b>
<b>RBI</b>	<b>7</b>
<b>BB</b>	<b>1</b>
<b>SO</b>	<b>4</b>
<b>LOB</b>	<b>13</b>

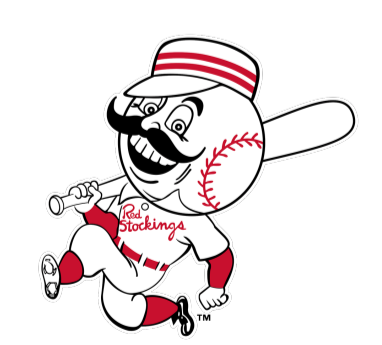

livebaseballscorecards.com





BOTTOM

New York Giants @ Cincinnati Redlegs  
Crosley Field, Cincinnati, OH  
Thu May 06 1954, 3:33 AM EDT  
Att. 2,566 - Unknown

livebaseballscorecards.com

AB	30
R	5
H	9
RBI	5
BB	2
SO	3
LOB	10

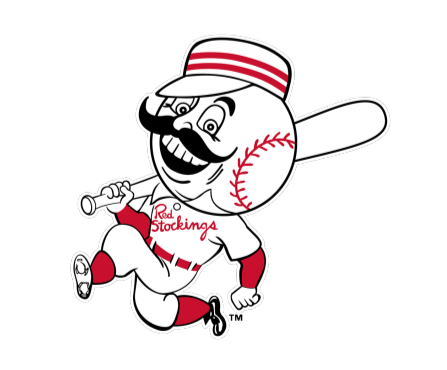

WP:	0	PA:	35
PB:	0	SB:	1
CS:	0		

AB R H RBI BB SO LOB

4 0 0 0 0 0 2

4 0 1 0 0 0 0

4 1 2 1 0 1 1

3 1 1 0 0 0 1

0 1 0 0 0 0 0

3 0 0 0 0 1 2

4 2 3 1 0 0 0

3 0 2 2 1 0 0

3 0 0 0 1 1 3

2 0 0 1 0 0 1

1B: 7 SF: 1  
2B: 1 SAC: 1  
3B: 0 DP: 1  
HR: 1 HBP: 1

WP: 0 PA: 35  
PB: 0 SB: 1  
CS: 0

Batter	1	2	3	4	5	6	7	8	9
Chuck Harmon, R OBP: 0.310, SLG: 0.423 (1, 5)	0-0 6-3	0-0 FC6-3			0-0 F9		0-0 F5		
Roy McMillan, R OBP: 0.291, SLG: 0.254 (1, 6)	0-0 6-3		0-0 F7		0-0 1B		0-0 6-3		
Gus Bell, L OBP: 0.344, SLG: 0.500 (1, 8)	0-0 HR		0-0 1B		0-0 4-3		0-3 K		
Ted Kluszewski, L OBP: 0.402, SLG: 0.583 Nino Escalera, L OBP: 0.365, SLG: 0.364 (1, 3) (8, PR) (9, 3)	0-0 G3		0-0 F8		0-0 E9 1B 2B 1B		1-0 SH1 1B HBP		
Jim Greengrass, R OBP: 0.353, SLG: 0.558 (1, 7)		0-0 1-3	0-0 F7		0-3 K		0-0 SH1		
Johnny Temple, R OBP: 0.465, SLG: 0.446 (1, 4)		0-0 BB SF8 1B		0-0 F6		0-0 2B 1B	0-0 2-H 1B		
Wally Post, R OBP: 0.273, SLG: 0.516 (1, 9)		0-0 BB 1B		0-0 F4		0-0 1-H 2B	4-0 BB G4-6-3		
Ed Bailey, L OBP: 0.351, SLG: 0.433 (1, 2)		4-0 FC6-3 BB		0-0 F4		0-3 K	0-0 G4-6-3		
Harry Perkowski, L (1, 1)		0-0 SF8		0-0 4-3		0-0 4-3			

Inning Stats	R: 1	H: 1	E: 0	K: 0	S: 4	H: 1	LOB: 0	BB: 0	P: 4	R: 1	H: 2	E: 0	K: 0	S: 5	H: 1	LOB: 2	BB: 1	P: 9	R: 0	H: 1	E: 0	K: 0	S: 4	R: 0	H: 0	E: 0	K: 0	S: 3	R: 0	H: 1	E: 0	K: 0	S: 4	R: 2	H: 3	E: 1	K: 2	S: 10	R: 0	H: 0	E: 0	K: 1	S: 5	R: 1	H: 1	E: 0	K: 0	S: 3
--------------	------	------	------	------	------	------	--------	-------	------	------	------	------	------	------	------	--------	-------	------	------	------	------	------	------	------	------	------	------	------	------	------	------	------	------	------	------	------	------	-------	------	------	------	------	------	------	------	------	------	------

PITCHER	IP	WLS	BF	H	R	ER	SO	BB	IBB	HBP	BLK	WP	HR	S	P	ERA	WHIP
Larry Jansen, R ERA: 5.59 (1, 1)	5.1		25	8	4	4	1	1	0	0	0	0	1	26	30	6.75	1.688
Mary Grissom, R ERA: 1.33 (6, 1)	0.2		2	0	0	0	1	0	0	0	0	0	0	4	4	0.00	0.000
Windy McCall, L ERA: 2.45 (7, 1)	1.1	L	6	1	1	1	1	0	0	1	0	0	0	7	8	6.75	0.750
Jim Hearn, R ERA: 8.64 (8, 1)	0.2		2	0	0	0	0	1	0	0	0	0	0	1	5	0.00	1.500

PITCHER	IP	WLS	BF	H	R	ER	SO	BB	IBB	HBP	BLK	WP	HR	S	P	ERA	WHIP
---------	----	-----	----	---	---	----	----	----	-----	-----	-----	----	----	---	---	-----	------

Batter	1	2	3	4	5	6	7	8	9	AB R H RBI BB SO LOB	TOP	
Davey Williams, R (1, 4) OBP: 0.228, SLG: 0.178	0-0 6-3	0-0 FC5-4		0-0 CS 1B			0-0 SH1-4 1B		0-0 F9	5 0 2 1 0 0 2		
Alvin Dark, R (1, 6) OBP: 0.272, SLG: 0.341	4-0 L9-4 1B BB	0-0 5-3		0-0 CS 1-2	0-3 K		0-0 SH1-4 1-2		0-0 4-3	3 0 0 0 1 1 2		
Hank Thompson, L (1, 5) OBP: 0.443, SLG: 0.522	0-0 1-2 1B		4-0 SH1-3 1B BB		0-0 F7		0-3 K		0-0 4-3	4 0 1 0 1 1 1		
Monte Irvin, R (1, 7) OBP: 0.329, SLG: 0.500	0-0 L9-4 2-3		0-0 SH1-3 1-2 1B		4-0 1B BB		0-0 F9			3 0 1 0 1 0 3		
Willie Mays, R (1, 8) OBP: 0.300, SLG: 0.500		0-0 HR	0-0 P3		0-0 1-3 1B		4-0 4-3 BB			3 1 2 1 1 0 2		
Don Mueller, L (1, 9) OBP: 0.388, SLG: 0.513		0-0 E FC5-4 2B	0-0 SH1-3 1-2 2-3		0-0 1-3		0-0 4-3			3 1 1 0 0 0 3		
Whitey Lockman, L (1, 3) OBP: 0.258, SLG: 0.316		0-0 F8	0-0 6-3			0-0 F8		0-0 F7		4 0 0 0 0 0 4		
Ebba St. Claire, S (1, 2) OBP: 0.419, SLG: 0.348 Ray Katt, R (8, PH) OBP: 0.412, SLG: 0.308 (8, 2)		0-0 E6 FC5-4 BB 2-3		0-3 K		0-0 G2		4-0 IBB		3 0 0 0 0 1 1 0 0 0 0 1 0 0		
Johnny Antonelli, L (1, 1) OBP: 0.294, SLG: 0.250		4-0 FC5-4 1-2 BB		0-3 K		0-0 6-3		0-0 P4		3 0 0 0 1 1 2		
<b>Inning Stats</b>	R: 0 E: 0 K: 0 S: 3 H: 1 LOB: 1 BB: 1 P: 7	R: 2 E: 1 K: 0 S: 6 H: 2 LOB: 2 BB: 1 P: 10	R: 0 E: 0 K: 0 S: 4 H: 1 LOB: 2 BB: 1 P: 8	R: 0 E: 0 K: 2 S: 7 H: 1 LOB: 0 BB: 0 P: 7	R: 0 E: 0 K: 1 S: 6 H: 1 LOB: 2 BB: 1 P: 10	R: 0 E: 0 K: 0 S: 3 H: 0 LOB: 0 BB: 0 P: 3	R: 0 E: 0 K: 1 S: 6 H: 1 LOB: 1 BB: 0 P: 6	R: 0 E: 0 K: 0 S: 3 H: 0 LOB: 2 BB: 2 P: 11	R: 0 E: 0 K: 0 S: 3 H: 0 LOB: 0 BB: 0 P: 3	1B: 5 2B: 2 3B: 0 HR: 1 SF: 0 SAC: 2 DP: 1 HBP: 0	WP: 0 PB: 0 SB: 0 CS: 1 PA: 40	
<b>PITCHER</b>	IP WLS BF H R ER SO BB IBB HBP BLK WP HR S P ERA WHIP											
Vern Law, R (1, 1) ERA: 6.26	2.0 L 13 4 2 1 0 3 0 0 0 0 0 1 10 22 4.50 3.500											
Bob Friend, R (3, 1) ERA: 6.75	5.0 18 3 0 0 4 1 0 0 0 0 0 0 25 29 0.00 0.800											
Paul LaPalme, L (8, 1) ERA: 3.33	2.0 8 0 0 0 0 1 1 0 0 0 0 0 6 14 0.00 0.500											

**New York Giants @ Pittsburgh Pirates**  
 Forbes Field, Pittsburgh, PA  
 Sat May 08 1954, 3:33 AM EDT  
 Att. 7,147 - Unknown

[livebaseballscorecards.com](http://livebaseballscorecards.com)

<b>AB</b>	31
<b>R</b>	2
<b>H</b>	7
<b>RBI</b>	2
<b>BB</b>	6
<b>SO</b>	4
<b>LOB</b>	20



BOTTOM

New York Giants @ Pittsburgh Pirates  
Forbes Field, Pittsburgh, PA  
Sat May 08 1954, 3:33 AM EDT  
Att. 7,147 - Unknown

livebaseballscorecards.com

AB 32  
R 1  
H 5  
RBI 1  
BB 4  
SO 8  
LOB 17



WP: 0 PA: 37  
PB: 0  
SB: 0  
CS: 0

AB R H RBI BB SO LOB

5 0 0 0 0 2 4

3 0 0 0 0 2 2

4 0 1 0 0 0 2

4 0 0 0 0 1 1

3 0 0 0 1 2 0

2 0 1 0 2 0 0

3 1 2 0 0 0 2

0 0 0 0 0 0 0

2 0 0 0 0 0 1

1 0 0 0 0 0 1

0 0 0 0 0 0 0

1 0 0 0 0 1 2

1B: 3 SF: 0

2B: 3 SAC: 1

3B: 0 DP: 1

HR: 0 HBP: 0

1B: 3 SF: 0

2B: 3 SAC: 1

3B: 0 DP: 1

HR: 0 HBP: 0

1B: 3 SF: 0

2B: 3 SAC: 1

3B: 0 DP: 1

HR: 0 HBP: 0

1B: 3 SF: 0

2B: 3 SAC: 1

3B: 0 DP: 1

HR: 0 HBP: 0

1B: 3 SF: 0

2B: 3 SAC: 1

3B: 0 DP: 1

HR: 0 HBP: 0

1B: 3 SF: 0

2B: 3 SAC: 1

3B: 0 DP: 1

HR: 0 HBP: 0

1B: 3 SF: 0

2B: 3 SAC: 1

3B: 0 DP: 1

HR: 0 HBP: 0

1B: 3 SF: 0

2B: 3 SAC: 1

3B: 0 DP: 1

HR: 0 HBP: 0

1B: 3 SF: 0

2B: 3 SAC: 1

3B: 0 DP: 1

HR: 0 HBP: 0

1B: 3 SF: 0

2B: 3 SAC: 1

3B: 0 DP: 1

HR: 0 HBP: 0

1B: 3 SF: 0

2B: 3 SAC: 1

3B: 0 DP: 1

HR: 0 HBP: 0

1B: 3 SF: 0

2B: 3 SAC: 1

3B: 0 DP: 1

HR: 0 HBP: 0

1B: 3 SF: 0

2B: 3 SAC: 1

3B: 0 DP: 1

HR: 0 HBP: 0

1B: 3 SF: 0

2B: 3 SAC: 1

3B: 0 DP: 1

HR: 0 HBP: 0

1B: 3 SF: 0

2B: 3 SAC: 1

3B: 0 DP: 1

HR: 0 HBP: 0

1B: 3 SF: 0

2B: 3 SAC: 1

3B: 0 DP: 1

HR: 0 HBP: 0

1B: 3 SF: 0

2B: 3 SAC: 1

3B: 0 DP: 1

HR: 0 HBP: 0

1B: 3 SF: 0

2B: 3 SAC: 1

3B: 0 DP: 1

HR: 0 HBP: 0

1B: 3 SF: 0

2B: 3 SAC: 1

3B: 0 DP: 1

HR: 0 HBP: 0

1B: 3 SF: 0

2B: 3 SAC: 1

3B: 0 DP: 1

HR: 0 HBP: 0

1B: 3 SF: 0

2B: 3 SAC: 1

3B: 0 DP: 1

HR: 0 HBP: 0

1B: 3 SF: 0

2B: 3 SAC: 1

3B: 0 DP: 1

HR: 0 HBP: 0

1B: 3 SF: 0

2B: 3 SAC: 1

3B: 0 DP: 1

HR: 0 HBP: 0

1B: 3 SF: 0

2B: 3 SAC: 1

3B: 0 DP: 1

HR: 0 HBP: 0

1B: 3 SF: 0

2B: 3 SAC: 1

3B: 0 DP: 1

HR: 0 HBP: 0

1B: 3 SF: 0

2B: 3 SAC: 1

3B: 0 DP: 1

HR: 0 HBP: 0

1B: 3 SF: 0

2B: 3 SAC: 1

3B: 0 DP: 1

HR: 0 HBP: 0

1B: 3 SF: 0

2B: 3 SAC: 1

3B: 0 DP: 1

HR: 0 HBP: 0

1B: 3 SF: 0

2B: 3 SAC: 1

3B: 0 DP: 1

HR: 0 HBP: 0

1B: 3 SF: 0

2B: 3 SAC: 1

3B: 0 DP: 1

HR: 0 HBP: 0

1B: 3 SF: 0

2B: 3 SAC: 1

3B: 0 DP: 1

HR: 0 HBP: 0

1B: 3 SF: 0

2B: 3 SAC: 1

3B: 0 DP: 1

HR: 0 HBP: 0

1B: 3 SF: 0

2B: 3 SAC: 1

3B: 0 DP: 1

HR: 0 HBP: 0

1B: 3 SF: 0

2B: 3 SAC: 1

3B: 0 DP: 1

HR: 0 HBP: 0

1B: 3 SF: 0

2B: 3 SAC: 1

3B: 0 DP: 1

HR: 0 HBP: 0

1B: 3 SF: 0

2B: 3 SAC: 1

3B: 0 DP: 1

HR: 0 HBP: 0

1B: 3 SF: 0

2B: 3 SAC: 1

3B: 0 DP: 1

HR: 0 HBP: 0

1B: 3 SF: 0

2B: 3 SAC: 1

3B: 0 DP: 1

HR: 0 HBP: 0

1B: 3 SF: 0

2B: 3 SAC: 1

3B: 0 DP: 1

HR: 0 HBP: 0

1B: 3 SF: 0

2B: 3 SAC: 1

3B: 0 DP: 1

HR: 0 HBP: 0

1B: 3 SF: 0

2B: 3 SAC: 1

3B: 0 DP: 1

HR: 0 HBP: 0

1B: 3 SF: 0

2B: 3 SAC: 1

3B: 0 DP: 1

HR: 0 HBP: 0

1B: 3 SF: 0

2B: 3 SAC: 1

3B: 0 DP: 1

HR: 0 HBP: 0

1B: 3 SF: 0

2B: 3 SAC: 1

3B: 0 DP: 1

HR: 0 HBP: 0

1B: 3 SF: 0

2B: 3 SAC: 1

3B: 0 DP: 1

HR: 0 HBP: 0

1B: 3 SF: 0

2B: 3 SAC: 1

3B: 0 DP: 1

HR: 0 HBP: 0

1B: 3 SF: 0

2B: 3 SAC: 1

3B: 0 DP: 1

HR: 0 HBP: 0

1B: 3 SF: 0

2B: 3 SAC: 1

3B: 0 DP: 1

HR: 0 HBP: 0

1B: 3 SF: 0

2B: 3 SAC: 1

3B: 0 DP: 1

HR: 0 HBP: 0

1B: 3 SF: 0

2B: 3 SAC: 1

3B: 0 DP: 1

HR: 0 HBP: 0

1B: 3 SF: 0

2B: 3 SAC: 1

3B: 0 DP: 1

HR: 0 HBP: 0

1B: 3 SF: 0

2B: 3 SAC: 1

3B: 0 DP: 1

HR: 0 HBP: 0

1B: 3 SF: 0

2B: 3 SAC: 1

3B: 0 DP: 1

HR: 0 HBP: 0

1B: 3 SF: 0

2B: 3 SAC: 1

3B: 0 DP: 1

HR: 0 HBP: 0

1B: 3 SF: 0

2B: 3 SAC: 1

3B: 0 DP: 1

HR: 0 HBP: 0

1B: 3 SF: 0

2B: 3 SAC: 1

3B: 0 DP: 1

HR: 0 HBP: 0

1B: 3 SF: 0

2B: 3 SAC: 1

3B: 0 DP: 1

HR: 0 HBP: 0

1B: 3 SF: 0

2B: 3 SAC: 1

3B: 0 DP: 1

HR: 0 HBP: 0

1B: 3 SF: 0

2B: 3 SAC: 1

3B: 0 DP: 1

HR: 0 HBP: 0

1B: 3 SF: 0

2B: 3 SAC: 1

3B: 0 DP: 1

HR: 0 HBP: 0

1B: 3 SF: 0

2B: 3 SAC: 1

3B: 0 DP: 1

HR: 0 HBP: 0

1B: 3 SF: 0

2B: 3 SAC: 1

3B: 0 DP: 1

HR: 0 HBP: 0

1B: 3 SF: 0

2B: 3 SAC: 1

3B: 0 DP: 1

HR: 0 HBP: 0

1B: 3 SF: 0

2B: 3 SAC: 1

Batter	1	2	3	4	5	6	7	8	9	AB	R	H	RBI	BB	SO	LOB	TOP																		
<a href="#">Davey Williams, R</a> (1, 4) OBP: 0.228, SLG: 0.178																	0	0	0	0	0	0	0	0	<b>New York Giants @ Pittsburgh Pirates</b> Forbes Field, Pittsburgh, PA Sun May 09 1954, 3:33 AM EDT Att. 4,577 - Unknown										
<a href="#">Alvin Dark, R</a> (1, 6) OBP: 0.272, SLG: 0.341																	0	0	0	0	0	0	0												
<a href="#">Hank Thompson, L</a> (1, 5) OBP: 0.443, SLG: 0.522																	0	0	0	0	0	0	0												
<a href="#">Monte Irvin, R</a> (1, 7) OBP: 0.329, SLG: 0.500																	0	0	0	0	0	0	0												
<a href="#">Willie Mays, R</a> (1, 8) OBP: 0.300, SLG: 0.500																	0	0	0	0	0	0	0												
<a href="#">Don Mueller, L</a> (1, 9) OBP: 0.388, SLG: 0.513																	0	0	0	0	0	0	0												
<a href="#">Whitey Lockman, L</a> (1, 3) OBP: 0.258, SLG: 0.316																	0	0	0	0	0	0	0	<b>AB 0</b> <b>R 0</b> <b>H 0</b> <b>RBI 0</b> <b>BB 0</b> <b>SO 0</b> <b>LOB 0</b>											
<a href="#">Ebba St. Claire, S</a> (1, 2) OBP: 0.419, SLG: 0.348																	0	0	0	0	0	0	0												
<a href="#">Sal Maglie, R</a> (1, 1) OBP: 0.067, SLG: 0.067	0	0	0	0	0	0	0																												
<b>Inning Stats</b>	1B: 0	SF: 0	WP: 0	PA: 0	2B: 0	SAC: 0	PB: 0			3B: 0	DP: 0	SB: 0		HR: 0	HBP: 0	CS: 0																			
<b>PITCHER</b> <a href="#">Max Surkont, R</a> (1, 1) ERA: 6.95	IP	WLS	BF	H	R	ER	SO	BB	IBB	HBP	BLK	WP	HR	S	P	ERA	WHIP	<b>PITCHER</b>	IP	WLS	BF	H	R	ER	SO	BB	IBB	HBP	BLK	WP	HR	S	P	ERA	WHIP



Batter	1	2	3	4	5	6	7	8	9	AB R H RBI BB SO LOB	TOP																
<b>Bobby Adams, R</b> (1, 5) OBP: 0.429, SLG: 0.420	4-0 SH3 HR BB	0-0 1-4-3		4-0 FC6-4 IBB		0-0 2-H 2B		0-0 3B		3 1 2 1 2 0 2																	
<b>Roy McMillan, R</b> (1, 6) OBP: 0.309, SLG: 0.264	0-0 SH3		0-3 K	0-0 FC6-4		0-0 4-3		0-0 6-3		3 0 0 0 0 1 4																	
<b>Chuck Harmon, R</b> (8, PH) OBP: 0.308, SLG: 0.382	1-2			1-2f						1 0 0 0 0 0 1																	
<b>Rocky Bridges, R</b> (8, 6) OBP: 0.667, SLG: 1.000										0 0 0 0 0 0 0																	
<b>Gus Bell, L</b> (1, 8) OBP: 0.345, SLG: 0.491	0-3 K		0-3 K		0-0 L6		0-0 FC1-6 2B 1B	0-3 K		5 1 1 0 0 3 2																	
<b>Ted Kluszewski, L</b> (1, 3) OBP: 0.426, SLG: 0.714	0-0		4-0		0-0 6-3		4-0 1-2 FC1-6 BB	0-0	0-0	3 1 2 2 2 0 0																	
<b>Nino Escalera, L</b> (9, PR) OBP: 0.316, SLG: 0.250	2-H HR		FC6-4 BB						1B	0 0 0 0 0 0 0																	
<b>Jim Greengrass, R</b> (1, 7) OBP: 0.299, SLG: 0.485	0-3 K		0-0 FC6-4		0-0 E6		0-0 FC1-6 2B CS	0-0 L8		5 0 0 0 0 1 4																	
<b>Johnny Temple, R</b> (1, 4) OBP: 0.421, SLG: 0.387		0-0 5-3		0-0 SH3-4 2-3 1B		0-0 F8	0-0 L8	0-0 F8		5 0 1 0 0 0 4																	
<b>Wally Post, R</b> (1, 9) OBP: 0.288, SLG: 0.500		0-0	0-0	0-0 2-3		0-0 SH1-4 2B 1B	0-0 1-3 3-H 2B	0-3 K		5 1 3 1 0 1 2																	
<b>Ed Bailey, L</b> (1, 2) OBP: 0.378, SLG: 0.382		0-3 K		4-0 SH3-4 BB		0-0 F3	0-0 3-H 4-0 IBB			2 0 0 0 2 1 2																	
<b>Fred Baczewski, L</b> (1, 1) OBP: 0.222, SLG: 0.125		4-0		0-0 SH3-4		0-0 SH1-4	0-0 CS	0-0 4-3		1 0 0 0 1 0 0																	
<b>Frank Smith, R</b> (8, 1) OBP: 0.222, SLG: 0.125	1-2 BB		1-2 2-3				3-H			0 0 0 0 0 0 0																	
<b>Inning Stats</b>	R: 2 E: 0 K: 2 S: 8	H: 1 LOB: 0 BB: 1 P: 12	R: 0 E: 0 K: 1 S: 6	H: 1 LOB: 2 BB: 1 P: 10	R: 0 E: 0 K: 2 S: 7	H: 0 LOB: 1 BB: 1 P: 11	R: 0 E: 0 K: 0 S: 4	H: 1 LOB: 3 BB: 2 P: 12	R: 0 E: 1 K: 0 S: 4	H: 0 LOB: 1 BB: 0 P: 4	R: 1 E: 0 K: 0 S: 5	H: 2 LOB: 1 BB: 0 P: 5	R: 1 E: 0 K: 0 S: 4	H: 2 LOB: 2 BB: 2 P: 12	R: 0 E: 0 K: 1 S: 6	H: 1 LOB: 1 BB: 0 P: 6	R: 0 E: 0 K: 1 S: 6	H: 1 LOB: 1 BB: 0 P: 6	R: 0 E: 0 K: 1 S: 6	H: 1 LOB: 1 BB: 0 P: 6	1B: 5 2B: 2 3B: 1 HR: 1	SF: 0 SAC: 3 DP: 0 HBP: 0	WP: 0 PB: 0 SB: 0 CS: 1	PA: 44			
<b>PITCHER</b>	IP WLS BF H R ER SO BB IBB HBP BLK WP HR S P ERA WHIP																										
<b>Ruben Gomez, R</b> (1, 1) ERA: 7.94	6.2		34	7	4	4	5	5	1	0	0	0	1	38	62	5.40	1.800										
<b>Windy McCall, L</b> (7, 1) ERA: 2.35	0.1		1	0	0	0	0	0	1	0	0	0	0	4	0.00	0.000											
<b>Mary Grissom, R</b> (8, 1) ERA: 1.21	2.0	W	8	2	0	0	2	0	0	0	0	0	0	12	12	0.00	1.000										

**Cincinnati Redlegs @ New York Giants**  
Polo Grounds, New York, NY  
Tue May 11 1954, 3:33 AM EDT  
Att. 3,203 - Unknown

[livebaseballscorecards.com](http://livebaseballscorecards.com)

<b>AB</b>	<b>33</b>
<b>R</b>	<b>4</b>
<b>H</b>	<b>9</b>
<b>RBI</b>	<b>4</b>
<b>BB</b>	<b>7</b>
<b>SO</b>	<b>7</b>
<b>LOB</b>	<b>21</b>



Batter	1	2	3	4	5	6	7	8	9
Davey Williams, R OBP: 0.216, SLG: 0.171 (1, 4)	0-0 6-3		0-0 F9		0-0 F2		0-0 5-3		
Alvin Dark, R OBP: 0.307, SLG: 0.375 (1, 6)	0-0 1B			0-0 1-3		0-0 F5		0-0 SH3-4 3B 1B	
Hank Thompson, L OBP: 0.427, SLG: 0.493 (1, 5)	0-0 P3			0-0 E4 BB		0-0 G1		0-0 SH3-4 1-2	
Monte Irvin, R OBP: 0.333, SLG: 0.506 (1, 7)	0-0 F9			4-0 BB G5-4-3 1-2		0-0 P4		0-0 CS 3B 2-H	
Willie Mays, R OBP: 0.303, SLG: 0.533 (1, 8)		0-0 F7		0-0 G5-4-3 1-2f			0-0 HR	0-0 6-3 3-H	
Don Mueller, L OBP: 0.398, SLG: 0.524 (1, 9)		0-0 4-3			0-0 HR 1B		0-0 1B G4-3 1B		
Whitey Lockman, L OBP: 0.292, SLG: 0.361 (1, 3)		0-0 F9			0-0 HR 1B		0-0 G4-3 1B 1-2		
Ray Katt, R OBP: 0.400, SLG: 0.313 Ron Samford, R (7, PR) Wes Westrum, R OBP: 0.324, SLG: 0.231 (8, 2)			0-0 F9		0-0 1-3		0-0 G4-3 1B 1-2 2-3		
Ruben Gomez, R OBP: 0.333, SLG: 0.333 Windy McCall, L (7, 1) Bobby Hofman, R OBP: 0.063, SLG: 0.250 Marv Grissom, R (8, 1)			0-0 5-3		0-0 CS 1B		0-0 G4-3 1-2f 2-3 3-H		

Inning Stats	R: 0	H: 1	E: 0	LOB: 1	K: 0	BB: 0	S: 4	P: 4	R: 0	H: 0	E: 0	LOB: 0	K: 0	BB: 0	S: 3	P: 3	R: 0	H: 0	E: 1	LOB: 1	K: 0	BB: 1	S: 3	P: 7	R: 2	H: 3	E: 0	LOB: 0	K: 0	BB: 0	S: 5	P: 5	R: 0	H: 0	E: 0	LOB: 0	K: 0	BB: 0	S: 3	P: 3	R: 2	H: 4	E: 0	LOB: 2	K: 0	BB: 0	S: 6	P: 6	R: 1	H: 2	E: 0	LOB: 0	K: 0	BB: 0	S: 4	P: 4
--------------	------	------	------	--------	------	-------	------	------	------	------	------	--------	------	-------	------	------	------	------	------	--------	------	-------	------	------	------	------	------	--------	------	-------	------	------	------	------	------	--------	------	-------	------	------	------	------	------	--------	------	-------	------	------	------	------	------	--------	------	-------	------	------

PITCHER	IP	WLS	BF	H	R	ER	SO	BB	IBB	HBP	BLK	WP	HR	S	P	ERA	WHIP
Fred Baczewski, L ERA: 6.26 (1, 1)	7.1	L	31	10	5	5	0	1	0	0	0	0	2	30	34	6.14	1.500
Frank Smith, R ERA: 0.87 (8, 1)	0.2		1	0	0	0	0	0	0	0	0	0	0	1	1	0.00	0.000

PITCHER	IP	WLS	BF	H	R	ER	SO	BB	IBB	HBP	BLK	WP	HR	S	P	ERA	WHIP
---------	----	-----	----	---	---	----	----	----	-----	-----	-----	----	----	---	---	-----	------

**BOTTOM**

AB	R	H	RBI	BB	SO	LOB
4	0	0	0	0	0	3
4	1	2	0	0	0	0
3	0	0	0	0	0	1
3	0	1	1	1	0	1
4	1	1	1	0	0	3
3	2	2	0	0	0	0
3	1	2	2	0	0	0
3	0	1	0	0	0	0
0	0	0	0	0	0	0
0	0	0	0	0	0	0
2	0	1	0	0	0	0
0	0	0	0	0	0	0
1	0	0	0	0	0	2
0	0	0	0	0	0	0

<b>AB</b>	<b>30</b>
<b>R</b>	<b>5</b>
<b>H</b>	<b>10</b>
<b>RBI</b>	<b>4</b>
<b>BB</b>	<b>1</b>
<b>SO</b>	<b>0</b>
<b>LOB</b>	<b>10</b>



WP	PA
0	32

**Cincinnati Redlegs @ New York Giants**  
**Polo Grounds, New York, NY**  
 Tue May 11 1954, 3:33 AM EDT  
 Att. 3,203 - Unknown

[livebaseballscorecards.com](http://livebaseballscorecards.com)

Batter	1	2	3	4	5	6	7	8	9	AB R H RBI BB SO LOB	TOP	
<b>Bobby Adams, R</b> OBP: 0.412, SLG: 0.400 (1, 5) X	0-0 F9 ①		0-0 F4 ①		0-0 FC6-4 ②		0-0 5-3 ③			4 0 0 0 0 0 2		
<b>Roy McMillan, R</b> OBP: 0.307, SLG: 0.264 (1, 6) X	0-0 F8 ②		0-0 F8 ②		0-0 1-2 1B			0-0 L5 ①		4 0 1 0 0 0 0		
<b>Gus Bell, L</b> OBP: 0.350, SLG: 0.481 (1, 8) B B B	4-0 1B 1B BB		4-0 BB BB		0-0 4-3 ③			0-0 E5 FC4-8		2 1 0 0 2 0 2		
<b>Ted Kluszewski, L</b> OBP: 0.419, SLG: 0.693 (1, 3) X	0-0 1B 1-3 1B		0-0 F8 ③			0-0 6-3 ①		0-0 FC4-6 ②		4 0 1 0 0 0 2		
<b>Jim Greengrass, R</b> OBP: 0.297, SLG: 0.476 (1, 7) X	0-0 FC6-4 1-2 3-H 1B			0-0 5-3 ①		0-0 F9 ②		0-0 L5 ③		4 0 1 1 0 0 1		
<b>Johnny Temple, R</b> OBP: 0.414, SLG: 0.381 (1, 4) X	0-0 FC6-4 1-2f			0-0 5-3 ②		0-0 F4 ③			0-0 E8 1B	4 0 1 0 0 0 2		
<b>Wally Post, R</b> OBP: 0.286, SLG: 0.488 (1, 9)		0-3 K ①		0-0 1-3 ③			0-0 6-3 ①		0-0 G6-4-3 1B 2-H	4 0 1 0 0 1 0		
<b>Andy Seminick, R</b> OBP: 0.441, SLG: 0.385 (1, 2)		0-0 F8 ②			0-0 FC1-8 1B		4-0 BB BB		0-0 G6-4-3 ② ③ 1-2f	3 0 1 0 1 0 1		
<b>Harry Perkowski, L</b> (1, 1)		0-0 F7 ③			0-0 FC1-6 1-2f FC6-4		0-3 K ②			3 0 0 0 0 1 2		
<b>Inning Stats</b>	R: 1 H: 2 E: 0 LOB: 2 K: 0 BB: 1 S: 5 P: 9	R: 0 H: 0 E: 0 LOB: 0 K: 1 BB: 0 S: 5 P: 5	R: 0 H: 0 E: 0 LOB: 1 K: 0 BB: 1 S: 3 P: 7	R: 0 H: 0 E: 0 LOB: 0 K: 0 BB: 0 S: 3 P: 3	R: 0 H: 2 E: 0 LOB: 2 K: 0 BB: 0 S: 5 P: 5	R: 0 H: 0 E: 0 LOB: 0 K: 0 BB: 0 S: 3 P: 3	R: 0 H: 0 E: 0 LOB: 1 K: 1 BB: 1 S: 5 P: 9	R: 0 H: 0 E: 1 LOB: 1 K: 0 BB: 0 S: 4 P: 4	R: 0 H: 2 E: 1 LOB: 0 K: 0 BB: 0 S: 3 P: 3	1B: 6 SF: 0 2B: 0 SAC: 0 3B: 0 DP: 1 HR: 0 HBP: 0	WP: 0 PA: 35 PB: 0 SB: 0 CS: 0	
<b>PITCHER</b> <b>Johnny Antonelli, L</b> ERA: 1.96 (1, 1)	IP WLS BF H R ER SO BB IBB HBP BLK WP HR S P ERA WHIP	9.0 W 35 6 1 1 2 3 0 0 0 0 0 36 48 1.00 1.000										

**Cincinnati Redlegs @ New York Giants**  
 Polo Grounds, New York, NY  
 Wed May 12 1954, 3:33 AM EDT  
 Att. 3,170 - Unknown

[livebaseballscorecards.com](http://livebaseballscorecards.com)

**AB** 32  
**R** 1  
**H** 6  
**RBI** 1  
**BB** 3  
**SO** 2  
**LOB** 12







Batter	1	2	3	4	5	6	7	8	9	AB R H RBI BB SO LOB	TOP														
Frank Baumholtz, L (1, 8) OBP: 0.300, SLG: 0.410	0-0 G1-4-3 1B	0-0 G4-6-3			0-0 F7		0-0 G3		4-0 BB	4 1 1 0 1 0 4	<p><b>Chicago Cubs @ New York Giants</b> Polo Grounds, New York, NY</p> <p>Thu May 13 1954, 3:33 AM EDT Att. 3,121 - Unknown</p> <p>livebaseballscorecards.com</p> <table border="0"> <tr><td>AB</td><td>35</td></tr> <tr><td>R</td><td>3</td></tr> <tr><td>H</td><td>9</td></tr> <tr><td>RBI</td><td>2</td></tr> <tr><td>BB</td><td>3</td></tr> <tr><td>SO</td><td>5</td></tr> <tr><td>LOB</td><td>24</td></tr> </table> 	AB	35	R	3	H	9	RBI	2	BB	3	SO	5	LOB	24
AB	35																								
R	3																								
H	9																								
RBI	2																								
BB	3																								
SO	5																								
LOB	24																								
Dee Fondy, L (1, 3) OBP: 0.317, SLG: 0.418	0-0 G1-4-3 1B		0-0 P6		0-0 3-1		0-0 4-3		0-3 K	5 0 1 0 0 1 3															
Ralph Kiner, R (1, 7) OBP: 0.438, SLG: 0.544	0-0 G1-4-3 1-2f 2-3		0-0 6-3			4-0 1B E BB	0-0 L8			3 1 0 0 1 0 3															
Hank Sauer, R (1, 9) OBP: 0.453, SLG: 0.780	0-0 1B 1B		0-0 F7			0-0 14 FC6-4 1-2 FC6-4 1B		0-0 FC5-4 1B		4 1 3 1 0 0 0															
Randy Jackson, R (1, 5) OBP: 0.366, SLG: 0.584	0-0 1-2 1B			0-0 F5		0-0 E5 14 FC6-4		0-0 F7		4 0 1 0 0 0 2															
14 Ernie Banks, R (1, 6) OBP: 0.315, SLG: 0.419	0-3 K			0-0 G4-6-3 1B		0-0 FC6-4 1-2f 2-3		0-3 K		4 0 1 0 0 2 5															
Gene Baker, R (1, 4) OBP: 0.374, SLG: 0.506		0-0 2B		0-0 G4-6-3 1-2f		0-0 FC6-4 1-2f 3-H		0-0 FC5-4 1-2f		4 0 1 1 0 0 3															
Ei Tappe, R (1, 2) OBP: 0.262, SLG: 0.250		0-0 F7			0-0 4-3 1B		0-0 F8		0-3 K	3 0 1 0 0 0 2															
Eddie Miksis, R (9, PH)									1 0 0 0 0 1 0																
Bubba Church, R (1, 1)		0-0 E6 G4-6-3				0-0 4-3 1-2		4-0 G3 BB		0-3 K	1 0 0 0 0 0 1														
Turk Lown, R (2, 1)									0 0 0 0 0 0 0																
Joe Garagiola, L (5, PH) OBP: 0.478, SLG: 0.421									1 0 0 0 0 0 1																
Jim Davis, S (5, 1)									0 0 0 0 0 0 0																
Bill Serena, R (7, PH) OBP: 0.333, SLG: 0.200									0 0 0 0 1 0 0																
Hal Jeffcoat, R (7, 1) OBP: 0.571, SLG: 1.167									0 0 0 0 0 0 0																
Steve Bilko, R (9, PH) OBP: 0.286, SLG: 0.167									1 0 0 0 0 1 0																
<b>Inning Stats</b>	R: 1 E: 0 K: 1 S: 8	H: 4 LOB: 2 BB: 0 P: 8	R: 0 E: 1 K: 0 S: 4	H: 1 LOB: 1 BB: 0 P: 4	R: 0 E: 0 K: 0 S: 3	H: 0 LOB: 0 BB: 0 P: 3	R: 0 E: 0 K: 0 S: 3	H: 1 LOB: 0 BB: 0 P: 3	R: 0 E: 0 K: 0 S: 4	H: 1 LOB: 1 BB: 0 P: 4	R: 2 E: 1 K: 0 S: 5	H: 1 LOB: 1 BB: 1 P: 9	R: 0 E: 0 K: 0 S: 3	H: 0 LOB: 1 BB: 1 P: 7	R: 0 E: 0 K: 1 S: 6	H: 1 LOB: 1 BB: 0 P: 6	R: 0 E: 0 K: 3 S: 9	H: 0 LOB: 1 BB: 1 P: 13	1B: 8 2B: 1 3B: 0 HR: 0	SF: 0 SAC: 0 DP: 3 HBP: 0	WP: 0 PB: 0 SB: 0 CS: 0	PA: 38			
<b>PITCHER</b>	IP WLS BF H R ER SO BB IBB HBP BLK WP HR S P ERA WHIP																								
Larry Jansen, R (1, 1) ERA: 4.97	6.0 W 27 8 3 2 1 2 0 0 0 0 0 0 27 35 3.00 1.667																								
Mary Grissom, R (7, 1) ERA: 1.07	3.0 S 11 1 0 0 4 1 0 0 0 0 0 0 18 22 0.00 0.667																								

Batter	1	2	3	4	5	6	7	8	9
Davey Williams, R (1, 4) OBP: 0.211, SLG: 0.169	0-0 4-3	0-3 K		0-0 1-3		0-0 F7			
Alvin Dark, R (1, 6) OBP: 0.296, SLG: 0.359	0-3 K	0-0 1-2 1B		0-0 5-3			0-0 6-3		
Hank Thompson, L (1, 5) OBP: 0.408, SLG: 0.500	0-0 HR	0-0 L7			0-0 4-3		0-0 6-3		
Monte Irvin, R (1, 7) OBP: 0.350, SLG: 0.575	0-0 HR	0-0 L7			4-0 BB		0-0 HR		
Don Mueller, L (1, 9) OBP: 0.388, SLG: 0.484	0-0 5-3		0-0 1-3		0-0 F9		0-0 1-3		
Willie Mays, R (1, 8) OBP: 0.311, SLG: 0.551		0-0 HR	0-3 K		0-0 5-3		0-0 FC4 1B		
Whitey Lockman, L (1, 3) OBP: 0.301, SLG: 0.352		4-0 HR BB	0-0 1B			0-0 3-1	0-0 FC4 2-5 BB 1-2f		
Ebba St. Claire, S (1, 2) OBP: 0.410, SLG: 0.433		0-0 HR 1-H	0-0 G3			0-0 FC2-6 1B	4-0 1-2 BB		
Larry Jansen, R (1, 1) Marv Grissom, R (7, 1) OBP: 0.333, SLG: 0.333		0-0 WP 1B		0-0 6-3		0-0 FC2-6 1-2f	0-0 2-5 2-3f		

Inning Stats	R: 2	H: 2	E: 0	K: 1	S: 7	LOB: 0	BB: 0	P: 7	R: 3	H: 4	E: 0	K: 1	S: 9	LOB: 2	BB: 1	P: 13	R: 0	H: 1	E: 0	K: 1	S: 6	LOB: 1	BB: 0	P: 6	R: 0	H: 0	E: 0	K: 0	S: 3	LOB: 0	BB: 0	P: 3	R: 0	H: 1	E: 0	K: 0	S: 4	LOB: 1	BB: 0	P: 4	R: 1	H: 1	E: 0	K: 0	S: 4	LOB: 0	BB: 0	P: 4	R: 0	H: 1	E: 0	K: 0	S: 3	LOB: 1	BB: 1	P: 7
--------------	------	------	------	------	------	--------	-------	------	------	------	------	------	------	--------	-------	-------	------	------	------	------	------	--------	-------	------	------	------	------	------	------	--------	-------	------	------	------	------	------	------	--------	-------	------	------	------	------	------	------	--------	-------	------	------	------	------	------	------	--------	-------	------

PITCHER	IP	WLS	BF	H	R	ER	SO	BB	IBB	HBP	BLK	WP	HR	S	P	ERA	WHIP
Bubba Church, R (1, 1) ERA: 10.97	1.0	L	9	5	5	5	1	1	0	0	0	0	0	4	14	45.00	6.000
Turk Lown, R (2, 1) ERA: 7.04	3.0		11	2	0	0	2	0	0	0	0	1	0	15	15	0.00	0.667
Jim Davis, L (5, 1) ERA: 8.53	2.0		8	1	0	0	0	1	0	0	0	0	0	7	11	0.00	1.000
Hal Jeffcoat, R (7, 1) ERA: 8.05	2.0		8	2	1	1	0	1	0	0	0	0	1	7	11	4.50	1.500

AB R H RBI BB SO LOB

4	0	0	0	0	1	2
4	0	1	0	0	1	0
4	1	1	1	0	0	2
3	2	2	2	1	0	2
4	0	0	0	0	0	1
4	1	2	1	0	1	1
3	1	1	0	1	0	1
3	1	2	2	1	0	1
3	0	1	0	0	0	1
1	0	0	0	0	0	2

AB	33
R	6
H	10
RBI	6
BB	3
SO	3
LOB	13



Chicago Cubs @ New York Giants  
Polo Grounds, New York, NY  
Thu May 13 1954, 3:33 AM EDT  
Att. 3,121 - Unknown

livebaseballscores.com

WP	1	PA	36
PB	0	CS	0

Batter	1	2	3	4	5	6	7	8	9	AB R H RBI BB SO LOB	TOP																									
Frank Baumholtz, L (1, 8) OBP: 0.333, SLG: 0.405	0-0 F9		4-0 G6-4-3 1B BB	0-0 F8		0-0 1B		4-0 1-2 BB		3 0 1 0 2 0 2																										
Dee Fondy, L (1, 3) OBP: 0.312, SLG: 0.408	0-3 K		0-0 G6-4-3 1B	0-0 F9		0-3 K		0-0 F7		5 0 1 0 0 2 5																										
Ralph Kiner, R (1, 7) OBP: 0.436, SLG: 0.571	0-0 F7		0-0 G6-4-3 1-2f 2-3		0-0 G5-4-3 1B		0-0 HR	0-3 K		5 1 2 1 0 1 4																										
Hank Sauer, R (1, 9) OBP: 0.440, SLG: 0.744		0-0 L7	4-0 BB		0-0 G5-4-3 1-2f		0-0 6-3	0-3 K		4 0 0 0 1 1 1																										
Randy Jackson, R (1, 5) OBP: 0.357, SLG: 0.564		0-0 PB BB 1B	0-0 F8		0-0 F7		0-0 6-3	0-0 1-3		5 1 1 0 0 0 2																										
14 Ernie Banks, R (1, 6) OBP: 0.330, SLG: 0.422		0-0 F9		0-0 1B 5-3 1B		0-0 HR 1B	1-0 S HBP	0-3 K		4 2 2 0 0 1 1																										
Gene Baker, R (1, 4) OBP: 0.379, SLG: 0.537		4-0 PB 1B BB		0-0 5-3		0-0 HR 1B	0-0 1-3			3 2 1 2 1 0 2																										
El Tappe, R (1, 2) OBP: 0.283, SLG: 0.273		0-0 1-H 2-H 1B		0-0 1B 2-3 1B		0-3 K		0-0 6-3		4 0 2 2 0 1 0																										
Bob Rush, R (1, 1) OBP: 0.375, SLG: 0.375		0-0 F7		0-0 1B 3-H		0-0 6-3		1-0 BB HBP		2 0 1 1 0 0 1																										
Jim Willis, L (5, 1) Steve Bilko, R (6, PH) Turk Lown, R (6, 1) Bubba Church, R (7, 1) Joe Garagiola, L (8, PH) Don Robertson, L (8, PH) Jim Davis, S (8, 1)										0 0 0 0 0 0 0 1 0																										
<b>Inning Stats</b>	R: 0 E: 0 K: 1 S: 5	H: 0 LOB: 0 BB: 0 P: 5	R: 2 E: 0 K: 0 S: 5	H: 2 LOB: 1 BB: 1 P: 9	R: 0 E: 0 K: 0 S: 3	H: 1 LOB: 2 BB: 2 P: 11	R: 1 E: 0 K: 0 S: 6	H: 3 LOB: 2 BB: 0 P: 6	R: 0 E: 0 K: 0 S: 3	H: 1 LOB: 0 BB: 0 P: 3	R: 2 E: 0 K: 2 S: 10	H: 3 LOB: 1 BB: 0 P: 10	R: 1 E: 0 K: 0 S: 4	H: 1 LOB: 1 BB: 0 P: 5	R: 0 E: 0 K: 1 S: 5	H: 0 LOB: 2 BB: 1 P: 10	R: 0 E: 0 K: 2 S: 7	H: 0 LOB: 0 BB: 0 P: 7	1B: 9 2B: 0 3B: 0 HR: 2	SF: 0 SAC: 0 DP: 2 HBP: 2	WP: 0 PB: 1 SB: 1 CS: 0	PA: 42														
<b>PITCHER</b>	IP WLS BF H R ER SO BB IBB HBP BLK WP HR S P ERA WHIP																																			
Sal Maglie, R (1, 1) ERA: 2.78	5.0		23	7	3	2	1	3	0	0	0	0	0	22	34	3.60	2.000																			
Mary Grissom, R (6, 1) ERA: 1.98	2.0		11	4	3	3	2	0	0	1	0	0	2	14	15	13.50	2.000																			
Hoyt Wilhelm, R (8, 1) ERA: 3.38	2.0	W	8	0	0	0	3	1	0	1	0	0	0	12	17	0.00	0.500																			

Chicago Cubs @ New York Giants  
Polo Grounds, New York, NY  
Fri May 14 1954, 3:33 AM EDT  
Att: 11,158 - Unknown

livebaseballscorecards.com

AB	36
R	6
H	11
RBI	6
BB	4
SO	6
LOB	18





Batter	1	2	3	4	5	6	7	8	9	AB R H RBI BB SO LOB	TOP											
Frank Baumholtz, L OBP: 0.340, SLG: 0.391 (1, 8) (9, 9)	0-0 S 1B	0-0 4-3			0-0 F7	4-0 BB		0-0 F3		4 0 1 0 1 0 1												
Dee Fondy, L OBP: 0.307, SLG: 0.398 (1, 3)	0-0 F4		0-0 4-3		0-0 S 1B	0-0 F6		0-0 F8		5 0 1 0 0 0 3												
Gene Baker, R OBP: 0.360, SLG: 0.506 (1, 4)	0-3 K		0-0 5-3		0-0 F9	0-0 F7			0-0 F3	5 0 0 0 0 1 4												
Hank Sauer, R OBP: 0.429, SLG: 0.711 Luis Marquez, R (1, 9) (9, 8)	0-0 F3		0-0 L7		4-0 IBB		0-0 F9		0-0 F7	4 0 0 0 1 0 1 0 0 0 0 0 0 0												
Randy Jackson, R OBP: 0.359, SLG: 0.566 (1, 5)		0-0 14 1B 1B		0-0 14 1B 2B	0-0 F8		0-0 F8		0-3 K	5 1 2 0 0 1 2												
Ralph Kiner, R OBP: 0.438, SLG: 0.563 (1, 7)		0-3 K		0-0 5-3		0-0 1B E 1B	4-0 14 1B BB			3 1 1 0 1 1 2												
14 Ernie Banks, R OBP: 0.347, SLG: 0.436 (1, 6)		0-0 1B SF9 1B		0-0 2-3 1B		0-0 F3	0-0 1-2 1B			4 1 3 0 0 0 1												
Joe Garagiola, L OBP: 0.500, SLG: 0.435 (1, 2)		0-0 1-3 2-H 1B		0-0 F9		0-0 E8 1B 1B	0-0 4-3			4 1 2 1 0 0 4												
Johnny Klippstein, R OBP: 0.167, SLG: 0.182 (1, 1)		0-0 SF9		0-0 F3		0-0 BB 1B	0-0 6-3			3 0 1 2 0 0 2												
<b>Inning Stats</b>	R: 0 E: 0 K: 1 S: 6	H: 1 LOB: 1 BB: 0 P: 6	R: 2 E: 0 K: 1 S: 8	H: 3 LOB: 1 BB: 0 P: 8	R: 0 E: 0 K: 0 S: 3	H: 0 LOB: 0 BB: 0 P: 3	R: 0 E: 0 K: 0 S: 5	H: 2 LOB: 2 BB: 0 P: 5	R: 0 E: 0 K: 0 S: 4	H: 1 LOB: 2 BB: 1 P: 8	R: 2 E: 1 K: 0 S: 6	H: 3 LOB: 2 BB: 1 P: 10	R: 0 E: 0 K: 0 S: 4	H: 1 LOB: 2 BB: 1 P: 8	R: 0 E: 0 K: 1 S: 5	H: 0 LOB: 0 BB: 0 P: 3	R: 0 E: 0 K: 1 S: 5	H: 0 LOB: 0 BB: 0 P: 5	1B: 10 2B: 1 3B: 0 HR: 0	SF: 1 SAC: 0 DP: 0 HBP: 0	WP: 0 PB: 0 SB: 2 CS: 0	PA: 41
<b>PITCHER</b>	IP WLS BF H R ER SO BB IBB HBP BLK WP HR S P ERA WHIP																					
Jim Hearn, R ERA: 7.24 (1, 1)	5.1 L 27 10 4 3 2 0 0 0 0 0 0 0 30 34 5.06 1.875																					
Hoyt Wilhelm, R ERA: 2.89 (6, 1)	2.2 11 1 0 0 0 2 0 0 0 0 0 0 9 17 0.00 1.125																					
Larry Jansen, R ERA: 4.78 (9, 1)	1.0 3 0 0 0 0 1 0 0 0 0 0 0 5 5 0.00 0.000																					

Chicago Cubs @ New York Giants  
Polo Grounds, New York, NY  
Sat May 15 1954, 3:33 AM EDT  
Att. 6,059 - Unknown

livebaseballscorecards.com

AB	37
R	4
H	11
RBI	3
BB	3
SO	3
LOB	20









BOTTOM

Milwaukee Braves @ New York Giants  
Polo Grounds, New York, NY  
Sun May 16 1954, 3:33 AM EDT  
Unknown

livebaseballscorecards.com

AB 38  
R 2  
H 9  
RBI 2  
BB 2  
SO 5  
LOB 14



WP: 0 PA: 41  
PB: 0  
SB: 0  
CS: 0

AB R H RBI BB SO LOB

5 0 0 0 0 1 4  
4 0 0 0 0 1 2  
0 0 0 0 0 0 0

4 0 1 0 1 1 1

5 0 1 0 0 1 2

5 0 1 0 0 0 2

4 1 1 0 0 1 1

4 1 2 1 0 0 1

2 0 0 0 0 0 1

0 0 0 0 1 0 0

1 0 1 0 0 0 0

0 0 0 0 0 0 0

0 0 0 0 0 0 0

2 0 0 0 0 0 0

1 0 1 1 0 0 0

0 0 0 0 0 0 0

1 0 1 0 0 0 0

1B: 8 SF: 0  
2B: 0 SAC: 0  
3B: 0 DP: 1  
HR: 1 HBP: 1

Batter	1	2	3	4	5	6	7	8	9	10
Davey Williams, R (1, 4) OBP: 0.193, SLG: 0.155	0-0 1-3		0-3 K			0-0 6-3	0-0 FC6-4		0-0 P7	
Alvin Dark, R (1, 6) OBP: 0.311, SLG: 0.388	0-0 1-3		0-0 6-3			1-0 HBP		0-0 1-3	0-3 K	
Billy Gardner, R (10, 6) OBP: 0.750, SLG: 0.667	0-0 1-3		0-0 6-3			0-0 HBP		0-0 1-3	0-3 K	
Hank Thompson, L (1, 5) OBP: 0.402, SLG: 0.457	4-0 FC6-4 BB			0-0 F5		0-0 F8		0-0 1B 1B	0-3 K	
Monte Irvin, R (1, 7) OBP: 0.333, SLG: 0.540	0-0 FC6-4			0-3 K		0-0 F7		0-0 1-2 1B	0-0 F4	
Don Mueller, L (1, 9) OBP: 0.370, SLG: 0.471		0-0 F7		0-0 1B		0-0 F7		0-0 G1-4-6-3	0-0 F7	
Willie Mays, R (1, 8) OBP: 0.314, SLG: 0.514		0-0 F9		0-3 K		0-0 BB 1B		0-0 5-3		
Whitey Lockman, L (1, 3) OBP: 0.322, SLG: 0.430		0-0 1B			0-0 1-3		0-0 F5		0-0 HR	
Wes Westrum, R (1, 2) OBP: 0.306, SLG: 0.214		0-0 4-3			0-0 F8		4-0 1B BB		0-0 1B 1B	
Dusty Rhodes, L (7, PH) OBP: 0.556, SLG: 0.429							0-0 BB BB		0-0 1B	
Ray Katt, R (8, 2) OBP: 0.375, SLG: 0.300							0-0 FC6-4		0-0 1B	
Ron Samford, R (9, PR)										
Marv Grissom, R (10, 1)										
Ruben Gomez, R (1, 1) OBP: 0.250, SLG: 0.250			0-0 F3		0-0 6-3		0-0 1-2 2-H 1B		0-0 1B	
Bill Taylor, L (7, PH) OBP: 0.364, SLG: 0.300										
Hoyt Wilhelm, R (8, 1)										
Ebba St. Claire, S (9, PH) OBP: 0.447, SLG: 0.444										

Inning Stats	R: 0	H: 0	E: 0	K: 0	S: 3	P: 7	R: 0	H: 1	E: 0	K: 0	S: 4	P: 4	R: 0	H: 0	E: 0	K: 1	S: 5	P: 5	R: 0	H: 1	E: 0	K: 2	S: 8	P: 8	R: 0	H: 0	E: 0	K: 0	S: 3	P: 3	R: 0	H: 0	E: 0	K: 0	S: 3	P: 4	R: 1	H: 2	E: 0	K: 0	S: 5	P: 9	R: 0	H: 2	E: 0	K: 0	S: 4	P: 4	R: 1	H: 3	E: 0	K: 1	S: 8	P: 8	R: 0	H: 0	E: 0	K: 1	S: 5	P: 5	1B: 8	SF: 0	2B: 0	3B: 0	HR: 1	SAC: 0	DP: 1	HBP: 1	WP: 0	PA: 41
--------------	------	------	------	------	------	------	------	------	------	------	------	------	------	------	------	------	------	------	------	------	------	------	------	------	------	------	------	------	------	------	------	------	------	------	------	------	------	------	------	------	------	------	------	------	------	------	------	------	------	------	------	------	------	------	------	------	------	------	------	------	-------	-------	-------	-------	-------	--------	-------	--------	-------	--------

PITCHER	IP	WLS	BF	H	R	ER	SO	BB	IBB	HBP	BLK	WP	HR	S	P	ERA	WHIP
Gene Conley, R (1, 1) ERA: 2.13	8.1		36	9	2	2	3	2	0	1	0	0	1	39	48	2.16	1.320
Dave Jolly, R (9, 1) ERA: 0.66	1.2	W	5	0	0	0	2	0	0	0	0	0	0	9	9	0.00	0.000

Batter	1	2	3	4	5	6	7	8	9	AB R H RBI BB SO LOB	TOP											
Bill Bruton, L (1, 8) OBP: 0.370, SLG: 0.333	0-0 G4-6-3 1B		0-0 S 1B			0-0 FC3-6 1B		0-0 6-3		4 0 3 0 0 0 0	<b>Milwaukee Braves @ New York Giants</b> Polo Grounds, New York, NY Sun May 16 1954, 3:38 AM EDT Att: 39,588 - Unknown											
Danny O'Connell, R (1, 4) OBP: 0.292, SLG: 0.313	0-0 G4-6-3 1-2f		0-0 F7 1-2			0-0 FC3-6 1-2f		0-3 K		4 0 0 0 0 1 3												
Eddie Mathews, L (1, 5) OBP: 0.440, SLG: 0.591	0-3 K				0-3 K	0-0 FC4-6-5 1-2f		0-0 F8		4 0 0 0 0 2 1												
Andy Pafko, R (1, 9) OBP: 0.340, SLG: 0.434		0-0 HR			0-3 K	0-0 F9		0-0 FC5-4 1B		4 1 2 1 0 1 1												
Joe Adcock, R (1, 3) OBP: 0.398, SLG: 0.574		0-0 F3		H 1-0 HBP			0-0 5-3	0-0 F9		3 0 0 0 0 0 1												
Johnny Logan, R (1, 6) OBP: 0.333, SLG: 0.423		0-0 L6-3 1B		0-0 F8			0-3 K	0-0 FC5-4 1-2f		4 0 1 0 0 1 2												
Jim Pendleton, R (1, 7) OBP: 0.250, SLG: 0.182		0-0 L6-3 1-2			0-3 K		0-0 3-1			3 0 0 0 0 1 1												
Del Crandall, R (1, 2) OBP: 0.261, SLG: 0.317			0-0 5-3		0-0 6-3			0-0 F8		3 0 0 0 0 0 0												
Lew Burdette, R (1, 1) Ernie Johnson, R (3, 1) Roy Smalley, R (8, PH) Phil Paine, R (8, 1)			0-0 4-3		0-0 4-3			0-0 HR		1 0 0 0 0 0 0 1 0 0 0 0 0 0 1 1 1 1 0 0 0 0 0 0 0 0 0 0												
<b>Inning Stats</b>	R: 0 E: 0 K: 1 S: 5	H: 1 LOB: 0 BB: 0 P: 5	R: 1 E: 0 K: 0 S: 4	H: 2 LOB: 0 BB: 0 P: 4	R: 0 E: 0 K: 0 S: 4	H: 1 LOB: 1 BB: 0 P: 4	R: 0 E: 0 K: 2 S: 7	H: 0 LOB: 1 BB: 0 P: 8	R: 0 E: 0 K: 1 S: 5	H: 0 LOB: 0 BB: 0 P: 5		R: 0 E: 0 K: 0 S: 4	H: 1 LOB: 1 BB: 0 P: 4	R: 0 E: 0 K: 1 S: 5	H: 0 LOB: 0 BB: 0 P: 5	R: 1 E: 0 K: 1 S: 6	H: 1 LOB: 0 BB: 0 P: 6	R: 0 E: 0 K: 0 S: 4	H: 1 LOB: 1 BB: 0 P: 4	1B: 5 2B: 1 3B: 0 HR: 2	SF: 0 SAC: 0 DP: 2 HBP: 1	WP: 0 PB: 0 SB: 1 CS: 0
<b>PITCHER</b> Johnny Antonelli, L (1, 1) ERA: 1.96	IP: 9.0 WLS: W BF: 33 H: 7 R: 2 ER: 2 SO: 6 BB: 0 IBB: 0 HBP: 1 BLK: 0 WP: 0 HR: 2 S: 44 P: 45 ERA: 2.00 WHIP: 0.778											<b>PITCHER</b>	IP: WLS: BF: H: R: ER: SO: BB: IBB: HBP: BLK: WP: HR: S: P: ERA: WHIP:									

AB	32
R	2
H	7
RBI	2
BB	0
SO	6
LOB	9



Batter	1	2	3	4	5	6	7	8	9
Davey Williams, R OBP: 0.202, SLG: 0.187 (1, 4)	0-3 K		0-0 HR	0-3 K		0-0 F3		1-0 BB 1B HBP	
Alvin Dark, R OBP: 0.307, SLG: 0.380 (1, 6)	0-0 BB 1B		0-0 5-3	0-0 L5		0-3 K		0-3 K	
Hank Thompson, L OBP: 0.418, SLG: 0.452 (1, 5)	4-0 G1-4-3 1-2 BB		4-0 1B SF7 BB	0-0 F9			4-0 1B FC1-4 BB	4-0 1B BB	
Monte Irvin, R OBP: 0.345, SLG: 0.543 (1, 7)	0-0 G1-4-3 1-2f		0-0 2B 1B		0-3 K		0-0 FC1-4 1B	0-0 1-2 2-H 1B	
Don Mueller, L OBP: 0.363, SLG: 0.463 (1, 9)		0-0 3-1	0-0 SF7		0-0 HR 1B		0-0 F2	0-0 G3	
Willie Mays, R OBP: 0.320, SLG: 0.550 (1, 8)		0-0 4-3	0-0 3-H 2B 2B		0-0 1-H HR		0-0 FC1-4 1B 1-2f 3-H		
Whitey Lockman, L OBP: 0.336, SLG: 0.447 (1, 3)		4-0 2B E BB	0-0 2-H 2B		0-0 3-1		0-0 1-2 1B		
Ebba St. Claire, S OBP: 0.451, SLG: 0.462 (1, 2)		0-0 E7 1-H 2B	4-0 IBB		0-0 F3		0-0 F9		
Johnny Antonelli, L OBP: 0.217, SLG: 0.182 (1, 1)	0-3 K		0-0 F7			0-0 6-3		0-0 L3	

Inning Stats	R: 0	H: 1	E: 0	K: 1	S: 5	LOB: 1	BB: 1	P: 9	R: 1	H: 1	E: 1	K: 1	S: 6	LOB: 1	BB: 1	P: 10	R: 4	H: 4	E: 0	K: 0	S: 7	LOB: 2	BB: 2	P: 15	R: 0	H: 0	E: 0	K: 1	S: 5	LOB: 0	BB: 0	P: 5	R: 2	H: 2	E: 0	K: 1	S: 7	LOB: 0	BB: 0	P: 7	R: 0	H: 0	E: 0	K: 1	S: 5	LOB: 0	BB: 0	P: 5	R: 1	H: 2	E: 0	K: 0	S: 5	LOB: 2	BB: 1	P: 9	R: 1	H: 1	E: 0	K: 1	S: 6	LOB: 2	BB: 1	P: 11
--------------	------	------	------	------	------	--------	-------	------	------	------	------	------	------	--------	-------	-------	------	------	------	------	------	--------	-------	-------	------	------	------	------	------	--------	-------	------	------	------	------	------	------	--------	-------	------	------	------	------	------	------	--------	-------	------	------	------	------	------	------	--------	-------	------	------	------	------	------	------	--------	-------	-------

PITCHER	IP	WLS	BF	H	R	ER	SO	BB	IBB	HBP	BLK	WP	HR	S	P	ERA	WHIP
Lew Burdette, R ERA: 2.72 (1, 1)	2.2	L	15	5	5	4	2	3	0	0	0	0	1	16	28	13.50	3.000
Ernie Johnson, R ERA: 2.41 (3, 1)	4.1		20	5	3	3	3	1	1	0	0	0	1	24	32	6.23	1.385
Phil Paine, R ERA: 5.4 (8, 1)	1.0		6	1	1	1	1	1	0	1	0	0	0	6	11	9.00	2.000

**BOTTOM**

**Milwaukee Braves @ New York Giants**  
 Polo Grounds, New York, NY  
 Sun May 16 1954, 3:38 AM EDT  
 Att. 39,588 - Unknown

AB	R	H	RBI	BB	SO	LOB
4	2	1	1	0	2	0
5	0	1	0	0	2	1
1	2	0	0	4	0	0
5	1	3	1	0	1	2
4	1	1	1	0	0	4
4	2	2	4	0	0	1
3	1	2	1	1	0	0
3	0	1	0	1	0	2
4	0	0	0	0	1	3

AB	33
R	9
H	11
RBI	8
BB	6
SO	6
LOB	13

WP: 0 PA: 41  
 PB: 0  
 SB: 0  
 CS: 0



PITCHER	IP	WLS	BF	H	R	ER	SO	BB	IBB	HBP	BLK	WP	HR	S	P	ERA	WHIP
---------	----	-----	----	---	---	----	----	----	-----	-----	-----	----	----	---	---	-----	------



Batter	1	2	3	4	5	6	7	8	9	AB	R	H	RBI	BB	SO	LOB
Davey Williams, R (1, 4) OBP: 0.203, SLG: 0.207	0-0 5-3 ①		0-0 SF7 3B 1-H		0-0 4-3 ①		0-0 6-3 ③			4	1	1	1	0	0	0
Alvin Dark, R (1, 6) OBP: 0.298, SLG: 0.371	0-0 5-3 ②		0-0 SF7 ②		0-0 4-3 ②			0-0 4-3 ①		3	0	0	1	0	0	0
Hank Thompson, L (1, 5) OBP: 0.421, SLG: 0.479	0-0 F9 ③		4-0 1B 1B BB		0-0 HR			0-0 G3 ②		3	1	1	1	1	0	0
Monte Irvin, R (1, 7) OBP: 0.350, SLG: 0.541		0-0 1-3 ①	0-0 1B 1B 1-2		0-0 1B			0-0 F5 ③		4	0	2	0	0	0	0
Don Mueller, L (1, 9) OBP: 0.368, SLG: 0.464		0-0 FC6-4 1B	0-0 FC6-4 1B 1-2 2-3			0-0 P6 ①			0-0 F7 ①	4	0	2	0	0	0	0
Willie Mays, R (1, 8) OBP: 0.317, SLG: 0.539		0-0 FC6-4 1-2f	0-0 FC6-4 1-2f			0-0 L7 ②			0-0 BB 1B	4	0	1	0	0	0	4
Whitey Lockman, L (1, 3) OBP: 0.325, SLG: 0.430	0-0 3-1 ③			0-0 G3 ①		0-0 6-3 ③			0-0 F9 ②	4	0	0	0	0	0	2
Ebba St. Claire, S (1, 2) OBP: 0.436, SLG: 0.429			0-0 E5 3B	0-3 K ②			0-0 F8 ①		4-0 BB 1-2	3	1	0	0	1	1	0
Larry Jansen, R (1, 1) OBP: 0.333, SLG: 0.333			0-3 K ①		0-0 1-3 ③		0-0 3-1 ②		0-0 4-3 ③	0	0	0	0	0	0	0
Jim Heath, R (2, 1) OBP: 0.333, SLG: 1.333										0	0	0	0	0	0	0
Windy McCall, L (2, 1) OBP: 0.333, SLG: 1.333										2	0	0	0	0	1	1
Bill Taylor, L (7, PH) OBP: 0.333, SLG: 0.273										1	0	0	0	0	0	0
Alex Konikowski, R (8, 1) OBP: 0.333, SLG: 0.273										0	0	0	0	0	0	0
Dusty Rhodes, L (9, PH) OBP: 0.500, SLG: 0.375										1	0	0	0	0	0	2

Inning Stats	R: 0	H: 0	E: 0	K: 0	S: 3	R: 0	H: 1	E: 0	K: 0	S: 4	R: 2	H: 3	E: 1	K: 1	S: 9	R: 0	H: 0	E: 0	K: 1	S: 5	R: 1	H: 2	E: 0	K: 0	S: 4	R: 0	H: 0	E: 0	K: 0	S: 3	R: 0	H: 0	E: 0	K: 0	S: 3	R: 0	H: 0	E: 0	K: 0	S: 4	R: 0	H: 1	E: 0	K: 0	S: 4	1B: 5	2B: 0	3B: 1	SF: 1	SAC: 0	DP: 0	HBP: 0	WP: 0	PA: 36
<b>Gerry Staley, R</b> (1, 1) ERA: 5.88	IP: 9.0	WLS: W	BF: 36	H: 7	R: 3	ER: 1	SO: 2	BB: 2	IBB: 0	HBP: 0	BLK: 0	WP: 0	HR: 1	S: 38	P: 46	ERA: 1.00	WHIP: 1.000																																					

**St. Louis Cardinals @ New York Giants**  
Polo Grounds, New York, NY  
Tue May 18 1954, 3:33 AM EDT  
Att. 19,053 - Unknown

<b>AB</b>	<b>33</b>
<b>R</b>	<b>3</b>
<b>H</b>	<b>7</b>
<b>RBI</b>	<b>3</b>
<b>BB</b>	<b>2</b>
<b>SO</b>	<b>2</b>
<b>LOB</b>	<b>9</b>



Batter	1	2	3	4	5	6	7	8	9	AB R H RBI BB SO LOB	TOP	
Wally Moon, L (1, 7) OBP: 0.451, SLG: 0.559	0-0 G3	0-0 F9			0-0 F9		0-0 FC4-6			4 0 0 0 0 0 2		
Solly Hemus, L (1, 6) OBP: 0.492, SLG: 0.500 Alex Grammas, R (5, 6) OBP: 0.292, SLG: 0.280	0-3 K2-3		0-3 K		0-3 K			0-0 G6-3 1B		3 0 0 0 0 3 0 1 0 1 0 0 0 0		
Red Schoendienst, S (1, 4) OBP: 0.348, SLG: 0.448	0-0 HR		0-3 K			0-0 P4		0-0 G6-3		4 1 1 1 0 1 1		
Stan Musial, L (1, 9) OBP: 0.484, SLG: 0.746	1-0 HBP		0-0 1-3			0-0 F5		4-0 BB		2 0 0 0 1 0 0		
Ray Jablonski, R (1, 5) OBP: 0.412, SLG: 0.585	0-3 K			0-0 1B K2-5-2 1B		0-0 1-3		0-0 5-3		4 0 1 0 0 1 2		
Tom Alston, L (1, 3) OBP: 0.372, SLG: 0.504		0-0 1B 5-3 1B		0-0 F8		0-0 L3		0-0 P6		4 1 1 0 0 0 1		
Rip Repulski, R (1, 8) OBP: 0.352, SLG: 0.476		0-0 P6		0-0 1-3 1B		0-0 HR		4-0 BB		3 1 2 1 1 0 1		
Del Rice, R (1, 2) OBP: 0.321, SLG: 0.392		0-0 5-3		0-3 K2-5-2		0-0 FC1-6 1B		0-0 P5		4 0 1 0 0 1 4		
Vic Raschi, R (1, 1) OBP: 0.185, SLG: 0.120		0-0 1B		0-0 F9		0-0 FC1-6 FC4-6		0-3 K		4 0 1 1 0 1 2		
<b>Inning Stats</b>	R: 1 E: 0 K: 2 S: 8 H: 1 LOB: 1 BB: 0 P: 9	R: 1 E: 0 K: 0 S: 5 H: 2 LOB: 1 BB: 0 P: 5	R: 0 E: 0 K: 2 S: 7 H: 0 LOB: 0 BB: 0 P: 7	R: 0 E: 0 K: 1 S: 6 H: 2 LOB: 2 BB: 0 P: 6	R: 0 E: 0 K: 1 S: 5 H: 0 LOB: 0 BB: 0 P: 5	R: 0 E: 0 K: 0 S: 3 H: 0 LOB: 0 BB: 0 P: 3	R: 1 E: 0 K: 0 S: 5 H: 2 LOB: 1 BB: 0 P: 5	R: 0 E: 0 K: 0 S: 3 H: 1 LOB: 1 BB: 1 P: 7	R: 0 E: 0 K: 1 S: 5 H: 0 LOB: 1 BB: 1 P: 9	1B: 6 2B: 1 3B: 0 HR: 2 SF: 0 SAC: 0 DP: 2 HBP: 1	WP: 0 PB: 0 SB: 0 CS: 0 PA: 36	
<b>PITCHER</b>	IP WLS BF H R ER SO BB IBB HBP BLK WP HR S P ERA WHIP											
Sal Maglie, R (1, 1) ERA: 2.85	8.0 L 32 8 3 3 6 1 0 1 0 0 2 42 47 3.38 1.125											
Hoyt Wilhelm, R (9, 1) ERA: 2.91	1.0 4 0 0 0 1 1 0 0 0 0 0 5 9 0.00 1.000											

St. Louis Cardinals @ New York Giants  
Polo Grounds, New York, NY  
Wed May 19 1954, 3:33 AM EDT  
Att. 6,663 - Unknown

[livebaseballscorecards.com](http://livebaseballscorecards.com)

AB	33
R	3
H	8
RBI	3
BB	2
SO	7
LOB	13



Batter	1	2	3	4	5	6	7	8	9	AB R H RBI BB SO LOB
--------	---	---	---	---	---	---	---	---	---	----------------------

Whitey Lockman, L (1, 3) OBP: 0.323, SLG: 0.423	0-0 G6-4-3 1B		0-0 F2			0-0 P5			0-0 P6	4 0 1 0 0 0 1
Alvin Dark, R (1, 6) OBP: 0.289, SLG: 0.359	0-0 G6-4-3 1-2f		0-0 F9			0-0 F5			0-0 1-3	4 0 0 0 0 0 2
Don Mueller, L (1, 9) OBP: 0.364, SLG: 0.457	0-0 3-1			0-0 G4-6-3 1B		0-0 F9			0-0 F5	4 0 1 0 0 0 0
Hank Thompson, L (1, 5) OBP: 0.411, SLG: 0.465		0-0 F9		0-0 G4-6-3 1-2f			0-0 4-3			3 0 0 0 0 0 1
Monte Irvin, R (1, 7) OBP: 0.341, SLG: 0.527		0-0 P5		0-0 L9			0-0 6-3			3 0 0 0 0 0 0
Willie Mays, R (1, 8) OBP: 0.326, SLG: 0.542		0-0 1B			0-0 FC4-6 1B		0-0 F8			3 0 2 0 0 0 0
Bobby Hofman, R (1, 4) OBP: 0.095, SLG: 0.381		0-0 P4			0-0 P6			0-0 5-3		3 0 0 0 0 0 2
Wes Westrum, R (1, 2) OBP: 0.316, SLG: 0.233			0-0 SH3 1B		0-3 K		0-0 F8		0-0 F8	2 0 1 0 0 1 1
Dusty Rhodes, L (8, PH) OBP: 0.455, SLG: 0.333										1 0 0 0 0 0 0
Ray Katt, R (9, 2) OBP: 0.375, SLG: 0.300										0 0 0 0 0 0 0
Sal Maglie, R (1, 1) OBP: 0.053, SLG: 0.053			0-0 SH3		0-0 FC4-6			0-3 K		1 0 0 0 0 0 1
Bill Taylor, L (8, PH) OBP: 0.308, SLG: 0.250										1 0 0 0 0 1 0
Hoyt Wilhelm, R (9, 1)			1-2		1-2f					0 0 0 0 0 0 0

Inning Stats	R: 0 E: 0 K: 0 S: 3	H: 1 LOB: 0 BB: 0 P: 3	R: 0 E: 0 K: 0 S: 4	H: 1 LOB: 1 BB: 0 P: 4	R: 0 E: 0 K: 0 S: 4	H: 1 LOB: 1 BB: 0 P: 4	R: 0 E: 0 K: 0 S: 3	H: 1 LOB: 0 BB: 0 P: 3	R: 0 E: 0 K: 1 S: 6	H: 1 LOB: 1 BB: 0 P: 6	R: 0 E: 0 K: 0 S: 3	H: 0 LOB: 0 BB: 0 P: 3	R: 0 E: 0 K: 0 S: 5	H: 0 LOB: 0 BB: 0 P: 5	R: 0 E: 0 K: 0 S: 3	H: 0 LOB: 0 BB: 0 P: 3	1B: 5 2B: 0 3B: 0 HR: 0	SF: 0 SAC: 1 DP: 2 HBP: 0	WP: 0 PB: 0 SB: 0 CS: 0	PA: 30
--------------	------------------------------	---------------------------------	------------------------------	---------------------------------	------------------------------	---------------------------------	------------------------------	---------------------------------	------------------------------	---------------------------------	------------------------------	---------------------------------	------------------------------	---------------------------------	------------------------------	---------------------------------	----------------------------------	------------------------------------	----------------------------------	--------

PITCHER	IP	WLS	BF	H	R	ER	SO	BB	IBB	HBP	BLK	WP	HR	S	P	ERA	WHIP	PITCHER	IP	WLS	BF	H	R	ER	SO	BB	IBB	HBP	BLK	WP	HR	S	P	ERA	WHIP	
Vic Raschi, R (1, 1) ERA: 3.71	9.0	W	30	5	0	0	2	0	0	0	0	0	0	34	34	0.00	0.556																			

BOTTOM

St. Louis Cardinals @ New York Giants  
 Polo Grounds, New York, NY  
 Wed May 19 1954, 3:33 AM EDT  
 Att. 6,663 - Unknown

livebaseballscorecards.com

AB	29
R	0
H	5
RBI	0
BB	0
SO	2
LOB	8



Batter	1	2	3	4	5	6	7	8	9	AB R H RBI BB SO LOB	TOP											
Whitey Lockman, L (1, 3) OBP: 0.328, SLG: 0.452	0-0 4-3			0-0 P5		0-0 HR		0-0 1B		4 1 2 1 0 0 0	<b>New York Giants @ Philadelphia Phillies</b> Connie Mack Stadium, Philadelphia, PA Fri May 21 1954, 3:33 AM EDT Att. 7,021 - Unknown  livebaseballscorecards.com  <b>AB 31</b> <b>R 1</b> <b>H 6</b> <b>RBI 1</b> <b>BB 1</b> <b>SO 7</b> <b>LOB 9</b>  											
Alvin Dark, R (1, 6) OBP: 0.295, SLG: 0.379	0-0 6-3			0-0 1B		0-0 3B		0-0 1-3		4 0 2 0 0 0 1												
Hank Thompson, L (1, 5) OBP: 0.406, SLG: 0.456	0-3 K			0-0 F8		0-3 K		0-0 G1-6-3 1B		4 0 1 0 0 2 2												
Monte Irvin, R (1, 7) OBP: 0.331, SLG: 0.509		0-0 5-3		0-0 F9		0-0 5-3		0-0 P3		4 0 0 0 0 0 2												
Don Mueller, L (1, 9) OBP: 0.360, SLG: 0.450		0-0 L8			0-0 1-3		0-0 FC5-4 1B	0-0 G1-6-3 1-2f		4 0 1 0 0 0 1												
Willie Mays, R (1, 8) OBP: 0.326, SLG: 0.533		0-0 4-3			4-0 G6-4-3 BB		0-0 F2			2 0 0 0 1 0 1												
Bobby Hofman, R (1, 4) OBP: 0.083, SLG: 0.333			0-0 P5		0-0 G6-4-3 1-2f		0-0 FC5-4 1-2f			3 0 0 0 0 0 2												
Ray Katt, R (1, 2) OBP: 0.333, SLG: 0.261			0-3 K		0-3 K		0-0 F7			3 0 0 0 0 2 0												
Johnny Antonelli, L (1, 1) OBP: 0.217, SLG: 0.182 Hoyt Wilhelm, R (6, PH) Hoot Evers, R (6, PH) Mario Picone, R (6, 1) Dusty Rhodes, L (8, PH) Don Liddle, L (8, 1)			0-3 K		0-3 K		0-3 K			0 0 0 0 0 0 0 1 0 0 0 0 1 0 1 0 0 0 0 1 0 0 0 0 0 0 0 0 1 0 0 0 0 1 0 0 0 0 0 0 0 0												
<b>Inning Stats</b>	R: 0 E: 0 K: 1 S: 5	H: 0 LOB: 0 BB: 0 P: 5	R: 0 E: 0 K: 0 S: 3	H: 0 LOB: 0 BB: 0 P: 3	R: 0 E: 0 K: 2 S: 7	H: 0 LOB: 0 BB: 0 P: 7	R: 0 E: 0 K: 0 S: 4	H: 1 LOB: 1 BB: 0 P: 4	R: 0 E: 0 K: 0 S: 2	H: 0 LOB: 0 BB: 1 P: 6	R: 1 E: 0 K: 3 S: 11	H: 2 LOB: 1 BB: 0 P: 11	R: 0 E: 0 K: 0 S: 4	H: 1 LOB: 1 BB: 0 P: 4	R: 0 E: 0 K: 1 S: 6	H: 1 LOB: 1 BB: 0 P: 6	R: 0 E: 0 K: 0 S: 3	H: 1 LOB: 0 BB: 0 P: 3	1B: 4 2B: 0 3B: 1 HR: 1	SF: 0 SAC: 0 DP: 2 HBP: 0	WP: 0 PB: 0 SB: 0 CS: 0	PA: 32
<b>PITCHER</b> Robin Roberts, R (1, 1) ERA: 2.23	IP 9.0 WLS W BF 32 H 6 R 1 ER 1 SO 7 BB 1 IBB 0 HBP 0 BLK 0 WP 0 HR 1 S 45 P 49 ERA 1.00 WHIP 0.778											<b>PITCHER</b>	IP WLS BF H R ER SO BB IBB HBP BLK WP HR S P ERA WHIP									





Batter	1	2	3	4	5	6	7	8	9	AB R H RBI BB SO LOB	TOP
Whitey Lockman, L (1, 3) OBP: 0.316, SLG: 0.433	0-0 F8	0-0 G3			0-0 F5		0-0 L7		0-0 F9	5 0 0 0 0 0 2	
Alvin Dark, R (1, 6) OBP: 0.287, SLG: 0.368	0-0 F9		0-0 L7		0-0 P4		0-0 F8			4 0 0 0 0 0 0	
Hank Thompson, L (1, 5) OBP: 0.401, SLG: 0.443	4-0 HR BB		0-0 G3		0-0 F3		0-0 3-1			3 1 0 0 1 0 0	
Monte Irvin, R (1, 7) OBP: 0.351, SLG: 0.542	0-0 1-H HR		4-0 3B BB		0-0 E 1B SF4 1B		4-0 G4-3 BB			2 3 2 2 2 0 0	
Don Mueller, L (1, 9) OBP: 0.372, SLG: 0.472	4-0 BB		0-0 1-H 3B		0-0 E7 SF4 S 1B		0-0 G4-3 1-2f			3 1 2 1 1 0 1	
Willie Mays, R (1, 8) OBP: 0.316, SLG: 0.520	0-0 F3		0-0 5-3		0-0 SF4		0-0 F8			3 0 0 1 0 0 2	
Davey Williams, R (1, 4) OBP: 0.205, SLG: 0.209		0-0 G6-4-3 1B		0-3 K		0-0 L4		0-0 5-3		4 0 1 0 0 1 1	AB 31 R 5 H 7 RBI 4 BB 5 SO 3 LOB 8
Ray Katt, R (1, 2) OBP: 0.323, SLG: 0.231		0-0 G6-4-3 1-2f		0-3 K		4-0 BB		0-3 K		3 0 0 0 1 2 1	
Ruben Gomez, R (1, 1) OBP: 0.333, SLG: 0.333		0-0 1B		0-0 F3		0-0 6-3		0-0 1B		4 0 2 0 0 0 1	
Inning Stats	R: 2 H: 1 E: 0 LOB: 1 K: 0 BB: 2 S: 4 P: 12	R: 0 H: 2 E: 0 LOB: 1 K: 0 BB: 0 P: 4	R: 1 H: 1 E: 0 LOB: 1 K: 0 BB: 1 P: 8	R: 0 H: 0 E: 0 LOB: 0 K: 2 BB: 0 P: 7	R: 0 H: 0 E: 0 LOB: 0 K: 0 BB: 0 P: 3	R: 2 H: 2 E: 1 LOB: 1 K: 0 BB: 1 S: 5 P: 9	R: 0 H: 0 E: 0 LOB: 0 K: 0 BB: 0 P: 3	R: 0 H: 0 E: 0 LOB: 0 K: 0 BB: 1 P: 6	R: 0 H: 1 E: 0 LOB: 1 K: 1 BB: 0 P: 6	1B: 5 SF: 1 2B: 0 SAC: 0 3B: 1 DP: 2 HR: 1 HBP: 0	WP: 0 PA: 37 PB: 0 SB: 1 CS: 0
PITCHER Paul Penson, R (1, 1) ERA: 3.46 Steve Ridzik, R (7, 1) ERA: 2.51	IP WLS BF H R ER SO BB IBB HBP BLK WP HR S P ERA WHIP										

New York Giants @ Philadelphia Phillies  
 Connie Mack Stadium, Philadelphia, PA

Sat May 22 1954, 3:33 AM EDT  
 Att. 12,183 - Unknown

livebaseballscorecards.com

BOTTOM

New York Giants @ Philadelphia Phillies  
Connie Mack Stadium, Philadelphia, PA

Sat May 22 1954, 3:33 AM EDT  
Att. 12,183 - Unknown

livebaseballscorecards.com

AB	30
R	0
H	6
RBI	0
BB	4
SO	3
LOB	18



WP:	1	PA:	34
PB:	0		
SB:	0		
CS:	0		

AB R H RBI BB SO LOB

4	0	1	0	0	0	0
3	0	1	0	1	0	1
2	0	0	0	2	0	2
4	0	0	0	0	0	6
3	0	0	0	1	0	1
4	0	2	0	0	1	3
4	0	1	0	0	0	2
3	0	1	0	0	1	1
2	0	0	0	0	0	1
1	0	0	0	0	1	1

Batter	1	2	3	4	5	6	7	8	9
Willie Jones, R OBP: 0.336, SLG: 0.317 (1, 5)	0-0 6-3 ①		0-0 F7 ①		0-0 F9 ③			0-0 FC4 1B	
Richie Ashburn, L OBP: 0.397, SLG: 0.291 (1, 8)	4-0 BB BB BB BB		0-0 E5 FC6-4			0-0 BB 1B		0-0 FC4 FC5-4 1-2f	
Earl Torgeson, L OBP: 0.398, SLG: 0.458 (1, 3)	4-0 BB 1-2 BB		0-0 F9 ②			4-0 L6-4 BB		0-0 P6 ②	
Del Ennis, R OBP: 0.341, SLG: 0.508 (1, 7)	0-0 F7 ②		0-0 FC6-4 1-2f			0-0 L6-4 ① ②		0-0 FC5-4 1-2f	
Granny Hamner, R OBP: 0.418, SLG: 0.451 (1, 4)	4-0 1-2 2-3 BB			0-0 4-3 ①		0-0 4-3 ③			0-0 4-3 ①
Johnny Wyrostek, L OBP: 0.282, SLG: 0.389 (1, 9)	0-3 K ③			0-0 L1-3 1B			0-0 4-3 ①		0-0 G1-6-3 1B
Smoky Burgess, L OBP: 0.408, SLG: 0.444 (1, 2)		0-0 1-3 ①		0-0 L1-3 1-2 ② ③			0-0 WP 1B		0-0 G1-6-3 1-2f ② ③
Ted Kazanski, R OBP: 0.167, SLG: 0.147 (1, 6)					0-0 6-3 ①		0-3 K 1-2 ②		
Paul Penson, R Steve Ridzik, R (7, 1)					0-0 1-3 ②		0-3 K ③		

Inning Stats	R: 0 E: 0 K: 1 S: 5	H: 0 LOB: 3 BB: 3 P: 17	R: 0 E: 0 K: 0 S: 3	H: 1 LOB: 0 BB: 0 P: 3	R: 0 E: 1 K: 0 S: 4	H: 0 LOB: 1 BB: 0 P: 4	R: 0 E: 0 K: 0 S: 3	H: 1 LOB: 0 BB: 0 P: 3	R: 0 E: 0 K: 0 S: 3	H: 0 LOB: 0 BB: 0 P: 3	R: 0 E: 0 K: 0 S: 3	H: 1 LOB: 1 BB: 1 P: 7	R: 0 E: 0 K: 2 S: 8	H: 1 LOB: 1 BB: 0 P: 8	R: 0 E: 0 K: 0 S: 4	H: 1 LOB: 1 BB: 0 P: 4	R: 0 E: 0 K: 0 S: 3	H: 1 LOB: 0 BB: 0 P: 3
--------------	------------------------------	----------------------------------	------------------------------	---------------------------------	------------------------------	---------------------------------	------------------------------	---------------------------------	------------------------------	---------------------------------	------------------------------	---------------------------------	------------------------------	---------------------------------	------------------------------	---------------------------------	------------------------------	---------------------------------

PITCHER	IP	WLS	BF	H	R	ER	SO	BB	IBB	HBP	BLK	WP	HR	S	P	ERA	WHIP
Ruben Gomez, R ERA: 4.36 (1, 1)	9.0	W	34	6	0	0	3	4	0	0	0	1	0	36	52	0.00	1.111

1B:	6	SF:	0
2B:	2	SAC:	0
3B:	0	DP:	4
HR:	0	HBP:	0

WP:	1	PA:	34
PB:	0		
SB:	0		
CS:	0		

Batter	1	2	3	4	5	6	7	8	9	AB R H RBI BB SO LOB	TOP											
Whitey Lockman, L (1, 3) OBP: 0.312, SLG: 0.424	0-0 F2	0-0 E8 1-3 2-H 3-H 1B		0-0 G4-6-3 1-2f		0-0 4-3			0-0 F8	5 0 1 2 0 0 1												
Alvin Dark, R (1, 6) OBP: 0.291, SLG: 0.369	0-0 FC4-6 1B	0-0 F5			0-0 G3		0-0 5-3		0-0 1B	5 0 2 0 0 0 2												
Hank Thompson, L (1, 5) OBP: 0.401, SLG: 0.450	0-0 FC4-6 1-2f CS		0-0 P6		0-0 4-3 1B 2B		0-0 4-3 1B		0-0 4-3	5 1 2 0 0 0 2												
Monte Irvin, R (1, 7) OBP: 0.348, SLG: 0.529	0-0 CS 1-2	0-0 F8	0-0 6-3		4-0 1B 4-3 BB		0-0 4-3 1-2			3 1 0 0 1 0 1												
Don Mueller, L (1, 9) OBP: 0.376, SLG: 0.472		0-0 FC6-4 1B	0-0 3B 1B		0-0 4-3 1-2 2-3		0-0 F8			4 1 2 0 0 0 3												
Willie Mays, R (1, 8) OBP: 0.321, SLG: 0.535		0-0 FC6-4 2B 1-2f BB	0-0 1-H 3B		0-0 1B 2-H 3-H		0-0 F5			4 1 2 3 0 0 1												
Davey Williams, R (1, 4) OBP: 0.206, SLG: 0.218		0-0 BB E 2B	0-0 P4		0-0 1-3		0-0 F5			4 1 1 0 0 0 2												
Ray Katt, R (1, 2) OBP: 0.364, SLG: 0.259		4-0 BB E IBB		0-0 FC3-4 1B		0-0 F8		0-0 K		1 1 1 0 1 0 0												
Joey Amalfitano, R (4, PR)										0 0 0 0 0 0 0												
Wes Westrum, R (4, 2) OBP: 0.300, SLG: 0.219										2 0 0 0 0 1 0												
Windy McCall, L (1, 1)		4-0 E BB		0-0 FC3-4 1-2f G4-6-3		0-0 4-3			0-0 F9	0 0 0 1 1 0 0												
Jim Hearn, R (3, 1) OBP: 0.200, SLG: 0.800										2 0 0 0 0 0 1												
Marv Grissom, R (7, 1)										1 0 0 0 0 0 0												
<b>Inning Stats</b>	R: 0 E: 0 K: 0 S: 3	H: 1 LOB: 0 BB: 0 P: 3	R: 3 E: 1 K: 0 S: 6	H: 3 LOB: 2 BB: 2 P: 14	R: 1 E: 0 K: 0 S: 5	H: 2 LOB: 1 BB: 0 P: 5	R: 0 E: 0 K: 0 S: 3	H: 1 LOB: 1 BB: 0 P: 3	R: 2 E: 0 K: 0 S: 5	H: 2 LOB: 1 BB: 1 P: 9	R: 0 E: 0 K: 0 S: 3	H: 0 LOB: 0 BB: 0 P: 3	R: 0 E: 0 K: 1 S: 5	H: 1 LOB: 1 BB: 0 P: 5	R: 0 E: 0 K: 0 S: 4	H: 0 LOB: 0 BB: 0 P: 5	R: 0 E: 0 K: 0 S: 4	H: 1 LOB: 1 BB: 0 P: 4	1B: 8 2B: 2 3B: 1 HR: 0	SF: 0 SAC: 0 DP: 1 HBP: 0	WP: 0 PB: 0 SB: 0 CS: 1	PA: 40
<b>PITCHER</b>	IP WLS BF H R ER SO BB IBB HBP BLK WP HR S P ERA WHIP											<b>PITCHER</b>	IP WLS BF H R ER SO BB IBB HBP BLK WP HR S P ERA WHIP									
Curt Simmons, L (1, 1) ERA: 1.87	3.0 L 16 6 4 4 0 1 1 0 0 0 0 14 22 12.00 2.333																					
Karl Drews, R (4, 1) ERA: 5.4	5.0 19 4 2 2 1 1 0 0 0 0 0 0 20 24 3.60 1.000																					
Jim Konstanty, R (9, 1) ERA: 3.93	1.0 4 1 0 0 0 0 0 0 0 0 0 0 4 4 0.00 1.000																					

**New York Giants @ Philadelphia Phillies**  
 Connie Mack Stadium, Philadelphia, PA  
 Sun May 23 1954, 3:33 AM EDT  
 Att. 9,688 - Unknown

[livebaseballscorecards.com](http://livebaseballscorecards.com)

<b>AB</b>	<b>36</b>
<b>R</b>	<b>6</b>
<b>H</b>	<b>11</b>
<b>RBI</b>	<b>6</b>
<b>BB</b>	<b>3</b>
<b>SO</b>	<b>1</b>
<b>LOB</b>	<b>13</b>





Batter	1	2	3	4	5	6	7	8	9	AB R H RBI BB SO LOB	TOP											
Whitey Lockman, L (1, 3) OBP: 0.303, SLG: 0.411	0-3 K		0-0 FC3-6		0-0 F2		0-0 SH5-3		0-0 3-1	4 0 0 0 0 1 1	<b>New York Giants @ Philadelphia Phillies</b> Connie Mack Stadium, Philadelphia, PA Mon May 24 1954, 3:33 AM EDT Att. 7,899 - Unknown <a href="http://livebaseballscorecards.com">livebaseballscorecards.com</a>											
Alvin Dark, R (1, 6) OBP: 0.283, SLG: 0.359	0-0 F8		0-0 1-3			0-0 4-3	0-0 F8			4 0 0 0 0 0 2												
Hank Thompson, L (1, 5) OBP: 0.397, SLG: 0.443	0-0 1B			0-0 G3		0-0 F9		0-0 4-3		4 0 1 0 0 0 0												
Monte Irvin, R (1, 7) OBP: 0.345, SLG: 0.516	0-0 F9			0-0 F3		4-0 BB		0-0 5-3		3 0 0 0 1 0 1												
Don Mueller, L (1, 9) OBP: 0.372, SLG: 0.473		0-0 L8		0-0 E4		0-0 4-3		0-0 HR		4 2 1 0 0 0 1												
Willie Mays, R (1, 8) OBP: 0.333, SLG: 0.588		0-3 K		0-0 E8			0-0 HR	0-0 HR		4 2 3 4 0 1 0												
Davey Williams, R (1, 4) OBP: 0.200, SLG: 0.211		0-0 4-3		0-0 6-3			0-0 4-3	0-0 F5		4 0 0 0 0 0 1												
Ray Katt, R (1, 2) OBP: 0.361, SLG: 0.300			0-0 4-3		0-0 P3		0-0 1B	0-3 K		3 0 1 0 0 0 0												
Billy Gardner, R (7, PR) OBP: 0.750, SLG: 0.667									0 1 0 0 0 0 0													
Wes Westrum, R (7, 2) OBP: 0.293, SLG: 0.212							0-0 2B		1 0 0 0 0 1 0													
Sal Maglie, R (1, 1) OBP: 0.095, SLG: 0.050			4-0 FC3-6		0-0 L4		0-0 SH5-3	0-3 K		1 0 0 0 1 0 0												
Dusty Rhodes, L (7, PH) OBP: 0.462, SLG: 0.364							2-H 1B		1 0 1 1 0 0 0													
Hoyt Wilhelm, R (7, 1)									1 0 0 0 0 1 0													
<b>Inning Stats</b>	R: 0 E: 0 K: 1 S: 6	H: 1 LOB: 1 BB: 0 P: 6	R: 0 E: 0 K: 1 S: 5	H: 0 LOB: 0 BB: 0 P: 5	R: 0 E: 0 K: 0 S: 3	H: 0 LOB: 1 BB: 1 P: 7	R: 1 E: 2 K: 0 S: 5	H: 1 LOB: 1 BB: 0 P: 5	R: 0 E: 0 K: 0 S: 3	H: 0 LOB: 0 BB: 0 P: 3	R: 0 E: 1 K: 0 S: 3	H: 0 LOB: 1 BB: 1 P: 7	R: 2 E: 0 K: 0 S: 6	H: 3 LOB: 1 BB: 0 P: 6	R: 2 E: 0 K: 0 S: 5	H: 2 LOB: 0 BB: 0 P: 5	R: 0 E: 0 K: 2 S: 7	H: 0 LOB: 0 BB: 0 P: 7	1B: 3 2B: 2 3B: 0 HR: 2	SF: 0 SAC: 1 DP: 0 HBP: 0	WP: 0 PB: 0 SB: 0 CS: 0	PA: 37
<b>PITCHER</b>	IP WLS BF H R ER SO BB IBB HBP BLK WP HR S P ERA WHIP												IP WLS BF H R ER SO BB IBB HBP BLK WP HR S P ERA WHIP									
Murry Dickson, R (1, 1) ERA: 3.13	8.0 L 34 7 5 4 2 2 0 0 0 0 0 2 36 44 4.50 1.125																					
Steve Ridzik, R (9, 1) ERA: 2.35	1.0 3 0 0 0 2 0 0 0 0 0 0 0 7 7 0.00 0.000																					

**New York Giants @ Philadelphia Phillies**  
 Connie Mack Stadium, Philadelphia, PA  
 Mon May 24 1954, 3:33 AM EDT  
 Att. 7,899 - Unknown

[livebaseballscorecards.com](http://livebaseballscorecards.com)

AB	34
R	5
H	7
RBI	5
BB	2
SO	4
LOB	6





Batter	1	2	3	4	5	6	7	8	9	AB R H RBI BB SO LOB	TOP																								
<b>Curt Roberts, R</b> (1, 4) OBP: 0.294, SLG: 0.313	0-0 1-3		0-0 G1		0-0 F3		0-0 L6		0-0 5-3	5 0 0 0 0 0 5																									
<b>Preston Ward, L</b> (1, 5) OBP: 0.281, SLG: 0.327	0-0 4-3		0-0 1-3		0-3 K			4-0 BB 3B BB		3 1 0 0 1 1 4																									
<b>Bob Skinner, L</b> (1, 3) OBP: 0.350, SLG: 0.423	0-3 K			0-0 HR	0-0 4-3			4-0 BB 1-2 3B BB		3 2 1 1 1 1 2																									
<b>Frank Thomas, R</b> (1, 7) OBP: 0.391, SLG: 0.537		0-0 F7		0-0 FC4-6 1B		0-0 L5		0-0 BB 1-H 2-H 3B		4 1 2 2 0 0 0																									
<b>Sid Gordon, R</b> (1, 9) OBP: 0.410, SLG: 0.393		0-0 5-3		0-0 FC4-6 1-2f		0-0 F8		0-0 L1-3 1B		4 0 1 1 0 0 1																									
<b>Jack Shepard, R</b> (1, 2) OBP: 0.364, SLG: 0.400		0-0 6-3		0-0 F8		0-3 K		0-0 L1-3 1-2		4 0 0 0 0 1 2																									
<b>Dick Cole, R</b> (1, 6) OBP: 0.379, SLG: 0.407			0-0 SH1-4 BB 1B	0-0 1-3		0-0 F9		0-0 F5		4 0 1 0 0 0 1																									
<b>Dick Hall, R</b> (1, 8) OBP: 0.314, SLG: 0.302			4-0 SH1-4 BB 1-2		4-0 1B BB		0-0 1B		0-0 6-3	2 0 1 0 2 0 0																									
<b>Bob Purkey, R</b> (1, 1) <b>Jim Mangan, R</b> (5, PH) <b>Paul LaPalme, L</b> (5, 1) <b>Gair Allie, R</b> (7, PH) <b>Jake Thies, R</b> (7, 1) <b>Joe Page, L</b> (7, 1) <b>Johnny Hetki, R</b> (8, 1) <b>Eddie Pellagrini, R</b> (9, PH)			0-0 SH1-4		0-0 1B		0-3 K		0-0 F7	0 0 0 0 0 0 0 1 0 1 0 0 0 0 0 0 0 0 0 0 0 1 0 0 0 0 0 1 1 0 1 0 0 0 0 0 0 0																									
<b>Inning Stats</b>	R: 0 E: 0 K: 1 S: 5	H: 0 LOB: 0 BB: 0 P: 5	R: 0 E: 0 K: 0 S: 3	H: 0 LOB: 0 BB: 0 P: 3	R: 0 E: 0 K: 0 S: 4	H: 1 LOB: 2 BB: 1 P: 8	R: 1 E: 0 K: 0 S: 5	H: 2 LOB: 1 BB: 0 P: 5	R: 0 E: 0 K: 1 S: 6	H: 1 LOB: 2 BB: 1 P: 10	R: 0 E: 0 K: 1 S: 5	H: 0 LOB: 0 BB: 0 P: 5	R: 0 E: 0 K: 1 S: 6	H: 1 LOB: 1 BB: 0 P: 6	R: 3 E: 0 K: 0 S: 4	H: 2 LOB: 0 BB: 2 P: 12	R: 0 E: 0 K: 0 S: 3	H: 0 LOB: 0 BB: 0 P: 3	1B: 5 2B: 1 3B: 1 HR: 1	SF: 0 SAC: 1 DP: 1 HBP: 0	WP: 0 PB: 0 SB: 0 CS: 0	PA: 37													
<b>PITCHER</b> <b>Johnny Antonelli, L</b> (1, 1) ERA: 2.67	IP 9.0	WLS W	BF 37	H 7	R 4	ER 4	SO 4	BB 4	IBB 0	HBP 0	BLK 0	WP 0	HR 1	S 41	P 57	ERA 4.00	WHIP 1.222	<b>PITCHER</b>	IP 9.0	WLS W	BF 37	H 7	R 4	ER 4	SO 4	BB 4	IBB 0	HBP 0	BLK 0	WP 0	HR 1	S 41	P 57	ERA 4.00	WHIP 1.222

**Pittsburgh Pirates @ New York Giants**  
**Polo Grounds, New York, NY**  
 Tue May 25 1954, 3:33 AM EDT  
 Att. 7,206 - Unknown

[livebaseballscorecards.com](http://livebaseballscorecards.com)

<b>AB</b>	32
<b>R</b>	4
<b>H</b>	7
<b>RBI</b>	4
<b>BB</b>	4
<b>SO</b>	4
<b>LOB</b>	16





Batter	1	2	3	4	5	6	7	8	9	AB	R	H	RBI	BB	SO	LOB
Whitey Lockman, L (1, 3) OBP: 0.318, SLG: 0.444	0-0 F8	0-0 4-3		0-0 6-3 1B		0-0 1B	0-0 HR	0-0 WP 1B 1B		6	2	4	4	0	0	2
Alvin Dark, R (1, 6) OBP: 0.278, SLG: 0.351	0-0 5-3		0-0 6-3	0-0 6-3 1B		0-0 FC5-4 1B	0-0 F8	0-0 F8		6	0	1	1	0	0	3
Hank Thompson, L (1, 5) OBP: 0.396, SLG: 0.441	0-0 4-3		0-0 BB 7-2 1B	0-0 F2		0-0 F2	0-0 2B	0-0 WP 1B 1B		3	0	1	0	0	0	2
Billy Gardner, R (6, 5) OBP: 0.714, SLG: 0.833										3	1	2	0	0	0	1
Monte Irvin, R (1, 7) OBP: 0.351, SLG: 0.504		4-0 1B G3 BB	4-0 BB 1-2 BB	0-0 6-3		0-0 FC5-4 1-2	0-0 F6	4-0 1B 1-2 2-3 BB		3	2	0	0	3	0	4
Don Mueller, L (1, 9) OBP: 0.392, SLG: 0.489		0-0 F8	4-0 BB 1-2 2-3 BB		0-0 3B 2B		0-0 BB 1B	4-0 BB 1B 1-2 2-3 HR 1B		4	3	3	2	2	0	1
Willie Mays, R (1, 8) OBP: 0.353, SLG: 0.607		0-0 G3 E 1B	0-0 7-2		0-0 2B 3B		4-0 1B HR BB	4-0 1B 1-2 HR BB 1-2 2-3 HR 1B		4	5	3	1	2	0	3
Davey Williams, R (1, 4) OBP: 0.228, SLG: 0.252		4-0 E G3 IBB		1-0 1B 1B HBP	0-0 6-3		0-0 HR 1B	0-0 HR 1B 1-2 2-3 HR 1B		4	4	3	4	1	0	1
Ray Katt, R (1, 2) OBP: 0.405, SLG: 0.429		0-0 G3		0-0 1B 1B 6-3 1B	0-0 2B		4-0 HR IBB	0-0 HR 3B		5	3	3	5	1	0	2
Johnny Antonelli, L (1, 1) OBP: 0.241, SLG: 0.321		0-0 E4		0-0 6-3 1B 1-2 2-H 1B	0-0 1-3		0-3 K	0-0 HR		6	1	2	3	0	1	5

Inning Stats	R: 0	H: 0	LOB: 0	K: 0	P: 3	R: 2	H: 1	LOB: 2	K: 0	P: 13	R: 0	H: 1	LOB: 2	K: 0	P: 11	R: 2	H: 3	LOB: 2	K: 0	P: 7	R: 1	H: 3	LOB: 1	K: 0	P: 5	R: 0	H: 2	LOB: 1	K: 0	P: 4	R: 5	H: 4	LOB: 1	K: 1	P: 17	R: 11	H: 8	LOB: 0	K: 0	P: 23
	0	0	0	0	3	2	1	2	0	13	0	1	2	0	11	2	3	2	0	7	1	3	0	1	5	0	2	0	4	5	4	1	17	11	8	0	0	23		

PITCHER	IP	WLS	BF	H	R	ER	SO	BB	IBB	HBP	BLK	WP	HR	S	P	ERA	WHIP
Bob Purkey, R (1, 1) ERA: 6.34	4.0	L	22	5	4	3	0	3	1	1	0	0	0	17	34	6.75	2.000
Paul LaPalme, L (5, 1) ERA: 5.06	2.0		9	5	1	1	0	0	0	0	0	0	0	9	9	4.50	2.500
Jake Thies, R (7, 1) ERA: 3.51	0.0		3	2	3	3	0	1	0	0	0	0	0	2	6	∞	∞
Joe Page, L (7, 1) ERA: 11.17	1.0		11	5	7	7	1	2	1	0	0	0	2	10	22	63.00	7.000
Johnny Hetki, R (8, 1) ERA: 4.76	1.0		9	5	6	6	0	1	0	0	0	1	1	8	12	54.00	6.000

**BOTTOM**

**Pittsburgh Pirates @ New York Giants**  
Polo Grounds, New York, NY  
Tue May 25 1954, 3:33 AM EDT  
Att. 7,206 - Unknown

AB	44
R	21
H	22
RBI	20
BB	9
SO	1
LOB	24



WP	HR	S	P	ERA	WHIP
1	3	0	1	6.75	2.000
0	0	0	1	4.50	2.500
0	0	0	1	∞	∞
0	0	0	1	63.00	7.000
0	0	0	1	54.00	6.000

Batter	1	2	3	4	5	6	7	8	9	AB R H RBI BB SO LOB	TOP											
<b>Curt Roberts, R</b> (1, 4) OBP: 0.293, SLG: 0.307	4-0 BB		0-0 5-3		0-3 K		0-0 F9			3 0 0 0 1 1 0												
<b>Preston Ward, L</b> (1, 5) OBP: 0.279, SLG: 0.321	0-0 F8		0-0 CS 1B		0-0 F8		0-0 F8			4 0 1 0 0 0 1												
<b>Bob Skinner, L</b> (1, 3) OBP: 0.348, SLG: 0.425	0-0 F8		0-3 K 1-2		0-0 2B			0-0 F7		4 0 1 0 0 1 2												
<b>Frank Thomas, R</b> (1, 7) OBP: 0.387, SLG: 0.526	0-0 6-3			0-0 6-3	4-0 BB			0-3 K		3 0 0 0 1 1 1												
<b>Sid Gordon, R</b> (1, 9) OBP: 0.390, SLG: 0.369		0-0 F7		0-0 P6	0-0 F8			0-0 3-1		4 0 0 0 0 0 2												
<b>Toby Atwell, L</b> (1, 2) OBP: 0.416, SLG: 0.440		0-0 1B E 1B		0-0 BB BB 1B		0-0 P6		0-0 F9		4 1 2 0 0 0 0												
<b>Dick Cole, R</b> (1, 6) OBP: 0.393, SLG: 0.415		0-0 E7 4-3 1-H 1B		4-0 BB BB 1-2 BB		0-0 6-3		0-0 1B		3 0 2 0 1 0 0												
<b>Dick Hall, R</b> (1, 8) OBP: 0.315, SLG: 0.292		0-0 4-3		4-0 BB BB 1-2 2-3 BB		0-0 5-3		0-0 L7		2 0 0 0 1 0 1												
<b>Jerry Lynch, L</b> (9, PH) OBP: 0.253, SLG: 0.346		0-0 2-3		0-0 1-2 2-3 BB		0-0 5-3		0-0 F7		1 0 0 0 0 0 1												
<b>Vern Law, R</b> (1, 1) OBP: 0.231, SLG: 0.182		0-3 K		0-0 5-3			0-0 6-3		0-0 F7	3 0 0 0 0 1 4												
<b>Jim Mangan, R</b> (9, PH) OBP: 0.500, SLG: 0.500										1 0 0 0 0 0 1												
<b>Inning Stats</b>	R: 0 E: 0 K: 0 S: 3	H: 0 LOB: 1 BB: 1 P: 7	R: 1 E: 1 K: 1 S: 7	H: 2 LOB: 1 BB: 0 P: 7	R: 0 E: 0 K: 1 S: 5	H: 1 LOB: 1 BB: 0 P: 5	R: 0 E: 0 K: 1 S: 4	H: 1 LOB: 3 BB: 2 P: 12	R: 0 E: 0 K: 1 S: 6	H: 1 LOB: 2 BB: 1 P: 10	R: 0 E: 0 K: 0 S: 3	H: 0 LOB: 0 BB: 0 P: 3	R: 0 E: 0 K: 0 S: 3	H: 0 LOB: 0 BB: 0 P: 3	R: 0 E: 0 K: 1 S: 5	H: 0 LOB: 0 BB: 0 P: 5	R: 0 E: 0 K: 0 S: 4	H: 1 LOB: 1 BB: 0 P: 4	1B: 5 2B: 2 3B: 0 HR: 0	SF: 0 SAC: 0 DP: 1 HBP: 0	WP: 0 PB: 0 SB: 0 CS: 1	PA: 36
<b>PITCHER</b> <b>Ruben Gomez, R</b> (1, 1) ERA: 3.43	IP: 9.0 WLS: W BF: 36 H: 6 R: 1 ER: 0 SO: 4 BB: 4 IBB: 0 HBP: 0 BLK: 0 WP: 0 HR: 0 S: 40 P: 56 ERA: 0.00 WHIP: 1.111																					
<b>PITCHER</b>																					IP: 9.0 WLS: W BF: 36 H: 6 R: 1 ER: 0 SO: 4 BB: 4 IBB: 0 HBP: 0 BLK: 0 WP: 0 HR: 0 S: 40 P: 56 ERA: 0.00 WHIP: 1.111	

**Pittsburgh Pirates @ New York Giants**  
**Polo Grounds, New York, NY**  
 Wed May 26 1954, 3:33 AM EDT  
 Att. 2,849 - Unknown

[livebaseballscorecards.com](http://livebaseballscorecards.com)

<b>AB</b>	<b>32</b>
<b>R</b>	<b>1</b>
<b>H</b>	<b>6</b>
<b>RBI</b>	<b>0</b>
<b>BB</b>	<b>4</b>
<b>SO</b>	<b>4</b>
<b>LOB</b>	<b>13</b>



Batter	1	2	3	4	5	6	7	8	9
Davey Williams, R OBP: 0.236, SLG: 0.282 (1, 4)	0-0 F9 ①		0-0 E5 G4-3 1-H 1B ①		0-0 HR			0-0 F9 ②	
Alvin Dark, R OBP: 0.272, SLG: 0.342 (1, 6)	0-3 K ②		0-0 G4-3 ①		0-3 K ③			0-0 F8 ③	
Whitey Lockman, L OBP: 0.318, SLG: 0.438 (1, 3)	4-0 FC5-4 BB		0-0 F7 ②			0-0 5-3 ①			
Monte Irvin, R OBP: 0.344, SLG: 0.492 (1, 7)	0-0 FC5-4 1-2f ③		0-0 4-3 ③			0-0 6-3 ②			
Don Mueller, L OBP: 0.384, SLG: 0.478 (1, 9)		0-0 F8 ①		0-0 L9 ①		0-0 3-1 ③			
Willie Mays, R OBP: 0.359, SLG: 0.623 (1, 8)		0-0 2B		0-0 5-3 ②			0-0 SH1-3 B1-6 2B		
Ray Katt, R OBP: 0.386, SLG: 0.405 (1, 2)		0-0 5-3 ②		0-0 P5 ③			0-0 SH1-3 2-3 ①		
Billy Gardner, R OBP: 0.500, SLG: 0.556 (1, 5)		0-0 F8 ③			0-0 F9 ①		0-0 B1-6 3-3f ② ③		
Ruben Gomez, R OBP: 0.267, SLG: 0.267 (1, 1)			0-0 E6 1B E ①			0-0 5-3 ②		0-3 K ①	

Inning Stats	R: 0	H: 0	E: 0	K: 1	S: 5	R: 0	H: 1	E: 0	K: 0	S: 4	R: 1	H: 1	E: 2	K: 0	S: 5	R: 0	H: 0	E: 0	K: 0	S: 3	R: 1	H: 1	E: 0	K: 1	S: 6	R: 0	H: 0	E: 0	K: 0	S: 3	R: 0	H: 1	E: 0	K: 0	S: 3	R: 0	H: 0	E: 0	K: 1	S: 5	R: 0	H: 0	E: 0	K: 1	S: 5
	LOB: 1	BB: 1	LOB: 1	BB: 0	P: 9	LOB: 1	BB: 0	LOB: 1	BB: 0	P: 4	LOB: 0	BB: 0	LOB: 0	BB: 0	P: 5	LOB: 0	BB: 0	LOB: 0	BB: 0	P: 3	LOB: 0	BB: 0	LOB: 0	BB: 0	P: 6	LOB: 0	BB: 0	LOB: 0	BB: 0	P: 3	LOB: 0	BB: 0	LOB: 0	BB: 0	P: 3	LOB: 0	BB: 0	LOB: 0	BB: 0	P: 5	LOB: 0	BB: 0	LOB: 0	BB: 0	P: 5

PITCHER	IP	WLS	BF	H	R	ER	SO	BB	IBB	HBP	BLK	WP	HR	S	P	ERA	WHIP												
Vern Law, R ERA: 3.75 (1, 1)	8.0	L	29	4	2	1	3	1	0	0	0	0	1	34	38	1.12	0.625												

**BOTTOM**

**Pittsburgh Pirates @ New York Giants**  
Polo Grounds, New York, NY  
Wed May 26 1954, 3:33 AM EDT  
Att. 2,849 - Unknown

AB	R	H	RBI	BB	SO	LOB
4	1	2	1	0	0	0
4	0	0	0	0	2	1
2	0	0	0	1	0	1
3	0	0	0	0	0	2
3	0	0	0	0	0	0
3	0	2	0	0	0	0
2	0	0	0	0	0	1
3	0	0	0	0	0	2
3	1	0	0	0	1	0

AB	27
R	2
H	4
RBI	1
BB	1
SO	3
LOB	7



WP	PA
0	29
PB	0
SB	0
CS	0

WP	PA	ERA	WHIP
0	29		

Batter	1	2	3	4	5	6	7	8	9	AB R H RBI BB SO LOB	TOP
<b>Jim Gilliam, S</b> (1, 4) <small>OBP: 0.301, SLG: 0.396</small>	2-2 		1-1 		1-2 	4-2 		1-1 		4 0 0 0 1 0 0	<b>Brooklyn Dodgers @ New York Giants</b> Polo Grounds, New York, NY Fri May 28 1954, 3:33 AM EDT Att: 38,758 - Unknown
<b>Pee Wee Reese, R</b> (1, 6) <small>OBP: 0.355, SLG: 0.411</small>	2-2 		4-2 		1-2 	4-2 		3-2 	3 1 1 0 2 0 0		
<b>Duke Snider, L</b> (1, 8) <small>OBP: 0.443, SLG: 0.655</small>	1-1 		4-0 		4-1 	3-1 		2-3 	2 0 0 1 2 1 0		
<b>Jackie Robinson, R</b> (1, 7) <b>Dick Williams, R</b> (5, 7) <small>OBP: 0.467, SLG: 0.534</small> <small>OBP: 0.063, SLG: 0.267</small>		1-0 	2-2 		1-2 	2-2 		0-1 	3 1 2 1 0 0 2 2 0 0 0 0 0 2		
<b>Gil Hodges, R</b> (1, 3) <small>OBP: 0.369, SLG: 0.586</small>		1-0 	2-2 			2-2 	4-1 		2 1 1 1 1 0 2		
<b>Carl Furillo, R</b> (1, 9) <small>OBP: 0.310, SLG: 0.258</small>		4-2 		1-1 		0-1 	1-1 		3 1 1 1 1 0 1		
<b>Don Hoak, R</b> (1, 5) <small>OBP: 0.338, SLG: 0.475</small>		2-1 		4-0 		2-1 	1-2 		3 0 1 0 1 0 2		
<b>Rube Walker, L</b> (1, 2) <small>OBP: 0.264, SLG: 0.238</small>		2-1 		2-2 		4-2 		2-2 	3 1 0 0 1 0 2		
<b>Clem Labine, R</b> (1, 1) <b>Russ Meyer, S</b> (4, 1) <b>Bob Milliken, R</b> (4, 1) <b>George Shuba, L</b> (6, PH) <b>Erv Palica, R</b> (6, 1) <b>Tim Thompson, L</b> (8, PH) <b>Ben Wade, R</b> (8, 1)			2-2 		3-2 	1-0 		1-3 	1 0 0 0 0 0 0 0 0 0 0 0 0 0 1 0 0 0 0 0 0 1 1 1 1 0 0 0 0 0 0 0 0 0 0 1 0 0 0 0 1 0 0 0 0 0 0 0 0		
<b>Inning Stats</b>	R: 0 H: 0 E: 0 LOB: 0 K: 0 BB: 0 S: 8 P: 13	R: 1 H: 2 E: 0 LOB: 1 K: 0 BB: 1 S: 9 P: 19	R: 1 H: 1 E: 0 LOB: 2 K: 0 BB: 2 S: 15 P: 30	R: 0 H: 0 E: 0 LOB: 0 K: 0 BB: 1 S: 5 P: 12	R: 0 H: 1 E: 0 LOB: 2 K: 0 BB: 1 S: 16 P: 26	R: 4 H: 3 E: 0 LOB: 2 K: 0 BB: 3 S: 21 P: 43	R: 0 H: 0 E: 0 LOB: 0 K: 0 BB: 1 S: 6 P: 12	R: 0 H: 0 E: 0 LOB: 0 K: 1 BB: 0 S: 9 P: 13	R: 0 H: 0 E: 0 LOB: 0 K: 1 BB: 0 S: 8 P: 13	1B: 5 SF: 2 2B: 0 SAC: 0 3B: 2 DP: 2 HR: 0 HBP: 0	
<b>PITCHER</b> <b>Jim Hearn, R</b> (1, 1) <small>ERA: 7.83</small> <b>Mary Grissom, R</b> (6, 1) <small>ERA: 1.8</small>	IP WLS BF H R ER SO BB IBB HBP BLK WP HR S P ERA WHIP 5.1 W 27 7 6 6 0 6 0 0 0 0 0 0 65 121 10.12 2.438					<b>PITCHER</b> IP WLS BF H R ER SO BB IBB HBP BLK WP HR S P ERA WHIP 3.2 S 13 0 0 0 2 3 0 0 0 1 0 0 32 60 0.00 0.818					

livebaseballscorecards.com

AB	29
R	6
H	7
RBI	5
BB	9
SO	2
LOB	11





Batter	1	2	3	4	5	6	7	8	9	AB R H RBI BB SO LOB	TOP
<b>Jim Gilliam, S</b> (1, 4) <small>OBP: 0.310, SLG: 0.403</small>	1-2 <b>4-3</b> 	1-1 		0-0 <b>F5</b> 			1-0 		2-1 	5 1 3 0 0 0 1	
<b>Pee Wee Reese, R</b> (1, 6) <small>OBP: 0.357, SLG: 0.428</small>	3-2 <b>5-3</b> 	4-2 			0-2 <b>L8</b> 		1-2 <b>FC4-6</b> 		1-2 	4 1 1 3 1 0 1	
<b>Duke Snider, L</b> (1, 8) <small>OBP: 0.436, SLG: 0.640</small>	3-1 	0-0 <b>4-3</b> 			1-0 <b>F7</b> 		2-3 <b>K</b> 		0-0 <b>F8</b> 	5 0 1 0 0 1 4	
<b>Jackie Robinson, R</b> (1, 7) <small>OBP: 0.477, SLG: 0.538</small>	1-2 		1-1 		4-1 		2-2 <b>F9</b> 			3 0 2 0 1 0 1	
<b>George Shuba, L</b> (1, 9) <b>Carl Furillo, R</b> (9, 9) <small>OBP: 0.311, SLG: 0.286</small> <small>OBP: 0.310, SLG: 0.258</small>	2-2 <b>F9</b> 		0-1 <b>G1-6-3</b> 		0-3 <b>K</b> 			2-2 <b>4-3</b> 		4 0 0 0 0 1 4 0 0 0 0 0 0 0	
<b>Gil Hodges, R</b> (1, 3) <small>OBP: 0.373, SLG: 0.603</small>		4-2 	3-2 <b>F7</b> 		2-1 			0-0 <b>5-3</b> 		3 2 1 1 1 0 0	
<b>Don Hoak, R</b> (1, 5) <small>OBP: 0.319, SLG: 0.446</small>		1-3 		1-1 <b>4-3</b> 		2-2 <b>F9</b> 		2-2 <b>F7</b> 		4 0 0 0 0 1 1	
<b>Rube Walker, L</b> (1, 2) <small>OBP: 0.250, SLG: 0.224</small>		0-1 <b>L7</b> 		1-0 <b>F9</b> 		1-0 <b>F7</b> 			2-1 <b>L8</b> 	4 0 0 0 0 0 1	
<b>Carl Erskine, R</b> (1, 1) <small>OBP: 0.179, SLG: 0.080</small>		4-0 		4-1 		0-2 <b>5-3</b> 			0-0 <b>B5-3</b> 	2 0 0 0 2 0 0	
<b>Inning Stats</b>	R: 0 H: 2 E: 0 LOB: 2 K: 0 BB: 0 S: 16 P: 26	R: 1 H: 1 E: 0 LOB: 3 K: 1 BB: 3 S: 12 P: 26	R: 0 H: 1 E: 0 LOB: 0 K: 0 BB: 0 S: 7 P: 11	R: 0 H: 0 E: 0 LOB: 1 K: 0 BB: 1 S: 5 P: 11	R: 0 H: 0 E: 0 LOB: 1 K: 1 BB: 1 S: 9 P: 14	R: 1 H: 1 E: 0 LOB: 0 K: 0 BB: 0 S: 9 P: 14	R: 0 H: 1 E: 0 LOB: 1 K: 1 BB: 0 S: 12 P: 18	R: 0 H: 0 E: 0 LOB: 0 K: 0 BB: 0 S: 7 P: 11	R: 2 H: 2 E: 0 LOB: 0 K: 0 BB: 0 S: 9 P: 14	1B: 6 SF: 0 2B: 0 SAC: 0 3B: 0 DP: 1 HR: 2 HBP: 0	WP: 0 PA: 39 PB: 0 SB: 1 CS: 0
<b>PITCHER</b> <b>Sal Maglie, R</b> (1, 1) <small>ERA: 2.99</small>	IP 9.0 WLS L BF 39 H 8 R 4 ER 4 SO 3 BB 5 IBB 0 HBP 0 BLK 0 WP 0 HR 2 S 86 P 145 ERA 4.00 WHIP 1.444					<b>PITCHER</b> IP WLS BF H R ER SO BB IBB HBP BLK WP HR S P ERA WHIP					

**Brooklyn Dodgers @ New York Giants**  
 Polo Grounds, New York, NY  
 Sat May 29 1954, 3:33 AM EDT  
 Att. 22,264 - Unknown

AB	34
R	4
H	8
RBI	4
BB	5
SO	3
LOB	13



[livebaseballscorecards.com](http://livebaseballscorecards.com)

Batter	1	2	3	4	5	6	7	8	9	AB R H RBI BB SO LOB
Davey Williams, R (1, 4) OBP: 0.242, SLG: 0.299	4-0 FC5-4 BB		1-0 6-3			3-2 F2		3-3 K		3 0 0 0 1 1 1
Alvin Dark, R (1, 6) OBP: 0.269, SLG: 0.372	1-3 K			0-1 F5		2-2 HR		3-2 F4		4 1 1 1 0 1 1
Whitey Lockman, L (1, 3) OBP: 0.319, SLG: 0.452	1-1 F7			1-1 1-3		0-0 F8		0-0 1B		4 0 1 0 0 0 1
Monte Irvin, R (1, 7) OBP: 0.338, SLG: 0.496	3-1 FC5-4 1-2f			2-1 F9		1-0 6-3		1-0 F4		4 0 0 0 0 0 2
Don Mueller, L (1, 9) OBP: 0.387, SLG: 0.483		1-0 6-3		1-1 6-3		1-0 4-3		0-0 1B		4 0 1 0 0 0 0
Willie Mays, R (1, 8) OBP: 0.370, SLG: 0.660		0-0 F2		1-0 HR		3-2 3-1		1-3 K		4 1 1 1 0 1 2
Ray Katt, R (1, 2) OBP: 0.404, SLG: 0.419		2-0 F6		2-3 K		3-2 F8				3 0 0 0 0 1 0
Billy Gardner, R (1, 5) OBP: 0.556, SLG: 0.875			2-2 6-3		3-2 5-3		0-0 2B			3 0 1 0 0 0 0
Sal Maglie, R (1, 1) OBP: 0.083, SLG: 0.043			0-0 F2			1-2 5-3		2-3 K		3 0 0 0 0 1 1

Inning Stats	R: 0	H: 0	E: 0	K: 1	S: 7	R: 0	H: 0	E: 0	K: 0	S: 3	R: 0	H: 0	E: 0	K: 0	S: 5	R: 1	H: 1	E: 0	K: 1	S: 12	R: 1	H: 1	E: 0	K: 0	S: 14	R: 0	H: 0	E: 0	K: 0	S: 5	R: 0	H: 1	E: 0	K: 2	S: 10	R: 0	H: 2	E: 0	K: 1	S: 10	1B: 2	SF: 0	2B: 1	SAC: 0	3B: 0	DP: 0	HR: 2	HBP: 0	WP: 0	PA: 33
	0	0	0	1	7	0	0	0	0	3	0	0	0	0	5	1	1	0	1	12	1	1	0	0	0	14	0	0	0	0	5	0	1	0	2	10	0	2	0	1	10	2	0	1	0	0	2	0	0	33

PITCHER	IP	WLS	BF	H	R	ER	SO	BB	IBB	HBP	BLK	WP	HR	S	P	ERA	WHIP
Carl Erskine, R (1, 1) ERA: 3.91	9.0	W	33	5	2	2	5	1	0	0	0	0	2	72	121	2.00	0.667

**BOTTOM**

**Brooklyn Dodgers @ New York Giants**  
Polo Grounds, New York, NY

Sat May 29 1954, 3:33 AM EDT  
Att. 22,264 - Unknown

livebaseballscorecards.com

AB	32
R	2
H	5
RBI	2
BB	1
SO	5
LOB	8



Batter	1	2	3	4	5	6	7	8	9	AB R H RBI BB SO LOB	TOP																
Jim Gilliam, S (1, 4) OBP: 0.307, SLG: 0.396	2-1 6-3	2-2 1B			1-2 L7	1-1 3-1			0-0 F7	5 0 1 0 0 0 2																	
Pee Wee Reese, R (1, 6) OBP: 0.360, SLG: 0.443	1-0 IHR 3B	3-2 F8			2-1 1B 1-2 1B			2-1 F9		4 1 2 0 0 0 2																	
Duke Snider, L (1, 8) OBP: 0.438, SLG: 0.636	2-3 IHR		1-0 G1-6-3 1B		0-0 1-2 2-3 1B			0-0 F7		4 0 2 0 0 1 1																	
Jackie Robinson, R (1, 7) OBP: 0.470, SLG: 0.527	4-0 IHR BB		0-1 G1-6-3 1-2f		1-1 SF8			3-2 5-3		2 1 0 1 1 0 1																	
Gil Hodges, R (1, 3) OBP: 0.370, SLG: 0.614	3-1 IHR		0-1 5-3		2-2 F9			0-0 F3		4 1 1 3 0 0 2																	
Roy Campanella, R (1, 2) OBP: 0.260, SLG: 0.359	2-0 5-3			2-2 6-3		1-0 F9		0-1 1-3		4 0 0 0 0 0 0																	
Carl Furillo, R (1, 9) OBP: 0.322, SLG: 0.288		1-2 G6-4-3 1B		1-0 G4-3 1B		2-0 1B 3B		0-0 F7		4 1 3 0 0 0 0																	
Don Hoak, R (1, 5) OBP: 0.315, SLG: 0.435		3-2 G6-4-3 1-2f		3-2 G4-3 1-2f		2-2 SH1-4 1B		0-1 1-3		4 0 1 1 0 0 2																	
Johnny Podres, L (1, 1) OBP: 0.391, SLG: 0.476		0-1 1B 1B			1-1 1B SF8 1B		0-0 SH1-4		1-0 F5	3 1 2 0 0 0 0 0 0 0 0 0 0 0																	
Jim Hughes, R (9, 1)																											
<b>Inning Stats</b>	R: 3 E: 0 K: 1 S: 9	H: 2 LOB: 0 BB: 1 P: 23	R: 0 E: 0 K: 0 S: 14	H: 3 LOB: 2 BB: 0 P: 23	R: 0 E: 0 K: 0 S: 5	H: 1 LOB: 0 BB: 0 P: 6	R: 0 E: 0 K: 0 S: 9	H: 1 LOB: 0 BB: 0 P: 15	R: 1 E: 0 K: 0 S: 13	H: 3 LOB: 2 BB: 0 P: 20	R: 1 E: 0 K: 0 S: 11	H: 2 LOB: 1 BB: 0 P: 17	R: 0 E: 0 K: 0 S: 8	H: 0 LOB: 0 BB: 0 P: 13	R: 0 E: 0 K: 0 S: 4	H: 0 LOB: 0 BB: 0 P: 4	R: 0 E: 0 K: 0 S: 4	H: 0 LOB: 0 BB: 0 P: 5	1B: 9 2B: 0 3B: 2 HR: 1	SF: 1 SAC: 1 DP: 3 HBP: 0	WP: 0 PB: 0 SB: 0 CS: 0	PA: 37					
<b>PITCHER</b>	IP WLS BF H R ER SO BB IBB HBP BLK WP HR S P ERA WHIP																										
Johnny Antonelli, L (1, 1) ERA: 3.0	2.0		11	5	3	3	1	1	0	0	0	0	0	23	46	13.50	3.000										
Larry Jansen, R (3, 1) ERA: 4.91	5.0	L	20	7	2	2	0	0	0	0	0	0	0	46	71	3.60	1.400										
Hoyt Wilhelm, R (8, 1) ERA: 1.99	2.0		6	0	0	0	0	0	0	0	0	0	0	8	9	0.00	0.000										

Brooklyn Dodgers @ New York Giants  
Polo Grounds, New York, NY  
Sun May 30 1954, 3:33 AM EDT  
Att: 47,672 - Unknown

livebaseballscorecards.com

AB	34
R	5
H	12
RBI	5
BB	1
SO	1
LOB	10







Batter	1	2	3	4	5	6	7	8	9	AB R H RBI BB SO LOB	TOP	
Davey Williams, R OBP: 0.236, SLG: 0.290 (1, 4) X	0-0 F7	0-0 FC6-4 1-2 1B		X 0-0 F3			X 0-0 F8			4 0 1 0 0 0 1		
Alvin Dark, R OBP: 0.263, SLG: 0.372 (1, 6) S S	0-3 K	0-0 FC6-4 1-2f			X 0-0 SF7 3B		X 0-3 K			4 1 1 0 0 2 2		
Whitey Lockman, L OBP: 0.316, SLG: 0.438 (1, 3) X	0-0 3-1		X 0-0 F8		X 0-0 F5		X 0-0 P6			4 0 0 0 0 0 1		
Monte Irvin, R OBP: 0.333, SLG: 0.483 (1, 7) X		X 0-0 FC3-6 1B	X 0-0 F7		X 0-0 SF7		X 0-0 L6			3 0 1 1 0 0 0		
Don Mueller, L OBP: 0.380, SLG: 0.471 (1, 9) X		X 0-0 FC3-6 1-2f HR	X 0-0 FC6-4 1B		X 0-0 G3		X 0-0 F8			4 1 1 0 0 0 1		
Willie Mays, R OBP: 0.382, SLG: 0.695 (1, 8) X		X 0-0 HR	X 0-0 FC6-4		X 0-0 5-3		X 0-0 4-3 S 1B			4 1 2 2 0 0 1		
Ray Katt, R OBP: 0.379, SLG: 0.388 (1, 2) X		X 0-0 5-3 1B		S S 0-3 K		X 0-0 F9		S S 0-3 K		4 1 1 0 0 2 1		
Billy Gardner, R OBP: 0.400, SLG: 0.609 (1, 5) X		X 0-0 5-3		X 0-0 2-3		X 0-0 6-3		X 0-0 4-3		4 0 0 0 0 0 2		
Ruben Gomez, R OBP: 0.316, SLG: 0.316 (1, 1) X		X 0-0 1B		X 0-0 1B		S S 0-3 K		X 0-0 4-3		4 0 2 1 0 1 1		
<b>Inning Stats</b>	R: 0 E: 0 K: 1 S: 5 H: 0 LOB: 0 BB: 0 P: 5	R: 3 E: 0 K: 0 S: 8 H: 5 LOB: 2 BB: 0 P: 8	R: 0 E: 0 K: 0 S: 4 H: 1 LOB: 1 BB: 0 P: 4	R: 0 E: 0 K: 1 S: 6 H: 1 LOB: 1 BB: 0 P: 6	R: 1 E: 0 K: 0 S: 4 H: 1 LOB: 0 BB: 0 P: 4	R: 0 E: 0 K: 0 S: 3 H: 0 LOB: 0 BB: 0 P: 3	R: 0 E: 0 K: 2 S: 7 H: 0 LOB: 0 BB: 0 P: 7	R: 0 E: 0 K: 0 S: 3 H: 0 LOB: 0 BB: 0 P: 3	R: 0 E: 0 K: 1 S: 6 H: 1 LOB: 1 BB: 0 P: 6	1B: 7 2B: 0 3B: 1 HR: 1 SF: 1 SAC: 0 DP: 0 HBP: 0	WP: 0 PB: 0 SB: 1 CS: 0 PA: 36	
<b>PITCHER</b>	IP WLS BF H R ER SO BB IBB HBP BLK WP HR S P ERA WHIP											
Len Yochim, L ERA: 7.9 (1, 1)	1.2 L 10 5 3 3 1 0 0 0 0 0 0 1 12 12 16.20 3.000											
Jake Thies, R ERA: 3.09 (2, 1)	6.1 22 3 1 1 3 0 0 0 0 0 0 0 28 28 1.42 0.474											
Bob Friend, R ERA: 7.09 (9, 1)	1.0 4 1 0 0 1 0 0 0 0 0 0 0 6 6 0.00 1.000											

**New York Giants @ Pittsburgh Pirates**  
 Forbes Field, Pittsburgh, PA  
 Mon May 31 1954, 3:33 AM EDT  
 Unknown

[livebaseballscorecards.com](http://livebaseballscorecards.com)

AB	35
R	4
H	9
RBI	4
BB	0
SO	5
LOB	10



Batter	1	2	3	4	5	6	7	8	9	AB	R	H	RBI	BB	SO	LOB
Eddie Pellagrini, R OBP: 0.288, SLG: 0.250 (1, 5)	0-3 K ①		0-3 K ②		0-0 F9 ③			4-0 BB		3	0	0	0	1	2	1
Dick Cole, R OBP: 0.389, SLG: 0.405 (1, 6)	0-0 F7 ②		0-0 F7 ③			0-0 G4-6-3 1B		0-0 4-3 ③		4	0	1	0	0	0	1
Bob Skinner, L OBP: 0.351, SLG: 0.401 (1, 3)	0-0 4-3 ③			0-3 K ①		0-0 G4-6-3 ① ② 1-2f		0-0 F9 ①		4	0	0	0	0	1	1
Frank Thomas, R OBP: 0.373, SLG: 0.524 (1, 7)		0-0 L6 ①		0-0 4-3 ②		0-3 K ③		0-0 5-3 ②		4	0	0	0	0	1	0
Sid Gordon, R OBP: 0.373, SLG: 0.333 (1, 9)		0-0 5-3 ②		4-0 BB		0-0 6-3 ①		0-0 L4 ③		3	0	0	0	1	0	0
Toby Atwell, L OBP: 0.437, SLG: 0.442 (1, 2)		4-0 1B BB		0-0 4-3 ③		4-0 BB G6-4-3		4-0 BB G6-4-3 ② ③		1	0	0	0	2	0	1
Curt Roberts, R OBP: 0.286, SLG: 0.295 (1, 4)		0-0 1B 1-2			0-0 SH1-4 1B		0-0 G6-4-3 ② ③ 1-2f			3	0	2	0	0	0	1
Dick Hall, R OBP: 0.301, SLG: 0.280 (1, 8)		0-0 P6 ③		0-3 K ①				0-0 4-3 ①		3	0	0	0	0	1	3
Len Yochim, L OBP: 0.500, SLG: 0.500 (1, 1)			0-0 F8 ①					0-0 P6 ②		0	0	0	0	0	0	0
Jake Thies, R (2, 1)					0-0 SH1-4 ②					1	0	0	0	0	0	0
Jack Shepard, R OBP: 0.375, SLG: 0.400 (8, PH)										1	0	0	0	0	0	0
Bob Friend, R OBP: 0.400, SLG: 0.353 (9, 1)										0	0	0	0	0	0	0

Inning Stats	R: 0	H: 0	E: 0	K: 1	S: 5	H: 0	LOB: 0	BB: 0	P: 5	R: 0	H: 1	E: 0	K: 1	S: 5	H: 0	LOB: 2	BB: 1	P: 8	R: 0	H: 0	E: 0	K: 1	S: 5	H: 0	LOB: 0	BB: 0	P: 5	R: 0	H: 0	E: 0	K: 1	S: 5	R: 0	H: 1	E: 0	K: 1	S: 6	H: 1	LOB: 1	BB: 0	P: 6	R: 0	H: 1	E: 0	K: 1	S: 5	H: 0	LOB: 0	BB: 0	P: 5	R: 0	H: 0	E: 0	K: 0	S: 2	H: 0	LOB: 0	BB: 1	P: 6	R: 0	H: 0	E: 0	K: 0	S: 3	H: 0	LOB: 1	BB: 1	P: 7	R: 0	H: 0	E: 0	K: 0	S: 3	H: 0	LOB: 0	BB: 0	P: 3	1B: 3	SF: 0	2B: 0	SAC: 1	3B: 0	DP: 2	HR: 0	HBP: 0	WP: 0	PA: 32	PB: 0	SB: 0	CS: 0	ERA	WHIP
PITCHER Ruben Gomez, R ERA: 2.82 (1, 1)	9.0	WLS	W	BF	32	H	3	R	0	ER	0	SO	5	BB	4	IBB	0	HBP	0	BLK	0	WP	0	HR	0	S	38	P	54	ERA	0.00	WHIP	0.778																																																											
PITCHER	IP	WLS	BF	H	R	ER	SO	BB	IBB	HBP	BLK	WP	HR	S	P	ERA	WHIP																																																																											

**BOTTOM**

**New York Giants @ Pittsburgh Pirates**  
 Forbes Field, Pittsburgh, PA  
 Mon May 31 1954, 3:33 AM EDT  
 Unknown

AB	27
R	0
H	3
RBI	0
BB	4
SO	5
LOB	8



livebaseballscorecards.com

Batter	1	2	3	4	5	6	7	8	9	AB R H RBI BB SO LOB	TOP
Davey Williams, R (1, 4) OBP: 0.236, SLG: 0.284	0-0 F7		4-0 BB		0-0 F9		0-0 P5			3 0 0 0 1 0 0	
Alvin Dark, R (1, 6) OBP: 0.262, SLG: 0.369	0-0 5-3		0-0 F9		0-0 1B		0-0 L4			4 1 1 0 0 0 1	
Whitey Lockman, L (1, 3) OBP: 0.320, SLG: 0.452	0-0 3B		0-0 F3		0-0 1B			0-0 G3		4 0 2 0 0 0 1	
Monte Irvin, R (1, 7) OBP: 0.331, SLG: 0.477	0-0 6-3			0-0 F8		0-0 1B		0-0 4-3		4 0 1 1 0 0 1	
Don Mueller, L (1, 9) OBP: 0.383, SLG: 0.472		0-0 1B		0-0 2B		0-0 FC6		0-0 4-3		4 1 2 0 0 0 2	
Willie Mays, R (1, 8) OBP: 0.379, SLG: 0.690		0-0 F7		0-0 E9		0-0 P3		0-0 F7		4 1 1 0 0 0 1	
Ray Katt, R (1, 2) OBP: 0.355, SLG: 0.365		0-0 F8		0-0 SF9		0-0 F2		0-0 5-3		3 0 0 1 0 0 1	
Billy Gardner, R (1, 5) OBP: 0.345, SLG: 0.519		0-3 K		0-0 5-3		0-0 F8		0-0 F7		4 0 0 0 0 1 1	
Johnny Antonelli, L (1, 1) Hoyt Wilhelm, R (6, 1) OBP: 0.226, SLG: 0.300			0-0 F7		0-0 F8		0-0 4-3			2 0 0 0 0 0 0 1 0 0 0 0 0 0	
<b>Inning Stats</b>	R: 0 E: 0 K: 0 S: 4 H: 1 LOB: 1 BB: 0 P: 4	R: 0 E: 0 K: 1 S: 6 H: 1 LOB: 1 BB: 0 P: 6	R: 0 E: 0 K: 0 S: 3 H: 0 LOB: 1 BB: 1 P: 7	R: 2 E: 1 K: 0 S: 5 H: 2 LOB: 0 BB: 0 P: 5	R: 1 E: 0 K: 0 S: 6 H: 3 LOB: 2 BB: 0 P: 6	R: 0 E: 0 K: 0 S: 3 H: 0 LOB: 0 BB: 0 P: 3	R: 0 E: 0 K: 0 S: 3 H: 0 LOB: 0 BB: 0 P: 3	R: 0 E: 0 K: 0 S: 3 H: 0 LOB: 0 BB: 0 P: 3	R: 0 E: 0 K: 0 S: 3 H: 0 LOB: 0 BB: 0 P: 3	1B: 5 2B: 1 3B: 1 HR: 0 SF: 1 SAC: 0 DP: 0 HBP: 0	WP: 0 PB: 0 SB: 0 CS: 0 PA: 35
<b>PITCHER</b> Vern Law, R (1, 1) ERA: 3.47	IP: 9.0 WLS: W BF: 35 H: 7 R: 3 ER: 2 SO: 1 BB: 1 IBB: 0 HBP: 0 BLK: 0 WP: 0 HR: 0 S: 36 P: 40 ERA: 2.00 WHIP: 0.889										

**New York Giants @ Pittsburgh Pirates**  
 Forbes Field, Pittsburgh, PA  
 Mon May 31 1954, 3:38 AM EDT  
 Att: 10,506 - Unknown

[livebaseballscorecards.com](http://livebaseballscorecards.com)

**AB** 33  
**R** 3  
**H** 7  
**RBI** 2  
**BB** 1  
**SO** 1  
**LOB** 8





Batter	1	2	3	4	5	6	7	8	9	AB R H RBI BB SO LOB	TOP																
Whitey Lockman, L (1, 3) OBP: 0.317, SLG: 0.441	0-0 F7		4-0 HR BB		0-0 F7	0-0 P6		0-0 G3		4 1 0 0 1 0 2																	
Alvin Dark, R (1, 6) OBP: 0.282, SLG: 0.394	0-0 HR 1B		4-0 HR BB		0-0 HR 1B		0-0 F9 HR 2B	0-0 1B 2B		4 5 4 0 1 0 0																	
Hank Thompson, L (1, 5) OBP: 0.416, SLG: 0.533	0-0 HR		0-0 HR		0-0 HR		4-0 HR IBB	0-0 FC5-4 1B		4 4 4 8 1 0 0																	
Monte Irvin, R (1, 7) OBP: 0.322, SLG: 0.461	0-0 F9		0-0 F8		0-0 F7		0-0 F9	0-0 FC5-4		5 0 0 0 0 0 3																	
Don Mueller, L (1, 9) OBP: 0.384, SLG: 0.470	0-0 1B		0-0 F9		0-0 4-3		0-0 F5		0-0 HR 1B	5 1 2 0 0 0 2																	
Willie Mays, R (1, 8) OBP: 0.385, SLG: 0.730	0-0 F7		0-0 5-3			0-0 2B	0-0 HR	0-0 HR		5 2 3 5 0 0 1																	
Ray Katt, R (1, 2) OBP: 0.343, SLG: 0.339		0-0 F2		0-0 6-3		0-3 K	4-0 FC6-4 BB	0-0 P4		4 0 0 0 1 1 1																	
Davey Williams, R (1, 4) OBP: 0.235, SLG: 0.281		0-0 5-3		0-0 5-3		0-0 1B	0-0 FC6-4	0-0 P4		5 0 1 0 0 0 1																	
Sal Maglie, R (1, 1) OBP: 0.080, SLG: 0.042		0-0 6-3		0-0 4-3		0-0 F2		0-0 1-3	0-0 6-3	1 0 0 0 0 0 0																	
Windy McCall, L (2, 1)										1 0 0 0 0 0 0																	
Marv Grissom, R (4, 1)										3 0 0 0 0 0 2																	
<b>Inning Stats</b>	R: 2 E: 1 K: 0 S: 6	H: 3 LOB: 1 BB: 0 P: 6	R: 0 E: 0 K: 0 S: 3	H: 0 LOB: 0 BB: 0 P: 3	R: 3 E: 0 K: 0 S: 4	H: 1 LOB: 0 BB: 2 P: 12	R: 0 E: 0 K: 0 S: 3	H: 0 LOB: 0 BB: 0 P: 3	R: 2 E: 0 K: 0 S: 5	H: 2 LOB: 0 BB: 0 P: 5	R: 0 E: 0 K: 1 S: 7	H: 2 LOB: 2 BB: 0 P: 7	R: 3 E: 0 K: 0 S: 5	H: 2 LOB: 1 BB: 2 P: 13	R: 1 E: 0 K: 0 S: 5	H: 2 LOB: 1 BB: 0 P: 5	R: 2 E: 0 K: 0 S: 5	H: 2 LOB: 0 BB: 0 P: 5	1B: 6 2B: 3 3B: 0 HR: 5	SF: 0 SAC: 0 DP: 0 HBP: 0	WP: 0 PB: 0 SB: 0 CS: 0	PA: 45					
<b>PITCHER</b>	IP WLS BF H R ER SO BB IBB HBP BLK WP HR S P ERA WHIP																										
Gerry Staley, R (1, 1) ERA: 6.91	5.0		23	6	7	6	0	2	0	0	0	0	3	21	29	10.80	1.600										
Joe Presko, R (6, 1) ERA: 5.52	2.0	L	12	4	3	3	1	1	1	0	0	0	1	12	20	13.50	2.500										
Al Brazle, L (8, 1) ERA: 5.46	2.0		10	4	3	3	0	0	0	0	0	0	1	10	10	13.50	2.000										

**New York Giants @ St. Louis Cardinals**  
 Sportsman's Park, St. Louis, MO  
 Thu Jun 03 1954, 4:33 AM EDT  
 Att. 7,694 - Unknown

[livebaseballscorecards.com](http://livebaseballscorecards.com)

<b>AB</b>	41
<b>R</b>	13
<b>H</b>	14
<b>RBI</b>	13
<b>BB</b>	4
<b>SO</b>	1
<b>LOB</b>	12



Batter	1	2	3	4	5	6	7	8	9	AB	R	H	RBI	BB	SO	LOB
Wally Moon, L OBP: 0.411, SLG: 0.489 (1, 8)	0-0 3B 1B	0-0 4-3 HR 2B		0-0 F5		4-0 FC1-4 SH1-3 BB	0-3 K		0-0 1B	5	2	3	2	1	1	2
Red Schoendienst, S OBP: 0.366, SLG: 0.469 (1, 4)	0-0 4-3 3B	0-0 4-3 2B		0-0 1B 3B		0-0 SH1-3		4-0 1B BB	0-0 F5	4	3	2	1	1	0	3
Stan Musial, L OBP: 0.481, SLG: 0.743 (1, 9)	0-0 4-3	0-0 HR		4-0 1B BB		4-0 FC1-4 IBB		0-0 1B 1B	0-0 L6	4	1	2	3	2	0	2
Ray Jablonski, R OBP: 0.427, SLG: 0.574 (1, 5)	0-3 K	0-0 1B		0-0 1B		0-0 FC1-4		0-0 FC6-4 1B		5	0	3	2	0	1	2
Tom Alston, L OBP: 0.348, SLG: 0.422 (1, 3)	0-0 E1	0-0 F8		0-3 K		0-0 P4		0-0 F8		5	0	0	0	0	1	7
Rip Repulski, R OBP: 0.310, SLG: 0.391 (1, 7)	0-0 G3		0-3 K	0-0 F7			0-3 K	0-0 L4		5	0	0	0	0	2	5
Alex Grammas, R OBP: 0.325, SLG: 0.330 (1, 6)		0-3 K	0-0 6-3		0-0 4-3		4-0 BB BB	0-0 FC6-4		3	0	0	0	0	1	0
Solly Hemus, L OBP: 0.451, SLG: 0.435 (7, PH) (8, 6)								1-2		1	0	0	0	1	0	2
Bill Sarni, R OBP: 0.444, SLG: 0.480 (1, 2)		0-0 2B 2B	0-0 2B		0-0 5-3		0-3 K		0-0 1B 1B	5	1	3	0	0	1	1
Gerry Staley, R OBP: 0.235, SLG: 0.071 (1, 1)		4-0 2B BB	0-3 K		0-0 6-3		4-0 1-2 BB		0-3 K	1	1	0	0	0	1	1
Tom Burgess, L OBP: 0.395, SLG: 0.429 (5, PH)										1	0	0	0	0	0	0
Joe Presko, R OBP: 0.324, SLG: 0.355 (6, 1)										0	0	0	0	0	0	0
Joe Frazier, L OBP: 0.324, SLG: 0.355 (7, PH)										0	0	0	0	1	0	0
Harvey Haddix, L OBP: 0.217, SLG: 0.250 (7, PR)										0	0	0	0	0	0	0
Al Brazle, L (8, 1)										0	0	0	0	0	0	0
Peanuts Lowrey, R (9, PH)										1	0	0	0	0	1	1

Inning Stats	R: 2	H: 2	E: 1	LOB: 1	K: 1	BB: 0	S: 8	R: 4	H: 4	E: 0	LOB: 1	K: 1	BB: 1	S: 9	R: 0	H: 1	E: 0	LOB: 1	K: 2	BB: 0	S: 8	R: 1	H: 2	E: 0	LOB: 2	K: 1	BB: 1	S: 7	R: 0	H: 0	E: 0	LOB: 0	K: 0	BB: 0	S: 3	R: 0	H: 0	E: 0	LOB: 2	K: 3	BB: 2	S: 9	R: 1	H: 2	E: 0	LOB: 2	K: 0	BB: 1	S: 5	R: 0	H: 2	E: 0	LOB: 2	K: 1	BB: 0	S: 7	1B: 7	2B: 3	3B: 2	HR: 1	SF: 0	SAC: 1	DP: 0	HBP: 0	WP: 0	PA: 48
--------------	------	------	------	--------	------	-------	------	------	------	------	--------	------	-------	------	------	------	------	--------	------	-------	------	------	------	------	--------	------	-------	------	------	------	------	--------	------	-------	------	------	------	------	--------	------	-------	------	------	------	------	--------	------	-------	------	------	------	------	--------	------	-------	------	-------	-------	-------	-------	-------	--------	-------	--------	-------	--------

PITCHER	IP	WLS	BF	H	R	ER	SO	BB	IBB	HBP	BLK	WP	HR	S	P	ERA	WHIP
Sal Maglie, R ERA: 3.58 (1, 1)	1.2		12	5	6	6	2	1	0	0	0	0	1	15	19	32.40	3.600
Windy McCall, L ERA: 2.7 (2, 1)	1.2		9	3	1	1	2	1	0	0	0	0	0	12	16	5.40	2.400
Mary Grissom, R ERA: 1.77 (4, 1)	5.2	W	27	5	1	1	5	4	1	0	0	0	0	32	52	1.59	1.588

**BOTTOM**

**New York Giants @ St. Louis Cardinals**  
 Sportsman's Park, St. Louis, MO

Thu Jun 03 1954, 4:33 AM EDT  
 Att. 7,694 - Unknown

livebaseballscorecards.com

<b>AB</b>	<b>40</b>
<b>R</b>	<b>8</b>
<b>H</b>	<b>13</b>
<b>RBI</b>	<b>8</b>
<b>BB</b>	<b>7</b>
<b>SO</b>	<b>9</b>
<b>LOB</b>	<b>26</b>



Batter	1	2	3	4	5	6	7	8	9	AB	R	H	RBI	BB	SO	LOB	TOP					
Whitey Lockman, L (1, 3) OBP: 0.314, SLG: 0.434	0-0 E4 1B 1B	0-0 1-2 2-H 1B		0-0 P4		0-0 F5		0-0 P6		5	1	1	1	0	0	0						
Alvin Dark, R (1, 6) OBP: 0.295, SLG: 0.405	0-0 1B 6-3 1B	0-0 1-3 2-H 1B		0-3 K			0-0 SH1 2B 1B		0-0 1B FC6-4 1B	5	3	4	1	0	1	0						
Hank Thompson, L (1, 5) OBP: 0.418, SLG: 0.532	0-0 1-3 3-H 1B	0-0 P6			0-0 F9		0-0 SH1 1-2		0-0 1-3 FC6-4 1B	4	0	2	1	0	0	2						
Monte Irvin, R (1, 7) OBP: 0.324, SLG: 0.462	0-0 P4	0-0 F7			4-0 1B BB		0-0 1B 2B		0-0 1-2f 3-H FC6-4 2B SF8	4	2	1	2	1	0	5						
Don Mueller, L (1, 9) OBP: 0.390, SLG: 0.479	0-0 6-3 1-2 3-H		0-0 4-3		0-0 1-2 1B		0-0 2-H 1B		0-0 1-3 SF8 1B 2B	5	1	3	2	0	0	1						
Willie Mays, R (1, 8) OBP: 0.386, SLG: 0.717	0-0 F2		0-0 P3		0-0 F8		4-0 G6-4-3 IBB		4-0 SF8 1B IBB	3	1	0	0	2	0	3						
Ray Katt, R (1, 2) OBP: 0.352, SLG: 0.339					0-0 F9		0-0 G6-4-3		0-0 SF8	3	0	1	0	1	0	4						
Bill Taylor, L (9, PH) OBP: 0.286, SLG: 0.250									1-2 2-3 3-H	0	0	0	1	0	0	0						
Wes Westrum, R (9, 2) OBP: 0.293, SLG: 0.212										0	0	0	0	0	0	0						
Davey Williams, R (1, 4) OBP: 0.234, SLG: 0.278		0-0 FC6-4 1B 1-2f	0-0 FC5-4 1B 1-2f		0-0 5-3		0-3 K		0-0 2-H 3-H FC7-4 1B	5	1	1	2	0	1	2						
Ruben Gomez, R (1, 1) OBP: 0.292, SLG: 0.292		0-0 1B 1-2		0-0 5-3		0-0 1-3		0-3 K	0-0 1-2f	5	1	1	0	0	1	1						
Hoyt Wilhelm, R (9, 1)										0	0	0	0	0	0	0						
<b>Inning Stats</b>	R: 2 E: 1 K: 0 S: 6	H: 2 LOB: 1 BB: 0 P: 6	R: 2 E: 0 K: 0 S: 6	H: 3 LOB: 2 BB: 1 P: 10	R: 0 E: 0 K: 0 S: 4	H: 1 LOB: 1 BB: 0 P: 4	R: 0 E: 0 K: 1 S: 5	H: 0 LOB: 0 BB: 0 P: 5	R: 0 E: 0 K: 0 S: 4	H: 1 LOB: 2 BB: 1 P: 8	R: 0 E: 0 K: 0 S: 3	H: 0 LOB: 0 BB: 0 P: 3	R: 2 E: 0 K: 0 S: 5	H: 3 LOB: 1 BB: 1 P: 9	R: 0 E: 0 K: 2 S: 7	H: 0 LOB: 0 BB: 0 P: 7	R: 4 E: 0 K: 0 S: 7	H: 4 LOB: 1 BB: 1 P: 11	1B: 12 2B: 2 3B: 0 HR: 0	SF: 1 SAC: 1 DP: 1 HBP: 0	WP: 0 PB: 0 SB: 0 CS: 0	PA: 45
<b>PITCHER</b>	IP	WLS	BF	H	R	ER	SO	BB	IBB	HBP	BLK	WP	HR	S	P	ERA	WHIP					
Bud Podbielan, R (1, 1) ERA: 5.84	1.1	L	11	5	4	2	0	1	0	0	0	0	0	10	14	13.50	4.500					
Joe Nuxhall, L (2, 1) ERA: 4.03	5.2		23	5	2	2	1	1	1	0	0	0	0	23	31	3.18	1.059					
Herm Wehmeier, R (8, 1) ERA: 5.73	1.1		8	3	4	4	2	0	1	0	0	0	0	11	15	27.00	2.250					
Frank Smith, R (9, 1) ERA: 0.78	0.2		3	1	0	0	0	0	0	0	0	0	0	3	3	0.00	1.500					

New York Giants @ Cincinnati Redlegs  
Crosley Field, Cincinnati, OH

livebaseballscorecards.com

AB	39
R	10
H	14
RBI	10
BB	4
SO	3
LOB	18



Fri Jun 04 1954, 3:33 AM EDT  
Att. 6,815 - Unknown



**BOTTOM**

**New York Giants @ Cincinnati Redlegs**

Crosley Field, Cincinnati, OH

Fri Jun 04 1954, 3:33 AM EDT  
Att. 6,815 - Unknown

livebaseballscorecards.com

<b>AB</b>	<b>35</b>
<b>R</b>	<b>6</b>
<b>H</b>	<b>8</b>
<b>RBI</b>	<b>6</b>
<b>BB</b>	<b>5</b>
<b>SO</b>	<b>2</b>
<b>LOB</b>	<b>21</b>

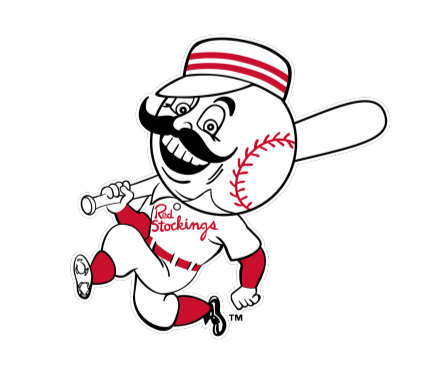

WP: 0	PA: 41
PB: 0	
SB: 0	
CS: 0	

AB R H RBI BB SO LOB

4 0 0 0 0 0 4  
3 1 1 0 0 0 1  
0 1 0 0 1 0 0  
0 0 0 0 0 0 0  
1 0 0 0 0 0 2

4 1 2 0 1 0 1

5 0 1 1 0 0 5

5 0 0 1 0 1 6

4 0 1 2 0 1 1

3 1 0 0 1 0 1

4 2 2 2 0 0 0

0 0 0 0 0 0 0  
2 0 1 0 0 0 0  
0 0 0 0 1 0 0  
0 0 0 0 0 0 0  
0 0 0 0 0 0 0  
0 0 0 0 1 0 0

1B: 6 SF: 0  
2B: 0 SAC: 0  
3B: 1 DP: 0  
HR: 1 HBP: 1

WP: 0 HR: 1 S: 5 P: 7 ERA: 6.75 WHIP: 1.375

WP: 0 HR: 0 S: 2 P: 4 ERA: 0.00 WHIP: 2.000

Batter	1	2	3	4	5	6	7	8	9
<b>Bobby Adams, R</b> (1, 5) OBP: 0.337, SLG: 0.312	1-0 FC6-4 HBP		0-0 4-3		0-0 FC5-4 1-2f		0-0 6-3		0-0 F7
<b>Roy McMillan, R</b> (1, 6) OBP: 0.298, SLG: 0.256	0-0 FC6-4		0-0 5-3			0-0 G3 BB F7 1B		4-0 G3 1B 3B BB	0-0 F8
<b>Lloyd Merriman, L</b> (8, PH) OBP: 0.286, SLG: 0.290									
<b>Rocky Bridges, R</b> (9, 6) OBP: 0.500, SLG: 0.600									
<b>Bob Borkowski, R</b> (9, PH) OBP: 0.308, SLG: 0.417	1-2f								
<b>Gus Bell, L</b> (1, 8) OBP: 0.359, SLG: 0.475	0-0 L8		0-0 4-3			4-0 G3 BB 1-2		0-0 G3 1B 3B	0-0 FC5 1B 1B
<b>Ted Kluszewski, L</b> (1, 3) OBP: 0.383, SLG: 0.625	0-0 F8			0-0 4-3		0-0 G3		0-0 G3	0-0 1B
<b>Wally Post, R</b> (1, 9) OBP: 0.271, SLG: 0.466		0-3 K		0-0 5-3		0-0 F7		0-0 P6	0-0 FC5
<b>Johnny Temple, R</b> (1, 4) OBP: 0.398, SLG: 0.380		0-3 K		0-0 P4		0-0 6-3		0-0 3B	
<b>Jim Greengrass, R</b> (1, 7) OBP: 0.276, SLG: 0.407		4-0 BB HR			0-0 6-3		0-0 5-3	0-0 F9	
<b>Hobie Landrith, L</b> (1, 2) OBP: 0.389, SLG: 0.536		0-0 HR		0-0 F7		0-0 F8			0-0 1B BB 1B
<b>Bud Podbielan, R</b> (1, 1) OBP: 0.417, SLG: 0.300		0-0 1-3			0-0 FC5-4 1B		4-0 BB		4-0 1B 1B BB
<b>Joe Nuxhall, L</b> (2, 1) OBP: 0.566, SLG: 0.429									
<b>Nino Escalera, L</b> (7, PH) OBP: 0.333, SLG: 0.208									
<b>Herm Wehmeier, R</b> (8, 1) OBP: 0.333, SLG: 0.208									
<b>Frank Smith, R</b> (9, 1) OBP: 0.275, SLG: 0.271									

Inning Stats	R: 0 H: 0 E: 0 K: 3 S: 3	H: 0 LOB: 1 BB: 0 P: 4	R: 2 H: 1 E: 0 K: 2 S: 8	H: 1 LOB: 0 BB: 1 P: 12	R: 0 H: 0 E: 0 K: 3 S: 3	H: 0 LOB: 0 BB: 0 P: 3	R: 0 H: 0 E: 0 K: 3 S: 3	H: 0 LOB: 0 BB: 0 P: 3	R: 0 H: 1 E: 0 K: 4 S: 4	H: 1 LOB: 1 BB: 0 P: 4	R: 1 H: 1 E: 0 K: 4 S: 4	H: 1 LOB: 1 BB: 1 P: 8	R: 0 H: 0 E: 0 K: 3 S: 3	H: 0 LOB: 1 BB: 1 P: 7	R: 2 H: 2 E: 0 K: 5 S: 5	H: 2 LOB: 1 BB: 1 P: 9	R: 1 H: 3 E: 0 K: 6 S: 6	H: 3 LOB: 3 BB: 1 P: 10	1B: 6 2B: 0 3B: 1 HR: 1	SF: 0 SAC: 0 DP: 0 HBP: 1
--------------	--------------------------	------------------------	--------------------------	-------------------------	--------------------------	------------------------	--------------------------	------------------------	--------------------------	------------------------	--------------------------	------------------------	--------------------------	------------------------	--------------------------	------------------------	--------------------------	-------------------------	-------------------------	---------------------------

PITCHER	<b>Ruben Gomez, R</b> (1, 1) ERA: 3.36	IP: 8.0 WLS: W BF: 36 H: 6 R: 6 ER: 6 SO: 2 BB: 5 IBB: 0 HBP: 1 BLK: 0 WP: 0 HR: 1 S: 34 P: 55 ERA: 6.75 WHIP: 1.375
PITCHER	<b>Hoyt Wilhelm, R</b> (9, 1) ERA: 2.29	IP: 1.0 WLS: S BF: 5 H: 2 R: 0 ER: 0 SO: 0 BB: 0 IBB: 0 HBP: 0 BLK: 0 WP: 0 HR: 0 S: 5 P: 5 ERA: 0.00 WHIP: 2.000

PITCHER	<b>Ruben Gomez, R</b> (1, 1) ERA: 3.36	IP: 8.0 WLS: W BF: 36 H: 6 R: 6 ER: 6 SO: 2 BB: 5 IBB: 0 HBP: 1 BLK: 0 WP: 0 HR: 1 S: 34 P: 55 ERA: 6.75 WHIP: 1.375
PITCHER	<b>Hoyt Wilhelm, R</b> (9, 1) ERA: 2.29	IP: 1.0 WLS: S BF: 5 H: 2 R: 0 ER: 0 SO: 0 BB: 0 IBB: 0 HBP: 0 BLK: 0 WP: 0 HR: 0 S: 5 P: 5 ERA: 0.00 WHIP: 2.000

Batter	1	2	3	4	5	6	7	8	9	AB R H RBI BB SO LOB	TOP											
Whitey Lockman, L (1, 3) OBP: 0.316, SLG: 0.433	0-3 K		0-0 L6		0-0 1B 1B	0-0 G3			0-0 G6-4-3 1B	5 1 2 0 0 1 0												
Alvin Dark, R (1, 6) OBP: 0.308, SLG: 0.415	4-0 HR BB		0-0 FC6-5 2B		0-0 1B 1B		1-0 G6-4-3 HBP		0-0 G6-4-3 1-2f	3 2 2 1 1 0 1												
Hank Thompson, L (1, 5) OBP: 0.423, SLG: 0.557	0-0 HR		0-0 FC6-5 2-3		0-0 1B SF8 1B		0-0 G6-4-3 1B		0-0 G3	5 2 3 4 0 0 1												
Monte Irvin, R (1, 7) OBP: 0.328, SLG: 0.460	4-0 1B BB		0-0 P6		0-0 1B BB 1B		0-0 G6-4-3 1-2f 2-3			3 0 1 1 1 0 3												
Don Mueller, L (1, 9) OBP: 0.387, SLG: 0.477	0-0 G4-6-3 1B			0-0 P6	0-0 SF8		0-0 6-3			3 0 1 1 0 0 1												
Willie Mays, R (1, 8) OBP: 0.383, SLG: 0.704	0-0 G4-6-3 1-2f			0-0 5-3	4-0 FC6-4 BB			0-3 K		3 0 0 0 1 1 2												
Ray Katt, R (1, 2) OBP: 0.347, SLG: 0.333		0-0 3-1		0-0 F7	0-0 FC6-4 1-2f			0-0 1B 1B		4 0 1 0 0 0 1												
Davey Williams, R (1, 4) OBP: 0.240, SLG: 0.280		0-0 F9			4-0 1B E 1B BB	0-0 P6		0-0 G4-6-3 1B		3 1 1 0 1 0 0												
Johnny Antonelli, L (1, 1) OBP: 0.200, SLG: 0.265		0-3 K			0-0 FC1 1B 1B	0-3 K		0-0 G4-6-3 1-2f		4 1 0 0 0 2 3												
<b>Inning Stats</b>	R: 2 E: 0 K: 1 S: 6	H: 2 LOB: 1 BB: 2 P: 14	R: 0 E: 0 K: 1 S: 5	H: 0 LOB: 0 BB: 0 P: 5	R: 0 E: 0 K: 0 S: 4	H: 1 LOB: 1 BB: 0 P: 4	R: 0 E: 0 K: 0 S: 3	H: 0 LOB: 0 BB: 0 P: 3	R: 5 E: 1 K: 0 S: 7	H: 4 LOB: 1 BB: 2 P: 15	R: 0 E: 0 K: 1 S: 5	H: 0 LOB: 0 BB: 0 P: 5	R: 0 E: 0 K: 0 S: 3	H: 1 LOB: 1 BB: 0 P: 4	R: 0 E: 0 K: 1 S: 6	H: 2 LOB: 1 BB: 0 P: 6	R: 0 E: 0 K: 0 S: 3	H: 1 LOB: 0 BB: 0 P: 3	1B: 9 2B: 1 3B: 0 HR: 1	SF: 1 SAC: 0 DP: 4 HBP: 1	WP: 0 PB: 0 SB: 0 CS: 0	PA: 39
<b>PITCHER</b>	IP WLS BF H R ER SO BB IBB HBP BLK WP HR S P ERA WHIP																					
Harry Perkowski, L (1, 1) ERA: 7.28	4.0 L 21 6 7 6 2 3 0 0 0 0 0 1 22 34 13.50 2.250																					
Howie Judson, R (5, 1) ERA: 3.74	4.0 15 4 0 0 2 1 0 1 0 0 0 0 17 22 0.00 1.250																					
Moe Savransky, L (9, 1) ERA:	1.0 3 1 0 0 0 0 0 0 0 0 0 0 3 3 0.00 1.000																					

**New York Giants @ Cincinnati Redlegs**  
 Crosley Field, Cincinnati, OH  
 Sat Jun 05 1954, 3:33 AM EDT  
 Att. 4,531 - Unknown

[livebaseballscorecards.com](http://livebaseballscorecards.com)

<b>AB</b>	33
<b>R</b>	7
<b>H</b>	11
<b>RBI</b>	7
<b>BB</b>	4
<b>SO</b>	4
<b>LOB</b>	12





Batter	1	2	3	4	5	6	7	8	9	AB R H RBI BB SO LOB	TOP																									
Whitey Lockman, L (1, 3) OBP: 0.313, SLG: 0.426	0-0 1B 1B		0-0 F8		0-0 L6		0-0 4-3		0-0 1-3	5 0 1 0 0 0 2																										
Alvin Dark, R (1, 6) OBP: 0.307, SLG: 0.411	0-0 P4		0-0 1B			0-3 K		0-0 1-3		4 0 1 0 0 0 1																										
Hank Thompson, L (1, 5) OBP: 0.419, SLG: 0.548	0-0 FC5-4 1-3 1B		0-0 L8			0-0 F7		0-0 F2		4 0 1 0 0 0 1																										
Monte Irvin, R (1, 7) OBP: 0.332, SLG: 0.476	4-0 FC5-4 1-2 BB				0-0 F9		0-0 6-3		0-0 HR	3 1 1 1 1 0 0																										
Don Mueller, L (1, 9) OBP: 0.389, SLG: 0.474	0-0 FC5-4 1-2 2-3				0-0 1B		0-0 L6		4-0 BB	3 0 1 0 1 0 3																										
Willie Mays, R (1, 8) OBP: 0.375, SLG: 0.688		0-3 K			0-0 F8		0-0 P3		0-3 K	4 0 0 0 0 2 2																										
Ray Katt, R (1, 2) OBP: 0.338, SLG: 0.323		0-3 K			0-3 K		0-0 1B 2B		0-0 SH1-4 2B	2 0 0 0 0 2 1	AB 34																									
Bill Taylor, L (7, PH) OBP: 0.333, SLG: 0.385										1 0 1 0 0 0 0	R 3																									
Billy Gardner, R (7, PR) OBP: 0.367, SLG: 0.571										1 1 1 0 0 0 0	H 9																									
Davey Williams, R (1, 4) OBP: 0.237, SLG: 0.276		0-0 5-3					0-0 P6		0-0 SH1-4	2 0 0 0 0 0 0	RBI 3																									
Dusty Rhodes, L (7, PH) OBP: 0.467, SLG: 0.385									2-3	1 1 1 1 0 0 0	BB 2																									
Wes Westrum, R (7, 2) OBP: 0.293, SLG: 0.212							2-H 2B 1B			0 0 0 0 0 0 0	SO 7																									
Jim Hearn, R (1, 1) OBP: 0.200, SLG: 0.600			0-0 5-3				0-0 K		0-3 K	3 0 1 1 0 1 0	LOB 11																									
Marv Grissom, R (7, 1)							2-H 2B			1 0 0 0 0 1 1																										
<b>Inning Stats</b>	R: 0 E: 0 K: 0 S: 4	H: 2 LOB: 2 BB: 1 P: 8	R: 0 E: 0 K: 2 S: 7	H: 0 LOB: 0 BB: 0 P: 7	R: 0 E: 0 K: 0 S: 4	H: 1 LOB: 1 BB: 0 P: 4	R: 0 E: 0 K: 1 S: 6	H: 1 LOB: 1 BB: 0 P: 6	R: 0 E: 0 K: 1 S: 5	H: 0 LOB: 0 BB: 0 P: 5	R: 2 E: 0 K: 0 S: 6	H: 3 LOB: 1 BB: 0 P: 6	R: 1 E: 0 K: 1 S: 6	H: 1 LOB: 1 BB: 1 P: 10	R: 0 E: 0 K: 1 S: 6	H: 1 LOB: 1 BB: 0 P: 6	1B: 5 2B: 3 3B: 0 HR: 1	SF: 0 SAC: 1 DP: 1 HBP: 0	WP: 0 PB: 0 SB: 0 CS: 0	PA: 37																
<b>PITCHER</b>	IP WLS BF H R ER SO BB IBB HBP BLK WP HR S P ERA WHIP																																			
Art Fowler, R (1, 1) ERA: 3.09	7.0	28	7	2	2	5	1	0	0	0	0	0	0	37	41	2.57	1.143																			
Frank Smith, R (8, 1) ERA: 1.08	2.0	L	9	2	1	1	2	1	0	0	0	0	1	12	16	4.50	1.500																			

**New York Giants @ Cincinnati Redlegs**  
 Crosley Field, Cincinnati, OH  
 Sun Jun 06 1954, 3:33 AM EDT  
 Unknown

livebaseballscorecards.com





Batter	1	2	3	4	5	6	7	8	9	AB R H RBI BB SO LOB	TOP											
Whitey Lockman, L (1, 3) OBP: 0.312, SLG: 0.422	0-0 F7		0-3 K			0-0 1B	0-0 F8			4 0 1 0 0 1 3												
Alvin Dark, R (1, 6) OBP: 0.301, SLG: 0.403	0-0 F9		0-0 P6			0-0 F7		0-3 K		4 0 0 0 0 1 3												
Hank Thompson, L (1, 5) OBP: 0.409, SLG: 0.532	0-0 P3		0-0 4-3			0-3 K		0-0 F8		4 0 0 0 0 1 3												
Monte Irvin, R (1, 7) OBP: 0.330, SLG: 0.470		0-0 3-1		0-0 1B		0-0 4-3		0-0 L4		4 0 1 0 0 0 1												
Don Mueller, L (1, 9) OBP: 0.397, SLG: 0.480		0-3 K		0-0 1B	G5-4-3		0-0 1B	0-0 FC1-5	E	4 1 3 0 0 1 0												
Willie Mays, R (1, 8) OBP: 0.378, SLG: 0.684		0-0 1B		0-0 1B	G5-4-3		0-0 1B	0-0 FC1-5	1-3	4 1 2 0 0 0 2												
Wes Westrum, R (1, 2) OBP: 0.279, SLG: 0.200		0-0 F2				0-3 K		0-0 F7		2 0 0 0 0 1 1												
Bobby Hofman, R (7, PH) OBP: 0.120, SLG: 0.400								0-0 F7		1 0 1 1 0 0 0												
Ruben Gomez, R (7, PR) OBP: 0.292, SLG: 0.292								0-0 F7		0 0 0 0 0 0 0												
Ray Katt, R (7, 2) OBP: 0.333, SLG: 0.318								0-0 F7		1 0 0 0 0 0 1												
Davey Williams, R (1, 4) OBP: 0.238, SLG: 0.277			0-0 SH		0-3 K		0-0 SF7	0-0 F8		3 0 1 1 0 1 1												
Don Liddle, L (1, 1)			0-0 SH		0-0 L6		0-0 K			2 0 0 0 0 1 1												
Larry Jansen, R (9, 1) OBP: 0.364, SLG: 0.455			1-2							0 0 0 0 0 0 0												
<b>Inning Stats</b>	R: 0 E: 0 K: 0 S: 3	H: 0 LOB: 0 BB: 0 P: 3	R: 0 E: 0 K: 1 S: 6	H: 1 LOB: 1 BB: 0 P: 6	R: 0 E: 0 K: 1 S: 7	H: 1 LOB: 2 BB: 0 P: 7	R: 0 E: 0 K: 0 S: 3	H: 2 LOB: 0 BB: 0 P: 3	R: 0 E: 0 K: 2 S: 7	H: 0 LOB: 0 BB: 0 P: 7	R: 0 E: 0 K: 1 S: 6	H: 1 LOB: 1 BB: 0 P: 6	R: 2 E: 0 K: 1 S: 8	H: 3 LOB: 1 BB: 0 P: 8	R: 0 E: 0 K: 1 S: 5	H: 0 LOB: 0 BB: 0 P: 5	R: 0 E: 1 K: 0 S: 4	H: 1 LOB: 1 BB: 0 P: 4	1B: 8 2B: 1 3B: 0 HR: 0	SF: 1 SAC: 1 DP: 1 HBP: 0	WP: 0 PB: 0 SB: 0 CS: 0	PA: 35
<b>PITCHER</b> Fred Baczewski, L (1, 1) ERA: 5.68	IP: 9.0 WLS: W BF: 35 H: 9 R: 2 ER: 2 SO: 7 BB: 0 IBB: 0 HBP: 0 BLK: 0 WP: 0 HR: 0 S: 49 P: 49 ERA: 2.00 WHIP: 1.000											<b>PITCHER</b>	IP: 9.0 WLS: W BF: 35 H: 9 R: 2 ER: 2 SO: 7 BB: 0 IBB: 0 HBP: 0 BLK: 0 WP: 0 HR: 0 S: 49 P: 49 ERA: 2.00 WHIP: 1.000									

**New York Giants @ Cincinnati Redlegs**  
 Crosley Field, Cincinnati, OH  
 Sun Jun 06 1954, 3:38 AM EDT  
 Att: 19,105 - Unknown

livebaseballscorecards.com

<b>AB</b>	33
<b>R</b>	2
<b>H</b>	9
<b>RBI</b>	2
<b>BB</b>	0
<b>SO</b>	7
<b>LOB</b>	16





Batter	1	2	3	4	5	6	7	8	9	AB R H RBI BB SO LOB	TOP											
Whitey Lockman, L (1, 3) OBP: 0.314, SLG: 0.438	0-0 1B 1B	0-0 1-H HR		0-0 F8		0-0 G3			0-0 F7	5 2 2 2 0 0 1												
Alvin Dark, R (1, 6) OBP: 0.303, SLG: 0.400	0-0 F9	0-0 1B		0-0 L9			0-0 4-3		4-0 WP 2B BB	4 1 1 0 1 0 1												
Hank Thompson, L (1, 5) OBP: 0.409, SLG: 0.535	0-0 1B 1-3 1B	0-0 F9			0-0 4-3		0-0 1-3		0-0 1-H 2B	5 0 2 1 0 0 1												
Monte Irvin, R (1, 7) OBP: 0.337, SLG: 0.474	0-0 1-2 3-H 1B		0-0 S 1B		0-0 E 1B		0-0 6-3		0-0 P6	5 0 3 1 0 0 1												
Don Mueller, L (1, 9) OBP: 0.389, SLG: 0.470	0-0 P6		0-0 6-3		0-0 E6 G6-4-3			0-3 K		4 0 0 0 0 1 4												
Willie Mays, R (1, 8) OBP: 0.370, SLG: 0.669	0-3 K		0-0 5-3		0-0 G6-4-3 1-2f			0-0 F8		4 0 0 0 0 1 5												
Billy Gardner, R (1, 4) OBP: 0.382, SLG: 0.548		0-0 6-3	1-0 HBP		0-0 5-3			0-0 1B		3 0 1 0 0 0 0												
Wes Westrum, R (1, 2) OBP: 0.277, SLG: 0.205		0-0 HR 1B	0-3 K		0-3 K			0-0 P4		4 1 1 0 0 2 3												
Sal Maglie, R (1, 1) OBP: 0.107, SLG: 0.074		0-0 F3		0-0 L5		0-0 1B			0-3 K	3 0 1 0 0 0 1												
Marv Grissom, R (8, 1)										1 0 0 0 0 1 0												
<b>Inning Stats</b>	R: 1 E: 0 K: 1 S: 8	H: 3 LOB: 2 BB: 0 P: 8	R: 2 E: 0 K: 0 S: 6	H: 3 LOB: 1 BB: 0 P: 6	R: 0 E: 0 K: 1 S: 6	H: 1 LOB: 2 BB: 0 P: 7	R: 0 E: 0 K: 0 S: 3	H: 0 LOB: 0 BB: 0 P: 3	R: 0 E: 1 K: 0 S: 4	H: 1 LOB: 1 BB: 0 P: 4	R: 0 E: 0 K: 1 S: 6	H: 1 LOB: 1 BB: 0 P: 6	R: 0 E: 0 K: 0 S: 3	H: 0 LOB: 0 BB: 0 P: 3	R: 0 E: 0 K: 1 S: 6	H: 1 LOB: 1 BB: 0 P: 6	R: 1 E: 0 K: 1 S: 6	H: 1 LOB: 1 BB: 1 P: 10	1B: 9 2B: 1 3B: 0 HR: 1	SF: 0 SAC: 0 DP: 1 HBP: 1	WP: 1 PB: 0 SB: 1 CS: 0	PA: 40
<b>PITCHER</b>	IP WLS BF H R ER SO BB IBB HBP BLK WP HR S P ERA WHIP																				<b>PITCHER</b>	IP WLS BF H R ER SO BB IBB HBP BLK WP HR S P ERA WHIP
Lew Burdette, R (1, 1) ERA: 2.51	7.0 L 31 9 3 3 3 0 0 1 0 0 0 1 36 37 3.86 1.286																					
Ernie Johnson, R (8, 1) ERA: 3.16	2.0 9 2 1 1 2 1 0 0 0 1 0 12 16 4.50 1.500																					

New York Giants @ Milwaukee Braves  
Milwaukee County Stadium, Milwaukee, WI

Mon Jun 07 1954, 4:33 AM EDT  
Att: 31,071 - Unknown

AB	38
R	4
H	11
RBI	4
BB	1
SO	5
LOB	17





**BOTTOM**

**New York Giants @ Milwaukee Braves**  
 Milwaukee County Stadium, Milwaukee, WI

Mon Jun 07 1954, 4:33 AM EDT  
 Att. 31,071 - Unknown

livebaseballscores.com

<b>AB</b>	<b>36</b>
<b>R</b>	<b>2</b>
<b>H</b>	<b>9</b>
<b>RBI</b>	<b>2</b>
<b>BB</b>	<b>2</b>
<b>SO</b>	<b>6</b>
<b>LOB</b>	<b>21</b>



WP: 0	PA: 38
PB: 1	
SB: 1	
CS: 0	

Batter	1	2	3	4	5	6	7	8	9	AB	R	H	RBI	BB	SO	LOB
Bill Bruton, L (1, 8) OBP: 0.323, SLG: 0.295	0-0 E S 1B		0-0 B4-3			0-0 1B	0-0 1-2 2-3 1B		0-0 4-3	5	0	3	0	0	0	0
Johnny Logan, R (1, 6) OBP: 0.356, SLG: 0.438	0-3 K		0-0 L6			0-3 K	0-0 1-3		0-0 6-3	5	0	0	0	0	2	5
Eddie Mathews, L (1, 5) OBP: 0.413, SLG: 0.553	0-3 K 1-3		0-0 F2			0-0 F8		0-0 HR		4	1	1	1	0	1	2
Andy Pafko, R (1, 9) OBP: 0.350, SLG: 0.451	0-0 6-3			0-0 F9		0-0 4-3		0-0 FC4-6 1B		4	0	1	0	0	0	2
Joe Adcock, R (1, 3) OBP: 0.394, SLG: 0.515		4-0 BB BB BB BB	4-3 PB BB		0-0 P3		0-0 F8	0-0 FC4-6 1B 1-2f		3	0	0	0	1	0	1
Jim Pendleton, R (1, 7) OBP: 0.259, SLG: 0.296		0-0 L4		0-0 6-3		0-0 1B 1B	0-0 1B 1B	0-0 1-2 1B		4	1	2	0	0	0	1
Danny O'Connell, R (1, 4) OBP: 0.296, SLG: 0.307		4-0 BB BB BB	4-3 BB		0-3 K		0-0 1B 1B 1B	0-0 L4		3	0	1	0	1	1	2
Charlie White, L (1, 2) OBP: 0.333, SLG: 0.386		0-0 4-3		0-0 6-3		0-3 K		0-0 F8		4	0	0	0	0	1	6
Lew Burdette, R (1, 1) George Metkovich, L (7, PH) Ernie Johnson, R (8, 1) Hank Aaron, R (9, PH)		0-3 K		0-0 6-3		0-0 6-3		0-0 1B 1-2 2-H 1B	0-0 6-3	2	0	0	0	0	1	2

Batter	1	2	3	4	5	6	7	8	9
Bill Bruton, L (1, 8) OBP: 0.323, SLG: 0.295	0-0 E S 1B		0-0 B4-3			0-0 1B	0-0 1-2 2-3 1B		0-0 4-3
Johnny Logan, R (1, 6) OBP: 0.356, SLG: 0.438	0-3 K		0-0 L6			0-3 K	0-0 1-3		0-0 6-3
Eddie Mathews, L (1, 5) OBP: 0.413, SLG: 0.553	0-3 K 1-3		0-0 F2			0-0 F8		0-0 HR	
Andy Pafko, R (1, 9) OBP: 0.350, SLG: 0.451	0-0 6-3			0-0 F9		0-0 4-3		0-0 FC4-6 1B	
Joe Adcock, R (1, 3) OBP: 0.394, SLG: 0.515		4-0 BB BB BB BB	4-3 PB BB		0-0 P3		0-0 F8	0-0 FC4-6 1B 1-2f	
Jim Pendleton, R (1, 7) OBP: 0.259, SLG: 0.296		0-0 L4		0-0 6-3		0-0 1B 1B	0-0 1B 1B	0-0 1-2 1B	
Danny O'Connell, R (1, 4) OBP: 0.296, SLG: 0.307		4-0 BB BB BB	4-3 BB		0-3 K		0-0 1B 1B 1B	0-0 L4	
Charlie White, L (1, 2) OBP: 0.333, SLG: 0.386		0-0 4-3		0-0 6-3		0-3 K		0-0 F8	
Lew Burdette, R (1, 1) George Metkovich, L (7, PH) Ernie Johnson, R (8, 1) Hank Aaron, R (9, PH)		0-3 K		0-0 6-3		0-0 6-3		0-0 1B 1-2 2-H 1B	0-0 6-3

Inning Stats	R: 0 E: 0 K: 2 S: 8	H: 1 LOB: 1 BB: 0 P: 8	R: 0 E: 0 K: 1 S: 5	H: 0 LOB: 2 BB: 2 P: 13	R: 0 E: 0 K: 0 S: 3	H: 0 LOB: 0 BB: 0 P: 3	R: 0 E: 0 K: 1 S: 5	H: 0 LOB: 0 BB: 0 P: 5	R: 0 E: 0 K: 1 S: 6	H: 1 LOB: 1 BB: 0 P: 6	R: 1 E: 0 K: 1 S: 9	H: 4 LOB: 3 BB: 0 P: 9	R: 1 E: 0 K: 0 S: 6	H: 3 LOB: 2 BB: 0 P: 6	R: 0 E: 0 K: 0 S: 3	H: 0 LOB: 0 BB: 0 P: 3	1B: 8 2B: 0 3B: 0 HR: 1	SF: 0 SAC: 0 DP: 0 HBP: 0	WP: 0 PB: 1 SB: 1 CS: 0	PA: 38
--------------	------------------------------	---------------------------------	------------------------------	----------------------------------	------------------------------	---------------------------------	------------------------------	---------------------------------	------------------------------	---------------------------------	------------------------------	---------------------------------	------------------------------	---------------------------------	------------------------------	---------------------------------	----------------------------------	------------------------------------	----------------------------------	--------

PITCHER	IP	WLS	BF	H	R	ER	SO	BB	IBB	HBP	BLK	WP	HR	S	P	ERA	WHIP
Sal Maglie, R (1, 1) ERA: 3.4	7.0	W	29	6	1	1	6	2	0	0	0	0	0	39	47	1.29	1.143
Mary Grissom, R (8, 1) ERA: 1.79	2.0	S	9	3	1	1	0	0	0	0	0	0	1	9	9	4.50	1.500

Batter	1	2	3	4	5	6	7	8	9	AB R H RBI BB SO LOB	TOP																
Whitey Lockman, L (1, 3) OBP: 0.306, SLG: 0.426	0-3 K	0-0 4-3	0-0 F7			0-3 K2-3			0-3 K	5 0 0 0 0 3 1																	
Alvin Dark, R (1, 6) OBP: 0.315, SLG: 0.415	0-0 1B FC4-6 1B	0-0 1B 2B			0-0 F9	0-0 1B			0-0 E 2B 1B	5 3 4 0 0 0 0																	
Hank Thompson, L (1, 5) OBP: 0.414, SLG: 0.534	0-0 FC4-6 1-3 BB 1B	0-0 BB 2-H 1B			0-0 F9	0-3 K			4-0 2B BB	4 2 2 1 1 1 1																	
Monte Irvin, R (1, 7) OBP: 0.348, SLG: 0.483	4-0 FC4-6 IBB	4-0 1-2 BB			0-0 1B		0-0 1-3		0-0 1-H 2-H 2B	3 0 2 2 2 0 0																	
Don Mueller, L (1, 9) OBP: 0.384, SLG: 0.460	0-0 FC4-6 BB 1-2f 2-3 3-H	0-0 F7			0-0 4-3		0-0 6-3		4-0 IBB	4 0 0 1 1 0 5																	
Willie Mays, R (1, 8) OBP: 0.371, SLG: 0.658	4-0 BB 1-2 BB		4-0 1-3 1B BB		0-0 4-3		0-3 K		0-0 P4	3 1 0 0 2 1 2																	
Billy Gardner, R (1, 4) OBP: 0.359, SLG: 0.486	4-0 1-2 2-3 3-H BB		0-0 1-3		0-0 F7			0-3 K	0-3 K	4 0 0 1 1 2 3																	
Wes Westrum, R (1, 2) OBP: 0.275, SLG: 0.209	0-0 F7		0-0 2-H 1B		0-0 F7			0-3 K		4 0 1 1 0 1 3																	
Larry Jansen, R (1, 1) OBP: 0.364, SLG: 0.455		0-3 K2-3	0-3 K			0-0 G3		0-3 K		0 0 0 0 0 0 0																	
Alex Konikowski, R (1, 1)										1 0 0 0 0 1 0																	
Bill Taylor, L (3, PH)										1 0 0 0 0 1 1																	
Windy McCall, L (3, 1)										1 0 0 0 0 0 0																	
Dusty Rhodes, L (8, PH)										1 0 0 0 0 1 0																	
Hoyt Wilhelm, R (8, 1)										0 0 0 0 0 0 0																	
<b>Inning Stats</b>	R: 2 E: 0 K: 1 S: 7	H: 2 LOB: 3 BB: 3 P: 19	R: 1 E: 0 K: 1 S: 7	H: 2 LOB: 2 BB: 1 P: 11	R: 1 E: 0 K: 1 S: 6	H: 1 LOB: 1 BB: 1 P: 10	R: 0 E: 0 K: 0 S: 4	H: 1 LOB: 1 BB: 0 P: 4	R: 0 E: 0 K: 0 S: 3	H: 0 LOB: 0 BB: 0 P: 3	R: 0 E: 0 K: 2 S: 8	H: 1 LOB: 1 BB: 0 P: 8	R: 0 E: 0 K: 1 S: 5	H: 0 LOB: 0 BB: 0 P: 5	R: 0 E: 0 K: 3 S: 9	H: 0 LOB: 0 BB: 0 P: 9	R: 2 E: 1 K: 2 S: 9	H: 2 LOB: 2 BB: 2 P: 17	1B: 7 2B: 2 3B: 0 HR: 0	SF: 0 SAC: 0 DP: 0 HBP: 0	WP: 0 PB: 0 SB: 0 CS: 0	PA: 43					
<b>PITCHER</b>	IP WLS BF H R ER SO BB IBB HBP BLK WP HR S P ERA WHIP																										
Chet Nichols, L (1, 1) ERA: 3.36	1.2	L	12	4	3	3	2	2	1	0	0	0	0	13	25	16.20	3.600										
Dave Jolly, R (2, 1) ERA: 1.16	7.1	L	31	5	3	3	9	3	1	0	0	0	0	45	61	3.68	1.091										

New York Giants @ Milwaukee Braves  
Milwaukee County Stadium, Milwaukee, WI

Tue Jun 08 1954, 4:33 AM EDT  
Att: 35,230 - Unknown

livebaseballscorecards.com

AB 36  
R 6  
H 9  
RBI 6  
BB 7  
SO 11  
LOB 16





Batter	1	2	3	4	5	6	7	8	9	AB R H RBI BB SO LOB	TOP											
Whitey Lockman, L (1, 3) OBP: 0.304, SLG: 0.421	0-0 F8	0-0 G3			0-0 F3		0-0 L4 1B	0-0 F9		5 0 1 0 0 0 4												
Alvin Dark, R (1, 6) OBP: 0.330, SLG: 0.435	0-0 2B FC1-4	4-0			0-0 4-3 2B		0-0 1-2 1B		0-0 SH3-4 1B	4 2 4 0 1 0 0												
Hank Thompson, L (1, 5) OBP: 0.411, SLG: 0.533	0-0 FC1-4 2B	0-0 4-3			0-0 4-3 2B		0-3 K		0-0 SH3-4 1B	4 0 1 0 0 1 6												
Monte Irvin, R (1, 7) OBP: 0.354, SLG: 0.478	4-0 FC1-4 IBB				4-0 F2		0-0 L4		4-0 1B SF9 IBB	2 1 0 0 3 0 2												
Don Mueller, L (1, 9) OBP: 0.384, SLG: 0.458	0-0 FC1-4				0-0 4-3				0-0 BB 1B	5 1 2 2 0 0 4												
Willie Mays, R (1, 8) OBP: 0.371, SLG: 0.651	0-0 F7				0-0 F9				0-0 BB 1B	2 0 0 1 2 0 2												
Billy Gardner, R (1, 4) OBP: 0.364, SLG: 0.475					0-0 5-3				0-0 BB 1B	5 0 2 0 0 1 3												
Wes Westrum, R (1, 2) OBP: 0.304, SLG: 0.200					0-0 L6				0-0 BB 1B	2 0 0 0 3 1 1												
Johnny Antonelli, L (1, 1) OBP: 0.205, SLG: 0.263					0-3 K				0-3 K	4 0 1 1 0 2 5												
<b>Inning Stats</b>	R: 1 E: 0 K: 0 S: 5	H: 2 LOB: 2 BB: 1 P: 9	R: 0 E: 0 K: 1 S: 7	H: 1 LOB: 3 BB: 1 P: 11	R: 0 E: 0 K: 0 S: 3	H: 0 LOB: 0 BB: 0 P: 3	R: 0 E: 0 K: 1 S: 5	H: 0 LOB: 0 BB: 0 P: 5	R: 0 E: 0 K: 1 S: 4	H: 1 LOB: 2 BB: 1 P: 8	R: 0 E: 0 K: 1 S: 4	H: 0 LOB: 1 BB: 2 P: 12	R: 0 E: 0 K: 1 S: 6	H: 2 LOB: 1 BB: 0 P: 6	R: 1 E: 0 K: 0 S: 4	H: 2 LOB: 2 BB: 2 P: 12	R: 2 E: 0 K: 1 S: 8	H: 3 LOB: 3 BB: 2 P: 16	1B: 8 2B: 5 3B: 0 HR: 0	SF: 1 SAC: 2 DP: 3 HBP: 0	WP: 0 PB: 0 SB: 0 CS: 0	PA: 45
<b>PITCHER</b> Warren Spahn, L (1, 1) ERA: 2.94	IP: 9.0 WLS: L BF: 45 H: 11 R: 4 ER: 4 SO: 5 BB: 4 IBB: 5 HBP: 0 BLK: 0 WP: 0 HR: 0 S: 46 P: 82 ERA: 4.00 WHIP: 1.667											<b>PITCHER</b>	IP: WLS: BF: H: R: ER: SO: BB: IBB: HBP: BLK: WP: HR: S: P: ERA: WHIP:									

**New York Giants @ Milwaukee Braves**  
**Milwaukee County Stadium, Milwaukee, WI**  
 Wed Jun 09 1954, 4:33 AM EDT  
 Att: 30,018 - Unknown

AB	33
R	4
H	11
RBI	4
BB	9
SO	5
LOB	27





Batter	1	2	3	4	5	6	7	8	9	10	AB R H RBI BB SO LOB	TOP								
Whitey Lockman, L (1, 3) OBP: 0.303, SLG: 0.417	0-0 4-3		0-0 G3		0-0 CS 1B			0-0 4-3			4 0 1 0 0 0 0	<b>New York Giants @ Milwaukee Braves</b> <b>Milwaukee County Stadium, Milwaukee, WI</b> Thu Jun 10 1954, 4:33 AM EDT Att. 23,100 - Unknown								
Alvin Dark, R (1, 6) OBP: 0.329, SLG: 0.432	0-0 1B 1B		0-3 K		0-0 CS 1-2	0-0 F9			0-0 6-3		4 0 1 0 0 1 0									
Hank Thompson, L (1, 5) OBP: 0.402, SLG: 0.519	0-0 F8			0-0 4-3		0-0 F8			0-3 K		4 0 0 0 0 1 1									
Monte Irvin, R (1, 7) OBP: 0.362, SLG: 0.481	0-0 1-2 1B			4-0 FC5 BB BB		0-3 K			0-0 1B		3 0 2 0 1 1 0									
Don Mueller, L (1, 9) OBP: 0.377, SLG: 0.449	0-0 4-3			0-0 F2		0-0 P4			0-3 K		4 0 0 0 0 1 4									
Willie Mays, R (1, 8) OBP: 0.369, SLG: 0.640		0-0 F8		4-0 1-2 BB		0-0 5-3			0-3 K		3 0 0 0 1 1 0									
Billy Gardner, R (1, 4) OBP: 0.340, SLG: 0.442		0-0 6-3		0-0 FC5 2-3f		0-0 6-3			0-0 HR		3 0 0 0 0 0 2									
Bill Taylor, L (10, PH) OBP: 0.353, SLG: 0.600											1 1 1 1 0 0 0									
Bobby Hofman, R (10, 4) OBP: 0.120, SLG: 0.400											0 0 0 0 0 0 0									
Wes Westrum, R (1, 2) OBP: 0.283, SLG: 0.184		0-0 P5			0-3 K			0-0 1-3		0-3 K	4 0 0 0 0 2 0									
Ruben Gomez, R (1, 1) OBP: 0.250, SLG: 0.250			0-0 4-3		0-0 P6			0-0 F9		0-0 6-3	4 0 0 0 0 0 0									
<b>Inning Stats</b>	R: 0 E: 0 K: 0 S: 5	H: 2 LOB: 2 BB: 0 P: 5	R: 0 E: 0 K: 0 S: 3	H: 0 LOB: 0 BB: 0 P: 3	R: 0 E: 0 K: 1 S: 5	H: 0 LOB: 0 BB: 0 P: 5	R: 0 E: 0 K: 1 S: 5	H: 1 LOB: 0 BB: 0 P: 5	R: 0 E: 0 K: 1 S: 5	H: 0 LOB: 0 BB: 0 P: 3	R: 0 E: 0 K: 0 S: 3	H: 0 LOB: 0 BB: 0 P: 3	R: 0 E: 0 K: 2 S: 8	H: 1 LOB: 1 BB: 0 P: 8	R: 1 E: 0 K: 2 S: 8	H: 1 LOB: 0 BB: 0 P: 8	1B: 4 2B: 0 3B: 0 HR: 1	SF: 0 SAC: 0 DP: 0 HBP: 0	WP: 0 PB: 0 SB: 0 CS: 1	PA: 37
<b>PITCHER</b> Gene Conley, R (1, 1) ERA: 2.43	IP 10.0	WLS L	BF 36	H 5	R 1	ER 1	SO 7	BB 2	IBB 0	HBP 0	BLK 0	WP 0	HR 1	S 48	P 56	ERA 0.90	WHIP 0.700			

livebaseballscorecards.com

AB	34
R	1
H	5
RBI	1
BB	2
SO	7
LOB	7



**BOTTOM**

**New York Giants @ Milwaukee Braves**  
 Milwaukee County Stadium, Milwaukee, WI

Thu Jun 10 1954, 4:33 AM EDT  
 Att: 23,100 - Unknown

[livebaseballscorecards.com](http://livebaseballscorecards.com)

<b>AB</b>	<b>33</b>
<b>R</b>	<b>0</b>
<b>H</b>	<b>9</b>
<b>RBI</b>	<b>0</b>
<b>BB</b>	<b>4</b>
<b>SO</b>	<b>3</b>
<b>LOB</b>	<b>16</b>



<b>WP:</b>	0	<b>PA:</b>	40
<b>PB:</b>	0		
<b>SB:</b>	1		
<b>CS:</b>	1		

AB R H RBI BB SO LOB

5 0 1 0 0 1 4

2 0 0 0 1 0 1

4 0 1 0 0 0 3

3 0 1 0 1 0 2

4 0 2 0 0 0 3

2 0 1 0 0 0 0

2 0 0 0 1 0 0  
 0 0 0 0 1 0 0  
 0 0 0 0 0 0 0

4 0 2 0 0 0 2

1B: 9 SF: 0  
 2B: 3 SAC: 2  
 3B: 0 DP: 4  
 HR: 0 HBP: 0

Batter	1	2	3	4	5	6	7	8	9	10
<b>Bill Bruton, L</b> (1, 8) OBP: 0.315, SLG: 0.284	0-0 F9-3 1B		0-3 K		0-0 P6		0-0 F8-2 3-H			0-0 P6
<b>Johnny Logan, R</b> (1, 6) OBP: 0.348, SLG: 0.426	0-0 F9-3			4-0 FC6-4 BB		0-0 F8		0-0 6-3		0-3 K
<b>Roy Smalley, R</b> (8, 6) OBP: 0.333, SLG: 0.800	1-2									0-3 K
<b>Jack Dittmer, L</b> (10, PH) OBP: 0.182, SLG: 0.262										
<b>Eddie Mathews, L</b> (1, 5) OBP: 0.416, SLG: 0.535	0-0 E S 1B			0-0 F7		0-0 G1		0-0 E3		0-3 K
<b>Andy Patko, R</b> (1, 9) OBP: 0.349, SLG: 0.439	0-0 F7 1-3			0-0 FC6-4 BB 1-2f		0-0 1B		0-0 L7		
<b>Joe Adcock, R</b> (1, 3) OBP: 0.395, SLG: 0.522		0-0 G6-4-3 1B		4-0 FC6-4 BB 1-2		0-0 P5		0-0 F8		
<b>Hank Aaron, R</b> (1, 7) OBP: 0.331, SLG: 0.460		0-0 G6-4-3 1-2f		0-0 FC6-4 1-2f			0-0 1B SH1-4 F8-2 1B		0-0 F9-6 SH1-4 1B	
<b>Danny O'Connell, R</b> (1, 4) OBP: 0.302, SLG: 0.305		0-0 CS 1B			0-0 3-1		0-0 SH1-4 1-2		0-0 SH1-4 1-2	
<b>Del Crandall, R</b> (1, 2) OBP: 0.242, SLG: 0.261		0-0 CS	0-0 6-3		0-0 6-3		4-0 1B IBB		4-0 1B IBB	
<b>George Metkovich, L</b> (9, PH) OBP: 0.400, SLG: 0.381		1-2								
<b>Charlie White, L</b> (10, 2) OBP: 0.333, SLG: 0.386										
<b>Gene Conley, R</b> (1, 1) OBP: 0.200, SLG: 0.240			0-0 F5		0-0 1B		0-0 1-2 2-3 1B		0-0 F9-6 2-3	

Inning Stats	R: 0	H: 2	E: 0	K: 0	S: 4	R: 0	H: 2	E: 0	K: 0	S: 3	R: 0	H: 0	E: 0	K: 1	S: 5	R: 0	H: 0	E: 0	K: 0	S: 3	R: 0	H: 1	E: 0	K: 0	S: 4	R: 0	H: 1	E: 0	K: 0	S: 4	R: 0	H: 2	E: 0	K: 0	S: 4	R: 0	H: 0	E: 1	K: 0	S: 4	R: 0	H: 1	E: 0	K: 0	S: 3	R: 0	H: 1	E: 0	K: 2	S: 7	R: 0	H: 0	E: 0	K: 2	S: 7	1B: 9	2B: 3	3B: 0	HR: 0	SF: 0	SAC: 2	DP: 4	HBP: 0	WP: 0	PA: 40
--------------	------	------	------	------	------	------	------	------	------	------	------	------	------	------	------	------	------	------	------	------	------	------	------	------	------	------	------	------	------	------	------	------	------	------	------	------	------	------	------	------	------	------	------	------	------	------	------	------	------	------	------	------	------	------	------	-------	-------	-------	-------	-------	--------	-------	--------	-------	--------

PITCHER	IP	WLS	BF	H	R	ER	SO	BB	IBB	HBP	BLK	WP	HR	S	P	ERA	WHIP
<b>Ruben Gomez, R</b> (1, 1) ERA: 2.87	10.0	W	39	9	0	0	3	2	2	0	0	0	0	41	57	0.00	1.100

Batter	1	2	3	4	5	6	7	8	9	10	AB R H RBI BB SO LOB	TOP														
Whitey Lockman, L (1, 3) OBP: 0.300, SLG: 0.414	0-0 1-3		0-0 1-3		0-0 E4 1-3 1B		0-0 SF9		0-0 4-3		4 0 1 1 0 0 0	<p><b>New York Giants @ Chicago Cubs</b> Wrigley Field, Chicago, IL</p> <p>Fri Jun 11 1954, 3:33 AM CDT Att: 5,997 - Unknown</p> <p>livebaseballscorecards.com</p> <table border="1"> <tr><td>AB</td><td>35</td></tr> <tr><td>R</td><td>4</td></tr> <tr><td>H</td><td>8</td></tr> <tr><td>RBI</td><td>3</td></tr> <tr><td>BB</td><td>3</td></tr> <tr><td>SO</td><td>4</td></tr> <tr><td>LOB</td><td>16</td></tr> </table> 	AB	35	R	4	H	8	RBI	3	BB	3	SO	4	LOB	16
AB	35																									
R	4																									
H	8																									
RBI	3																									
BB	3																									
SO	4																									
LOB	16																									
Alvin Dark, R (1, 6) OBP: 0.326, SLG: 0.424	0-0 F9		1-0 HBP		0-0 1-3		0-0 6-3		0-0 F8		4 0 0 0 0 0 2															
Hank Thompson, L (1, 5) OBP: 0.397, SLG: 0.506	0-0 P6		0-0 F9			0-0 3-1		0-0 4-3		H 1-0 G5-4-3 HBP	4 0 0 0 0 0 1															
Monte Irvin, R (1, 7) OBP: 0.372, SLG: 0.484		B B B B	4-0 WP 1B BB		0-0 CS 1B		0-0 FC4-6 1B		4-0 1B E BB	H 0-0 G5-4-3 1-2f	3 2 2 0 2 0 1															
Don Mueller, L (1, 9) OBP: 0.377, SLG: 0.448		X	0-0 G4-6-3 1-H 1B E		0-0 L4		0-0 FC4-6 1B		0-0 E7 1B	X 0-0 F8	5 0 2 1 0 0 2															
Willie Mays, R (1, 8) OBP: 0.367, SLG: 0.632		X	0-0 E6 G4-6-3 1-2		0-0 6-3		0-0 1-2 1B		0-0 G3		4 0 1 0 0 0 2															
Billy Gardner, R (1, 4) OBP: 0.320, SLG: 0.413		X	0-0 G4-6-3		0-0 F7		0-3 K		0-3 K		3 0 0 0 0 1 4															
Bobby Hofman, R (8, PH) OBP: 0.115, SLG: 0.385		X	1-2f 2-3								1 0 0 0 0 1 1															
Wes Westrum, R (1, 2) OBP: 0.290, SLG: 0.180		X	0-0 F9		4-0 E BB		0-0 3-1 SF9 2B		0-0 HR		1 0 0 0 1 0 1															
Dusty Rhodes, L (7, PH) OBP: 0.471, SLG: 0.467											1 1 1 0 0 0 0															
Ray Katt, R (7, 2) OBP: 0.342, SLG: 0.373											1 1 1 1 0 0 0															
Jim Hearn, R (1, 1) OBP: 0.167, SLG: 0.500					0-0 F8		0-0 3-1		0-3 K		2 0 0 0 0 1 1															
Hoyt Wilhelm, R (6, 1)											0 0 0 0 0 0 0															
Bill Taylor, L (7, PH) OBP: 0.333, SLG: 0.563											1 0 0 0 0 0 1															
Alex Konikowski, R (7, 1)											0 0 0 0 0 0 0															
Windy McCall, L (7, 1)											0 0 0 0 0 0 0															
Marv Grissom, R (8, 1)											1 0 0 0 0 1 0															
<b>Inning Stats</b>	R: 0 E: 0 K: 0 S: 3	H: 0 LOB: 0 BB: 0 P: 3	R: 1 E: 1 K: 0 S: 4	H: 1 LOB: 1 BB: 1 P: 8	R: 0 E: 0 K: 0 S: 3	H: 0 LOB: 1 BB: 0 P: 4	R: 0 E: 0 K: 0 S: 3	H: 1 LOB: 0 BB: 0 P: 3	R: 0 E: 1 K: 1 S: 6	H: 2 LOB: 2 BB: 0 P: 7	R: 1 E: 0 K: 0 S: 4	H: 1 LOB: 0 BB: 0 P: 4	R: 1 E: 1 K: 1 S: 6	H: 1 LOB: 1 BB: 1 P: 10	R: 1 E: 0 K: 1 S: 6	H: 1 LOB: 0 BB: 0 P: 6	R: 0 E: 0 K: 0 S: 2	H: 0 LOB: 0 BB: 0 P: 3	1B: 6 2B: 1 3B: 0 HR: 1	SF: 1 SAC: 0 DP: 2 HBP: 2	WP: 1 PB: 0 SB: 0 CS: 1	PA: 41				
<b>PITCHER</b>	IP WLS BF H R ER SO BB IBB HBP BLK WP HR S P ERA WHIP																									
Johnny Klippstein, R (1, 1) ERA: 6.38	7.1		32	7	3	2	2	3	0	0	0	0	1	0	32	45	2.46	1.364								
Hal Jeffcoat, R ERA: 5.88	(8, 1)	1.2		6	1	1	1	2	0	0	0	0	0	1	10	10	5.40	0.600								
Jim Davis, L ERA: 5.68	(10, 1)	1.0	W	3	0	0	0	0	0	0	1	0	0	0	2	3	0.00	0.000								



BOTTOM

New York Giants @ Chicago Cubs  
Wrigley Field, Chicago, IL  
Fri Jun 11 1954, 3:33 AM CDT  
Att. 5,997 - Unknown

livebaseballscorecards.com

AB 36  
R 5  
H 9  
RBI 4  
BB 8  
SO 3  
LOB 24



WP: 1 PA: 46  
PB: 0  
SB: 0  
CS: 1

AB R H RBI BB SO LOB

4 1 3 1 1 0 0

3 2 1 1 2 2 0

5 0 1 0 0 0 4

3 0 0 0 2 1 4

4 1 1 1 1 0 1

4 1 1 0 1 0 3

4 0 0 0 1 0 5

3 0 1 1 0 0 0

1 0 1 0 0 0 0

1 0 0 0 0 0 1

0 0 0 0 0 0 0

1B: 5 SF: 0  
2B: 1 SAC: 2  
3B: 1 DP: 0  
HR: 2 HBP: 0

Batter	1	2	3	4	5	6	7	8	9	10
Eddie Miksis, R (1, 4) OBP: 0.262, SLG: 0.308	F9		F9 1B		E7 1B	BB		SH SH5-4		HR
Bob Talbot, R (1, 8) OBP: 0.283, SLG: 0.351	6-3		F9		P4	F9 BB		SH5-4		
Randy Jackson, R (1, 5) OBP: 0.374, SLG: 0.520	HR			K		14 E BB	K	IBB		
Ralph Kiner, R (1, 7) OBP: 0.441, SLG: 0.605	F7			5-3		F7	14 WP BB 1B	P6		
Hank Sauer, R (1, 9) OBP: 0.438, SLG: 0.711		5-3		BB		K	14 WP BB	5-3		
14 Ernie Banks, R (1, 6) OBP: 0.333, SLG: 0.434		4-3		F5		E6 E 2B	FC4-6 IBB	F7		
Dee Fondy, L (1, 3) OBP: 0.300, SLG: 0.427		3B		6-3		6-3	E 1B BB	E4 CS		
El Tappe, R (1, 2) OBP: 0.309, SLG: 0.294		6-3		4-3		4-3	E5 BB 1B	FC4-6		BB
Johnny Klippstein, R (1, 1) OBP: 0.136, SLG: 0.143			4-3		E6			SH5-4 SH		F5
Hal Jeffcoat, R (8, 1) OBP: 0.429, SLG: 0.833										
Bill Serena, R (9, PH) OBP: 0.375, SLG: 0.684										
Jim Davis, S (10, 1)										

Inning Stats	R: 1	H: 1	E: 0	K: 0	S: 4	R: 0	H: 1	E: 0	K: 0	S: 4	R: 0	H: 1	E: 0	K: 0	S: 3	R: 0	H: 0	E: 0	K: 1	S: 5	R: 0	H: 1	E: 2	K: 0	S: 5	R: 3	H: 2	E: 0	K: 1	S: 8	R: 0	H: 1	E: 0	K: 1	S: 6	R: 0	H: 1	E: 1	K: 0	S: 5	R: 0	H: 0	E: 1	K: 0	S: 3	R: 1	H: 1	E: 0	K: 0	S: 1
	LOB: 0	BB: 0	P: 4	LOB: 1	BB: 0	P: 4	LOB: 0	BB: 0	P: 3	LOB: 1	BB: 1	P: 9	LOB: 2	BB: 0	P: 5	LOB: 3	BB: 3	P: 20	LOB: 3	BB: 2	P: 14	LOB: 1	BB: 1	P: 9	LOB: 0	BB: 1	P: 7	LOB: 0	BB: 0	P: 1	LOB: 1	BB: 0	P: 1	LOB: 0	BB: 0	P: 1	LOB: 0	BB: 0	P: 1	LOB: 0	BB: 0	P: 1	LOB: 0	BB: 0	P: 1					

PITCHER	IP	WLS	BF	H	R	ER	SO	BB	IBB	HBP	BLK	WP	HR	S	P	ERA	WHIP
Jim Hearn, R (1, 1) ERA: 6.17	5.2		28	6	4	2	2	4	0	0	0	0	1	28	44	3.18	1.765
Hoyt Wilhelm, R (6, 1) ERA: 2.15	0.1		1	0	0	0	0	0	0	0	0	0	0	1	1	0.00	0.000
Alex Konikowski, R (7, 1) ERA: 6.75	0.1		3	1	0	0	1	1	0	0	0	0	0	4	8	0.00	6.000
Windy McCall, L (7, 1) ERA: 2.01	0.2		4	1	0	0	0	0	1	0	0	1	0	3	7	0.00	1.500
Mary Grissom, R (8, 1) ERA: 1.9	2.0	L	10	1	1	1	0	1	1	0	0	0	1	8	16	4.50	1.000

**New York Giants @ Chicago Cubs**  
 Wrigley Field, Chicago, IL  
 Sat Jun 12 1954, 3:33 AM CDT  
 Att. 11,775 - Unknown

[livebaseballscorecards.com](http://livebaseballscorecards.com)

<b>AB</b>	36
<b>R</b>	5
<b>H</b>	10
<b>RBI</b>	5
<b>BB</b>	2
<b>SO</b>	5
<b>LOB</b>	14



WP:	1	PA:	39
PB:	0		
SB:	1		
CS:	0		

AB R H RBI BB SO LOB

4	0	1	0	1	0	1
5	0	2	3	0	0	0
5	0	0	0	0	1	5
4	0	2	0	0	0	3
4	0	0	0	0	0	2
4	2	2	1	0	1	0
4	1	1	0	0	0	1
2	0	0	0	0	1	0
1	0	1	1	0	0	0
0	1	0	0	1	0	0
2	1	1	0	0	1	0
1	0	0	0	0	1	2

Batter	1	2	3	4	5	6	7	8	9
<b>Whitey Lockman, L</b> (1, 3) OBP: 0.303, SLG: 0.411	0-0 F2			0-0 6-3		0-0 1B	0-0 4-3		4-0 1B
<b>Alvin Dark, R</b> (1, 6) OBP: 0.328, SLG: 0.423	0-0 F5			0-0 E6		0-0 1B		0-0 4-3	0-0 1B
<b>Hank Thompson, L</b> (1, 5) OBP: 0.387, SLG: 0.491	0-3 K			0-0 G3		0-0 F2		0-0 4-3	0-0 F7
<b>Monte Irvin, R</b> (1, 7) OBP: 0.374, SLG: 0.484				0-0 F9		0-0 F8		0-0 1B	
<b>Don Mueller, L</b> (1, 9) OBP: 0.370, SLG: 0.439				0-0 L4-3		0-0 5-3		0-0 4-3	0-0 P3
<b>Willie Mays, R</b> (1, 8) OBP: 0.369, SLG: 0.645				0-0 F3		0-3 K			0-0 WP
<b>Davey Williams, R</b> (1, 4) OBP: 0.238, SLG: 0.288				0-0 5-3		0-0 F7		0-0 1B	0-0 F2
<b>Wes Westrum, R</b> (1, 2) OBP: 0.281, SLG: 0.173				0-3 K		0-0 F8		0-0 SH3	4-0 WP
<b>Dusty Rhodes, L</b> (7, PH) OBP: 0.500, SLG: 0.500									1B
<b>Ray Katt, R</b> (7, 2) OBP: 0.350, SLG: 0.373									1B
<b>Sal Maglie, R</b> (1, 1) OBP: 0.133, SLG: 0.103				0-3 K		0-0 1B		0-0 SH3	0-3 K
<b>Hoyt Wilhelm, R</b> (8, 1)									1-2 2-3

Inning Stats	R: 0	H: 0	R: 0	H: 1	R: 0	H: 0	R: 0	H: 0	R: 1	H: 3	R: 2	H: 3	R: 0	H: 1	R: 2	H: 2	
E: 0	LOB: 0	E: 0	LOB: 0	E: 0	LOB: 0	E: 0	LOB: 0	E: 0	LOB: 2	E: 0	LOB: 1	E: 0	LOB: 1	E: 0	LOB: 2	E: 0	LOB: 2
K: 1	BB: 0	K: 0	BB: 0	K: 2	BB: 0	K: 0	BB: 0	K: 1	BB: 0	K: 0	BB: 0	K: 0	BB: 0	K: 0	BB: 2	K: 1	BB: 2
S: 5	P: 5	S: 3	P: 3	S: 7	P: 7	S: 4	P: 4	S: 5	P: 5	S: 6	P: 6	S: 6	P: 6	S: 4	P: 4	S: 7	P: 15

PITCHER	IP	WLS	BF	H	R	ER	SO	BB	IBB	HBP	BLK	WP	HR	S	P	ERA	WHIP
<b>Warren Hacker, R</b> (1, 1) ERA: 3.76	6.1	L	26	7	3	3	4	0	0	0	0	0	1	34	34	4.26	1.105
<b>Jim Brosnan, R</b> (7, 1) ERA: 9.33	0.2		2	0	0	0	0	0	0	0	0	0	0	2	2	0.00	0.000
<b>Bill Tremel, R</b> (8, 1) ERA: 9.0	2.0		11	3	2	2	1	0	2	0	0	1	0	11	19	9.00	1.500

1B:	8	SF:	0
2B:	1	SAC:	1
3B:	1	DP:	1
HR:	1	HBP:	0

Batter	1	2	3	4	5	6	7	8	9	AB	R	H	RBI	BB	SO	LOB
Eddie Miksis, R OBP: 0.261, SLG: 0.302 (1, 4)	0-0 1B 1B		0-0 F7		0-0 F8			0-3 K		4	0	1	0	0	1	0
Bob Talbot, R OBP: 0.282, SLG: 0.347 (1, 8)	0-0 F8		0-0 5-3			0-0 WP 1B		0-0 5-3		4	0	1	0	0	0	1
Randy Jackson, R OBP: 0.376, SLG: 0.520 (1, 5)	0-0 1-2 1B		0-0 FC6-4 1B			0-0 P6		0-0 6-3		4	0	2	0	0	0	1
Ralph Kiner, R OBP: 0.433, SLG: 0.593 (1, 7)	0-0 L4		0-0 FC6-4 1-2f			0-0 P2 1-2		0-3 K		4	0	0	0	0	1	4
Hank Sauer, R OBP: 0.430, SLG: 0.694 (1, 9)	0-3 K			0-3 K		0-0 F8		0-0 F2		4	0	0	0	0	2	3
14 Ernie Banks, R OBP: 0.332, SLG: 0.431 (1, 6)		0-0 F8		0-0 G6-3 1B		0-0 F7		0-0 6-3		4	0	1	0	0	0	0
Dee Fondy, L OBP: 0.300, SLG: 0.425 (1, 3)		0-0 FC4-6 1B		0-0 G6-3 1-2f		0-0 F8				3	0	1	0	0	0	1
El Tappe, R OBP: 0.310, SLG: 0.315 (1, 2)		0-0 FC4-6 FC6-4 1-2f		0-0 6-3		0-0 2B				3	0	1	0	0	0	1
Warren Hacker, R OBP: 0.188, SLG: 0.133 (1, 1)		0-0 FC6-4		0-0 F9						2	0	0	0	0	0	1
Jim Brosnan, R OBP: 0.250, SLG: 0.250 (7, 1)										0	0	0	0	0	0	0
Joe Garagiola, L OBP: 0.416, SLG: 0.427 (7, PH)										1	0	0	0	0	0	1
Bill Tremel, R (8, 1)										0	0	0	0	0	0	0

Inning Stats	R: 0	H: 2	E: 0	K: 1	S: 7	R: 0	H: 1	E: 0	K: 0	S: 4	R: 0	H: 1	E: 0	K: 1	S: 5	R: 0	H: 0	E: 0	K: 0	S: 3	R: 0	H: 1	E: 0	K: 0	S: 4	R: 0	H: 0	E: 0	K: 1	S: 5	R: 0	H: 0	E: 0	K: 1	S: 5	R: 0	H: 0	E: 0	K: 1	S: 5
	LOB: 2	BB: 0	P: 7	LOB: 1	BB: 0	P: 4	LOB: 0	BB: 0	P: 4	LOB: 0	BB: 0	P: 3	LOB: 1	BB: 0	P: 4	LOB: 1	BB: 0	LOB: 0	BB: 0	P: 3	LOB: 1	BB: 0	LOB: 0	BB: 0	P: 5	LOB: 0	BB: 0	P: 5	LOB: 0	BB: 0	P: 5	LOB: 0	BB: 0	P: 5	LOB: 0	BB: 0	P: 5	LOB: 0	BB: 0	P: 5

PITCHER	IP	WLS	BF	H	R	ER	SO	BB	IBB	HBP	BLK	WP	HR	S	P	ERA	WHIP
Sal Maglie, R ERA: 3.15 (1, 1)	7.0	W	27	7	0	0	2	0	0	0	0	1	0	31	31	0.00	1.000
Hoyt Wilhelm, R ERA: 2.04 (8, 1)	2.0	S	6	0	0	0	2	0	0	0	0	0	0	10	10	0.00	0.000

**BOTTOM**

**New York Giants @ Chicago Cubs**  
 Wrigley Field, Chicago, IL  
 Sat Jun 12 1954, 3:33 AM CDT  
 Att. 11,775 - Unknown

livebaseballscorecards.com

<b>AB</b>	<b>33</b>
<b>R</b>	<b>0</b>
<b>H</b>	<b>7</b>
<b>RBI</b>	<b>0</b>
<b>BB</b>	<b>0</b>
<b>SO</b>	<b>4</b>
<b>LOB</b>	<b>13</b>



WP	PA	ERA	WHIP
1	33		
0			
0			

Batter	1	2	3	4	5	6	7	8	9	10	11	AB R H RBI BB SO LOB	TOP
<b>Whitey Lockman, L</b> OBP: 0.303, SLG: 0.408 (1, 3)												6 1 2 0 0 1 4	<b>New York Giants @ Chicago Cubs</b> Wrigley Field, Chicago, IL Sun Jun 13 1954, 3:33 AM CDT Unknown
<b>Alvin Dark, R</b> OBP: 0.328, SLG: 0.419 (1, 6)												5 1 1 1 0 0 1	
<b>Hank Thompson, L</b> OBP: 0.390, SLG: 0.482 (1, 5)												3 0 0 1 3 0 1	
<b>Monte Irvin, R</b> OBP: 0.364, SLG: 0.472 (1, 7)												5 0 0 1 0 0 4	
<b>Don Mueller, L</b> OBP: 0.374, SLG: 0.441 (1, 9)												6 2 3 1 0 0 1	
<b>Willie Mays, R</b> OBP: 0.368, SLG: 0.645 (1, 8)												6 1 2 0 0 0 4	
<b>Davey Williams, R</b> OBP: 0.242, SLG: 0.303 (1, 4)												5 2 2 2 0 0 2	
<b>Wes Westrum, R</b> OBP: 0.303, SLG: 0.226 (1, 2)												1 1 1 0 1 0 0	
<b>Dusty Rhodes, L</b> OBP: 0.474, SLG: 0.471 (7, PH)												1 0 0 0 0 0 1	
<b>Ray Katt, R</b> OBP: 0.341, SLG: 0.362 (7, 2)												2 0 0 0 0 1 2	
<b>Johnny Antonelli, L</b> OBP: 0.220, SLG: 0.275 (1, 1)												2 0 1 1 0 0 1	
<b>Hoyt Wilhelm, R</b> (5, 1)												0 0 0 0 0 0 0	
<b>Bill Taylor, L</b> OBP: 0.368, SLG: 0.588 (7, PH)												1 0 1 1 0 0 0	
<b>Billy Gardner, R</b> OBP: 0.320, SLG: 0.413 (7, PR)												0 0 0 0 0 0 0	
<b>Mary Grissom, R</b> OBP: 0.059, SLG: 0.059 (7, 1)												2 1 1 1 0 0 0	
<b>Inning Stats</b>	R: 0 H: 0 E: 1 LOB: 1 K: 0 BB: 0 S: 4 P: 4	R: 1 H: 2 E: 0 LOB: 2 K: 0 BB: 1 S: 5 P: 9	R: 0 H: 0 E: 0 LOB: 0 K: 0 BB: 0 S: 3 P: 3	R: 0 H: 0 E: 0 LOB: 0 K: 0 BB: 0 S: 3 P: 3	R: 1 H: 2 E: 0 LOB: 0 K: 0 BB: 0 S: 4 P: 4	R: 0 H: 0 E: 0 LOB: 1 K: 0 BB: 1 S: 3 P: 7	R: 1 H: 2 E: 0 LOB: 1 K: 1 BB: 0 S: 6 P: 6	R: 0 H: 0 E: 0 LOB: 0 K: 0 BB: 0 S: 3 P: 3	R: 0 H: 1 E: 0 LOB: 1 K: 0 BB: 0 S: 4 P: 4	R: 0 H: 1 E: 0 LOB: 2 K: 0 BB: 1 S: 4 P: 8	R: 6 H: 6 E: 0 LOB: 2 K: 1 BB: 1 S: 11 P: 16	1B: 9 SF: 1 2B: 4 SAC: 0 3B: 1 DP: 0 HR: 0 HBP: 1	WP: 1 PA: 52 PB: 0 SB: 1 CS: 2
<b>PITCHER</b>	IP WLS BF H R ER SO BB IBB HBP BLK WP HR S P ERA WHIP												
<b>Bob Rush, R</b> ERA: 4.71 (1, 1)	10.0 L 43 11 6 6 1 2 1 0 0 0 1 0 42 54 5.40 1.300												
<b>Hal Jeffcoat, R</b> ERA: 6.48 (11, 1)	0.1 5 2 1 1 1 1 0 1 0 0 0 5 10 27.00 9.000												
<b>Bill Tremel, R</b> ERA: 6.75 (11, 1)	0.2 3 1 2 2 0 0 0 0 0 0 0 3 3 27.00 1.500												

livebaseballscorecards.com

AB	45
R	9
H	14
RBI	9
BB	4
SO	2
LOB	21



Batter	1	2	3	4	5	6	7	8	9	10	11	AB	R	H	RBI	BB	SO	LOB	BOTTOM						
Eddie Miksis, R OBP: 0.250, SLG: 0.286 (1, 4)	4-3		1-6-3		E3		FC5-4 1B		6-3		F9	6	0	1	0	0	0	1							
Bob Talbot, R OBP: 0.279, SLG: 0.341 (1, 8)	5-3			F8	G4-6-3		F8			SH5-4 1B		5	0	1	0	0	0	2							
Randy Jackson, R OBP: 0.374, SLG: 0.514 (1, 5)	1-3			F8	BB BB 1B		FC5-4			SH5-4		4	0	1	0	0	0	1							
Ralph Kiner, R OBP: 0.437, SLG: 0.587 (1, 7)		K		14 BB E BB	14 FC5 BB		F9			IBB		2	1	0	0	3	1	1							
Hank Sauer, R OBP: 0.429, SLG: 0.682 (1, 9)		P9		E 14 BB BB				K		F7		3	1	0	0	2	1	2							
14 Ernie Banks, R OBP: 0.333, SLG: 0.427 (1, 6)		E5 1B		E BB	FC5			P4		F7		4	0	1	0	1	0	5							
Dee Fondy, L OBP: 0.298, SLG: 0.421 (1, 3)		1-3		E3 FC6-4 1B				F8				5	0	1	0	0	0	2							
El Tappe, R OBP: 0.302, SLG: 0.305 (1, 2)			K	FC6-4			FC1-6 L8-3 1B		4-3			5	0	1	0	0	1	3							
Bob Rush, R OBP: 0.333, SLG: 0.400 (1, 1)			G3				L8-3		6-3			4	1	1	0	0	0	1							
Hal Jeffcoat, R OBP: 0.429, SLG: 0.833 (11, 1)											F8	0	0	0	0	0	0	0							
Bill Tremel, R (11, 1)												0	0	0	0	0	0	0							
Joe Garagiola, L OBP: 0.412, SLG: 0.422 (11, PH)												1	0	0	0	0	0	1							
<b>Inning Stats</b>	R: 0 E: 0 K: 0 S: 3	H: 0 LOB: 0 BB: 0 P: 3	R: 0 E: 1 K: 1 S: 6	H: 1 LOB: 1 BB: 0 P: 6	R: 0 E: 0 K: 1 S: 5	H: 0 LOB: 0 BB: 0 P: 5	R: 2 E: 2 K: 0 S: 4	H: 0 LOB: 2 BB: 3 P: 16	R: 1 E: 1 K: 0 S: 5	H: 2 LOB: 3 BB: 2 P: 13	R: 0 E: 0 K: 0 S: 3	H: 1 LOB: 1 BB: 0 P: 4	R: 0 E: 0 K: 1 S: 5	H: 0 LOB: 0 BB: 0 P: 5	R: 0 E: 0 K: 0 S: 3	H: 0 LOB: 0 BB: 0 P: 3	R: 0 E: 0 K: 0 S: 4	H: 1 LOB: 2 BB: 1 P: 8	R: 0 E: 0 K: 0 S: 4	H: 1 LOB: 1 BB: 0 P: 4	1B: 6 2B: 2 3B: 0 HR: 0	SF: 0 SAC: 1 DP: 2 HBP: 0	WP: 0 PB: 0 SB: 0 CS: 0	PA: 46	
<b>PITCHER</b>	IP	WLS	BF	H	R	ER	SO	BB	IBB	HBP	BLK	WP	HR	S	P	ERA	WHIP								
Johnny Antonelli, L ERA: 2.39 (1, 1)	4.2		23	3	3	1	2	5	0	0	0	0	0	22	42	1.93	1.714								
Hoyt Wilhelm, R ERA: 1.88 (5, 1)	1.1		4	1	0	0	0	0	0	0	0	0	0	4	4	0.00	0.750								
Marv Grissom, R ERA: 1.72 (7, 1)	5.0	W	19	3	0	0	1	0	1	0	0	0	0	20	24	0.00	0.600								

**New York Giants @ Chicago Cubs**  
 Wrigley Field, Chicago, IL  
 Sun Jun 13 1954, 3:33 AM CDT  
 Unknown

[livebaseballscorecards.com](http://livebaseballscorecards.com)

<b>AB</b>	<b>39</b>
<b>R</b>	<b>3</b>
<b>H</b>	<b>7</b>
<b>RBI</b>	<b>0</b>
<b>BB</b>	<b>6</b>
<b>SO</b>	<b>3</b>
<b>LOB</b>	<b>19</b>



Batter	1	2	3	4	5	6	7	8	9	AB R H RBI BB SO LOB	TOP											
Whitey Lockman, L (1, 3) OBP: 0.305, SLG: 0.413	0-0 E4 L4-3	0-0 1-2 3-H 1B			0-0 5-3		0-0 3-1 2B 2B	0-0 F9		5 1 2 1 0 0 0												
Alvin Dark, R (1, 6) OBP: 0.325, SLG: 0.414	0-0 L4-3	0-0 FC5			0-0 1B		0-0 3-1	0-0 5-3		5 0 1 0 0 0 4												
Hank Thompson, L (1, 5) OBP: 0.395, SLG: 0.503	0-0 2B			0-0 4-3 SF7 2B		0-0 F9	0-0 WP FC5-2-5 2B		0-0 4-3	5 1 3 1 0 0 1												
Monte Irvin, R (1, 7) OBP: 0.361, SLG: 0.462	0-0 F3			0-0 4-3		0-0 P4	4-0 FC5-2-5 1B BB		0-0 6-3	4 1 0 0 1 0 3												
Don Mueller, L (1, 9) OBP: 0.379, SLG: 0.451		0-0 E SF7 1B		0-0 SF7		0-0 1B 2B	0-0 FC5-2-5 1B		0-0 PB WP 1B 1B	4 4 3 1 0 0 2												
Willie Mays, R (1, 8) OBP: 0.373, SLG: 0.641		0-0 SF7 1B 1B		0-3 K		0-0 F9	4-0 1B IBB		4-0 1B E BB	3 2 1 0 2 1 1												
Davey Williams, R (1, 4) OBP: 0.256, SLG: 0.313		4-0 FC5 1B BB			0-0 F7	0-0 1-3 1B	0-0 1-3 2-H 3-H 1B		0-0 E9 1B	4 0 3 4 1 0 0	AB 38 R 9 H 13 RBI 8 BB 4 SO 2 LOB 18											
Wes Westrum, R (1, 2) OBP: 0.282, SLG: 0.211		0-0 SF7		0-0 F3		0-0 1-3	0-3 K		0-0 5-3	4 0 0 1 0 1 4												
Don Liddle, L (1, 1) Hoyt Wilhelm, R (6, 1)		0-0 P5		0-0 P6		0-0 F8		0-0 L6		3 0 0 0 0 0 3 1 0 0 0 0 0 0												
<b>Inning Stats</b>	R: 0 E: 1 K: 0 S: 4	H: 1 LOB: 1 BB: 0 P: 4	R: 2 E: 1 K: 0 S: 6	H: 3 LOB: 2 BB: 1 P: 10	R: 1 E: 0 K: 1 S: 6	H: 1 LOB: 0 BB: 0 P: 6	R: 0 E: 0 K: 0 S: 3	H: 0 LOB: 0 BB: 0 P: 3	R: 0 E: 0 K: 0 S: 4	H: 1 LOB: 1 BB: 0 P: 4	R: 1 E: 0 K: 0 S: 5	H: 2 LOB: 1 BB: 0 P: 5	R: 3 E: 0 K: 1 S: 8	H: 3 LOB: 2 BB: 2 P: 16	R: 0 E: 0 K: 0 S: 3	H: 0 LOB: 0 BB: 0 P: 3	R: 2 E: 1 K: 0 S: 5	H: 2 LOB: 1 BB: 1 P: 9	1B: 8 2B: 6 3B: 0 HR: 0	SF: 2 SAC: 0 DP: 1 HBP: 0	WP: 2 PB: 1 SB: 0 CS: 0	PA: 44
<b>PITCHER</b>	IP WLS BF H R ER SO BB IBB HBP BLK WP HR S P ERA WHIP																					
Howie Pollet, L (1, 1) ERA: 3.16	6.0 L 27 8 4 4 1 1 0 0 0 0 0 0 28 32 6.00 1.500																					
Turk Lown, R (7, 1) ERA: 6.14	2.0 11 3 3 3 1 1 1 0 0 1 0 11 19 13.50 2.000																					
Johnny Klippstein, R (9, 1) ERA: 6.42	1.0 6 2 2 1 0 1 0 0 0 1 0 5 9 9.00 3.000																					

**New York Giants @ Chicago Cubs**  
Wrigley Field, Chicago, IL  
Sun Jun 13 1954, 3:38 AM CDT  
Att: 26,597 - Unknown

[livebaseballscorecards.com](http://livebaseballscorecards.com)



Cincinnati Redlegs @ New York Giants  
 Polo Grounds, New York, NY  
 Tue Jun 15 1954, 3:33 AM EDT  
 Att. 12,414 - Unknown

livebaseballscorecards.com

AB	32
R	3
H	8
RBI	3
BB	5
SO	6
LOB	16



AB	R	H	RBI	BB	SO	LOB	
5	0	1	1	0	0	0	
4	0	0	0	1	0	2	
5	0	1	0	0	1	3	
2	1	1	1	2	0	0	
4	1	2	0	0	1	4	
3	0	2	0	0	0	2	
2	0	0	0	1	1	2	
0	1	0	0	0	0	0	
0	0	0	0	0	0	0	
1	0	0	0	0	1	1	
0	0	0	0	0	0	0	
0	0	0	0	0	0	0	
3	0	1	1	0	0	0	
2	0	0	0	0	1	1	
1	0	0	0	1	1	1	
1B: 6	SF: 0	2B: 1	SAC: 2	3B: 0	DP: 1	HR: 1	HBP: 0

Batter	1	2	3	4	5	6	7	8	9																										
Nino Escalera, L (1, 9) OBP: 0.308, SLG: 0.212	0-0 L4		0-0 F3		0-0 3-1		0-0 FC5-2 1B		0-0 B3																										
Bobby Adams, R (1, 5) OBP: 0.355, SLG: 0.327	0-0 F9		0-0 5-3		4-0 BB	4-0 FC5-2		0-0 F8																											
Gus Bell, L (1, 8) OBP: 0.377, SLG: 0.546	0-0 2B		0-3 K		0-0 4-3	0-0 G3		0-0 F7																											
Ted Kluszewski, L (1, 3) OBP: 0.389, SLG: 0.623	4-0 FC6-4 BB		0-0 F8		4-0 IBB		0-0 HR																												
Jim Greengrass, R (1, 7) OBP: 0.280, SLG: 0.437	0-0 FC6-4		0-0 CS 1B		0-3 K		0-0 SH1-4 1B																												
Johnny Temple, R (1, 4) OBP: 0.384, SLG: 0.363		0-0 G3-6-1 1B		0-0 1B	0-0 F9		0-0 SH1-4																												
Ed Bailey, L (1, 2) OBP: 0.363, SLG: 0.467		0-0 G3-6-1		0-3 K		4-0 SH3-4 1B BB		0-3 K																											
Chuck Harmon, R (7, PR) OBP: 0.298, SLG: 0.259																																			
Frank Smith, R (7, 1)																																			
Bob Borkowski, R (8, PH)																																			
Harry Perkowski, L (8, 1) OBP: 0.280, SLG: 0.383																																			
Howie Judson, R (9, 1) OBP: 0.143, SLG: 0.143																																			
Jackie Collum, L (9, 1) OBP: 0.200, SLG: 0.400																																			
Roy McMillan, R (1, 6) OBP: 0.300, SLG: 0.292		0-0 E6		0-0 6-3		0-0 SH3-4		0-0 1B																											
Fred Baczewski, L (1, 1) OBP: 0.091, SLG: 0.048		0-3 K		0-0 3-1		4-0 FC5-2 BB		0-3 K																											
Andy Seminick, R (7, PH) OBP: 0.360, SLG: 0.290																																			
Inning Stats	R: 0 H: 1 E: 0 LOB: 2 K: 0 BB: 1 S: 4 P: 8	R: 0 H: 1 E: 1 LOB: 1 K: 1 BB: 0 S: 6 P: 6	R: 0 H: 0 E: 0 LOB: 0 K: 1 BB: 0 S: 5 P: 5	R: 0 H: 2 E: 0 LOB: 1 K: 1 BB: 0 S: 6 P: 6	R: 0 H: 0 E: 0 LOB: 0 K: 0 BB: 0 S: 3 P: 3	R: 0 H: 0 E: 0 LOB: 2 K: 1 BB: 2 S: 5 P: 13	R: 1 H: 1 E: 0 LOB: 2 K: 0 BB: 2 S: 4 P: 12	R: 2 H: 3 E: 0 LOB: 1 K: 2 BB: 0 S: 10 P: 10	R: 0 H: 0 E: 0 LOB: 0 K: 0 BB: 0 S: 3 P: 3																										
PITCHER	IP WLS BF H R ER SO BB IBB HBP BLK WP HR S P ERA WHIP																																		
Ruben Gomez, R (1, 1) ERA: 2.96	7.0	32	7	3	3	4	4	1	0	0	0	0	1	35	55	3.86	1.571																		
Mary Grissom, R (8, 1) ERA: 1.66	2.0	W	7	1	0	0	2	0	0	0	0	0	0	11	11	0.00	0.500																		



BOTTOM

Cincinnati Redlegs @ New York Giants  
Polo Grounds, New York, NY  
Tue Jun 15 1954, 3:33 AM EDT  
Att. 12,414 - Unknown

livebaseballscorecards.com

AB	32
R	5
H	9
RBI	5
BB	5
SO	4
LOB	19



WP	0	PA	39
PB	0		
SB	1		
CS	0		

AB R H RBI BB SO LOB

4	1	2	0	1	1	0
5	1	3	0	0	0	3
3	1	1	3	0	0	1
3	0	0	0	1	1	4
4	0	1	1	0	1	3
2	0	0	0	2	0	1
4	0	1	0	0	0	2
3	1	1	1	1	1	2
0	1	0	0	0	0	0
3	0	0	0	0	0	2
0	0	0	0	0	0	0
1	0	0	0	0	0	1

4-0

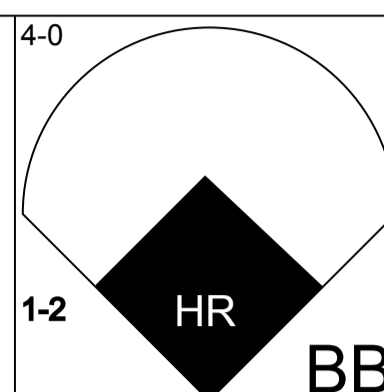

1-2

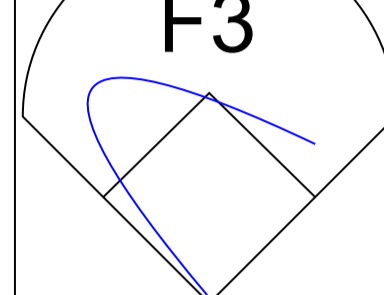

0-0

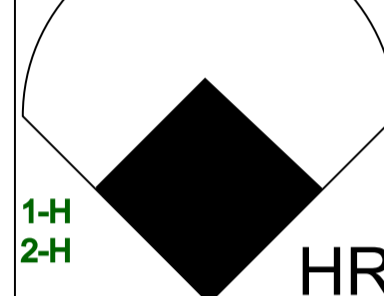

1-H  
2-H

0-0

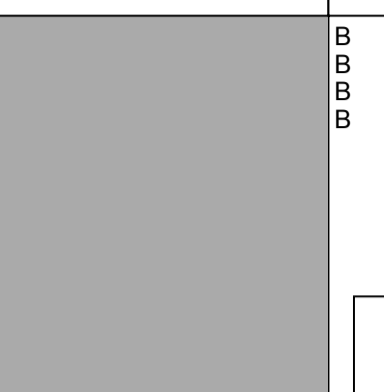

0-0



0-0

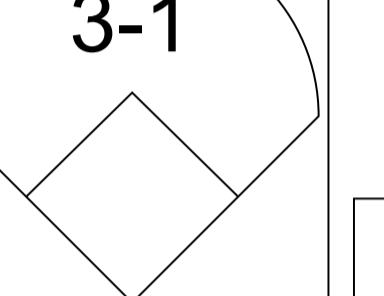

4-0

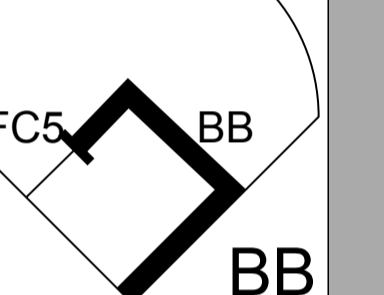

0-3

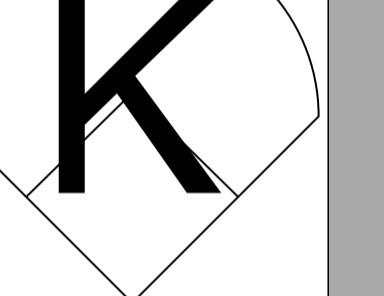

4-0

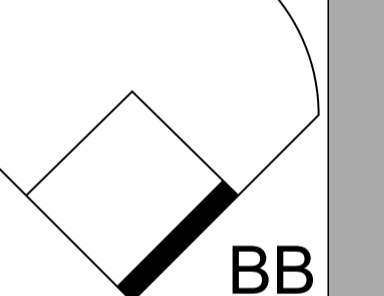

0-0

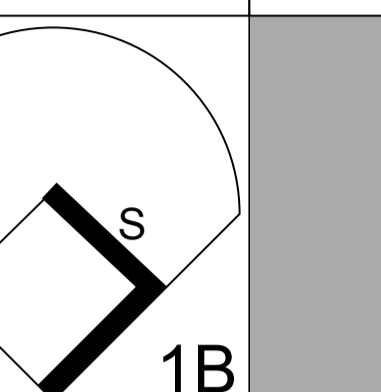

0-0

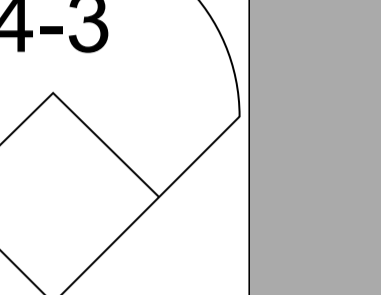

0-0

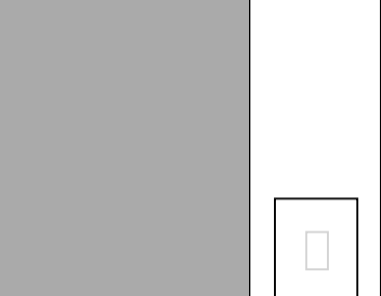

2-3

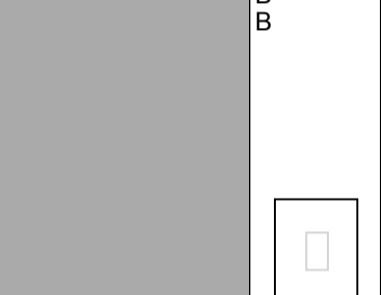

0-0

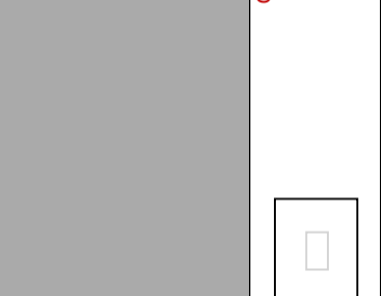

3-H

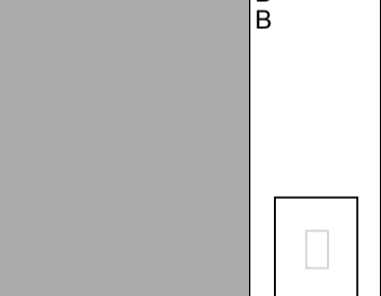

0-0

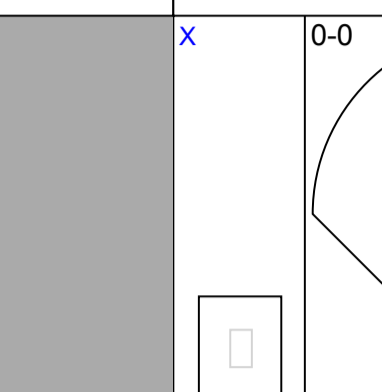

0-0

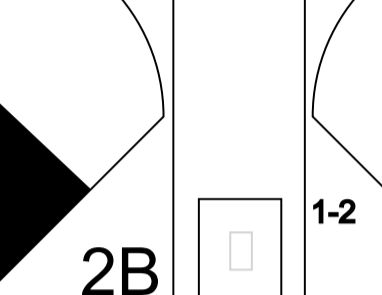

0-0

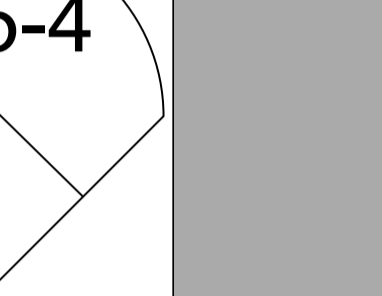

0-0

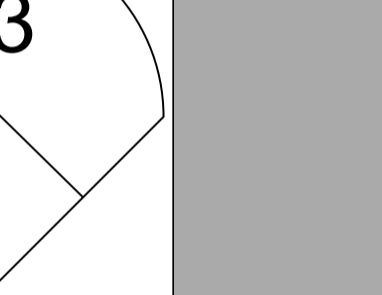

0-0

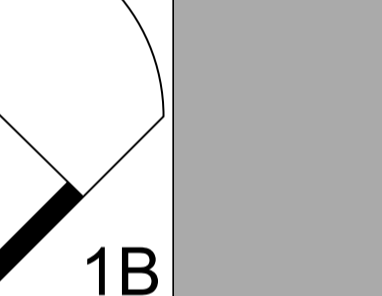

0-0

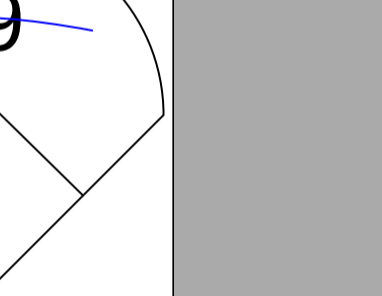

0-0

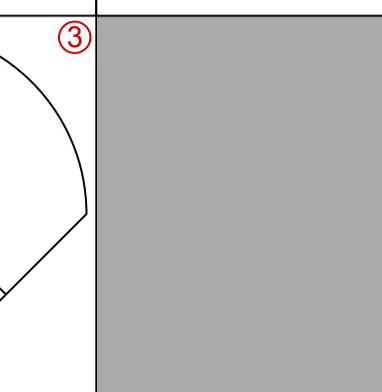

0-0

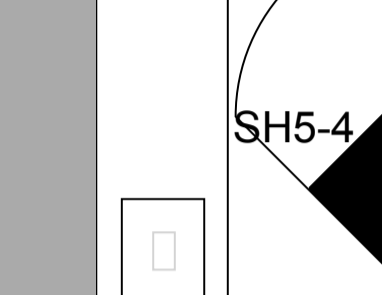

0-0

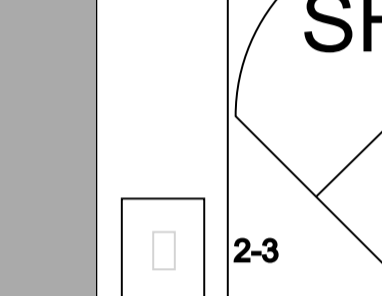

0-0

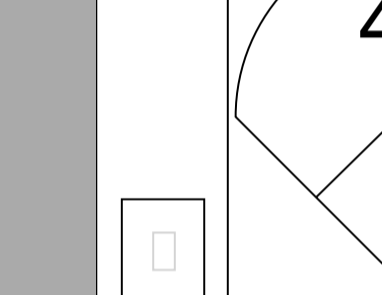

0-0

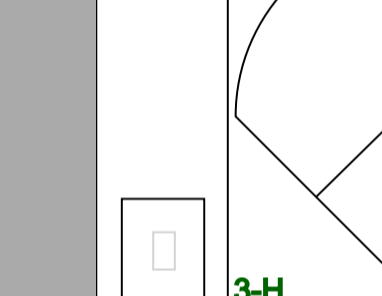

0-0

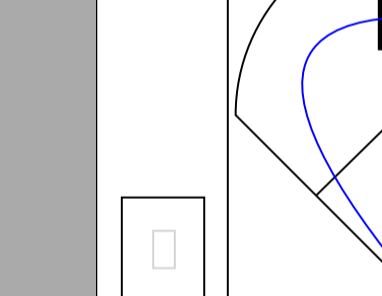

0-0

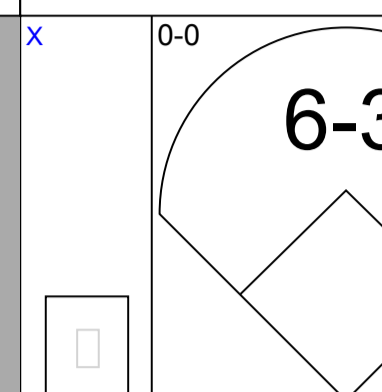

0-0



0-0



0-0



0-0



0-0



0-3

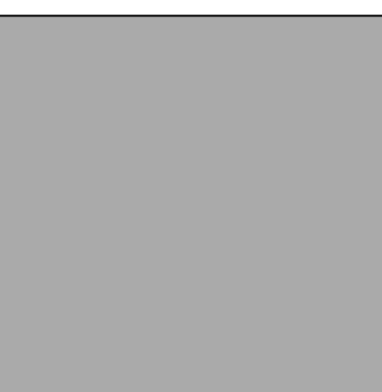

0-0



0-0



0-0



0-0

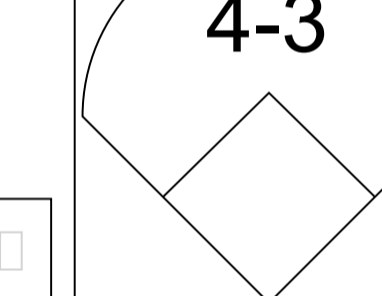

0-0

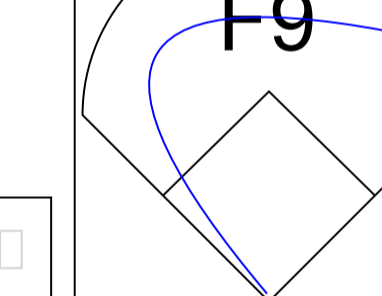

0-3

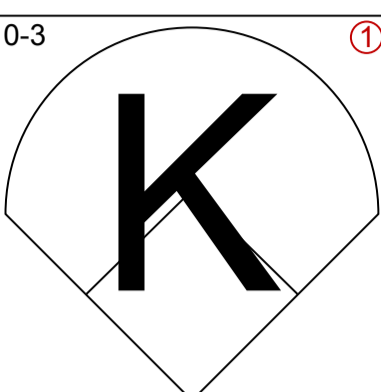

0-0

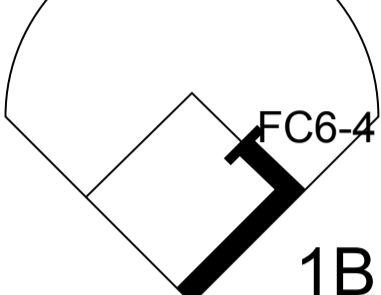

0-0

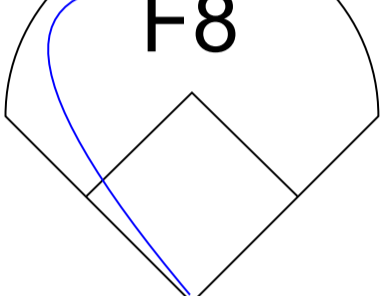

0-0

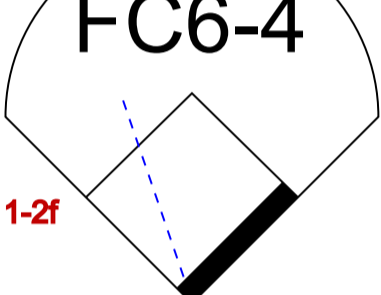

0-0



4-0



0-0

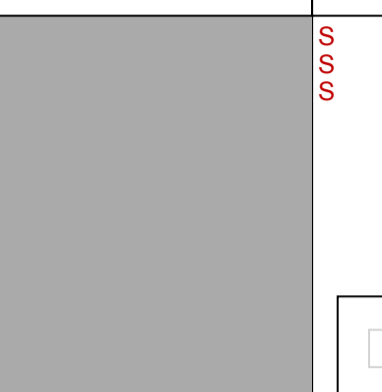

0-0



0-0

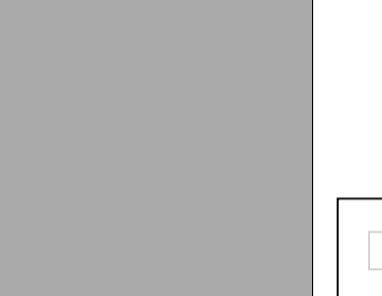

0-3



0-0



0-0

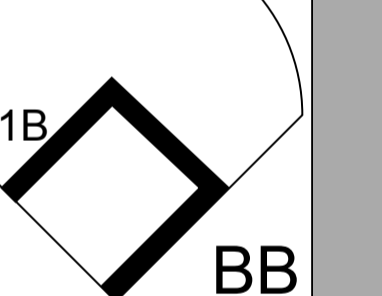

0-0

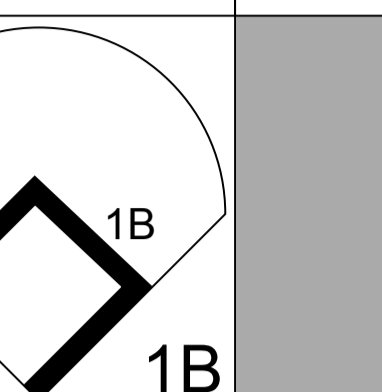

0-0

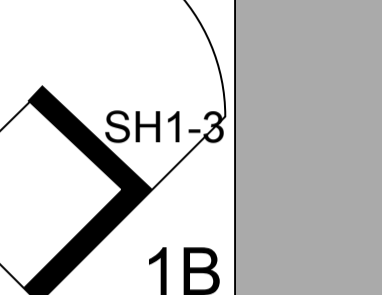

0-0

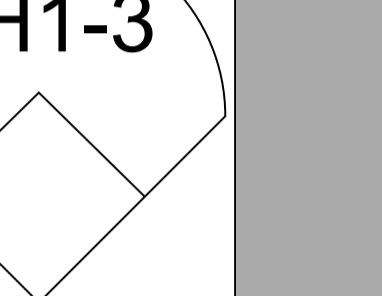

0-3

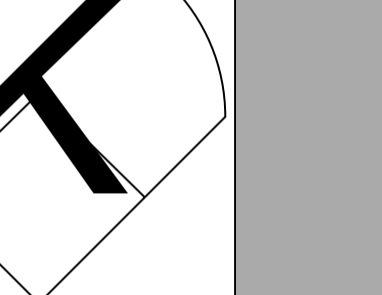

0-0

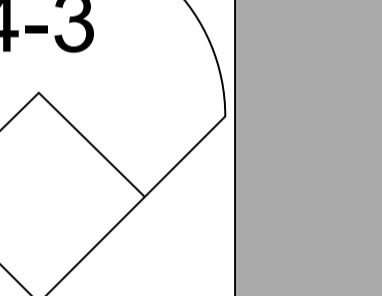

0-0

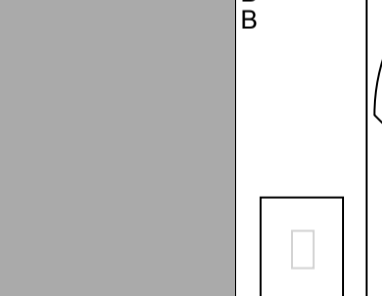

0-0

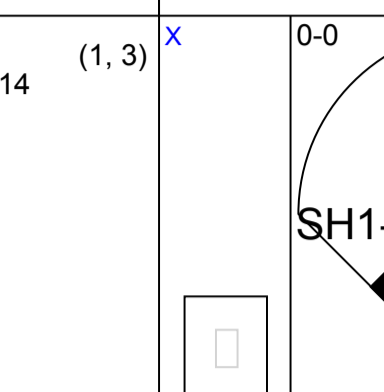

0-0

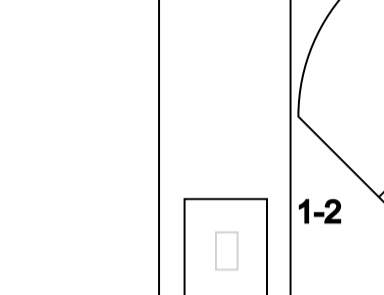

0-0

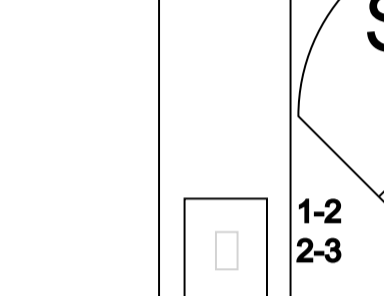

0-3

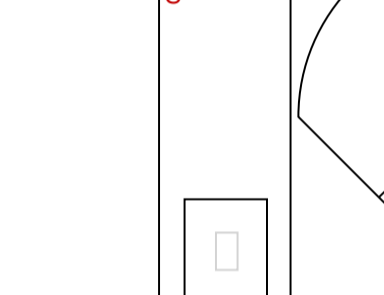

0-0

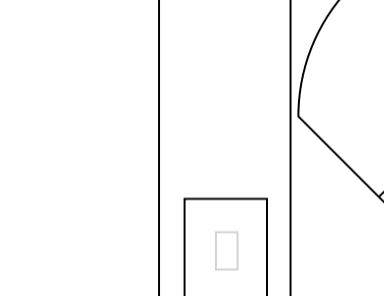

0-0

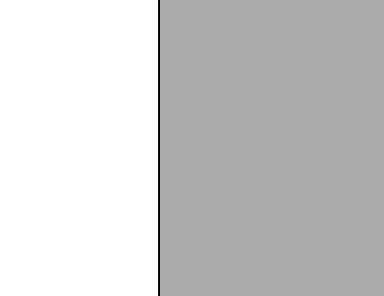

0-0

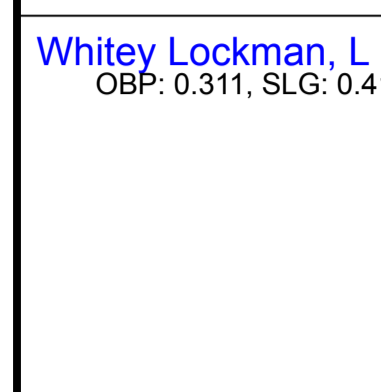

0-0

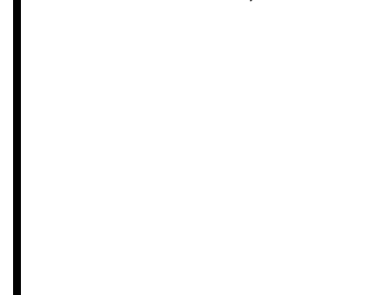

0-0



0-3

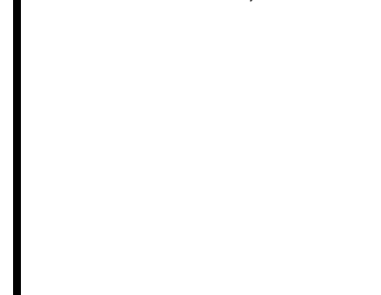

0-0

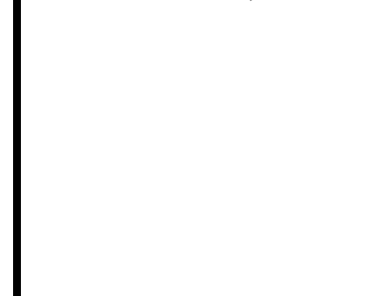

0-0



R: 0	H: 2	R: 0	H: 1	R: 0	H: 1	R: 0	H: 0	R: 0	H: 0	R: 1	H: 2	R: 1	H: 2	R: 0	H: 0	R: 3	H: 1
E: 0	LOB: 2	E: 0	LOB: 1	E: 0	LOB: 1	E: 0	LOB: 0	E: 0	LOB: 0	E: 0	LOB: 1	E: 0	LOB: 1	E: 0	LOB: 0	E: 0	LOB: 1
K: 1	BB: 0	K: 1	BB: 1	K: 1	BB: 0	K: 0	BB: 0	K: 0	BB: 0	K: 0	BB: 0	K: 0	BB: 0	K: 1	BB: 0	K: 0	BB: 2
S: 7	P: 7	S: 5	P: 9	S: 6	P: 6	S: 3	P: 3	S: 3	P: 3	S: 5	P: 5	S: 5	P: 5	S: 5	P: 13	S: 3	P: 11

Inning Stats

PITCHER	IP	WLS	BF	H	R	ER	SO	BB	IBB	HBP	BLK	WP	HR	S	P	ERA	WHIP
Fred Baczewski, L	(1, 1)		24	6	1	1	3	1	0	0	0	0	0	29	33	1.50	1.167
Frank Smith, R	(7, 1)		5	2	1	1	0	0	0	0	0	0	1	5	5	9.00	2.000
Harry Perkowski, L	(8, 1)	L	8	0	2	2	1	4	0	0	0	0	0	6	22	13.50	3.000
Howie Judson, R	(9, 1)		1	0	0	0	0	0	0	0	0	0	0	1	1	0.00	0.000
Jackie Collum, L	(9, 1)		1	1	1	0	0	0	0	0	0	0	1	1	1	∞	∞

PITCHER	IP	WLS	BF	H	R	ER	SO	BB	IBB	HBP	BLK	WP	HR	S	P	ERA	WHIP
Fred Baczewski, L	(1, 1)		24	6	1	1	3	1	0	0	0	0	0	29	33	1.50	1.167
Frank Smith, R	(7, 1)		5	2	1	1	0	0	0	0	0	0	1	5	5	9.00	2.000
Harry Perkowski, L	(8, 1)	L	8	0	2	2	1	4	0	0	0	0	0	6	22	13.50	3.000
Howie Judson, R	(9, 1)		1	0	0	0	0	0	0	0	0	0	0	1	1	0.00	0.000
Jackie Collum, L	(9, 1)		1	1	1	0	0	0	0	0	0	0	1	1	1	∞	∞

PITCHER	IP	WLS	BF	H	R	ER	SO	BB	IBB	HBP	BLK	WP	HR	S	P	ERA	WHIP
Fred Baczewski, L	(1, 1)		24	6	1	1	3	1	0	0	0	0	0	29	33	1.50	1.167
Frank Smith, R	(7, 1)		5	2	1	1	0	0	0	0	0	0	1	5	5	9.00	2.000
Harry Perkowski, L	(8, 1)	L	8	0	2	2	1	4	0	0	0	0	0	6	22	13.50	3.000
Howie Judson, R	(9, 1)		1	0	0	0	0	0	0	0	0	0	0	1	1	0.00	0.000
Jackie Collum, L	(9, 1)		1	1	1	0	0	0	0	0	0	0	1	1	1	∞	∞



Batter	1	2	3	4	5	6	7	8	9	AB	R	H	RBI	BB	SO	LOB
<b>Whitey Lockman, L</b> (1, 3) OBP: 0.321, SLG: 0.425	4-0 WP BB	0-0 2-H 2B		1-2 1B		0-0 F7		0-0 1-3 1B		4	0	3	1	1	0	0
<b>Alvin Dark, R</b> (1, 6) OBP: 0.332, SLG: 0.419	0-0 F9	0-0 4-3		0-0 F7		0-0 1B		4-0 S BB		4	0	1	0	1	0	4
<b>Hank Thompson, L</b> (1, 5) OBP: 0.399, SLG: 0.514	4-0 G6-4-3 BB		0-0 1B		0-0 4-3	0-3 K		4-0 FC6-4 BB		3	0	1	0	2	1	1
<b>Monte Irvin, R</b> (1, 7) OBP: 0.351, SLG: 0.444	0-0 G6-4-3 1-2f		0-0 F6		0-0 F4		0-0 6-3	0-0 FC6-4 1-2f		5	0	0	0	0	0	6
<b>Don Mueller, L</b> (1, 9) OBP: 0.383, SLG: 0.453		0-0 1B 2B 1B	0-3 K		0-0 BB 1B		0-0 FC6-4 1B			4	1	3	0	0	1	1
<b>Willie Mays, R</b> (1, 8) OBP: 0.378, SLG: 0.630		0-0 2B SF8 1B	0-0 F9		4-0 BB		0-0 F7			3	1	1	0	1	0	2
<b>Davey Williams, R</b> (1, 4) OBP: 0.261, SLG: 0.317		0-0 2B 2B	1-3 2-H	4-0 E 9-2 BB	0-0 F8		0-0 FC6-4 1-2f			3	1	1	1	1	0	3
<b>Ray Katt, R</b> (1, 2) OBP: 0.337, SLG: 0.403		0-0 SF8	0-0 E6 1B	0-0 HR		0-0		0-0 F7		3	1	1	2	0	0	1
<b>Jim Hearn, R</b> (1, 1) OBP: 0.188, SLG: 0.400		0-3 K	0-0 9-2	0-0 6-3				4-0 1B BB		3	0	0	0	1	1	3

Inning Stats	R: 0	H: 0	E: 0	K: 0	S: 2	R: 3	H: 4	E: 0	K: 1	S: 9	R: 0	H: 1	E: 0	K: 1	S: 6	R: 0	H: 1	E: 0	K: 0	S: 4	R: 1	H: 2	E: 0	K: 1	S: 7	R: 0	H: 1	E: 0	K: 0	S: 4	R: 0	H: 1	E: 0	K: 0	S: 3	
	LOB: 1	BB: 2	P: 10	LOB: 1	BB: 0	P: 9	LOB: 1	BB: 0	P: 6	LOB: 2	BB: 1	P: 8	LOB: 1	BB: 0	P: 7	LOB: 1	BB: 3	P: 15																		

PITCHER	IP	WLS	BF	H	R	ER	SO	BB	IBB	HBP	BLK	WP	HR	S	P	ERA	WHIP
<b>Joe Nuxhall, L</b> (1, 1) ERA: 3.8	7.0	L	34	10	4	4	3	4	0	0	0	1	1	36	52	5.14	2.000
<b>Mario Picone, R</b> (8, 1) ERA: 6.16	1.0		6	1	0	0	0	3	0	0	0	0	0	3	15	0.00	4.000

**BOTTOM**

**Cincinnati Redlegs @ New York Giants**

Polo Grounds, New York, NY

Wed Jun 16 1954, 3:33 AM EDT  
Att. 2,266 - Cloudy

<b>AB</b>	<b>32</b>
<b>R</b>	<b>4</b>
<b>H</b>	<b>11</b>
<b>RBI</b>	<b>4</b>
<b>BB</b>	<b>7</b>
<b>SO</b>	<b>3</b>
<b>LOB</b>	<b>21</b>



1B	2B	3B	HR	SF	SAC	DP	HBP	WP	HR	S	P	ERA	WHIP
8	3	0	1	1	0	2	0	1	1	3			

Batter	1	2	3	4	5	6	7	8	9	AB R H RBI BB SO LOB	TOP											
Nino Escalera, L (1, 9) OBP: 0.277, SLG: 0.195	0-0 F8		0-0 E1 2-H 1B			0-0 1-3		0-3 K		4 0 1 0 0 1 0												
Chuck Harmon, R (1, 5) OBP: 0.250, SLG: 0.250	0-0 4-3		0-0 1-3			0-0 4-3		0-0 F3		4 0 0 0 0 0 1												
Gus Bell, L (1, 8) OBP: 0.369, SLG: 0.532	0-0 F7					0-0 1B				4 0 1 0 0 0 0												
Ted Kluszewski, L (1, 3) OBP: 0.384, SLG: 0.607		0-0 F9		0-0 FC5-4 1B		0-0 G3				4 0 1 0 0 0 1												
Jim Greengrass, R (1, 7) OBP: 0.279, SLG: 0.430		0-0 F7		0-0 F9			0-0 P4			4 0 0 0 0 0 1												
Johnny Temple, R (1, 4) OBP: 0.372, SLG: 0.350		0-0 6-3		0-0 FC5-4 1-2f			0-0 6-3			3 0 0 0 0 0 1												
Andy Seminick, R (1, 2) OBP: 0.360, SLG: 0.292			0-0 F8		0-0 F7		0-0 FC6-4 1B			3 0 1 0 0 0 0												
Roy McMillan, R (1, 6) OBP: 0.301, SLG: 0.294			0-0 SH2-4 E 1B		0-0 F6		0-0 FC6-4 1-2f			3 1 1 0 0 0 1												
Art Fowler, R (1, 1) OBP: 0.160, SLG: 0.087			0-0 SH2-4		0-0 F9			0-0 F8		1 0 0 0 0 0 0												
Bob Borkowski, R (8, PH) OBP: 0.269, SLG: 0.367			1-2							1 0 0 0 0 0 0												
Frank Smith, R (8, 1)										0 0 0 0 0 0 0												
<b>Inning Stats</b>	R: 0 E: 0 K: 0 S: 3	H: 0 LOB: 0 BB: 0 P: 3	R: 0 E: 0 K: 0 S: 3	H: 0 LOB: 0 BB: 0 P: 3	R: 1 E: 1 K: 0 S: 5	H: 2 LOB: 1 BB: 0 P: 5	R: 0 E: 0 K: 0 S: 4	H: 1 LOB: 1 BB: 0 P: 4	R: 0 E: 0 K: 0 S: 3	H: 0 LOB: 0 BB: 0 P: 3	R: 0 E: 0 K: 0 S: 4	H: 1 LOB: 1 BB: 0 P: 4	R: 0 E: 0 K: 0 S: 4	H: 1 LOB: 1 BB: 0 P: 4	R: 0 E: 0 K: 1 S: 5	H: 0 LOB: 0 BB: 0 P: 5	R: 0 E: 0 K: 0 S: 3	H: 0 LOB: 0 BB: 0 P: 3	1B: 5 2B: 0 3B: 0 HR: 0	SF: 0 SAC: 1 DP: 0 HBP: 0	WP: 0 PB: 0 SB: 0 CS: 0	PA: 32
<b>PITCHER</b> Johnny Antonelli, L (1, 1) ERA: 2.18	IP: 9.0 WLS: W BF: 32 H: 5 R: 1 ER: 0 SO: 1 BB: 0 IBB: 0 HBP: 0 BLK: 0 WP: 0 HR: 0 S: 34 P: 34 ERA: 0.00 WHIP: 0.556																				<b>PITCHER</b> IP: WLS: BF: H: R: ER: SO: BB: IBB: HBP: BLK: WP: HR: S: P: ERA: WHIP	

Cincinnati Redlegs @ New York Giants  
Polo Grounds, New York, NY  
Thu Jun 17 1954, 3:33 AM EDT  
Att. 4,753 - Unknown

livebaseballscorecards.com

AB	31
R	1
H	5
RBI	0
BB	0
SO	1
LOB	5



Batter	1	2	3	4	5	6	7	8	9
Whitey Lockman, L (1, 3) OBP: 0.316, SLG: 0.417	0-0 F5		0-0 F8		0-0 FC3 E BB FC6-4		0-0 F8		
Alvin Dark, R (1, 6) OBP: 0.331, SLG: 0.414	0-0 F5		0-0 4-1		4-0 FC6-4 E BB 1-2 2-3		0-3 K		
Hank Thompson, L (1, 5) OBP: 0.401, SLG: 0.508	4-0 BB		4-0 BB		0-0 E4 FC6-4 1-2 2-3 3-H		0-0 4-3		
Monte Irvin, R (1, 7) OBP: 0.346, SLG: 0.435	0-0 F9		0-0 F8		0-0 FC6-4 1-2 2-3 3-H		0-3 K2-3		
Don Mueller, L (1, 9) OBP: 0.381, SLG: 0.449		0-0 6-3		0-0 F7		0-0 F8		0-0 1B	
Willie Mays, R (1, 8) OBP: 0.376, SLG: 0.623		0-0 FC6-4 1B		0-0 F8		0-0 F8		0-0 F8	
Davey Williams, R (1, 4) OBP: 0.257, SLG: 0.312		0-0 FC6-4 1-2f		0-0 6-3		0-0 F7			
Ray Katt, R (1, 2) OBP: 0.326, SLG: 0.387		0-0 F7			0-0 L7		0-0 F7		
Johnny Antonelli, L (1, 1) OBP: 0.227, SLG: 0.262			0-0 E9 4-1		4-0 BB E E BB		0-0 4-3		

Inning Stats	R: 0	H: 0	E: 0	K: 0	S: 3	LOB: 1	BB: 1	P: 7	R: 0	H: 1	E: 0	K: 0	S: 4	LOB: 1	BB: 0	P: 4	R: 0	H: 0	E: 1	K: 0	S: 4	LOB: 2	BB: 1	P: 8	R: 0	H: 0	E: 0	K: 0	S: 3	LOB: 0	BB: 0	P: 3	R: 2	H: 0	E: 2	K: 0	S: 5	LOB: 2	BB: 2	P: 13	R: 0	H: 0	E: 0	K: 0	S: 3	LOB: 0	BB: 0	P: 3	R: 0	H: 0	E: 0	K: 1	S: 5	LOB: 0	BB: 0	P: 5	R: 0	H: 1	E: 0	K: 1	S: 6	LOB: 1	BB: 0	P: 6
1B: 2	SF: 0	2B: 0	SAC: 0	3B: 0	DP: 0	HR: 0	HBP: 0	WP: 0	PA: 33																																																							

PITCHER	IP	WLS	BF	H	R	ER	SO	BB	IBB	HBP	BLK	WP	HR	S	P	ERA	WHIP
Art Fowler, R (1, 1) ERA: 3.15	7.0	L	29	1	2	0	1	4	0	0	0	0	0	27	43	0.00	0.714
Frank Smith, R (8, 1) ERA: 1.59	1.0		4	1	0	0	1	0	0	0	0	0	0	6	6	0.00	1.000

**BOTTOM**

**Cincinnati Redlegs @ New York Giants**  
Polo Grounds, New York, NY

Thu Jun 17 1954, 3:33 AM EDT  
Att. 4,753 - Unknown

AB	29
R	2
H	2
RBI	2
BB	4
SO	2
LOB	15



PITCHER	IP	WLS	BF	H	R	ER	SO	BB	IBB	HBP	BLK	WP	HR	S	P	ERA	WHIP
---------	----	-----	----	---	---	----	----	----	-----	-----	-----	----	----	---	---	-----	------

Batter	1	2	3	4	5	6	7	8	9	AB R H RBI BB SO LOB	TOP		
Rip Repulski, R OBP: 0.322, SLG: 0.432 (1, 7) X	0-0 HR	0-0 6-3		0-0 1B 1B		0-3 K		0-0 F7		5 2 2 1 0 1 1			
Red Schoendienst, S OBP: 0.366, SLG: 0.471 (1, 4) B B B	4-0 4-3 4-3 BB	0-0 2-H 2B		0-0 P4		0-0 1B 1B		0-0 HR 1B		4 1 3 1 1 0 1			
Stan Musial, L OBP: 0.458, SLG: 0.738 (1, 9) X	0-0 4-3 1-2	4-0 FC6-4 IBB		0-0 1B 1-2 1B		0-0 P4		0-0 1-H HR		4 1 2 2 1 0 2			
Ray Jablonski, R OBP: 0.399, SLG: 0.532 (1, 5) X	0-0 E5 4-3	0-0 FC6-4 1-2		0-0 1-3 2-H 1B		0-0 1-2 1B		0-0 5-3		5 0 2 1 0 0 3			
Wally Moon, L OBP: 0.397, SLG: 0.492 (1, 8) X	0-0 4-3 1-2 2-3		0-0 1-3	0-0 4-3		0-0 L6		0-0 F7		5 0 0 0 0 0 6			
Tom Alston, L OBP: 0.315, SLG: 0.366 (1, 3)	4-0 IBB		0-0 5-3 1B		0-0 F8		0-0 F3	0-0 F8		4 0 1 0 1 0 0			
Bill Sarni, R OBP: 0.417, SLG: 0.654 (1, 2) X	0-0 1-3		0-0 5-3 1-2		0-0 3B		0-0 1B	0-0 F9		5 0 2 0 0 0 4			
Alex Grammas, R OBP: 0.311, SLG: 0.305 (1, 6) B B B B		4-0 2B BB	0-0 6-3		0-0 5-3		0-3 K	0-0 F9		4 0 0 0 1 1 3			
Harvey Haddix, L OBP: 0.292, SLG: 0.333 (1, 1) X		0-0 1-H 2B 2B		0-0 P6		0-0 F2		0-0 3-1		4 1 1 0 0 0 2			
<b>Inning Stats</b>	R: 1 E: 1 K: 0 S: 5 H: 1 LOB: 3 BB: 2 P: 13	R: 1 E: 0 K: 0 S: 4 H: 2 LOB: 2 BB: 2 P: 12	R: 0 E: 0 K: 0 S: 4 H: 1 LOB: 1 BB: 0 P: 4	R: 1 E: 0 K: 0 S: 6 H: 3 LOB: 2 BB: 0 P: 6	R: 0 E: 0 K: 0 S: 4 H: 1 LOB: 1 BB: 0 P: 4	R: 0 E: 0 K: 1 S: 7 H: 2 LOB: 2 BB: 0 P: 7	R: 0 E: 0 K: 1 S: 6 H: 1 LOB: 1 BB: 0 P: 6	R: 2 E: 0 K: 0 S: 5 H: 2 LOB: 0 BB: 0 P: 5	R: 0 E: 0 K: 0 S: 3 H: 0 LOB: 0 BB: 0 P: 3	1B: 8 2B: 2 3B: 1 HR: 2 SF: 0 SAC: 0 DP: 0 HBP: 0	WP: 0 PB: 0 SB: 0 CS: 0 PA: 44		
<b>PITCHER</b>	IP WLS BF H R ER SO BB IBB HBP BLK WP HR S P ERA WHIP											<b>PITCHER</b>	IP WLS BF H R ER SO BB IBB HBP BLK WP HR S P ERA WHIP
Sal Maglie, R ERA: 3.31 (1, 1)	3.2 L 21 6 3 3 0 2 2 0 0 0 0 1 17 33 7.36 2.182												
Windy McCall, L ERA: 2.36 (4, 1)	4.1 20 7 2 2 2 0 0 0 0 0 0 1 24 24 4.15 1.615												
Alex Konikowski, R ERA: 5.4 (9, 1)	1.0 3 0 0 0 0 0 0 0 0 0 0 0 3 3 0.00 0.000												

St. Louis Cardinals @ New York Giants  
Polo Grounds, New York, NY  
Fri Jun 18 1954, 3:33 AM EDT  
Att. 31,093 - Unknown

livebaseballscorecards.com

AB 40  
R 5  
H 13  
RBI 5  
BB 4  
SO 2  
LOB 22



Batter	1	2	3	4	5	6	7	8	9	AB R H RBI BB SO LOB
Whitey Lockman, L (1, 3) OBP: 0.311, SLG: 0.410	0-0 F8		0-0 F3		0-3 K			0-0 F7		4 0 0 0 0 1 0
Alvin Dark, R (1, 6) OBP: 0.330, SLG: 0.411	0-0 FC4-6 1B		0-0 F9			0-0 F2		0-0 G3		4 0 1 0 0 0 0
Hank Thompson, L (1, 5) OBP: 0.398, SLG: 0.500	0-0 FC4-6 BB 1-2f		4-0 BB			0-0 F3			0-3 K	3 0 0 0 1 1 1
Monte Irvin, R (1, 7) OBP: 0.344, SLG: 0.429	4-0 BB 1-2		0-3 K			0-0 P6			0-0 4-3	3 0 0 0 1 1 1
Don Mueller, L (1, 9) OBP: 0.383, SLG: 0.450	0-0 G3			0-3 K			0-0 FC6-4 1B		0-0 1B	4 0 2 0 0 1 2
Willie Mays, R (1, 8) OBP: 0.369, SLG: 0.612		0-0 F8		0-0 6-3		0-0 P6		0-0 F8		4 0 0 0 0 0 2
Davey Williams, R (1, 4) OBP: 0.254, SLG: 0.307		0-0 1-3		0-3 K		0-0 FC6-4 1-2f				3 0 0 0 0 1 1
Ray Katt, R (1, 2) OBP: 0.326, SLG: 0.385		0-0 FC5-4 1B			0-0 6-3	0-3 K2-3				3 0 1 0 0 1 1
Sal Maglie, R (1, 1) OBP: 0.129, SLG: 0.100		0-0 FC5-4			0-3 K			0-0 F9		1 0 0 0 0 0 1
Windy McCall, L (4, 1)										1 0 0 0 0 1 0
Bobby Hofman, R (8, PH) OBP: 0.111, SLG: 0.370										1 0 0 0 0 0 0
Alex Konikowski, R (9, 1)										0 0 0 0 0 0 0

Inning Stats	R: 0	H: 1	E: 0	LOB: 2	K: 0	BB: 1	S: 4	P: 8	R: 0	H: 1	E: 0	LOB: 1	K: 0	BB: 0	S: 4	P: 4	R: 0	H: 0	E: 0	LOB: 1	K: 1	BB: 1	S: 5	P: 9	R: 0	H: 0	E: 0	LOB: 0	K: 2	BB: 0	S: 7	P: 7	R: 0	H: 0	E: 0	LOB: 0	K: 2	BB: 0	S: 7	P: 7	R: 0	H: 0	E: 0	LOB: 0	K: 0	BB: 0	S: 3	P: 3	R: 0	H: 1	E: 1	LOB: 1	K: 1	BB: 0	S: 6	P: 6	R: 0	H: 0	E: 0	LOB: 0	K: 0	BB: 0	S: 3	P: 3	R: 0	H: 1	E: 0	LOB: 1	K: 1	BB: 0	S: 6	P: 6	R: 0	H: 0	E: 0	LOB: 0	K: 1	BB: 0	S: 6	P: 6
PITCHER Harvey Haddix, L (1, 1) ERA: 2.99	IP	WLS	BF	H	R	ER	SO	BB	IBB	HBP	BLK	WP	HR	S	P	ERA	WHIP	IP	WLS	BF	H	R	ER	SO	BB	IBB	HBP	BLK	WP	HR	S	P	ERA	WHIP	IP	WLS	BF	H	R	ER	SO	BB	IBB	HBP	BLK	WP	HR	S	P	ERA	WHIP																													

**BOTTOM**

**St. Louis Cardinals @ New York Giants**  
 Polo Grounds, New York, NY  
 Fri Jun 18 1954, 3:33 AM EDT  
 Att. 31,093 - Unknown

AB	31
R	0
H	4
RBI	0
BB	2
SO	7
LOB	9



Batter	1	2	3	4	5	6	7	8	9	AB R H RBI BB SO LOB	TOP																
Rip Repulski, R (1, 7) OBP: 0.323, SLG: 0.452	0-0 SF9 3B	0-0 FC5-4 1-2f		0-0 F9					0-0 E6 G4-6-3	5 2 2 1 0 0 4																	
Red Schoendienst, S (1, 4) OBP: 0.363, SLG: 0.475	0-0 SF9		0-0 F8		0-0 3B		0-0 5-3		0-0 G4-6-3 1-2f	4 0 1 1 0 0 2																	
Stan Musial, L (1, 9) OBP: 0.459, SLG: 0.732	4-0 FC4-6 BB		4-0 CS BB		0-0 6-3		0-0 P3			2 0 0 0 2 0 1																	
Ray Jablonski, R (1, 5) OBP: 0.396, SLG: 0.528	0-0 FC4-6 FC6-4 1-2f		0-0 1B 1B		0-0 P3		0-0 P6			4 0 1 0 0 0 2																	
Bill Sarni, R (1, 2) OBP: 0.420, SLG: 0.646	0-0 FC6-4 1-2f		0-0 1B		0-3 K		0-0 FC6-4 1B			4 0 2 0 0 1 2																	
Wally Moon, L (1, 8) OBP: 0.395, SLG: 0.485		4-0 E BB	0-0 F7		0-0 4-3		0-0 FC6-4 1-2f			3 0 0 0 1 0 3																	
Alex Grammas, R (1, 6) OBP: 0.304, SLG: 0.297		0-0 F9		0-0 P6		0-0 F9		0-0 4-3		4 0 0 0 0 0 2																	
Tom Alston, L (1, 3) OBP: 0.318, SLG: 0.366		0-0 E4 FC5-4 1-2		4-0 FC5-4 BB		0-3 K			0-0 E 1B	3 0 1 0 1 1 1																	
Tom Poholsky, R (1, 1) OBP: 0.176, SLG: 0.188		0-3 K		0-0 FC5-4		0-0 F8			0-3 K	3 0 0 0 0 1 3																	
Solly Hemus, L (9, PH) OBP: 0.457, SLG: 0.475										1 0 0 0 0 1 1																	
Stu Miller, R (9, 1) OBP: 0.357, SLG: 0.308										0 0 0 0 0 0 0																	
Joe Presko, R (9, 1)										0 0 0 0 0 0 0																	
<b>Inning Stats</b>	R: 1 E: 0 K: 0 S: 4	H: 1 LOB: 1 BB: 1 P: 8	R: 0 E: 1 K: 1 S: 6	H: 0 LOB: 2 BB: 1 P: 10	R: 0 E: 0 K: 0 S: 4	H: 2 LOB: 2 BB: 1 P: 8	R: 0 E: 0 K: 0 S: 3	H: 0 LOB: 1 BB: 1 P: 7	R: 0 E: 0 K: 1 S: 6	H: 1 LOB: 1 BB: 0 P: 6	R: 0 E: 0 K: 1 S: 5	H: 0 LOB: 0 BB: 0 P: 5	R: 1 E: 0 K: 0 S: 4	H: 1 LOB: 0 BB: 0 P: 4	R: 0 E: 0 K: 0 S: 4	H: 1 LOB: 1 BB: 0 P: 4	R: 0 E: 1 K: 1 S: 6	H: 1 LOB: 1 BB: 0 P: 6	1B: 4 2B: 0 3B: 2 HR: 1	SF: 1 SAC: 0 DP: 1 HBP: 0	WP: 0 PB: 0 SB: 0 CS: 1	PA: 38					
<b>PITCHER</b>	IP WLS BF H R ER SO BB IBB HBP BLK WP HR S P ERA WHIP																										
Don Liddle, L (1, 1) ERA: 3.33	7.0		30	5	2	2	3	4	0	0	0	0	0	32	48	2.57	1.286										
Hoyt Wilhelm, R (8, 1) ERA: 2.14	2.0	W	8	2	0	0	1	0	0	0	0	0	0	10	10	0.00	1.000										

St. Louis Cardinals @ New York Giants  
Polo Grounds, New York, NY  
Sat Jun 19 1954, 3:33 AM EDT  
Att. 14,656 - Unknown

livebaseballscorecards.com

AB	33
R	2
H	7
RBI	2
BB	4
SO	4
LOB	21





BOTTOM

St. Louis Cardinals @ New York Giants  
Polo Grounds, New York, NY  
Sat Jun 19 1954, 3:33 AM EDT  
Att. 14,656 - Unknown

livebaseballscorecards.com

AB	32
R	5
H	8
RBI	5
BB	2
SO	3
LOB	11



WP:	0	PA:	36
PB:	0		
SB:	0		
CS:	0		

AB	R	H	RBI	BB	SO	LOB
3	0	1	0	1	0	1
3	0	0	0	0	0	1
3	0	0	0	0	1	1
1	0	0	0	0	0	1
4	0	1	0	0	0	1
4	0	1	0	0	0	2
4	2	3	1	0	0	1
3	0	0	0	0	0	1
0	1	0	0	1	0	0
3	0	1	1	0	1	1
0	1	0	0	0	0	0
2	0	0	0	0	1	1
1	0	0	0	0	0	0
0	0	0	0	0	0	0
1	1	1	3	0	0	0

R	H	ER	SO	BB	IBB	HBP	BLK	WP	HR	S	P	ERA	WHIP
4	3	3	1	1	0	0	0	0	0	0	0	1.12	0.750
4	3	1	1	1	0	0	0	0	0	0	0	81.00	9.000
4	3	1	1	1	0	0	0	0	1	1	1	∞	∞

IP	WLS	BF	H	R	ER	SO	BB	IBB	HBP	BLK	WP	HR	S	P	ERA	WHIP
8.0		31	5	1	1	3	1	0	0	1	0	1	35	40	1.12	0.750
0.1	L	4	2	3	3	0	1	0	0	0	0	0	3	7	81.00	9.000
0.0		1	1	1	1	0	0	0	0	0	0	1	1	1	∞	∞

R	H	ER	SO	BB	IBB	HBP	BLK	WP	HR	S	P	ERA	WHIP
0	1	1	1	1	0	0	0	0	0	0	0	1.12	0.750
0	1	1	1	1	0	0	0	0	0	0	0	81.00	9.000
0	1	1	1	1	0	0	0	0	1	1	1	∞	∞

R	H	ER	SO	BB	IBB	HBP	BLK	WP	HR	S	P	ERA	WHIP
0	1	1	1	1	0	0	0	0	0	0	0	1.12	0.750
0	1	1	1	1	0	0	0	0	0	0	0	81.00	9.000
0	1	1	1	1	0	0	0	0	1	1	1	∞	∞

R	H	ER	SO	BB	IBB	HBP	BLK	WP	HR	S	P	ERA	WHIP
0	1	1	1	1	0	0	0	0	0	0	0	1.12	0.750
0	1	1	1	1	0	0	0	0	0	0	0	81.00	9.000
0	1	1	1	1	0	0	0	0	1	1	1	∞	∞

R	H	ER	SO	BB	IBB	HBP	BLK	WP	HR	S	P	ERA	WHIP
0	1	1	1	1	0	0	0	0	0	0	0	1.12	0.750
0	1	1	1	1	0	0	0	0	0	0	0	81.00	9.000
0	1	1	1	1	0	0	0	0	1	1	1	∞	∞

R	H	ER	SO	BB	IBB	HBP	BLK	WP	HR	S	P	ERA	WHIP
0	1	1	1	1	0	0	0	0	0	0	0	1.12	0.750
0	1	1	1	1	0	0	0	0	0	0	0	81.00	9.000
0	1	1	1	1	0	0	0	0	1	1	1	∞	∞

R	H	ER	SO	BB	IBB	HBP	BLK	WP	HR	S	P	ERA	WHIP
1	1	1	1	1	0	0	0	0	0	0	0	1.12	0.750
1	1	1	1	1	0	0	0	0	0	0	0	81.00	9.000
1	1	1	1	1	0	0	0	0	1	1	1	∞	∞

R	H	ER	SO	BB	IBB	HBP	BLK	WP	HR	S	P	ERA	WHIP
0	1	1	1	1	0	0	0	0	0	0	0	1.12	0.750
0	1	1	1	1	0	0	0	0	0	0	0	81.00	9.000
0	1	1	1	1	0	0	0	0	1	1	1	∞	∞

R	H	ER	SO	BB	IBB	HBP	BLK	WP	HR	S	P	ERA	WHIP
0	1	1	1	1	0	0	0	0	0	0	0	1.12	0.750
0	1	1	1	1	0	0	0	0	0	0	0	81.00	9.000
0	1	1	1	1	0	0	0	0	1	1	1	∞	∞

Batter	1	2	3	4	5	6	7	8	9	AB	R	H	RBI	BB	SO	LOB						
Davey Williams, R (1, 4) OBP: 0.258, SLG: 0.308	4-0 1B BB	0-0 FC6-4 1-2f			0-0 F8			0-0 4-3 SH2-4 1B		3	0	1	0	1	0	1						
Alvin Dark, R (1, 6) OBP: 0.326, SLG: 0.406	0-0 F8		0-0 4-3		0-0 6-3			0-0 SH2-4 1-2		3	0	0	0	0	0	1						
Whitey Lockman, L (1, 3) OBP: 0.308, SLG: 0.405 Bobby Hofman, R (7, 3) OBP: 0.107, SLG: 0.357	0-0 F2		0-0 1-6-3			0-3 K		0-0 4-3 2-3		3	0	0	0	0	1	1						
Bill Taylor, L (1, 7) OBP: 0.348, SLG: 0.524	0-0 1-2 1B		0-0 P4			0-0 4-3		0-0 4-3		4	0	1	0	0	0	1						
Don Mueller, L (1, 9) OBP: 0.381, SLG: 0.447	0-0 4-3			0-0 3-1		0-0 1B			0-0 6-3	4	0	1	0	0	0	2						
Willie Mays, R (1, 8) OBP: 0.375, SLG: 0.628		0-0 HR		0-0 BLK 1B		0-0 P2			0-0 BB 1B	4	2	3	1	0	0	1						
Billy Gardner, R (1, 5) OBP: 0.302, SLG: 0.388 Monte Irvin, R (9, PH) OBP: 0.347, SLG: 0.429		0-0 6-3		0-0 F9 1-2			0-0 P3		4-0 BB BB 1-2 HR BB	3	0	0	0	0	0	1						
Wes Westrum, R (1, 2) OBP: 0.304, SLG: 0.270 Ruben Gomez, R (9, PR) OBP: 0.226, SLG: 0.226		1-0 FC6-4 HBP		0-3 K			0-0 5-3		0-0 HR 1B 1-2 2-H	3	0	1	1	0	1	1						
Don Liddle, L (1, 1) Dusty Rhodes, L (7, PH) OBP: 0.450, SLG: 0.444 Hoyt Wilhelm, R (8, 1) Hoot Evers, R (9, PH) OBP: 0.083, SLG: 0.333		0-0 F8			0-3 K		0-0 6-3		0-0 HR 1-1 2-H	2	0	0	0	0	1	1						
Inning Stats	R: 0 E: 0 K: 0 S: 4	H: 1 LOB: 2 BB: 1 P: 8	R: 1 E: 0 K: 0 S: 4	H: 1 LOB: 1 BB: 0 P: 5	R: 0 E: 0 K: 0 S: 3	H: 0 LOB: 0 BB: 0 P: 3	R: 0 E: 0 K: 1 S: 6	H: 1 LOB: 1 BB: 0 P: 6	R: 0 E: 0 K: 1 S: 5	H: 0 LOB: 0 BB: 0 P: 5	R: 0 E: 0 K: 1 S: 6	H: 1 LOB: 1 BB: 0 P: 6	R: 0 E: 0 K: 0 S: 3	H: 0 LOB: 0 BB: 0 P: 3	R: 0 E: 0 K: 0 S: 4	H: 1 LOB: 1 BB: 0 P: 4	R: 4 E: 0 K: 0 S: 4	H: 3 LOB: 1 BB: 1 P: 8	1B: 6 2B: 0 3B: 0 HR: 2	SF: 0 SAC: 1 DP: 0 HBP: 1	WP: 0 PB: 0 SB: 0 CS: 0	PA: 36
PITCHER	IP	WLS	BF	H	R	ER	SO	BB	IBB	HBP	BLK	WP	HR	S	P	ERA	WHIP					
Tom Poholsky, R (1, 1) ERA: 3.08	8.0		31	5	1	1	3	1	0	0	1	0	1	35	40	1.12	0.750					
Stu Miller, R (9, 1) ERA: 5.79	0.1	L	4	2	3	3	0	1	0	0	0	0	0	3	7	81.00	9.000					
Joe Presko, R (9, 1) ERA: 6.34	0.0		1	1	1	1	0	0	0	0	0	0	1	1	1	∞	∞					

Batter	1	2	3	4	5	6	7	8	9	AB	R	H	RBI	BB	SO	LOB	TOP										
Rip Repulski, R OBP: 0.331, SLG: 0.473 (1, 7) X	0-0 6-3		0-0 2B 3B	4-0 BB BB		0-0 HR F8		4-0 1-2 BB		4	2	2	1	2	0	3											
Red Schoendienst, S OBP: 0.359, SLG: 0.468 (1, 4) X	0-0 4-3		0-0 1-3	0-0 F3		0-0 BB 1B	0-3 K	0-0 F5		6	1	1	0	0	1	4											
Stan Musial, L OBP: 0.460, SLG: 0.723 (1, 9) S (6, 3) S	0-3 K		4-0 2B 1B IBB	4-0 1-2 BB		4-0 1B 1-2 BB	0-0 1-3		0-0 G3	3	2	0	0	3	1	0											
Ray Jablonski, R OBP: 0.399, SLG: 0.531 (1, 5) X		0-0 5-3	0-0 1B 1-3 2B	0-0 6-3		0-0 1B 1-3 FC3-2 1B	0-0 BB 1B		0-0 4-3	6	0	3	2	0	0	2											
Wally Moon, L OBP: 0.401, SLG: 0.486 (1, 8) X		0-0 1B FC5-2 1B	4-0 1B IBB		0-0 FC3-6 1B	0-3 K BB BB	4-0 1-2 BB		0-0 F7	4	0	2	0	2	1	2											
Tom Alston, L OBP: 0.318, SLG: 0.365 (1, 3) S Peanuts Lowrey, R OBP: 0.194, SLG: 0.185 (6, PH) S (6, 9) S		0-0 FC5-2 WP 1B	0-3 K		0-0 FC3-6 1-2f	4-0 FC3-2 1B IBB	0-0 4-3			3	0	1	0	0	1	4											
Bill Sarni, R OBP: 0.452, SLG: 0.655 (1, 2) X		4-0 FC5-2 1-2 IBB	0-0 1-2 2-3 3-H 1B		4-0 IBB	0-0 1B FC3-2 1B		4-0 FC3-6 BB		2	0	2	2	3	0	0											
Alex Grammas, R OBP: 0.299, SLG: 0.291 (1, 6) S Solly Hemus, L OBP: 0.449, SLG: 0.463 (6, PH) S (6, 6) S		0-0 FC5-2	0-3 K		0-0 F8	0-0 FC3-2 1B		0-3 K		3	0	0	0	0	1	8											
Vic Raschi, R OBP: 0.195, SLG: 0.132 (1, 1) S Cot Deal, S OBP: 0.125, SLG: 0.500 (6, 1) S Al Brazier, L (6, 1) S Joe Frazier, L OBP: 0.373, SLG: 0.395 (8, PH) S Dick Schofield, S OBP: 0.200, SLG: 0.600 (8, PR) S Bill Greacon, R (8, 1) S		0-0 2-3		0-3 K	0-0 4-3	0-0 1-2 2-3 3-H 1B		0-0 FC3-6 BB		4	0	1	1	0	1	5											
<b>Inning Stats</b>	R: 0 E: 0 K: 1 S: 5	H: 0 LOB: 0 BB: 0 P: 5	R: 0 E: 0 K: 0 S: 5	H: 2 LOB: 3 BB: 1 P: 9	R: 2 E: 0 K: 2 S: 10	H: 3 LOB: 3 BB: 2 P: 18	R: 0 E: 0 K: 1 S: 5	H: 0 LOB: 2 BB: 2 P: 13	R: 0 E: 1 K: 0 S: 4	H: 1 LOB: 2 BB: 1 P: 8	R: 4 E: 0 K: 1 S: 10	H: 5 LOB: 3 BB: 2 P: 18	R: 0 E: 0 K: 1 S: 6	H: 1 LOB: 2 BB: 1 P: 10	R: 0 E: 0 K: 1 S: 5	H: 0 LOB: 2 BB: 2 P: 13	R: 0 E: 0 K: 0 S: 3	H: 0 LOB: 0 BB: 0 P: 3	1B: 9 2B: 1 3B: 1 HR: 1	SF: 0 SAC: 0 DP: 0 HBP: 0	WP: 1 PB: 0 SB: 0 CS: 0	PA: 50					
<b>PITCHER</b>	IP	WLS	BF	H	R	ER	SO	BB	IBB	HBP	BLK	WP	HR	S	P	ERA	WHIP										
Ruben Gomez, R ERA: 3.22 (1, 1)	5.0		31	9	6	4	4	3	4	0	0	1	1	32	60	7.20	2.400										
Windy McCall, L ERA: 2.33 (6, 1)	0.1		1	0	0	0	1	0	0	0	0	0	0	3	3	0.00	0.000										
Marv Grissom, R ERA: 1.64 (6, 1)	0.2	W	5	2	0	0	0	0	1	0	0	0	0	4	8	0.00	3.000										
Hoyt Wilhelm, R ERA: 2.05 (7, 1)	2.0		10	1	0	0	2	3	0	0	0	0	0	11	23	0.00	2.000										
Johnny Antonelli, L ERA: 2.16 (9, 1)	1.0	S	3	0	0	0	0	0	0	0	0	0	0	3	3	0.00	0.000										

St. Louis Cardinals @ New York Giants  
Polo Grounds, New York, NY  
Sun Jun 20 1954, 3:33 AM EDT  
Att. 22,631 - Unknown

AB	39
R	6
H	12
RBI	6
BB	11
SO	7
LOB	35





Batter	1	2	3	4	5	6	7	8	9	AB R H RBI BB SO LOB	TOP											
Solly Hemus, L (1, 6) OBP: 0.446, SLG: 0.460	0-0 4-3		0-0 1B 1B		0-0 3-1		0-0 E 1B	0-0 P5		5 2 2 1 0 0 1												
Wally Moon, L (1, 8) OBP: 0.411, SLG: 0.494	0-0 1B 1B		0-0 1B 1B		4-0 1B BB		0-0 E 1B		0-0 2-3 1B	4 1 4 0 1 0 0												
Red Schoendienst, S (1, 4) OBP: 0.363, SLG: 0.470	0-0 G4-6-3 1B		0-0 1B		0-0 1B		0-0 F7		0-3 K	5 0 3 2 0 1 2												
Stan Musial, L (1, 9) OBP: 0.455, SLG: 0.711	0-0 G4-6-3 1-2f		0-0 F9		0-0 F9		4-0 1B BB		0-0 2-3	4 0 0 0 1 0 7												
Ray Jablonski, R (1, 5) OBP: 0.392, SLG: 0.521		0-3 K		0-3 K		0-0 6-3	0-0 F9		0-0 P5	5 0 0 0 0 2 3												
Rip Repulski, R (1, 7) OBP: 0.333, SLG: 0.478		0-0 5-3		0-0 6-3		0-0 2B	0-0 1B			4 0 2 1 0 0 0												
Tom Alston, L (1, 3) OBP: 0.317, SLG: 0.363		0-3 K		0-0 PO 1B		0-0 5-3	0-0 4-3			4 0 1 0 0 1 3												
Al Brazle, L (7, 1)										0 0 0 0 0 0 0												
Bill Sarni, R (1, 2) OBP: 0.433, SLG: 0.625			0-0 L4	0-0 PO	0-0 6-3	0-0 6-3		0-0 F7		4 0 0 0 0 0 1												
Gerry Staley, R (1, 1) OBP: 0.231, SLG: 0.091			0-0 L8		4-0 1B BB		0-0 1B 3B	0-3 K		1 0 0 0 0 0 0												
Tom Burgess, L (5, PH) OBP: 0.182, SLG: 0.105										0 1 0 0 1 0 0												
Royce Lint, L (5, 1)										0 0 0 0 0 0 0												
Peanuts Lowrey, R (7, PH) OBP: 0.212, SLG: 0.276										2 1 1 0 0 1 0												
<b>Inning Stats</b>	R: 0 E: 0 K: 0 S: 4	H: 2 LOB: 1 BB: 0 P: 4	R: 0 E: 0 K: 2 S: 7	H: 0 LOB: 0 BB: 0 P: 7	R: 1 E: 0 K: 0 S: 6	H: 3 LOB: 2 BB: 0 P: 6	R: 0 E: 0 K: 1 S: 5	H: 1 LOB: 0 BB: 0 P: 5	R: 1 E: 0 K: 0 S: 4	H: 1 LOB: 2 BB: 2 P: 12	R: 0 E: 0 K: 0 S: 4	H: 1 LOB: 1 BB: 0 P: 4	R: 3 E: 1 K: 0 S: 7	H: 4 LOB: 2 BB: 1 P: 11	R: 0 E: 0 K: 1 S: 5	H: 0 LOB: 0 BB: 0 P: 5	R: 0 E: 0 K: 1 S: 6	H: 1 LOB: 1 BB: 0 P: 6	1B: 11 2B: 1 3B: 1 HR: 0	SF: 0 SAC: 0 DP: 1 HBP: 0	WP: 0 PB: 0 SB: 0 CS: 0	PA: 42
<b>PITCHER</b>	IP WLS BF H R ER SO BB IBB HBP BLK WP HR S P ERA WHIP																					
Jim Hearn, R (1, 1) ERA: 4.86	6.0 W 27 9 3 3 3 2 0 0 0 0 0 0 31 39 4.50 1.833																					
Windy McCall, L (7, 1) ERA: 2.96	0.1 4 2 1 1 0 1 0 0 0 0 0 0 3 7 27.00 9.000																					
Mary Grissom, R (7, 1) ERA: 1.56	2.2 S 10 2 1 1 2 0 0 0 0 0 0 0 14 14 3.38 0.750																					

St. Louis Cardinals @ New York Giants  
Polo Grounds, New York, NY  
Mon Jun 21 1954, 3:33 AM EDT  
Att. 7,184 - Unknown

livebaseballscorecards.com

AB	38
R	5
H	13
RBI	4
BB	3
SO	5
LOB	17





Batter	1	2	3	4	5	6	7	8	9	AB R H RBI BB SO LOB	TOP											
<b>Jim Pendleton, R</b> (1, 8) <small>OBP: 0.235, SLG: 0.286</small> <b>Bill Bruton, L</b> (8, 8) <small>OBP: 0.315, SLG: 0.282</small>	0-0 6-3			x 0-0 F8		x 0-0 4-3		x 0-0 1B		4 0 1 0 0 0 0 0 0 0 0 0 0 0												
<b>Johnny Logan, R</b> (1, 6) <small>OBP: 0.332, SLG: 0.409</small>	0-0 F8			x 0-0 F8		x 0-0 5-3		SS 0-3 K		4 0 0 0 0 1 1												
<b>Hank Aaron, R</b> (1, 7) <small>OBP: 0.341, SLG: 0.493</small>	0-0 6-3			x 0-0 HR		x 0-0 F8		H 1-0 HBP		3 1 1 1 0 0 0												
<b>Joe Adcock, R</b> (1, 3) <small>OBP: 0.379, SLG: 0.522</small>		SS 0-3 K		x 0-0 F2		x 0-0 F8		x 0-0 F3		4 0 0 0 0 1 1												
<b>Andy Pafko, R</b> (1, 9) <small>OBP: 0.339, SLG: 0.443</small>		x 0-0 6-3			x 0-0 G3 2B		x 0-0 4-3		x 0-0 F3		4 1 1 0 0 0 1											
<b>Danny O'Connell, R</b> (1, 5) <small>OBP: 0.320, SLG: 0.336</small>		x 0-0 F9			x 0-0 G3 2-3		x 0-0 1B		SS 0-3 K		4 0 1 0 0 1 2											
<b>Del Crandall, R</b> (1, 2) <small>OBP: 0.272, SLG: 0.313</small>			x 0-0 5-3		BB 4-0 G3 BB		SS 0-3 K				2 0 0 0 1 1 1											
<b>Jack Dittmer, L</b> (1, 4) <small>OBP: 0.205, SLG: 0.240</small>			x 0-0 F9		x 0-0 G3 1-2 3-H		SS 0-3 K				3 0 0 1 0 1 1											
<b>Gene Conley, R</b> (1, 1) <small>OBP: 0.156, SLG: 0.188</small>			SS 0-3 K		x 0-0 F6		x 0-0 4-3				3 0 0 0 0 1 1											
<b>Inning Stats</b>	R: 0 E: 0 K: 0 S: 3	H: 0 LOB: 0 BB: 0 P: 3	R: 0 E: 0 K: 1 S: 5	H: 0 LOB: 0 BB: 0 P: 5	R: 0 E: 0 K: 1 S: 5	H: 0 LOB: 0 BB: 0 P: 5	R: 1 E: 0 K: 0 S: 4	H: 1 LOB: 0 BB: 0 P: 4	R: 1 E: 0 K: 0 S: 4	H: 1 LOB: 1 BB: 1 P: 8	R: 0 E: 0 K: 0 S: 3	H: 0 LOB: 0 BB: 0 P: 3	R: 0 E: 0 K: 1 S: 6	H: 1 LOB: 1 BB: 0 P: 6	R: 0 E: 0 K: 2 S: 8	H: 1 LOB: 1 BB: 0 P: 8	R: 0 E: 0 K: 1 S: 5	H: 0 LOB: 1 BB: 0 P: 6	1B: 2 2B: 1 3B: 0 HR: 1	SF: 0 SAC: 0 DP: 0 HBP: 1	WP: 0 PB: 0 SB: 0 CS: 0	PA: 33
<b>PITCHER</b>	IP WLS BF H R ER SO BB IBB HBP BLK WP HR S P ERA WHIP																					
<b>Johnny Antonelli, L</b> (1, 1) <small>ERA: 2.16</small> <b>Hoyt Wilhelm, R</b> (9, 1) <small>ERA: 2.01</small>	8.0 29 4 2 2 5 1 0 0 0 0 1 38 42 2.25 0.625																					
	1.0 W 4 0 0 0 1 0 0 1 0 0 0 5 6 0.00 0.000																					

Milwaukee Braves @ New York Giants  
Polo Grounds, New York, NY  
Tue Jun 22 1954, 3:33 AM EDT  
Att. 29,136 - Unknown

livebaseballscorecards.com

AB	31
R	2
H	4
RBI	2
BB	1
SO	6
LOB	8



Batter	1	2	3	4	5	6	7	8	9	AB R H RBI BB SO LOB
Davey Williams, R (1, 4) OBP: 0.269, SLG: 0.313	0-0 F9		0-3 K			0-0 SH2-3 1B		0-0 1B		4 0 2 0 0 1 0
Alvin Dark, R (1, 6) OBP: 0.330, SLG: 0.421	0-0 6-3			0-0 F8		0-0 SH2-3 1-2		0-0 5-3		3 0 0 0 0 0 1
Whitey Lockman, L (1, 3) OBP: 0.309, SLG: 0.403	0-0 CS 1B			0-0 F5		0-0 6-3		4-0 1B 2B SH3-4 BB		3 1 1 0 1 0 1
Bill Taylor, L (1, 7) OBP: 0.313, SLG: 0.414	0-0 CS 1-2	0-0 L4		4-0 1B BB		0-0 F9		0-0 SH3-4 1-2		2 0 0 0 1 0 1
Don Mueller, L (1, 9) OBP: 0.375, SLG: 0.437		0-0 4-3		0-0 1B 1-3		0-0 4-3		0-0 2B 1B 2-3		4 1 2 0 0 0 0
Willie Mays, R (1, 8) OBP: 0.389, SLG: 0.672		0-0 HR		0-0 6-3		0-3 K		0-0 1B 2B 1-3 3-H		4 1 2 2 0 1 0
Billy Gardner, R (1, 5) OBP: 0.290, SLG: 0.362		0-0 L3		0-0 1B		0-0 F8		4-0 1B IBB		3 0 1 0 0 0 0
Bobby Hofman, R (9, PH) OBP: 0.161, SLG: 0.467										0 0 0 0 1 0 0
Wes Westrum, R (1, 2) OBP: 0.311, SLG: 0.324			0-0 F6		0-0 F9			0-0 5-3		3 0 0 0 0 0 1
Hoot Evers, R (9, PH) OBP: 0.071, SLG: 0.286								0-3 K		1 0 0 0 0 1 3
Johnny Antonelli, L (1, 1) OBP: 0.217, SLG: 0.250			0-0 4-3		0-0 4-3			0-0 F7		2 0 0 0 0 0 1
Dusty Rhodes, L (8, PH) OBP: 0.455, SLG: 0.600								1-2 2-3 3-H		1 0 0 0 0 0 0
Hoyt Wilhelm, R (9, 1)										0 0 0 0 0 0 0
Monte Irvin, R (9, PH) OBP: 0.346, SLG: 0.428										1 0 1 1 0 0 0

**BOTTOM**

**Milwaukee Braves @ New York Giants**

Polo Grounds, New York, NY

Tue Jun 22 1954, 3:33 AM EDT

Att. 29,136 - Unknown

livebaseballscores.com

AB	31
R	3
H	9
RBI	3
BB	3
SO	3
LOB	8



Inning Stats	R: 0 H: 1 E: 0 K: 0 S: 3	H: 1 LOB: 0 BB: 0 P: 3	R: 1 H: 1 E: 0 K: 0 S: 4	H: 1 LOB: 0 BB: 0 P: 4	R: 0 H: 0 E: 0 K: 1 S: 5	H: 0 LOB: 0 BB: 0 P: 5	R: 0 H: 1 E: 0 K: 0 S: 3	H: 1 LOB: 2 BB: 1 P: 7	R: 0 H: 1 E: 0 K: 0 S: 4	H: 1 LOB: 1 BB: 0 P: 4	R: 0 H: 1 E: 0 K: 0 S: 4	H: 0 LOB: 0 BB: 0 P: 5	R: 0 H: 1 E: 0 K: 0 S: 4	H: 0 LOB: 1 BB: 0 P: 4	R: 0 H: 1 E: 0 K: 0 S: 4	H: 1 LOB: 1 BB: 0 P: 4	R: 2 H: 3 E: 0 K: 1 S: 7	H: 3 LOB: 3 BB: 2 P: 15	1B: 7 2B: 1 3B: 0 HR: 1	SF: 0 SAC: 2 DP: 0 HBP: 0	WP: 0 PA: 37
--------------	--------------------------	------------------------	--------------------------	------------------------	--------------------------	------------------------	--------------------------	------------------------	--------------------------	------------------------	--------------------------	------------------------	--------------------------	------------------------	--------------------------	------------------------	--------------------------	-------------------------	-------------------------	---------------------------	--------------

PITCHER	IP	WLS	BF	H	R	ER	SO	BB	IBB	HBP	BLK	WP	HR	S	P	ERA	WHIP
Gene Conley, R (1, 1) ERA: 2.57	8.2	L	36	9	3	3	3	2	1	0	0	0	1	39	51	3.12	1.269

Batter	1	2	3	4	5	6	7	8	9	AB R H RBI BB SO LOB	TOP									
Bill Bruton, L (1, 8) OBP: 0.317, SLG: 0.281	0-0 L8		0-0 P6		0-0 1B	4-0 BB			0-0 F9	4 1 1 0 1 0 0										
Johnny Logan, R (1, 6) OBP: 0.329, SLG: 0.404	0-0 FC5-4 1B		0-0 6-3		0-3 K	0-0 F3			0-0 F7	5 0 1 0 0 1 3										
Hank Aaron, R (1, 7) OBP: 0.338, SLG: 0.486	0-0 FC5-4 1-2f HR		0-0 5-3		0-0 1B			0-0 6-3	0-0 P2	5 1 1 1 0 0 1										
Joe Adcock, R (1, 3) OBP: 0.381, SLG: 0.533	0-0 1-H HR			0-0 5-3	4-0 1-2 BB			0-0 5-3		3 1 1 2 1 0 0										
Andy Pafko, R (1, 9) OBP: 0.342, SLG: 0.458	0-0 6-3			0-0 HR	0-0 F8			0-0 1B		4 1 2 1 0 0 2										
Danny O'Connell, R (1, 5) OBP: 0.314, SLG: 0.330			0-0 F8	0-0 1-3		0-0 P4		0-0 1-3		4 0 0 0 0 0 1										
Del Crandall, R (1, 2) OBP: 0.283, SLG: 0.351			0-0 2B	0-0 1B		0-0 HR		0-0 F8		4 1 3 1 0 0 0										
Jack Dittmer, L (1, 4) OBP: 0.207, SLG: 0.253			0-0 F8	0-0 F5		0-0 F3 2B		0-0 L8		4 0 1 0 0 0 2										
Jim Wilson, R (1, 1) OBP: 0.214, SLG: 0.286			0-3 K		0-0 F9	0-0 F3		0-0 F9		4 0 0 0 0 1 2										
Dave Jolly, R (9, 1) OBP: 0.333, SLG: 0.375						2-3				0 0 0 0 0 0 0										
<b>Inning Stats</b>	R: 2 E: 0 K: 0 S: 5	H: 2 LOB: 0 BB: 0 P: 5	R: 0 E: 0 K: 1 S: 6	H: 1 LOB: 1 BB: 0 P: 6	R: 0 E: 0 K: 0 S: 3	H: 0 LOB: 0 BB: 0 P: 3	R: 1 E: 0 K: 0 S: 5	H: 2 LOB: 1 BB: 0 P: 5	R: 1 E: 0 K: 1 S: 7	H: 2 LOB: 2 BB: 1 P: 9	R: 0 E: 0 K: 0 S: 4	H: 1 LOB: 1 BB: 0 P: 4	R: 0 E: 0 K: 0 S: 3	H: 0 LOB: 0 BB: 0 P: 3	R: 0 E: 0 K: 0 S: 3	H: 0 LOB: 0 BB: 0 P: 3	1B: 5 2B: 2 3B: 0 HR: 3	SF: 0 SAC: 0 DP: 0 HBP: 0	WP: 0 PB: 0 SB: 1 CS: 0	PA: 39
<b>PITCHER</b>	IP WLS BF H R ER SO BB IBB HBP BLK WP HR S P ERA WHIP																			
Ruben Gomez, R (1, 1) ERA: 3.4	1.0 L 5 2 2 2 0 0 0 0 0 0 0 1 5 5 18.00 2.000																			
Larry Jansen, R (2, 1) ERA: 5.79	4.0 18 5 2 2 2 1 0 0 0 0 0 1 21 25 4.50 1.500																			
Windy McCall, L (6, 1) ERA: 3.07	2.0 10 3 1 1 0 1 0 0 0 0 0 1 9 13 4.50 2.000																			
Alex Konikowski, R (8, 1) ERA: 3.86	2.0 6 0 0 0 0 0 0 0 0 0 0 0 6 6 0.00 0.000																			

Milwaukee Braves @ New York Giants  
Polo Grounds, New York, NY  
Wed Jun 23 1954, 3:33 AM EDT  
Att. 4,640 - Unknown

livebaseballscorecards.com

AB	37
R	5
H	10
RBI	5
BB	2
SO	2
LOB	11





Batter	1	2	3	4	5	6	7	8	9	AB	R	H	RBI	BB	SO	LOB
Davey Williams, R (1, 4) OBP: 0.268, SLG: 0.311	0-0 1B		0-0 F7		0-0 F7			0-0 F7		4	0	1	0	0	0	0
Alvin Dark, R (1, 6) OBP: 0.325, SLG: 0.415	0-0 P4		0-0 P3		0-0 F7			0-0 1-3		4	0	0	0	0	0	1
Whitey Lockman, L (1, 3) OBP: 0.312, SLG: 0.405	0-0 F8			0-0 F8 1B 1B		0-0 1B 1B		0-0 3-1		4	1	2	0	0	0	1
Monte Irvin, R (1, 7) OBP: 0.349, SLG: 0.429	0-0 F3			0-0 1-2 1B 1B		0-3 K			0-0 1B 1B	4	0	2	0	0	1	2
Don Mueller, L (1, 9) OBP: 0.376, SLG: 0.438		0-0 F4		0-0 L7		0-0 1-2 1B		0-0 1B 1B		4	0	2	0	0	0	2
Willie Mays, R (1, 8) OBP: 0.390, SLG: 0.681		0-0 HR		0-0 F8		0-0 P3		1-0 1-2 HBP		3	1	1	1	0	0	3
Billy Gardner, R (1, 5) OBP: 0.292, SLG: 0.361		0-0 6-3		0-0 1-2 1B				0-0 F9		3	0	1	1	0	0	1
Hank Thompson, L (9, PH) OBP: 0.396, SLG: 0.497				0-0 3-H 1B				0-0 F5		1	0	0	0	0	0	3
Wes Westrum, R (1, 2) OBP: 0.298, SLG: 0.308		0-3 K		0-0 4-3				0-3 K		4	0	0	0	0	2	5
Ruben Gomez, R (1, 1) OBP: 0.242, SLG: 0.242			0-0 6-3		0-0 4-3			0-0 P2		0	0	0	0	0	0	0
Larry Jansen, R (2, 1) OBP: 0.353, SLG: 0.417										1	0	0	0	0	0	0
Dusty Rhodes, L (5, PH) OBP: 0.435, SLG: 0.571										0	0	0	0	0	0	0
Windy McCall, L (6, 1) OBP: 0.435, SLG: 0.571										0	0	0	0	0	0	0
Bill Taylor, L (7, PH) OBP: 0.303, SLG: 0.400										1	0	0	0	0	0	0
Alex Konikowski, R (8, 1) OBP: 0.156, SLG: 0.452										0	0	0	0	0	0	0
Bobby Hofman, R (9, PH) OBP: 0.156, SLG: 0.452										1	0	0	0	0	0	3

Inning Stats	R: 0	H: 1	E: 0	LOB: 1	K: 0	BB: 0	S: 4	P: 4	R: 1	H: 1	E: 0	LOB: 0	K: 1	BB: 0	S: 6	R: 0	H: 0	E: 0	LOB: 0	K: 0	BB: 0	S: 3	R: 1	H: 3	E: 0	LOB: 2	K: 0	BB: 0	S: 6	R: 0	H: 0	E: 0	LOB: 0	K: 0	BB: 0	S: 3	R: 0	H: 2	E: 0	LOB: 1	K: 1	BB: 0	S: 6	R: 0	H: 0	E: 0	LOB: 0	K: 2	BB: 0	S: 7	R: 0	H: 0	E: 0	LOB: 0	K: 0	BB: 0	S: 3	R: 0	H: 0	E: 0	LOB: 0	K: 0	BB: 0	S: 5	R: 0	H: 2	E: 0	LOB: 3	K: 0	BB: 0	S: 5	1B: 8	SF: 0	2B: 0	SAC: 0	3B: 0	DP: 0	HR: 1	HBP: 1	WP: 0	PA: 36
PITCHER	IP	WLS	BF	H	R	ER	SO	BB	IBB	HBP	BLK	WP	HR	S	P	ERA	WHIP																			IP	WLS	BF	H	R	ER	SO	BB	IBB	HBP	BLK	WP	HR	S	P	ERA	WHIP																													
Jim Wilson, R (1, 1) ERA: 2.68	8.0	W	32	9	2	2	4	0	0	0	0	0	0	40	40	2.25	1.125																																																																
Dave Jolly, R (9, 1) ERA: 0.99	1.0	S	4	0	0	0	0	0	0	1	0	0	0	3	4	0.00	0.000																																																																

BOTTOM

Milwaukee Braves @ New York Giants  
 Polo Grounds, New York, NY  
 Wed Jun 23 1954, 3:33 AM EDT  
 Att. 4,640 - Unknown

livebaseballscorecards.com

AB	35
R	2
H	9
RBI	2
BB	0
SO	4
LOB	20



Batter	1	2	3	4	5	6	7	8	9	AB R H RBI BB SO LOB	TOP
<b>Jim Pendleton, R</b> (1, 8) <small>OBP: 0.224, SLG: 0.272</small>	0-0 <b>F8</b>		0-0 <b>G5-4-3</b>			0-0 <b>F9</b>			0-0 <b>P4</b>	4 0 0 0 0 0 1	<b>Milwaukee Braves @ New York Giants</b> Polo Grounds, New York, NY Thu Jun 24 1954, 3:33 AM EDT Att. 7,743 - Unknown  <a href="http://livebaseballscorecards.com">livebaseballscorecards.com</a>  <b>AB 28</b> <b>R 1</b> <b>H 4</b> <b>RBI 1</b> <b>BB 1</b> <b>SO 2</b> <b>LOB 4</b>  
<b>Johnny Logan, R</b> (1, 6) <small>OBP: 0.324, SLG: 0.397</small>	0-0 <b>F3</b>			0-0 <b>L8</b>		0-3 <b>K</b>		0-0 <b>F8</b>	4 0 0 0 0 1 0		
<b>Hank Aaron, R</b> (1, 7) <small>OBP: 0.333, SLG: 0.479</small>	0-0 <b>P6</b>			0-0 <b>F3</b>			0-0 <b>F6</b>		3 0 0 0 0 0 0		
<b>Joe Adcock, R</b> (1, 3) <small>OBP: 0.376, SLG: 0.526</small>		0-0 <b>P6</b>		0-0 <b>F7</b>			0-0 <b>F2</b>		3 0 0 0 0 0 0		
<b>Andy Pafko, R</b> (1, 9) <small>OBP: 0.346, SLG: 0.475</small>		0-0 <b>HR</b>			0-0 <b>CS</b> <b>1B</b>		0-0 <b>L9</b>		3 1 2 1 0 0 0		
<b>Danny O'Connell, R</b> (1, 5) <small>OBP: 0.315, SLG: 0.330</small>		0-0 <b>5-3</b>			0-0 <b>1B</b>			0-0 <b>F5</b>	3 0 1 0 0 0 0		
<b>Del Crandall, R</b> (1, 2) <small>OBP: 0.284, SLG: 0.351</small>		0-0 <b>F7</b>			0-3 <b>K</b>			0-0 <b>1B</b>	3 0 1 0 0 1 1		
<b>Jack Dittmer, L</b> (1, 4) <small>OBP: 0.213, SLG: 0.250</small> <b>Roy Smalley, R</b> (8, PH) <small>OBP: 0.286, SLG: 0.667</small> (8, 4)			4-0 <b>FC1-6</b> <b>BB</b>		0-0 <b>F9</b>			0-0 <b>F7</b>	1 0 0 0 1 0 1 1 0 0 0 0 0 0		
<b>Warren Spahn, L</b> (1, 1) <small>OBP: 0.286, SLG: 0.326</small> <b>Sam Calderone, R</b> (9, PH) <small>OBP: 0.444, SLG: 0.429</small>			0-0 <b>FC1-6</b> <b>G5-4-3</b>		0-0 <b>1-3</b>			0-0 <b>F2</b>	2 0 0 0 0 0 1 1 0 0 0 0 0 0		
<b>Inning Stats</b>	R: 0 H: 0 E: 0 LOB: 0 K: 0 BB: 0 S: 3 P: 3	R: 1 H: 1 E: 0 LOB: 0 K: 0 BB: 0 S: 4 P: 4	R: 0 H: 0 E: 0 LOB: 0 K: 0 BB: 1 S: 2 P: 6	R: 0 H: 0 E: 0 LOB: 0 K: 0 BB: 0 S: 3 P: 3	R: 0 H: 2 E: 0 LOB: 1 K: 1 BB: 0 S: 6 P: 6	R: 0 H: 0 E: 0 LOB: 0 K: 1 BB: 0 S: 5 P: 5	R: 0 H: 0 E: 0 LOB: 0 K: 0 BB: 0 S: 3 P: 3	R: 0 H: 1 E: 0 LOB: 0 K: 0 BB: 0 S: 3 P: 3	R: 0 H: 0 E: 0 LOB: 0 K: 0 BB: 0 S: 3 P: 3	1B: 3 SF: 0 2B: 0 SAC: 0 3B: 0 DP: 1 HR: 1 HBP: 0	WP: 0 PA: 29 PB: 0 SB: 0 CS: 1
<b>PITCHER</b> <b>Don Liddle, L</b> (1, 1) <small>ERA: 2.75</small>	IP WLS BF H R ER SO BB IBB HBP BLK WP HR S P ERA WHIP 9.0 W 29 4 1 1 2 1 0 0 0 0 1 32 36 1.00 0.556										

Batter	1	2	3	4	5	6	7	8	9
Davey Williams, R OBP: 0.268, SLG: 0.310 (1, 4)	0-0 1B	0-0 F8			0-0 F8			0-0 FC1-6 1-2f	
Alvin Dark, R OBP: 0.321, SLG: 0.409 (1, 6)	0-0 P3		0-0 4-3			0-0 F7		0-0 F8	
Whitey Lockman, L OBP: 0.311, SLG: 0.402 (1, 3)	0-0 F8		0-3 K			0-0 G5-4-3 1B		0-0 P4	
Monte Irvin, R OBP: 0.345, SLG: 0.423 (1, 7)	0-0 F8		0-0 P4			0-0 G5-4-3 1-2f			
Don Mueller, L OBP: 0.376, SLG: 0.437 (1, 9)		0-0 HR 1B		0-0 F2			0-0 F8		
Willie Mays, R OBP: 0.393, SLG: 0.693 (1, 8)		0-0 HR		0-0 F7			0-0 FC1-4 1B		
Billy Gardner, R OBP: 0.279, SLG: 0.344 (1, 5)		0-0 F7		0-0 F8			0-0 FC1-4 1-2f		
Wes Westrum, R OBP: 0.299, SLG: 0.309 (1, 2)		0-0 FC3-6 1B			0-0 F8		0-0 4-3		
Don Liddle, L OBP: 0.091, SLG: 0.091 (1, 1)		0-0 FC3-6 1-2f			0-0 1-3			0-0 FC1-6 1B	

Inning Stats	R: 0 E: 0 K: 0 S: 4	H: 1 LOB: 1 BB: 0 P: 4	R: 2 E: 0 K: 0 S: 6	H: 3 LOB: 1 BB: 0 P: 6	R: 0 E: 0 K: 1 S: 5	H: 0 LOB: 0 BB: 0 P: 5	R: 0 E: 0 K: 0 S: 3	H: 0 LOB: 0 BB: 0 P: 3	R: 0 E: 0 K: 0 S: 3	H: 1 LOB: 0 BB: 0 P: 3	R: 0 E: 0 K: 0 S: 4	H: 1 LOB: 1 BB: 0 P: 4	R: 0 E: 0 K: 0 S: 4	H: 1 LOB: 1 BB: 0 P: 4
1B: 6 2B: 0 3B: 0 HR: 1	SF: 0 SAC: 0 DP: 1 HBP: 0	WP: 0 PA: 30 SB: 0 CS: 0												

PITCHER	IP	WLS	BF	H	R	ER	SO	BB	IBB	HBP	BLK	WP	HR	S	P	ERA	WHIP
Warren Spahn, L ERA: 2.91 (1, 1)	8.0	L	30	7	2	2	1	0	0	0	0	0	1	32	32	2.25	0.875

**BOTTOM**

AB	R	H	RBI	BB	SO	LOB
4	0	1	0	0	0	2
4	0	0	0	0	0	2
4	0	1	0	0	1	2
3	0	0	0	0	0	2
3	1	1	0	0	0	0
3	1	2	2	0	0	0
3	0	0	0	0	0	1
3	0	1	0	0	0	1
3	0	1	0	0	0	1

<b>AB</b>	<b>30</b>
<b>R</b>	<b>2</b>
<b>H</b>	<b>7</b>
<b>RBI</b>	<b>2</b>
<b>BB</b>	<b>0</b>
<b>SO</b>	<b>1</b>
<b>LOB</b>	<b>11</b>



WP	PA	ERA	WHIP
0	30		

**Milwaukee Braves @ New York Giants**  
 Polo Grounds, New York, NY  
 Thu Jun 24 1954, 3:33 AM EDT  
 Att. 7,743 - Unknown

[livebaseballscorecards.com](http://livebaseballscorecards.com)

Batter	1	2	3	4	5	6	7	8	9	AB R H RBI BB SO LOB	TOP											
Bob Talbot, R (1, 8) OBP: 0.273, SLG: 0.351	0-0 F5		0-3 K		0-0 1-3 2-H 1B		0-0 F2		0-0 P8	5 0 1 1 0 1 4												
Gene Baker, R (1, 4) OBP: 0.322, SLG: 0.399	4-0 14 G5-4-3 BB			0-0 6-3		0-0 4-3	0-0 F8			3 0 0 0 1 0 2												
14 Ernie Banks, R (1, 6) OBP: 0.326, SLG: 0.400	0-0 G5-4-3 1-2f			0-0 F8		4-0 BB		0-0 F8		3 0 0 0 1 0 1												
Ralph Kiner, R (1, 7) OBP: 0.421, SLG: 0.585		0-0 6-3		0-0 FC4 1B		0-0 F6		0-0 4-3		4 0 1 0 0 0 1												
Randy Jackson, R (1, 5) OBP: 0.372, SLG: 0.513		0-0 5-3		0-0 FC4 1-2f		0-0 F9		0-0 1B		4 0 1 0 0 0 2												
Hank Sauer, R (1, 9) OBP: 0.396, SLG: 0.638		0-3 K			0-0 FC5-4 1B		4-0 E BB G3 BB	0-0 5-3		3 1 1 0 1 1 1												
Steve Bilko, R (1, 3) OBP: 0.333, SLG: 0.357			0-3 K		0-0 FC5-4 1B 1-2f		4-0 G3 E BB		0-0 F2	3 1 0 0 1 1 1												
El Tappe, R (1, 2) OBP: 0.282, SLG: 0.284			0-0 F8		0-0 1B 1-2		0-0 E6 G3		0-3 K	2 0 1 0 0 0 0												
Frank Baumholtz, L (7, PH) OBP: 0.352, SLG: 0.414										1 0 0 0 0 0 2												
Hal Jeffcoat, R (7, 1) OBP: 0.375, SLG: 0.769										0 0 0 0 0 0 0												
Bill Serena, R (9, PH) OBP: 0.359, SLG: 0.448										1 0 0 0 0 1 0												
Bob Rush, R (1, 1) OBP: 0.364, SLG: 0.424			0-0 1B		0-0 F9		0-0 G3		4-0 BB	1 0 1 0 0 0 0												
Hal Rice, L (5, PH) OBP: 0.295, SLG: 0.270										1 0 0 0 0 0 2												
Dave Cole, R (5, 1)										0 0 0 0 0 0 0												
Joe Garagiola, L (7, PH) OBP: 0.412, SLG: 0.383										1 0 0 1 1 0 2												
Warren Hacker, R (9, PR) OBP: 0.211, SLG: 0.167										0 0 0 0 0 0 0												
<b>Inning Stats</b>	R: 0 E: 0 K: 0 S: 2	H: 0 LOB: 0 BB: 1 P: 6	R: 0 E: 0 K: 1 S: 5	H: 0 LOB: 0 BB: 0 P: 5	R: 0 E: 0 K: 2 S: 8	H: 1 LOB: 1 BB: 0 P: 8	R: 0 E: 0 K: 0 S: 4	H: 1 LOB: 1 BB: 0 P: 4	R: 1 E: 0 K: 0 S: 5	H: 3 LOB: 2 BB: 0 P: 5	R: 0 E: 0 K: 0 S: 3	H: 0 LOB: 1 BB: 1 P: 7	R: 1 E: 1 K: 0 S: 4	H: 0 LOB: 2 BB: 2 P: 12	R: 0 E: 0 K: 0 S: 4	H: 1 LOB: 1 BB: 0 P: 4	R: 0 E: 0 K: 1 S: 5	H: 0 LOB: 1 BB: 1 P: 9	1B: 6 2B: 0 3B: 0 HR: 0	SF: 0 SAC: 0 DP: 1 HBP: 0	WP: 0 PB: 0 SB: 0 CS: 0	PA: 37
<b>PITCHER</b>	IP WLS BF H R ER SO BB IBB HBP BLK WP HR S P ERA WHIP																					
Jim Hearn, R (1, 1) ERA: 4.58	7.0 W 29 5 2 2 3 4 0 0 0 0 0 0 31 47 2.57 1.286																					
Mary Grissom, R (8, 1) ERA: 1.51	2.0 S 8 1 0 0 1 1 0 0 0 0 0 0 9 13 0.00 1.000																					

Chicago Cubs @ New York Giants  
Polo Grounds, New York, NY  
Fri Jun 25 1954, 3:33 AM EDT  
Att. 12,125 - Unknown

livebaseballscorecards.com

AB	32
R	2
H	6
RBI	2
BB	5
SO	4
LOB	18





Batter	1	2	3	4	5	6	7	8	9	AB R H RBI BB SO LOB	TOP									
<b>Bob Talbot, R</b> (1, 8) <small>OBP: 0.272, SLG: 0.349</small> <b>Frank Baumholtz, L</b> (9, PH) <small>OBP: 0.349, SLG: 0.412</small>	0-0 5-3		0-0 1B 1B		0-0 4-3		0-0 FC5 2-3f		0-0 F7	4 0 1 0 0 0 2 1 0 0 0 0 0 2										
<b>Gene Baker, R</b> (1, 4) <small>OBP: 0.324, SLG: 0.399</small>	0-0 6-3		0-0 BB BB 1B		0-0 F8			0-0 1B HR 1B	0-0 F9	5 1 2 0 0 0 2										
<b>Randy Jackson, R</b> (1, 5) <small>OBP: 0.380, SLG: 0.513</small>	0-0 6-3		4-0 BB BB 1B		4-0 G5-4-3 BB			0-0 1B HR 1B	4-0 BB	2 1 1 0 3 0 0										
<b>Ralph Kiner, R</b> (1, 7) <small>OBP: 0.418, SLG: 0.576</small>		0-0 F2	4-0 BB BB BB 1-2 2-3 BB		0-0 F9			0-3 K	0-3 K	4 0 0 0 1 2 6										
<b>Hank Sauer, R</b> (1, 9) <small>OBP: 0.394, SLG: 0.645</small>		0-0 F8	0-3 K		0-0 G5-4-3 1-2f			0-0 1B HR		4 1 1 3 0 1 4										
<b>14 Ernie Banks, R</b> (1, 6) <small>OBP: 0.329, SLG: 0.397</small>		4-0 BB		0-0 F7			1-0 G6-3 HBP	0-3 K2-3		2 0 0 0 1 1 0										
<b>Steve Bilko, R</b> (1, 3) <small>OBP: 0.309, SLG: 0.326</small>		0-0 1-3		0-0 6-3			0-0 G6-3 1-2f	0-0 F8		4 0 0 0 0 0 2										
<b>Walker Cooper, R</b> (1, 2) <small>OBP: 0.369, SLG: 0.491</small> <b>Warren Hacker, R</b> (9, PR) <small>OBP: 0.211, SLG: 0.167</small>			0-0 HR		0-0 L5		0-0 FC5 1B 1B		0-0 BB BB 1B	4 1 3 1 0 0 0 0 0 0 0 0 0 0										
<b>Johnny Klippstein, R</b> (1, 1) <small>OBP: 0.130, SLG: 0.136</small> <b>Eddie Miksis, R</b> (5, PH) <small>OBP: 0.227, SLG: 0.254</small> <b>Jim Davis, S</b> (5, 1) <b>Bill Serena, R</b> (7, PH) <small>OBP: 0.375, SLG: 0.467</small> <b>Dave Cole, R</b> (7, 1) <b>Hal Rice, L</b> (9, PH) <small>OBP: 0.302, SLG: 0.270</small>			0-0 6-3		0-0 6-3		0-0 1B		4-0 BB BB	1 0 0 0 0 0 0 1 0 0 0 0 0 0 0 0 0 0 0 0 0 1 0 1 0 0 0 0 0 0 0 0 0 0 0 0 0 0 0 1 0 0										
<b>Inning Stats</b>	R: 0 E: 0 K: 0 S: 3	H: 0 LOB: 0 BB: 0 P: 3	R: 0 E: 0 K: 0 S: 3	H: 0 LOB: 1 BB: 1 P: 7	R: 1 E: 0 K: 1 S: 7	H: 3 LOB: 3 BB: 2 P: 15	R: 0 E: 0 K: 0 S: 3	H: 0 LOB: 0 BB: 0 P: 3	R: 0 E: 0 K: 0 S: 2	H: 0 LOB: 0 BB: 1 P: 6	R: 0 E: 0 K: 0 S: 4	H: 2 LOB: 2 BB: 0 P: 5	R: 3 E: 0 K: 2 S: 10	H: 3 LOB: 0 BB: 0 P: 10	R: 0 E: 0 K: 1 S: 6	H: 1 LOB: 3 BB: 2 P: 14	1B: 7 2B: 0 3B: 0 HR: 2	SF: 0 SAC: 0 DP: 2 HBP: 1	WP: 0 PB: 0 SB: 0 CS: 0	PA: 40
<b>PITCHER</b>	IP WLS BF H R ER SO BB IBB HBP BLK WP HR S P ERA WHIP																			
<b>Johnny Antonelli, L</b> (1, 1) <small>ERA: 2.26</small> <b>Hoyt Wilhelm, R</b> (8, 1) <small>ERA: 2.15</small> <b>Mary Grissom, R</b> (9, 1) <small>ERA: 1.48</small>	7.0 W 30 7 3 3 1 4 0 1 0 0 1 27 44 3.86 1.571																			
	1.0 6 2 1 1 2 1 0 0 0 0 1 9 13 9.00 3.000																			
	1.0 S 4 0 0 0 1 1 0 0 0 0 0 5 9 0.00 1.000																			

Chicago Cubs @ New York Giants  
Polo Grounds, New York, NY  
Sat Jun 26 1954, 3:33 AM EDT  
Att. 7,705 - Unknown

livebaseballscorecards.com

AB	33
R	4
H	9
RBI	4
BB	6
SO	4
LOB	18



Batter	1	2	3	4	5	6	7	8	9	AB	R	H	RBI	BB	SO	LOB
Davey Williams, R (1, 4) OBP: 0.270, SLG: 0.317	0-0 4-3 1B 2B		4-0 WP S 6-3 BB	0-0 F9			0-0 E6 L4-3			3	2	1	0	1	0	0
Alvin Dark, R (1, 6) OBP: 0.321, SLG: 0.408	0-0 4-3 2-3		0-0 6-3 1-H	0-0 1B			0-0 L4-3 1-2			4	0	1	1	0	0	2
Whitey Lockman, L (1, 3) OBP: 0.306, SLG: 0.398	0-0 6-3		0-0 L4	0-0 4-3			0-0 L4			4	0	0	0	0	0	2
Hank Thompson, L (1, 5) OBP: 0.413, SLG: 0.516 Billy Gardner, R (8, PR) OBP: 0.279, SLG: 0.344 (9, 5)	4-0 1B BB		0-0 3-1			0-0 L6-3 1B		4-0 BB		2	0	1	0	2	0	0
Don Mueller, L (1, 9) OBP: 0.376, SLG: 0.435	0-0 1-2 3-H 1B			0-0 2B HR 1B		0-0 L6-3 1-2		0-3 K		4	1	2	1	0	1	2
Willie Mays, R (1, 8) OBP: 0.389, SLG: 0.695	0-3 K			0-0 1-3 HR 2B		0-3 K		0-0 F9		4	1	1	0	0	2	3
Bill Taylor, L (1, 7) OBP: 0.297, SLG: 0.364 Monte Irvin, R (9, 7) OBP: 0.347, SLG: 0.420		0-0 5-3		4-0 HR IBB		0-3 K		0-0 4-3		3	1	0	0	1	1	1
Wes Westrum, R (1, 2) OBP: 0.308, SLG: 0.352		0-0 L5		0-0 1-H 2-H 3-H HR		0-0 F7				3	1	1	4	0	0	0
Johnny Antonelli, L (1, 1) OBP: 0.204, SLG: 0.234 Hoyt Wilhelm, R (8, 1) Mary Grissom, R (9, 1) OBP: 0.056, SLG: 0.056		0-0 P6		0-0 4-3		0-0 F2				3	0	0	0	0	0	0

Inning Stats	R: 1	H: 2	E: 0	K: 1	S: 7	H: 2	LOB: 2	BB: 1	P: 11	R: 0	H: 0	E: 0	K: 0	S: 3	H: 0	LOB: 0	BB: 0	P: 3	R: 1	H: 0	E: 0	K: 0	S: 3	R: 4	H: 4	E: 0	K: 0	S: 7	H: 1	LOB: 0	BB: 1	P: 7	R: 0	H: 1	E: 0	K: 1	S: 5	H: 0	LOB: 0	BB: 0	P: 5	R: 0	H: 0	E: 1	K: 0	S: 3	H: 0	LOB: 0	BB: 0	P: 3	R: 0	H: 0	E: 0	K: 1	S: 5	H: 0	LOB: 1	BB: 1	P: 9
--------------	------	------	------	------	------	------	--------	-------	-------	------	------	------	------	------	------	--------	-------	------	------	------	------	------	------	------	------	------	------	------	------	--------	-------	------	------	------	------	------	------	------	--------	-------	------	------	------	------	------	------	------	--------	-------	------	------	------	------	------	------	------	--------	-------	------

PITCHER	IP	WLS	BF	H	R	ER	SO	BB	IBB	HBP	BLK	WP	HR	S	P	ERA	WHIP
Johnny Klippstein, R (1, 1) ERA: 7.13	4.0	L	21	6	6	6	1	2	1	0	0	1	1	20	32	13.50	2.000
Jim Davis, L (5, 1) ERA: 4.56	2.0		6	1	0	0	2	0	0	0	0	0	0	10	10	0.00	0.500
Dave Cole, R (7, 1) ERA: 2.25	2.0		7	0	0	0	1	1	0	0	0	0	0	8	12	0.00	0.500

**BOTTOM**

**Chicago Cubs @ New York Giants**  
Polo Grounds, New York, NY  
Sat Jun 26 1954, 3:33 AM EDT  
Att. 7,705 - Unknown

AB	30
R	6
H	7
RBI	6
BB	4
SO	4
LOB	10



1B	2B	3B	HR	SF	SAC	DP	HBP	WP	HR	S	P	ERA	WHIP
4	4	0	1	0	2	0	1	1	0	0	34		





BOTTOM

Chicago Cubs @ New York Giants  
Polo Grounds, New York, NY  
Sun Jun 27 1954, 3:33 AM EDT  
Att: 11,947 - Unknown

livebaseballscorecards.com

AB 34  
R 3  
H 5  
RBI 3  
BB 2  
SO 3  
LOB 9



WP: 0 PA: 36  
PB: 0  
SB: 2  
CS: 0

AB R H RBI BB SO LOB

4 1 0 0 0 0 0

4 0 0 0 0 0 1

4 1 1 2 0 0 0

3 0 0 0 1 0 0

4 0 2 0 0 0 1

4 1 1 0 0 1 2

3 0 0 0 0 0 2

0 0 0 0 1 0 0

3 0 0 0 0 1 1

1 0 0 0 0 1 2

1B: 2 SF: 0  
2B: 1 SAC: 0  
3B: 1 DP: 0  
HR: 1 HBP: 0

1B 2B IBB

1B 2B

1B

3B

HR

HR

BB

BB

BB

BB

BB

BB

BB

BB

BB

BB

BB

BB

BB

BB

BB

BB

BB

BB

BB

BB

BB

BB

BB

BB

BB

BB

BB

BB

BB

BB

BB

BB

BB

BB

BB

BB

BB

BB

BB

BB

BB

BB

BB

BB

BB

BB

BB

BB

BB

BB

BB

BB

BB

BB

BB

BB

BB

BB

BB

BB

BB

BB

BB

BB

BB

BB

BB

BB

BB

BB

BB

BB

BB

BB

BB

BB

BB

BB

BB

BB

BB

BB

BB

BB

BB

BB

BB

BB

BB

BB

BB

BB

BB

BB

BB

BB

BB

BB

BB

BB

BB

BB

BB

BB

BB

BB

BB

BB

BB

BB

BB

BB

BB

BB

BB

BB

BB

BB

BB

BB

BB

BB

BB

BB

BB

BB

BB

BB

BB

BB

BB

BB

BB

BB

BB

BB

BB

BB

BB

BB

BB

BB

BB

BB

BB

BB

BB

BB

BB

BB

BB

BB

BB

BB

BB

BB

BB

BB

BB

BB

BB

BB

BB

BB

BB

BB

BB

BB

BB

BB

BB

BB

BB

BB

BB

BB

BB

BB

BB

BB

BB

BB

BB

BB

BB

BB

BB

BB

BB

BB

BB

BB

BB

BB

BB

BB

BB

BB

BB

BB

BB

BB

BB

BB

BB

BB

BB

BB

BB

BB

BB

BB

BB

BB

BB

BB

BB

BB

BB

BB

BB

BB

BB

BB

BB

BB

BB

BB

BB

BB

BB

BB

BB

BB

BB

BB

BB

BB

BB

BB

BB

BB

BB

BB

BB

BB

BB

BB

BB

BB

BB

BB

BB

BB

BB

BB

BB

BB

BB

BB

BB

BB

BB

BB

BB

BB

BB

BB

BB

BB

BB

BB

BB

BB

BB

BB

BB

BB

BB

BB

BB

BB

BB

BB

BB

BB

BB

BB

BB

BB

BB

BB

BB

Batter	1	2	3	4	5	6	7	8	9	10	11	12	13	AB R H RBI BB SO LOB	TOP	
<b>Jim Gilliam, S</b> (1, 4) <small>OBP: 0.326, SLG: 0.425</small>	3-2 <b>F3</b>		0-2 <b>F8</b>		1-1 <b>F4</b>			1-0 <b>4-3</b>		2-3 <b>K</b>		0-0 <b>F4</b>		6 0 0 0 0 1 3	<b>Brooklyn Dodgers @ New York Giants</b> Polo Grounds, New York, NY Tue Jun 29 1954, 3:33 AM EDT Att. 51,464 - Unknown	
<b>Pee Wee Reese, R</b> (1, 6) <small>OBP: 0.364, SLG: 0.442</small> <b>Billy Cox, R</b> (12, PR) <small>OBP: 0.325, SLG: 0.311</small>	0-1 <b>F8</b>		2-1 <b>4-3</b>			1-3 <b>K</b>		2-2 <b>F4</b>		1-2 <b>HBP</b> <b>1B</b>		1-1 <b>1B</b> <b>1B</b>		6 0 2 0 0 1 1 0 0 0 0 0 0 0		
<b>Duke Snider, L</b> (1, 8) <small>OBP: 0.450, SLG: 0.707</small> <b>Walt Moryn, L</b> (10, 9) <small>OBP: 1.000, SLG: 1.000</small>	2-1 <b>3B</b>			1-0 <b>1B</b>		1-2 <b>F7</b>			1-0 <b>F8</b>	2-1 <b>HBP</b>		0-0 <b>G6-4-3</b> <b>1B</b>		4 0 2 0 0 0 0 1 0 1 0 0 0 0		
<b>Jackie Robinson, R</b> (1, 7) <small>OBP: 0.445, SLG: 0.602</small>	1-0 <b>F7</b>			3-1 <b>F6</b>		3-3 <b>K</b>		1-0 <b>HR</b> <b>1B</b>	1-0 <b>F8</b>		1-1 <b>G6-4-3</b>		6 1 1 0 0 1 7			
<b>Gil Hodges, R</b> (1, 3) <small>OBP: 0.386, SLG: 0.606</small>		0-3 <b>K</b>		0-1 <b>L7</b>			3-1 <b>F7</b>		2-3 <b>K</b>		1-2 <b>F9</b>		1-0 <b>F2</b>	6 0 0 0 0 2 2		
<b>Roy Campanella, R</b> (1, 2) <small>OBP: 0.253, SLG: 0.431</small>		3-3 <b>K</b>		0-0 <b>F7</b>			0-3 <b>K</b>		1-2 <b>HR</b>		1-1 <b>E5</b> <b>1B</b>		0-0 <b>1-3</b>	6 1 2 2 0 2 1		
<b>Don Hoak, R</b> (1, 5) <small>OBP: 0.326, SLG: 0.484</small>		1-2 <b>1B</b>			0-1 <b>B1-3</b>		0-0 <b>F8</b>		2-3 <b>K</b>		3-3 <b>K</b>		1-2 <b>HR</b>	6 1 2 1 0 2 1		
<b>Carl Furillo, R</b> (1, 9) <small>OBP: 0.342, SLG: 0.357</small>	2-0 <b>F7</b>			2-1 <b>L7</b>			0-1 <b>4-3</b> <b>1B</b>		1-2 <b>1B</b> <b>1B</b>		4-0 <b>IBB</b>		2-2 <b>F9</b>	5 0 2 0 1 0 1		
<b>Don Newcombe, L</b> (1, 1) <small>OBP: 0.423, SLG: 0.364</small> <b>George Shubert, L</b> (8, PH) <small>OBP: 0.298, SLG: 0.362</small> <b>Clem Labine, R</b> (8, 1) <small>OBP: 0.196, SLG: 0.222</small> <b>Chuck Kress, L</b> (10, PH) <small>OBP: 0.200, SLG: 0.200</small> <b>Jim Hughes, R</b> (10, 1) <small>OBP: 0.289, SLG: 0.307</small> <b>Rube Walker, L</b> (11, PH) <small>OBP: 0.154, SLG: 0.154</small>	1-0 <b>F9</b>			1-0 <b>1B</b>			0-0 <b>F6</b>		0-0 <b>B5</b>	3-3 <b>K</b>			2 0 1 0 0 0 0 1 0 0 0 0 0 1 0 0 0 0 0 0 0 1 0 0 0 0 0 1 0 0 0 0 0 0 0 1 0 0 0 0 1 2 0 0 0 0 0 0 0			
<b>Inning Stats</b>	R: 0 H: 1 E: 0 LOB: 1 K: 0 BB: 0 S: 9 P: 15	R: 0 H: 1 E: 0 LOB: 1 K: 2 BB: 0 S: 11 P: 17	R: 0 H: 0 E: 0 LOB: 0 K: 0 BB: 0 S: 6 P: 9	R: 0 H: 1 E: 0 LOB: 1 K: 0 BB: 0 S: 6 P: 10	R: 0 H: 1 E: 0 LOB: 1 K: 0 BB: 0 S: 7 P: 11	R: 0 H: 0 E: 0 LOB: 0 K: 2 BB: 0 S: 9 P: 14	R: 0 H: 0 E: 0 LOB: 0 K: 1 BB: 0 S: 7 P: 10	R: 0 H: 1 E: 0 LOB: 1 K: 0 BB: 0 S: 9 P: 12	R: 2 H: 2 E: 0 LOB: 0 K: 2 BB: 0 S: 11 P: 18	R: 0 H: 2 E: 0 LOB: 3 K: 1 BB: 0 S: 12 P: 19	R: 0 H: 1 E: 1 LOB: 2 K: 2 BB: 1 S: 14 P: 26	R: 0 H: 2 E: 0 LOB: 1 K: 0 BB: 0 S: 6 P: 8	R: 1 H: 1 E: 0 LOB: 0 K: 0 BB: 0 S: 8 P: 12	1B: 10 SF: 0 2B: 0 SAC: 0 3B: 1 DP: 1 HR: 2 HBP: 1		WP: 0 PA: 53 PB: 0 SB: 0 CS: 0
<b>PITCHER</b> <b>Sal Maglie, R</b> (1, 1) <small>ERA: 3.2</small> <b>Marv Grissom, R</b> (10, 1) <small>ERA: 1.53</small>	IP 9.0 WLS 7 BF 34 H 6 R 1 ER 1 SO 3 BB 0 IBB 1 HBP 1 BLK 0 WP 0 HR 1 S 75 P 116 ERA 2.00 WHIP 0.778					<b>PITCHER</b> IP 4.0 WLS 19 BF 6 H 1 R 1 ER 1 SO 3 BB 0 IBB 1 HBP 1 BLK 0 WP 0 HR 1 S 40 P 65 ERA 2.25 WHIP 1.500										

livebaseballscorecards.com

AB	51
R	3
H	13
RBI	3
BB	1
SO	10
LOB	20

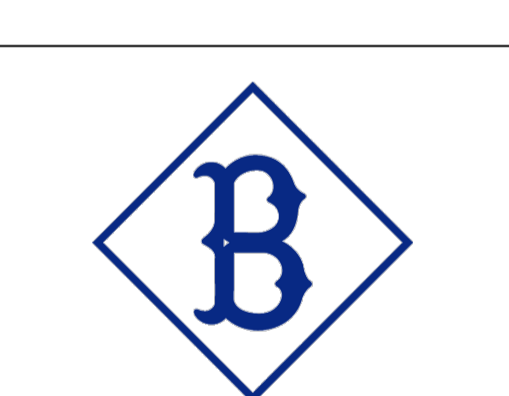

Batter	1	2	3	4	5	6	7	8	9	10	11	12	13	AB R H RBI BB SO LOB
Davey Williams, R OBP: 0.268, SLG: 0.322	0-1 F6		1-1 HR		0-1 F2			0-1 F9		4-2 BB		2-2 F4		5 1 1 1 1 0 1
Alvin Dark, R OBP: 0.314, SLG: 0.397	2-1 1B		0-2 6-3			1-0 6-3		1-2 F3		1-0 4-3		1-2 F7		6 0 1 0 0 0 2
Whitey Lockman, L OBP: 0.302, SLG: 0.399	2-1 F2		1-1 F8			2-1 4-3		0-0 F8			1-0 F9		4-1 FC4-6 BB	5 0 0 0 1 0 2
Hank Thompson, L OBP: 0.412, SLG: 0.508	0-0 F9			0-1 1B		1-1 1B			2-1 SH3-4 1B		2-1 4-3		1-2 F5	6 0 3 0 0 0 2
Don Mueller, L OBP: 0.375, SLG: 0.439		2-0 4-3		2-1 4-3		2-0 F7			0-0 SH3-4		1-1 1B		1-2 FC4-6 BB 1B	5 1 1 0 0 0 3
Willie Mays, R OBP: 0.390, SLG: 0.685		1-0 F7		0-2 6-3			2-3 K		4-0 G6-4-3 IBB		0-0 1B		4-2 BB 1B	4 1 1 0 2 1 1
Monte Irvin, R OBP: 0.353, SLG: 0.430		1-0 HR		1-0 F4			2-1 6-3		3-2 G6-4-3		4-0 IBB		4-2 1B BB	4 1 1 1 2 0 3
Wes Westrum, R OBP: 0.297, SLG: 0.330		1-2 F4			1-3 K		1-3 K		4-2 CS BB		0-0 4-3		1-2 1B	3 0 0 0 1 2 0
Ruben Gomez, R OBP: 0.229, SLG: 0.229													1-2 2-3 1B	0 0 0 0 0 0 0
Ray Katt, R OBP: 0.323, SLG: 0.380													1-2 2-3 1B	1 0 0 0 0 0 3
Dusty Rhodes, L OBP: 0.440, SLG: 0.565													1-2 2-H 3-H 1B	1 0 1 2 0 0 0
Sal Maglie, R OBP: 0.147, SLG: 0.094			3-3 K		1-1 6-3			4-2 BB		1-3 K		1-2 5-3		2 0 0 0 1 1 0
Marv Grissom, R OBP: 0.050, SLG: 0.050														2 0 0 0 0 1 1

Inning Stats	R: 0	H: 1	R: 1	H: 1	R: 1	H: 1	R: 0	H: 0	R: 0	H: 1	R: 0	H: 2	R: 0	H: 0	R: 0	H: 0	R: 2	H: 1		
	E: 0	LOB: 1	E: 0	LOB: 0	E: 0	LOB: 0	E: 0	LOB: 0	E: 0	LOB: 1	E: 0	LOB: 1	E: 0	LOB: 3	E: 0	LOB: 0	E: 0	LOB: 2	E: 0	LOB: 2
	K: 0	BB: 0	K: 0	BB: 0	K: 1	BB: 0	K: 0	BB: 0	K: 2	BB: 0	K: 0	BB: 1	K: 1	BB: 2	K: 0	BB: 1	K: 0	BB: 3	K: 0	BB: 3
	S: 7	P: 11	S: 8	P: 13	S: 10	P: 15	S: 8	P: 9	S: 6	P: 12	S: 10	P: 15	S: 9	P: 14	S: 8	P: 18	S: 7	P: 15	S: 10	P: 14

PITCHER	IP	WLS	BF	H	R	ER	SO	BB	IBB	HBP	BLK	WP	HR	S	P	ERA	WHIP
Don Newcombe, R ERA: 4.35	(1, 1)	7.0	26	5	2	2	4	0	0	0	0	0	2	56	86	2.57	0.714
Clem Labine, R ERA: 3.15	(8, 1)	2.0	8	1	0	0	0	1	1	0	0	0	0	15	29	0.00	1.000
Jim Hughes, R ERA: 2.82	(10, 1)	1.0	4	0	0	0	1	2	0	0	0	0	0	8	18	0.00	2.000
Billy Loes, R ERA: 5.93	(11, 1)	2.2	L 15	3	2	2	0	3	1	0	0	0	0	32	59	6.75	2.250

**BOTTOM**

**Brooklyn Dodgers @ New York Giants**  
Polo Grounds, New York, NY

Tue Jun 29 1954, 3:33 AM EDT  
Att: 51,464 - Unknown

AB	44
R	4
H	9
RBI	4
BB	8
SO	5
LOB	18



WP: 0	PA: 53
PB: 0	
SB: 0	
CS: 1	



Batter	1	2	3	4	5	6	7	8	9	AB	R	H	RBI	BB	SO	LOB
Davey Williams, R OBP: 0.270, SLG: 0.325 (1, 4)	0-2 1B SF7 2B	3-1 F4		1-0 F6		1-0 F6		4-1 1B BB 1-2 2-3		4	2	1	0	1	0	4
Alvin Dark, R OBP: 0.315, SLG: 0.395 (1, 6)	1-1 BB SF7 2-3 1B	1-0 6-3		1-0 F9			1-0 5-3	4-1 1B BB 1-2 2-3 3-H		4	0	1	1	1	0	4
Whitey Lockman, L OBP: 0.300, SLG: 0.397 (1, 3)	0-0 SF7 1-2 3-H		3-2 F8		0-1 F7		1-1 5-3	1-0 1B 1-3 2-H 3-H		4	0	1	3	0	0	0
Hank Thompson, L OBP: 0.416, SLG: 0.507 (1, 5)	1-1 BB HBP		1-0 F9		2-2 E 1B WP 1B		0-1 1B	2-1 L4		4	1	2	0	0	0	2
Don Mueller, L OBP: 0.373, SLG: 0.436 (1, 9)	0-0 L7		0-0 6-3		0-0 WP E 1B		0-0 F8			4	0	1	0	0	0	3
Willie Mays, R OBP: 0.391, SLG: 0.681 (1, 8)	4-1 1-2 2-3 BB			3-2 2B FC3-2 1B	SAFE	3-2 5-3		0-1 F8		3	0	1	0	1	0	2
Monte Irvin, R OBP: 0.355, SLG: 0.433 (1, 7)	3-2 5-3			1-0 FC3-2 1-3 2B		3-2 L8		4-2 BB BB BB		3	1	1	0	1	0	4
Wes Westrum, R OBP: 0.313, SLG: 0.326 (1, 2)		4-0 SH1-4 BB		4-2 FC3-2 BB		0-0 G3		4-1 BB BB 1-2 1B BB		1	1	0	0	3	0	0
Johnny Antonelli, L OBP: 0.196, SLG: 0.224 Hoyt Wilhelm, R (8, 1)		0-0 SH1-4		1-0 FC3-2 1-2 2-3 3-H		0-3 K2-3		0-3 K		2	0	0	0	0	1	3
										1	0	0	0	0	1	2

Inning Stats	R: 1	H: 2	E: 0	K: 0	S: 12	R: 0	H: 0	E: 0	K: 0	S: 4	R: 0	H: 0	E: 0	K: 0	S: 7	R: 0	H: 2	E: 0	K: 0	S: 12	R: 1	H: 2	E: 1	K: 0	S: 13	R: 0	H: 0	E: 0	K: 1	S: 5	R: 0	H: 1	E: 0	K: 0	S: 6	R: 3	H: 1	E: 0	K: 1	S: 14	R: 6	SF: 1	2B: 2	3B: 0	HR: 0	1B: 6	SF: 1	SAC: 1	DP: 0	HBP: 1	WP: 1	PA: 40
PITCHER	IP	WLS	BF	H	R	ER	SO	BB	IBB	HBP	BLK	WP	HR	S	P	ERA	WHIP																																			
Carl Erskine, R ERA: 3.28 (1, 1)	6.0	L	28	6	2	1	1	3	0	1	0	1	0	53	94	1.50	1.500																																			
Clem Labine, R ERA: 3.61 (7, 1)	1.2		9	1	3	3	1	3	0	0	0	0	0	16	30	16.20	2.400																																			
Jim Hughes, R ERA: 2.79 (8, 1)	0.1		3	1	0	0	0	1	0	0	0	0	0	4	11	0.00	6.000																																			

**BOTTOM**

**Brooklyn Dodgers @ New York Giants**  
Polo Grounds, New York, NY

Wed Jun 30 1954, 3:33 AM EDT  
Att. 29,693 - Unknown

[livebaseballscorecards.com](http://livebaseballscorecards.com)

<b>AB</b>	<b>30</b>
<b>R</b>	<b>5</b>
<b>H</b>	<b>8</b>
<b>RBI</b>	<b>4</b>
<b>BB</b>	<b>7</b>
<b>SO</b>	<b>2</b>
<b>LOB</b>	<b>24</b>



Batter	1	2	3	4	5	6	7	8	9	AB R H RBI BB SO LOB	TOP
<b>Jim Gilliam, S</b> (1, 4) <small>OBP: 0.321, SLG: 0.417</small>	0-2 		2-2 			0-1 		1-0 		4 0 0 0 0 0 1	
<b>Don Hoak, R</b> (1, 5) <small>OBP: 0.329, SLG: 0.469</small>	1-3 			3-2 		1-0 		4-1 		3 0 0 0 1 1 0	
<b>Walt Moryn, L</b> (1, 9) <small>OBP: 0.167, SLG: 0.167</small>	2-0 			2-2 		0-0 		1-1 	0-1 	4 0 0 0 0 0 0	
<b>Jackie Robinson, R</b> (1, 7) <small>OBP: 0.434, SLG: 0.582</small>		1-2 		0-1 			0-2 		1-0 	4 0 0 0 0 0 0	
<b>Gil Hodges, R</b> (1, 3) <small>OBP: 0.392, SLG: 0.615</small>		0-0 			2-1 		0-3 		2-1 	4 0 3 0 0 1 0	
<b>Roy Campanella, R</b> (1, 2) <small>OBP: 0.263, SLG: 0.450</small>		1-1 			2-3 		0-0 		4-1 	3 1 1 1 1 1 2	
<b>Carl Furillo, R</b> (1, 8) <small>OBP: 0.343, SLG: 0.368</small>			0-0 		2-0 		2-1 		4-0 	3 1 2 1 1 0 1	
<b>Billy Cox, R</b> (1, 6) <small>OBP: 0.322, SLG: 0.303</small>			1-2 		4-1 		1-2 		0-0 	3 0 0 0 1 0 4	
<b>Russ Meyer, S</b> (1, 1) <small>OBP: 0.150, SLG: 0.056</small> <b>George Shuba, L</b> (5, PH) <small>OBP: 0.288, SLG: 0.347</small> <b>Erv Palica, R</b> (5, 1) <small>OBP: 0.333, SLG: 0.250</small>			4-2 		3-3 			0-1 		0 0 0 0 1 0 0 1 0 0 0 0 1 2 1 0 0 0 0 0 0	
<b>Inning Stats</b>	R: 0 H: 0 E: 0 LOB: 0 K: 1 BB: 0 S: 8 P: 11	R: 0 H: 1 E: 0 LOB: 0 K: 0 BB: 0 S: 7 P: 9	R: 0 H: 1 E: 0 LOB: 1 K: 0 BB: 1 S: 11 P: 18	R: 0 H: 0 E: 0 LOB: 0 K: 0 BB: 0 S: 8 P: 13	R: 0 H: 1 E: 0 LOB: 2 K: 2 BB: 1 S: 11 P: 24	R: 0 H: 0 E: 0 LOB: 0 K: 0 BB: 0 S: 4 P: 5	R: 2 H: 2 E: 0 LOB: 0 K: 1 BB: 0 S: 14 P: 17	R: 0 H: 0 E: 0 LOB: 0 K: 0 BB: 1 S: 5 P: 11	R: 0 H: 1 E: 0 LOB: 3 K: 0 BB: 2 S: 7 P: 18	1B: 3 SF: 0 2B: 2 SAC: 0 3B: 0 DP: 2 HR: 2 HBP: 0	WP: 0 PA: 36 PB: 0 SB: 0 CS: 1
<b>PITCHER</b> <b>Ruben Gomez, R</b> (1, 1) <small>ERA: 3.18</small> <b>Hoyt Wilhelm, R</b> (9, 1) <small>ERA: 2.17</small> <b>Mary Grissom, R</b> (9, 1) <small>ERA: 1.52</small>	IP WLS BF H R ER SO BB IBB HBP BLK WP HR S P ERA WHIP 8.0 W 29 5 2 2 4 3 0 0 0 0 2 68 108 2.25 1.000 0.2 5 1 0 0 0 2 0 0 0 0 0 6 17 0.00 4.500 0.1 S 1 0 0 0 0 0 0 0 0 0 0 0 1 1 0.00 0.000	<b>PITCHER</b> IP WLS BF H R ER SO BB IBB HBP BLK WP HR S P ERA WHIP 0.0 0 0 0 0 0 0 0 0 0 0 0 0 0 0.00 0.000									

**Brooklyn Dodgers @ New York Giants**  
 Polo Grounds, New York, NY  
 Thu Jul 01 1954, 3:33 AM EDT  
 Att: 21,560 - Unknown

AB	30
R	2
H	6
RBI	2
BB	5
SO	4
LOB	10





Batter	1	2	3	4	5	6	7	8	9	AB R H RBI BB SO LOB	TOP		
Davey Williams, R (1, 4) OBP: 0.272, SLG: 0.346	0-0 6-3		0-0 5-3		0-0 E7 1B 2B		0-0 P5	0-0 F8		5 1 1 0 0 0 1			
Alvin Dark, R (1, 6) OBP: 0.319, SLG: 0.403	0-0 4-3 HR 1B		0-0 L9		0-0 6-3		0-0 1B 1B 2B		0-0 4-3	5 2 2 0 0 0 1			
Whitey Lockman, L (1, 3) OBP: 0.304, SLG: 0.396	0-0 4-3 1-2		0-0 6-3		0-0 S 1B		0-0 E 1B		0-0 4-3	5 1 2 2 0 0 1			
Hank Thompson, L (1, 5) OBP: 0.411, SLG: 0.512	0-0 HR 2-H			0-0 F3	0-0 F7 1-2		0-0 E 2B 1B		0-0 F9	5 2 2 3 0 0 1			
Don Mueller, L (1, 9) OBP: 0.369, SLG: 0.433	0-0 F8			0-0 5-3		0-0 P4	0-0 FC4 2B			4 1 0 0 0 0 1			
Willie Mays, R (1, 8) OBP: 0.397, SLG: 0.684		0-0 1B		0-0 1B 2B		0-0 F2	0-0 2B 1-H 2-H			4 1 3 2 0 0 0			
Monte Irvin, R (1, 7) OBP: 0.353, SLG: 0.426		0-0 P4		0-0 1B 2-H		0-0 6-3	0-0 5-3			4 0 1 1 0 0 2			
Wes Westrum, R (1, 2) OBP: 0.293, SLG: 0.304		0-0 F9		0-0 P4			0-0 F7	0-0 P6		4 0 0 0 0 0 2			
Ramon Monzant, R (1, 1) Alex Konikowski, R (4, 1) Windy McCall, L (4, 1) Hoyt Wilhelm, R (6, 1) Dusty Rhodes, L (7, PH) Sal Maglie, R (7, 1)		0-0 4-3			0-0 4-3		0-0 2B 1B	0-0 6-3		1 0 0 0 0 0 1 0 0 0 0 0 0 0 1 0 0 0 0 0 0 0 0 0 0 0 0 0 1 1 1 0 0 0 0 1 0 0 0 0 0 0			
<b>Inning Stats</b>	R: 2 H: 2 E: 0 LOB: 0 K: 0 BB: 0 S: 5 P: 5	R: 0 H: 1 E: 0 LOB: 1 K: 0 BB: 0 S: 4 P: 4	R: 0 H: 0 E: 0 LOB: 0 K: 0 BB: 0 S: 3 P: 3	R: 1 H: 2 E: 0 LOB: 1 K: 0 BB: 0 S: 5 P: 5	R: 1 H: 2 E: 1 LOB: 1 K: 0 BB: 0 S: 5 P: 5	R: 0 H: 0 E: 0 LOB: 0 K: 0 BB: 0 S: 3 P: 3	R: 5 H: 5 E: 1 LOB: 1 K: 0 BB: 0 S: 9 P: 9	R: 0 H: 0 E: 0 LOB: 0 K: 0 BB: 0 S: 3 P: 3	R: 0 H: 0 E: 0 LOB: 0 K: 0 BB: 0 S: 3 P: 3	1B: 7 SF: 0 2B: 4 SAC: 0 3B: 0 DP: 0 HR: 1 HBP: 0	WP: 0 PA: 40 PB: 0 SB: 1 CS: 0		
<b>PITCHER</b>	IP WLS BF H R ER SO BB IBB HBP BLK WP HR S P ERA WHIP											<b>PITCHER</b>	IP WLS BF H R ER SO BB IBB HBP BLK WP HR S P ERA WHIP
Bob Friend, R (1, 1) ERA: 5.88	6.2 L 33 12 9 5 0 0 0 0 0 0 0 1 33 33 6.75 1.800												
Johnny Hetki, R (7, 1) ERA: 5.09	2.1 7 0 0 0 0 0 0 0 0 0 0 0 7 7 0.00 0.000												

**New York Giants @ Pittsburgh Pirates**  
**Forbes Field, Pittsburgh, PA**  
 Fri Jul 02 1954, 3:33 AM EDT  
 Att. 9,603 - Unknown

[livebaseballscorecards.com](http://livebaseballscorecards.com)

<b>AB</b>	40
<b>R</b>	9
<b>H</b>	12
<b>RBI</b>	8
<b>BB</b>	0
<b>SO</b>	0
<b>LOB</b>	10





BOTTOM

New York Giants @ Pittsburgh Pirates  
Forbes Field, Pittsburgh, PA

livebaseballscorecards.com

AB	31
R	5
H	6
RBI	5
BB	8
SO	8
LOB	18



WP:	0	PA:	39
PB:	0	SB:	0
CS:	0		

ERA	9.82	WHIP	1.909
ERA	3.86		
ERA	3.19		
ERA	2.14		
ERA	3.12		

AB	R	H	RBI	BB	SO	LOB
5	1	2	0	0	2	4
5	0	1	0	0	1	1
3	1	0	0	2	1	1
4	1	1	1	0	0	3
2	1	0	0	2	0	2
3	1	0	0	1	0	4
4	0	1	2	0	3	1
2	0	1	1	2	0	0
2	0	0	1	1	0	2
0	0	0	0	0	0	0
1	0	0	0	0	1	0

Batter	1	2	3	4	5	6	7	8	9
Gair Allie, R OBP: 0.298, SLG: 0.296	0-3 K			0-0 K		0-0 L7			0-0 1B
Jerry Lynch, L OBP: 0.260, SLG: 0.336	0-0 4-3			0-0 FC5 BB 1-2 1B	0-0 P3		0-3 K	0-0 F7	
Preston Ward, L OBP: 0.325, SLG: 0.364	0-0 F8			4-0 BB FC5 1-2 2-3 2B BB	4-0 BB		0-0 F9	0-3 K	
Frank Thomas, R OBP: 0.361, SLG: 0.472		0-0 P4		0-0 FC5 BB 1-2 2-3f 3-H 2B	0-0 F8		0-0 1B		
Sid Gordon, R OBP: 0.402, SLG: 0.346		4-0 G5-4-3 BB		4-0 2B BB 1-2 2-3	0-0 F9		0-0 F9		
Jack Shepard, R OBP: 0.343, SLG: 0.347		0-0 G5-4-3 1-2f		0-0 P4		4-0 3B BB		0-0 P3	
Dick Cole, R OBP: 0.349, SLG: 0.371		0-3 K		0-0 BB 1-3 2-H 3-H 2B		0-3 K		0-3 K	
Curt Roberts, R OBP: 0.279, SLG: 0.285		4-0 G5-4-3 BB		4-0 BB G5-4-3 IBB		0-0 1-H 3B		0-0 6-3	
Bob Friend, R OBP: 0.357, SLG: 0.375		0-0 G5-4-3		4-0 BB 1-2 2-3 3-H BB		0-0 P3		0-3 K	
Johnny Hetki, R OBP: 0.333, SLG: 0.333									
Bob Skinner, L OBP: 0.330, SLG: 0.372									

Inning Stats	R	H	E	K	S	P	IP	WLS	BF	H	R	ER	SO	BB	IBB	HBP	BLK	WP	HR	S	P	ERA	WHIP	
Ramon Monzant, R ERA: 9.82	0	0	0	1	5	7	3.2		16	3	4	4	2	4	0	0	0	0	0	0	0	9.82	1.909	
Alex Konikowski, R ERA: 3.86	0	0	0	0	0	0	0.0		2	0	0	0	0	1	1	0	0	0	0	0	0	∞	∞	
Windy McCall, L ERA: 3.19	0	1	0	0	0	0	1.2		8	1	1	1	2	2	0	0	0	0	0	0	2	2	5.40	1.800
Hoyt Wilhelm, R ERA: 2.14	0	0	0	0	0	0	0.2	W	2	0	0	0	0	0	0	0	0	0	0	0	2	2	0.00	0.000
Sal Maglie, R ERA: 3.12	0	0	0	0	0	0	3.0	S	11	2	0	0	4	0	0	0	0	0	0	0	19	19	0.00	0.667

PITCHER	IP	WLS	BF	H	R	ER	SO	BB	IBB	HBP	BLK	WP	HR	S	P	ERA	WHIP
Ramon Monzant, R ERA: 9.82	3.2		16	3	4	4	2	4	0	0	0	0	0	16	32	9.82	1.909
Alex Konikowski, R ERA: 3.86	0.0		2	0	0	0	0	1	1	0	0	0	0	0	8	∞	∞
Windy McCall, L ERA: 3.19	1.2		8	1	1	1	2	2	0	0	0	0	0	10	18	5.40	1.800
Hoyt Wilhelm, R ERA: 2.14	0.2	W	2	0	0	0	0	0	0	0	0	0	0	2	2	0.00	0.000
Sal Maglie, R ERA: 3.12	3.0	S	11	2	0	0	4	0	0	0	0	0	0	19	19	0.00	0.667

PITCHER	IP	WLS	BF	H	R	ER	SO	BB	IBB	HBP	BLK	WP	HR	S	P	ERA	WHIP
Ramon Monzant, R ERA: 9.82	3.2		16	3	4	4	2	4	0	0	0	0	0	16	32	9.82	1.909
Alex Konikowski, R ERA: 3.86	0.0		2	0	0	0	0	1	1	0	0	0	0	0	8	∞	∞
Windy McCall, L ERA: 3.19	1.2		8	1	1	1	2	2	0	0	0	0	0	10	18	5.40	1.800
Hoyt Wilhelm, R ERA: 2.14	0.2	W	2	0	0	0	0	0	0	0	0	0	0	2	2	0.00	0.000
Sal Maglie, R ERA: 3.12	3.0	S	11	2	0	0	4	0	0	0	0	0	0	19	19	0.00	0.667

PITCHER	IP	WLS	BF	H	R	ER	SO	BB	IBB	HBP	BLK	WP	HR	S	P	ERA	WHIP
Ramon Monzant, R ERA: 9.82	3.2		16	3	4	4	2	4	0	0	0	0	0	16	32	9.82	1.909
Alex Konikowski, R ERA: 3.86	0.0		2	0	0	0	0	1	1	0	0	0	0	0	8	∞	∞
Windy McCall, L ERA: 3.19	1.2		8	1	1	1	2	2	0	0	0	0	0	10	18	5.40	1.800
Hoyt Wilhelm, R ERA: 2.14	0.2	W	2	0	0	0	0	0	0	0	0	0	0	2	2	0.00	0.000
Sal Maglie, R ERA: 3.12	3.0	S	11	2	0	0	4	0	0	0	0	0	0	19	19	0.00	0.667

PITCHER	IP	WLS	BF	H	R	ER	SO	BB	IBB	HBP	BLK	WP	HR	S	P	ERA	WHIP
Ramon Monzant, R ERA: 9.82	3.2		16	3	4	4	2	4	0	0	0	0	0	16	32	9.82	1.909
Alex Konikowski, R ERA: 3.86	0.0		2	0	0	0	0	1	1	0	0	0	0	0	8	∞	∞
Windy McCall, L ERA: 3.19	1.2		8	1	1	1	2	2	0	0	0	0	0	10	18	5.40	1.800
Hoyt Wilhelm, R ERA: 2.14	0.2	W	2	0	0	0	0	0	0	0	0	0	0	2	2	0.00	0.000
Sal Maglie, R ERA: 3.12	3.0	S	11	2	0	0	4	0	0	0	0	0	0	19	19	0.00	0.667

PITCHER	IP	WLS	BF	H	R	ER	SO	BB	IBB	HBP	BLK	WP	HR	S	P	ERA	WHIP
Ramon Monzant, R ERA: 9.82	3.2		16	3	4	4	2	4	0	0	0	0	0	16	32	9.82	1.909
Alex Konikowski, R ERA: 3.86	0.0		2	0	0	0	0	1	1	0	0	0	0	0	8	∞	∞
Windy McCall, L ERA: 3.19	1.2		8	1	1	1	2	2	0	0	0	0	0	10	18	5.40	1.800
Hoyt Wilhelm, R ERA: 2.14	0.2	W	2	0	0	0	0	0	0	0	0	0	0	2	2	0.00	0.000
Sal Maglie, R ERA: 3.12	3.0	S	11	2	0	0	4	0	0	0	0	0	0	19	19	0.00	0.667

PITCHER	IP	WLS	BF	H	R	ER	SO	BB	IBB	HBP	BLK	WP	HR	S	P	ERA	WHIP
Ramon Monzant, R ERA: 9.82	3.2		16	3	4	4	2	4	0	0	0	0	0	16	32	9.82	1.909
Alex Konikowski, R ERA: 3.86	0.0		2	0	0	0	0	1	1	0	0	0	0	0	8	∞	∞
Windy McCall, L ERA: 3.19	1.2		8	1	1	1	2	2	0	0	0	0	0	10	18	5.40	1.800
Hoyt Wilhelm, R ERA: 2.14	0.2	W	2	0	0	0	0	0	0	0	0	0	0	2	2	0.00	0.000
Sal Maglie, R ERA: 3.12	3.0	S	11	2	0	0	4	0	0	0	0	0	0	19	19	0.00	0.667

PITCHER	IP	WLS	BF	H	R	ER	SO	BB	IBB	HBP	BLK	WP	HR	S	P	ERA	WHIP
Ramon Monzant, R ERA: 9.82	3.2		16	3	4	4	2	4	0	0	0	0	0	16	32	9.82	1.909
Alex Konikowski, R ERA: 3.86	0.0		2	0	0	0	0	1	1	0	0	0	0	0	8	∞	∞
Windy McCall, L ERA: 3.19	1.2		8	1	1	1	2	2	0	0	0	0	0	10	18	5.40	1.800
Hoyt Wilhelm, R ERA: 2.14	0.2	W	2	0	0	0	0	0	0	0	0	0	0	2	2	0.00	0.000
Sal Maglie, R ERA: 3.12	3.0	S	11	2	0	0	4	0	0	0	0	0	0	19	19	0.00	0.667

PITCHER	IP	WLS	BF	H	R	ER	SO	BB	IBB	HBP	BLK	WP	HR	S	P	ERA	WHIP
Ramon Monzant, R ERA: 9.82	3.2		16	3	4	4	2	4	0	0	0	0	0	16	32	9.82	1.909
Alex Konikowski, R ERA: 3.86	0.0		2	0	0	0	0	1	1	0	0	0	0	0	8	∞	∞
Windy McCall, L ERA: 3.19	1.2		8	1	1	1	2	2	0	0	0	0	0	10	18	5.40	1.800
Hoyt Wilhelm, R ERA: 2.14	0.2	W	2	0	0	0	0	0	0	0	0	0	0	2	2	0.00	0.000
Sal Maglie, R ERA: 3.12	3.0	S	11	2	0	0	4	0	0	0	0	0	0	19	19	0.00	0.667

PITCHER	IP	WLS	BF	H	R	ER	SO	BB	IBB	HBP	BLK	WP	HR	S	P	ERA	WHIP
Ramon Monzant, R ERA: 9.82	3.2		16	3	4	4	2	4	0	0	0	0	0	16	32	9.82	1.909
Alex Konikowski, R ERA: 3.86	0.0		2	0	0	0	0	1	1	0	0	0	0	0	8	∞	∞
Windy McCall, L ERA: 3.19	1.2		8	1	1	1	2	2	0	0	0	0	0	10	18	5.40	1.800
Hoyt Wilhelm, R ERA: 2.14	0.2	W	2	0	0	0	0	0	0	0	0	0	0	2	2	0.00	0.000
Sal Maglie, R ERA: 3.12	3.0	S	11	2	0	0	4	0	0	0	0	0	0	19	19	0.00	0.667













Batter	1	2	3	4	5	6	7	8	9	AB R H RBI BB SO LOB	TOP	
Willie Jones, R (1, 5) OBP: 0.332, SLG: 0.388	0-3 K		0-3 K		0-0 F8			0-0 F7		4 0 0 0 0 2 1	<b>Philadelphia Phillies @ New York Giants</b> Polo Grounds, New York, NY Mon Jul 05 1954, 3:33 AM EDT Unknown <a href="http://livebaseballscorecards.com">livebaseballscorecards.com</a>	
Richie Ashburn, L (1, 8) OBP: 0.431, SLG: 0.375	4-0 BB		0-0 F7		0-0 5-3			0-0 FC6-4		3 0 0 0 1 0 1		
Stan Lopata, R (1, 2) OBP: 0.399, SLG: 0.535	0-0 F3		4-0 BB				0-0 P4	0-0 F7		3 0 0 0 1 0 2		
Danny Schell, R (1, 7) OBP: 0.329, SLG: 0.425	0-0 L4		0-0 1-3				0-0 P4		0-0 P6	4 0 0 0 0 0 2		
Granny Hamner, R (1, 4) OBP: 0.389, SLG: 0.495		0-0 5-3		0-0 3B			0-0 4-3		0-3 K	4 0 1 0 0 1 0		
Mel Clark, R (1, 9) OBP: 0.289, SLG: 0.290		0-0 P4		0-0 5-3			0-0 F8		0-0 1-3	4 0 0 0 0 0 1		
Earl Torgeson, L (1, 3) OBP: 0.384, SLG: 0.401		0-0 1B 1B		0-3 K			0-3 K			3 0 1 0 0 2 1		
Bobby Morgan, R (1, 6) OBP: 0.398, SLG: 0.439		0-0 1-2 1B		0-0 1-3			0-0 1-3			3 0 1 0 0 0 1		
Herm Wehmeier, R (1, 1) Jim Konstanty, R (3, 1) Bob Greenwood, R (3, 1)		0-3 K		0-3 K				4-0 FC6-4 BB		1 0 0 0 0 1 2 0 0 0 0 0 0 0 1 0 0 0 1 1 0		
<b>Inning Stats</b>	R: 0 H: 0 E: 0 LOB: 1 K: 1 BB: 1 S: 5 P: 9	R: 0 H: 2 E: 0 LOB: 2 K: 1 BB: 0 S: 7 P: 7	R: 0 H: 0 E: 0 LOB: 1 K: 1 BB: 1 S: 5 P: 9	R: 0 H: 1 E: 0 LOB: 1 K: 1 BB: 0 S: 6 P: 6	R: 0 H: 0 E: 0 LOB: 0 K: 1 BB: 0 S: 5 P: 5	R: 0 H: 0 E: 0 LOB: 0 K: 0 BB: 0 S: 3 P: 3	R: 0 H: 0 E: 0 LOB: 0 K: 1 BB: 0 S: 5 P: 5	R: 0 H: 0 E: 0 LOB: 1 K: 0 BB: 1 S: 3 P: 7	R: 0 H: 0 E: 0 LOB: 0 K: 1 BB: 0 S: 5 P: 5	1B: 2 SF: 0 2B: 0 SAC: 0 3B: 1 DP: 0 HR: 0 HBP: 0	WP: 0 PA: 33 PB: 0 SB: 0 CS: 0	
<b>PITCHER</b> Johnny Antonelli, L (1, 1) ERA: 2.06	IP WLS BF H R ER SO BB IBB HBP BLK WP HR S P ERA WHIP	9.0 W 33 3 0 0 7 3 0 0 0 0 0 0 44 56 0.00 0.667										

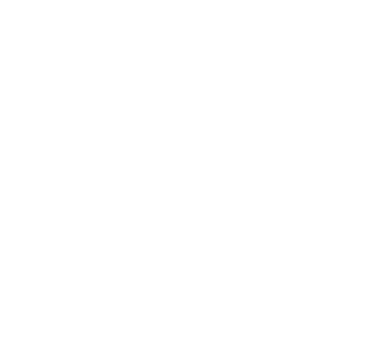



Batter	1	2	3	4	5	6	7	8	9	AB	R	H	RBI	BB	SO	LOB
Whitey Lockman, L (1, 3) OBP: 0.301, SLG: 0.384	0-0 E6 1B	0-0 P6	0-0 5-3		0-0 4-3			0-0 6-3		5	1	1	0	0	0	1
Alvin Dark, R (1, 6) OBP: 0.329, SLG: 0.415	0-0 1B SF9 2-H		0-0 2B 1B	0-0 HR		0-0 G4-6-3 1B		0-0 L5		5	3	4	1	0	0	0
Dusty Rhodes, L (1, 7) OBP: 0.500, SLG: 0.788	0-0 F9		0-0 1B 3B 2B	0-0 1-H HR		0-0 G4-6-3 1-2f				4	2	2	2	0	0	2
Hank Thompson, L (1, 5) OBP: 0.412, SLG: 0.507	0-0 1-3 1B		4-0 1B 3B IBB	0-0 G3		4-0 BB BB BB				2	1	1	0	2	0	0
Don Mueller, L (1, 9) OBP: 0.367, SLG: 0.430	0-0 SF9 3-H		0-0 1-2 2-3 3-H 3B 1B	0-0 F7		0-0 L8				3	1	1	2	0	0	1
Willie Mays, R (1, 8) OBP: 0.400, SLG: 0.688	0-0 F9		0-0 1-H 2-H 3-H HR 3B	0-0 E5		4-0 BB BB BB G6-4-3 BB				3	1	1	3	1	0	1
Davey Williams, R (1, 4) OBP: 0.289, SLG: 0.358		0-0 F7	0-0 HR	0-0 1-3		0-0 F9				4	1	1	2	0	0	2
Wes Westrum, R (1, 2) OBP: 0.281, SLG: 0.292		0-0 F8	0-0 3-H P3		0-0 6-3		0-0 G6-4-3 1-2f			4	0	0	0	0	0	1
Johnny Antonelli, L (1, 1) OBP: 0.200, SLG: 0.226		0-0 1B	0-0 6-3		0-0 F9		0-0 4-3			4	0	1	0	0	0	0

Inning Stats	R: 2	H: 3	E: 1	K: 0	S: 6	LOB: 1	BB: 0	P: 6	R: 0	H: 1	E: 0	K: 0	S: 4	LOB: 1	BB: 0	P: 4	R: 6	H: 5	E: 0	K: 0	S: 8	LOB: 0	BB: 1	P: 12	R: 2	H: 2	E: 1	K: 0	S: 6	LOB: 1	BB: 0	P: 6	R: 0	H: 0	E: 0	K: 0	S: 3	LOB: 0	BB: 0	P: 3	R: 0	H: 1	E: 0	K: 0	S: 3	LOB: 1	BB: 1	P: 7	R: 0	H: 0	E: 0	K: 0	S: 2	LOB: 0	BB: 1	P: 6	R: 0	H: 0	E: 0	K: 0	S: 3	LOB: 0	BB: 0	P: 3
--------------	------	------	------	------	------	--------	-------	------	------	------	------	------	------	--------	-------	------	------	------	------	------	------	--------	-------	-------	------	------	------	------	------	--------	-------	------	------	------	------	------	------	--------	-------	------	------	------	------	------	------	--------	-------	------	------	------	------	------	------	--------	-------	------	------	------	------	------	------	--------	-------	------

PITCHER	IP	WLS	BF	H	R	ER	SO	BB	IBB	HBP	BLK	WP	HR	S	P	ERA	WHIP
Herm Wehmeier, R (1, 1) ERA: 5.95	2.0	L	14	7	6	6	0	0	0	0	0	0	0	13	17	27.00	3.500
Jim Konstanty, R (3, 1) ERA: 3.89	0.0		2	2	2	2	0	0	0	0	0	0	1	2	2	∞	∞
Bob Greenwood, R (3, 1) ERA: 2.16	6.0		22	3	2	2	0	2	0	0	0	0	1	20	28	3.00	0.833

**BOTTOM**

**Philadelphia Phillies @ New York Giants**  
Polo Grounds, New York, NY

Mon Jul 05 1954, 3:33 AM EDT  
Unknown

AB	34
R	10
H	12
RBI	10
BB	3
SO	0
LOB	8



WP: 0	PA: 38
PB: 0	SB: 0
CS: 0	

livebaseballscorecards.com

Batter	1	2	3	4	5	6	7	8	9	AB R H RBI BB SO LOB	TOP															
Willie Jones, R OBP: 0.330, SLG: 0.384 (1, 5) X	0-0 G4-6-3 1B BB	0-0 F3		0-0 F2		0-0 F8			0-3 K2-3	5 1 1 0 0 1 2																
Richie Ashburn, L OBP: 0.441, SLG: 0.378 (1, 8) B B B B	4-0 G4-6-3 1-2 BB	0-0 1B 1-3 3-H 1B		4-0 1B BB			4-0 BB BB	4-0 G5-4-3 BB		1 0 1 1 4 0 0																
Smoky Burgess, L OBP: 0.424, SLG: 0.469 Stan Lopata, R OBP: 0.396, SLG: 0.531 (1, 2) X (7, PR) (7, 2)	0-0 G4-6-3 1-2f 2-3	0-0 3-H 1B		0-0 1B			4-0 G6-4-3 1-2 BB	0-0 G5-4-3 1-2f		3 0 2 1 1 0 2 1 0 0 0 0 0 1																
Danny Schell, R OBP: 0.325, SLG: 0.416 (1, 7) X	0-0 BB 1B	0-0 F3			0-0 6-3		0-0 B3			4 0 1 1 0 0 4																
Granny Hamner, R OBP: 0.390, SLG: 0.491 (1, 4) B B B B	4-0 1-2 BB			4-0 BB		0-3 K		0-0 G6-4-3 1-2f		2 0 0 0 2 1 2																
Johnny Wyrostek, L OBP: 0.285, SLG: 0.359 (1, 9) S S S	0-3 K			0-0 F7		0-0 1B		0-0 F2		4 0 1 0 0 1 3																
Earl Torgeson, L OBP: 0.386, SLG: 0.402 (1, 3)				0-0 F7		0-0 4-3		0-0 FC5-4 1B		4 1 2 0 0 0 2																
Bobby Morgan, R OBP: 0.393, SLG: 0.432 (1, 6)		0-0 SH3-4 1B		0-0 L4				0-0 F8		3 0 0 0 0 0 2																
Murry Dickson, R OBP: 0.209, SLG: 0.238 Mel Clark, R OBP: 0.287, SLG: 0.287 Steve Ridzik, R OBP: 0.231, SLG: 0.385 (1, 1) (8, PH) (8, 1)		0-0 E1 1B 2-3		0-0 F7		0-0 F5		0-0 FC5-4 1-2f		3 1 0 0 0 0 1 1 0 0 0 0 0 1 0 0 0 0 0 0 0																
<b>Inning Stats</b>	R: 1 E: 0 K: 1 S: 6	H: 2 LOB: 2 BB: 2 P: 14	R: 2 E: 1 K: 0 S: 7	H: 3 LOB: 2 BB: 0 P: 7	R: 0 E: 0 K: 0 S: 3	H: 0 LOB: 1 BB: 1 P: 7	R: 0 E: 1 K: 0 S: 3	H: 1 LOB: 2 BB: 1 P: 7	R: 0 E: 0 K: 1 S: 6	H: 1 LOB: 1 BB: 0 P: 6	R: 0 E: 0 K: 0 S: 3	H: 0 LOB: 0 BB: 0 P: 3	R: 0 E: 0 K: 0 S: 2	H: 0 LOB: 2 BB: 2 P: 10	R: 0 E: 0 K: 0 S: 4	H: 1 LOB: 1 BB: 0 P: 4	R: 0 E: 0 K: 1 S: 4	H: 0 LOB: 0 BB: 1 P: 8	1B: 8 2B: 0 3B: 0 HR: 0	SF: 0 SAC: 1 DP: 3 HBP: 0	WP: 0 PB: 0 SB: 0 CS: 0	PA: 39				
<b>PITCHER</b>	IP WLS BF H R ER SO BB IBB HBP BLK WP HR S P ERA WHIP																									
Ruben Gomez, R ERA: 3.22 (1, 1)	1.2		12	5	3	1	1	2	0	0	0	0	0	0	12	20	5.40	4.200								
Windy McCall, L ERA: 2.91 (2, 1)	2.1		9	1	0	0	0	2	0	0	0	0	0	7	15	0.00	1.286									
Ramon Monzant, R ERA: 6.35 (5, 1)	2.0		9	1	0	0	1	2	0	0	0	0	0	9	17	0.00	1.500									
Hoyt Wilhelm, R ERA: 2.09 (7, 1)	3.0	W	9	1	0	0	1	1	0	0	0	0	0	10	14	0.00	0.667									

Philadelphia Phillies @ New York Giants  
Polo Grounds, New York, NY  
Mon Jul 05 1954, 3:38 AM EDT  
Att: 36,547 - Unknown

AB	31
R	3
H	8
RBI	3
BB	7
SO	3
LOB	20



WP: 0	PA: 39
PB: 0	
SB: 0	
CS: 0	

livebaseballscorecards.com

BOTTOM

Philadelphia Phillies @ New York Giants  
Polo Grounds, New York, NY  
Mon Jul 05 1954, 3:38 AM EDT  
Att. 36,547 - Unknown

livebaseballscorecards.com

AB	34
R	4
H	11
RBI	4
BB	1
SO	3
LOB	11



WP:	0	PA:	35
PB:	0	SB:	0
CS:	0		

AB R H RBI BB SO LOB

4	1	2	0	0	0	1
4	1	1	0	0	0	1
4	1	3	3	0	0	0
4	0	1	0	0	0	1
4	0	0	0	0	0	2
4	1	1	1	0	0	0
3	0	2	0	1	0	0
4	0	1	0	0	1	3
0	0	0	0	0	0	0
1	0	0	0	0	1	1
1	0	0	0	0	0	1
1	0	0	0	0	1	1
0	0	0	0	0	0	0

1B:	9	SF:	0
2B:	0	SAC:	0
3B:	0	DP:	1
HR:	2	HBP:	0

WP	HR	S	P	ERA	WHIP
----	----	---	---	-----	------

Batter	1	2	3	4	5	6	7	8	9
Whitey Lockman, L (1, 3) OBP: 0.304, SLG: 0.386	0-0 G1-6-3 1B		0-0 6-3		0-0 1B HR 1B	0-0 G3			
Alvin Dark, R (1, 6) OBP: 0.328, SLG: 0.413	0-0 G1-6-3 1-2f		0-0 F8		0-0 1-3 HR 1B		0-0 5-3		
Dusty Rhodes, L (1, 7) OBP: 0.525, SLG: 0.865	0-0 1B		0-0 1B		0-0 1-H 3-H HR		0-0 F3		
Hank Thompson, L (1, 5) OBP: 0.409, SLG: 0.502	0-0 1-3		0-0 1-2 1B		0-0 F3		0-0 G3		
Don Mueller, L (1, 9) OBP: 0.383, SLG: 0.424		0-0 F7	0-0 4-3		0-0 P6		0-0 F8		
Willie Mays, R (1, 8) OBP: 0.398, SLG: 0.692		0-0 HR		0-0 F8	0-0 L6		0-0 P6		
Davey Williams, R (1, 4) OBP: 0.296, SLG: 0.361		0-0 1B		0-0 1B		0-0 F8		4-0 BB BB BB	
Wes Westrum, R (1, 2) OBP: 0.281, SLG: 0.291		0-0 F5		0-0 P4		0-0 1B		0-3 K	
Ruben Gomez, R (1, 1) OBP: 0.211, SLG: 0.211		0-3 K		0-0 1-3		0-3 K			
Windy McCall, L (2, 1)									
Bill Taylor, L (4, PH) OBP: 0.256, SLG: 0.308									
Ramon Monzant, R (5, 1)									
Hoyt Wilhelm, R (7, 1)									

Inning Stats	R: 0	H: 2	E: 0	LOB: 1	K: 0	BB: 0	S: 4	R: 1	H: 2	E: 0	LOB: 1	K: 1	BB: 0	S: 7	R: 0	H: 2	E: 0	LOB: 2	K: 0	BB: 0	S: 5	R: 0	H: 1	E: 0	LOB: 1	K: 0	BB: 0	S: 4	R: 3	H: 3	E: 0	LOB: 0	K: 0	BB: 0	S: 6	R: 0	H: 1	E: 0	LOB: 1	K: 1	BB: 0	S: 6	R: 0	H: 0	E: 0	LOB: 0	K: 0	BB: 0	S: 3	R: 0	H: 0	E: 0	LOB: 1	K: 1	BB: 1	S: 5
--------------	------	------	------	--------	------	-------	------	------	------	------	--------	------	-------	------	------	------	------	--------	------	-------	------	------	------	------	--------	------	-------	------	------	------	------	--------	------	-------	------	------	------	------	--------	------	-------	------	------	------	------	--------	------	-------	------	------	------	------	--------	------	-------	------

PITCHER	IP	WLS	BF	H	R	ER	SO	BB	IBB	HBP	BLK	WP	HR	S	P	ERA	WHIP
Murry Dickson, R (1, 1) ERA: 3.28	7.0	L	31	11	4	4	2	0	0	0	0	0	2	35	35	5.14	1.571
Steve Ridzik, R (8, 1) ERA: 3.32	1.0		4	0	0	0	1	1	0	0	0	0	0	5	9	0.00	1.000

Batter	1	2	3	4	5	6	7	8	9	AB R H RBI BB SO LOB	TOP		
Whitey Lockman, L (1, 3) OBP: 0.309, SLG: 0.386	4-2 G1-6-3 BB			0-0 HR 1B	1-1 G4-6-3 1-2f		4-2 BB 2-3			2 1 1 0 2 0 1			
Alvin Dark, R (1, 6) OBP: 0.330, SLG: 0.423	0-0 G1-6-3 1-2f			1-0 HR 1-H	0-0 6-3			0-2 G6-3 1B		4 1 2 2 0 0 1			
Hank Thompson, L (1, 5) OBP: 0.404, SLG: 0.494	2-1 F2			2-3 K		1-1 4-3		2-1 G6-3 1-2f		4 0 0 0 0 1 1			
Willie Mays, R (1, 8) OBP: 0.396, SLG: 0.697		2-1 5-3		0-0 HR		2-1 F8		1-0 F4		4 1 1 1 0 0 0			
Don Mueller, L (1, 9) OBP: 0.364, SLG: 0.428		2-3 K		3-2 1B 1B		1-2 G3		1-1 E 2B		4 1 2 0 0 1 0			
Monte Irvin, R (1, 7) OBP: 0.355, SLG: 0.434		1-0 L7		2-0 1-2 1B		1-0 HR		1-2 F2		4 1 2 1 0 0 1			
Davey Williams, R (1, 4) OBP: 0.295, SLG: 0.360			1-3 K	1-1 F8		3-2 F8		0-0 E8 1B		4 0 1 1 0 1 2			
Wes Westrum, R (1, 2) OBP: 0.280, SLG: 0.289			3-2 F6	3-2 5-3		2-2 CS SH3-4 1B		1-0 6-3		4 0 1 0 0 0 3			
Sal Maglie, R (1, 1) OBP: 0.158, SLG: 0.086			3-3 K		4-2 G4-6-3 BB		1-0 SH3-4		0-3 K	2 0 0 0 1 2 1 0 0 0 0 0 0 0			
Mary Grissom, R (9, 1) OBP: 0.095, SLG: 0.095													
<b>Inning Stats</b>	R: 0 H: 0 E: 0 LOB: 0 K: 0 BB: 1 S: 6 P: 12	R: 0 H: 0 E: 0 LOB: 0 K: 1 BB: 0 S: 6 P: 11	R: 0 H: 0 E: 0 LOB: 0 K: 2 BB: 0 S: 11 P: 18	R: 3 H: 5 E: 0 LOB: 2 K: 1 BB: 0 S: 19 P: 31	R: 0 H: 0 E: 0 LOB: 0 K: 0 BB: 1 S: 5 P: 10	R: 0 H: 0 E: 0 LOB: 0 K: 0 BB: 0 S: 7 P: 11	R: 1 H: 2 E: 0 LOB: 1 K: 0 BB: 1 S: 11 P: 22	R: 0 H: 1 E: 0 LOB: 0 K: 0 BB: 0 S: 6 P: 9	R: 1 H: 2 E: 1 LOB: 1 K: 1 BB: 0 S: 10 P: 13	1B: 6 SF: 0 2B: 1 SAC: 1 3B: 0 DP: 3 HR: 3 HBP: 0	WP: 0 PA: 36 PB: 0 SB: 0 CS: 1		
<b>PITCHER</b>	IP WLS BF H R ER SO BB IBB HBP BLK WP HR S P ERA WHIP											<b>PITCHER</b>	IP WLS BF H R ER SO BB IBB HBP BLK WP HR S P ERA WHIP
Preacher Roe, L (1, 1) ERA: 4.61	3.1 L 15 5 3 3 4 1 0 0 0 0 2 37 63 8.10 1.800												
Bob Milliken, R (4, 1) ERA: 3.89	3.2 13 2 1 1 0 2 0 0 0 0 1 28 52 2.46 1.091												
Erv Palica, R (8, 1) ERA: 4.0	2.0 8 3 1 1 1 0 0 0 0 0 0 16 22 4.50 1.500												

**New York Giants @ Brooklyn Dodgers**  
**Ebbets Field, Brooklyn, NY**  
 Tue Jul 06 1954, 3:33 AM EDT  
 Att. 33,616 - Unknown

livebaseballscorecards.com

**AB 32**  
**R 5**  
**H 10**  
**RBI 5**  
**BB 3**  
**SO 5**  
**LOB 10**



BOTTOM

New York Giants @ Brooklyn Dodgers  
Ebbets Field, Brooklyn, NY  
Tue Jul 06 1954, 3:33 AM EDT  
Att. 33,616 - Unknown

livebaseballscorecards.com

AB 35  
R 2  
H 9  
RBI 2  
BB 2  
SO 5  
LOB 19



WP: 0 PA: 37  
PB: 0  
SB: 0  
CS: 0

AB R H RBI BB SO LOB

5 1 2 0 0 0 4

2 1 0 0 2 1 1

4 0 1 2 0 0 3

4 0 0 0 0 0 2

4 0 1 0 0 2 1

4 0 2 0 0 0 0

4 0 1 0 0 0 1

3 0 1 0 0 1 0

1 0 0 0 0 0 3

1 0 0 0 0 0 1

1 0 1 0 0 0 0

1 0 0 0 0 0 0

0 0 0 0 0 0 0

1 0 0 0 0 1 3

1B: 8 SF: 0

2B: 2 SAC: 0

3B: 0 DP: 1

HR: 0 HBP: 0

1B: 8 SF: 0

2B: 2 SAC: 0

3B: 0 DP: 1

HR: 0 HBP: 0

1B: 8 SF: 0

2B: 2 SAC: 0

3B: 0 DP: 1

HR: 0 HBP: 0

1B: 8 SF: 0

2B: 2 SAC: 0

3B: 0 DP: 1

HR: 0 HBP: 0

1B: 8 SF: 0

2B: 2 SAC: 0

3B: 0 DP: 1

HR: 0 HBP: 0

1B: 8 SF: 0

2B: 2 SAC: 0

3B: 0 DP: 1

HR: 0 HBP: 0

1B: 8 SF: 0

2B: 2 SAC: 0

3B: 0 DP: 1

HR: 0 HBP: 0

1B: 8 SF: 0

2B: 2 SAC: 0

3B: 0 DP: 1

HR: 0 HBP: 0

1B: 8 SF: 0

2B: 2 SAC: 0

3B: 0 DP: 1

HR: 0 HBP: 0

1B: 8 SF: 0

2B: 2 SAC: 0

3B: 0 DP: 1

HR: 0 HBP: 0

1B: 8 SF: 0

2B: 2 SAC: 0

3B: 0 DP: 1

HR: 0 HBP: 0

1B: 8 SF: 0

2B: 2 SAC: 0

3B: 0 DP: 1

HR: 0 HBP: 0

1B: 8 SF: 0

2B: 2 SAC: 0

3B: 0 DP: 1

HR: 0 HBP: 0

1B: 8 SF: 0

2B: 2 SAC: 0

3B: 0 DP: 1

HR: 0 HBP: 0

1B: 8 SF: 0

2B: 2 SAC: 0

3B: 0 DP: 1

HR: 0 HBP: 0

1B: 8 SF: 0

2B: 2 SAC: 0

3B: 0 DP: 1

HR: 0 HBP: 0

1B: 8 SF: 0

2B: 2 SAC: 0

3B: 0 DP: 1

HR: 0 HBP: 0

1B: 8 SF: 0

2B: 2 SAC: 0

3B: 0 DP: 1

HR: 0 HBP: 0

1B: 8 SF: 0

2B: 2 SAC: 0

3B: 0 DP: 1

HR: 0 HBP: 0

1B: 8 SF: 0

2B: 2 SAC: 0

3B: 0 DP: 1

HR: 0 HBP: 0

1B: 8 SF: 0

2B: 2 SAC: 0

3B: 0 DP: 1

HR: 0 HBP: 0

1B: 8 SF: 0

2B: 2 SAC: 0

3B: 0 DP: 1

HR: 0 HBP: 0

1B: 8 SF: 0

2B: 2 SAC: 0

3B: 0 DP: 1

HR: 0 HBP: 0

1B: 8 SF: 0

2B: 2 SAC: 0

3B: 0 DP: 1

HR: 0 HBP: 0

1B: 8 SF: 0

2B: 2 SAC: 0

3B: 0 DP: 1

HR: 0 HBP: 0

1B: 8 SF: 0

2B: 2 SAC: 0

3B: 0 DP: 1

HR: 0 HBP: 0

1B: 8 SF: 0

2B: 2 SAC: 0

3B: 0 DP: 1

HR: 0 HBP: 0

1B: 8 SF: 0

2B: 2 SAC: 0

3B: 0 DP: 1

HR: 0 HBP: 0

1B: 8 SF: 0

2B: 2 SAC: 0

3B: 0 DP: 1

HR: 0 HBP: 0

1B: 8 SF: 0

2B: 2 SAC: 0

3B: 0 DP: 1

HR: 0 HBP: 0

1B: 8 SF: 0

2B: 2 SAC: 0

3B: 0 DP: 1

HR: 0 HBP: 0

1B: 8 SF: 0

2B: 2 SAC: 0

3B: 0 DP: 1

HR: 0 HBP: 0

1B: 8 SF: 0

2B: 2 SAC: 0

3B: 0 DP: 1

HR: 0 HBP: 0

1B: 8 SF: 0

2B: 2 SAC: 0

3B: 0 DP: 1

HR: 0 HBP: 0

1B: 8 SF: 0

2B: 2 SAC: 0

3B: 0 DP: 1

HR: 0 HBP: 0

1B: 8 SF: 0

2B: 2 SAC: 0

3B: 0 DP: 1

HR: 0 HBP: 0

1B: 8 SF: 0

2B: 2 SAC: 0

3B: 0 DP: 1

HR: 0 HBP: 0

1B: 8 SF: 0

2B: 2 SAC: 0

3B: 0 DP: 1

HR: 0 HBP: 0

1B: 8 SF: 0

2B: 2 SAC: 0

3B: 0 DP: 1

HR: 0 HBP: 0

1B: 8 SF: 0

2B: 2 SAC: 0

3B: 0 DP: 1

HR: 0 HBP: 0

1B: 8 SF: 0

2B: 2 SAC: 0

3B: 0 DP: 1

HR: 0 HBP: 0

1B: 8 SF: 0

2B: 2 SAC: 0

3B: 0 DP: 1

HR: 0 HBP: 0

1B: 8 SF: 0

2B: 2 SAC: 0

3B: 0 DP: 1

HR: 0 HBP: 0

1B: 8 SF: 0

2B: 2 SAC: 0

3B: 0 DP: 1

HR: 0 HBP: 0

1B: 8 SF: 0

2B: 2 SAC: 0

3B: 0 DP: 1

HR: 0 HBP: 0

1B: 8 SF: 0

2B: 2 SAC: 0

3B: 0 DP: 1

HR: 0 HBP: 0

1B: 8 SF: 0

2B: 2 SAC: 0

3B: 0 DP: 1

HR: 0 HBP: 0

1B: 8 SF: 0

2B: 2 SAC: 0

3B: 0 DP: 1

HR: 0 HBP: 0

1B: 8 SF: 0

2B: 2 SAC: 0

3B: 0 DP: 1

HR: 0 HBP: 0

1B: 8 SF: 0

2B: 2 SAC: 0

3B: 0 DP: 1

HR: 0 HBP: 0

1B: 8 SF: 0

2B: 2 SAC: 0

3B: 0 DP: 1

HR: 0 HBP: 0

1B: 8 SF: 0

2B: 2 SAC: 0

3B: 0 DP: 1

HR: 0 HBP: 0

1B: 8 SF: 0

2B: 2 SAC: 0

3B: 0 DP: 1

HR: 0 HBP: 0

1B: 8 SF: 0

2B: 2 SAC: 0

3B: 0 DP: 1

HR: 0 HBP: 0

1B: 8 SF: 0

2B: 2 SAC: 0

3B: 0 DP: 1

HR: 0 HBP: 0

1B: 8 SF: 0

2B: 2 SAC: 0

3B: 0 DP: 1

HR: 0 HBP: 0

1B: 8 SF: 0

2B: 2 SAC: 0

3B: 0 DP: 1

HR: 0 HBP: 0

1B: 8 SF: 0

2B: 2 SAC: 0

3B: 0 DP: 1

HR: 0 HBP: 0

1B: 8 SF: 0

2B: 2 SAC: 0

3B: 0 DP: 1

HR: 0 HBP: 0

1B: 8 SF: 0

2B: 2 SAC: 0

3B: 0 DP: 1

HR: 0 HBP: 0

1B: 8 SF: 0

2B: 2 SAC: 0

3B: 0 DP: 1

HR: 0 HBP: 0

1B: 8 SF: 0

2B: 2 SAC: 0

3B: 0 DP: 1

HR: 0 HBP: 0

1B: 8 SF: 0

2B: 2 SAC: 0

3B: 0 DP: 1

HR: 0 HBP: 0

Batter	1	2	3	4	5	6	7	8	9	AB R H RBI BB SO LOB	TOP											
Whitey Lockman, L (1, 3) OBP: 0.306, SLG: 0.385	1-1 E7 FC5 2B	2-0 F8		0-0 4-3		0-1 4-3		0-2 F8	1-1 L9	6 1 1 0 0 0 2												
Alvin Dark, R (1, 6) OBP: 0.329, SLG: 0.429	2-2 FC5 1B 2B	0-1 F3		0-1 4-3		0-0 1-3		3-1 HR		5 2 1 2 0 0 2												
Don Mueller, L (1, 9) OBP: 0.365, SLG: 0.428	1-0 2B SF9 1B		0-2 F4		0-1 F7	0-1 1B		1-0 G3		5 1 2 0 0 0 0												
Hank Thompson, L (1, 5) OBP: 0.410, SLG: 0.506	1-1 1B 2B		1-0 2B		4-2 HR BB	2-2 F8		0-1 E 1B 1B		4 2 3 1 1 0 1												
Willie Mays, R (1, 8) OBP: 0.399, SLG: 0.706	0-0 SF9		1-0 6-3		1-0 HR		4-2 E BB	2-1 E7 1B		3 2 2 3 1 0 1												
Monte Irvin, R (1, 7) OBP: 0.359, SLG: 0.447	2-2 E S 1B		0-0 F7		2-1 HR		2-0 6-3	4-2 BB		4 1 2 2 1 0 2												
Davey Williams, R (1, 4) OBP: 0.293, SLG: 0.354	0-2 F4			4-0 SH3 BB BB	0-0 F4		0-0 E1	3-2 F8		4 0 0 0 1 0 4												
Wes Westrum, R (1, 2) OBP: 0.284, SLG: 0.312	3-3 K 1-3			4-2 SH3 BB	3-1 HR		1-0 F6		0-0 F8	4 1 1 1 1 1 2												
Jim Hearn, R (1, 1) OBP: 0.185, SLG: 0.280		1-3 K		2-2 SH3 1-2 2-3	1-2 F4		2-0 F7		2-1 F8	4 0 0 0 0 1 1												
<b>Inning Stats</b>	R: 4 E: 1 K: 1 S: 19	H: 4 LOB: 1 BB: 0 P: 29	R: 0 E: 0 K: 1 S: 6	H: 0 LOB: 0 BB: 0 P: 9	R: 0 E: 0 K: 0 S: 6	H: 1 LOB: 1 BB: 0 P: 8	R: 0 E: 0 K: 0 S: 9	H: 0 LOB: 2 BB: 2 P: 19	R: 4 E: 0 K: 0 S: 13	H: 3 LOB: 0 BB: 1 P: 24	R: 0 E: 0 K: 0 S: 8	H: 1 LOB: 1 BB: 0 P: 10	R: 1 E: 1 K: 0 S: 6	H: 0 LOB: 1 BB: 1 P: 15	R: 1 E: 1 K: 0 S: 16	H: 3 LOB: 3 BB: 1 P: 29	R: 0 E: 0 K: 0 S: 5	H: 0 LOB: 0 BB: 0 P: 8	1B: 5 2B: 3 3B: 0 HR: 4	SF: 1 SAC: 1 DP: 0 HBP: 0	WP: 0 PB: 0 SB: 1 CS: 0	PA: 46
<b>PITCHER</b>	IP WLS BF H R ER SO BB IBB HBP BLK WP HR S P ERA WHIP												<b>PITCHER</b>	IP WLS BF H R ER SO BB IBB HBP BLK WP HR S P ERA WHIP								
Don Newcombe, R (1, 1) ERA: 4.78	4.1 L 24 7 7 6 2 3 0 0 0 0 0 2 47 79 12.46 2.308																					
Clem Labine, R (5, 1) ERA: 3.88	2.2 12 2 2 1 0 1 0 0 0 0 1 20 35 3.38 1.125																					
Ben Wade, R (8, 1) ERA: 8.37	2.0 10 3 1 1 0 1 0 0 0 0 1 21 37 4.50 2.000																					

**New York Giants @ Brooklyn Dodgers**  
**Ebbets Field, Brooklyn, NY**  
 Wed Jul 07 1954, 3:33 AM EDT  
 Att: 22,712 - Unknown

livebaseballscorecards.com

**AB 39**  
**R 10**  
**H 12**  
**RBI 9**  
**BB 5**  
**SO 2**  
**LOB 15**



Batter	1	2	3	4	5	6	7	8	9	AB R H RBI BB SO LOB
Jim Gilliam, S OBP: 0.331, SLG: 0.437 (1, 4)	3-3 K		1-0 L8		2-1 2B		3-1 4-3		2-0 FC6 1B	5 0 2 0 0 1 1
Walt Moryn, L OBP: 0.412, SLG: 0.594 (1, 7)	0-1 4-3		3-2 G3		0-1 F8		2-0 F8		0-0 FC6	5 0 0 0 0 0 5
Duke Snider, L OBP: 0.454, SLG: 0.722 (1, 8)	4-2 HR BB		2-1 F2		4-2 FC6-4 BB		1-3 K			2 1 0 0 2 1 1
Gil Hodges, R OBP: 0.381, SLG: 0.597 (1, 3)	1-1 HR			1-1 1B HBP		2-0 FC6-4		3-2 6-3		3 1 1 2 0 0 2
Roy Campanella, R OBP: 0.259, SLG: 0.442 (1, 2)	1-2 6-3			1-2 F8		0-2 FC4-6 1B		3-1 F7		4 0 1 0 0 0 1
Carl Furillo, R OBP: 0.352, SLG: 0.399 (1, 9)		1-3 K		0-0 1B		0-2 F2		1-3 K		4 0 1 0 0 2 1
Don Hoak, R OBP: 0.331, SLG: 0.444 (1, 5)		3-3 K		2-1 FC6-4 1B		1-2 FC4-6		4-1 1B BB		3 0 1 0 1 1 1
Don Zimmer, R OBP: 0.269, SLG: 0.292 (1, 6)		0-0 L5		1-1 FC6-4		0-3 K		0-2 1B 1B		4 0 1 0 0 1 3
Don Newcombe, L OBP: 0.414, SLG: 0.360 (1, 1)			0-0 G3		1-2 F3		2-2 3-1		1-1 F6	1 0 1 0 0 0 0
Clem Labine, R (5, 1)										1 0 0 0 0 0 0
Chuck Kress, L (7, PH)										1 0 0 0 0 0 0
Ben Wade, R (8, 1)										0 0 0 0 0 0 0
George Shuba, L (9, PH)										1 0 0 0 0 0 2

Inning Stats	R: 2	H: 1	E: 0	K: 1	S: 17	LOB: 0	BB: 1	P: 26	R: 0	H: 0	E: 0	K: 2	S: 9	LOB: 0	BB: 0	P: 13	R: 0	H: 1	E: 0	K: 0	S: 8	LOB: 1	BB: 0	P: 14	R: 0	H: 2	E: 0	K: 0	S: 9	LOB: 2	BB: 0	P: 14	R: 0	H: 1	E: 0	K: 0	S: 11	LOB: 2	BB: 1	P: 20	R: 0	H: 1	E: 0	K: 1	S: 12	LOB: 1	BB: 0	P: 13	R: 0	H: 0	E: 0	K: 0	S: 6	LOB: 0	BB: 0	P: 13	R: 0	H: 0	E: 0	K: 1	S: 8	LOB: 0	BB: 0	P: 15	R: 0	H: 2	E: 0	K: 1	S: 11	LOB: 3	BB: 1	P: 19	1B: 6	SF: 0	2B: 1	SAC: 0	3B: 0	DP: 0	HR: 1	HBP: 1
--------------	------	------	------	------	-------	--------	-------	-------	------	------	------	------	------	--------	-------	-------	------	------	------	------	------	--------	-------	-------	------	------	------	------	------	--------	-------	-------	------	------	------	------	-------	--------	-------	-------	------	------	------	------	-------	--------	-------	-------	------	------	------	------	------	--------	-------	-------	------	------	------	------	------	--------	-------	-------	------	------	------	------	-------	--------	-------	-------	-------	-------	-------	--------	-------	-------	-------	--------

PITCHER	IP	WLS	BF	H	R	ER	SO	BB	IBB	HBP	BLK	WP	HR	S	P	ERA	WHIP
Jim Hearn, R ERA: 4.38 (1, 1)	9.0	W	38	8	2	2	6	3	0	1	0	0	1	91	147	2.00	1.222

**BOTTOM**

**New York Giants @ Brooklyn Dodgers**  
**Ebbets Field, Brooklyn, NY**  
 Wed Jul 07 1954, 3:33 AM EDT  
 Att. 22,712 - Unknown

<b>AB</b>	<b>34</b>
<b>R</b>	<b>2</b>
<b>H</b>	<b>8</b>
<b>RBI</b>	<b>2</b>
<b>BB</b>	<b>3</b>
<b>SO</b>	<b>6</b>
<b>LOB</b>	<b>17</b>

**B**

<b>WP: 0</b>	<b>PA: 38</b>
<b>PB: 0</b>	
<b>SB: 0</b>	
<b>CS: 0</b>	

livebaseballscorecards.com

Batter	1	2	3	4	5	6	7	8	9	AB R H RBI BB SO LOB	TOP											
Whitey Lockman, L (1, 3) OBP: 0.310, SLG: 0.403	1-1 4-3 1B 2B		0-1 4-3 2B 2B		1-1 HR	1-1 4-3	0-1 F8		0-2 1-3	6 3 3 1 0 0 4												
Alvin Dark, R (1, 6) OBP: 0.329, SLG: 0.429	0-0 4-3 2-3		0-1 4-3 2-3		1-3 K		1-2 1B HR 2B	1-0 G4-6-3 HBP	0-1 L9	5 1 1 0 0 1 4												
Don Mueller, L (1, 9) OBP: 0.372, SLG: 0.437	1-0 HR 1B		1-1 3-H 2B		1-0 1B 1B		0-0 HR 1B	2-0 G4-6-3 1-2f		5 2 4 2 0 0 1												
Hank Thompson, L (1, 5) OBP: 0.410, SLG: 0.502	1-3 K		0-3 K		0-0 BB 1B		1-0 F6	4-2 BB		4 0 1 0 1 2 4												
Willie Mays, R (1, 8) OBP: 0.402, SLG: 0.724	0-0 1-H HR		3-1 F9		4-0 1-2 BB		0-0 HR	1-0 1-3		4 2 2 5 1 0 2												
Monte Irvin, R (1, 7) OBP: 0.363, SLG: 0.457	3-2 F7			2-1 HR	2-0 F4		2-0 1B 1B HBP	4-2 1B BB		3 3 1 1 1 0 3												
Davey Williams, R (1, 4) OBP: 0.295, SLG: 0.355		2-0 F5		1-3 K	1-0 FC6-4		2-1 FC1-5 1B 1B	1-0 SH3-4 1B 1B		5 0 2 0 0 1 3												
Wes Westrum, R (1, 2) OBP: 0.288, SLG: 0.315		1-2 F5		0-1 L9		0-3 K	2-2 FC1-5 1B	2-0 SH3-4 1B		5 0 2 2 0 1 0												
Ruben Gomez, R (1, 1) OBP: 0.190, SLG: 0.190		0-0 F8		0-0 F8		1-3 K2-3	0-0 FC1-5	1-1 SH3-4		4 0 0 0 0 1 2												
<b>Inning Stats</b>	R: 3 E: 0 K: 1 S: 11	H: 3 LOB: 0 BB: 0 P: 17	R: 0 E: 0 K: 0 S: 5	H: 0 LOB: 0 BB: 0 P: 8	R: 1 E: 0 K: 1 S: 11	H: 2 LOB: 1 BB: 0 P: 15	R: 1 E: 0 K: 1 S: 8	H: 1 LOB: 0 BB: 0 P: 11	R: 1 E: 0 K: 1 S: 12	H: 3 LOB: 3 BB: 1 P: 22	R: 0 E: 0 K: 2 S: 9	H: 0 LOB: 0 BB: 0 P: 11	R: 4 E: 0 K: 0 S: 14	H: 5 LOB: 2 BB: 0 P: 22	R: 0 E: 0 K: 0 S: 7	H: 0 LOB: 1 BB: 1 P: 15	R: 1 E: 0 K: 0 S: 13	H: 2 LOB: 2 BB: 1 P: 21	1B: 8 2B: 4 3B: 0 HR: 4	SF: 0 SAC: 1 DP: 1 HBP: 2	WP: 0 PB: 0 SB: 0 CS: 0	PA: 47
<b>PITCHER</b>	IP WLS BF H R ER SO BB IBB HBP BLK WP HR S P ERA WHIP																					
Carl Erskine, R (1, 1) ERA: 3.54	4.1 L 21 8 6 6 4 0 0 0 0 0 0 3 44 63 12.46 1.846																					
Russ Meyer, R (5, 1) ERA: 3.68	2.0 13 5 4 4 2 1 0 1 0 0 0 1 20 35 18.00 3.000																					
Jim Hughes, R (7, 1) ERA: 2.88	0.2 3 1 0 0 0 0 0 0 0 0 0 0 6 8 0.00 1.500																					
Pete Wojey, R (8, 1) ERA: 5.68	2.0 10 2 1 1 0 2 0 1 0 0 0 0 20 36 4.50 2.000																					

**New York Giants @ Brooklyn Dodgers**  
 Ebbets Field, Brooklyn, NY  
 Thu Jul 08 1954, 3:33 AM EDT  
 Att. 30,256 - Unknown

[livebaseballscorecards.com](http://livebaseballscorecards.com)

**AB 41**  
**R 11**  
**H 16**  
**RBI 11**  
**BB 3**  
**SO 6**  
**LOB 23**





Batter	1	2	3	4	5	6	7	8	9	AB R H RBI BB SO LOB
Jim Gilliam, S OBP: 0.331, SLG: 0.436 (1, 4)	0-0 FC5-4 BB E 1B	0-0 F7		1-2 L8			1-1 1B 1B		1-3 K	5 1 2 0 0 1 2
Pee Wee Reese, R OBP: 0.371, SLG: 0.444 (1, 6)	4-0 FC5-4 BB 1-2	4-1 BB			0-2 F7		3-2 1-3 1B		0-2 1-2 1B	3 0 2 0 2 0 0
Duke Snider, L OBP: 0.451, SLG: 0.713 (1, 8)	1-0 FC5-4 BB E 1-2f 2-3	0-0 4-3			1-1 1B		0-3 K		0-3 K	5 1 1 0 0 2 8
Gil Hodges, R OBP: 0.378, SLG: 0.589 (1, 3)	4-2 E 1-2 BB		2-3 K		1-0 F8		1-3 K		1-3 K	4 0 0 0 1 3 5
Carl Furillo, R OBP: 0.348, SLG: 0.393 (1, 9)	1-3 K		0-1 6-3		3-2 4-3			1-2 5-3		4 0 0 0 0 1 4
Roy Campanella, R OBP: 0.259, SLG: 0.435 (1, 2)	0-1 E3 1-3 2-H 3-H		4-0 FC6-4 BB		1-3 K			2-1 5-3		3 0 0 0 1 1 1
Jackie Robinson, R OBP: 0.417, SLG: 0.551 (1, 7)	2-2 4-3		0-1 FC6-4 1-2f		1-0 4-3			3-1 1B		4 0 1 0 0 0 3
Don Hoak, R OBP: 0.329, SLG: 0.435 (1, 5)		4-2 SH1-4 BB		2-1 F3		0-0 5-3		0-2 4-3		3 0 0 0 1 0 1
Carl Erskine, R OBP: 0.180, SLG: 0.109 (1, 1)		1-2 SH1-4		0-1 6-3			1-2 4-3		1-1 1B 1B	1 0 1 0 0 0 0 0 0 0 0 0 0 0 0 0 1 0 1 0 0 0 0

Inning Stats	R: 2	H: 1	E: 1	LOB: 2	K: 12	S: 12	R: 0	H: 0	E: 0	LOB: 2	K: 0	S: 8	R: 0	H: 0	E: 0	LOB: 1	K: 1	S: 8	R: 0	H: 0	E: 0	LOB: 0	K: 0	S: 7	R: 0	H: 1	E: 0	LOB: 1	K: 0	S: 9	R: 0	H: 0	E: 0	LOB: 0	K: 1	S: 6	R: 0	H: 2	E: 0	LOB: 2	K: 2	S: 14	R: 0	H: 1	E: 0	LOB: 1	K: 0	S: 10	R: 0	H: 2	E: 0	LOB: 2	K: 3	S: 17	1B: 7	2B: 0	3B: 0	HR: 0	SF: 0	SAC: 1	DP: 0	HBP: 0	WP: 0	PA: 40
PITCHER Ruben Gomez, R ERA: 2.95 (1, 1)	IP	WLS	BF	H	R	ER	SO	BB	IBB	HBP	BLK	WP	HR	S	P	ERA	WHIP	IP	WLS	BF	H	R	ER	SO	BB	IBB	HBP	BLK	WP	HR	S	P	ERA	WHIP																														

**BOTTOM**

**New York Giants @ Brooklyn Dodgers**  
Ebbets Field, Brooklyn, NY

Thu Jul 08 1954, 3:33 AM EDT  
Att. 30,256 - Unknown

livebaseballscorecards.com

AB	34
R	2
H	7
RBI	0
BB	5
SO	8
LOB	24

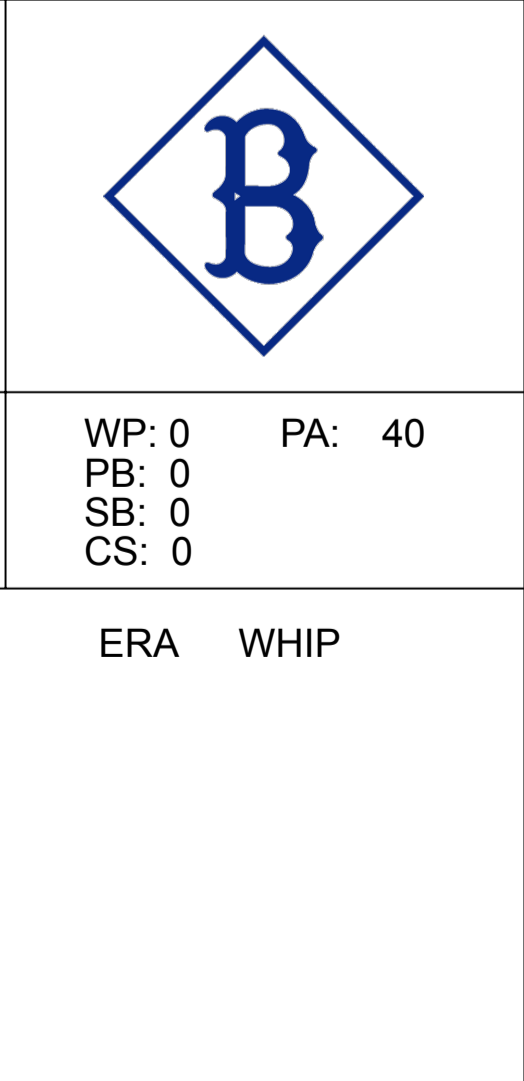

Batter	1	2	3	4	5	6	7	8	9	AB R H RBI BB SO LOB	TOP	
Gair Allie, R (1, 6) OBP: 0.302, SLG: 0.287	0-0 F7	0-0 FC6-4		4-0 FC6-4 BB		0-0 F8			0-0 6-3	4 0 0 0 1 0 3		
Vic Janowicz, R (1, 5) OBP: 0.182, SLG: 0.100	0-3 K		0-0 L6	0-0 FC6-4			0-3 K		0-0 4-3 1B	5 0 1 0 0 2 3		
Preston Ward, L (1, 3) OBP: 0.351, SLG: 0.383	0-0 1B		0-0 F9		0-0 5-3		0-0 G3		0-0 4-3	5 0 1 0 0 0 1		
Frank Thomas, R (1, 8) OBP: 0.363, SLG: 0.465	0-3 K		4-0 FC6-4 BB		0-0 3-1		0-0 F2		0-0 F7	4 0 0 0 1 1 2		
Sid Gordon, R (1, 7) OBP: 0.401, SLG: 0.361		0-0 1B BB 1B	0-0 FC6-4		0-0 1-3			0-0 WP 1B SF8 1B		4 1 2 0 0 0 1		
Jack Shepard, R (1, 2) OBP: 0.356, SLG: 0.343		0-0 P4		0-0 SH5-4 BB 1B		4-0 HR BB		0-0 F8		3 1 1 0 1 0 2		
Dick Cole, R (1, 4) OBP: 0.349, SLG: 0.371		4-0 1B BB		0-0 L8		0-3 K		0-0 WP 1B		3 0 1 0 1 1 2		
Dick Hall, R (1, 9) OBP: 0.328, SLG: 0.344		0-3 K		4-0 SH5-4 BB		0-0 HR		0-0 SF8		2 1 1 3 1 1 2		
Paul LaPalme, L (1, 1) OBP: 0.231, SLG: 0.385		0-0 1B		0-0 SH5-4		0-3 K		0-0 5-3		2 0 1 0 0 1 0		
Johnny Hetki, R (6, 1) OBP: 0.333, SLG: 0.333										0 0 0 0 0 0 0		
Eddie Pellagrini, R (8, PH) OBP: 0.273, SLG: 0.250										1 0 0 0 0 0 1		
Bob Purkey, R (8, 1) OBP: 0.200, SLG: 0.222		1-2 2-3 1B								0 0 0 0 0 0 0		
<b>Inning Stats</b>	R: 0 H: 1 E: 0 LOB: 1 K: 2 BB: 0 S: 8 P: 8	R: 0 H: 2 E: 0 LOB: 3 K: 1 BB: 1 S: 7 P: 11	R: 0 H: 0 E: 0 LOB: 1 K: 0 BB: 1 S: 3 P: 7	R: 0 H: 1 E: 0 LOB: 3 K: 0 BB: 2 S: 4 P: 12	R: 0 H: 0 E: 0 LOB: 0 K: 0 BB: 0 S: 3 P: 3	R: 2 H: 1 E: 0 LOB: 0 K: 2 BB: 1 S: 8 P: 12	R: 0 H: 0 E: 0 LOB: 0 K: 1 BB: 0 S: 5 P: 5	R: 1 H: 2 E: 0 LOB: 1 K: 0 BB: 0 S: 5 P: 5	R: 0 H: 1 E: 0 LOB: 1 K: 0 BB: 0 S: 4 P: 4	1B: 7 SF: 1 2B: 0 SAC: 1 3B: 0 DP: 0 HR: 1 HBP: 0	WP: 1 PA: 40 PB: 0 SB: 0 CS: 0	
<b>PITCHER</b> Johnny Antonelli, L (1, 1) ERA: 2.12	IP WLS BF H R ER SO BB IBB HBP BLK WP HR S P ERA WHIP											
	9.0 W 40 8 3 3 6 5 0 0 0 1 1 47 67 3.00 1.444											

Pittsburgh Pirates @ New York Giants  
Polo Grounds, New York, NY  
Fri Jul 09 1954, 3:33 AM EDT  
Att. 12,423 - Unknown

livebaseballscorecards.com

AB 33  
R 3  
H 8  
RBI 3  
BB 5  
SO 6  
LOB 17



Batter	1	2	3	4	5	6	7	8	9
Whitey Lockman, L (1, 3) OBP: 0.309, SLG: 0.399	0-0 1-3		4-0 BB		0-0 5-3	0-0 P6			
Alvin Dark, R (1, 6) OBP: 0.331, SLG: 0.438	0-0 1B		0-0 F3		0-0 HR	0-0 5-3			
Don Mueller, L (1, 9) OBP: 0.367, SLG: 0.431	0-0 F3		0-0 F2		0-0 L3		0-0 G3		
Willie Mays, R (1, 8) OBP: 0.401, SLG: 0.718	0-0 F8		0-0 6-3			0-0 HR 1B	0-0 F9		
Monte Irvin, R (1, 7) OBP: 0.368, SLG: 0.471		4-0 FC5-4 BB		0-0 1B		0-0 HR 1-H	0-0 F2		
Hank Thompson, L (1, 5) OBP: 0.408, SLG: 0.496		0-0 F9		0-0 F9		4-0 FC3-6 BB	0-0 4-3		
Davey Williams, R (1, 4) OBP: 0.294, SLG: 0.351		0-0 FC5-4 WP 1B 1-2f		0-0 F9		0-0 FC3-6 HR 1-2f	1-0 HBP		
Wes Westrum, R (1, 2) OBP: 0.293, SLG: 0.338		4-0 1B BB 1-2		0-0 P5		0-0 HR 1-H	0-0 F2		
Johnny Antonelli, L (1, 1) OBP: 0.220, SLG: 0.298		0-0 1B 1-2 2-H			0-0 F8	0-0 HR	0-0 L4		

Inning Stats	R: 0 E: 0 K: 0 S: 4	H: 1 LOB: 1 BB: 0 P: 4	R: 0 E: 0 K: 0 S: 3	H: 1 LOB: 3 BB: 2 P: 11	R: 0 E: 0 K: 0 S: 3	H: 0 LOB: 1 BB: 1 P: 7	R: 0 E: 0 K: 0 S: 4	H: 1 LOB: 1 BB: 0 P: 4	R: 1 E: 0 K: 0 S: 4	H: 1 LOB: 0 BB: 0 P: 4	R: 5 E: 0 K: 0 S: 7	H: 4 LOB: 0 BB: 1 P: 11	R: 0 E: 0 K: 0 S: 3	H: 0 LOB: 0 BB: 0 P: 3	R: 0 E: 0 K: 0 S: 3	H: 0 LOB: 1 BB: 0 P: 4
1B: 4 2B: 0 3B: 0 HR: 4	SF: 0 SAC: 0 DP: 0 HBP: 1	WP: 1 PB: 0 SB: 0 CS: 0	PA: 36													

PITCHER	IP	WLS	BF	H	R	ER	SO	BB	IBB	HBP	BLK	WP	HR	S	P	ERA	WHIP
Paul LaPalme, L (1, 1) ERA: 5.91	5.1	L	27	8	6	6	0	4	0	0	0	1	4	23	39	10.12	2.250
Johnny Hetki, R (6, 1) ERA: 5.68	1.2		5	0	0	0	0	0	0	0	0	0	0	5	5	0.00	0.000
Bob Purkey, R (8, 1) ERA: 5.17	1.0		4	0	0	0	0	0	0	1	0	0	0	3	4	0.00	0.000

BOTTOM

Pittsburgh Pirates @ New York Giants  
Polo Grounds, New York, NY  
Fri Jul 09 1954, 3:33 AM EDT  
Att. 12,423 - Unknown

livebaseballscorecards.com

AB	31
R	6
H	8
RBI	6
BB	4
SO	0
LOB	13



Batter	1	2	3	4	5	6	7	8	9	AB R H RBI BB SO LOB	TOP																																						
Gair Allie, R OBP: 0.302, SLG: 0.282 (1, 6) X	0-0 F8	4-0 SH SF8 BB	0-3 K		4-0 FC4-6 BB	0-0 L5			0-3 K	4 1 0 0 2 2 1																																							
Vic Janowicz, R OBP: 0.185, SLG: 0.160 (1, 5) X	0-0 1B 2B	0-0 SH BB BB		0-0 F8	0-0 FC4-6 1B		0-0 F8		0-3 K	5 1 1 1 0 1 1																																							
Preston Ward, L OBP: 0.358, SLG: 0.382 (1, 3) B B B	4-0 1B BB	4-0 BB BB		0-0 E6	0-0 BB 1B		0-3 K		0-3 K	3 0 1 1 2 1 0																																							
Frank Thomas, R OBP: 0.360, SLG: 0.460 (1, 8) X	0-0 F8	0-0 SF8		0-3 K	4-0 BB		0-3 K			3 0 0 1 1 2 3																																							
Sid Gordon, R OBP: 0.401, SLG: 0.358 (1, 7) X	0-0 1B	4-0 BB		0-3 K	0-0 F8			0-0 5-3		4 0 1 1 1 1 4																																							
Jack Shepard, R OBP: 0.350, SLG: 0.336 (1, 2) X	0-0 5-3	0-0 G5-4-3			0-0 E8 1B	0-3 K		0-3 K		5 1 1 0 0 2 5																																							
Dick Cole, R OBP: 0.350, SLG: 0.372 (1, 4) X		0-0 2B 1B	0-0 L4		0-0 3B 1B	0-0 6-3		0-0 E5		5 2 2 1 0 0 0																																							
Dick Hall, R OBP: 0.330, SLG: 0.347 (1, 9) X		0-0 1B 2B	0-0 E6 SH3-4		0-3 K	4-0 HR BB		0-3 K		4 2 1 0 1 2 2																																							
Max Surkont, R OBP: 0.263, SLG: 0.176 (1, 1)		0-0 SH BB BB 1B	0-0 SH3-4		0-0 FC4-6 3B	0-0 HR			0-3 K	1 1 1 2 0 0 0																																							
Jake Thies, R (3, 1)										0 0 0 0 0 0 0																																							
Bob Skinner, L (5, PH)										1 1 1 1 0 0 0																																							
George O'Donnell, R (5, 1)										2 1 1 2 0 1 0																																							
<b>Inning Stats</b>	R: 1 E: 0 K: 0 S: 5	H: 2 LOB: 2 BB: 1 P: 9	R: 4 E: 1 K: 0 S: 6	H: 3 LOB: 2 BB: 3 P: 18	R: 0 E: 1 K: 1 S: 6	H: 0 LOB: 1 BB: 0 P: 6	R: 0 E: 1 K: 2 S: 8	H: 0 LOB: 1 BB: 0 P: 8	R: 3 E: 1 K: 1 S: 9	H: 4 LOB: 3 BB: 2 P: 17	R: 2 E: 0 K: 1 S: 6	H: 1 LOB: 0 BB: 1 P: 10	R: 0 E: 0 K: 2 S: 7	H: 0 LOB: 0 BB: 0 P: 7	R: 0 E: 1 K: 2 S: 8	H: 0 LOB: 1 BB: 0 P: 8	R: 0 E: 0 K: 3 S: 9	H: 0 LOB: 0 BB: 0 P: 9	1B: 6 2B: 2 3B: 1 HR: 1	SF: 1 SAC: 2 DP: 1 HBP: 0	WP: 0 PB: 0 SB: 0 CS: 0	PA: 47																											
<b>PITCHER</b>	IP WLS BF H R ER SO BB IBB HBP BLK WP HR S P ERA WHIP											<b>PITCHER</b>	IP WLS BF H R ER SO BB IBB HBP BLK WP HR S P ERA WHIP																																				
Don Liddle, L (1, 1) ERA: 3.15	1.0		9	5	4	4	0	1	0	0	0	0	0	8	12	36.00	6.000											Windy McCall, L (6, 1) ERA: 3.16	3.0		12	1	2	2	5	1	0	0	0	0	0	1	21	25	6.00	0.667			
Ramon Manzant, R (2, 1) ERA: 6.35	0.0		3	0	0	0	0	2	0	0	0	0	0	1	9	∞	∞											Paul Giel, R (9, 1) ERA:	1.0		3	0	0	0	3	0	0	0	0	0	9	9	0.00	0.000					
Alex Konikowski, R (2, 1) ERA: 2.7	2.0		7	0	1	0	1	1	0	0	0	0	0	8	12	0.00	0.500																																
Hoyt Wilhelm, R (4, 1) ERA: 2.47	1.2	L	12	4	3	3	3	2	0	0	0	0	0	16	24	16.20	3.600																																
Mary Grissom, R (5, 1) ERA: 1.96	0.1		1	0	0	0	0	0	0	0	0	0	0	1	1	0.00	0.000																																

Pittsburgh Pirates @ New York Giants  
Polo Grounds, New York, NY  
Sat Jul 10 1954, 3:33 AM EDT  
Att. 9,744 - Unknown

livebaseballscorecards.com

AB	37
R	10
H	10
RBI	10
BB	7
SO	12
LOB	16









Batter	1	2	3	4	5	6	7	8	9	AB R H RBI BB SO LOB	TOP											
Gair Allie, R (1, 6) OBP: 0.306, SLG: 0.284	0-0 1-3		0-0 FC5-4		4-0 BB			0-0 G3	0-0 F7	4 0 0 0 1 0 1												
Bob Skinner, L (1, 9) Dick Hall, R (8, PR) OBP: 0.335, SLG: 0.408 OBP: 0.326, SLG: 0.343	0-3 K			0-0 HR 1B	0-0 F8			0-0 E6 1B 1B	0-0 5-3	4 1 1 0 0 1 2 1 1 0 0 0 0 0												
Preston Ward, L (1, 3) OBP: 0.345, SLG: 0.363	0-0 F1			0-0 F7				0-0 F8	4-0 BB	4 0 0 0 1 0 2												
Frank Thomas, R (1, 8) OBP: 0.362, SLG: 0.476		0-0 4-3		0-0 HR 1B				0-0 1B 1B	0-0 5-3	4 2 2 2 1 0 1												
Jerry Lynch, L (1, 7) Sid Gordon, R (8, 7) OBP: 0.268, SLG: 0.348 OBP: 0.399, SLG: 0.356		0-0 4-3		0-0 F9				0-0 1B 1B		4 1 1 1 0 0 1 0 0 0 0 0 0 0												
Toby Atwell, L (1, 2) OBP: 0.407, SLG: 0.409		0-0 F5		0-0 4-3				0-0 HBP 1B 1B		4 0 1 1 0 0 1												
Dick Cole, R (1, 4) OBP: 0.358, SLG: 0.378			0-0 4-3		0-0 F8			0-0 B2-6-4 1B 1B		4 0 2 1 0 0 0												
Vic Janowicz, R (1, 5) Eddie Pellagrini, R (8, PR) OBP: 0.257, SLG: 0.258 OBP: 0.279, SLG: 0.250			4-0 FC1-6 BB		0-0 2B			0-3 K	1-0 HBP 1B	2 0 1 0 1 1 1 0 0 0 0 0 0 0												
Dick Littlefield, L (1, 1) OBP: 0.167, SLG: 0.188			0-0 FC1-6 FC5-4		0-0 F7			0-0 B2-6-4	0-3 K	4 0 0 0 0 1 6												
<b>Inning Stats</b>	R: 0 E: 0 K: 1 S: 5	H: 0 LOB: 0 BB: 0 P: 5	R: 0 E: 0 K: 0 S: 3	H: 0 LOB: 0 BB: 0 P: 3	R: 0 E: 0 K: 0 S: 3	H: 0 LOB: 1 BB: 1 P: 7	R: 2 E: 0 K: 0 S: 5	H: 2 LOB: 0 BB: 0 P: 5	R: 0 E: 0 K: 0 S: 4	H: 1 LOB: 2 BB: 1 P: 8	R: 0 E: 0 K: 0 S: 3	H: 0 LOB: 1 BB: 1 P: 7	R: 0 E: 0 K: 1 S: 5	H: 1 LOB: 0 BB: 0 P: 5	R: 3 E: 1 K: 1 S: 10	H: 4 LOB: 3 BB: 0 P: 11	R: 0 E: 0 K: 0 S: 3	H: 0 LOB: 1 BB: 1 P: 7	1B: 6 2B: 1 3B: 0 HR: 1	SF: 0 SAC: 0 DP: 1 HBP: 1	WP: 0 PB: 0 SB: 0 CS: 0	PA: 40
<b>PITCHER</b>	IP WLS BF H R ER SO BB IBB HBP BLK WP HR S P ERA WHIP																					
Jim Hearn, R (1, 1) ERA: 4.18	7.2 L 32 6 5 2 2 3 0 0 0 0 0 1 33 45 2.35 1.174																					
Mary Grissom, R (8, 1) ERA: 1.94	0.0 3 2 0 0 0 0 0 0 1 0 0 0 2 3 ∞ ∞																					
Don Liddle, L (8, 1) ERA: 3.13	0.1 1 0 0 0 0 1 0 0 0 0 0 0 3 3 0.00 0.000																					
Al Corwin, R (9, 1) ERA: 2.84	1.0 4 0 0 0 0 0 1 0 0 0 0 0 3 7 0.00 1.000																					

Pittsburgh Pirates @ New York Giants  
Polo Grounds, New York, NY  
Sun Jul 11 1954, 3:38 AM EDT  
Att. 21,504 - Unknown

livebaseballscorecards.com

AB	35
R	5
H	8
RBI	5
BB	4
SO	3
LOB	15







Batter	1	2	3	4	5	6	7	8	9	AB R H RBI BB SO LOB	TOP											
Whitey Lockman, L (1, 3) OBP: 0.312, SLG: 0.405	0-0 G3		0-0 FC6-4		0-0 3-1		0-0 1B			4 0 1 1 0 0 1												
Alvin Dark, R (1, 6) OBP: 0.325, SLG: 0.443	0-3 K			0-3 K		0-0 6-3	0-0 4-3			4 0 0 0 0 2 1												
Don Mueller, L (1, 9) OBP: 0.370, SLG: 0.447	0-0 1-3			0-0 1B		0-0 G3		0-0 G3		4 0 1 0 0 0 0												
Monte Irvin, R (1, 7) OBP: 0.372, SLG: 0.476		0-0 5-3		0-0 F4		0-0 FC6-4 1B		0-0 1-3		4 0 1 0 0 0 1												
Willie Mays, R (1, 8) OBP: 0.392, SLG: 0.701		0-3 K		0-0 4-3		0-0 FC6-4		0-0 F3		4 0 0 0 0 1 2												
Davey Williams, R (1, 4) OBP: 0.300, SLG: 0.350		0-0 4-3			4-0 HR BB		0-0 SH1-4 1B		0-0 6-3	3 2 1 0 1 0 0												
Hank Thompson, L (1, 5) OBP: 0.397, SLG: 0.490			0-0 FC8-5 2B		0-0 3-4-1		0-0 SH1-4		0-0 F7	3 0 1 0 0 0 1												
Wes Westrum, R (1, 2) OBP: 0.314, SLG: 0.370			0-0 FC8-5		0-0 HR		0-0 6-3 1B		0-0 F7	4 2 2 3 0 0 1												
Don Liddle, L (1, 1) OBP: 0.222, SLG: 0.222			0-0 FC6-4 1B		0-0 6-3		0-0 6-3			3 0 1 0 0 0 1												
<b>Inning Stats</b>	R: 0 E: 0 K: 1 S: 5	H: 0 LOB: 0 BB: 0 P: 5	R: 0 E: 0 K: 1 S: 5	H: 0 LOB: 0 BB: 0 P: 5	R: 0 E: 0 K: 0 S: 4	H: 2 LOB: 1 BB: 0 P: 4	R: 0 E: 0 K: 1 S: 6	H: 1 LOB: 1 BB: 0 P: 6	R: 2 E: 0 K: 0 S: 4	H: 1 LOB: 0 BB: 1 P: 8	R: 0 E: 0 K: 0 S: 4	H: 1 LOB: 1 BB: 0 P: 4	R: 2 E: 0 K: 0 S: 6	H: 3 LOB: 1 BB: 0 P: 6	R: 0 E: 0 K: 0 S: 3	H: 0 LOB: 0 BB: 0 P: 3	R: 0 E: 0 K: 0 S: 3	H: 0 LOB: 0 BB: 0 P: 3	1B: 6 2B: 2 3B: 0 HR: 1	SF: 0 SAC: 1 DP: 1 HBP: 0	WP: 0 PB: 0 SB: 0 CS: 0	PA: 35
<b>PITCHER</b>	IP WLS BF H R ER SO BB IBB HBP BLK WP HR S P ERA WHIP																					
Harvey Haddix, L (1, 1) ERA: 3.24	7.0 L 29 8 4 4 3 1 0 0 0 0 0 1 34 38 5.14 1.286																					
Brooks Lawrence, R (8, 1) ERA: 3.38	1.0 3 0 0 0 0 0 0 0 0 0 0 0 3 3 0.00 0.000																					
Cot Deal, R (9, 1) ERA: 6.55	1.0 3 0 0 0 0 0 0 0 0 0 0 0 3 3 0.00 0.000																					

**New York Giants @ St. Louis Cardinals**  
 Sportsman's Park, St. Louis, MO  
 Thu Jul 15 1954, 4:33 AM EDT  
 Att. 23,024 - Unknown

AB	33
R	4
H	8
RBI	4
BB	1
SO	3
LOB	8





Batter	1	2	3	4	5	6	7	8	9	AB R H RBI BB SO LOB	TOP												
Whitey Lockman, L (1, 3) OBP: 0.316, SLG: 0.408	0-0 6-3 1B		0-0 FC5-4 1B		0-0 4-3		0-0 G5-2-3 1B	0-0 WP 1B		5 0 3 1 0 0 0	<b>New York Giants @ St. Louis Cardinals</b> Sportsman's Park, St. Louis, MO Fri Jul 16 19:54, 4:33 AM EDT Att: 21,610 - Unknown												
Alvin Dark, R (1, 6) OBP: 0.326, SLG: 0.441	0-0 CS E 1B		0-0 FC5-4 2B 1-2f		0-0 F4		0-0 G5-2-3 1-2 2-3 3-Hf	4-0 3-H 1B		4 0 1 0 1 0 4													
Don Mueller, L (1, 9) OBP: 0.368, SLG: 0.446	0-0 E4 1-2		0-0 2B 1-3		0-0 5-3		0-3 K	0-0 F5		5 0 1 0 0 1 7													
Hank Thompson, L (1, 5) OBP: 0.391, SLG: 0.481	0-3 K 2-3		0-0 F8			0-3 K		0-0 F6	0-3 K	5 0 0 0 0 3 4													
Monte Irvin, R (1, 7) OBP: 0.375, SLG: 0.477		0-0 G1-4-3 1B		0-0 6-3		0-0 1B		4-0 1B BB	0-0 F3	4 1 2 0 1 0 0													
Willie Mays, R (1, 8) OBP: 0.392, SLG: 0.706		0-0 G1-4-3 1-2f		0-0 HR		0-0 F8		0-0 F6	0-0 BB 1B	5 1 2 1 0 0 3													
Davey Williams, R (1, 4) OBP: 0.307, SLG: 0.356		0-0 1B		0-0 1B		0-0 G3		0-0 E 1B 1B	4-0 BB 1-2 BB	4 1 3 0 1 0 1													
Wes Westrum, R (1, 2) OBP: 0.314, SLG: 0.365		0-0 F7		0-0 F3			4-0 1B BB G5-2-3	0-0 E 1B 1B	0-0 F3	2 0 0 0 1 0 2													
Ruben Gomez, R (7, PR) OBP: 0.190, SLG: 0.190								1-3 2-H E 1B		0 0 0 0 0 0 0													
Ray Katt, R (7, 2) OBP: 0.333, SLG: 0.388								2-3 3-H WP 1B		2 1 1 1 0 0 2													
Sal Maglie, R (1, 1) OBP: 0.167, SLG: 0.103			0-3 K		0-0 F4					2 0 0 0 0 1 1	<b>NY</b>												
Al Corwin, R (4, 1) OBP: 0.594, SLG: 0.846										0 0 0 0 0 0 0													
Dusty Rhodes, L (7, PH) OBP: 0.594, SLG: 0.846										1 0 1 0 0 0 0													
Windy McCall, L (7, 1) OBP: 0.211, SLG: 0.486										0 0 0 0 0 0 0													
Bobby Hofman, R (8, PH) OBP: 0.211, SLG: 0.486										1 0 0 0 0 0 1													
Billy Gardner, R (8, PR) OBP: 0.279, SLG: 0.344										0 0 0 0 0 0 0													
Mary Grissom, R (8, 1) OBP: 0.095, SLG: 0.095										0 0 0 0 0 0 0													
<b>Inning Stats</b>	R: 0 E: 1 K: 1 S: 6	H: 1 LOB: 2 BB: 0 P: 6	R: 0 E: 0 K: 0 S: 4	H: 2 LOB: 1 BB: 0 P: 4	R: 0 E: 0 K: 1 S: 7	H: 2 LOB: 2 BB: 0 P: 7	R: 1 E: 0 K: 0 S: 5	H: 2 LOB: 1 BB: 0 P: 5	R: 0 E: 0 K: 0 S: 3	H: 0 LOB: 0 BB: 0 P: 3		R: 0 E: 0 K: 1 S: 6	H: 1 LOB: 1 BB: 0 P: 6	R: 0 E: 0 K: 1 S: 6	H: 2 LOB: 3 BB: 1 P: 10	R: 3 E: 2 K: 0 S: 7	H: 3 LOB: 3 BB: 2 P: 15	R: 0 E: 0 K: 1 S: 6	H: 1 LOB: 2 BB: 1 P: 10	1B: 12 2B: 2 3B: 0 HR: 1	SF: 0 SAC: 0 DP: 3 HBP: 0	WP: 1 PB: 0 SB: 0 CS: 1	PA: 44
<b>PITCHER</b>	IP WLS BF H R ER SO BB IBB HBP BLK WP HR S P ERA WHIP																						
Vic Raschi, R (1, 1) ERA: 4.46	6.2		29	10	1	1	3	1	0	0		0	0	1	34	38	1.35	1.650					
Al Brazle, L (7, 1) ERA: 4.4	1.1		10	3	3	1	1	1	1	0	0	1	0	10	18	6.75	3.000						
Brooks Lawrence, R (9, 1) ERA: 3.29	1.0	W	5	1	0	0	1	1	0	0	0	0	0	6	10	0.00	2.000						

livebaseballscorecards.com

Batter	1	2	3	4	5	6	7	8	9	AB	R	H	RBI	BB	SO	LOB
Rip Repulski, R OBP: 0.315, SLG: 0.462 (1, 7)	0-0 F4	0-0 5-3		0-0 F6		0-0 4-3 S 1B		0-0 CS	0-0 4-3	5	0	1	0	0	0	3
Wally Moon, L OBP: 0.393, SLG: 0.463 (1, 8)	0-0 4-3		0-0 E6 FC6-4	4-0 2B BB		0-0 4-3			0-0 5-3 1B 1B	4	2	1	0	1	0	1
Red Schoendienst, S OBP: 0.363, SLG: 0.465 (1, 4)	0-0 F8		0-0 FC6-4 1B BB	0-0 2B		0-0 4-3			0-0 5-3 1-2	5	0	1	2	0	0	3
Stan Musial, L OBP: 0.437, SLG: 0.666 (1, 9)		0-0 HR	0-3 K	4-0 IBB		0-0 G4-6-3 1B			4-0 1B IBB	3	1	2	1	2	1	1
Ray Jablonski, R OBP: 0.371, SLG: 0.480 (1, 5)		4-0 1B BB	4-0 1B BB	0-0 6-3		0-0 F5			0-0 1-2 2-H 1B	3	1	1	1	2	0	3
Joe Cunningham, L OBP: 0.353, SLG: 0.541 (1, 3)		0-0 F6	0-0 1-2 2-3 1B		0-0 4-3-6 1B		0-0 G4-6-3 1-2			4	0	2	0	0	0	2
Bill Sarni, R OBP: 0.364, SLG: 0.494 (1, 2)		0-0 1-2 1B 1B	0-0 F3		0-0 4-3-6				0-0 1-3	4	0	1	0	0	0	4
Alex Grammas, R OBP: 0.294, SLG: 0.287 (1, 6)		0-0 1-2 2-H 1B		0-0 2B S 1B		0-0 2-3			0-0 4-3	4	1	2	1	0	0	0
Vic Raschi, R OBP: 0.180, SLG: 0.128 (1, 1)		0-0 F9		0-3 K		0-0 G3			4-0 CS BB	3	0	0	0	0	1	3
Al Brazle, L (7, 1)										0	0	0	0	0	0	0
Joe Frazier, L (8, PH)										0	0	0	0	1	0	0
Dick Schofield, S (8, PR)										0	0	0	0	0	0	0
Brooks Lawrence, R (9, 1)										0	0	0	0	0	0	0

Inning Stats	R: 0	H: 0	E: 0	K: 0	S: 3	H: 0	LOB: 0	BB: 0	P: 3	R: 2	H: 3	E: 0	K: 0	S: 6	R: 0	H: 1	E: 1	K: 1	S: 7	R: 2	H: 2	E: 0	K: 1	S: 7	R: 0	H: 1	E: 0	K: 0	S: 3	R: 0	H: 1	E: 0	K: 0	S: 4	R: 0	H: 1	E: 0	K: 0	S: 3	R: 0	H: 0	E: 0	K: 0	S: 2	R: 1	H: 2	E: 0	K: 0	S: 4	1B: 9	SF: 0	2B: 2	SAC: 0	3B: 0	DP: 2	HR: 1	HBP: 0	WP: 0	PA: 42
--------------	------	------	------	------	------	------	--------	-------	------	------	------	------	------	------	------	------	------	------	------	------	------	------	------	------	------	------	------	------	------	------	------	------	------	------	------	------	------	------	------	------	------	------	------	------	------	------	------	------	------	-------	-------	-------	--------	-------	-------	-------	--------	-------	--------

PITCHER	IP	WLS	BF	H	R	ER	SO	BB	IBB	HBP	BLK	WP	HR	S	P	ERA	WHIP
Sal Maglie, R (1, 1)	3.2		22	6	4	4	2	3	1	0	0	0	1	22	38	9.82	2.455
Al Corwin, R (4, 1)	2.1		8	2	0	0	0	0	0	0	0	0	0	8	8	0.00	0.857
Windy McCall, L (7, 1)	1.0		3	1	0	0	0	0	0	0	0	0	0	3	3	0.00	1.000
Mary Grissom, R (8, 1)	1.2	L	8	2	1	1	0	1	1	0	0	0	0	6	14	5.40	1.800

**BOTTOM**

**New York Giants @ St. Louis Cardinals**  
 Sportsman's Park, St. Louis, MO  
 Fri Jul 16 1954, 4:33 AM EDT  
 Att. 21,610 - Unknown

livebaseballscorecards.com

<b>AB</b>	<b>35</b>
<b>R</b>	<b>5</b>
<b>H</b>	<b>11</b>
<b>RBI</b>	<b>5</b>
<b>BB</b>	<b>6</b>
<b>SO</b>	<b>2</b>
<b>LOB</b>	<b>20</b>



Batter	1	2	3	4	5	6	7	8	9	10	11	AB R H RBI BB SO LOB	TOP		
Davey Williams, R OBP: 0.309, SLG: 0.356	0-0 4-3 WP 2B 1B		0-0 E 1B FC4-6			0-0 5-3		0-0 4-3			0-0 SH3-4	5 2 2 0 0 0 1			
Alvin Dark, R OBP: 0.326, SLG: 0.442	0-0 4-3		0-0 E5 2B 1B	0-0 F7		0-0 4-3 2B		0-3 K		0-0 K	0-0 E 1B	6 1 2 0 0 1 3			
Don Mueller, L OBP: 0.367, SLG: 0.448	0-0 1B 2B		0-0 2B 1B	0-0 F7		0-0 4-3		0-0 3-1		0-0 3-1	0-0 SF7	5 2 2 3 0 0 1			
Monte Irvin, R OBP: 0.378, SLG: 0.481	0-0 G6-4-3 1B		0-0 1B 2B			0-0 F4		0-0 G3		0-0 G3	0-0 6-3	6 1 3 3 0 0 3			
Willie Mays, R OBP: 0.391, SLG: 0.702	0-0 G6-4-3		1-0 1B SF7 HBP	0-0 F3		0-0 4-3		0-0 5-3		0-0 5-3		2 1 0 0 0 0 2			
Hoot Evers, R OBP: 0.056, SLG: 0.222	1-2f											2 0 0 0 0 0 0			
Hank Thompson, L OBP: 0.388, SLG: 0.476		0-0 4-3	0-0 1B FC4-6 1B		0-0 G3		0-0 F7		0-0 F8			5 1 1 2 0 0 0			
Wes Westrum, R OBP: 0.311, SLG: 0.362		0-0 F8	0-0 SF7		0-0 F8		0-0 F4		0-0 1B			4 0 1 1 0 0 0			
Whitey Lockman, L OBP: 0.317, SLG: 0.408		0-0 1-3	0-0 FC4-6 1B		0-0 1B		0-0 F8		0-0 4-3			5 0 2 0 0 0 1			
Johnny Antonelli, L Hoyt Wilhelm, R Paul Giel, R Don Liddle, L Newt Gibson, R Bobby Thomson, R Ruben Gomez, R Billy Gardner, R Winsky McCall, L			0-0 E5 1B FC4-6		0-0 4-3		0-3 K				0-0 1B SH3-4 SF7 1B	3 1 0 0 1 0 0 2 0			
<b>Inning Stats</b>	R: 2 H: 3 E: 0 LOB: 0 K: 0 BB: 0 S: 5 P: 5	R: 0 H: 0 E: 0 LOB: 0 K: 0 BB: 0 S: 3 P: 3	R: 7 H: 5 E: 2 LOB: 1 K: 0 BB: 0 S: 10 P: 11	R: 0 H: 1 E: 0 LOB: 1 K: 0 BB: 0 S: 4 P: 4	R: 0 H: 1 E: 0 LOB: 1 K: 0 BB: 0 S: 4 P: 4	R: 0 H: 1 E: 0 LOB: 1 K: 0 BB: 0 S: 4 P: 4	R: 0 H: 0 E: 0 LOB: 0 K: 0 BB: 0 S: 3 P: 3	R: 0 H: 0 E: 0 LOB: 0 K: 1 BB: 0 S: 5 P: 5	R: 0 H: 0 E: 0 LOB: 0 K: 1 BB: 0 S: 5 P: 5	R: 0 H: 1 E: 0 LOB: 1 K: 0 BB: 0 S: 4 P: 4	R: 1 H: 2 E: 1 LOB: 2 K: 0 BB: 0 S: 5 P: 5	1B: 11 SF: 2 2B: 3 SAC: 1 3B: 0 DP: 1 HR: 0 HBP: 1	WP: 1 PA: 49 PB: 0 SB: 0 CS: 0		
<b>PITCHER</b>	IP WLS BF H R ER SO BB IBB HBP BLK WP HR S P ERA WHIP													<b>PITCHER</b>	IP WLS BF H R ER SO BB IBB HBP BLK WP HR S P ERA WHIP
Royce Lint, L ERA: 4.35	(1, 1) 0.1 4 3 2 2 0 0 0 0 0 0 1 0 4 4 54.00 9.000													Harvey Haddix, L ERA: 3.23	(9, 1) 3.0 L 12 3 1 1 1 0 0 0 0 0 0 0 14 14 3.00 1.000
Cot Deal, R ERA: 6.89	(1, 1) 1.2 11 4 7 3 0 0 0 0 1 0 0 0 10 11 16.20 2.400														
Ralph Beard, R ERA: 2.7	(3, 1) 4.0 16 4 0 0 0 0 0 0 0 0 0 0 16 16 0.00 1.000														
Joe Presko, R ERA: 6.62	(7, 1) 1.0 3 0 0 0 0 0 0 0 0 0 0 0 3 3 0.00 0.000														
Al Brazle, L ERA: 4.32	(8, 1) 1.0 3 0 0 0 0 1 0 0 0 0 0 0 5 5 0.00 0.000														

**New York Giants @ St. Louis Cardinals**  
 Sportsman's Park, St. Louis, MO  
 Sat Jul 17 1954, 4:33 AM EDT  
 Att. 14,990 - Unknown

[livebaseballscorecards.com](http://livebaseballscorecards.com)

AB	45
R	10
H	14
RBI	10
BB	0
SO	2
LOB	13



Batter	1	2	3	4	5	6	7	8	9	10	11	AB R H RBI BB SO LOB
Rip Repulski, R OBP: 0.320, SLG: 0.464 (1, 7)	F8		FC4-6 1B		BB 1B	2B 1B	BB 1B		F6		F7	7 1 4 3 0 0 0
Wally Moon, L OBP: 0.388, SLG: 0.455 (1, 8)	F7		FC4-6 1B		F8	K	BB 1B		K		F7	6 0 0 0 1 2 4
Red Schoendienst, S OBP: 0.368, SLG: 0.469 (1, 4)	1B		BB 1B		BB	2B	BB		6-3			5 0 3 2 1 0 2
Stan Musial, L OBP: 0.436, SLG: 0.658 (1, 9)	F6		BB		4-3	G3			F7		4-3 BB	4 0 0 0 2 0 4
Ray Jablonski, R OBP: 0.374, SLG: 0.483 Dick Schofield, S OBP: 0.167, SLG: 0.500 (1, 5) (8, PR) (9, 6)		6-3	F3			4-3 1B 2B	FC6-4 1B	E BB			K	4 1 2 0 1 0 3 1 1 0 0 0 1 1
Bill Sarni, R OBP: 0.358, SLG: 0.482 (1, 2)		4-3			5-3	4-3	FC6-4 BB 3B	FC3-6 1B			4-3	6 1 1 0 0 0 3
Joe Cunningham, L OBP: 0.365, SLG: 0.523 (1, 3)		BB			5-3	1B 1B	F7	FC3-6 1B			BB	4 1 1 1 2 0 2
Alex Grammas, R OBP: 0.294, SLG: 0.288 Solly Hemus, L OBP: 0.463, SLG: 0.473 (1, 6) (7, PH) (8, 6) (9, 5)		1-3			F8	1B 1B	BB	1B			K	3 1 1 0 0 0 1 2 1 1 0 1 1 2
Royce Lint, L Cot Deal, S Ralph Beard, R Sal Vairs, R Joe Frazier, L Joe Frazier, L Al Brazle, L Peanuts Lowmyer, R Harvey Haddix, L			K		K	2B 1B	1B 3B	6-3			K	0 0 0 0 0 0 0 0 0 0 0 0 0 0 2 0 0 0 0 0 2 1 1 1 0 0 0 0 0 0 0 0 0 0 0 0 0 0 0 0 0 0 1 1 1 2 0 0 0 1 0 0 0 0 0 0 1 0 0 0 0 0 0 1 0 0 0 0 0 2

Inning Stats	R: 0	H: 1	R: 0	H: 0	R: 0	H: 2	R: 0	H: 0	R: 0	H: 1	R: 5	H: 6	R: 3	H: 3	R: 1	H: 2	R: 0	H: 0	R: 0	H: 0	R: 0	H: 0	R: 0	H: 0
	E: 0	LOB: 1	E: 0	LOB: 1	E: 0	LOB: 3	E: 0	LOB: 0	E: 0	LOB: 2	E: 0	LOB: 1	E: 0	LOB: 2	E: 1	LOB: 2	E: 0	LOB: 0	E: 0	LOB: 2	E: 0	LOB: 0	E: 0	LOB: 0
	K: 0	BB: 0	K: 0	BB: 1	K: 1	BB: 1	K: 0	BB: 0	K: 1	BB: 1	K: 1	BB: 0	K: 0	BB: 2	K: 0	BB: 1	K: 1	BB: 0	K: 2	BB: 2	K: 1	BB: 0	K: 1	BB: 0
	S: 4	P: 4	S: 3	P: 7	S: 7	P: 11	S: 3	P: 3	S: 6	P: 10	S: 11	P: 11	S: 6	P: 14	S: 5	P: 9	S: 5	P: 5	S: 7	P: 15	S: 5	P: 5	S: 5	P: 5

PITCHER	IP	WLS	BF	H	R	ER	SO	BB	IBB	HBP	BLK	WP	HR	S	P	ERA	WHIP
Johnny Antonelli, L ERA: 2.34 (1, 1)	5.2		30	10	5	5	3	3	0	0	0	0	0	33	45	7.94	2.294
Hoyt Wilhelm, R ERA: 2.86 (6, 1)	1.0		6	2	3	3	0	1	0	0	0	0	0	5	9	27.00	3.000
Paul Giel, R ERA: (7, 1)	0.0		1	1	0	0	0	0	0	0	0	0	0	1	1	∞	∞
Don Liddle, L ERA: 2.59 (7, 1)	0.2		4	0	1	0	0	2	0	0	0	0	0	2	10	0.00	3.000
Marv Grissom, R ERA: 1.95 (8, 1)	2.2	W	12	2	0	0	3	2	0	0	0	0	0	16	24	0.00	1.500

AB	R	H	RBI	BB	SO	LOB
7	1	4	3	0	0	0
6	0	0	0	1	2	4
5	0	3	2	1	0	2
4	0	0	0	2	0	4
4	1	2	0	1	0	3
1	1	0	0	0	1	1
6	1	1	0	0	0	3
4	1	1	1	2	0	2
3	1	1	0	0	0	1
2	1	1	0	1	1	2
0	0	0	0	0	0	0
0	0	0	0	0	0	0
2	1	1	0	0	0	0
0	0	0	0	0	0	0
0	0	0	0	0	0	0
1	1	1	2	0	0	0
1	0	0	0	0	0	0
1	0	0	0	0	0	0
1	0	0	0	0	1	2

WP	PA
0	56

**New York Giants @ St. Louis Cardinals**  
 Sportsman's Park, St. Louis, MO  
 Sat Jul 17 1954, 4:33 AM EDT  
 Att. 14,990 - Unknown

livebaseballscores.com

AB	R	H	RBI	BB	SO	LOB
48	9	15	8	8	7	24



**New York Giants @ Cincinnati Redlegs**  
 Crosley Field, Cincinnati, OH  
 Sun Jul 18 1954, 3:33 AM EDT  
 Unknown

[livebaseballscorecards.com](http://livebaseballscorecards.com)

<b>AB</b>	36
<b>R</b>	4
<b>H</b>	12
<b>RBI</b>	4
<b>BB</b>	2
<b>SO</b>	2
<b>LOB</b>	16



AB R H RBI BB SO LOB

5	1	3	0	0	0	0
5	1	0	0	0	0	3
5	0	3	2	0	0	0
3	0	0	0	1	0	2
4	2	2	0	0	0	2
3	0	3	1	1	0	0
3	0	0	1	0	0	3
4	0	1	0	0	1	3
1	0	0	0	0	0	1
0	0	0	0	0	0	0
1	0	0	0	0	0	0
0	0	0	0	0	0	0
0	0	0	0	0	0	0
0	0	0	0	0	0	0
1	0	0	0	0	1	1
0	0	0	0	0	0	0

1B:	10	SF:	1
2B:	3	SAC:	0
3B:	0	DP:	2
HR:	0	HBP:	0

WP:	1	PA:	39
PB:	0		
SB:	0		
CS:	0		

Batter	1	2	3	4	5	6	7	8	9
<b>Whitey Lockman, L</b> (1, 3) OBP: 0.321, SLG: 0.411	0-0 FC3-6 1B		0-0 L6-3 1B		0-0 5-3 1B		0-0 4-3		0-0 4-3
<b>Alvin Dark, R</b> (1, 6) OBP: 0.322, SLG: 0.436	0-0 FC3-6 WP 1-2f 3-4		0-0 L6-3 1-2		0-0 5-3 1-2		0-0 F9		0-0 F8
<b>Don Mueller, L</b> (1, 9) OBP: 0.370, SLG: 0.450	0-0 3-4 2-H		0-0 1B		0-0 BB 1B		0-0 1B		0-0 F7
<b>Hank Thompson, L</b> (1, 5) OBP: 0.387, SLG: 0.471	0-0 4-3		0-0 G3-1		4-0 BB 1-2 BB		0-0 F4		
<b>Monte Irvin, R</b> (1, 7) OBP: 0.379, SLG: 0.481		0-0 1B SF8 1B		0-0 F9		0-0 F8		0-0 2B 1B	
<b>Willie Mays, R</b> (1, 8) OBP: 0.398, SLG: 0.707		0-0 1-3 1B		4-0 BB		0-0 G3-6-3 1B		0-0 1-H 2B	
<b>Davey Williams, R</b> (1, 4) OBP: 0.305, SLG: 0.353		0-0 SF8 3-H		0-0 F8		0-0 G3-6-3 1-2f		0-0 F5	
<b>Wes Westrum, R</b> (1, 2) OBP: 0.310, SLG: 0.365		0-0 F9		0-3 K		0-0 2B		0-0 5-3	
<b>Ruben Gomez, R</b> (1, 1) <b>Ramon Marrero, R</b> (1, 1) <b>Bill Taylor, L</b> (1, 1) <b>Paul Giel, R</b> (1, 1) <b>Al Cowens, R</b> (1, 1) <b>Dusty Rhodes, L</b> (1, 1) <b>Hoyt Wilhelm, R</b> (1, 1) <b>Bobby Hofman, R</b> (1, 1) <b>Alex Konikowski, R</b> (1, 1)		0-0 5-3				0-0 F9		0-3 K	

Inning Stats	R: 1	H: 1	E: 1	K: 0	S: 4	P: 4	R: 1	H: 2	E: 0	K: 0	S: 5	P: 5	R: 0	H: 2	E: 0	K: 0	S: 4	P: 4	R: 0	H: 0	E: 0	K: 1	S: 5	P: 9	R: 1	H: 2	E: 0	K: 0	S: 5	P: 9	R: 0	H: 2	E: 0	K: 0	S: 4	P: 4	R: 0	H: 1	E: 0	K: 0	S: 4	P: 4	R: 1	H: 2	E: 0	K: 1	S: 7	P: 7	R: 0	H: 0	E: 0	K: 0	S: 3	P: 3
--------------	------	------	------	------	------	------	------	------	------	------	------	------	------	------	------	------	------	------	------	------	------	------	------	------	------	------	------	------	------	------	------	------	------	------	------	------	------	------	------	------	------	------	------	------	------	------	------	------	------	------	------	------	------	------

PITCHER	IP	WLS	BF	H	R	ER	SO	BB	IBB	HBP	BLK	WP	HR	S	P	ERA	WHIP
<b>Howie Judson, R</b> (1, 1) ERA: 2.92	7.0	W	33	12	4	3	1	2	0	0	0	1	0	33	41	3.86	2.000
<b>Frank Smith, R</b> (8, 1) ERA: 1.31	2.0	S	6	0	0	0	1	0	0	0	0	0	0	8	8	0.00	0.000

PITCHER	IP	WLS	BF	H	R	ER	SO	BB	IBB	HBP	BLK	WP	HR	S	P	ERA	WHIP
---------	----	-----	----	---	---	----	----	----	-----	-----	-----	----	----	---	---	-----	------



BOTTOM

New York Giants @ Cincinnati Redlegs  
Crosley Field, Cincinnati, OH

livebaseballscorecards.com

AB	39
R	14
H	18
RBI	14
BB	8
SO	4
LOB	24



WP	1	PA	48
PB	0		
SB	0		
CS	0		

ERA	54.00	WHIP	7.000
-----	-------	------	-------

Sun Jul 18 1954, 3:33 AM EDT  
Unknown

AB	R	H	RBI	BB	SO	LOB
5	2	4	1	1	0	1
5	2	2	0	0	0	5
4	1	3	3	1	0	1
1	1	0	0	0	0	3
4	2	2	1	1	0	3
0	0	0	0	0	0	0
5	2	3	2	0	0	1
4	2	2	2	1	1	0
4	0	0	1	1	0	6
4	1	2	3	1	1	3
3	1	0	0	1	2	1
0	0	0	1	1	0	0

1B	16	SF	0
2B	1	SAC	1
3B	0	DP	2
HR	1	HBP	0

WP	1	HR	0	S	8	P	24
ERA	54.00	WHIP	7.000				

Batter	1	2	3	4	5	6	7	8	9
Chuck Harmon, R OBP: 0.290, SLG: 0.336 (1, 5)	0-0 G6-4-3 1B		0-0 SH1-4 1B	0-0 5-3 1B	0-0 F8			1B BB	
Roy McMillan, R OBP: 0.306, SLG: 0.310 (1, 6)	0-0 G6-4-3 1-2f		0-0 SH1-4 1-2 2-3	0-0 5-3 1-2		0-0 G3 1B		1B 1B F3	
Gus Bell, L OBP: 0.379, SLG: 0.552 Nino Escalera, L OBP: 0.250, SLG: 0.189 (1, 8) (8, PR) (9, 3)	0-0 1B		0-0 1B 2-H 3-H	4-0 BB		0-0 G3 1-2		1B 1B 4-3	
Ted Kluszewski, L OBP: 0.395, SLG: 0.602 Wally Post, R OBP: 0.280, SLG: 0.420 (1, 3) (9, 8)	0-0 4-3		0-0 BB FC4 1B	0-0 F3		0-0 G6-4-3 1B		1B 1B IBB	
Jim Greengrass, R OBP: 0.320, SLG: 0.497 (1, 7)		0-0 F7	0-0 FC4 BB 1B		0-0 1B 2B 1B	0-0 G6-4-3		0-0 WP 1B 1B	
Bob Borkowski, R OBP: 0.279, SLG: 0.391 (1, 9)		0-0 F7	4-0 FC4 BB		0-0 1-2 2B 1B		0-3 K	0-0 BB WP 1B 1B	
Johnny Temple, R OBP: 0.388, SLG: 0.352 (1, 4)		4-0 BB	0-0 FC4 1-2f 2-3 3-H		0-0 F9		0-0 6-3	0-0 F4 1-2 2-3	
Andy Seminick, R OBP: 0.361, SLG: 0.426 (1, 2)		0-0 5-3	0-3 K		0-0 2B		0-0 HR	4-0 1B BB IBB	
Howie Judson, R OBP: 0.118, SLG: 0.063 Frank Smith, R (8, 1)			4-0 SH1-4 1B BB	0-3 K	0-3 K		0-0 5-3	4-0 1B BB	

Inning Stats	R: 0 E: 0 K: 0 S: 4	H: 2 LOB: 1 BB: 0 P: 4	R: 0 E: 0 K: 0 S: 3	H: 0 LOB: 1 BB: 1 P: 7	R: 4 E: 0 K: 1 S: 9	H: 4 LOB: 2 BB: 2 P: 17	R: 0 E: 0 K: 1 S: 6	H: 1 LOB: 2 BB: 1 P: 10	R: 2 E: 0 K: 1 S: 8	H: 3 LOB: 1 BB: 0 P: 8	R: 1 E: 0 K: 0 S: 4	H: 2 LOB: 0 BB: 0 P: 4	R: 1 E: 0 K: 1 S: 6	H: 1 LOB: 0 BB: 0 P: 6	R: 6 E: 0 K: 0 S: 8	H: 5 LOB: 3 BB: 4 P: 24
--------------	------------------------------	---------------------------------	------------------------------	---------------------------------	------------------------------	----------------------------------	------------------------------	----------------------------------	------------------------------	---------------------------------	------------------------------	---------------------------------	------------------------------	---------------------------------	------------------------------	----------------------------------

PITCHER	IP	WLS	BF	H	R	ER	SO	BB	IBB	HBP	BLK	WP	HR	S	P	ERA	WHIP
Ruben Gomez, R ERA: 3.21 (1, 1)	2.1	L	14	6	4	4	0	0	2	0	0	0	0	12	20	15.43	3.429
Ramon Monzant, R ERA: 4.91 (3, 1)	1.2		8	1	0	0	2	2	0	0	0	0	0	10	18	0.00	1.800
Paul Giel, R ERA: 18.0 (5, 1)	0.0		2	2	2	2	0	0	0	0	0	0	0	2	2	∞	∞
Al Corwin, R ERA: 1.86 (5, 1)	1.0		4	1	0	0	1	0	0	0	0	0	0	6	6	0.00	1.000
Hoyt Wilhelm, R ERA: 3.05 (6, 1)	2.0		8	3	2	2	1	0	0	0	0	0	1	10	10	9.00	1.500

PITCHER	IP	WLS	BF	H	R	ER	SO	BB	IBB	HBP	BLK	WP	HR	S	P	ERA	WHIP
Alex Konikowski, R ERA: 7.36 (8, 1)	1.0		12	5	6	6	0	2	2	0	0	1	0	8	24	54.00	7.000



BOTTOM

New York Giants @ Cincinnati Redlegs

Crosley Field, Cincinnati, OH

Sun Jul 18 1954, 3:38 AM EDT

Att. 30,873 - Unknown

livebaseballscorecards.com

AB	33
R	1
H	6
RBI	1
BB	3
SO	4
LOB	11

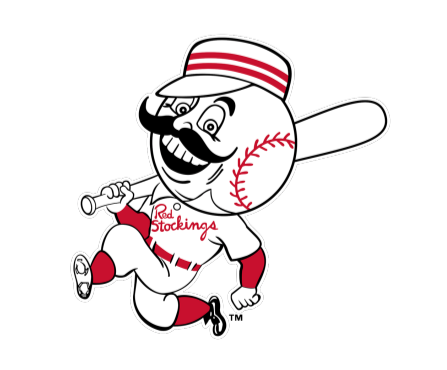

WP:	0	PA:	36
PB:	1	SB:	0
CS:	0		

AB R H RBI BB SO LOB

4 0 0 0 0 0 1

4 0 0 0 0 0 0

4 0 1 0 0 0 0

3 0 1 0 1 0 0

4 0 1 0 0 1 2

4 0 0 0 0 0 2

3 1 2 0 1 0 0

2 0 0 0 1 1 3

0 0 0 0 0 0 0

0 0 0 0 0 0 0

1 0 1 0 0 0 0

1 0 0 1 0 0 1

0 0 0 0 0 0 0

0 0 0 0 0 0 0

1 0 0 0 0 1 2

1B: 4 SF: 0

2B: 2 SAC: 0

3B: 0 DP: 0

HR: 0 HBP: 0

1B: 4 SF: 0

2B: 2 SAC: 0

3B: 0 DP: 0

HR: 0 HBP: 0

1B: 4 SF: 0

2B: 2 SAC: 0

3B: 0 DP: 0

HR: 0 HBP: 0

1B: 4 SF: 0

2B: 2 SAC: 0

3B: 0 DP: 0

HR: 0 HBP: 0

1B: 4 SF: 0

2B: 2 SAC: 0

3B: 0 DP: 0

HR: 0 HBP: 0

1B: 4 SF: 0

2B: 2 SAC: 0

3B: 0 DP: 0

HR: 0 HBP: 0

1B: 4 SF: 0

2B: 2 SAC: 0

3B: 0 DP: 0

HR: 0 HBP: 0

1B: 4 SF: 0

2B: 2 SAC: 0

3B: 0 DP: 0

HR: 0 HBP: 0

1B: 4 SF: 0

2B: 2 SAC: 0

3B: 0 DP: 0

HR: 0 HBP: 0

1B: 4 SF: 0

2B: 2 SAC: 0

3B: 0 DP: 0

HR: 0 HBP: 0

1B: 4 SF: 0

2B: 2 SAC: 0

3B: 0 DP: 0

HR: 0 HBP: 0

1B: 4 SF: 0

2B: 2 SAC: 0

3B: 0 DP: 0

HR: 0 HBP: 0

1B: 4 SF: 0

2B: 2 SAC: 0

3B: 0 DP: 0

HR: 0 HBP: 0

1B: 4 SF: 0

2B: 2 SAC: 0

3B: 0 DP: 0

HR: 0 HBP: 0

1B: 4 SF: 0

2B: 2 SAC: 0

3B: 0 DP: 0

HR: 0 HBP: 0

1B: 4 SF: 0

2B: 2 SAC: 0

3B: 0 DP: 0

HR: 0 HBP: 0

1B: 4 SF: 0

2B: 2 SAC: 0

3B: 0 DP: 0

HR: 0 HBP: 0

1B: 4 SF: 0

2B: 2 SAC: 0

3B: 0 DP: 0

HR: 0 HBP: 0

1B: 4 SF: 0

2B: 2 SAC: 0

3B: 0 DP: 0

HR: 0 HBP: 0

1B: 4 SF: 0

2B: 2 SAC: 0

3B: 0 DP: 0

HR: 0 HBP: 0

1B: 4 SF: 0

2B: 2 SAC: 0

3B: 0 DP: 0

HR: 0 HBP: 0

1B: 4 SF: 0

2B: 2 SAC: 0

3B: 0 DP: 0

HR: 0 HBP: 0

1B: 4 SF: 0

2B: 2 SAC: 0

3B: 0 DP: 0

HR: 0 HBP: 0

1B: 4 SF: 0

2B: 2 SAC: 0

3B: 0 DP: 0

HR: 0 HBP: 0

1B: 4 SF: 0

2B: 2 SAC: 0

3B: 0 DP: 0

HR: 0 HBP: 0

1B: 4 SF: 0

2B: 2 SAC: 0

3B: 0 DP: 0

HR: 0 HBP: 0

1B: 4 SF: 0

2B: 2 SAC: 0

3B: 0 DP: 0

HR: 0 HBP: 0

1B: 4 SF: 0

2B: 2 SAC: 0

3B: 0 DP: 0

HR: 0 HBP: 0

1B: 4 SF: 0

2B: 2 SAC: 0

3B: 0 DP: 0

HR: 0 HBP: 0

1B: 4 SF: 0

2B: 2 SAC: 0

3B: 0 DP: 0

HR: 0 HBP: 0

1B: 4 SF: 0

2B: 2 SAC: 0

3B: 0 DP: 0

HR: 0 HBP: 0

1B: 4 SF: 0

2B: 2 SAC: 0

3B: 0 DP: 0

HR: 0 HBP: 0

1B: 4 SF: 0

2B: 2 SAC: 0

3B: 0 DP: 0

HR: 0 HBP: 0

1B: 4 SF: 0

2B: 2 SAC: 0

3B: 0 DP: 0

HR: 0 HBP: 0

1B: 4 SF: 0

2B: 2 SAC: 0

3B: 0 DP: 0

HR: 0 HBP: 0

1B: 4 SF: 0

2B: 2 SAC: 0

3B: 0 DP: 0

HR: 0 HBP: 0

1B: 4 SF: 0

2B: 2 SAC: 0

3B: 0 DP: 0

HR: 0 HBP: 0

1B: 4 SF: 0

2B: 2 SAC: 0

3B: 0 DP: 0

HR: 0 HBP: 0

1B: 4 SF: 0

2B: 2 SAC: 0

3B: 0 DP: 0

HR: 0 HBP: 0

1B: 4 SF: 0

2B: 2 SAC: 0

3B: 0 DP: 0

HR: 0 HBP: 0

1B: 4 SF: 0

2B: 2 SAC: 0

3B: 0 DP: 0

HR: 0 HBP: 0

1B: 4 SF: 0

2B: 2 SAC: 0

3B: 0 DP: 0

HR: 0 HBP: 0

1B: 4 SF: 0

2B: 2 SAC: 0

3B: 0 DP: 0

HR: 0 HBP: 0

1B: 4 SF: 0

2B: 2 SAC: 0

3B: 0 DP: 0

HR: 0 HBP: 0

1B: 4 SF: 0

2B: 2 SAC: 0

3B: 0 DP: 0

HR: 0 HBP: 0

1B: 4 SF: 0

2B: 2 SAC: 0

3B: 0 DP: 0

HR: 0 HBP: 0

1B: 4 SF: 0

2B: 2 SAC: 0

3B: 0 DP: 0

HR: 0 HBP: 0

1B: 4 SF: 0

2B: 2 SAC: 0

3B: 0 DP: 0

HR: 0 HBP: 0

1B: 4 SF: 0

2B: 2 SAC: 0

3B: 0 DP: 0

HR: 0 HBP: 0

1B: 4 SF: 0

2B: 2 SAC: 0

3B: 0 DP: 0

HR: 0 HBP: 0

1B: 4 SF: 0

2B: 2 SAC: 0

3B: 0 DP: 0

HR: 0 HBP: 0

1B: 4 SF: 0

2B: 2 SAC: 0

3B: 0 DP: 0

HR: 0 HBP: 0

1B: 4 SF: 0

2B: 2 SAC: 0

3B: 0 DP: 0

HR: 0 HBP: 0

1B: 4 SF: 0

2B: 2 SAC: 0

3B: 0 DP: 0

HR: 0 HBP: 0

1B: 4 SF: 0

2B: 2 SAC: 0

3B: 0 DP: 0

HR: 0 HBP: 0

1B: 4 SF: 0

2B: 2 SAC: 0

3B: 0 DP: 0

HR: 0 HBP: 0

1B: 4 SF: 0

2B: 2 SAC: 0

3B: 0 DP: 0

HR: 0 HBP: 0

1B: 4 SF: 0

2B: 2 SAC: 0

3B: 0 DP: 0

HR: 0 HBP: 0

1B: 4 SF: 0

2B: 2 SAC: 0

3B: 0 DP: 0

HR: 0 HBP: 0

1B: 4 SF: 0

2B: 2 SAC: 0

3B: 0 DP: 0

HR: 0 HBP: 0

1B: 4 SF: 0

2B: 2 SAC: 0

3B: 0 DP: 0

HR: 0 HBP: 0

1B: 4 SF: 0

Batter	1	2	3	4	5	6	7	8	9	10	11	12	AB	R	H	RBI	BB	SO	LOB	TOP				
Davey Williams, R (1, 4) OBP: 0.298, SLG: 0.344	0-0 4-3		0-0 F6			0-0 FC1-6		0-0 G2-6-3			0-0 5-3		5	0	0	0	0	0	2					
Alvin Dark, R (1, 6) OBP: 0.319, SLG: 0.431	0-0 F9		0-0 5-3			0-0 F8		0-0 F7			0-0 FC5-4 1B		5	0	1	0	0	0	1					
Don Mueller, L (1, 9) OBP: 0.364, SLG: 0.442	0-0 F3				0-0 F5		0-0 3-1			0-0 F7		0-0 F9		5	0	0	0	0	2					
Monte Irvin, R (1, 7) OBP: 0.378, SLG: 0.490		0-0 F5			0-0 F9					0-0 F3		0-0 FC5-4		5	0	1	0	0	1					
Willie Mays, R (1, 8) OBP: 0.394, SLG: 0.703		0-0 F6			0-0 F8		0-0 K			0-0 F2		0-3 K		5	0	0	0	2	1					
Whitey Lockman, L (1, 3) OBP: 0.321, SLG: 0.412						0-0 F7		0-0 FC1-4 BB				0-0 G3		5	0	1	0	0	1					
Wes Westrum, R (1, 2) OBP: 0.321, SLG: 0.361		4-0 BB			0-3 K		4-0 BB			4-0 BB		0-3 K		2	0	0	0	3	2	0				
Billy Gardner, R (1, 5) OBP: 0.260, SLG: 0.319		0-0 F4			0-3 K		0-0 F3			0-0 F7				4	0	0	0	0	1	5				
Don Liddle, L (1, 1) OBP: 0.273, SLG: 0.200			0-3 K			4-0 FC1-6 BB		4-0 G2-6-3 BB			0-0 F4			1	0	0	0	2	1	0				
Marv Grissom, R (9, 1) OBP: 0.095, SLG: 0.095														0	0	0	0	0	0	0				
Bobby Hofman, R (10, PH) OBP: 0.220, SLG: 0.475														1	0	0	0	0	0	1				
Al Corwin, R (10, 1)														0	0	0	0	0	0	0				
<b>Inning Stats</b>	R: 0 E: 0 K: 0 S: 3	H: 0 LOB: 0 BB: 0 P: 3	R: 0 E: 0 K: 0 S: 4	H: 1 LOB: 2 BB: 1 P: 8	R: 0 E: 0 K: 1 S: 5	H: 0 LOB: 0 BB: 0 P: 5	R: 0 E: 0 K: 0 S: 3	H: 0 LOB: 0 BB: 0 P: 3	R: 0 E: 0 K: 2 S: 7	H: 0 LOB: 0 BB: 0 P: 7	R: 0 E: 0 K: 1 S: 3	H: 1 LOB: 2 BB: 1 P: 10	R: 0 E: 0 K: 0 S: 2	H: 0 LOB: 0 BB: 1 P: 6	R: 0 E: 0 K: 0 S: 3	H: 0 LOB: 0 BB: 0 P: 3	R: 0 E: 0 K: 0 S: 3	H: 1 LOB: 1 BB: 0 P: 4	R: 0 E: 0 K: 0 S: 7	H: 0 LOB: 0 BB: 0 P: 7	1B: 1 2B: 2 3B: 0 HR: 0	SF: 0 SAC: 0 DP: 1 HBP: 0	WP: 0 PB: 0 SB: 0 CS: 0	PA: 43
<b>PITCHER</b> Harry Perkowski, L (1, 1) ERA: 6.31	IP: 12.0 WLS: W BF: 43	H: 3 R: 0 ER: 0 SO: 6	BB: 5 IBB: 0 HBP: 0 BLK: 0	WP: 0 HR: 0 S: 50 P: 70	ERA: 0.00 WHIP: 0.667	<b>PITCHER</b> IP: WLS: BF: H: R: ER: SO: BB: IBB: HBP: BLK: WP: HR: S: P: ERA: WHIP:																		

New York Giants @ Cincinnati Redlegs  
 Crosley Field, Cincinnati, OH  
 Mon Jul 19 1954, 3:33 AM EDT  
 Att. 13,477 - Unknown

livebaseballscorecards.com

AB	38
R	0
H	3
RBI	0
BB	5
SO	6
LOB	14









Batter	1	2	3	4	5	6	7	8	9	AB R H RBI BB SO LOB	TOP
Whitey Lockman, L (1, 3) OBP: 0.320, SLG: 0.407	0-0 FC6-4 1B		0-0 4-3			0-0 4-3		0-0 6-3		4 0 1 0 0 0 1	
Alvin Dark, R (1, 6) OBP: 0.316, SLG: 0.426	0-0 FC6-4 1-2f			0-0 1B 2B		0-0 F9		0-0 1-3		4 1 1 0 0 0 2	
Hank Thompson, L (1, 5) OBP: 0.380, SLG: 0.456	0-0 1-3 1-2			0-0 F8		0-0 4-3			0-0 SH1-3 1B	4 1 1 0 0 0 2	
Monte Irvin, R (1, 7) OBP: 0.382, SLG: 0.492	0-0 4-3			0-0 S 1B			0-0 1B 1B		0-0 SH1-3	3 0 2 1 0 0 1	
Don Mueller, L (1, 9) OBP: 0.361, SLG: 0.439		0-3 K		0-0 F8 1-2			0-0 1B 1B		0-0 6-3	4 0 1 0 0 1 2	
Dusty Rhodes, L (1, 8) OBP: 0.500, SLG: 0.773		0-0 E3		0-0 F8			0-0 F2		4-0 1B IBB	3 0 0 0 1 0 3 0 0 0 0 0 0 0	
Hoot Evers, R (9, 8) OBP: 0.053, SLG: 0.211											
Davey Williams, R (1, 4) OBP: 0.299, SLG: 0.345		0-0 G3-6				0-0 F9			0-0 1B	3 0 0 0 0 0 3	
Bill Taylor, L (9, PH) OBP: 0.277, SLG: 0.310							0-0 G6-4-3			1 0 1 1 0 0 0	
Billy Gardner, R (9, 4) OBP: 0.260, SLG: 0.319							1-2f		1-2 2-H	0 0 0 0 0 0 0	
Wes Westrum, R (1, 2) OBP: 0.315, SLG: 0.348			0-0 F7			0-0 6-3		4-0 SH3 BB	0-0 L3	3 0 0 0 1 0 2	
Sal Maglie, R (1, 1) OBP: 0.156, SLG: 0.095			0-0 G3			0-0 3-1		0-0 SH3		2 0 0 0 0 0 0	
<b>Inning Stats</b>	R: 0 E: 0 K: 0 S: 4 H: 1 LOB: 1 BB: 0 P: 4	R: 0 E: 1 K: 1 S: 5 H: 0 LOB: 0 BB: 0 P: 5	R: 0 E: 0 K: 0 S: 3 H: 0 LOB: 0 BB: 0 P: 3	R: 1 E: 0 K: 0 S: 5 H: 2 LOB: 1 BB: 0 P: 5	R: 0 E: 0 K: 0 S: 3 H: 0 LOB: 0 BB: 0 P: 3	R: 0 E: 0 K: 0 S: 3 H: 0 LOB: 0 BB: 0 P: 3	R: 0 E: 0 K: 0 S: 4 H: 2 LOB: 1 BB: 0 P: 4	R: 0 E: 0 K: 0 S: 3 H: 0 LOB: 1 BB: 1 P: 7	R: 1 E: 0 K: 0 S: 5 H: 2 LOB: 2 BB: 1 P: 9	1B: 6 2B: 1 3B: 0 HR: 0 SF: 0 SAC: 2 DP: 2 HBP: 0	WP: 0 PB: 0 SB: 1 CS: 0 PA: 35
<b>PITCHER</b> Bob Rush, R (1, 1) ERA: 4.41	IP: 9.0 WLS: L BF: 35 H: 7 R: 2 ER: 2 SO: 1 BB: 1 IBB: 1 HBP: 0 BLK: 0 WP: 0 HR: 0 S: 35 P: 43 ERA: 2.00 WHIP: 0.889										

**New York Giants @ Chicago Cubs**  
Wrigley Field, Chicago, IL  
Wed Jul 21 1954, 3:33 AM CDT  
Att: 12,190 - Unknown

[livebaseballscorecards.com](http://livebaseballscorecards.com)

<b>AB</b>	31
<b>R</b>	2
<b>H</b>	7
<b>RBI</b>	2
<b>BB</b>	2
<b>SO</b>	1
<b>LOB</b>	16





BOTTOM

New York Giants @ Chicago Cubs  
Wrigley Field, Chicago, IL  
Wed Jul 21 1954, 3:33 AM CDT  
Att. 12,190 - Unknown

livebaseballscorecards.com

AB	29
R	1
H	4
RBI	1
BB	3
SO	7
LOB	9



WP:	0	PA:	32
PB:	0	SB:	1
CS:	1		

AB R H RBI BB SO LOB

3	1	0	0	1	0	1
3	0	1	1	1	2	1
4	0	1	0	0	1	2
4	0	0	0	0	1	1
4	0	0	0	0	2	0
3	0	1	0	0	0	0
2	0	0	0	1	0	1
2	0	0	0	0	0	1
1	0	0	0	0	0	2
3	0	1	0	0	1	0

Batter	1	2	3	4	5	6	7	8	9
Bob Talbot, R OBP: 0.287, SLG: 0.318 (1, 8)	0-0 F7		4-0 1B BB			0-0 F9		0-0 FC3-6 CS	
Gene Baker, R OBP: 0.345, SLG: 0.459 (1, 4)	0-3 K		0-0 1B G4-6-3 1-H			4-0 BB K		0-3 K 1-2	
Dee Fondy, L OBP: 0.319, SLG: 0.411 (1, 3)	0-0 1B		0-0 G4-6-3 1-2f			0-3 K 1-2		0-0 G3	
Randy Jackson, R OBP: 0.360, SLG: 0.513 (1, 5)	0-0 4-3			0-3 K		0-0 F4		0-0 6-3	
Ralph Kiner, R OBP: 0.396, SLG: 0.518 (1, 7)		0-3 K		0-0 F6		0-0 5-3		0-3 K	
Hank Sauer, R OBP: 0.397, SLG: 0.603 (1, 9)		0-0 2B		0-0 F5		0-0 E5			
14 Ernie Banks, R OBP: 0.336, SLG: 0.411 (1, 6)		0-0 F8			0-0 F7		4-0 FC5-4 IBB		
El Tappe, R OBP: 0.264, SLG: 0.245 Walker Cooper, R OBP: 0.411, SLG: 0.577 (7, PH) (8, 2)	0-0 4-3				0-0 4-3		0-0 FC5-4 1-2f		
Bob Rush, R OBP: 0.383, SLG: 0.435 (1, 1)			0-3 K		0-0 4-3			0-0 FC3-6 1B	

Inning Stats	R: 0 E: 0 K: 1 S: 6	H: 1 LOB: 1 BB: 0 P: 6	R: 0 E: 0 K: 1 S: 6	H: 1 LOB: 1 BB: 0 P: 6	R: 1 E: 0 K: 1 S: 5	H: 1 LOB: 0 BB: 1 P: 9	R: 0 E: 0 K: 1 S: 5	H: 0 LOB: 0 BB: 0 P: 5	R: 0 E: 0 K: 0 S: 3	H: 0 LOB: 0 BB: 0 P: 3	R: 0 E: 0 K: 1 S: 4	H: 0 LOB: 1 BB: 1 P: 8	R: 0 E: 1 K: 0 S: 4	H: 0 LOB: 2 BB: 1 P: 8	R: 0 E: 0 K: 1 S: 5	H: 1 LOB: 0 BB: 0 P: 5	R: 0 E: 0 K: 1 S: 5	H: 0 LOB: 0 BB: 0 P: 5
--------------	------------------------------	---------------------------------	------------------------------	---------------------------------	------------------------------	---------------------------------	------------------------------	---------------------------------	------------------------------	---------------------------------	------------------------------	---------------------------------	------------------------------	---------------------------------	------------------------------	---------------------------------	------------------------------	---------------------------------

PITCHER	IP	WLS	BF	H	R	ER	SO	BB	IBB	HBP	BLK	WP	HR	S	P	ERA	WHIP
---------	----	-----	----	---	---	----	----	----	-----	-----	-----	----	----	---	---	-----	------

Sal Maglie, R ERA: 3.26 (1, 1)	9.0	W	32	4	1	1	7	2	1	0	0	0	0	43	55	1.00	0.667
--------------------------------------	-----	---	----	---	---	---	---	---	---	---	---	---	---	----	----	------	-------

Batter	1	2	3	4	5	6	7	8	9	AB R H RBI BB SO LOB	TOP									
Whitey Lockman, L (1, 8) OBP: 0.320, SLG: 0.407	0-0 1-3	0-3 K			0-0 F8		0-0 E8		0-0 E7	5 0 2 1 0 1 2										
Alvin Dark, R (1, 6) OBP: 0.314, SLG: 0.424	0-0 F4		0-0 G5-4-3 1B			0-0 5-3	0-0 F4		0-0 5-3	5 0 1 0 0 0 2										
Don Mueller, L (1, 9) OBP: 0.359, SLG: 0.436	0-0 F5		0-0 F9			0-0 F8		0-0 1B G3 1B	0-0 F7	5 1 1 0 0 0 2										
Monte Irvin, R (1, 7) OBP: 0.386, SLG: 0.494		0-0 E 1B	0-0 G5-4-3 1-2f			4-0 BB BB		0-0 1-3 G3 1B		3 1 2 0 1 0 1										
Bobby Hofman, R (1, 3) OBP: 0.234, SLG: 0.444		0-0 F3 1-H		0-0 F7		4-0 BB BB		0-3 K		3 0 0 0 1 1 2										
Hank Thompson, L (1, 5) OBP: 0.378, SLG: 0.451		4-0 2B BB		0-0 F7		0-0 3-1		0-0 G3 1-2 3-H		3 1 0 1 1 0 3										
Davey Williams, R (1, 4) OBP: 0.298, SLG: 0.347		0-0 4-3 1-H 2B		0-0 F7			0-0 E4 FC4	0-0 6-3		4 0 1 1 0 0 1										
Wes Westrum, R (1, 2) OBP: 0.315, SLG: 0.343		4-0 4-3 BB			0-0 5-3		0-0 FC4 SH1-4 E		0-0 G3	2 1 0 0 1 0 1 1 0 0 0 0 0 0										
Bill Taylor, L (9, PH) OBP: 0.271, SLG: 0.302																				
Jim Hearn, R (1, 1) OBP: 0.206, SLG: 0.258		0-0 4-3			0-0 5-3		0-0 SH1-4		0-0 E3 1B	2 0 0 0 0 0 2 0 1 1 0 0 0 0 0										
Mary Grissom, R (7, 1) OBP: 0.095, SLG: 0.095																				
Al Corwin, R (7, 1)																				
Ramon Monzant, R (8, 1)																				
Dusty Rhodes, L (9, PH) OBP: 0.490, SLG: 0.756		1-2 2-3																		
<b>Inning Stats</b>	R: 0 E: 0 K: 0 S: 3	H: 0 LOB: 0 BB: 0 P: 3	R: 2 E: 1 K: 1 S: 7	H: 2 LOB: 2 BB: 2 P: 15	R: 0 E: 0 K: 0 S: 3	H: 1 LOB: 0 BB: 0 P: 3	R: 0 E: 0 K: 0 S: 3	H: 0 LOB: 0 BB: 0 P: 3	R: 0 E: 0 K: 0 S: 3	H: 0 LOB: 2 BB: 2 P: 11	R: 1 E: 2 K: 0 S: 5	H: 1 LOB: 1 BB: 0 P: 5	R: 1 E: 0 K: 1 S: 7	H: 2 LOB: 1 BB: 0 P: 7	R: 1 E: 2 K: 0 S: 5	H: 1 LOB: 1 BB: 0 P: 5	1B: 6 2B: 1 3B: 0 HR: 0	SF: 0 SAC: 1 DP: 1 HBP: 0	WP: 0 PB: 0 SB: 0 CS: 0	PA: 39
<b>PITCHER</b>	IP WLS BF H R ER SO BB IBB HBP BLK WP HR S P ERA WHIP																			
Jim Davis, L (1, 1) ERA: 3.74	7.0 W 29 4 3 1 1 4 0 0 0 0 0 0 27 43 1.29 1.143																			
Bill Tremel, R (8, 1) ERA: 4.45	2.0 S 10 3 2 1 1 0 0 0 0 0 0 0 12 12 4.50 1.500																			

**New York Giants @ Chicago Cubs**  
Wrigley Field, Chicago, IL  
Thu Jul 22 1954, 3:33 AM CDT  
Att. 16,438 - Unknown

livebaseballscorecards.com

AB	34
R	5
H	7
RBI	3
BB	4
SO	2
LOB	16



BOTTOM

New York Giants @ Chicago Cubs  
Wrigley Field, Chicago, IL  
Thu Jul 22 1954, 3:33 AM CDT  
Att. 16,438 - Unknown

livebaseballscores.com

AB 38  
R 13  
H 14  
RBI 12  
BB 4  
SO 3  
LOB 16



WP: 3 PA: 43  
PB: 0  
SB: 0  
CS: 1

AB R H RBI BB SO LOB  
3 0 1 0 0 0 0  
1 0 0 0 0 1 2  
1 1 1 2 0 0 0

5 1 1 3 0 0 3

4 3 1 0 1 0 0

5 3 4 5 0 0 0

4 0 1 0 0 0 1  
1 0 1 1 0 0 0

5 1 2 1 0 0 2

3 1 1 0 1 0 2

1 0 0 0 1 0 2  
2 1 0 0 0 1 3

2 0 0 0 0 1 1  
1 2 1 0 1 0 0

1B: 10 SF: 0  
2B: 0 SAC: 1  
3B: 1 DP: 0  
HR: 3 HBP: 0

WP HR S P ERA WHIP

Batter	1	2	3	4	5	6	7	8	9
Bob Talbot, R (1, 8) Steve Bilko, R (7, PH) Walker Cooper, R (8, 2)	F4		F6		CS 1B		K	1B 1B	
Gene Baker, R (1, 4)	6-3		F8		F5		IHR	F8	
Dee Fondy, L (1, 3)	HR BB		F3		F7		E1 HR	E2 1B 1B	
Randy Jackson, R (1, 5)	HR				WP 1B		F6	HR 1B 1B	
Ralph Kiner, R (1, 7) Bill Tremel, R (8, 1)	F8				F8		6-3	1B 1B	
Hank Sauer, R (1, 9) (8, 7)			5-3		F7		F5	1B 1B	
14 Ernie Banks, R (1, 6)			F4		BB BB BB		FC1-2 3B	SH 1B 1B	
El Tappe, R (1, 2) Hal Rice, L (7, PH) (8, 9)			WP BB		6-3		FC1-2 WP BB IHR	K	
Jim Davis, S (1, 1) Frank Baumholtz, L (7, PH) (8, 8)			4-3				K	1B 1B E 1B	

Inning Stats	R: 2	H: 1	E: 0	LOB: 0	K: 0	S: 4	P: 8	R: 0	H: 0	E: 0	LOB: 1	K: 0	S: 3	P: 7	R: 0	H: 0	E: 0	LOB: 0	K: 0	S: 3	R: 0	H: 1	E: 0	LOB: 2	K: 0	S: 4	P: 8	R: 0	H: 1	E: 0	LOB: 0	K: 1	S: 5	R: 0	H: 1	E: 0	LOB: 1	K: 0	S: 4	R: 5	H: 3	E: 1	LOB: 0	K: 1	S: 9	R: 6	H: 7	E: 1	LOB: 2	K: 1	S: 13	1B: 10	SF: 0	2B: 0	SAC: 1	3B: 1	DP: 0	HR: 3	HBP: 0
--------------	------	------	------	--------	------	------	------	------	------	------	--------	------	------	------	------	------	------	--------	------	------	------	------	------	--------	------	------	------	------	------	------	--------	------	------	------	------	------	--------	------	------	------	------	------	--------	------	------	------	------	------	--------	------	-------	--------	-------	-------	--------	-------	-------	-------	--------

PITCHER	IP	WLS	BF	H	R	ER	SO	BB	IBB	HBP	BLK	WP	HR	S	P	ERA	WHIP
Jim Hearn, R (1, 1) ERA: 4.06	6.1	L	27	5	4	4	1	4	0	0	0	2	1	25	41	5.68	1.421
Mary Grissom, R (7, 1) ERA: 2.04	0.1		4	2	3	1	1	0	0	0	0	1	1	6	6	27.00	6.000
Al Corwin, R (7, 1) ERA: 3.46	1.0		9	5	6	2	1	0	0	0	0	0	0	11	11	18.00	5.000
Ramon Monzant, R (8, 1) ERA: 4.7	0.1		3	2	0	0	0	0	0	0	0	0	0	3	3	0.00	6.000

Batter	1	2	3	4	5	6	7	8	9	AB R H RBI BB SO LOB	TOP
Whitey Lockman, L (1, 3) OBP: 0.322, SLG: 0.411	0-0 2B		0-0 F7			0-0 F8		0-0 1B		4 1 2 0 0 0 0	<b>New York Giants @ Milwaukee Braves</b> Milwaukee County Stadium, Milwaukee, WI Fri Jul 23 1954, 4:33 AM EDT Att: 45,056 - Unknown
Alvin Dark, R (1, 6) OBP: 0.316, SLG: 0.424	0-3 K		0-0 4-3			0-0 FC6 1B		0-0 1B		4 0 2 0 0 1 1	
Don Mueller, L (1, 9) OBP: 0.358, SLG: 0.437	0-0 2B				0-0 F6		0-0 FC6		0-0 G6-4-3	4 0 1 1 0 0 3	
Hank Thompson, L (1, 5) OBP: 0.377, SLG: 0.447	0-0 F9				0-3 K		0-0 F8		4-0 1B SF7 BB	3 1 0 0 1 1 2	
Dusty Rhodes, L (1, 8) OBP: 0.472, SLG: 0.735	0-0 F9				0-0 2B		0-0 4-1		0-0 F9	4 0 1 0 0 0 2	
Monte Irvin, R (1, 7) OBP: 0.388, SLG: 0.492		4-0 BB			0-0 3-1		0-0 1-3		0-0 1B	3 0 1 0 1 0 1	
Davey Williams, R (1, 4) OBP: 0.298, SLG: 0.347		0-0 G6-4-3			0-0 F7		0-0 1B		0-0 SF7	3 0 1 1 0 0 1	
Ray Katt, R (1, 2) OBP: 0.333, SLG: 0.387		0-0 F8			0-0 F3		0-0 G3		0-0 F8	4 0 0 0 0 0 2	
Ruben Gomez, R (1, 1) OBP: 0.178, SLG: 0.178 Bill Taylor, L (8, PH) OBP: 0.265, SLG: 0.295 Hoyt Wilhelm, R (8, 1)			0-0 F7		0-0 6-3			0-0 F9		2 0 0 0 0 0 0 1 0 0 0 0 0 0 0 0 0 0 0 0 0	
<b>Inning Stats</b>	R: 1 H: 2 E: 0 LOB: 1 K: 1 BB: 0 S: 7 P: 7	R: 0 H: 0 E: 0 LOB: 0 K: 0 BB: 1 S: 2 P: 6	R: 0 H: 0 E: 0 LOB: 0 K: 0 BB: 0 S: 3 P: 3	R: 0 H: 1 E: 0 LOB: 1 K: 1 BB: 0 S: 6 P: 6	R: 0 H: 0 E: 0 LOB: 0 K: 0 BB: 0 S: 3 P: 3	R: 0 H: 1 E: 0 LOB: 1 K: 0 BB: 0 S: 4 P: 4	R: 0 H: 1 E: 0 LOB: 1 K: 0 BB: 0 S: 4 P: 4	R: 0 H: 2 E: 0 LOB: 1 K: 0 BB: 0 S: 4 P: 4	R: 1 H: 1 E: 0 LOB: 1 K: 0 BB: 1 S: 4 P: 8	1B: 5 SF: 1 2B: 3 SAC: 0 3B: 0 DP: 2 HR: 0 HBP: 0	WP: 0 PA: 35 PB: 0 SB: 0 CS: 0
<b>PITCHER</b> Bob Buhl, R (1, 1) ERA: 4.22	IP WLS BF H R ER SO BB IBB HBP BLK WP HR S P ERA WHIP										

livebaseballscorecards.com

<b>AB</b>	32
<b>R</b>	2
<b>H</b>	8
<b>RBI</b>	2
<b>BB</b>	2
<b>SO</b>	2
<b>LOB</b>	12





Batter	1	2	3	4	5	6	7	8	9	AB R H RBI BB SO LOB	TOP																													
Whitey Lockman, L (1, 3) OBP: 0.323, SLG: 0.410	0-0 4-3		0-0 1B		0-0 F2		0-0 FC6-4 1B		0-0 1-3	5 0 2 0 0 0 0																														
Alvin Dark, R (1, 6) OBP: 0.313, SLG: 0.420	0-0 6-3		0-0 F5		0-0 F8		0-0 FC6-4 1-2f			4 0 0 0 0 0 2																														
Don Mueller, L (1, 9) OBP: 0.359, SLG: 0.438	0-0 1B			0-0 F6		0-0 FC4-6 1B		0-0 F8		4 0 2 0 0 0 0																														
Monte Irvin, R (1, 7) OBP: 0.389, SLG: 0.492	0-0 6-3			0-0 E4 F9 1B		0-0 FC4-6 1-2f BB		0-0 HR 1B		4 2 2 0 0 0 2																														
Willie Mays, R (1, 8) OBP: 0.399, SLG: 0.706		0-0 G1-6-3 1B		4-0 F9 1B BB		4-0 1-2 BB		0-0 1-H HR		2 2 2 2 2 0 0																														
Davey Williams, R (1, 4) OBP: 0.294, SLG: 0.342		0-0 G1-6-3 1-2f		0-0 F9 1-2 2-3		0-0 F4		0-0 4-3		4 0 0 0 0 0 5																														
Hank Thompson, L (1, 5) OBP: 0.375, SLG: 0.444		0-3 K		0-0 2-H 3-H 1B		0-0 3-1		0-3 K		4 0 1 2 0 2 2																														
Wes Westrum, R (1, 2) OBP: 0.309, SLG: 0.335			0-0 F4		0-0 F6		0-3 K		0-3 K	4 0 0 0 0 2 1																														
Don Liddle, L (1, 1) OBP: 0.250, SLG: 0.182			0-3 K		0-0 F7		0-0 6-3		0-3 K	2 0 0 0 0 0 1 0																														
Bobby Hofman, R (7, PH) OBP: 0.229, SLG: 0.435										1 0 0 0 0 0 0 0																														
Ramon Montant, R (7, 1) OBP: 0.095, SLG: 0.095										0 0 0 0 0 0 0 0																														
Al Corwin, R (7, 1) OBP: 0.095, SLG: 0.095										0 0 0 0 0 0 0 0																														
Marv Grissom, R (8, 1) OBP: 0.095, SLG: 0.095										0 0 0 0 0 0 0 0																														
Ray Katt, F (9, PH) OBP: 0.330, SLG: 0.383										1 0 0 0 0 0 1 0																														
<b>Inning Stats</b>	R: 0 E: 0 K: 0 S: 4	H: 1 LOB: 1 BB: 0 P: 4	R: 0 E: 0 K: 1 S: 5	H: 1 LOB: 0 BB: 0 P: 5	R: 0 E: 0 K: 1 S: 6	H: 1 LOB: 1 BB: 0 P: 6	R: 2 E: 1 K: 0 S: 5	H: 2 LOB: 1 BB: 1 P: 9	R: 0 E: 0 K: 0 S: 3	H: 0 LOB: 0 BB: 0 P: 3	R: 0 E: 0 K: 0 S: 4	H: 1 LOB: 2 BB: 1 P: 8	R: 0 E: 0 K: 1 S: 6	H: 1 LOB: 1 BB: 0 P: 6	R: 2 E: 0 K: 1 S: 7	H: 2 LOB: 0 BB: 0 P: 7	R: 0 E: 0 K: 2 S: 7	H: 0 LOB: 0 BB: 0 P: 7	1B: 8 2B: 0 3B: 0 HR: 1	SF: 0 SAC: 0 DP: 1 HBP: 0	WP: 0 PB: 0 SB: 0 CS: 0	PA: 37																		
<b>PITCHER</b> Warren Spahn, L (1, 1) ERA: 3.44	IP 9.0	WLS W	BF 37	H 9	R 4	ER 4	SO 6	BB 2	IBB 0	HBP 0	BLK 0	WP 0	HR 1	S 47	P 55	ERA 4.00	WHIP 1.222						<b>PITCHER</b>	IP 9.0	WLS W	BF 37	H 9	R 4	ER 4	SO 6	BB 2	IBB 0	HBP 0	BLK 0	WP 0	HR 1	S 47	P 55	ERA 4.00	WHIP 1.222

New York Giants @ Milwaukee Braves  
Milwaukee County Stadium, Milwaukee, WI

Sat Jul 24 1954, 4:33 AM EDT  
Att: 37,768 - Unknown

livebaseballscorecards.com

AB	35
R	4
H	9
RBI	4
BB	2
SO	6
LOB	12



Batter	1	2	3	4	5	6	7	8	9
<b>Jim Pendleton, R</b> (1, 8) <small>OBP: 0.223, SLG: 0.265</small> <b>Bill Bruton, L</b> (7, 8) <small>OBP: 0.337, SLG: 0.325</small>	0-3 <b>K</b>		0-0 <b>HR</b> 1B		0-0 <b>F9</b>	0-0 <b>6-3</b>		0-0 <b>1B</b>	
<b>Danny O'Connell, R</b> (1, 4) <small>OBP: 0.318, SLG: 0.346</small>	0-0 <b>FC3-6</b> 1B		0-0 <b>F9</b>		0-0 <b>S</b> 2B		0-0 <b>G4-6-3</b> BB 1B	0-0 <b>F9</b>	
<b>Eddie Mathews, L</b> (1, 5) <small>OBP: 0.393, SLG: 0.556</small>	0-0 <b>FC3-6</b> 1-2f		0-0 <b>1-H</b> <b>HR</b>		4-0 <b>2-3</b> BB		4-0 <b>1-2</b> <b>G4-6-3</b> BB		
<b>Hank Aaron, R</b> (1, 7) <small>OBP: 0.312, SLG: 0.437</small>	0-0 <b>F9</b>		0-0 <b>F7</b>		0-0 <b>F7</b>		0-0 <b>G4-6-3</b> 1-2f 2-3		
<b>Joe Adcock, R</b> (1, 3) <small>OBP: 0.369, SLG: 0.512</small>		0-0 <b>F8</b>		0-0 <b>6-3</b>		0-0 <b>SH5-4</b> 1B	0-0 <b>5-3</b>		
<b>Andy Pafko, R</b> (1, 9) <small>OBP: 0.330, SLG: 0.423</small>		4-0 <b>CS</b> BB		0-0 <b>FC6-4</b> 1B		0-0 <b>SH5-4</b> 2-3		0-0 <b>F9</b>	
<b>Johnny Logan, R</b> (1, 6) <small>OBP: 0.333, SLG: 0.389</small>		0-3 <b>K</b> 1-2		0-0 <b>F8</b>		0-3 <b>K</b>		0-0 <b>6-3</b>	
<b>Del Crandall, R</b> (1, 2) <small>OBP: 0.304, SLG: 0.418</small>			0-0 <b>1B</b> 3B		0-0 <b>FC6-4</b> 1-2f		4-0 <b>1B</b> IBB	0-0 <b>BB</b> 1B	
<b>Warren Spahn, L</b> (1, 1) <small>OBP: 0.344, SLG: 0.404</small>			0-0 <b>F8</b>		0-0 <b>F2</b>		0-0 <b>1-3</b> 3-H 1B	4-0 <b>1-2</b> 1B BB	

Inning Stats	R: 0 E: 0 K: 1 S: 6	H: 1 LOB: 1 BB: 0 P: 6	R: 0 E: 0 K: 1 S: 4	H: 0 LOB: 1 BB: 1 P: 8	R: 3 E: 0 K: 0 S: 6	H: 3 LOB: 0 BB: 0 P: 6	R: 0 E: 0 K: 0 S: 4	H: 1 LOB: 1 BB: 0 P: 4	R: 0 E: 0 K: 0 S: 4	H: 1 LOB: 2 BB: 1 P: 8	R: 1 E: 1 K: 1 S: 7	H: 2 LOB: 2 BB: 1 P: 11	R: 0 E: 0 K: 0 S: 3	H: 1 LOB: 1 BB: 1 P: 7	R: 1 E: 0 K: 0 S: 5	H: 2 LOB: 2 BB: 1 P: 9
1B: 8 2B: 2 3B: 1 HR: 1	SF: 0 SAC: 1 DP: 2 HBP: 0	WP: 0 PB: 0 SB: 1 CS: 1	PA: 38													

PITCHER	IP	WLS	BF	H	R	ER	SO	BB	IBB	HBP	BLK	WP	HR	S	P	ERA	WHIP
<b>Don Liddle, L</b> (1, 1) <small>ERA: 2.57</small>	6.0		28	8	4	4	3	2	1	0	0	0	1	31	43	6.00	1.667
<b>Ramon Monzant, R</b> (7, 1) <small>ERA: 4.7</small>	0.0		2	1	0	0	0	1	0	0	0	0	0	1	5	∞	∞
<b>Al Corwin, R</b> (7, 1) <small>ERA: 3.68</small>	1.2	L	6	1	1	1	0	1	0	0	0	0	0	5	9	5.40	1.200
<b>Mary Grissom, R</b> (8, 1) <small>ERA: 2.03</small>	0.1		2	1	0	0	0	0	0	0	0	0	0	2	2	0.00	3.000

**BOTTOM**

**New York Giants @ Milwaukee Braves**  
**Milwaukee County Stadium, Milwaukee, WI**  
 Sat Jul 24 1954, 4:33 AM EDT  
 Att. 37,768 - Unknown

livebaseballscores.com

<b>AB</b>	<b>32</b>
<b>R</b>	<b>5</b>
<b>H</b>	<b>11</b>
<b>RBI</b>	<b>5</b>
<b>BB</b>	<b>5</b>
<b>SO</b>	<b>3</b>
<b>LOB</b>	<b>17</b>



Batter	1	2	3	4	5	6	7	8	9	AB R H RBI BB SO LOB	TOP																
Whitey Lockman, L (1, 3) OBP: 0.329, SLG: 0.414	0-0 E7 1B		0-0 2B 1B	4-0 G6-4-3 BB			0-0 1B 1B	0-0 E3		4 2 3 0 1 0 1	<b>New York Giants @ Milwaukee Braves</b> <b>Milwaukee County Stadium, Milwaukee, WI</b> Sun Jul 25 1954, 4:33 AM EDT Att: 44,279 - Unknown																
Alvin Dark, R (1, 6) OBP: 0.312, SLG: 0.417	0-3 K		0-0 F8	0-0 G6-4-3 1-2f			0-0 1B 1B	0-0 F9		5 0 1 0 0 1 8																	
Don Mueller, L (1, 9) OBP: 0.357, SLG: 0.437	0-0 F8		0-0 1B 2B		0-0 F8		0-0 F5		0-0 4-3	5 1 1 1 0 0 3																	
Hank Thompson, L (1, 5) OBP: 0.373, SLG: 0.440	0-0 F9		0-0 FC4 1B		0-0 4-3		0-0 F9		0-0 F2	5 0 1 2 0 0 3																	
Willie Mays, R (1, 8) OBP: 0.396, SLG: 0.699		0-3 K	0-0 FC4 1-2f		0-0 6-3		0-0 FC6-4 1B		0-0 F4	5 0 1 1 0 1 1																	
Monte Irvin, R (1, 7) OBP: 0.387, SLG: 0.488	0-0 5-3			4-0 1B 1B BB		0-0 F8	0-0 FC6-4 1-2f			3 1 0 0 1 0 2																	
Davey Williams, R (1, 4) OBP: 0.294, SLG: 0.341	0-0 6-3			0-0 SH5-4 1B 1B		0-0 F9		0-0 F6		4 0 1 0 0 0 0																	
Wes Westrum, R (1, 2) OBP: 0.319, SLG: 0.343			4-0 1B 2B BB	0-0 SH5-4 1B		0-0 1B		4-0 E BB		2 1 2 1 1 0 0																	
Dusty Rhodes, L (8, PH) OBP: 0.481, SLG: 0.735				0-0 SH5-4 1B		0-0 K		0-0 F7		0 0 0 0 1 0 0																	
Ray Katt, R (8, 2) OBP: 0.330, SLG: 0.383				0-0 F9		0-3 K				0 0 0 0 0 0 0																	
Johnny Antonelli, L (1, 1) OBP: 0.188, SLG: 0.254			0-0 F9	0-0 SH5-4						1 0 0 0 0 0 1																	
Jim Hearn, R (4, 1) OBP: 0.200, SLG: 0.250										1 0 0 0 0 1 1																	
Ruben Gomez, R (6, 1) OBP: 0.178, SLG: 0.178										0 0 0 0 0 0 0																	
Bill Taylor, L (8, PH) OBP: 0.260, SLG: 0.289										1 0 0 0 0 0 1																	
Windy McCall, L (8, 1) OBP: 0.260, SLG: 0.289										0 0 0 0 0 0 0																	
<b>Inning Stats</b>	R: 0 E: 1 K: 1 S: 6	H: 1 LOB: 1 BB: 0 P: 6	R: 0 E: 0 K: 1 S: 5	H: 0 LOB: 0 BB: 0 P: 5	R: 3 E: 0 K: 0 S: 6	H: 3 LOB: 1 BB: 1 P: 10	R: 1 E: 0 K: 0 S: 4	H: 2 LOB: 2 BB: 2 P: 12	R: 0 E: 0 K: 0 S: 3	H: 0 LOB: 0 BB: 0 P: 3	R: 0 E: 0 K: 1 S: 6	H: 1 LOB: 1 BB: 0 P: 6	R: 1 E: 0 K: 0 S: 6	H: 3 LOB: 2 BB: 0 P: 6	R: 0 E: 1 K: 0 S: 4	H: 0 LOB: 2 BB: 1 P: 8	R: 0 E: 0 K: 0 S: 3	H: 0 LOB: 0 BB: 0 P: 3	1B: 9 2B: 1 3B: 0 HR: 0	SF: 0 SAC: 1 DP: 1 HBP: 0	WP: 0 PB: 0 SB: 0 CS: 0	PA: 41					
<b>PITCHER</b>	IP WLS BF H R ER SO BB IBB HBP BLK WP HR S P ERA WHIP																										
Jim Wilson, R (1, 1) ERA: 3.28	3.0		17	6	4	4	2	2	0	0	0	0	0	19	27	12.00	2.667										
Chet Nichols, L (4, 1) ERA: 3.89	1.0		3	0	0	0	0	1	0	0	0	0	0	2	6	0.00	1.000										
Dave Jolly, R (5, 1) ERA: 1.47	5.0	W	21	4	1	1	1	1	0	0	0	0	0	22	26	1.80	1.000										

livebaseballscorecards.com

<b>AB</b>	<b>36</b>
<b>R</b>	<b>5</b>
<b>H</b>	<b>10</b>
<b>RBI</b>	<b>5</b>
<b>BB</b>	<b>4</b>
<b>SO</b>	<b>3</b>
<b>LOB</b>	<b>21</b>





BOTTOM

New York Giants @ Milwaukee Braves  
Milwaukee County Stadium, Milwaukee, WI

AB 32  
R 7  
H 12  
RBI 7  
BB 6  
SO 4  
LOB 17



WP: 0 PA: 39  
PB: 0  
SB: 1  
CS: 0

Sun Jul 25 1954, 4:33 AM EDT  
Att. 44,279 - Unknown

livebaseballscorecards.com

AB	R	H	RBI	BB	SO	LOB
2	0	1	0	0	0	0
3	1	2	0	0	0	2
3	0	0	1	1	1	1
3	1	1	1	2	1	0
4	1	1	0	0	0	5
2	1	0	0	2	1	0
4	2	3	3	0	0	0
3	0	1	1	1	0	2
4	1	3	1	0	0	2
1	0	0	0	0	0	1
0	0	0	0	0	0	0
1	0	0	0	0	0	2
2	0	0	0	0	1	2
1B: 10	SF: 1	WP: 0	PA: 39			
2B: 1	SAC: 0	PB: 0				
3B: 0	DP: 3	SB: 1				
HR: 1	HBP: 0	CS: 0				

Batter	1	2	3	4	5	6	7	8	9
<b>Jim Pendleton, R</b> (1, 8) OBP: 0.228, SLG: 0.269 <b>Bill Bruton, L</b> (5, PH) OBP: 0.340, SLG: 0.331 (6, 8)	0-0 F8		0-0 BB BB 1-2 1B		0-0 5-3 1B	0-0 G6-3 1-2f		0-0 S SF8 2B	
<b>Danny O'Connell, R</b> (1, 4) OBP: 0.316, SLG: 0.344	0-0 1-3		4-0 FC5 BB 1-2 2-3 BB		0-0 5-3 1-2		0-3 K	0-0 SF8 2-H	
<b>Eddie Mathews, L</b> (1, 5) OBP: 0.396, SLG: 0.554	0-0 6-3		4-0 BB BB 1-2 2-3 3-H BB		4-0 G6-4-3 BB		0-0 E8 1B 1B	0-3 K	
<b>Hank Aaron, R</b> (1, 7) OBP: 0.311, SLG: 0.435		0-0 5-3	0-0 FC5 2-3f		0-0 G6-4-3 1-2f		0-0 1B 1B		
<b>Joe Adcock, R</b> (1, 3) OBP: 0.370, SLG: 0.509		0-3 K		0-0 F5		4-0 1B 1B BB	4-0 1B 1B		
<b>Andy Pafko, R</b> (1, 9) OBP: 0.335, SLG: 0.436		0-0 F9		0-0 HR		0-0 1B 1-3 1B	0-0 1-2 2-H 3-H 1B		
<b>Johnny Logan, R</b> (1, 6) OBP: 0.335, SLG: 0.389			0-0 6-3	4-0 1B BB		0-0 FC3-6 1-3 3-H 1B	0-0 F5		
<b>Del Crandall, R</b> (1, 2) OBP: 0.311, SLG: 0.423			0-0 BB BB 1B	0-0 G5-4-3 1-2 1B		0-0 FC3-6 1-2 3-H 1B	0-0 F5		
<b>Jim Wilson, R</b> (1, 1) OBP: 0.241, SLG: 0.286 <b>Chet Nichols, S</b> (4, 1) OBP: 0.120, SLG: 0.120 <b>Bobby Thomson, R</b> (4, PH) OBP: 0.667, SLG: 0.600 <b>Dave Jolly, R</b> (5, 1) OBP: 0.450, SLG: 0.632			0-0 F4	0-0 G5-4-3 1-2f		0-0 FC3-6 G6-3 1-2f 2-3		0-3 K	

Inning Stats	R: 0	H: 0	E: 0	K: 0	S: 3	LOB: 0	BB: 0	P: 3
	0	0	0	0	3	0	0	3
	0	0	0	0	5	0	0	5
	1	2	0	1	5	3	2	13
	1	2	0	0	4	1	1	8
	0	1	0	0	3	1	1	7
	2	3	0	0	5	1	1	9
	2	3	1	1	8	2	1	12
	1	1	0	0	8	0	0	8

PITCHER	IP	WLS	BF	H	R	ER	SO	BB	IBB	HBP	BLK	WP	HR	S	P	ERA	WHIP
<b>Johnny Antonelli, L</b> (1, 1) ERA: 2.27	3.1		17	4	2	2	1	3	0	0	0	0	1	16	28	5.40	2.100
<b>Jim Hearn, R</b> (4, 1) ERA: 4.18	1.2		8	3	2	2	0	2	0	0	0	0	0	6	14	10.80	3.000
<b>Ruben Gomez, R</b> (6, 1) ERA: 3.27	2.0	L	10	4	2	2	1	0	1	0	0	0	0	11	15	9.00	2.000
<b>Windy McCall, L</b> (8, 1) ERA: 3.15	1.0		4	1	1	1	2	0	0	0	0	0	0	8	8	9.00	1.000

Batter	1	2	3	4	5	6	7	8	9	AB R H RBI BB SO LOB	TOP																						
Whitey Lockman, L (1, 3) OBP: 0.328, SLG: 0.415	1-2 L7			1-3 K		1-1 G3		1-0 2B		4 0 1 0 0 1 0																							
Alvin Dark, R (1, 6) OBP: 0.311, SLG: 0.414	4-1 G1-6-3 BB			1-1 F9		2-2 6-3		2-1 F5		3 0 0 0 1 0 1																							
Don Mueller, L (1, 9) OBP: 0.359, SLG: 0.436	2-2 G1-6-3 1-2f			0-1 2B E 1B		4-0 BB		0-2 G3		3 1 1 0 1 0 2																							
Hank Thompson, L (1, 5) OBP: 0.372, SLG: 0.441		0-0 F9		0-0 E9 1-H 2B		2-3 K		2-1 1-3		4 0 1 0 0 1 1																							
Willie Mays, R (1, 8) OBP: 0.393, SLG: 0.691		1-0 6-3		2-2 L9		1-0 F8		2-1 E6 4-3 FC4		4 0 0 0 0 0 1																							
Monte Irvin, R (1, 7) OBP: 0.386, SLG: 0.485		3-3 K		0-1 L7		2-1 3-1 BB 1B		1-2 FC4 4-3		4 0 1 0 0 1 1																							
Davey Williams, R (1, 4) OBP: 0.296, SLG: 0.341			1-0 F9		1-0 1B		4-1 1-2 BB		1-0 4-3	3 0 1 0 1 0 2																							
Wes Westrum, R (1, 2) OBP: 0.316, SLG: 0.339			2-3 K		2-1 F8		1-2 3-1 SAFE		1-1 F9	2 0 0 0 0 1 1																							
Dusty Rhodes, L (7, PH) OBP: 0.473, SLG: 0.720										1 0 0 0 0 0 2																							
Ray Katt, R (7, 2) OBP: 0.327, SLG: 0.379										1 0 0 0 0 0 2																							
Sal Maglie, R (1, 1) OBP: 0.149, SLG: 0.091			2-1 F6		1-3 K			0-3 K		2 0 0 0 0 1 1																							
Hoyt Wilhelm, R (6, 1)										0 0 0 0 0 0 0																							
Paul Giel, R (6, 1)										0 0 0 0 0 0 0																							
Bill Taylor, L (8, PH) OBP: 0.255, SLG: 0.283										1 0 0 0 0 1 0																							
Al Corwin, R (8, 1)										0 0 0 0 0 0 0																							
<b>Inning Stats</b>	R: 0 E: 0 K: 0 S: 7	H: 0 LOB: 0 BB: 1 P: 14	R: 0 E: 0 K: 1 S: 8	H: 0 LOB: 0 BB: 0 P: 12	R: 0 E: 0 K: 1 S: 6	H: 0 LOB: 0 BB: 0 P: 11	R: 1 E: 1 K: 1 S: 13	H: 2 LOB: 1 BB: 0 P: 17	R: 0 E: 0 K: 1 S: 8	H: 1 LOB: 1 BB: 1 P: 12	R: 0 E: 0 K: 1 S: 8	H: 0 LOB: 1 BB: 1 P: 17	R: 0 E: 0 K: 0 S: 7	H: 1 LOB: 1 BB: 1 P: 15	R: 0 E: 0 K: 1 S: 9	H: 1 LOB: 1 BB: 0 P: 12	R: 0 E: 1 K: 0 S: 11	H: 0 LOB: 2 BB: 0 P: 18	1B: 3 2B: 2 3B: 0 HR: 0	SF: 0 SAC: 0 DP: 1 HBP: 0	WP: 0 PB: 0 SB: 0 CS: 0	PA: 35											
<b>PITCHER</b> Carl Erskine, R (1, 1) ERA: 3.59	IP 9.0	WLS W	BF 35	H 5	R 1	ER 0	SO 6	BB 3	IBB 0	HBP 0	BLK 0	WP 0	HR 0	S 77	P 128	ERA 0.00	WHIP 0.889																
											<b>PITCHER</b>	IP	WLS	BF	H	R	ER	SO	BB	IBB	HBP	BLK	WP	HR	S	P	ERA	WHIP					

**New York Giants @ Brooklyn Dodgers**  
 Ebbets Field, Brooklyn, NY  
 Mon Jul 26 1954, 3:33 AM EDT  
 Att: 33,251 - Unknown

livebaseballscorecards.com

AB	32
R	1
H	5
RBI	0
BB	3
SO	6
LOB	14



BOTTOM

New York Giants @ Brooklyn Dodgers  
Ebbets Field, Brooklyn, NY  
Mon Jul 26 1954, 3:33 AM EDT  
Att. 33,251 - Unknown

livebaseballscorecards.com

AB	37
R	9
H	15
RBI	8
BB	8
SO	3
LOB	23



WP:	0	PA:	47
PB:	1	SB:	0
CS:	0		

AB R H RBI BB SO LOB

3 0 1 0 1 0 1  
2 2 1 0 0 0 2

5 1 3 1 1 1 2

2 2 0 0 3 0 4

3 1 1 3 1 0 0

5 1 2 1 0 1 5

5 0 3 2 0 0 2  
0 1 0 0 0 0 0

4 0 2 0 1 0 1

4 0 0 0 1 1 4

4 1 2 1 0 0 2

1B: 11 SF: 2  
2B: 3 SAC: 0  
3B: 1 DP: 0  
HR: 0 HBP: 0

Batter	1	2	3	4	5	6	7	8	9
<b>Jim Gilliam, S</b> (1, 4) OBP: 0.350, SLG: 0.426 <b>Billy Cox, R</b> (6, PR) OBP: 0.299, SLG: 0.319 (7, 4)	3-1 F9	0-0 BB 1B		0-1 F8		4-1 1B BB	2-2 PB 1B SF8 1B	1-0 F5	
<b>Pee Wee Reese, R</b> (1, 6) OBP: 0.389, SLG: 0.458	1-2 F2	4-1 BB		1-1 E2 1B		0-0 BB BB BLK 1B	1-0 SF8 PB 1B	2-3 K	
<b>Duke Snider, L</b> (1, 8) OBP: 0.448, SLG: 0.686	4-1 2B BB	0-0 4-3		1-0 G3		4-2 BLK BB 6-3 BB	4-0 SF8 IBB		
<b>Gil Hodges, R</b> (1, 3) OBP: 0.379, SLG: 0.583	1-0 1B 2B		3-2 F8		0-0 F4	4-1 6-3 BLK BB	0-1 SF8		
<b>Sandy Amoros, L</b> (1, 7) OBP: 0.241, SLG: 0.373	0-0 1B		0-0 F8		0-1 1B 3B	1-3 K	3-2 G2		
<b>Jackie Robinson, R</b> (1, 5) OBP: 0.418, SLG: 0.514 <b>Don Hoak, R</b> (8, PR) OBP: 0.319, SLG: 0.412 (9, 5)	0-0 F7		1-0 2B		3-2 1B 1B	1-2 6-3		1-0 BB 1B SF8 1B	
<b>Carl Furillo, R</b> (1, 9) OBP: 0.352, SLG: 0.408		0-1 5-3	0-0 6-3		0-1 1B	4-1 BB		0-0 BB 1B	
<b>Roy Campanella, R</b> (1, 2) OBP: 0.270, SLG: 0.424		1-0 5-3		0-0 F5	2-2 F2	3-3 K		4-0 BB	
<b>Carl Erskine, R</b> (1, 1) OBP: 0.188, SLG: 0.169		0-1 BB 1B 1B		2-1 E 2B	0-0 F4		1-2 F3	2-0 SF8	

Inning	R	H	E	K	S	R	H	E	K	S	R	H	E	K	S	R	H	E	K	S
1	2	2	0	9	18	0	2	0	8	13	0	1	0	8	12	1	3	0	13	18
2	0	0	0	0	0	0	0	0	0	0	0	0	0	0	0	0	0	0	0	0
3	0	1	0	0	10	0	1	0	0	10	0	0	0	0	0	0	0	0	0	0
4	1	2	1	0	12	1	2	0	8	12	1	3	0	13	18	3	1	4	24	36
5	1	3	0	0	18	0	0	0	13	18	0	0	0	0	0	0	0	0	0	0
6	3	1	0	2	36	0	1	0	15	36	0	1	0	13	24	1	2	2	24	36
7	1	2	0	0	24	0	2	0	13	24	0	2	0	13	24	1	2	1	24	36
8	0	2	0	1	17	0	2	0	7	17	0	2	0	7	17	0	2	0	7	17
9	0	0	0	0	0	0	0	0	0	0	0	0	0	0	0	0	0	0	0	0

PITCHER	IP	WLS	BF	H	R	ER	SO	BB	IBB	HBP	BLK	WP	HR	S	P	ERA	WHIP
<b>Sal Maglie, R</b> (1, 1) ERA: 3.51	5.0	L	29	11	6	6	0	3	0	0	0	0	0	46	77	10.80	2.800
<b>Hoyt Wilhelm, R</b> (6, 1) ERA: 3.21	0.2		5	0	1	1	1	3	0	0	1	0	0	10	24	13.50	4.500
<b>Paul Giel, R</b> (6, 1) ERA: 11.57	1.1		7	2	1	1	1	0	1	0	0	0	0	16	30	6.75	1.500
<b>Al Corwin, R</b> (8, 1) ERA: 4.02	1.0		6	2	1	1	1	1	0	0	0	0	0	7	17	9.00	3.000



Batter	1	2	3	4	5	6	7	8	9	AB R H RBI BB SO LOB
Whitey Lockman, L (1, 3) OBP: 0.329, SLG: 0.415	0-0 6-3 1B	0-0 1B			0-0 F7		0-0 FC4-6 1B		0-0 4-3	5 0 2 1 0 0 0
Don Mueller, L (1, 9) OBP: 0.357, SLG: 0.433	0-0 1B	0-0 F9			0-0 F7		0-0 FC4-6 5-3		0-0 F9	5 0 1 0 0 0 2
Willie Mays, R (1, 8) OBP: 0.393, SLG: 0.696	0-3 K		0-0 1B SF8		0-0 6-3		0-0 5-3		0-0 HR	5 2 2 1 0 1 2
Dusty Rhodes, L (1, 7) OBP: 0.500, SLG: 0.778	0-0 BB 1B		0-0 1B G6-4-3		0-0 HR		4-0 IBB		0-0 F2	4 1 3 1 1 0 0
Hank Thompson, L (1, 5) OBP: 0.373, SLG: 0.439	4-0 BB		0-0 SF8		4-0 BB BB		0-3 K			1 0 0 1 2 1 2
Alvin Dark, R (1, 6) OBP: 0.309, SLG: 0.411	0-3 K		0-0 G6-4-3		0-0 F9		0-0 F7			4 0 0 0 0 1 5
Bobby Hofman, R (1, 4) OBP: 0.269, SLG: 0.469		0-0 1B E		1-0 HBP G6-4-3		0-0 F8		0-0 2B		3 1 2 0 0 0 1
Wes Westrum, R (1, 2) OBP: 0.315, SLG: 0.333		0-0 FC5 1B		0-0 F2		4-0 BB		0-0 5-3		3 0 0 0 1 0 3
Jim Hearn, R (1, 1) OBP: 0.189, SLG: 0.235		0-3 K		0-0 G6-4-3		0-0 4-3		0-0 F3		2 0 0 0 0 1 3
Bill Taylor, L (6, PH) OBP: 0.250, SLG: 0.277										1 0 0 0 0 0 2
Ruben Gomez, R (7, 1) OBP: 0.178, SLG: 0.178										0 0 0 0 0 0 0
Monte Irvin, R (8, PH) OBP: 0.385, SLG: 0.483										1 0 0 0 0 0 1
Mary Grissom, R (9, 1) OBP: 0.095, SLG: 0.095										0 0 0 0 0 0 0

Inning Stats	R: 0 E: 0 K: 2 S: 9	H: 2 LOB: 3 BB: 1 P: 13	R: 1 E: 1 K: 1 S: 7	H: 2 LOB: 1 BB: 0 P: 7	R: 1 E: 0 K: 0 S: 4	H: 2 LOB: 0 BB: 0 P: 4	R: 0 E: 0 K: 0 S: 2	H: 0 LOB: 0 BB: 0 P: 3	R: 0 E: 0 K: 0 S: 3	H: 0 LOB: 0 BB: 0 P: 3	R: 1 E: 0 K: 1 S: 4	H: 1 LOB: 2 BB: 2 P: 12	R: 0 E: 0 K: 1 S: 6	H: 1 LOB: 2 BB: 1 P: 10	R: 0 E: 0 K: 0 S: 4	H: 1 LOB: 1 BB: 0 P: 4	R: 1 E: 0 K: 0 S: 4	H: 1 LOB: 0 BB: 0 P: 4	1B: 7 2B: 1 3B: 0 HR: 2	SF: 1 SAC: 0 DP: 2 HBP: 1	WP: 0 PB: 0 SB: 0 CS: 0	PA: 40	
PITCHER	IP	WLS	BF	H	R	ER	SO	BB	IBB	HBP	BLK	WP	HR	S	P	ERA	WHIP						
Ralph Beard, R (1, 1) ERA: 1.99	3.0		15	6	2	1	3	1	0	0	0	0	0	20	24	3.00	2.333						
Brooks Lawrence, R (4, 1) ERA: 3.06	5.0	W	21	3	1	1	1	2	1	1	0	0	1	19	32	1.80	1.000						
Harvey Haddix, L (9, 1) ERA: 3.14	1.0	S	4	1	1	1	0	0	0	0	0	0	1	4	4	9.00	1.000						

BOTTOM

St. Louis Cardinals @ New York Giants  
Polo Grounds, New York, NY  
Tue Jul 27 1954, 3:33 AM EDT  
Att. 21,716 - Unknown

livebaseballscorecards.com

AB	34
R	4
H	10
RBI	4
BB	4
SO	4
LOB	21



Batter	1	2	3	4	5	6	7	8	9	AB R H RBI BB SO LOB	TOP																						
Rip Repulski, R (1, 7) OBP: 0.321, SLG: 0.458	0-0 4-3		0-0 FC5-4 1B		0-0 F7		0-0 1-3		0-0 FC5-4 1-2f	5 0 1 0 0 0 4																							
Wally Moon, L (1, 8) OBP: 0.396, SLG: 0.489	0-0 CS 1B		0-0 FC5-4 1B		0-0 4-3			0-0 4-3		4 0 2 0 0 0 1																							
Red Schoendienst, S (1, 4) OBP: 0.377, SLG: 0.470	0-0 F3 1-2		0-0 FC5-4 1-2 2-3		0-0 F7			0-0 4-3		4 0 0 0 0 0 3																							
Stan Musial, L (1, 9) OBP: 0.440, SLG: 0.649		0-0 F7	0-0 4-1		0-0 F9			0-0 E 1B		4 0 1 0 0 0 1																							
Ray Jablonski, R (1, 5) OBP: 0.367, SLG: 0.475		0-0 5-3		0-0 F3		0-0 6-3		0-0 E6 1-2		4 0 0 0 0 0 1																							
Bill Sarni, R (1, 2) OBP: 0.348, SLG: 0.464		0-0 BB 1B		0-0 F8			0-0 1B 1B	0-3 K		4 0 2 0 0 1 2																							
Joe Cunningham, L (1, 3) OBP: 0.361, SLG: 0.505		0-0 BB 1B		0-0 F7			0-0 F2		0-0 F5	4 0 1 0 0 0 1																							
Alex Grammas, R (1, 6) OBP: 0.290, SLG: 0.278		4-0 BB 1-2 2-3			0-0 FC6-4 1B		0-0 F3		0-0 F8	3 0 1 0 1 0 1																							
Tom Poholsky, R (1, 1) OBP: 0.156, SLG: 0.167					0-0 FC6-4 1-2f		0-0 1B		0-0 FC5-4 1B	1 0 0 0 0 0 0 3																							
Peanuts Lowrey, R (5, PH) OBP: 0.260, SLG: 0.262										1 0 0 0 0 0 0 1																							
Al Brazle, L (5, 1)										0 0 0 0 0 0 0 0																							
Sal Yvars, R (7, PH) OBP: 0.370, SLG: 0.489										1 0 1 0 0 0 0 0																							
Harvey Haddix, L (7, PR) OBP: 0.254, SLG: 0.286										0 0 0 0 0 0 0 0																							
Royce Lint, L (7, 1) OBP: 0.455, SLG: 0.286										0 0 0 0 0 0 0 0																							
Del Rice, R (9, PH) OBP: 0.294, SLG: 0.374										1 0 1 0 0 0 0 0																							
Solly Hemus, L (9, PR) OBP: 0.455, SLG: 0.465										0 0 0 0 0 0 0 0																							
<b>Inning Stats</b>	R: 0 E: 0 K: 0 S: 3	H: 1 LOB: 0 BB: 0 P: 3	R: 0 E: 0 K: 0 S: 5	H: 2 LOB: 3 BB: 1 P: 9	R: 0 E: 0 K: 0 S: 4	H: 2 LOB: 1 BB: 0 P: 4	R: 0 E: 0 K: 0 S: 3	H: 0 LOB: 0 BB: 0 P: 3	R: 0 E: 0 K: 0 S: 4	H: 1 LOB: 1 BB: 0 P: 4	R: 0 E: 0 K: 0 S: 3	H: 0 LOB: 0 BB: 0 P: 3	R: 0 E: 1 K: 1 S: 7	H: 2 LOB: 2 BB: 0 P: 5	R: 0 E: 1 K: 1 S: 7	H: 1 LOB: 2 BB: 0 P: 7	R: 0 E: 0 K: 0 S: 4	H: 1 LOB: 1 BB: 0 P: 4	1B: 10 2B: 0 3B: 0 HR: 0	SF: 0 SAC: 0 DP: 1 HBP: 0	WP: 0 PB: 0 SB: 0 CS: 1	PA: 37											
<b>PITCHER</b> Johnny Antonelli, L (1, 1) ERA: 2.16	IP 9.0	WLS W	BF 37	H 10	R 0	ER 0	SO 1	BB 1	IBB 0	HBP 0	BLK 0	WP 0	HR 0	S 38	P 42	ERA 0.00	WHIP 1.222																
											<b>PITCHER</b>	IP	WLS	BF	H	R	ER	SO	BB	IBB	HBP	BLK	WP	HR	S	P	ERA	WHIP					

St. Louis Cardinals @ New York Giants  
Polo Grounds, New York, NY  
Wed Jul 28 1954, 3:33 AM EDT  
Att: 10,856 - Unknown

livebaseballscorecards.com

AB	36
R	0
H	10
RBI	0
BB	1
SO	1
LOB	18



Batter	1	2	3	4	5	6	7	8	9
Whitey Lockman, L (1, 3) OBP: 0.332, SLG: 0.415	0-0 G1-6-3 1B		0-0 G3		4-0 BB		0-0 4-3	0-0 3-1 1B	
Don Mueller, L (1, 9) OBP: 0.352, SLG: 0.428	0-0 G1-6-3 1-2f			0-0 5-3	0-0 F3		0-0 1-3	0-0 3-1 1-2 2-3	
Willie Mays, R (1, 8) OBP: 0.395, SLG: 0.704	0-0 F9			0-0 S 1B 2B		0-0 HR		0-0 HR BB F6	
Dusty Rhodes, L (1, 7) OBP: 0.531, SLG: 0.947		0-0 HR		4-0 S 1B IBB		0-0 HR		0-0 1-H HR	
Hank Thompson, L (1, 5) OBP: 0.372, SLG: 0.437		0-0 F2		0-0 F9 1-2 2-3		0-0 4-3		0-0 1B HR 1B	
Bobby Hofman, R (1, 4) OBP: 0.268, SLG: 0.442		0-3 K2-3		4-0 1B BB		0-0 F3		0-0 F7	
Alvin Dark, R (1, 6) OBP: 0.313, SLG: 0.414		0-0 6-3		0-0 1-3 2-H 3-H 1B		0-0 1B		0-0 1-2 HR 1B	
Ray Katt, R (1, 2) OBP: 0.325, SLG: 0.404			0-3 K		0-0 F2	0-0 5-3		0-0 1-H 2-H HR	
Johnny Antonelli, L (1, 1) OBP: 0.192, SLG: 0.254			0-3 K		0-0 4-3		0-0 F5	0-0 3-1 1B 1B	

Inning Stats	R: 0 E: 0 K: 0 S: 3	H: 1 LOB: 0 BB: 0 P: 3	R: 1 E: 0 K: 1 S: 6	H: 1 LOB: 0 BB: 0 P: 6	R: 0 E: 0 K: 2 S: 7	H: 0 LOB: 0 BB: 0 P: 7	R: 2 E: 0 K: 0 S: 4	H: 2 LOB: 2 BB: 2 P: 12	R: 0 E: 0 K: 0 S: 3	H: 0 LOB: 1 BB: 1 P: 7	R: 2 E: 0 K: 0 S: 6	H: 3 LOB: 1 BB: 0 P: 6	R: 0 E: 0 K: 0 S: 3	H: 0 LOB: 0 BB: 0 P: 3	R: 5 E: 0 K: 0 S: 9	H: 6 LOB: 2 BB: 1 P: 13
1B: 7 2B: 1 3B: 0 HR: 5	SF: 0 SAC: 0 DP: 1 HBP: 0	WP: 0 PB: 0 SB: 2 CS: 0														

PITCHER	IP	WLS	BF	H	R	ER	SO	BB	IBB	HBP	BLK	WP	HR	S	P	ERA	WHIP
Tom Poholsky, R (1, 1) ERA: 3.32	4.0	L	16	4	3	3	3	1	1	0	0	0	1	20	28	6.75	1.250
Al Brazle, L (5, 1) ERA: 4.99	2.0		10	3	2	2	0	1	0	0	0	0	2	9	13	9.00	2.000
Royce Lint, L (7, 1) ERA: 5.33	2.0		13	6	5	5	0	1	0	0	0	0	2	12	16	22.50	3.500

BOTTOM

St. Louis Cardinals @ New York Giants  
 Polo Grounds, New York, NY  
 Wed Jul 28 1954, 3:33 AM EDT  
 Att. 10,856 - Unknown

livebaseballscorecards.com

AB	35
R	10
H	13
RBI	10
BB	4
SO	3
LOB	10



WP: 0	PA: 39
PB: 0	
SB: 2	
CS: 0	

Batter	1	2	3	4	5	6	7	8	9	AB R H RBI BB SO LOB	TOP											
Wally Moon, L OBP: 0.400, SLG: 0.490 (1, 8)	4-0 1B WP FC6 BB	0-0 F4			0-0 SH3-4 2B 1B	4-0 CS BB			0-0 1B 1B	3 3 2 0 2 0 1												
Red Schoendienst, S OBP: 0.379, SLG: 0.470 (1, 4)	0-0 FC6 1B	0-0 FC6-4			0-0 SH3-4 1-2 2-3	0-0 CS 1-2	0-0 G3		0-0 G3-6-3 1B	4 0 2 1 0 0 1												
Stan Musial, L OBP: 0.440, SLG: 0.643 (1, 9)	0-0 FC6 FC4-6 1-2f 3-H			0-0 F4	4-0 2B IBB		4-0 1B 1B BB		0-0 G3-6-3 1-2f	3 2 0 1 2 0 2												
Ray Jablonski, R OBP: 0.367, SLG: 0.477 Solly Hemus, L OBP: 0.455, SLG: 0.465 (1, 5) (9, 5)	0-0 FC4-6 1B 1-2f			0-0 F9	0-0 1B 1B 2B 1-H 2-H 3-H		0-0 1B 1B		0-0 F8	5 2 2 3 0 0 1 0 0 0 0 0 0 0												
Bill Sarni, R OBP: 0.356, SLG: 0.469 (1, 2)	0-0 1B 1B			0-0 5-3	0-0 1B 1B		0-0 1B 1B G5-4-3 1-2 2-H			4 0 3 1 0 0 0												
Rip Repulski, R OBP: 0.323, SLG: 0.458 (1, 7)	0-0 1B			0-3 K	0-0 PB 1B 1-3 3-H		0-0 G5-4-3 1-2f			4 0 2 2 0 1 2												
Joe Cunningham, L OBP: 0.356, SLG: 0.495 (1, 3)	0-0 F5			0-0 F7	0-0 F4 1-2			0-0 G6-4-3 1B		4 0 1 0 0 0 3												
Alex Grammas, R OBP: 0.289, SLG: 0.278 (1, 6)		0-0 FC6-4 1B		0-0 F9		0-0 6-3		0-0 G6-4-3 1-2f		4 0 1 0 0 0 1												
Vic Raschi, R OBP: 0.169, SLG: 0.125 (1, 1)		0-3 K		0-0 SH3-4 2B 1B	0-3 K		0-0 4-3			4 1 1 0 0 2 1												
<b>Inning Stats</b>	R: 2 E: 0 K: 0 S: 6	H: 3 LOB: 2 BB: 1 P: 10	R: 0 E: 0 K: 1 S: 6	H: 1 LOB: 1 BB: 0 P: 6	R: 0 E: 0 K: 0 S: 3	H: 0 LOB: 0 BB: 0 P: 3	R: 0 E: 0 K: 1 S: 5	H: 0 LOB: 0 BB: 0 P: 5	R: 4 E: 0 K: 0 S: 7	H: 5 LOB: 1 BB: 1 P: 11	R: 0 E: 0 K: 1 S: 4	H: 0 LOB: 0 BB: 1 P: 8	R: 1 E: 0 K: 0 S: 4	H: 2 LOB: 1 BB: 1 P: 8	R: 0 E: 0 K: 0 S: 3	H: 1 LOB: 0 BB: 0 P: 3	R: 1 E: 0 K: 0 S: 4	H: 2 LOB: 0 BB: 0 P: 4	1B: 13 2B: 1 3B: 0 HR: 0	SF: 0 SAC: 1 DP: 3 HBP: 0	WP: 1 PB: 1 SB: 0 CS: 1	PA: 41
<b>PITCHER</b>	IP WLS BF H R ER SO BB IBB HBP BLK WP HR S P ERA WHIP																					
Don Liddle, L ERA: 3.15 (1, 1)	4.1 L 22 7 6 6 2 1 1 0 0 1 0 24 32 12.46 1.846																					
Al Worthington, R ERA: (5, 1)	0.2 3 2 0 0 0 0 0 0 0 0 0 3 3 0.00 3.000																					
Al Conwin, R ERA: 4.24 (6, 1)	1.1 7 2 1 1 1 2 0 0 0 0 0 7 15 6.75 3.000																					
Paul Giel, R ERA: 6.75 (7, 1)	1.2 4 1 0 0 0 0 0 0 0 0 0 4 4 0.00 0.600																					
Alex Konikowski, R ERA: 7.5 (9, 1)	1.0 4 2 1 1 0 0 0 0 0 0 0 4 4 9.00 2.000																					

St. Louis Cardinals @ New York Giants  
Polo Grounds, New York, NY  
Thu Jul 29 1954, 3:33 AM EDT  
Att. 8,408 - Unknown

livebaseballscorecards.com

AB	35
R	8
H	14
RBI	8
BB	4
SO	3
LOB	12





Batter	1	2	3	4	5	6	7	8	9	AB	R	H	RBI	BB	SO	LOB
Whitey Lockman, L (1, 3) OBP: 0.330, SLG: 0.412 Al Corwin, R (6, 1) Paul Giel, R (7, 1) Bill Taylor, L (8, PH) Alex Konikowski, R (9, 1)	0-0 6-3		0-0 FC1-6		0-0 G3			0-3 K		3	0	0	0	0	0	2
Don Mueller, L (1, 9) OBP: 0.351, SLG: 0.426	0-0 6-3		0-0 FC3-6			0-0 F5		0-0 FC6-4 1B		4	0	1	0	0	0	1
Willie Mays, R (1, 8) OBP: 0.394, SLG: 0.699	0-0 6-3		0-0 F9			0-0 FC3-6 1B		0-0 FC6-4		4	0	1	0	0	0	2
Dusty Rhodes, L (1, 7) OBP: 0.500, SLG: 0.885		0-0 F7		0-0 4-3		0-0 FC3-6		0-3 K		4	0	0	0	0	1	1
Hank Thompson, L (1, 5) OBP: 0.370, SLG: 0.433		4-0 1B BB		0-0 6-3		0-3 K		0-0 FC4-6		3	0	0	0	1	1	2
Bobby Hofman, R (1, 4) OBP: 0.267, SLG: 0.429		0-0 1-3 1B		0-0 F7			0-0 5-3		0-0 F4	4	0	1	0	0	0	1
Alvin Dark, R (1, 6) OBP: 0.310, SLG: 0.410		0-0 F5			0-0 6-3		0-0 F9		0-0 1-3	4	0	0	0	0	0	3
Ray Katt, R (1, 2) OBP: 0.316, SLG: 0.392		0-0 F2			0-0 E5		0-0 F7			3	0	0	0	0	0	2
Don Liddle, L (1, 1) OBP: 0.280, SLG: 0.182 Al Worthington, R (5, 1) Davey Williams, R (5, PH)			4-0 FC1-6 BB		0-3 K			0-0 6-3		0	0	0	0	1	0	0
										0	0	0	0	0	0	0
										2	0	0	0	0	1	1

Inning Stats	R: 0	H: 0	E: 0	K: 0	S: 3	R: 0	H: 1	E: 0	K: 0	S: 4	R: 0	H: 0	E: 0	K: 0	S: 3	R: 0	H: 0	E: 1	K: 1	S: 6	R: 0	H: 1	E: 1	K: 1	S: 6	R: 0	H: 0	E: 0	K: 0	S: 3	R: 0	H: 1	E: 0	K: 1	S: 6	R: 0	H: 0	E: 1	K: 1	S: 6	R: 0	H: 0	E: 1	K: 1	S: 6						
	0	0	0	0	3	0	1	0	0	4	0	0	0	0	3	0	0	1	1	6	0	1	0	0	0	6	0	0	0	0	3	0	1	0	0	6	0	0	0	0	6	0	0	0	0	6	0	0	0	0	6
	0	0	0	0	3	0	0	0	0	4	0	0	0	0	3	0	0	1	1	6	0	1	0	0	0	6	0	0	0	0	3	0	0	0	0	6	0	0	0	0	6	0	0	0	0	6	0	0	0	0	6

**BOTTOM**

**St. Louis Cardinals @ New York Giants**  
 Polo Grounds, New York, NY  
 Thu Jul 29 1954, 3:33 AM EDT  
 Att. 8,408 - Unknown

AB	32
R	0
H	3
RBI	0
BB	2
SO	4
LOB	15



WP: 0	PA: 34
PB: 0	SB: 0
CS: 0	

Batter	1	2	3	4	5	6	7	8	9	AB R H RBI BB SO LOB	TOP	
<b>Chuck Harmon, R</b> (1, 5) <small>OBP: 0.273, SLG: 0.299</small>	0-0 		0-0 			0-0 		0-0 		4 0 1 0 0 0 0		
<b>Roy McMillan, R</b> (1, 6) <small>OBP: 0.305, SLG: 0.313</small>	0-0 			0-0 		4-0 		0-3 		3 0 1 0 1 1 1		
<b>Gus Bell, L</b> (1, 8) <small>OBP: 0.361, SLG: 0.523</small>	0-0 			0-0 		0-0 		0-0 		4 0 0 0 0 0 3		
<b>Ted Kluszewski, L</b> (1, 3) <small>OBP: 0.389, SLG: 0.593</small>	0-3 			0-0 		0-0 			0-0 	4 0 1 0 0 1 2		
<b>Jim Greengrass, R</b> (1, 7) <small>OBP: 0.311, SLG: 0.473</small>		0-0 		0-0 		0-0 		0-0 		4 1 2 0 0 0 1		
<b>Wally Post, R</b> (1, 9) <small>OBP: 0.261, SLG: 0.406</small>		0-0 			0-0 	0-0 		0-0 		4 0 0 1 0 0 1		
<b>Ed Bailey, L</b> (1, 2) <small>OBP: 0.337, SLG: 0.412</small>		0-3 			0-0 	0-0 		0-3 		4 0 0 0 0 2 2		
<b>Rocky Bridges, R</b> (1, 4) <small>OBP: 0.400, SLG: 0.361</small> <b>Lloyd Merriman, L</b> (9, PH) <small>OBP: 0.316, SLG: 0.308</small>			0-3 		4-0 	0-0 		0-0 		2 0 0 0 1 1 0 1 0 0 0 0 0 2		
<b>Fred Baczewski, L</b> (1, 1) <small>OBP: 0.121, SLG: 0.094</small> <b>Jackie Collum, L</b> (6, 1) <small>OBP: 0.143, SLG: 0.286</small> <b>Nino Escalera, L</b> (8, PH) <small>OBP: 0.234, SLG: 0.175</small> <b>Joe Nuxhall, L</b> (8, 1) <small>OBP: 0.375, SLG: 0.400</small>		0-3 		0-0 			0-0 			2 0 0 0 0 1 1 0 0 0 0 0 0 0 1 0 0 0 0 0 0 0 0 0 0 0 0 0		
<b>Inning Stats</b>	R: 0 H: 1 E: 0 LOB: 1 K: 1 BB: 0 S: 6 P: 6	R: 0 H: 0 E: 0 LOB: 0 K: 1 BB: 0 S: 5 P: 5	R: 0 H: 0 E: 0 LOB: 0 K: 2 BB: 0 S: 7 P: 7	R: 0 H: 1 E: 0 LOB: 1 K: 0 BB: 0 S: 4 P: 4	R: 0 H: 0 E: 0 LOB: 1 K: 0 BB: 1 S: 3 P: 7	R: 0 H: 0 E: 0 LOB: 1 K: 0 BB: 1 S: 3 P: 7	R: 1 H: 1 E: 0 LOB: 0 K: 0 BB: 0 S: 4 P: 4	R: 0 H: 1 E: 0 LOB: 1 K: 1 BB: 0 S: 7 P: 6	R: 0 H: 1 E: 1 LOB: 2 K: 1 BB: 0 S: 7 P: 7	1B: 4 SF: 0 2B: 0 SAC: 0 3B: 1 DP: 0 HR: 0 HBP: 0	WP: 0 PA: 35 PB: 0 SB: 0 CS: 0	
<b>PITCHER</b> <b>Ruben Gomez, R</b> (1, 1) <small>ERA: 3.2</small>	IP: 9.0 WLS: W BF: 35 H: 5 R: 1 ER: 1 SO: 6 BB: 2 IBB: 0 HBP: 0 BLK: 0 WP: 0 HR: 0 S: 45 P: 53 ERA: 1.00 WHIP: 0.778											<b>PITCHER</b> IP: WLS: BF: H: R: ER: SO: BB: IBB: HBP: BLK: WP: HR: S: P: ERA: WHIP

**Cincinnati Redlegs @ New York Giants**  
 Polo Grounds, New York, NY  
 Fri Jul 30 1954, 3:33 AM EDT  
 Att. 13,153 - Unknown

[livebaseballscorecards.com](http://livebaseballscorecards.com)

**AB** 33  
**R** 1  
**H** 5  
**RBI** 1  
**BB** 2  
**SO** 6  
**LOB** 13



Batter	1	2	3	4	5	6	7	8	9	AB	R	H	RBI	BB	SO	LOB
Whitey Lockman, L (1, 3) OBP: 0.331, SLG: 0.412	0-0 F8 ①		4-0 G4-6-3 BB		0-0 1B		0-0 F6 ②			3	0	1	0	1	0	0
Alvin Dark, R (1, 6) OBP: 0.307, SLG: 0.406	0-0 F8 ②		0-0 G4-6-3 ② ③ 1-2f		0-0 F5 ③		0-0 6-3 ③			4	0	0	0	0	0	2
Don Mueller, L (1, 9) OBP: 0.353, SLG: 0.433	4-0 BB			0-0 F3 ①		0-0 HR		0-0 1-3 ①		3	1	1	1	1	0	0
Monte Irvin, R (1, 7) OBP: 0.381, SLG: 0.477	0-0 F8 ③			0-0 6-3 ②		0-0 6-3 ①		0-0 F9 ②		4	0	0	0	0	0	1
Willie Mays, R (1, 8) OBP: 0.392, SLG: 0.695		0-0 F8 ①		0-0 F3 ③		0-0 6-3 ②		0-0 1B ③		4	0	1	0	0	0	0
Davey Williams, R (1, 4) OBP: 0.295, SLG: 0.337		0-0 4-1 ②			0-0 4-3 ①	4-0 HR BB				2	1	0	0	1	0	0
Hank Thompson, L (1, 5) OBP: 0.370, SLG: 0.441		0-0 F2 ③			0-0 G3 ②	0-0 1-H HR				3	1	1	2	0	0	0
Wes Westrum, R (1, 2) OBP: 0.319, SLG: 0.352			0-0 HR		4-0 HR BB	0-0 6-3 ③				2	2	1	1	1	0	0
Ruben Gomez, R (1, 1) OBP: 0.188, SLG: 0.250			0-0 6-3 ①		0-0 1-H HR		0-0 5-3 ①			3	1	1	2	0	0	0

Inning Stats	R: 0	H: 0	E: 0	K: 0	S: 3	LOB: 1	BB: 1	P: 7	R: 0	H: 0	E: 0	K: 0	S: 3	LOB: 0	BB: 0	P: 3	R: 1	H: 1	E: 0	K: 0	S: 3	LOB: 0	BB: 1	P: 7	R: 0	H: 0	E: 0	K: 0	S: 3	LOB: 0	BB: 0	P: 3	R: 2	H: 2	E: 0	K: 0	S: 5	LOB: 1	BB: 1	P: 9	R: 3	H: 2	E: 0	K: 0	S: 5	LOB: 0	BB: 1	P: 9	R: 0	H: 0	E: 0	K: 0	S: 3	LOB: 0	BB: 0	P: 3	R: 0	H: 1	E: 0	K: 0	S: 3	LOB: 1	BB: 0	P: 3
1B: 2	SF: 0	2B: 0	SAC: 0	3B: 0	DP: 1	HR: 4	HBP: 0	WP: 0	PA: 32																																																							

PITCHER	IP	WLS	BF	H	R	ER	SO	BB	IBB	HBP	BLK	WP	HR	S	P	ERA	WHIP
Fred Baczewski, L (1, 1) ERA: 4.56	5.2	L	25	5	6	6	0	4	0	0	0	0	4	21	37	9.53	1.588
Jackie Collum, L (6, 1) ERA: 3.61	1.1		4	0	0	0	0	0	0	0	0	0	0	4	4	0.00	0.000
Joe Nuxhall, L (8, 1) ERA: 4.52	1.0		3	1	0	0	0	0	0	0	0	0	0	3	3	0.00	1.000

**BOTTOM**

**Cincinnati Redlegs @ New York Giants**  
**Polo Grounds, New York, NY**  
 Fri Jul 30 1954, 3:33 AM EDT  
 Att. 13,153 - Unknown

[livebaseballscorecards.com](http://livebaseballscorecards.com)

<b>AB</b>	<b>28</b>
<b>R</b>	<b>6</b>
<b>H</b>	<b>6</b>
<b>RBI</b>	<b>6</b>
<b>BB</b>	<b>4</b>
<b>SO</b>	<b>0</b>
<b>LOB</b>	<b>3</b>



Batter	1	2	3	4	5	6	7	8	9	AB R H RBI BB SO LOB	TOP	
<b>Chuck Harmon, R</b> (1, 5) <small>OBP: 0.272, SLG: 0.298</small>	0-0 		0-0 		0-0 			0-0 		4 0 1 0 0 0 2		
<b>Roy McMillan, R</b> (1, 6) <small>OBP: 0.304, SLG: 0.313</small>	0-0 		0-0 			0-0 		0-0 		4 0 1 0 0 0 2		
<b>Gus Bell, L</b> (1, 8) <small>OBP: 0.362, SLG: 0.520</small>	4-0 		0-0 			0-0 			4-0 	2 0 0 0 2 0 1		
<b>Ted Kluszewski, L</b> (1, 3) <small>OBP: 0.390, SLG: 0.591</small>	4-0 			0-0 		0-0 			0-0 	3 0 1 0 1 0 0		
<b>Jim Greengrass, R</b> (1, 7) <small>OBP: 0.308, SLG: 0.468</small>	0-0 			0-0 			0-0 		0-0 	4 0 0 0 0 0 4		
<b>Wally Post, R</b> (1, 9) <small>OBP: 0.278, SLG: 0.401</small>		0-0 		0-0 			0-0 		0-0 	4 0 0 0 0 0 2		
<b>Hobie Landrith, L</b> (1, 2) <small>OBP: 0.349, SLG: 0.500</small>		0-0 			0-0 		0-0 			3 0 1 0 0 0 0		
<b>Rocky Bridges, R</b> (1, 4) <small>OBP: 0.381, SLG: 0.342</small> <b>Lloyd Merriman, L</b> (8, PH) <small>OBP: 0.313, SLG: 0.303</small> <b>Karl Drews, R</b> (8, 1) <small>OBP: 0.250, SLG: 0.077</small>		0-0 			0-0 			0-0 		2 0 0 0 0 0 1		
<b>Howie Judson, R</b> (1, 1) <small>OBP: 0.136, SLG: 0.095</small> <b>Ed Bailey, L</b> (8, PH) <small>OBP: 0.341, SLG: 0.412</small> <b>Johnny Temple, R</b> (8, 4) <small>OBP: 0.380, SLG: 0.344</small>			0-0 		0-3 			4-0 		0 0 0 0 1 0 0		
<b>Inning Stats</b>	R: 0 H: 1 E: 0 LOB: 2 K: 0 BB: 2 S: 3 P: 11	R: 0 H: 0 E: 0 LOB: 0 K: 0 BB: 0 S: 3 P: 3	R: 0 H: 1 E: 0 LOB: 1 K: 0 BB: 0 S: 4 P: 4	R: 0 H: 0 E: 0 LOB: 0 K: 0 BB: 0 S: 3 P: 3	R: 0 H: 1 E: 0 LOB: 1 K: 1 BB: 0 S: 6 P: 6	R: 0 H: 0 E: 0 LOB: 0 K: 0 BB: 0 S: 3 P: 3	R: 0 H: 0 E: 0 LOB: 0 K: 0 BB: 0 S: 3 P: 3	R: 0 H: 0 E: 0 LOB: 1 K: 0 BB: 1 S: 3 P: 7	R: 0 H: 1 E: 0 LOB: 1 K: 0 BB: 1 S: 3 P: 7	1B: 4 SF: 0 2B: 1 SAC: 0 3B: 0 DP: 2 HR: 0 HBP: 0	WP: 0 PA: 33 PB: 0 SB: 0 CS: 0	
<b>PITCHER</b> <b>Sal Maglie, R</b> (1, 1) <small>ERA: 3.35</small> <b>Mary Grissom, R</b> (8, 1) <small>ERA: 2.19</small>	IP WLS BF H R ER SO BB IBB HBP BLK WP HR S P ERA WHIP 7.1 W 27 3 0 0 1 3 0 0 0 0 0 0 26 38 0.00 0.818											<b>PITCHER</b> IP WLS BF H R ER SO BB IBB HBP BLK WP HR S P ERA WHIP 1.2 S 6 1 0 0 0 1 0 0 0 0 0 0 5 9 0.00 1.200

**Cincinnati Redlegs @ New York Giants**  
 Polo Grounds, New York, NY  
 Sat Jul 31 1954, 3:33 AM EDT  
 Att. 7,310 - Unknown

livebaseballscorecards.com

AB	29
R	0
H	4
RBI	0
BB	4
SO	1
LOB	13





Batter	1	2	3	4	5	6	7	8	9	AB R H RBI BB SO LOB	TOP											
<b>Chuck Harmon, R</b> (1, 5) <small>OBP: 0.271, SLG: 0.296</small>	0-0 5-3		0-3 K		0-3 K		0-0 HR 1B	0-0 F3		5 1 1 0 0 2 1												
<b>Roy McMillan, R</b> (1, 6) <small>OBP: 0.303, SLG: 0.319</small>	0-0 6-3		0-0 5-3		0-0 F2		0-0 HR 1B	0-0 F2	5 1 1 2 0 0 0													
<b>Ted Kluszewski, L</b> (1, 3) <small>OBP: 0.388, SLG: 0.594</small>	0-0 F9		0-0 HR		0-0 4-3		0-0 F9	0-0 4-3	5 1 1 1 0 0 0													
<b>Bob Borkowski, R</b> (1, 9) <small>OBP: 0.330, SLG: 0.444</small>		1-0 BB HBP HBP	0-0 F9		0-0 4-3 1-3 1B		0-0 1B	0-0 6-3	4 0 2 0 0 0 0													
<b>Gus Bell, L</b> (1, 8) <small>OBP: 0.361, SLG: 0.516</small>		1-0 BB 1-2 HBP		0-0 F9		0-0 1-3 1-2	0-0 F4		3 0 0 0 0 0 2													
<b>Jim Greengrass, R</b> (1, 7) <small>OBP: 0.310, SLG: 0.467</small>		0-0 F9		4-0 BB BB		0-0 4-3 2-3		0-0 3-1 SH5-3 1B	3 1 1 0 1 0 3													
<b>Andy Seminick, R</b> (1, 2) <small>OBP: 0.361, SLG: 0.423</small>		0-0 F3		4-0 1-2 BB		4-0 BB		0-0 SH5-3	1 0 0 0 2 0 2													
<b>Rocky Bridges, R</b> (1, 4) <small>OBP: 0.370, SLG: 0.317</small>		4-0 1-2 2-3 BB		0-0 F5		0-0 F7		0-0 3-1	3 0 0 0 1 0 5													
<b>Harry Perkowski, L</b> (1, 1) <small>OBP: 0.160, SLG: 0.333</small> <b>Bobby Adams, R</b> (7, PH) <small>OBP: 0.365, SLG: 0.355</small> <b>Frank Smith, R</b> (7, 1) <small>OBP: 0.359, SLG: 0.510</small> <b>Hobie Landrith, L</b> (8, PH) <small>OBP: 0.359, SLG: 0.510</small> <b>Moe Savransky, L</b> (8, 1) <small>OBP: 0.667, SLG: 0.500</small>		0-3 K		0-3 K		0-0 6-3		0-0 3-H 1B	2 0 0 0 0 2 5 1 0 0 0 0 0 0 0 0 0 0 0 0 0 1 0 1 1 0 0 0 0 0 0 0 0 0 0													
<b>Inning Stats</b>	R: 0 E: 0 K: 0 S: 3	H: 0 LOB: 0 BB: 0 P: 3	R: 0 E: 0 K: 1 S: 5	H: 0 LOB: 3 BB: 1 P: 11	R: 1 E: 0 K: 1 S: 6	H: 1 LOB: 0 BB: 0 P: 6	R: 0 E: 0 K: 1 S: 5	H: 0 LOB: 2 BB: 2 P: 13	R: 0 E: 0 K: 1 S: 5	H: 0 LOB: 0 BB: 0 P: 5	R: 0 E: 0 K: 0 S: 4	H: 1 LOB: 2 BB: 1 P: 8	R: 2 E: 0 K: 0 S: 6	H: 3 LOB: 1 BB: 0 P: 6	R: 1 E: 0 K: 0 S: 5	H: 2 LOB: 1 BB: 0 P: 5	R: 0 E: 0 K: 0 S: 3	H: 0 LOB: 0 BB: 0 P: 3	1B: 5 2B: 0 3B: 0 HR: 2	SF: 0 SAC: 1 DP: 0 HBP: 2	WP: 0 PB: 0 SB: 0 CS: 0	PA: 40
<b>PITCHER</b>	IP WLS BF H R ER SO BB IBB HBP BLK WP HR S P ERA WHIP																					
<b>Johnny Antonelli, L</b> (1, 1) <small>ERA: 2.22</small> <b>Mary Grissom, R</b> (8, 1) <small>ERA: 2.25</small>	7.0 W 32 5 3 3 4 4 0 2 0 0 2 34 52 3.86 1.286																					
	2.0 S 8 2 1 1 0 0 0 0 0 0 0 8 8 4.50 1.000																					

**Cincinnati Redlegs @ New York Giants**  
 Polo Grounds, New York, NY  
 Sun Aug 01 1954, 3:33 AM EDT  
 Unknown

[livebaseballscorecards.com](http://livebaseballscorecards.com)

**AB 33**  
**R 4**  
**H 7**  
**RBI 4**  
**BB 4**  
**SO 4**  
**LOB 18**



Batter	1	2	3	4	5	6	7	8	9
<b>Whitey Lockman, L</b> OBP: 0.331, SLG: 0.413 (1, 3)	0-0 1B 3B	0-0 FC3-6 1-2f			0-0 F7		0-0 SH3-4 HR 1B	0-0 FC6-4 1-2f	
<b>Alvin Dark, R</b> OBP: 0.310, SLG: 0.416 (1, 6)	0-0 FC3-6 1B 3-H	0-0 F7			0-0 HR		0-0 SH3-4 1-2	0-0 FC6-4 1-2f	
<b>Hank Thompson, L</b> OBP: 0.378, SLG: 0.472 (1, 5)	0-0 FC3-6 1B 1-2f		4-0 BB BB BB		0-3 K		0-0 HR 2-H		
<b>Monte Irvin, R</b> OBP: 0.377, SLG: 0.471 (1, 7)	0-0 F4		0-0 G6-4-3 1-2f		0-0 F2		0-0 6-3		
<b>Don Mueller, L</b> OBP: 0.356, SLG: 0.434 (1, 9)	0-0 1B 1-2		0-0 4-3		0-0 FC5-4 1B		0-0 4-3		
<b>Willie Mays, R</b> OBP: 0.394, SLG: 0.689 (1, 8)	0-0 4-3		0-0 G6-4-3 1B		0-0 F8		0-0 F8		
<b>Davey Williams, R</b> OBP: 0.294, SLG: 0.333 (1, 4)		0-0 1B FC5-4 1B		0-0 G6-4-3 1-2f		0-0 FC5-4 1-2f		4-0 HR BB	
<b>Wes Westrum, R</b> OBP: 0.320, SLG: 0.348 (1, 2)		0-0 FC5-4 1B		0-3 K		4-0 HR BB		0-0 HR 1-H	
<b>Bobby Hofman, R</b> OBP: 0.279, SLG: 0.429 (7, PH)		0-0 FC5-4 1B		0-3 K		0-0 HR 1-H		4-0 FC6-4 BB	
<b>Ruben Gomez, R</b> OBP: 0.188, SLG: 0.250 (7, PR)		0-0 FC5-4 1B		0-3 K					
<b>Ray Katt, R</b> OBP: 0.322, SLG: 0.427 (8, 2)		0-0 FC5-4 1B		0-3 K					
<b>Johnny Antonelli, L</b> OBP: 0.187, SLG: 0.247 (1, 1)		0-0 FC5-4 1B		0-3 K					
<b>Dusty Rhodes, L</b> OBP: 0.479, SLG: 0.879 (7, PH)		0-0 FC5-4 1B		0-3 K					
<b>Mary Grissom, R</b> OBP: 0.167, SLG: 0.130 (8, 1)		0-0 FC5-4 1B		0-3 K					

Inning Stats	R: 1	H: 3	E: 0	K: 0	S: 6	H: 3	LOB: 2	BB: 0	P: 6	R: 1	H: 2	E: 0	K: 0	S: 5	H: 2	LOB: 1	BB: 0	P: 5	R: 0	H: 0	E: 0	K: 0	S: 2	H: 0	LOB: 0	BB: 1	P: 6	R: 0	H: 1	E: 0	K: 1	S: 5	H: 1	LOB: 0	BB: 0	P: 5	R: 1	H: 1	E: 0	K: 2	S: 8	H: 1	LOB: 0	BB: 0	P: 8	R: 0	H: 1	E: 0	K: 0	S: 4	H: 1	LOB: 1	BB: 0	P: 4	R: 4	H: 3	E: 0	K: 0	S: 6	H: 3	LOB: 1	BB: 1	P: 10	R: 2	H: 1	E: 0	K: 0	S: 4	H: 1	LOB: 1	BB: 2	P: 12
--------------	------	------	------	------	------	------	--------	-------	------	------	------	------	------	------	------	--------	-------	------	------	------	------	------	------	------	--------	-------	------	------	------	------	------	------	------	--------	-------	------	------	------	------	------	------	------	--------	-------	------	------	------	------	------	------	------	--------	-------	------	------	------	------	------	------	------	--------	-------	-------	------	------	------	------	------	------	--------	-------	-------

PITCHER	IP	WLS	BF	H	R	ER	SO	BB	IBB	HBP	BLK	WP	HR	S	P	ERA	WHIP
<b>Harry Perkowski, L</b> ERA: 6.25 (1, 1)	6.0		25	8	3	3	3	1	0	0	0	0	1	30	34	4.50	1.500
<b>Frank Smith, R</b> ERA: 2.16 (7, 1)	1.0	L	7	3	4	4	0	1	0	0	0	0	2	6	10	36.00	4.000
<b>Moe Savransky, L</b> ERA: 3.98 (8, 1)	1.0		6	1	2	2	0	2	0	0	0	0	1	4	12	18.00	3.000

**BOTTOM**

**Cincinnati Redlegs @ New York Giants**  
Polo Grounds, New York, NY  
Sun Aug 01 1954, 3:33 AM EDT  
Unknown

AB	R	H	RBI	BB	SO	LOB
5	2	2	0	0	0	2
4	1	2	2	0	0	2
3	1	1	2	1	1	1
4	0	0	0	0	0	3
4	0	2	0	0	0	1
4	0	1	0	0	0	3
3	2	1	0	1	0	2
2	0	1	0	0	1	0
0	0	0	0	1	0	0
0	1	0	0	0	0	0
1	1	1	2	0	0	0
2	0	0	1	0	1	1
1	1	1	2	0	0	0
0	0	0	0	1	0	0

AB	33
R	9
H	12
RBI	9
BB	4
SO	3
LOB	15



WP	PA	3B	SF	SAC	DP	HBP	CS
0	38	0	0	1	2	0	0

Batter	1	2	3	4	5	6	7	8	9	AB R H RBI BB SO LOB	TOP
<b>Chuck Harmon, R</b> (1, 5) <small>OBP: 0.270, SLG: 0.291</small>	4-0 		0-0 <b>G5-4-3</b> <small>1-2f</small>			0-0 <b>5-3</b>		0-3 <b>K</b>		3 0 0 0 1 1 1	
<b>Roy McMillan, R</b> (1, 6) <small>OBP: 0.300, SLG: 0.316</small>	0-0 <b>G6-4-3</b> <small>1-2f</small>		0-0 <b>6-3</b>			0-0 <b>F7</b>		0-0 <b>6-3</b>		4 0 0 0 0 0 1	
<b>Ted Kluszewski, L</b> (1, 3) <small>OBP: 0.391, SLG: 0.595</small>	0-0 <b>1B</b> <b>1B</b>			0-0 <b>1-5-3</b>		0-0 <b>1B</b>		0-0 <b>G1-4-3</b> <b>1B</b>		4 0 3 0 0 0 0	
<b>Bob Borkowski, R</b> (1, 9) <small>OBP: 0.336, SLG: 0.447</small>	0-0 <b>1-2</b> <b>1B</b>			0-0 <b>FC6-4</b> <b>1B</b>		0-3 <b>K</b>		0-0 <b>G1-4-3</b> <small>1-2f</small>		4 0 2 0 0 1 2	
<b>Gus Bell, L</b> (1, 8) <small>OBP: 0.361, SLG: 0.515</small>	0-3 <b>K</b>			0-0 <b>F6</b>			0-0 <b>G4-6-3</b> <b>1B</b>			3 0 1 0 0 1 3	
<b>Jim Greengrass, R</b> (1, 7) <small>OBP: 0.308, SLG: 0.464</small>		0-0 <b>4-3</b>		0-0 <b>FC6-4</b> <small>1-2f</small>			0-0 <b>G4-6-3</b> <small>1-2f</small>			3 0 0 0 0 0 2	
<b>Hobie Landrith, L</b> (1, 2) <small>OBP: 0.358, SLG: 0.491</small> <b>Jackie Collum, L</b> (8, 1) <small>OBP: 0.143, SLG: 0.286</small>		4-0 <b>G1-6-3</b> <b>BB</b>			0-3 <b>K2-3</b>		0-0 <b>F8</b>			2 0 0 0 1 1 0 0 0 0 0 0 0 0	
<b>Rocky Bridges, R</b> (1, 4) <small>OBP: 0.354, SLG: 0.302</small> <b>Lloyd Merriman, L</b> (8, PH) <small>OBP: 0.309, SLG: 0.299</small> <b>Johnny Temple, R</b> (8, 4) <small>OBP: 0.380, SLG: 0.344</small>		0-0 <b>G1-6-3</b> <small>1-2f</small>			0-0 <b>5-3</b>			0-0 <b>F8</b>		2 0 0 0 0 0 1 1 0 0 0 0 0 0 0 0 0 0 0 0 0	
<b>Art Fowler, R</b> (1, 1) <small>OBP: 0.239, SLG: 0.125</small> <b>Ed Bailey, L</b> (8, PH) <small>OBP: 0.339, SLG: 0.409</small> (8, 2)			4-0 <b>G5-4-3</b> <b>BB</b>		0-0 <b>5-3</b>			0-0 <b>4-3</b>		1 0 0 0 1 0 0 1 0 0 0 0 0 0	
<b>Inning Stats</b>	R: 0 H: 2 E: 0 LOB: 2 K: 1 BB: 1 S: 6 P: 10	R: 0 H: 0 E: 0 LOB: 0 K: 0 BB: 1 S: 2 P: 6	R: 0 H: 0 E: 0 LOB: 0 K: 0 BB: 1 S: 2 P: 6	R: 0 H: 1 E: 0 LOB: 1 K: 0 BB: 0 S: 4 P: 4	R: 0 H: 0 E: 0 LOB: 0 K: 1 BB: 0 S: 5 P: 5	R: 0 H: 1 E: 0 LOB: 1 K: 1 BB: 0 S: 6 P: 6	R: 0 H: 1 E: 0 LOB: 0 K: 0 BB: 0 S: 3 P: 3	R: 0 H: 0 E: 0 LOB: 0 K: 1 BB: 0 S: 5 P: 5	R: 0 H: 1 E: 0 LOB: 0 K: 0 BB: 0 S: 3 P: 3	1B: 6 SF: 0 2B: 0 SAC: 0 3B: 0 DP: 5 HR: 0 HBP: 0	WP: 0 PA: 31 PB: 0 SB: 0 CS: 0
<b>PITCHER</b> <b>Jim Hearn, R</b> (1, 1) <small>ERA: 3.86</small>	IP: 9.0 WLS: W BF: 31 H: 6 R: 0 ER: 0 SO: 4 BB: 3 IBB: 0 HBP: 0 BLK: 0 WP: 0 HR: 0 S: 36 P: 48 ERA: 0.00 WHIP: 1.000										

**Cincinnati Redlegs @ New York Giants**  
 Polo Grounds, New York, NY  
 Sun Aug 01 1954, 3:38 AM EDT  
 Att: 19,362 - Unknown

[livebaseballscorecards.com](http://livebaseballscorecards.com)

<b>AB</b>	<b>28</b>
<b>R</b>	<b>0</b>
<b>H</b>	<b>6</b>
<b>RBI</b>	<b>0</b>
<b>BB</b>	<b>3</b>
<b>SO</b>	<b>4</b>
<b>LOB</b>	<b>10</b>





Batter	1	2	3	4	5	6	7	8	9	AB	R	H	RBI	BB	SO	LOB
Whitey Lockman, L (1, 3) OBP: 0.330, SLG: 0.412	0-0 E1 1B SF7		0-0 1-3		0-0 3-1 SH1-3 1B		0-0 G3			4	1	1	0	0	0	0
Alvin Dark, R (1, 6) OBP: 0.315, SLG: 0.420	0-0 1-3 3B 1B		0-0 1B 1B		0-0 SH1-3 1-2		0-0 SH1-4 1B			3	2	3	0	0	0	0
Hank Thompson, L (1, 5) OBP: 0.378, SLG: 0.472	0-0 SF7		0-0 1-2 1B		0-0 3-1		0-0 SH1-4			2	0	1	1	0	0	1
Dusty Rhodes, L (1, 7) OBP: 0.468, SLG: 0.871	0-0 3-H 1-H SF9 3B		0-0 F8		0-0 F5		0-0 F2			4	1	1	1	0	0	4
Don Mueller, L (1, 9) OBP: 0.357, SLG: 0.438	0-0 SF9		0-0 F1		0-0 G4-6-3 1B		0-0 1B 2B			3	1	2	2	0	0	2
Willie Mays, R (1, 8) OBP: 0.393, SLG: 0.684	0-0 F9		0-0 F6		0-0 F2		0-0 1B			4	0	1	1	0	0	1
Davey Williams, R (1, 4) OBP: 0.291, SLG: 0.330		0-0 F9		0-0 F8		0-0 G4-6-3 1-2f		0-0 1-3		4	0	0	0	0	0	2
Wes Westrum, R (1, 2) OBP: 0.320, SLG: 0.344		0-0 F5		4-0 FC6-4 BB		0-3 K				2	0	0	0	1	1	0
Jim Hearn, R (1, 1) OBP: 0.175, SLG: 0.216		0-0 5-3		0-0 FC6-4 1-2f		0-0 F8				3	0	0	0	0	0	1

Inning Stats	R: 3	H: 2	E: 1	K: 0	S: 6	LOB: 0	BB: 0	P: 6
	R: 0	H: 0	E: 0	K: 0	S: 3	LOB: 0	BB: 0	P: 3
	R: 0	H: 2	E: 0	K: 0	S: 5	LOB: 2	BB: 0	P: 5
	R: 0	H: 0	E: 0	K: 0	S: 3	LOB: 1	BB: 1	P: 7
	R: 0	H: 1	E: 0	K: 0	S: 4	LOB: 1	BB: 0	P: 4
	R: 0	H: 1	E: 0	K: 0	S: 3	LOB: 0	BB: 0	P: 3
	R: 0	H: 0	E: 0	K: 1	S: 5	LOB: 0	BB: 0	P: 5
	R: 2	H: 3	E: 0	K: 0	S: 6	LOB: 1	BB: 0	P: 6

PITCHER	IP	WLS	BF	H	R	ER	SO	BB	IBB	HBP	BLK	WP	HR	S	P	ERA	WHIP
Art Fowler, R (1, 1) ERA: 3.08	7.0	L	28	6	3	1	1	1	1	0	0	0	0	29	33	1.29	1.000
Jackie Collum, L (8, 1) ERA: 3.91	1.0		6	3	2	2	0	0	0	0	0	0	0	6	6	18.00	3.000

**BOTTOM**

**Cincinnati Redlegs @ New York Giants**  
Polo Grounds, New York, NY

Sun Aug 01 1954, 3:38 AM EDT  
Att. 19,362 - Unknown

<b>AB</b>	<b>29</b>
<b>R</b>	<b>5</b>
<b>H</b>	<b>9</b>
<b>RBI</b>	<b>5</b>
<b>BB</b>	<b>1</b>
<b>SO</b>	<b>1</b>
<b>LOB</b>	<b>11</b>

[livebaseballscorecards.com](http://livebaseballscorecards.com)



WP	HR	S	P	ERA	WHIP
WP: 0	HR: 0	S: 0	P: 34	ERA: 0	WHIP: 0
PB: 0	SAC: 2	DP: 1	CS: 0		

Batter	1	2	3	4	5	6	7	8	9	AB R H RBI BB SO LOB	TOP																													
Frank Baumholtz, L (1, 8) OBP: 0.369, SLG: 0.434	0-0 F8	0-0 SF8			0-0 F9		0-3 K2-3		0-0 G4-6-3	4 0 0 1 0 1 1																														
Eddie Miksis, R (1, 4) OBP: 0.226, SLG: 0.259	0-0 6-3	0-0 F8			0-0 4-3 1B		0-0 6-3			4 0 1 0 0 0 2																														
Dee Fondy, L (1, 3) OBP: 0.320, SLG: 0.403	0-0 1B			0-0 F7	0-0 4-3		0-3 K			4 0 1 0 0 1 1																														
Ralph Kiner, R (1, 7) OBP: 0.393, SLG: 0.521	0-0 1-3 1B		4-0 BB	4-0 BB	4-0 BB		0-0 6-3			2 0 1 0 2 0 0																														
Hal Rice, L (1, 9) OBP: 0.271, SLG: 0.226	0-0 3-1		0-0 F9	0-3 K	0-3 K		0-0 6-3			4 0 0 0 0 1 5																														
14 Ernie Banks, R (1, 6) OBP: 0.339, SLG: 0.415		4-0 BB HBP SF8 BB	0-0 F6		0-0 1B		0-0 1B			3 1 2 0 1 0 1																														
Bill Serena, R (1, 5) OBP: 0.324, SLG: 0.421		0-0 F4		0-0 6-3	0-3 K		0-3 K			4 0 0 0 0 2 3																														
Clyde McCullough, R (1, 2) OBP: 0.320, SLG: 0.489		1-0 BB HBP	0-0 5-3	0-0 5-3	0-0 F3		0-0 E5			3 0 0 0 0 0 1																														
Bob Rush, R (1, 1) OBP: 0.339, SLG: 0.370		4-0 BB	0-3 K	0-3 K	0-0 F9		0-3 K			2 0 0 0 1 1 1																														
Bill Tremel, R (8, 1) OBP: 0.333, SLG: 0.250										0 0 0 0 0 0 0																														
Steve Bilko, R (9, PH) OBP: 0.291, SLG: 0.333		1-2 2-3 BB								1 0 0 0 0 1 1																														
<b>Inning Stats</b>	R: 0 E: 0 K: 0 S: 5	H: 2 LOB: 2 BB: 0 P: 5	R: 1 E: 0 K: 0 S: 3	H: 0 LOB: 2 BB: 2 P: 12	R: 0 E: 0 K: 0 S: 3	H: 0 LOB: 1 BB: 1 P: 7	R: 0 E: 0 K: 1 S: 5	H: 0 LOB: 0 BB: 0 P: 5	R: 0 E: 0 K: 1 S: 6	H: 1 LOB: 2 BB: 1 P: 10	R: 0 E: 0 K: 1 S: 6	H: 1 LOB: 1 BB: 0 P: 6	R: 0 E: 0 K: 2 S: 7	H: 0 LOB: 0 BB: 0 P: 7	R: 0 E: 0 K: 1 S: 6	H: 1 LOB: 1 BB: 0 P: 6	R: 0 E: 1 K: 1 S: 5	H: 0 LOB: 0 BB: 0 P: 5	1B: 5 2B: 0 3B: 0 HR: 0	SF: 1 SAC: 0 DP: 1 HBP: 1	WP: 0 PB: 0 SB: 0 CS: 0	PA: 37																		
<b>PITCHER</b> Ruben Gomez, R (1, 1) ERA: 3.06	IP 9.0	WLS W	BF 37	H 5	R 1	ER 1	SO 7	BB 4	IBB 0	HBP 1	BLK 0	WP 0	HR 0	S 46	P 63	ERA 1.00	WHIP 1.000						<b>PITCHER</b>	IP 9.0	WLS W	BF 37	H 5	R 1	ER 1	SO 7	BB 4	IBB 0	HBP 1	BLK 0	WP 0	HR 0	S 46	P 63	ERA 1.00	WHIP 1.000

Chicago Cubs @ New York Giants  
Polo Grounds, New York, NY  
Tue Aug 03 1954, 3:33 AM EDT  
Att. 7,968 - Unknown

livebaseballscorecards.com

AB	31
R	1
H	5
RBI	1
BB	4
SO	7
LOB	16



Batter	1	2	3	4	5	6	7	8	9
Whitey Lockman, L OBP: 0.332, SLG: 0.411 (1, 3)	4-0 1B HR BB	0-3 K			0-0 F7		0-0 SH3-4	0-0 1B 1-3 2-H	
Alvin Dark, R OBP: 0.318, SLG: 0.422 (1, 6)	0-0 1-3 HR 1B	0-3 K			0-0 BB 1B		0-0 F9	0-0 1-3 3-H 1B	
Hank Thompson, L OBP: 0.380, SLG: 0.480 (1, 5)	0-0 1-H 3-H HR		0-0 F9		4-0 1-2 BB		4-0 BB	0-3 K	
Dusty Rhodes, L OBP: 0.444, SLG: 0.824 (1, 7)	0-0 F1		0-3 K		0-0 F5		0-0 F4		
Don Mueller, L OBP: 0.358, SLG: 0.439 Monte Irvin, R OBP: 0.377, SLG: 0.471 (1, 9)	0-0 1-3 1B		0-0 F8			0-0 FC6-4 1B		0-0 E9	
Willie Mays, R OBP: 0.394, SLG: 0.681 (1, 8)	0-0 1-3			4-0 BB G3-6-3		0-0 FC6-4 FC5-4		0-0 E4 1B	
Davey Williams, R OBP: 0.293, SLG: 0.331 (1, 4)	0-0 2-H 1B			0-0 G3-6-3 1-2f		0-0 FC5-4 1-2f		0-0 2-H 1B	
Wes Westrum, R OBP: 0.319, SLG: 0.342 (1, 2)	0-0 5-3			0-0 5-3		0-3 K		0-0 1-2 1B	
Ruben Gomez, R OBP: 0.192, SLG: 0.250 (1, 1)		0-0 5-3			0-0 5-3		0-0 SH3-4 1B	0-3 K	

AB R H RBI BB SO LOB		BOTTOM																		
3	1	1	1	1	1	0														
5	1	3	1	0	1	1														
3	1	1	3	2	1	2														
4	0	0	0	0	1	4														
4	1	2	0	0	0	0														
0	0	0	0	0	0	0														
3	1	1	0	1	0	2														
4	1	2	2	0	0	2														
4	1	1	0	0	1	2														
4	0	1	0	0	1	2														
Inning Stats		R: 4 E: 0 K: 0 S: 7	H: 4 LOB: 1 BB: 1 P: 11	R: 0 E: 0 K: 2 S: 7	H: 0 LOB: 0 BB: 0 P: 7	R: 0 E: 0 K: 1 S: 5	H: 0 LOB: 0 BB: 1 P: 5	R: 0 E: 0 K: 0 S: 2	H: 1 LOB: 2 BB: 1 P: 8	R: 0 E: 0 K: 1 S: 6	H: 1 LOB: 1 BB: 0 P: 6	R: 0 E: 0 K: 0 S: 4	H: 1 LOB: 2 BB: 1 P: 8	R: 3 E: 2 K: 2 S: 12	H: 5 LOB: 2 BB: 0 P: 12	1B: 11 2B: 0 3B: 0 HR: 1	SF: 0 SAC: 1 DP: 1 HBP: 0	WP: 0 PB: 0 SB: 0 CS: 0	PA: 39	
PITCHER		IP	WLS	BF	H	R	ER	SO	BB	IBB	HBP	BLK	WP	HR	S	P	ERA	WHIP		
Bob Rush, R ERA: 4.43 (1, 1)	7.2	L	38	12	7	7	7	5	4	0	0	0	0	1	44	60	8.22	2.087		
Bill Tremel, R ERA: 4.19 (8, 1)	0.1		1	0	0	0	0	1	0	0	0	0	0	0	3	3	0.00	0.000		

Chicago Cubs @ New York Giants  
Polo Grounds, New York, NY  
Tue Aug 03 1954, 3:33 AM EDT  
Att. 7,968 - Unknown

AB	34
R	7
H	12
RBI	7
BB	4
SO	6
LOB	15



WP: 0	PA: 39
PB: 0	
SB: 0	
CS: 0	

livebaseballscores.com

Batter	1	2	3	4	5	6	7	8	9	10	11	AB R H RBI BB SO LOB	TOP	
Frank Baumholtz, L (1, 8) OBP: 0.372, SLG: 0.445 (5, 9)	0-0 1B 1B	0-0 1-H 3B		0-3 K		0-0 3-1			0-0 FC4-6 1B		0-0 4-3	6 1 3 1 0 1 3	<b>Chicago Cubs @ New York Giants</b> Polo Grounds, New York, NY Wed Aug 04 1954, 3:33 AM EDT Att: 7,932 - Unknown	
Eddie Miksis, R (1, 4) OBP: 0.222, SLG: 0.253	0-0 1B 14 1B 1B	0-0 6-3		0-0 FC6-4			0-0 F9		0-0 FC4-6		0-0 4-3	6 1 1 0 0 0 6		
Dee Fondy, L (1, 3) OBP: 0.316, SLG: 0.398	0-0 F7	0-3 K			0-0 F8		0-0 G3		0-3 K			5 0 0 0 0 2 4		
Ralph Kiner, R (1, 7) OBP: 0.396, SLG: 0.523	0-0 F6		0-0 1B 2B		0-0 1B 1B		4-0 BB		0-0 F9			4 0 2 0 1 0 2		
Hal Rice, L (1, 9) OBP: 0.281, SLG: 0.238 Steve Bilko, R (5, PH) OBP: 0.300, SLG: 0.343 Bob Talbot, R (5, 8) OBP: 0.285, SLG: 0.311	0-0 14 1B 1B		0-0 G4-3 1B		0-0 1-2 1B		0-0 F8		0-0 5-3			2 0 2 1 0 0 0 1 0 1 0 0 0 0 2 0 0 0 0 0 1		
14 Ernie Banks, R (1, 6) OBP: 0.337, SLG: 0.413	0-0 1-2 3-H 1B		0-3 K		0-0 F9		0-0 5-3		0-0 F8			5 0 1 1 0 1 4		
Bill Serena, R (1, 5) OBP: 0.303, SLG: 0.387	0-0 F9		0-0 G4-3		0-0 F9		0-0 1-3		0-0 F6			5 0 0 0 0 0 6		
Walker Cooper, R (1, 2) OBP: 0.417, SLG: 0.552 Gene Baker, R (11, PR) OBP: 0.336, SLG: 0.463 El Tappe, R (11, 2) OBP: 0.252, SLG: 0.216		0-0 3B 1B		0-0 6-3		0-0 6-3		0-3 K		0-0 4-3 SH 1B		5 1 2 0 0 1 0 0 0 0 0 0 0 0 0 0 0 0 0 0 0		
Paul Minner, L (1, 1) OBP: 0.238, SLG: 0.345 Johnny Klippstein, R (4, 1) OBP: 0.161, SLG: 0.200		0-0 F7		4-0 FC6-4 BB		0-3 K		0-0 F8		0-0 SH 4-3		1 0 0 0 1 0 1 2 0 0 0 0 1 0		
<b>Inning Stats</b>	R: 2 H: 4 E: 0 LOB: 2 K: 0 BB: 0 S: 7 P: 7	R: 1 H: 2 E: 0 LOB: 1 K: 1 BB: 0 S: 7 P: 7	R: 0 H: 2 E: 0 LOB: 1 K: 1 BB: 0 S: 6 P: 6	R: 0 H: 0 E: 0 LOB: 1 K: 1 BB: 1 S: 5 P: 9	R: 0 H: 2 E: 0 LOB: 2 K: 0 BB: 0 S: 5 P: 5	R: 0 H: 0 E: 0 LOB: 0 K: 1 BB: 0 S: 5 P: 5	R: 0 H: 0 E: 0 LOB: 1 K: 0 BB: 1 S: 3 P: 7	R: 0 H: 0 E: 0 LOB: 0 K: 1 BB: 0 S: 5 P: 5	R: 0 H: 1 E: 0 LOB: 1 K: 1 BB: 0 S: 6 P: 6	R: 0 H: 0 E: 0 LOB: 0 K: 0 BB: 0 S: 3 P: 3	R: 0 H: 1 E: 0 LOB: 3 K: 0 BB: 0 S: 5 P: 5	1B: 10 SF: 0 2B: 1 SAC: 1 3B: 1 DP: 1 HR: 0 HBP: 0		WP: 0 PA: 47 PB: 0 SB: 0 CS: 0
<b>PITCHER</b>	IP WLS BF H R ER SO BB IBB HBP BLK WP HR S P ERA WHIP													
Sal Maglie, R (1, 1) ERA: 3.49	1.1 10 6 3 3 0 0 0 0 0 0 0 0 10 10 20.25 4.500													
Al Worthington, R (2, 1) ERA:	1.2 6 2 0 0 2 0 0 0 0 0 0 0 10 10 0.00 1.200													
Windy McCall, L (4, 1) ERA: 3.07	1.0 4 0 0 0 1 1 0 0 0 0 0 0 5 9 0.00 1.000													
Don Liddle, L (5, 1) ERA: 2.88	7.0 W 27 4 0 0 3 1 0 0 0 0 0 0 32 36 0.00 0.714													

AB	44
R	3
H	12
RBI	3
BB	2
SO	6
LOB	27



livebaseballscorecards.com

BOTTOM

Chicago Cubs @ New York Giants  
Polo Grounds, New York, NY  
Wed Aug 04 1954, 3:33 AM EDT  
Att: 7,932 - Unknown

livebaseballscores.com

AB	41
R	4
H	12
RBI	4
BB	5
SO	2
LOB	20



WP:	0	PA:	48
PB:	0		
SB:	0		
CS:	0		

AB	R	H	RBI	BB	SO	LOB
5	0	1	0	1	0	0
6	0	1	0	0	0	5
5	1	3	1	1	0	1
4	1	1	0	0	0	4
4	0	1	1	1	0	0
5	1	1	1	0	2	3
5	0	2	0	0	0	3
4	1	2	1	1	0	1
0	0	0	0	0	0	0
0	0	0	0	0	0	0
1	0	0	0	0	0	1
0	0	0	0	0	0	0
1	0	0	0	0	0	2
1	0	0	0	1	0	0

Batter	1	2	3	4	5	6	7	8	9	10	11
Whitey Lockman, L OBP: 0.332, SLG: 0.409	4-3		F7		F3		G1-2-3 1B		G3		1B IBB
Alvin Dark, R OBP: 0.316, SLG: 0.418	F7			F9	FC5-4 1B		G1-2-3		F9		F7
Hank Thompson, L OBP: 0.385, SLG: 0.482	4-3			1B 1B	F8		IBB			SH3-4 1B	1-2 2-H 1B
Monte Irvin, R OBP: 0.376, SLG: 0.469		6-3		1B FC6-4 1B	FC5-4		F7			SH3-4 1-2	
Don Mueller, L OBP: 0.359, SLG: 0.437		6-3		FC6-4 1B		4-3		F9		FC6-4 IBB	
Willie Mays, R OBP: 0.392, SLG: 0.678				FC6-4 1B		K		K		F8	
Davey Williams, R OBP: 0.294, SLG: 0.332				1B 1B		5-3		1B		FC6-4	
Wes Westrum, R OBP: 0.325, SLG: 0.345								E5 1B BB		F8	SH1-4 1B 1B
Sal Maglie, R OBP: 0.163, SLG: 0.109											
Al Worthington, R											
Foster Castleman, R											
Windy McCall, L											
Bobby Hofman, R											
Don Liddle, L											

Inning	R	H	E	K	S
1	0	0	0	0	3
2	0	1	0	0	4
3	0	0	0	0	2
4	3	5	0	0	8
5	0	1	0	0	4
6	0	0	0	1	5
7	0	1	1	0	12
8	0	1	0	0	6
9	0	0	0	0	3
10	0	1	0	1	8
11	1	2	0	1	8

PITCHER	IP	WLS	BF	H	R	ER	SO	BB	IBB	HBP	BLK	WP	HR	S	P	ERA	WHIP
Paul Minner, L ERA: 3.54	3.2		17	6	3	3	0	1	0	0	0	0	0	16	20	7.36	1.909
Johnny Klippstein, R ERA: 6.26	7.0	L	31	6	1	1	2	1	3	0	0	0	0	31	47	1.29	1.000

PITCHER	IP	WLS	BF	H	R	ER	SO	BB	IBB	HBP	BLK	WP	HR	S	P	ERA	WHIP
Paul Minner, L ERA: 3.54	3.2		17	6	3	3	0	1	0	0	0	0	0	16	20	7.36	1.909
Johnny Klippstein, R ERA: 6.26	7.0	L	31	6	1	1	2	1	3	0	0	0	0	31	47	1.29	1.000

PITCHER	IP	WLS	BF	H	R	ER	SO	BB	IBB	HBP	BLK	WP	HR	S	P	ERA	WHIP
Paul Minner, L ERA: 3.54	3.2		17	6	3	3	0	1	0	0	0	0	0	16	20	7.36	1.909
Johnny Klippstein, R ERA: 6.26	7.0	L	31	6	1	1	2	1	3	0	0	0	0	31	47	1.29	1.000

PITCHER	IP	WLS	BF	H	R	ER	SO	BB	IBB	HBP	BLK	WP	HR	S	P	ERA	WHIP
Paul Minner, L ERA: 3.54	3.2		17	6	3	3	0	1	0	0	0	0	0	16	20	7.36	1.909
Johnny Klippstein, R ERA: 6.26	7.0	L	31	6	1	1	2	1	3	0	0	0	0	31	47	1.29	1.000

PITCHER	IP	WLS	BF	H	R	ER	SO	BB	IBB	HBP	BLK	WP	HR	S	P	ERA	WHIP
Paul Minner, L ERA: 3.54	3.2		17	6	3	3	0	1	0	0	0	0	0	16	20	7.36	1.909
Johnny Klippstein, R ERA: 6.26	7.0	L	31	6	1	1	2	1	3	0	0	0	0	31	47	1.29	1.000

PITCHER	IP	WLS	BF	H	R	ER	SO	BB	IBB	HBP	BLK	WP	HR	S	P	ERA	WHIP
Paul Minner, L ERA: 3.54	3.2		17	6	3	3	0	1	0	0	0	0	0	16	20	7.36	1.909
Johnny Klippstein, R ERA: 6.26	7.0	L	31	6	1	1	2	1	3	0	0	0	0	31	47	1.29	1.000

PITCHER	IP	WLS	BF	H	R	ER	SO	BB	IBB	HBP	BLK	WP	HR	S	P	ERA	WHIP
Paul Minner, L ERA: 3.54	3.2		17	6	3	3	0	1	0	0	0	0	0	16	20	7.36	1.909
Johnny Klippstein, R ERA: 6.26	7.0	L	31	6	1	1	2	1	3	0	0	0	0	31	47	1.29	1.000

PITCHER	IP	WLS	BF	H	R	ER	SO	BB	IBB	HBP	BLK	WP	HR	S	P	ERA	WHIP
Paul Minner, L ERA: 3.54	3.2		17	6	3	3	0	1	0	0	0	0	0	16	20	7.36	1.909
Johnny Klippstein, R ERA: 6.26	7.0	L	31	6	1	1	2	1	3	0	0	0	0	31	47	1.29	1.000

PITCHER	IP	WLS	BF	H	R	ER	SO	BB	IBB	HBP	BLK	WP	HR	S	P	ERA	WHIP
Paul Minner, L ERA: 3.54	3.2		17	6	3	3	0	1	0	0	0	0	0	16	20	7.36	1.909
Johnny Klippstein, R ERA: 6.26	7.0	L	31	6	1	1	2	1	3	0	0	0	0	31	47	1.29	1.000

PITCHER	IP	WLS	BF	H	R	ER	SO	BB	IBB	HBP	BLK	WP	HR	S	P	ERA	WHIP
Paul Minner, L ERA: 3.54	3.2		17	6	3	3	0	1	0	0	0	0	0	16	20	7.36	1.909
Johnny Klippstein, R ERA: 6.26	7.0	L	31	6	1	1	2	1	3	0	0	0	0	31	47	1.29	1.000

Batter	1	2	3	4	5	6	7	8	9	AB R H RBI BB SO LOB	TOP	
<b>Frank Baumholtz, L</b> (1, 8) <small>OBP: 0.369, SLG: 0.453</small> <b>Bob Talbot, R</b> (8, 8) <small>OBP: 0.285, SLG: 0.311</small>	0-3 		0-0 		0-0 	0-0 4-3		0-0 		5 1 1 1 0 1 2 0 0 0 0 0 0 0	<b>Chicago Cubs @ New York Giants</b> Polo Grounds, New York, NY Thu Aug 05 1954, 3:33 AM EDT Att. 5,563 - Unknown  <b>livebaseballscorecards.com</b>  <b>AB 41</b> <b>R 6</b> <b>H 14</b> <b>RBI 5</b> <b>BB 1</b> <b>SO 4</b> <b>LOB 20</b>  	
<b>Gene Baker, R</b> (1, 4) <small>OBP: 0.334, SLG: 0.462</small>	0-0 		0-0 		0-0 		0-0 		0-0 	5 0 1 0 0 0 0		
<b>Dee Fondy, L</b> (1, 3) <small>OBP: 0.319, SLG: 0.403</small>	0-0 			0-0 	0-0 		0-0 1-3		0-0 	5 1 3 0 0 0 1		
<b>Ralph Kiner, R</b> (1, 7) <small>OBP: 0.398, SLG: 0.523</small>	0-0 			0-0 	4-0 		0-0 6-3		0-0 	4 1 2 0 1 0 1		
<b>Hank Sauer, R</b> (1, 9) <small>OBP: 0.401, SLG: 0.618</small>		0-0 		0-0 	0-0 			0-0 	0-0 	5 1 2 0 0 0 4		
<b>14 Ernie Banks, R</b> (1, 6) <small>OBP: 0.338, SLG: 0.420</small>	0-3 		0-0 	0-0 	0-0 			0-0 	0-0 	5 1 2 3 0 1 5		
<b>Eddie Miksis, R</b> (1, 5) <small>OBP: 0.234, SLG: 0.297</small>		0-0 5-3		0-0 	0-0 		0-0 			4 1 2 1 0 0 3		
<b>Walker Cooper, R</b> (1, 2) <small>OBP: 0.405, SLG: 0.535</small>	0-3 			0-0 	0-0 		0-0 		0-3 	4 0 0 0 0 2 2		
<b>Warren Hacker, R</b> (1, 1) <small>OBP: 0.213, SLG: 0.239</small> <b>Hal Rice, L</b> (6, PH) <small>OBP: 0.279, SLG: 0.236</small> <b>Hal Jeffcoat, R</b> (6, 1) <small>OBP: 0.368, SLG: 0.688</small> <b>Jim Davis, S</b> (8, 1) <small>OBP: 0.286, SLG: 0.048</small>			0-0 4-3	0-0 		0-0 		0-0 	0-0 	2 0 0 0 0 0 1 1 0 0 0 0 0 1 1 0 1 0 0 0 0 0 0 0 0 0 0 0		
<b>Inning Stats</b>	R: 0 H: 1 E: 0 LOB: 1 K: 1 BB: 0 S: 6 P: 6	R: 0 H: 1 E: 0 LOB: 1 K: 2 BB: 0 S: 8 P: 8	R: 0 H: 0 E: 0 LOB: 0 K: 0 BB: 0 S: 3 P: 3	R: 3 H: 3 E: 1 LOB: 1 K: 0 BB: 0 S: 7 P: 7	R: 1 H: 2 E: 0 LOB: 2 K: 0 BB: 1 S: 5 P: 9	R: 0 H: 1 E: 0 LOB: 1 K: 0 BB: 0 S: 4 P: 4	R: 0 H: 0 E: 0 LOB: 0 K: 0 BB: 0 S: 3 P: 3	R: 2 H: 3 E: 0 LOB: 1 K: 1 BB: 0 S: 8 P: 8	R: 0 H: 3 E: 0 LOB: 2 K: 0 BB: 0 S: 5 P: 5	1B: 9 SF: 0 2B: 2 SAC: 0 3B: 0 DP: 1 HR: 3 HBP: 0	WP: 0 PA: 42 PB: 0 SB: 2 CS: 0	
<b>PITCHER</b> <b>Jim Hearn, R</b> (1, 1) <small>ERA: 4.0</small> <b>Mary Grissom, R</b> (8, 1) <small>ERA: 2.2</small>	IP WLS BF H R ER SO BB IBB HBP BLK WP HR S P ERA WHIP 7.1 L 34 10 6 5 3 1 0 0 0 0 0 3 39 43 6.14 1.500											IP WLS BF H R ER SO BB IBB HBP BLK WP HR S P ERA WHIP 1.2 8 4 0 0 1 0 0 0 0 0 0 0 10 10 0.00 2.400

Batter	1	2	3	4	5	6	7	8	9	AB	R	H	RBI	BB	SO	LOB
Whitey Lockman, L (1, 3) OBP: 0.329, SLG: 0.405	0-0 G3		0-0 F9		0-0 1-3		0-0 3-1			4	0	0	0	0	0	1
Alvin Dark, R (1, 6) OBP: 0.317, SLG: 0.425	0-0 F5		0-0 1-3		HR			SH3-4 BB		4	1	2	1	0	0	0
Hank Thompson, L (1, 5) OBP: 0.386, SLG: 0.480 (9, 7)	1B			3-1	K			SH3-4 BB		3	0	1	0	1	1	0
Dusty Rhodes, L (1, 7) OBP: 0.440, SLG: 0.803 Bobby Hofman, R (8, PH) OBP: 0.274, SLG: 0.421 (9, 5)	0-0 F9		0-0 G3			1-0 G4-6-3 HBP		SH3-4		2	0	0	0	0	0	1
Don Mueller, L (1, 9) OBP: 0.355, SLG: 0.433		0-0 F5		0-0 F3		0-0 G4-6-3		F6		4	0	0	0	0	0	3
Willie Mays, R (1, 8) OBP: 0.391, SLG: 0.676		0-0 F9			1B	0-0 F4		F7		4	1	1	0	0	0	2
Davey Williams, R (1, 4) OBP: 0.299, SLG: 0.337		0-0			HR		6-3		G6-4-3 1B	4	1	3	1	0	0	0
Wes Westrum, R (1, 2) OBP: 0.323, SLG: 0.344 Bill Taylor, L (5, PH) OBP: 0.259, SLG: 0.347 Ray Katt, R (6, 2) OBP: 0.317, SLG: 0.419		0-3 K			HR	6-3		K		1	0	0	0	0	1	1
Jim Hearn, R (1, 1) OBP: 0.163, SLG: 0.200 Marv Grissom, R (8, 1) OBP: 0.167, SLG: 0.130 Monte Irvin, R (9, PH) OBP: 0.375, SLG: 0.467			0-3 K		K		E4		G6-4-3	3	0	0	0	0	2	0

Inning Stats	R: 0	H: 1	E: 0	LOB: 1	K: 0	BB: 0	S: 4	R: 0	H: 1	E: 0	LOB: 1	K: 1	BB: 0	S: 6	R: 0	H: 0	E: 0	LOB: 0	K: 1	BB: 0	S: 5	R: 0	H: 0	E: 0	LOB: 0	K: 0	BB: 0	S: 3	R: 4	H: 4	E: 0	LOB: 0	K: 2	BB: 0	S: 11	R: 0	H: 0	E: 1	LOB: 1	K: 0	BB: 0	S: 4	R: 0	H: 1	E: 0	LOB: 2	K: 0	BB: 1	S: 4	R: 0	H: 1	E: 0	LOB: 0	K: 1	BB: 0	S: 5	1B: 5	SF: 0	3B: 0	DP: 2	HR: 2	HBP: 1	WP: 0	PA: 36
--------------	------	------	------	--------	------	-------	------	------	------	------	--------	------	-------	------	------	------	------	--------	------	-------	------	------	------	------	--------	------	-------	------	------	------	------	--------	------	-------	-------	------	------	------	--------	------	-------	------	------	------	------	--------	------	-------	------	------	------	------	--------	------	-------	------	-------	-------	-------	-------	-------	--------	-------	--------

PITCHER	IP	WLS	BF	H	R	ER	SO	BB	IBB	HBP	BLK	WP	HR	S	P	ERA	WHIP
Warren Hacker, R (1, 1) ERA: 4.05	5.0		21	6	4	4	4	0	0	0	0	0	2	29	29	7.20	1.200
Hal Jeffcoat, R (6, 1) ERA: 5.46	2.0	W	9	1	0	0	0	1	0	1	0	0	0	7	12	0.00	1.000
Jim Davis, L (8, 1) ERA: 3.51	2.0	S	6	1	0	0	1	0	0	0	0	0	0	8	8	0.00	0.500

BOTTOM

Chicago Cubs @ New York Giants  
Polo Grounds, New York, NY  
Thu Aug 05 1954, 3:33 AM EDT  
Att. 5,563 - Unknown

livebaseballscorecards.com

AB	33
R	4
H	8
RBI	4
BB	1
SO	5
LOB	10



Milwaukee Braves @ New York Giants  
 Polo Grounds, New York, NY  
 Fri Aug 06 1954, 3:33 AM EDT  
 Att: 38,485 - Unknown

livebaseballscorecards.com

AB	37
R	6
H	10
RBI	5
BB	2
SO	1
LOB	10



WP:	0	PA:	40
PB:	0		
SB:	0		
CS:	0		

AB R H RBI BB SO LOB

4	1	1	1	0	0	0
4	1	0	0	1	0	1
4	0	2	3	1	0	1
5	0	2	1	0	0	2
4	0	1	0	0	0	4
4	0	1	0	0	0	1
4	0	0	0	0	0	1
4	2	2	0	0	1	0
3	2	1	0	0	0	0
1	0	0	0	0	0	0

Batter	1	2	3	4	5	6	7	8	9
Bill Bruton, L (1, 8) OBP: 0.348, SLG: 0.371	0-0 G3		0-0 SH3-4	0-0 1B		0-0 4-3			0-0 G3
Danny O'Connell, R (1, 4) OBP: 0.310, SLG: 0.351	0-0 1-3		0-0 6-3	4-0 1B		0-0 F9			0-0 E1
Eddie Mathews, L (1, 5) OBP: 0.404, SLG: 0.563	4-0 BB		0-0 1B	0-0 1B			0-0 6-3		0-0 F9
Hank Aaron, R (1, 7) OBP: 0.319, SLG: 0.449	0-0 F6		0-0 1B	0-0 1B			0-0 5-3		0-0 1-4-3
Joe Adcock, R (1, 3) OBP: 0.377, SLG: 0.554		0-0 F7	0-0 F6	0-0 FC5-4			0-0 FC5-4		0-0 1B
Andy Pafko, R (1, 9) OBP: 0.345, SLG: 0.459		0-0 5-3		0-0 1B	0-0 F1		0-0 FC5-4		
Johnny Logan, R (1, 6) OBP: 0.337, SLG: 0.383		0-0 F6		0-0 G5-4-3	0-0 F7			0-0 F8	
Del Crandall, R (1, 2) OBP: 0.320, SLG: 0.426			0-0 E	0-0 1B	0-3 K			0-0 6-3	
Gene Conley, R (1, 1) OBP: 0.194, SLG: 0.210			0-0 E4	0-0 1B		0-0 F9		0-0 G3	
Dave Jolly, R (7, 1) OBP: 0.435, SLG: 0.591			0-0 1B	1-2 1B					

Inning Stats	R: 0	H: 0	E: 0	K: 0	S: 3	P: 7	R: 0	H: 0	E: 0	K: 0	S: 3	P: 3	R: 2	H: 3	E: 1	K: 0	S: 7	P: 7	R: 4	H: 6	E: 0	K: 0	S: 8	P: 12	R: 0	H: 0	E: 0	K: 1	S: 5	P: 5	R: 0	H: 0	E: 0	K: 0	S: 3	P: 3	R: 0	H: 1	E: 0	K: 0	S: 4	P: 4	R: 0	H: 0	E: 0	K: 0	S: 3	P: 3	R: 0	H: 0	E: 1	K: 0	S: 4	P: 4	1B: 9	SF: 0	2B: 0	SAC: 1	3B: 1	DP: 1	HR: 0	HBP: 0	WP: 0	PA: 40
--------------	------	------	------	------	------	------	------	------	------	------	------	------	------	------	------	------	------	------	------	------	------	------	------	-------	------	------	------	------	------	------	------	------	------	------	------	------	------	------	------	------	------	------	------	------	------	------	------	------	------	------	------	------	------	------	-------	-------	-------	--------	-------	-------	-------	--------	-------	--------

PITCHER	IP	WLS	BF	H	R	ER	SO	BB	IBB	HBP	BLK	WP	HR	S	P	ERA	WHIP
Johnny Antonelli, L (1, 1) ERA: 2.32	3.2	L	19	7	5	3	0	1	0	0	0	0	0	18	22	7.36	2.182
Al Worthington, R (4, 1) ERA: 3.86	0.0		3	2	1	1	0	1	0	0	0	0	0	2	6	∞	∞
Al Corwin, R (4, 1) ERA: 3.54	3.1		11	1	0	0	1	0	0	0	0	0	0	13	13	0.00	0.300
Mary Grissom, R (8, 1) ERA: 2.18	1.0		3	0	0	0	0	0	0	0	0	0	0	3	3	0.00	0.000
Windy McCall, L (9, 1) ERA: 3.0	1.0		4	0	0	0	0	0	0	0	0	0	0	4	4	0.00	0.000









Batter	1	2	3	4	5	6	7	8	9	AB R H RBI BB SO LOB	TOP	
Bill Bruton, L (1, 8) OBP: 0.353, SLG: 0.380	0-0 F7		0-0 F8		4-0 F8 WP 1B BB		0-0 1-3		1-0 S 2B HBP	3 2 0 0 1 0 1		
Danny O'Connell, R (1, 4) OBP: 0.310, SLG: 0.349	0-0 F9		0-3 K		0-0 F8		0-0 6-3		0-0 F8	5 0 0 0 0 1 3		
Eddie Mathews, L (1, 5) OBP: 0.411, SLG: 0.580	4-0 1B BB		4-0 1-2 BB		0-0 FC5-4 1B			0-0 HR	4-0 2B IBB	2 2 2 2 3 0 0		
Hank Aaron, R (1, 7) OBP: 0.320, SLG: 0.450	0-0 1-2 1B		0-3 K		0-0 FC5-4 1-2f			0-0 S 1B	0-0 1-H 2-H 2B	5 1 3 2 0 1 3		
Joe Adcock, R (1, 3) OBP: 0.375, SLG: 0.548	0-0 F7			0-0 SH1-3 1B		0-0 FC5-4 1B		0-3 K	0-0 6-3	5 0 2 0 0 1 4		
Andy Pafko, R (1, 9) OBP: 0.345, SLG: 0.457		0-0 F8		0-0 SH1-3 1-2		0-0 F9		0-0 2-H 1B		3 0 1 1 0 0 1		
Johnny Logan, R (1, 6) OBP: 0.333, SLG: 0.378		0-0 F8		0-0 6-3		0-0 FC5-4 1-2f		0-0 F7		4 0 0 0 0 0 3		
Del Crandall, R (1, 2) OBP: 0.315, SLG: 0.416		0-3 K		0-0 5-3		0-0 5-3		0-0 F8		4 0 0 0 0 1 3		
Warren Spahn, L (1, 1) OBP: 0.324, SLG: 0.364			0-0 BB 1B		0-0 F8		0-0 1-3		0-3 K	4 0 1 0 0 1 0		
<b>Inning Stats</b>	R: 0 E: 0 K: 0 S: 4 H: 1 LOB: 2 BB: 1 P: 8	R: 0 E: 0 K: 1 S: 5 H: 0 LOB: 0 BB: 0 P: 5	R: 0 E: 0 K: 2 S: 8 H: 1 LOB: 2 BB: 1 P: 12	R: 0 E: 0 K: 0 S: 4 H: 1 LOB: 1 BB: 0 P: 4	R: 1 E: 0 K: 0 S: 4 H: 1 LOB: 1 BB: 1 P: 8	R: 0 E: 0 K: 0 S: 4 H: 1 LOB: 1 BB: 0 P: 4	R: 0 E: 0 K: 0 S: 3 H: 0 LOB: 0 BB: 0 P: 3	R: 2 E: 0 K: 1 S: 8 H: 3 LOB: 1 BB: 0 P: 8	R: 2 E: 0 K: 1 S: 6 H: 1 LOB: 1 BB: 1 P: 11	1B: 7 2B: 1 3B: 0 HR: 1 SF: 0 SAC: 1 DP: 0 HBP: 1	WP: 1 PB: 0 SB: 2 CS: 0 PA: 41	
<b>PITCHER</b>	IP WLS BF H R ER SO BB IBB HBP BLK WP HR S P ERA WHIP											
Sal Maglie, R (1, 1) ERA: 3.5	7.1 L 33 8 3 3 4 3 0 0 0 1 1 38 50 3.68 1.500											
Mary Grissom, R (8, 1) ERA: 2.35	1.2 8 1 2 2 1 0 1 1 0 0 0 8 13 10.80 0.600											

Milwaukee Braves @ New York Giants  
Polo Grounds, New York, NY  
Sun Aug 08 1954, 3:33 AM EDT  
Att: 31,070 - Unknown

livebaseballscorecards.com

AB 35  
R 5  
H 9  
RBI 5  
BB 4  
SO 5  
LOB 18







BOTTOM

New York Giants @ Pittsburgh Pirates  
Forbes Field, Pittsburgh, PA  
Tue Aug 10 1954, 3:33 AM EDT  
Att. 9,945 - Unknown

livebaseballscorecards.com

AB	28
R	1
H	3
RBI	1
BB	4
SO	5
LOB	12



WP:	0	PA:	35
PB:	0		
SB:	0		
CS:	0		

AB R H RBI BB SO LOB

4 0 1 0 0 1 0

3 0 1 0 0 0 0

2 0 0 1 0 1 0

4 0 0 0 0 0 3

4 0 0 0 0 0 3

1 0 0 0 3 1 0

3 0 1 0 0 0 2

1 0 0 0 0 0 0

3 0 0 0 0 1 3

1 0 0 0 0 1 0

1B: 2 SF: 1

2B: 1 SAC: 1

3B: 0 DP: 0

HR: 0 HBP: 1

Batter	1	2	3	4	5	6	7	8	9
<b>Curt Roberts, R</b> OBP: 0.298, SLG: 0.304 (1, 4)	0-3 K		0-0 F8			0-0 F7		0-0 FC7-6-5 2B	
<b>Eddie Pellagrini, R</b> OBP: 0.308, SLG: 0.284 (1, 5)	0-0 F7			0-0 SH2-3 1B		0-0 F8		1-0 FC7-6-5 HBP	
<b>Bob Skinner, L</b> OBP: 0.331, SLG: 0.395 (1, 3)	0-3 K			0-0 SH2-3 1-2		0-0 F9		0-0 SF7	
<b>Frank Thomas, R</b> OBP: 0.382, SLG: 0.518 (1, 8)		0-0 G3		0-0 F2		0-0 1-3		0-0 FC7-6-5 1-2 2-3f	
<b>Sid Gordon, R</b> OBP: 0.390, SLG: 0.373 (1, 9)		0-0 F8		0-0 F7		0-0 F9		0-0 F8	
<b>Jack Shepard, R</b> OBP: 0.350, SLG: 0.331 (1, 2)		4-0 FC5-4 BB		4-0 FC6-4 BB		4-0 1B BB		0-3 K	
<b>Dick Cole, R</b> OBP: 0.327, SLG: 0.348 (1, 6)		0-0 FC5-4 1-2f		0-0 F7		0-0 F7		0-0 F7	
<b>Toby Atwell, L</b> OBP: 0.404, SLG: 0.402 (9, PH)						1-2 1B			
<b>Dick Hall, R</b> OBP: 0.331, SLG: 0.327 (1, 7)			0-0 5-3		0-0 F9		0-3 K	0-3 K	
<b>Preston Ward, L</b> OBP: 0.332, SLG: 0.373 (9, PH)									
<b>Dick Littlefield, L</b> OBP: 0.161, SLG: 0.172 (1, 1)			0-0 4-3		0-0 FC6-4 1-2f			4-0 2B SF7 BB	
<b>Gair Allie, R</b> OBP: 0.298, SLG: 0.271 (8, PH)									
<b>Johnny Hetki, R</b> OBP: 0.250, SLG: 0.250 (9, 1)									

Inning Stats	R: 0	H: 0	E: 0	K: 2	S: 7	R: 0	H: 0	E: 0	K: 0	S: 3	R: 0	H: 0	E: 0	K: 0	S: 3	R: 0	H: 1	E: 0	K: 0	S: 4	R: 0	H: 0	E: 0	K: 0	S: 3	R: 0	H: 0	E: 0	K: 1	S: 6	R: 1	H: 1	E: 0	K: 0	S: 4	R: 0	H: 0	E: 0	K: 2	S: 7	1B: 2	2B: 1	3B: 0	HR: 0	SF: 1	SAC: 1	DP: 0	HBP: 1	WP: 0	PB: 0	SB: 0	CS: 0
--------------	------	------	------	------	------	------	------	------	------	------	------	------	------	------	------	------	------	------	------	------	------	------	------	------	------	------	------	------	------	------	------	------	------	------	------	------	------	------	------	------	-------	-------	-------	-------	-------	--------	-------	--------	-------	-------	-------	-------

PITCHER	IP	WLS	BF	H	R	ER	SO	BB	IBB	HBP	BLK	WP	HR	S	P	ERA	WHIP
<b>Johnny Antonelli, L</b> ERA: 2.28 (1, 1)	7.0	W	28	3	1	1	3	4	0	0	0	0	0	30	46	1.29	1.000
<b>Mary Grissom, R</b> ERA: 2.29 (8, 1)	2.0	S	7	0	0	0	2	0	0	1	0	0	0	10	11	0.00	0.000

PITCHER	IP	WLS	BF	H	R	ER	SO	BB	IBB	HBP	BLK	WP	HR	S	P	ERA	WHIP
<b>Johnny Antonelli, L</b> ERA: 2.28 (1, 1)	7.0	W	28	3	1	1	3	4	0	0	0	0	0	30	46	1.29	1.000
<b>Mary Grissom, R</b> ERA: 2.29 (8, 1)	2.0	S	7	0	0	0	2	0	0	1	0	0	0	10	11	0.00	0.000

Batter	1	2	3	4	5	6	7	8	9	AB R H RBI BB SO LOB	TOP									
Whitey Lockman, L (1, 3) OBP: 0.326, SLG: 0.396	1-0 4-3		1-1 4-3			3-3 K		1-1 F8		4 0 0 0 0 1 0										
Alvin Dark, R (1, 6) OBP: 0.323, SLG: 0.451	2-2 F8 2B			4-1 BB		0-1 5-3		1-3 K		3 0 1 0 1 1 0										
Don Mueller, L (1, 9) OBP: 0.354, SLG: 0.427	1-0 F8 2-3		1-1 F8				0-0 WP 1B 2B	2-0 1B 1B		4 1 2 0 0 0 2										
Hank Thompson, L (1, 5) OBP: 0.377, SLG: 0.465	3-3 K2-3		2-3 K				3-3 K 2-3	0-0 1-3 1B		4 0 1 0 0 3 3										
Willie Mays, R (1, 8) OBP: 0.393, SLG: 0.663		1-0 1-3		3-2 5-3			0-1 2B 1B	3-3 K		4 1 1 1 0 1 3										
Monte Irvin, R (1, 7) OBP: 0.375, SLG: 0.458		1-3 K			0-1 6-3		2-2 2B 1-H	1-0 5-3		4 0 1 1 0 1 0										
Davey Williams, R (1, 4) OBP: 0.290, SLG: 0.331		0-3 K			0-0 4-3		0-0 F2	2-1 F7		4 0 0 0 0 1 1										
Wes Westrum, R (1, 2) OBP: 0.321, SLG: 0.338			0-1 5-3		2-2 F9		4-2 BB	1-3 K		2 0 0 0 1 0 0										
Bill Taylor, L (9, PH) OBP: 0.263, SLG: 0.333										1 0 0 0 0 1 0										
Sal Maglie, R (1, 1) OBP: 0.167, SLG: 0.118			1-1 L8			2-2 6-3		0-0 G3		2 0 0 0 0 0 0										
Dusty Rhodes, L (7, PH) OBP: 0.429, SLG: 0.795										1 0 0 0 0 0 2										
Mary Grissom, R (7, 1) OBP: 0.160, SLG: 0.125										0 0 0 0 0 0 0										
<b>Inning Stats</b>	R: 0 E: 0 K: 1 S: 11	H: 1 LOB: 1 BB: 0 P: 18	R: 0 E: 0 K: 2 S: 7	H: 0 LOB: 0 BB: 0 P: 9	R: 0 E: 0 K: 0 S: 6	H: 0 LOB: 0 BB: 0 P: 8	R: 0 E: 0 K: 1 S: 11	H: 0 LOB: 1 BB: 1 P: 21	R: 0 E: 0 K: 0 S: 6	H: 0 LOB: 0 BB: 0 P: 8	R: 2 E: 0 K: 1 S: 15	H: 3 LOB: 2 BB: 1 P: 24	R: 0 E: 0 K: 2 S: 11	H: 2 LOB: 2 BB: 0 P: 18	R: 0 E: 0 K: 1 S: 6	H: 0 LOB: 0 BB: 0 P: 10	1B: 3 2B: 3 3B: 0 HR: 0	SF: 0 SAC: 0 DP: 0 HBP: 0	WP: 1 PB: 0 SB: 0 CS: 0	PA: 35
<b>PITCHER</b> Carl Erskine, R (1, 1) ERA: 3.63	IP: 9.0 WLS: W BF: 35 H: 6 R: 2 ER: 2 SO: 9 BB: 2 IBB: 0 HBP: 0 BLK: 0 WP: 1 HR: 0 S: 82 P: 130 ERA: 2.00 WHIP: 0.889																			
<b>PITCHER</b>	IP: 9.0 WLS: W BF: 35 H: 6 R: 2 ER: 2 SO: 9 BB: 2 IBB: 0 HBP: 0 BLK: 0 WP: 1 HR: 0 S: 82 P: 130 ERA: 2.00 WHIP: 0.889																			

**New York Giants @ Brooklyn Dodgers**  
 Ebbets Field, Brooklyn, NY  
 Fri Aug 13 1954, 3:33 AM EDT  
 Att: 33,467 - Unknown

livebaseballscorecards.com

<b>AB</b>	33
<b>R</b>	2
<b>H</b>	6
<b>RBI</b>	2
<b>BB</b>	2
<b>SO</b>	9
<b>LOB</b>	11





Batter	1	2	3	4	5	6	7	8	9
<b>Jim Gilliam, S</b> <small>OBP: 0.352, SLG: 0.421</small> (1, 4)	2-1 		3-1 			3-2 	3-3 		
<b>Pee Wee Reese, R</b> <small>OBP: 0.394, SLG: 0.458</small> (1, 6)	1-1 		1-1 			1-1 		2-2 	
<b>Duke Snider, L</b> <small>OBP: 0.439, SLG: 0.668</small> (1, 8)	2-3 			3-1 		0-0 		1-3 	
<b>Jackie Robinson, R</b> <small>OBP: 0.425, SLG: 0.549</small> (1, 5)	4-1 			3-1 		0-1 		2-3 	
<b>Sandy Amoros, L</b> <small>OBP: 0.309, SLG: 0.447</small> (1, 7)	0-0 			3-3 		1-1 			
<b>Gil Hodges, R</b> <small>OBP: 0.376, SLG: 0.571</small> (1, 3)		2-1 			2-1 		2-1 		
<b>Carl Furillo, R</b> <small>OBP: 0.358, SLG: 0.414</small> (1, 9)		2-1 			1-3 		1-0 		
<b>Roy Campanella, R</b> <small>OBP: 0.269, SLG: 0.425</small> (1, 2)		1-2 			1-0 		1-1 		
<b>Carl Erskine, R</b> <small>OBP: 0.189, SLG: 0.174</small> (1, 1)			0-0 			0-1 	1-0 		

AB	R	H	RBI	BB	SO	LOB
4	0	2	0	0	1	0
3	0	0	1	0	0	1
4	0	1	0	0	2	1
3	0	0	0	1	1	2
3	0	0	0	0	1	4
3	1	1	0	0	0	0
3	1	1	2	0	1	0
3	0	0	0	0	0	0
3	1	1	0	0	0	0

**BOTTOM**

**New York Giants @ Brooklyn Dodgers**  
 Ebbets Field, Brooklyn, NY  
 Fri Aug 13 1954, 3:33 AM EDT  
 Att. 33,467 - Unknown

[livebaseballscorecards.com](http://livebaseballscorecards.com)

<b>AB</b>	<b>29</b>
<b>R</b>	<b>3</b>
<b>H</b>	<b>6</b>
<b>RBI</b>	<b>3</b>
<b>BB</b>	<b>1</b>
<b>SO</b>	<b>6</b>
<b>LOB</b>	<b>8</b>



Inning Stats	R: 0	H: 1	E: 0	K: 1	S: 9	LOB: 2	BB: 1	P: 18
	R: 0	H: 0	E: 0	K: 0	S: 7	LOB: 0	BB: 0	P: 12
	R: 0	H: 0	E: 0	K: 0	S: 5	LOB: 0	BB: 0	P: 9
	R: 0	H: 0	E: 0	K: 1	S: 8	LOB: 0	BB: 0	P: 17
	R: 0	H: 0	E: 0	K: 1	S: 6	LOB: 0	BB: 0	P: 10
	R: 1	H: 3	E: 0	K: 0	S: 12	LOB: 2	BB: 0	P: 17
	R: 2	H: 2	E: 0	K: 1	S: 9	LOB: 0	BB: 0	P: 17
	R: 0	H: 0	E: 0	K: 2	S: 9	LOB: 0	BB: 0	P: 14

PITCHER	IP	WLS	BF	H	R	ER	SO	BB	IBB	HBP	BLK	WP	HR	S	P	ERA	WHIP
<b>Sal Maglie, R</b> <small>ERA: 3.43</small>	(1, 1)	6.0	23	4	1	1	3	1	0	0	1	0	0	47	83	1.50	0.833
<b>Mary Grissom, R</b> <small>ERA: 2.45</small>	(7, 1)	2.0	8	2	2	2	3	0	0	0	0	0	1	18	31	9.00	1.000

PITCHER	IP	WLS	BF	H	R	ER	SO	BB	IBB	HBP	BLK	WP	HR	S	P	ERA	WHIP

WP	HR	S	P	ERA	WHIP
0	0	0	0	0	0

**New York Giants @ Brooklyn Dodgers**  
 Ebbets Field, Brooklyn, NY  
 Sat Aug 14 1954, 3:33 AM EDT  
 Att: 28,956 - Unknown

livebaseballscorecards.com

<b>AB</b>	<b>36</b>
<b>R</b>	<b>5</b>
<b>H</b>	<b>10</b>
<b>RBI</b>	<b>5</b>
<b>BB</b>	<b>1</b>
<b>SO</b>	<b>3</b>
<b>LOB</b>	<b>12</b>



WP:	1	PA:	38
PB:	0		
SB:	0		
CS:	0		

Batter	1	2	3	4	5	6	7	8	9	AB	R	H	RBI	BB	SO	LOB
Whitey Lockman, L (1, 3) OBP: 0.323, SLG: 0.392	0-1 F7	2-1 4-3			0-0 L6	1-0 F7			1-2 F9	5	0	0	0	0	0	1
Alvin Dark, R (1, 6) OBP: 0.328, SLG: 0.458	2-0 2B 1B		1-0 4-3 WP 1B 1B		0-0 2B 1B			0-1 3B	3-2 F3	5	3	4	0	0	0	0
Don Mueller, L (1, 9) OBP: 0.353, SLG: 0.428	2-0 1B 2B		1-0 4-3		2-0 F9			0-1 F3		4	1	1	1	0	0	3
Monte Irvin, R (1, 7) OBP: 0.376, SLG: 0.457	1-2 1B 1B		3-2 4-3		4-2 2B BB			1-2 6-3		3	1	1	1	1	0	2
Willie Mays, R (1, 8) OBP: 0.394, SLG: 0.663	3-2 5-4-3 1B		1-1 1B		1-2 2B			3-1 F9		4	0	2	2	0	0	2
Hank Thompson, L (1, 5) OBP: 0.376, SLG: 0.463	0-0 FC6-4 1B		2-2 F9		1-0 F7			0-0 F6		4	0	1	1	0	0	3
Davey Williams, R (1, 4) OBP: 0.288, SLG: 0.327	1-0 FC6-4		2-2 1-3		1-0 F7			0-0 L7		4	0	0	0	0	0	1
Wes Westrum, R (1, 2) OBP: 0.321, SLG: 0.338		1-2 F4		2-3 K		1-2 SH5-4 1B		1-1 F8		3	0	1	0	0	1	0
Bill Taylor, L (8, PH) OBP: 0.259, SLG: 0.327										1	0	0	0	0	0	0
Ray Katt, R (8, 2) OBP: 0.320, SLG: 0.432										0	0	0	0	0	0	0
Ruben Gomez, R (1, 1) OBP: 0.193, SLG: 0.232		0-0 4-3		1-3 K		0-0 SH5-4			3-3 K	2	0	0	0	0	1	0
Don Liddle, L (6, 1) OBP: 0.296, SLG: 0.174										0	0	0	0	0	0	0
Windy McCall, L (6, 1)										0	0	0	0	0	0	0
Hoyt Wilhelm, R (7, 1)										0	0	0	0	0	0	0
Dusty Rhodes, L (9, PH) OBP: 0.424, SLG: 0.786										1	0	0	0	0	1	0

Inning Stats	R: 3 E: 0 K: 0 S: 12	H: 4 LOB: 1 BB: 0 P: 21	R: 0 E: 0 K: 0 S: 6	H: 0 LOB: 0 BB: 0 P: 9	R: 1 E: 0 K: 0 S: 11	H: 2 LOB: 1 BB: 0 P: 19	R: 0 E: 0 K: 2 S: 9	H: 0 LOB: 0 BB: 0 P: 14	R: 1 E: 0 K: 0 S: 9	H: 2 LOB: 2 BB: 1 P: 17	R: 0 E: 0 K: 0 S: 6	H: 1 LOB: 1 BB: 0 P: 9	R: 0 E: 0 K: 0 S: 9	H: 1 LOB: 1 BB: 0 P: 13	R: 0 E: 0 K: 0 S: 4	H: 0 LOB: 0 BB: 0 P: 5	R: 0 E: 0 K: 1 S: 10	H: 0 LOB: 0 BB: 0 P: 17	1B: 7 2B: 2 3B: 1 HR: 0	SF: 0 SAC: 1 DP: 0 HBP: 0	WP: 1 PB: 0 SB: 0 CS: 0	PA: 38
--------------	-------------------------------	----------------------------------	------------------------------	---------------------------------	-------------------------------	----------------------------------	------------------------------	----------------------------------	------------------------------	----------------------------------	------------------------------	---------------------------------	------------------------------	----------------------------------	------------------------------	---------------------------------	-------------------------------	----------------------------------	----------------------------------	------------------------------------	----------------------------------	--------

PITCHER	IP	WLS	BF	H	R	ER	SO	BB	IBB	HBP	BLK	WP	HR	S	P	ERA	WHIP
Russ Meyer, R (1, 1) ERA: 4.03	0.2		6	4	3	3	0	0	0	0	0	0	0	11	19	40.50	6.000
Clem Labine, R (1, 1) ERA: 4.08	4.1		18	4	2	2	2	1	0	0	0	1	0	36	61	4.15	1.154
Don Newcombe, R (6, 1) ERA: 4.49	1.0		4	1	0	0	0	0	0	0	0	0	0	6	9	0.00	1.000
Jim Hughes, R (7, 1) ERA: 2.8	3.0	W	10	1	0	0	1	0	0	0	0	0	0	23	35	0.00	0.333

**BOTTOM**

**New York Giants @ Brooklyn Dodgers**  
 Ebbets Field, Brooklyn, NY  
 Sat Aug 14 1954, 3:33 AM EDT  
 Att. 28,956 - Unknown

[livebaseballscorecards.com](http://livebaseballscorecards.com)

<b>AB</b>	<b>31</b>
<b>R</b>	<b>6</b>
<b>H</b>	<b>6</b>
<b>RBI</b>	<b>6</b>
<b>BB</b>	<b>8</b>
<b>SO</b>	<b>6</b>
<b>LOB</b>	<b>18</b>



WP: 0	PA: 40
PB: 1	
SB: 0	
CS: 0	

AB	R	H	RBI	BB	SO	LOB
4	0	1	0	1	0	0
3	0	0	0	2	1	3
4	0	0	0	1	2	4
4	2	2	0	1	1	1
2	2	0	0	1	0	2
4	1	0	0	0	0	4
4	1	1	4	0	0	2
3	0	2	2	1	1	0
0	0	0	0	0	0	0
0	0	0	0	1	0	0
1	0	0	0	0	1	0
0	0	0	0	0	0	0
1	0	0	0	0	0	1
1	0	0	0	0	0	1

1B: 5	SF: 0
2B: 0	SAC: 1
3B: 0	DP: 0
HR: 1	HBP: 0

Batter	1	2	3	4	5	6	7	8	9
<b>Jim Gilliam, S</b> OBP: 0.353, SLG: 0.419 (1, 4)	3-2 4-3 BB	4-0 1-2 2-3 BB			0-2 1-3 BB	1-0 1-2 BB 1B		3-2 G3	
<b>Pee Wee Reese, R</b> OBP: 0.394, SLG: 0.454 (1, 6)	4-2 1B BB	2-1 FC5 2-3f			0-1 5-3 BB	4-1 1-2 2-3 BB		1-3 K	
<b>Duke Snider, L</b> OBP: 0.437, SLG: 0.662 (1, 8)	0-0 F7		1-0 6-3			K		4-1 PB BB	
<b>Gil Hodges, R</b> OBP: 0.379, SLG: 0.571 (1, 3)	1-2 1-2 1B		3-2 5-3			4-1 E BB HR BB	2-2 SH 1B 1B	1-3 K	
<b>Sandy Amoros, L</b> OBP: 0.309, SLG: 0.440 (1, 7)	0-1 3-1		1-1 F8			4-0 1-2 HR BB	0-0 SH 1B		
<b>Jackie Robinson, R</b> OBP: 0.421, SLG: 0.542 (1, 5)		3-2 5-3		1-2 F6		0-0 1-2 2-3 HR	1-0 F3		
<b>Carl Furillo, R</b> OBP: 0.357, SLG: 0.420 (1, 9)		2-2 1-3		0-1 L5		0-0 1-4 2-H 3-H HR	1-0 5-3		
<b>Roy Campanella, R</b> OBP: 0.274, SLG: 0.427 (1, 2)		4-2 BB BB BB		1-3 K		1-2 BB 1B 1B	1-1 FC6-4 1B		
<b>Russ Meyer, S</b> OBP: 0.082, SLG: 0.030 (1, 1)		4-2 FC5 BB				0-3 K	3-2 F3	0-1 FC6-4	
<b>Clem Labine, R</b> OBP: 0.208, SLG: 0.050 (5, PH)									
<b>Don Newcombe, L</b> OBP: 0.390, SLG: 0.333 (6, 1)									
<b>Walt Morin, L</b> OBP: 0.082, SLG: 0.429 (6, PH)									
<b>Don Hoak, R</b> OBP: 0.318, SLG: 0.411 (6, PH)									
<b>Jim Hughes, R</b> OBP: 0.091, SLG: 0.091 (7, 1)									

Inning Stats	R: 0	H: 1	E: 0	K: 0	S: 12	LOB: 2	BB: 1	P: 20	R: 0	H: 0	E: 0	K: 0	S: 12	LOB: 3	BB: 3	P: 31	R: 0	H: 0	E: 0	K: 0	S: 6	LOB: 0	BB: 0	P: 11	R: 0	H: 0	E: 0	K: 1	S: 8	LOB: 0	BB: 0	P: 10	R: 4	H: 3	E: 1	K: 2	S: 20	LOB: 3	BB: 3	P: 38	R: 2	H: 2	E: 1	K: 0	S: 14	LOB: 1	BB: 0	P: 19	R: 0	H: 0	E: 0	K: 2	S: 10	LOB: 1	BB: 1	P: 19
--------------	------	------	------	------	-------	--------	-------	-------	------	------	------	------	-------	--------	-------	-------	------	------	------	------	------	--------	-------	-------	------	------	------	------	------	--------	-------	-------	------	------	------	------	-------	--------	-------	-------	------	------	------	------	-------	--------	-------	-------	------	------	------	------	-------	--------	-------	-------

PITCHER	IP	WLS	BF	H	R	ER	SO	BB	IBB	HBP	BLK	WP	HR	S	P	ERA	WHIP
<b>Ruben Gomez, R</b> ERA: 3.21 (1, 1)	5.1		26	3	4	3	3	6	0	0	0	0	1	56	99	5.06	1.688
<b>Don Liddle, L</b> ERA: 2.87 (6, 1)	0.1		3	1	0	0	0	1	0	0	0	0	0	6	14	0.00	6.000
<b>Windy McCall, L</b> ERA: 2.95 (6, 1)	0.1	L	3	1	2	0	1	0	0	0	0	0	0	12	15	0.00	3.000
<b>Hoyt Wilhelm, R</b> ERA: 3.09 (7, 1)	2.0		8	1	0	0	2	1	0	0	0	0	0	16	28	0.00	1.000

Batter	1	2	3	4	5	6	7	8	9	AB R H RBI BB SO LOB	TOP																					
<b>Whitey Lockman, L</b> (1, 3) OBP: 0.319, SLG: 0.387	0-0 F2		0-1 4-3		2-1 F9		2-2 1-3		0-1 G3	5 0 0 0 0 0 0																						
<b>Alvin Dark, R</b> (1, 6) OBP: 0.333, SLG: 0.468	2-1 G1-6-3 1B		0-1 BB 1B		2-1 IHR			4-2 4-3 BB		3 1 3 1 1 0 0																						
<b>Hank Thompson, L</b> (1, 5) OBP: 0.377, SLG: 0.470	1-1 G1-6-3 1-2f		4-1 BB		1-0 HR			0-2 G3 1-2		3 1 1 1 1 0 2																						
<b>Monte Irvin, R</b> (1, 7) OBP: 0.375, SLG: 0.454		4-1 2B BB	2-2 F9		1-3 K			2-2 4-3 2-3		3 0 0 0 1 1 3																						
<b>Don Mueller, L</b> (1, 9) OBP: 0.352, SLG: 0.428		1-1 1-3 2B	0-0 3-1		0-0 F4			1-0 3-1		4 0 1 0 0 0 3																						
<b>Willie Mays, R</b> (1, 8) OBP: 0.395, SLG: 0.668		4-1 BB		2-2 6-3		0-0 5-3			0-0 HR	3 1 1 1 1 0 0																						
<b>Davey Williams, R</b> (1, 4) OBP: 0.285, SLG: 0.324		2-3 K		0-0 F8		2-3 K			1-0 F3	4 0 0 0 0 2 3																						
<b>Wes Westrum, R</b> (1, 2) OBP: 0.319, SLG: 0.335 <b>Bobby Hofman, R</b> (7, PH) OBP: 0.265, SLG: 0.397 <b>Ray Katt, R</b> (7, 2) OBP: 0.326, SLG: 0.464		3-3 K		1-2 5-3			0-0 F8		0-1 HR	2 0 0 0 0 1 3 1 0 0 0 0 0 0 1 1 1 1 0 0 0																						
<b>Jim Hearn, R</b> (1, 1) OBP: 0.199, SLG: 0.195 <b>Al Corwin, R</b> (2, 1) <b>Marv Grissom, R</b> (5, 1) OBP: 0.190, SLG: 0.125 <b>Bill Taylor, L</b> (7, PH) OBP: 0.254, SLG: 0.321 <b>Paul Giel, R</b> (7, 1) <b>Al Worthington, R</b> (7, 1) <b>Dusty Rhodes, L</b> (9, PH) OBP: 0.419, SLG: 0.776		1-3 K		0-3 K			1-3 K		1-0 F9	1 0 0 0 0 1 3 1 0 0 0 0 1 0 0 0 0 0 0 0 0 1 0 0 0 0 1 0 0 0 0 0 0 0 0 0 0 0 0 0 0 0 1 0 0 0 0 0 0																						
<b>Inning Stats</b>	R: 0 E: 0 K: 0 S: 5	H: 1 LOB: 0 BB: 0 P: 8	R: 0 E: 0 K: 3 S: 13	H: 1 LOB: 3 BB: 2 P: 28	R: 0 E: 0 K: 0 S: 9	H: 0 LOB: 0 BB: 0 P: 15	R: 2 E: 0 K: 0 S: 11	H: 2 LOB: 0 BB: 0 P: 17	R: 0 E: 0 K: 1 S: 5	H: 0 LOB: 0 BB: 0 P: 7	R: 0 E: 0 K: 1 S: 7	H: 0 LOB: 0 BB: 0 P: 10	R: 0 E: 0 K: 0 S: 11	H: 0 LOB: 1 BB: 1 P: 18	R: 2 E: 0 K: 0 S: 7	H: 2 LOB: 0 BB: 0 P: 9	1B: 2 2B: 1 3B: 0 HR: 4	SF: 0 SAC: 0 DP: 1 HBP: 0	WP: 0 PB: 0 SB: 0 CS: 0	PA: 37												
<b>PITCHER</b> <b>Billy Loes, R</b> (1, 1) ERA: 4.2	IP 9.0	WLS W	BF 37	H 7	R 4	ER 4	SO 7	BB 4	IBB 0	HBP 0	BLK 0	WP 0	HR 3	S 76	P 123	ERA 4.00	WHIP 1.222															
											<b>PITCHER</b>	IP	WLS	BF	H	R	ER	SO	BB	IBB	HBP	BLK	WP	HR	S	P	ERA	WHIP				

**New York Giants @ Brooklyn Dodgers**  
**Ebbets Field, Brooklyn, NY**  
 Sun Aug 15 1954, 3:33 AM EDT  
 Att: 29,271 - Unknown

[livebaseballscorecards.com](http://livebaseballscorecards.com)

**AB 33**  
**R 4**  
**H 7**  
**RBI 4**  
**BB 4**  
**SO 7**  
**LOB 17**



Batter	1	2	3	4	5	6	7	8	9	AB	R	H	RBI	BB	SO	LOB
Jim Gilliam, S OBP: 0.355, SLG: 0.421 (1, 4)	2-1 F9	2-1 1B			1-2 HR 1B	1-1 6-3		0-0 CS 1B		5	1	3	2	0	0	0
Pee Wee Reese, R OBP: 0.392, SLG: 0.450 (1, 6)	2-2 L8	1-0 5-3			2-3 K 1B	2-1 1-6-3		4-2 4-3 BB		4	0	0	0	1	1	3
Duke Snider, L OBP: 0.437, SLG: 0.665 (1, 8)	3-1 1-3				0-1 HR		2-1 F8	1-1 4-3		4	2	1	2	1	0	1
Gil Hodges, R OBP: 0.381, SLG: 0.577 (1, 3)					0-1 HR		1-0 BB 2B 1B	1-2 5-3		4	2	2	1	1	0	2
Sandy Amoros, L OBP: 0.315, SLG: 0.433 (1, 7)					1-1 F9		4-1 2B BB			2	1	0	0	2	0	1
Jackie Robinson, R OBP: 0.424, SLG: 0.551 (1, 5)					1-0 1B 2B		1-0 BB 2B			2	2	2	2	1	0	0
Carl Furillo, R OBP: 0.356, SLG: 0.418 (1, 9)					2-2 1B		3-3 K 1B			4	0	1	1	0	1	4
Roy Campanella, R OBP: 0.277, SLG: 0.424 (1, 2)					3-2 F6		4-0 IBB			2	1	0	0	2	0	1
Billy Loes, R OBP: 0.167, SLG: 0.143 (1, 1)					1-3 K		0-0 6-3			3	0	0	1	1	2	3

Inning Stats	R: 0	H: 0	E: 0	K: 0	S: 7	LOB: 0	BB: 0	P: 14	R: 3	H: 1	E: 1	K: 0	S: 11	LOB: 2	BB: 4	P: 31	R: 1	H: 0	E: 0	K: 0	S: 7	LOB: 0	BB: 2	P: 19	R: 0	H: 0	E: 0	K: 1	S: 6	LOB: 0	BB: 0	P: 9	R: 4	H: 5	E: 0	K: 1	S: 19	LOB: 1	BB: 0	P: 29	R: 0	H: 0	E: 0	K: 0	S: 5	LOB: 0	BB: 0	P: 8	R: 1	H: 2	E: 0	K: 2	S: 11	LOB: 3	BB: 2	P: 27	R: 0	H: 1	E: 0	K: 0	S: 8	LOB: 1	BB: 1	P: 14
1B: 5	SF: 1	3B: 0	SAC: 0	HR: 2	DP: 0	HBP: 0	WP: 0	PA: 41																																																								

PITCHER	IP	WLS	BF	H	R	ER	SO	BB	IBB	HBP	BLK	WP	HR	S	P	ERA	WHIP
Jim Hearn, R (1, 1)	1.2	L	10	1	3	3	0	4	0	0	0	0	0	17	43	16.20	3.000
Al Corwin, R (2, 1)	2.2		12	3	4	4	2	2	0	0	0	0	2	24	43	13.50	1.875
Mary Grissom, R (5, 1)	1.2		7	2	1	1	0	0	0	0	0	0	0	14	24	5.40	1.200
Paul Giel, R (7, 1)	0.1		4	2	1	1	0	1	0	0	0	0	0	5	13	27.00	9.000
Al Worthington, R (7, 1)	1.2		7	1	0	0	2	1	1	0	0	0	0	14	28	0.00	1.200

BOTTOM

New York Giants @ Brooklyn Dodgers  
Ebbets Field, Brooklyn, NY  
Sun Aug 15 1954, 3:33 AM EDT  
Att. 29,271 - Unknown

livebaseballscorecards.com

AB	30
R	9
H	9
RBI	9
BB	9
SO	4
LOB	15



Batter	1	2	3	4	5	6	7	8	9	AB R H RBI BB SO LOB	
<b>Richie Ashburn, L</b> OBP: 0.440, SLG: 0.380 (1, 8) <small>BB</small>	4-0 BB G6-4-3		0-0 5-3			0-3 K		0-3 K		3 0 0 0 1 2 0	
<b>Bobby Morgan, R</b> OBP: 0.376, SLG: 0.458 (1, 6) <small>X</small> (3, 4)	0-0 G6-4-3 1-2f			0-0 5-3		0-0 2B		0-0 1B 2B 2B		4 1 2 0 0 0 1	
<b>Stan Lopata, R</b> OBP: 0.381, SLG: 0.520 (1, 2) <small>SS</small>	0-3 K			0-0 F3		0-0 F7		0-3 K		4 0 0 0 0 2 2	
<b>Granny Hamner, R</b> OBP: 0.370, SLG: 0.500 <b>Ted Kazanski, R</b> OBP: 0.168, SLG: 0.188 (1, 4) <small>X</small> (3, 6)		0-0 E6 G6-4-3 1B		0-0 6-3		0-3 K		0-0 2B 2-3 1B		1 0 0 0 0 0 0 3 0 1 0 0 1 1	
<b>Del Ennis, R</b> OBP: 0.317, SLG: 0.456 (1, 9) <small>X</small>		0-0 G6-4-3 1-2 1B			0-0 HR		0-0 5-3	0-0 1-3 3-H 2B		4 1 3 2 0 0 0	
<b>Danny Schell, R</b> OBP: 0.328, SLG: 0.450 (1, 7) <small>X</small>		0-0 G6-4-3 1-2f 2-3			0-0 F9		0-0 F8	0-0 F3		4 0 0 0 0 0 4	
<b>Earl Torgeson, L</b> OBP: 0.376, SLG: 0.375 (1, 3) <small>SS</small>		0-3 K			0-0 1-3		0-0 1-3	0-0 4-3		4 0 0 0 0 1 3	
<b>Willie Jones, R</b> OBP: 0.327, SLG: 0.398 (1, 5) <small>X</small>			0-0 F7		0-0 HR		0-0 F8			3 1 1 1 0 0 0	
<b>Curt Simmons, L</b> OBP: 0.216, SLG: 0.183 <b>Steve Ridzik, R</b> OBP: 0.211, SLG: 0.316 <b>Mel Clark, R</b> OBP: 0.291, SLG: 0.313 <b>Jim Konstanty, R</b> (8, 1)			0-3 K		0-0 5-3		0-3 K2-3			1 0 0 0 0 1 0 1 0 0 0 0 0 0 1 0 0 0 0 1 0 0 0 0 0 0 0 0	
<b>Inning Stats</b>	R: 0 E: 0 K: 1 S: 4 H: 0 LOB: 0 BB: 1 P: 8	R: 0 E: 1 K: 1 S: 6 H: 1 LOB: 1 BB: 0 P: 6	R: 0 E: 0 K: 1 S: 5 H: 0 LOB: 0 BB: 0 P: 5	R: 0 E: 0 K: 0 S: 3 H: 0 LOB: 0 BB: 0 P: 3	R: 2 E: 0 K: 0 S: 5 H: 2 LOB: 0 BB: 0 P: 5	R: 0 E: 0 K: 2 S: 8 H: 1 LOB: 1 BB: 0 P: 8	R: 0 E: 0 K: 0 S: 3 H: 0 LOB: 0 BB: 0 P: 3	R: 0 E: 0 K: 2 S: 7 H: 0 LOB: 0 BB: 0 P: 7	R: 1 E: 0 K: 1 S: 8 H: 3 LOB: 2 BB: 0 P: 8	1B: 2 2B: 3 3B: 0 HR: 2 SF: 0 SAC: 0 DP: 2 HBP: 0	WP: 0 PB: 0 SB: 0 CS: 0 PA: 34

PITCHER	IP	WLS	BF	H	R	ER	SO	BB	IBB	HBP	BLK	WP	HR	S	P	ERA	WHIP
<b>Johnny Antonelli, L</b> ERA: 2.32 (1, 1)	9.0	W	34	7	3	3	8	1	0	0	0	0	2	49	53	3.00	0.889

**TOP**

**Philadelphia Phillies @ New York Giants**  
Polo Grounds, New York, NY

Tue Aug 17 1954, 3:33 AM EDT  
Att: 15,688 - Unknown

<b>AB</b>	<b>33</b>
<b>R</b>	<b>3</b>
<b>H</b>	<b>7</b>
<b>RBI</b>	<b>3</b>
<b>BB</b>	<b>1</b>
<b>SO</b>	<b>8</b>
<b>LOB</b>	<b>11</b>





Batter	1	2	3	4	5	6	7	8	9	AB R H RBI BB SO LOB	TOP	
<b>Richie Ashburn, L</b> OBP: 0.439, SLG: 0.381 (1, 8) X	0-0 1-3 FC1-2-5 2B		0-0 F7		0-0 6-3			0-3 K		4 0 1 0 0 1 0		
<b>Earl Torgeson, L</b> OBP: 0.375, SLG: 0.373 (1, 3) X	0-0 1-3 2-3		0-0 G6-3 1B			0-0 4-3		0-0 F8		4 0 1 0 0 0 1		
<b>Smoky Burgess, L</b> OBP: 0.443, SLG: 0.540 (1, 2) X	0-0 FC1-2-5 3-H		0-0 G6-3 1-2f			0-0 1B 2B		0-0 1B		4 1 2 0 0 0 2		
<b>Granny Hamner, R</b> OBP: 0.371, SLG: 0.500 (1, 4) X	0-0 F8			0-0 E7 4-3 1B		0-0 1B 2-H		0-0 1-3		4 0 2 1 0 0 2		
<b>Del Ennis, R</b> OBP: 0.317, SLG: 0.454 (1, 9) X		0-0 1B 1B		0-0 4-3 2-3		0-0 F8		0-0 F4		4 0 1 0 0 0 2		
<b>Danny Schell, R</b> OBP: 0.323, SLG: 0.442 (1, 7) X		0-0 F8		0-0 F8		0-0 F3		0-0 5-3		4 0 0 0 0 0 3		
<b>Bobby Morgan, R</b> OBP: 0.375, SLG: 0.465 (1, 6) X		0-0 F8		0-0 4-3			0-3 K		0-0 HR	4 1 1 1 0 1 2	<b>AB 36</b>	
<b>Willie Jones, R</b> OBP: 0.328, SLG: 0.399 (1, 5) X		0-0 1-3 1B			0-0 F4		0-0 5-3		0-0 1B	4 0 2 0 0 0 0	<b>R 2</b>	
<b>Herm Wehmeier, R</b> OBP: 0.054, SLG: 0.083 (1, 1) X		0-0 F8			0-3 K		0-0 F8		0-0 F8	2 0 0 0 0 1 2	<b>H 10</b>	
<b>Ron Mrozinski, R</b> (5, 1) X										1 0 0 0 0 0 0	<b>RBI 2</b>	
<b>Johnny Wyrostek, L</b> OBP: 0.293, SLG: 0.349 (9, PH) X										1 0 0 0 0 0 1	<b>BB 0</b>	
<b>Inning Stats</b>	R: 0 H: 1 E: 0 LOB: 1 K: 0 BB: 0 S: 4 P: 4	R: 0 H: 2 E: 0 LOB: 2 K: 0 BB: 0 S: 5 P: 5	R: 0 H: 1 E: 0 LOB: 0 K: 0 BB: 0 S: 3 P: 3	R: 0 H: 1 E: 1 LOB: 1 K: 0 BB: 0 S: 4 P: 4	R: 0 H: 0 E: 0 LOB: 0 K: 1 BB: 0 S: 5 P: 5	R: 1 H: 2 E: 0 LOB: 1 K: 0 BB: 0 S: 5 P: 5	R: 0 H: 0 E: 0 LOB: 0 K: 1 BB: 0 S: 5 P: 5	R: 0 H: 1 E: 0 LOB: 1 K: 1 BB: 0 S: 6 P: 6	R: 1 H: 2 E: 0 LOB: 1 K: 0 BB: 0 S: 5 P: 5	1B: 7 SF: 0 2B: 2 SAC: 0 3B: 0 DP: 1 HR: 1 HBP: 0	WP: 0 PA: 36 PB: 0 SB: 0 CS: 0	
<b>PITCHER</b> <b>Sal Maglie, R</b> ERA: 3.36 (1, 1)	IP WLS BF H R ER SO BB IBB HBP BLK WP HR S P ERA WHIP											<b>PITCHER</b> IP WLS BF H R ER SO BB IBB HBP BLK WP HR S P ERA WHIP
	9.0 W 36 10 2 2 3 0 0 0 0 0 0 1 42 42 2.00 1.111											

Philadelphia Phillies @ New York Giants  
Polo Grounds, New York, NY  
Wed Aug 18 1954, 3:33 AM EDT  
Att. 9,992 - Unknown

livebaseballscorecards.com







Batter	1	2	3	4	5	6	7	8	9	AB R H RBI BB SO LOB	TOP
<b>Richie Ashburn, L</b> (1, 8) OBP: 0.441, SLG: 0.385	0-0 2B 1B		0-0 1B		0-0 6-3 1B		0-0 4-3 1-2			4 0 3 0 0 0 1	
<b>Earl Torgeson, L</b> (1, 3) OBP: 0.374, SLG: 0.375	0-0 1-2 2B		0-0 F9		0-0 F3		0-0 1-3			4 0 1 0 0 0 2	
<b>Smoky Burgess, L</b> (1, 2) OBP: 0.441, SLG: 0.535	0-0 F8		0-0 1B		0-0 6-3 1-2			0-3 K		4 0 1 0 0 1 2	
<b>Granny Hamner, R</b> (1, 4) OBP: 0.368, SLG: 0.495	0-0 5-3		0-0 4-3		0-0 F7			0-0 F8		4 0 0 0 0 0 3	
<b>Del Ennis, R</b> (1, 9) OBP: 0.316, SLG: 0.451		0-0 1-3		0-0 5-3		0-0 5-3		4-0 BB		3 0 0 0 1 0 0	
<b>Danny Schell, R</b> (1, 7) OBP: 0.318, SLG: 0.435		0-0 5-3		0-0 F8		0-0 F9		0-0 F6		4 0 0 0 0 0 1	
<b>Bobby Morgan, R</b> (1, 6) OBP: 0.376, SLG: 0.467		0-0 2B		4-0 FC5 E BB		0-0 F2			0-0 6-3	3 0 1 0 1 0 0	<b>AB 33</b>
<b>Willie Jones, R</b> (1, 5) OBP: 0.330, SLG: 0.398		4-0 FC6-4 BB		0-0 E6 1-2		0-0 4-3 1B			0-0 F7	3 0 1 0 1 0 1	<b>R 0</b>
<b>Murry Dickson, R</b> (1, 1) OBP: 0.197, SLG: 0.217		0-0 FC6-4		0-0 FC5		0-0 F9			0-0 4-3	2 0 0 0 0 0 4	<b>H 7</b>
<b>Johnny Wrostock, L</b> (7, PH) OBP: 0.292, SLG: 0.347		1-2		2-3f						1 0 0 0 0 0 1	<b>RBI 0</b>
<b>Bob Miller, R</b> (7, 1) OBP: 0.213, SLG: 0.250										0 0 0 0 0 0 0	<b>BB 3</b>
<b>Floyd Baker, L</b> (9, PH) OBP: 0.219, SLG: 0.258										1 0 0 0 0 0 0	<b>SO 1</b>
<b>Inning Stats</b>	R: 0 E: 0 K: 0 S: 4 H: 2 LOB: 1 BB: 0 P: 4	R: 0 E: 0 K: 0 S: 4 H: 1 LOB: 2 BB: 1 P: 8	R: 0 E: 0 K: 0 S: 4 H: 2 LOB: 1 BB: 0 P: 4	R: 0 E: 1 K: 0 S: 4 H: 0 LOB: 2 BB: 1 P: 8	R: 0 E: 0 K: 0 S: 4 H: 1 LOB: 1 BB: 0 P: 4	R: 0 E: 0 K: 0 S: 3 H: 0 LOB: 0 BB: 0 P: 3	R: 0 E: 0 K: 0 S: 4 H: 1 LOB: 1 BB: 0 P: 4	R: 0 E: 0 K: 1 S: 5 H: 0 LOB: 1 BB: 1 P: 9	R: 0 E: 0 K: 0 S: 3 H: 0 LOB: 0 BB: 0 P: 3	1B: 5 2B: 2 3B: 0 HR: 0 SF: 0 SAC: 0 DP: 0 HBP: 0	WP: 0 PB: 0 SB: 0 CS: 0 PA: 36
<b>PITCHER</b> <b>Ruben Gomez, R</b> (1, 1) ERA: 3.03	IP: 9.0 WLS: W BF: 36 H: 7 R: 0 ER: 0 SO: 1 BB: 3 IBB: 0 HBP: 0 BLK: 0 WP: 0 HR: 0 S: 35 P: 47 ERA: 0.00 WHIP: 1.111										

Philadelphia Phillies @ New York Giants  
Polo Grounds, New York, NY  
Thu Aug 19 1954, 3:33 AM EDT  
Att. 6,530 - Unknown

livebaseballscorecards.com







Batter	1	2	3	4	5	6	7	8	9
<b>Davey Williams, R</b> OBP: 0.286, SLG: 0.328 (1, 4) X	0-0 F4		0-0 F6		0-3 K		0-3 K		
<b>Don Mueller, L</b> OBP: 0.351, SLG: 0.436 (1, 9) X	0-0 4-3		0-0 F6		0-0 HR		0-0 FC3-6		
<b>Alvin Dark, R</b> OBP: 0.330, SLG: 0.458 (1, 6) X	0-0 F4			0-3 K	0-0 1B		0-0 CS	0-0 F4	
<b>Willie Mays, R</b> OBP: 0.400, SLG: 0.676 (1, 8)		0-0 5-3		0-0 2B	0-0 F9			0-0 1B	
<b>Bobby Hofman, R</b> OBP: 0.298, SLG: 0.507 (1, 3)		0-3 K		0-0 FC6-5-4-3-5		0-0 F8		0-0 F7	
<b>Monte Irvin, R</b> OBP: 0.375, SLG: 0.447 (1, 7)		0-0 6-3			4-0 1B HR BB	4-0 FC6-4 BB		0-0 F6	
<b>Ray Katt, R</b> OBP: 0.322, SLG: 0.480 (1, 2)			0-3 K		0-0 F8	0-0 F3			
<b>Billy Gardner, R</b> OBP: 0.268, SLG: 0.312 (1, 5)			0-0 BB 1B		0-0 BB 1B	0-0 FC6-4			
<b>Don Liddle, L</b> OBP: 0.367, SLG: 0.208 (1, 1)			4-0 BB		4-0 HR BB		0-0 FC3-6 1B		

Inning Stats	R: 0	H: 0	E: 0	K: 0	S: 3	R: 0	H: 0	E: 0	K: 1	S: 5	R: 0	H: 1	E: 0	K: 1	S: 6	R: 0	H: 1	E: 0	K: 1	S: 5	R: 4	H: 3	E: 0	K: 1	S: 8	R: 0	H: 0	E: 0	K: 0	S: 3	R: 0	H: 1	E: 0	K: 1	S: 5	R: 0	H: 1	E: 0	K: 0	S: 4
	LOB: 0	BB: 0	LOB: 0	BB: 0	P: 3	LOB: 0	BB: 0	LOB: 0	BB: 0	P: 5	LOB: 2	BB: 1	LOB: 0	BB: 0	P: 10	LOB: 1	BB: 2	LOB: 1	BB: 2	P: 16	LOB: 1	BB: 1	LOB: 0	BB: 0	P: 7	LOB: 1	BB: 0	LOB: 1	BB: 0	P: 4	LOB: 1	BB: 0	LOB: 1	BB: 0	P: 4	LOB: 1	BB: 0	LOB: 1	BB: 0	P: 4

PITCHER	IP	WLS	BF	H	R	ER	SO	BB	IBB	HBP	BLK	WP	HR	S	P	ERA	WHIP
<b>Dick Littlefield, L</b> ERA: 3.13 (1, 1)	5.0	L	22	5	4	4	4	3	0	0	0	0	1	27	39	7.20	1.600
<b>Bob Purkey, R</b> ERA: 4.95 (6, 1)	2.0		7	1	0	0	1	1	0	0	0	0	0	8	12	0.00	1.000
<b>Johnny Hetki, R</b> ERA: 5.4 (8, 1)	1.0		4	1	0	0	0	0	0	0	0	0	0	4	4	0.00	1.000

**BOTTOM**

**Pittsburgh Pirates @ New York Giants**  
Polo Grounds, New York, NY

Fri Aug 20 1954, 3:33 AM EDT  
Att. 8,985 - Unknown

AB	29
R	4
H	7
RBI	4
BB	4
SO	5
LOB	16



1B: 5	SF: 0	WP: 0	PA: 34
2B: 2	SAC: 0	PB: 0	
3B: 0	DP: 1	SB: 0	
HR: 1	HBP: 0	CS: 1	

1B: 5	SF: 0	WP: 0	PA: 34
2B: 2	SAC: 0	PB: 0	
3B: 0	DP: 1	SB: 0	
HR: 1	HBP: 0	CS: 1	

Batter	1	2	3	4	5	6	7	8	9	AB R H RBI BB SO LOB	TOP																
<b>Curt Roberts, R</b> OBP: 0.303, SLG: 0.307 (1, 4) X	0-0 E6 1B HR	0-0 1B		0-0 PB 2B		0-0 5-3		4-0 BB BB		4 1 2 1 1 0 0																	
<b>Eddie Pellagrini, R</b> OBP: 0.298, SLG: 0.279 (1, 5) X	0-0 1-3 HR 1B	0-0 1-3 1B		4-0 PB BB		0-0 6-3		0-3 K		4 1 2 0 1 1 2																	
<b>Bob Skinner, L</b> OBP: 0.330, SLG: 0.392 (1, 3) S S S	0-3 K	0-0 F7		4-0 1-2 2-3 BB			0-0 SH5-3 1B	4-0 1-2 2-3 BB		3 0 1 0 2 1 4																	
<b>Frank Thomas, R</b> OBP: 0.380, SLG: 0.531 (1, 8) X	0-0 1-H 3-H HR			4-0 G6-4-3 BB		0-0 5-3		0-0 SH5-3 1B	0-0 F5	3 1 1 3 1 0 6																	
<b>Sid Gordon, R</b> OBP: 0.398, SLG: 0.395 (1, 9) X	0-0 2B			0-0 G6-4-3		0-0 SH3-4 1B		4-0 SH5-4 BB	0-0 E4 SH5-4 1B	4 0 3 0 1 0 1 0 0 0 0 0 0 0 0 0 0 0 0 0 0																	
<b>Vic Janowicz, R</b> OBP: 0.238, SLG: 0.194 (9, PR)				1-2																							
<b>Jerry Lynch, L</b> OBP: 0.302, SLG: 0.420 (9, 9)																											
<b>Jack Shepard, R</b> OBP: 0.348, SLG: 0.344 (1, 2) X	0-0 F8			0-3 K		0-0 SH3-4		0-0 F8	0-0 SH5-4	3 0 0 0 0 1 3																	
<b>Dick Cole, R</b> OBP: 0.329, SLG: 0.350 (1, 6) X	0-0 F8			0-0 2B 2B		0-0 5-3		0-0 F6	0-0 F6	5 1 1 0 0 0 6																	
<b>Dick Hall, R</b> OBP: 0.333, SLG: 0.352 (1, 7) X		0-0 F7		0-3 K		0-0 F3		0-0 F9	4-0 IBB	4 0 0 0 1 1 2																	
<b>Paul LaPalme, L</b> OBP: 0.167, SLG: 0.207 (1, 1)		0-0 4-3		0-0 F7		0-0 G3		0-0 BB BB 1B	0-0 1-3	5 0 1 0 0 0 4 0 0 0 0 0 0 0 0 0 0 0 0 0 0																	
<b>Johnny Hetki, R</b> OBP: 0.200, SLG: 0.200 (9, 1)																											
<b>Jake Thies, R</b> OBP: 0.207, SLG: 0.042 (9, 1)																											
<b>Inning Stats</b>	R: 3 E: 1 K: 1 S: 9	H: 3 LOB: 1 BB: 0 P: 9	R: 0 E: 0 K: 0 S: 5	H: 2 LOB: 2 BB: 0 P: 5	R: 0 E: 0 K: 1 S: 4	H: 0 LOB: 0 BB: 1 P: 8	R: 1 E: 0 K: 1 S: 7	H: 2 LOB: 3 BB: 2 P: 15	R: 0 E: 0 K: 0 S: 4	H: 1 LOB: 1 BB: 0 P: 4	R: 0 E: 0 K: 0 S: 3	H: 0 LOB: 0 BB: 0 P: 3	R: 0 E: 0 K: 0 S: 4	H: 1 LOB: 2 BB: 1 P: 8	R: 0 E: 0 K: 1 S: 6	H: 1 LOB: 3 BB: 2 P: 14	R: 0 E: 1 K: 0 S: 4	H: 1 LOB: 3 BB: 1 P: 8	1B: 7 2B: 3 3B: 0 HR: 1	SF: 0 SAC: 3 DP: 1 HBP: 0	WP: 0 PB: 1 SB: 0 CS: 0	PA: 45					
<b>PITCHER</b>	IP	WLS	BF	H	R	ER	SO	BB	IBB	HBP	BLK	WP	HR	S	P	ERA	WHIP										
<b>Johnny Antonelli, L</b> ERA: 2.4 (1, 1)	0.1		5	3	3	2	1	0	0	0	0	0	1	7	7	54.00	9.000										
<b>Al Corwin, R</b> ERA: 4.44 (1, 1)	3.1		14	4	1	1	2	1	0	0	0	0	0	17	21	2.70	1.500										
<b>Hoyt Wilhelm, R</b> ERA: 2.99 (4, 1)	2.1		10	1	0	0	0	2	0	0	0	0	0	8	16	0.00	1.286										
<b>Mary Grissom, R</b> ERA: 2.47 (7, 1)	1.0		5	1	0	0	0	1	0	0	0	0	0	4	8	0.00	2.000										
<b>Windy McCall, L</b> ERA: 2.82 (8, 1)	2.0	W	11	2	0	0	1	2	1	0	0	0	0	10	22	0.00	2.000										

Pittsburgh Pirates @ New York Giants  
Polo Grounds, New York, NY  
Sun Aug 22 1954, 3:33 AM EDT  
Unknown

livebaseballscorecards.com

AB	35
R	4
H	11
RBI	4
BB	7
SO	4
LOB	28



Batter	1	2	3	4	5	6	7	8	9	AB	R	H	RBI	BB	SO	LOB
<b>Davey Williams, R</b> (1, 4) OBP: 0.286, SLG: 0.325	0-0 F2			0-0 F2		4-0 1B BB		0-3 K		3	0	0	0	1	1	0
<b>Don Mueller, L</b> (1, 9) OBP: 0.349, SLG: 0.432	0-0 F8			0-0 F9		0-0 F3		0-0 6-3		4	0	0	0	0	0	3
<b>Alvin Dark, R</b> (1, 6) OBP: 0.329, SLG: 0.456	0-0 4-3			0-0 F7		0-0 1B		0-3 K		4	0	1	2	0	1	0
<b>Willie Mays, R</b> (1, 8) OBP: 0.397, SLG: 0.670		0-0 1-3			0-3 K	0-0 F6			0-0 F4	4	0	0	0	0	1	2
<b>Bobby Hofman, R</b> (1, 3) OBP: 0.299, SLG: 0.494		0-3 K			0-0 F2		4-0 WP 1B BB		0-0 E9 BB BB	2	0	0	0	1	1	0
<b>Whitey Lockman, L</b> (7, PR) OBP: 0.319, SLG: 0.386										1	2	0	0	0	0	0
<b>Monte Irvin, R</b> (1, 7) OBP: 0.374, SLG: 0.444		0-0 F3			0-0 6-3		0-0 F8		4-0 BB BB 1B BB	3	1	0	0	1	0	1
<b>Ray Katt, R</b> (1, 2) OBP: 0.322, SLG: 0.477			0-0 6-3			0-3 K	0-0 1B 1B		4-0 1B BB	3	0	1	1	0	1	0
<b>Don Liddle, L</b> (7, PR) OBP: 0.367, SLG: 0.208							2-H 1B		1-2 2-3 BB	0	0	0	0	0	0	0
<b>Wes Westrum, R</b> (8, 2) OBP: 0.321, SLG: 0.335									1-2 2-3 BB	0	0	0	0	1	0	0
<b>Billy Gardner, R</b> (1, 5) OBP: 0.282, SLG: 0.325			0-0 F2			BB 1B 1B	0-0 G4-6-3 1B		4-0 1B	3	1	2	0	0	0	0
<b>Hank Thompson, L</b> (9, PH) OBP: 0.375, SLG: 0.461							1-2 1B		1-2 2-3 BB	0	0	0	1	1	0	0
<b>Johnny Antonelli, L</b> Al Corwin, R Hoyt Wilhelm, R Foster Clendenen, R Ruben Gomez, R Mary Grimes, R Dusty Rhodes, L Windy McCall, L Bill Taylor, L			0-0 F6			0-0 1B BB	0-0 G4-6-3 1B		0-0 1B	0	0	0	0	0	0	0
							1-2 1B		1-2 2-3 3-H	0	0	0	0	0	0	0

**BOTTOM**

**Pittsburgh Pirates @ New York Giants**  
Polo Grounds, New York, NY  
Sun Aug 22 1954, 3:33 AM EDT  
Unknown

AB	31
R	5
H	6
RBI	5
BB	5
SO	5
LOB	8



Inning Stats	R: 0	H: 0	E: 0	LOB: 0	K: 0	BB: 0	S: 3	P: 3	R: 0	H: 0	E: 0	LOB: 0	K: 0	BB: 0	S: 3	P: 3	R: 0	H: 0	E: 0	LOB: 0	K: 0	BB: 0	S: 3	P: 3	R: 0	H: 3	E: 0	LOB: 2	K: 1	BB: 1	S: 8	P: 12	R: 1	H: 2	E: 0	LOB: 2	K: 0	BB: 1	S: 4	P: 8	R: 0	H: 0	E: 0	LOB: 0	K: 2	BB: 0	S: 7	P: 7	R: 2	H: 1	E: 1	LOB: 3	K: 0	BB: 3	S: 3	P: 15	1B: 6	2B: 0	3B: 0	HR: 0	SF: 0	SAC: 0	DP: 1	HBP: 0	WP: 1	PA: 36
<b>Paul LaPalme, L</b> (1, 1) ERA: 5.27	8.1	WLS L	BF 33	H 5	R 5	ER 4	SO 5	BB 3	IBB 0	HBP 0	BLK 0	WP 1	HR 0	S 40	P 52	ERA 4.32	WHIP 0.960																																																	
<b>Johnny Hetki, R</b> (9, 1) ERA: 5.4	0.0		2	0	0	0	0	2	0	0	0	0	0	0	8	∞	∞																																																	
<b>Jake Thies, R</b> (9, 1) ERA: 2.95	0.0		1	1	0	0	0	0	0	0	0	0	0	1	1	∞	∞																																																	

PITCHER	IP	WLS	BF	H	R	ER	SO	BB	IBB	HBP	BLK	WP	HR	S	P	ERA	WHIP
<b>Paul LaPalme, L</b>	8.1	L	33	5	5	4	5	3	0	0	0	1	0	40	52	4.32	0.960
<b>Johnny Hetki, R</b>	0.0		2	0	0	0	0	2	0	0	0	0	0	8	8	∞	∞
<b>Jake Thies, R</b>	0.0		1	1	0	0	0	0	0	0	0	0	0	1	1	∞	∞

Batter	1	2	3	4	5	6	7	8	9	AB R H RBI BB SO LOB	TOP																
<b>Curt Roberts, R</b> (1, 4) OBP: 0.299, SLG: 0.303	0-3 K		0-0 E6 FC3-2 BB 1-2	0-0 F8		0-0 F3		0-0 F6		5 0 0 0 0 1 5																	
<b>Bob Skinner, L</b> (1, 3) OBP: 0.331, SLG: 0.390	0-3 K		4-0 FC3-2 BB 1-2 2-3		0-0 1B 1B	0-0 F7		0-0 4-3		4 1 1 0 1 1 1																	
<b>Preston Ward, L</b> (1, 9) OBP: 0.349, SLG: 0.420	0-0 F5		0-0 FC3-2 BB 1-2 2-3 3-Hf		0-0 1B 1B 1B	0-3 K			0-0 1-3	5 1 1 0 0 1 3																	
<b>Frank Thomas, R</b> (1, 8) OBP: 0.378, SLG: 0.527		0-0 1B 1B	0-3 K		0-0 F6		0-0 E5 SH3-4		0-3 K	5 0 1 0 0 2 5																	
<b>Toby Atwell, L</b> (1, 2) OBP: 0.390, SLG: 0.381		0-0 G4-3 1B		0-0 F8	0-0 1B 1B		0-0 SH3-4		0-3 K	1 0 1 0 0 0 0																	
<b>Jack Shepard, R</b> (2, 2) OBP: 0.348, SLG: 0.344		1-3 1B		0-0 F9	1-2 3-H 1B 1B		1-2 SH3-4		0-3 K	3 1 1 1 0 1 1																	
<b>Jerry Lynch, L</b> (1, 7) OBP: 0.300, SLG: 0.415	0-3 K		0-0 F9		0-0 5-3 1B 1B		0-0 6-3		0-3 K	5 0 1 0 0 2 4																	
<b>Dick Cole, R</b> (1, 6) OBP: 0.330, SLG: 0.352	0-0 G4-3		0-0 1B 1B 1B		1-2 2-3 1B		0-0 F6			4 0 2 2 0 0 3																	
<b>Gair Allie, R</b> (1, 5) OBP: 0.312, SLG: 0.290			0-0 BB E FC3-2 1B	0-0 1B 1B	0-0 5-3			4-0 BB		3 0 2 0 1 0 2																	
<b>Max Surkont, R</b> (1, 1) OBP: 0.255, SLG: 0.204			0-3 K	0-0 1B	0-0 F6			0-3 K		3 0 1 0 0 1 3																	
<b>Eddie Pellagrini, R</b> (8, PH) OBP: 0.296, SLG: 0.277				1-2 2-3 1B						1 0 0 0 0 1 1																	
<b>Vern Law, R</b> (8, 1) OBP: 0.341, SLG: 0.450										0 0 0 0 0 0 0																	
<b>Inning Stats</b>	R: 0 E: 0 K: 2 S: 7	H: 0 LOB: 0 BB: 0 P: 7	R: 0 E: 0 K: 1 S: 6	H: 2 LOB: 1 BB: 0 P: 6	R: 0 E: 1 K: 2 S: 9	H: 1 LOB: 3 BB: 1 P: 13	R: 0 E: 0 K: 0 S: 6	H: 3 LOB: 3 BB: 0 P: 6	R: 3 E: 0 K: 0 S: 8	H: 5 LOB: 2 BB: 0 P: 8	R: 0 E: 0 K: 1 S: 5	H: 0 LOB: 0 BB: 0 P: 5	R: 0 E: 1 K: 0 S: 4	H: 0 LOB: 1 BB: 0 P: 4	R: 0 E: 0 K: 1 S: 5	H: 0 LOB: 1 BB: 1 P: 9	R: 0 E: 1 K: 3 S: 10	H: 0 LOB: 1 BB: 0 P: 10	1B: 11 2B: 0 3B: 0 HR: 0	SF: 0 SAC: 1 DP: 1 HBP: 0	WP: 0 PB: 0 SB: 0 CS: 0	PA: 42					
<b>PITCHER</b>	IP WLS BF H R ER SO BB IBB HBP BLK WP HR S P ERA WHIP																										
<b>Sal Maglie, R</b> (1, 1) ERA: 3.42	4.1		25	11	3	3	5	1	0	0	0	0	0	34	38	6.23	2.769										
<b>Hoyt Wilhelm, R</b> (5, 1) ERA: 2.81	4.2	W	17	0	0	0	5	1	0	0	0	0	0	26	30	0.00	0.214										

**Pittsburgh Pirates @ New York Giants**  
Polo Grounds, New York, NY  
Sun Aug 22 1954, 3:38 AM EDT  
Att: 22,702 - Unknown

livebaseballscorecards.com

AB	39
R	3
H	11
RBI	3
BB	2
SO	10
LOB	28





Batter	1	2	3	4	5	6	7	8	9	AB	R	H	RBI	BB	SO	LOB
Whitey Lockman, L (1, 3) OBP: 0.320, SLG: 0.387	4-0 FC4-6 BB	0-0 F6	0-0 F2			0-0 4-3		0-0 1B 2B		4	1	1	0	1	0	4
Don Mueller, L (1, 9) OBP: 0.353, SLG: 0.438	0-0 FC4-6 2B 1-2f	0-0 E9 1B 1-3 2-H 3-H		0-0 SH1-3 2B		0-0 1B		0-0 1B 2-H		5	0	4	3	0	0	1
Alvin Dark, R (1, 6) OBP: 0.328, SLG: 0.457	0-0 1-3 2B	0-0 4-3		0-0 SH1-3 2-3		0-0 F6		0-0 5-3		4	0	1	0	0	0	4
Dusty Rhodes, L (1, 7) OBP: 0.425, SLG: 0.787	4-0 IBB	0-0 F3		0-0 G3			0-3 K			3	0	0	0	1	1	3
Monte Irvin, R (8, 7) OBP: 0.374, SLG: 0.444										0	0	0	0	0	0	0
Willie Mays, R (1, 8) OBP: 0.394, SLG: 0.664	0-3 K		0-0 E6 E	0-0 4-3			0-0 6-3			4	1	0	0	0	1	4
Hank Thompson, L (1, 5) OBP: 0.376, SLG: 0.462	0-0 F4		0-0 E2 1B 1-H		0-0 G3		0-0 1B			4	1	2	0	0	0	3
Ray Katt, R (1, 2) OBP: 0.320, SLG: 0.470		0-0 BB E 1B 1B	0-0 F7		0-0 F7		0-0 F7			4	1	1	0	0	0	1
Davey Williams, R (1, 4) OBP: 0.285, SLG: 0.325		0-0 BB E 1B 1-2	0-0 F9		0-0 4-3			0-0 F9		4	1	1	0	0	0	0
Sal Maglie, R (1, 1) OBP: 0.186, SLG: 0.127		4-0 E BB 1-2 2-3	0-0					0-0 G3		1	0	1	0	1	0	0
Hoyt Wilhelm, R (5, 1) OBP: 0.186, SLG: 0.127						0-0 5-3				2	0	0	0	0	0	0

Inning Stats	R: 0	H: 1	E: 0	K: 1	S: 6	LOB: 3	BB: 2	P: 14
	R: 2	H: 3	E: 1	K: 0	S: 6	LOB: 2	BB: 1	P: 10
	R: 2	H: 2	E: 2	K: 0	S: 6	LOB: 1	BB: 0	P: 6
	R: 0	H: 1	E: 0	K: 0	S: 4	LOB: 1	BB: 0	P: 4
	R: 0	H: 0	E: 0	K: 0	S: 3	LOB: 0	BB: 0	P: 3
	R: 0	H: 1	E: 0	K: 0	S: 4	LOB: 1	BB: 0	P: 4
	R: 0	H: 1	E: 0	K: 1	S: 6	LOB: 1	BB: 0	P: 6
	R: 1	H: 2	E: 0	K: 0	S: 5	LOB: 1	BB: 0	P: 5

PITCHER	IP	WLS	BF	H	R	ER	SO	BB	IBB	HBP	BLK	WP	HR	S	P	ERA	WHIP
Max Surkont, R (1, 1) ERA: 4.45	7.0	L	34	9	4	2	2	2	2	1	0	0	0	35	47	2.57	1.571
Vern Law, R (8, 1) ERA: 5.67	1.0		5	2	1	1	0	0	0	0	0	0	0	5	5	9.00	2.000

**BOTTOM**

**Pittsburgh Pirates @ New York Giants**  
Polo Grounds, New York, NY  
Sun Aug 22 1954, 3:38 AM EDT  
Att. 22,702 - Unknown

AB	35
R	5
H	11
RBI	3
BB	3
SO	2
LOB	20



1B	8	SF	0	WP	0	PA	39
2B	3	SAC	1	PB	0		
3B	0	DP	0	SB	0		
HR	0	HBP	0	CS	0		

Batter	1	2	3	4	5	6	7	8	9	AB R H RBI BB SO LOB	TOP	
Davey Williams, R OBP: 0.287, SLG: 0.325 (1, 4) X	0-0 F9		0-0 6-3		0-0 F3		0-0		0-0 FC6-4	5 0 2 1 0 0 0		
Don Mueller, L OBP: 0.353, SLG: 0.442 (1, 9) X	0-0 2B 1B		0-0 1-3		0-0 4-3 3B		0-0 F8		0-0 FC6-4	5 2 2 0 0 0 1		
Alvin Dark, R OBP: 0.328, SLG: 0.455 (1, 6) X	0-0 F7		0-0 3B 1B		0-0 4-3		0-0 5-3			4 1 1 1 0 0 1		
Willie Mays, R OBP: 0.397, SLG: 0.676 (1, 8) X	0-0 1-H 2B		0-0 1-H 3B		0-0 3-H 2B 3B		0-0 F9			4 1 3 2 0 0 0		
Bobby Hofman, R OBP: 0.297, SLG: 0.494 (1, 3) X	0-0 5-3		0-0 F5		0-0 3-H 2B		0-0 F7			4 0 1 1 0 0 2		
Monte Irvin, R OBP: 0.372, SLG: 0.444 (1, 7) X		0-0 2B		0-0 5-3	0-0 5-3		0-0 F3			4 0 1 0 0 0 1		
Ray Katt, R OBP: 0.318, SLG: 0.463 (1, 2) X		0-3 K		0-0 5-3		0-0 3-1		0-0 SH1-4 1B 1B		4 1 1 0 0 1 1	AB 37 R 5 H 11 RBI 5 BB 0 SO 2 LOB 10	
Billy Gardner, R OBP: 0.270, SLG: 0.310 (1, 5) X		0-3 K		0-0 E6		0-0 F2		0-0 F1		4 0 0 0 0 1 2		
Ruben Gomez, R OBP: 0.203, SLG: 0.254 (1, 1) X		0-0 6-3		0-0 F7		0-0 F9		0-0 SH1-4		3 0 0 0 0 0 2		
Inning Stats	R: 1 H: 2 E: 0 LOB: 1 K: 0 BB: 0 S: 5 P: 5	R: 0 H: 1 E: 0 LOB: 1 K: 2 BB: 0 S: 8 P: 8	R: 1 H: 2 E: 0 LOB: 1 K: 0 BB: 0 S: 5 P: 5	R: 0 H: 0 E: 1 LOB: 1 K: 0 BB: 0 S: 4 P: 4	R: 2 H: 3 E: 0 LOB: 1 K: 0 BB: 0 S: 6 P: 6	R: 0 H: 0 E: 0 LOB: 0 K: 0 BB: 0 S: 3 P: 3	R: 0 H: 1 E: 0 LOB: 0 K: 0 BB: 0 S: 3 P: 3	R: 0 H: 0 E: 0 LOB: 0 K: 0 BB: 0 S: 3 P: 3	R: 1 H: 2 E: 0 LOB: 1 K: 0 BB: 0 S: 5 P: 5	1B: 5 SF: 0 2B: 3 SAC: 1 3B: 3 DP: 0 HR: 0 HBP: 0	WP: 0 PA: 38 PB: 0 SB: 0 CS: 0	
PITCHER Paul Minner, L (1, 1) ERA: 3.77	IP WLS BF H R ER SO BB IBB HBP BLK WP HR S P ERA WHIP	9.0 L 38 11 5 5 2 0 0 0 0 0 0 0 42 42 5.00 1.222										

New York Giants @ Chicago Cubs  
 Wrigley Field, Chicago, IL  
 Tue Aug 24 1954, 3:33 AM CDT  
 Att. 8,725 - Unknown

livebaseballscorecards.com



Batter	1	2	3	4	5	6	7	8	9	AB R H RBI BB SO LOB	TOP												
Davey Williams, R (1, 4) OBP: 0.286, SLG: 0.325	0-0 F8		0-0 1-3 1B		0-0 F9			0-0 F4		4 0 1 0 0 0 0	<b>New York Giants @ Chicago Cubs</b> Wrigley Field, Chicago, IL Thu Aug 26 1954, 3:33 AM CDT Unknown												
Don Mueller, L (1, 9) OBP: 0.355, SLG: 0.443	0-0 CS 2B		0-0 F4		0-0 F8			4-0 HR BB	3 1 1 0 1 0 1														
Alvin Dark, R (1, 6) OBP: 0.325, SLG: 0.452	0-0 2-3			0-0 1-4-3		0-0 4-3		0-0 F7	4 0 0 0 0 0 2														
Willie Mays, R (1, 8) OBP: 0.402, SLG: 0.688		0-0 1B 1B		0-0 FC5-4 2B		0-0 1B		0-0 1-H HR	4 1 4 2 0 0 0														
Bobby Hofman, R (1, 3) OBP: 0.305, SLG: 0.488		0-0 G1-4-3 1B		0-0 FC5-4 1B E		0-3 K		4-0 BB	3 1 1 0 1 1 2														
Whitey Lockman, L (8, 3) OBP: 0.320, SLG: 0.387		1-3		2-3					0 0 0 0 0 0 0														
Monte Irvin, R (1, 7) OBP: 0.371, SLG: 0.442		0-0 F9		0-0 E7 1B		0-0 F5		0-0 F4	4 0 1 0 0 0 4														
Ray Katt, R (1, 2) OBP: 0.312, SLG: 0.453		0-0 G1-4-3		0-0 E5		0-3 K			3 0 0 0 0 1 3														
Hank Thompson, L (9, PH) OBP: 0.375, SLG: 0.460		1-2f		1-2				0-0 1-3	1 0 0 0 0 0 0														
Billy Gardner, R (1, 5) OBP: 0.272, SLG: 0.302			4-0 FC1-6 BB		0-0 4-3		0-0 F8		0-3 K	2 0 0 0 1 0 2													
Dusty Rhodes, L (9, PH) OBP: 0.421, SLG: 0.779								0-0 K	1 0 0 0 0 1 0														
Don Liddle, L (1, 1) OBP: 0.355, SLG: 0.200			0-0 FC1-6		0-0 F8		0-0 6-3		0-0 G3	1 0 0 0 0 0 1													
Hoyt Wilhelm, R (3, 1)										1 0 0 0 0 0 0													
Foster Castleman, R (7, PH) OBP: 0.400, SLG: 0.400										1 0 0 0 0 0 0													
Mary Grissom, R (7, 1) OBP: 0.160, SLG: 0.125										0 0 0 0 0 0 0													
Bill Taylor, L (9, PH) OBP: 0.262, SLG: 0.327										1 0 0 0 0 0 0													
<b>Inning Stats</b>	R: 0 E: 0 K: 0 S: 3	H: 1 LOB: 0 BB: 0 P: 3	R: 0 E: 0 K: 0 S: 4	H: 2 LOB: 1 BB: 0 P: 4	R: 0 E: 0 K: 0 S: 3	H: 1 LOB: 1 BB: 1 P: 7	R: 1 E: 2 K: 0 S: 6	H: 2 LOB: 2 BB: 0 P: 6	R: 0 E: 0 K: 1 S: 3	H: 0 LOB: 0 BB: 0 P: 3	R: 0 E: 0 K: 1 S: 6	H: 1 LOB: 1 BB: 0 P: 6	R: 0 E: 0 K: 1 S: 5	H: 0 LOB: 0 BB: 0 P: 5	R: 2 E: 0 K: 0 S: 4	H: 1 LOB: 1 BB: 2 P: 12	R: 0 E: 0 K: 1 S: 5	H: 0 LOB: 0 BB: 0 P: 5	1B: 5 2B: 2 3B: 0 HR: 1	SF: 0 SAC: 0 DP: 1 HBP: 0	WP: 0 PB: 0 SB: 0 CS: 1	PA: 36	
<b>PITCHER</b> Howie Pollet, L (1, 1) ERA: 3.32	IP: 7.2	WLS: 32	H: 8	R: 3	ER: 2	SO: 2	BB: 3	IBB: 0	HBP: 0	BLK: 0	WP: 0	HR: 1	S: 33	P: 45	ERA: 2.35	WHIP: 1.435							
Warren Hacker, R (8, 1) ERA: 4.39	IP: 1.1	WLS: 4	H: 0	R: 0	ER: 0	SO: 1	BB: 0	IBB: 0	HBP: 0	BLK: 0	WP: 0	HR: 0	S: 6	P: 6	ERA: 0.00	WHIP: 0.000							

<b>AB</b>	33
<b>R</b>	3
<b>H</b>	8
<b>RBI</b>	2
<b>BB</b>	3
<b>SO</b>	3
<b>LOB</b>	15



Batter	1	2	3	4	5	6	7	8	9
Bob Talbot, R OBP: 0.292, SLG: 0.326 (1, 8)	0-0 G6-4-3 1B		0-0 G6-4-3 1B		0-0 2B		0-0 4-3		
Gene Baker, R OBP: 0.338, SLG: 0.451 (1, 4)	0-0 F9		4-0 G6-4-3 BB		0-0 F7			0-0 E 1B 1B	
Randy Jackson, R OBP: 0.354, SLG: 0.503 (1, 5)	0-0 G6-4-3 1-2f		0-0 G6-4-3 1-2f 2-3 3-H			0-0 1-3		0-0 E1 E 1B	
Hank Sauer, R OBP: 0.387, SLG: 0.580 (1, 9)		0-0 1-3	0-0 F4		0-0 F5		0-0 F6		
14 Ernie Banks, R OBP: 0.345, SLG: 0.457 (1, 6)		0-0 4-3 2B		0-0 F7		0-0 S 1B		0-0 F9	
Ralph Kiner, R OBP: 0.385, SLG: 0.507 (1, 7)		0-0 4-3 2-3		4-0 G5-4-3 BB		0-3 K 1-2		0-0 E4 2-H 3-H 1B	
Steve Bilko, R OBP: 0.292, SLG: 0.345 (1, 3)		0-3 K		0-0 G5-4-3 1-2f			4-0 FC1-6 BB	0-0 F9	
Dee Fondy, L OBP: 0.313, SLG: 0.390 (8, PH) (9, 3)									
Walker Cooper, R OBP: 0.384, SLG: 0.500 (1, 2)			4-0 1B BB BB		0-0 F8		0-0 FC1-6 SH1-3 1-2f		
Howie Pollet, L OBP: 0.270, SLG: 0.278 (1, 1)			0-0 BB 1B		0-0 F4		0-0 SH1-3 1-2		
Warren Hacker, R OBP: 0.235, SLG: 0.260 (8, 1)			1-2 G6-4-3 1B						

Inning Stats	R: 0 E: 0 K: 0 S: 3	H: 1 LOB: 0 BB: 0 P: 3	R: 0 E: 0 K: 1 S: 6	H: 1 LOB: 1 BB: 0 P: 6	R: 2 E: 0 K: 0 S: 4	H: 2 LOB: 1 BB: 2 P: 12	R: 0 E: 0 K: 0 S: 2	H: 0 LOB: 0 BB: 1 P: 6	R: 0 E: 0 K: 0 S: 4	H: 1 LOB: 1 BB: 0 P: 4	R: 0 E: 0 K: 1 S: 6	H: 1 LOB: 1 BB: 0 P: 6	R: 0 E: 0 K: 0 S: 3	H: 0 LOB: 1 BB: 1 P: 7	R: 2 E: 2 K: 0 S: 6	H: 3 LOB: 1 BB: 0 P: 6
1B: 7 2B: 2 3B: 0 HR: 0	SF: 0 SAC: 1 DP: 3 HBP: 0	WP: 0 PA: 34														

PITCHER	IP	WLS	BF	H	R	ER	SO	BB	IBB	HBP	BLK	WP	HR	S	P	ERA	WHIP
Don Liddle, L ERA: 2.72 (1, 1)	2.0		11	4	2	2	1	2	0	0	0	0	0	11	19	9.00	3.000
Hoyt Wilhelm, R ERA: 2.67 (3, 1)	4.0		13	2	0	0	1	1	0	0	0	0	0	14	18	0.00	0.750
Mary Grissom, R ERA: 2.52 (7, 1)	2.0	L	10	3	2	1	0	1	0	0	0	0	0	9	13	4.50	2.000

**BOTTOM**

**New York Giants @ Chicago Cubs**  
Wrigley Field, Chicago, IL  
Thu Aug 26 1954, 3:33 AM CDT  
Unknown

livebaseballscorecards.com

<b>AB</b>	<b>29</b>
<b>R</b>	<b>4</b>
<b>H</b>	<b>9</b>
<b>RBI</b>	<b>2</b>
<b>BB</b>	<b>4</b>
<b>SO</b>	<b>2</b>
<b>LOB</b>	<b>17</b>



Batter	1	2	3	4	5	6	7	8	9	AB R H RBI BB SO LOB	TOP	
Whitey Lockman, L (1, 3) OBP: 0.319, SLG: 0.386	0-0 SH3-4 WP 1B		0-0 4-3		0-3 K			0-0 4-3		4 1 1 0 0 1 2		
Alvin Dark, R (1, 6) OBP: 0.324, SLG: 0.449	0-0 SH3-4 1-3		0-0 4-3		0-0 5-3			0-0 6-3		3 0 0 0 0 0 2		
Don Mueller, L (1, 9) OBP: 0.356, SLG: 0.444	0-0 5-3			0-0 BB 1B		0-0 G3		0-0 2B 1B		4 1 2 0 0 0 1		
Dusty Rhodes, L (1, 7) OBP: 0.432, SLG: 0.786 Monte Irvin, R (8, 7) OBP: 0.371, SLG: 0.442	0-0 3-H 1B			4-0 BB F9-4-6 BB		0-0 4-3		0-0 1-H 2B		3 0 2 2 1 0 0 0 0 0 0 0 0 0		
Willie Mays, R (1, 8) OBP: 0.400, SLG: 0.684		0-0 CS 1B		0-3 K		0-0 F6		0-3 K		4 0 1 0 0 2 3		
Hank Thompson, L (1, 5) OBP: 0.372, SLG: 0.455		0-0 F8 1-2		0-0 F9-4-6 1-2		0-0 4-3		0-0 3-1		4 0 0 0 0 0 3		
Davey Williams, R (1, 4) OBP: 0.288, SLG: 0.327		4-0 BB			0-0 FC1-5 2B		0-0 6-3		0-0 6-3	3 0 1 0 1 0 0	AB 30 R 2 H 7 RBI 2 BB 3 SO 4 LOB 15	
Wes Westrum, R (1, 2) OBP: 0.324, SLG: 0.332		0-0 F7			1-0 FC1-5 HBP		4-0 BB		0-0 F6	2 0 0 0 1 0 1		
Johnny Antonelli, L (1, 1) OBP: 0.176, SLG: 0.220			0-0 G3		0-0 FC1-5 1-2 2-3f		0-3 K			3 0 0 0 0 1 3		
Inning Stats	R: 1 H: 2 E: 0 LOB: 1 K: 0 BB: 0 S: 4 P: 4	R: 0 H: 1 E: 0 LOB: 1 K: 0 BB: 1 S: 3 P: 7	R: 0 H: 0 E: 0 LOB: 0 K: 0 BB: 0 S: 3 P: 3	R: 0 H: 1 E: 0 LOB: 1 K: 1 BB: 1 S: 5 P: 9	R: 0 H: 1 E: 0 LOB: 2 K: 1 BB: 0 S: 6 P: 7	R: 0 H: 0 E: 0 LOB: 0 K: 0 BB: 0 S: 3 P: 3	R: 0 H: 0 E: 0 LOB: 1 K: 1 BB: 1 S: 5 P: 9	R: 1 H: 2 E: 0 LOB: 1 K: 1 BB: 0 S: 7 P: 7	R: 0 H: 0 E: 0 LOB: 0 K: 0 BB: 0 S: 3 P: 3	1B: 5 SF: 0 2B: 3 SAC: 1 3B: 0 DP: 1 HR: 0 HBP: 1	WP: 1 PA: 35 PB: 0 SB: 0 CS: 1	
PITCHER Bob Rush, R (1, 1) ERA: 4.12	IP WLS BF H R ER SO BB IBB HBP BLK WP HR S P ERA WHIP	9.0 L 35 7 2 2 4 3 0 1 0 1 0 39 52 2.00 1.111										

New York Giants @ Chicago Cubs  
Wrigley Field, Chicago, IL  
Thu Aug 26 1954, 3:38 AM CDT  
Att. 9,392 - Unknown

livebaseballscorecards.com



Batter	1	2	3	4	5	6	7	8	9	AB R H RBI BB SO LOB	TOP		
Whitey Lockman, L (1, 3) OBP: 0.319, SLG: 0.385	0-0 1B		0-0 SH5-4 1-2 2-3		0-0 4-3	0-0 F8			0-0 5-3	4 0 1 0 0 0 3			
Alvin Dark, R (1, 6) OBP: 0.323, SLG: 0.447	0-3 K		0-0 6-3 2-3 3-H		0-0 1-3			0-0 SH3-4 1B	0-0 F7	5 0 1 1 0 1 2			
Don Mueller, L (1, 9) OBP: 0.355, SLG: 0.444	0-0 F5		0-0 2B 3-H		0-0 6-3			0-0 SH3-4 1-2	0-0 4-3	4 0 1 1 0 0 1			
Dusty Rhodes, L (1, 7) OBP: 0.430, SLG: 0.772 Monte Irvin, R (7, PH) OBP: 0.370, SLG: 0.441 (7, 7)	0-0 4-3		0-0 6-3			0-0 WP 1B HBP 1B		0-0 F4		3 1 1 0 0 0 2 1 0 0 0 0 0 1			
Willie Mays, R (1, 8) OBP: 0.399, SLG: 0.679		0-0 5-3		0-0 F7		0-3 K		4-0 IBB		3 0 0 0 1 1 1			
Hank Thompson, L (1, 5) OBP: 0.371, SLG: 0.453		0-0 4-3		0-0 1B 1B		0-0 F8		0-0 G3		4 0 1 0 0 0 3			
Davey Williams, R (1, 4) OBP: 0.290, SLG: 0.329		0-0 F7		0-0 1-3 1B		0-0 HBP WP 1B		0-0 6-3		4 0 2 0 0 0 0			
Wes Westrum, R (1, 2) OBP: 0.327, SLG: 0.332			0-0 SH5-4 SH 6-3 1B		0-3 K	4-0 HBP IBB		0-3 K		3 1 1 0 1 2 2			
Sal Maglie, R (1, 1) OBP: 0.194, SLG: 0.123			0-0 SH 6-3 SH5-4 2B		0-0 1-3	1-0 HBP		0-3 K		2 1 0 1 0 1 2			
<b>Inning Stats</b>	R: 0 E: 0 K: 1 S: 6 H: 1 LOB: 1 BB: 0 P: 6	R: 0 E: 0 K: 0 S: 3 H: 0 LOB: 0 BB: 0 P: 3	R: 2 E: 0 K: 0 S: 6 H: 2 LOB: 1 BB: 0 P: 6	R: 0 E: 0 K: 1 S: 7 H: 2 LOB: 2 BB: 0 P: 7	R: 0 E: 0 K: 0 S: 3 H: 0 LOB: 0 BB: 0 P: 3	R: 1 E: 0 K: 1 S: 7 H: 2 LOB: 3 BB: 1 P: 12	R: 0 E: 0 K: 0 S: 4 H: 1 LOB: 2 BB: 1 P: 8	R: 0 E: 0 K: 2 S: 7 H: 0 LOB: 0 BB: 0 P: 7	R: 0 E: 0 K: 0 S: 3 H: 0 LOB: 0 BB: 0 P: 3	1B: 7 2B: 1 3B: 0 HR: 0 SF: 0 SAC: 3 DP: 0 HBP: 1	WP: 1 PB: 0 SB: 0 CS: 0 PA: 39		
<b>PITCHER</b>	IP WLS BF H R ER SO BB IBB HBP BLK WP HR S P ERA WHIP											<b>PITCHER</b>	IP WLS BF H R ER SO BB IBB HBP BLK WP HR S P ERA WHIP
Gene Conley, R (1, 1) ERA: 2.98	5.2 L 27 7 3 3 3 0 1 1 0 1 0 31 36 4.76 1.235												
Dave Koslo, L (6, 1) ERA: 2.55	2.1 9 1 0 0 2 0 1 0 0 0 0 12 16 0.00 0.429												
Dave Jolly, R (9, 1) ERA: 2.01	1.0 3 0 0 0 0 0 0 0 0 0 0 3 3 0.00 0.000												

**New York Giants @ Milwaukee Braves**  
**Milwaukee County Stadium, Milwaukee, WI**  
 Fri Aug 27 1954, 4:33 AM EDT  
 Att: 46,944 - Unknown

[livebaseballscorecards.com](http://livebaseballscorecards.com)

<b>AB</b>	<b>33</b>
<b>R</b>	<b>3</b>
<b>H</b>	<b>8</b>
<b>RBI</b>	<b>3</b>
<b>BB</b>	<b>2</b>
<b>SO</b>	<b>5</b>
<b>LOB</b>	<b>17</b>





Batter	1	2	3	4	5	6	7	8	9	AB	R	H	RBI	BB	SO	LOB
Bill Bruton, L OBP: 0.347, SLG: 0.371 (1, 8)	0-0 4-3 1B		0-0 6-3			0-3 K		0-0 1-3		4	1	1	0	0	1	1
Danny O'Connell, R OBP: 0.322, SLG: 0.352 (1, 5)	0-3 K		0-3 K			0-0 6-3			0-0 F5	4	0	0	0	0	2	1
Bobby Thomson, R OBP: 0.464, SLG: 0.654 (1, 7)	0-0 4-3 1-2			0-3 K		0-0 F9			0-0 6-3	4	0	0	0	0	1	1
Joe Adcock, R OBP: 0.366, SLG: 0.532 (1, 3)	0-0 WP 1B			4-0 BB			0-0 F7		0-0 6-3	3	0	1	1	1	0	0
Andy Pafko, R OBP: 0.334, SLG: 0.444 (1, 9)	0-0 F9 1-2			0-3 K			0-0 F7			3	0	0	0	0	1	2
Del Crandall, R OBP: 0.313, SLG: 0.416 (1, 2)		0-0 F5		0-0 F7			0-0 F6			3	0	0	0	0	0	1
Johnny Logan, R OBP: 0.339, SLG: 0.375 (1, 6)		0-0 FC1-6 1B			0-0 L4-6 2B			0-0 1-3		3	0	2	0	0	0	0
Roy Smalley, R OBP: 0.306, SLG: 0.364 (1, 4)		0-0 FC1-6			0-3 K			0-0 1-3		2	0	0	0	0	1	2
Charlie White, L OBP: 0.315, SLG: 0.333 (8, PH)		1-2f								1	0	0	0	0	0	0
Jack Dittmer, L OBP: 0.211, SLG: 0.244 (9, 4)										0	0	0	0	0	0	0
Gene Conley, R OBP: 0.169, SLG: 0.183 (1, 1)			0-0 F3			0-0 L4-6		0-0		2	0	0	0	0	0	1
Dave Koslo, L (6, 1)						2-3				0	0	0	0	0	0	0
Hank Aaron, R OBP: 0.317, SLG: 0.437 (8, PH)										1	0	1	0	0	0	0
Dave Jolly, R OBP: 0.400, SLG: 0.542 (9, 1)								1B		0	0	0	0	0	0	0

Inning Stats	R: 1	H: 2	E: 0	K: 1	S: 7	R: 0	H: 1	E: 1	K: 0	S: 3	R: 0	H: 0	E: 0	K: 1	S: 5	R: 0	H: 0	E: 0	K: 2	S: 7	R: 0	H: 1	E: 0	K: 1	S: 5	R: 0	H: 0	E: 0	K: 1	S: 5	R: 0	H: 0	E: 0	K: 0	S: 4	R: 0	H: 1	E: 0	K: 0	S: 3	R: 0	H: 0	E: 0	K: 0	S: 3	1B: 4	2B: 2	3B: 0	HR: 0	SF: 0	SAC: 0	DP: 1	HBP: 0	WP: 1	PB: 0	SB: 0	CS: 0	PA: 31
--------------	------	------	------	------	------	------	------	------	------	------	------	------	------	------	------	------	------	------	------	------	------	------	------	------	------	------	------	------	------	------	------	------	------	------	------	------	------	------	------	------	------	------	------	------	------	-------	-------	-------	-------	-------	--------	-------	--------	-------	-------	-------	-------	--------

PITCHER	IP	WLS	BF	H	R	ER	SO	BB	IBB	HBP	BLK	WP	HR	S	P	ERA	WHIP
Sal Maglie, R ERA: 3.31 (1, 1)	9.0	W	31	5	1	1	6	1	0	0	0	1	0	42	46	1.00	0.667

**BOTTOM**

**New York Giants @ Milwaukee Braves**  
Milwaukee County Stadium, Milwaukee, WI

Fri Aug 27 1954, 4:33 AM EDT  
Att. 46,944 - Unknown

livebaseballscorecards.com

<b>AB</b>	<b>30</b>
<b>R</b>	<b>1</b>
<b>H</b>	<b>5</b>
<b>RBI</b>	<b>1</b>
<b>BB</b>	<b>1</b>
<b>SO</b>	<b>6</b>
<b>LOB</b>	<b>9</b>



Batter	1	2	3	4	5	6	7	8	9	AB R H RBI BB SO LOB	TOP	
<b>Davey Williams, R</b> (1, 4) OBP: 0.288, SLG: 0.326	0-0 1-3		0-3 K		0-0 F5			0-0 F4		4 0 0 0 0 1 1		
<b>Don Mueller, L</b> (1, 9) OBP: 0.358, SLG: 0.444	4-0 FC5-4 BB		0-0 F6		0-0 1B			4-0 BB		2 0 1 0 2 0 0		
<b>Alvin Dark, R</b> (1, 6) OBP: 0.320, SLG: 0.443	0-0 FC5-4 FC4 1-2f			0-0 F9	0-0 F8			0-0 F5		4 0 0 0 0 0 4		
<b>Willie Mays, R</b> (1, 8) OBP: 0.398, SLG: 0.678	0-0 FC4 1-2f			0-0 2B		0-0 4-3		0-0 F8		4 0 1 0 0 0 2		
<b>Bobby Hofman, R</b> (1, 3) OBP: 0.303, SLG: 0.489		0-0 5-3		0-0 F7		0-3 K			0-0 1B SF7 2B	4 1 1 0 0 1 1		
<b>Monte Irvin, R</b> (1, 7) OBP: 0.372, SLG: 0.440		4-0 1B BB		0-0 F9		0-0 F6			0-0 2-3 E 1B	3 0 1 0 1 0 1		
<b>Hank Thompson, L</b> (1, 5) OBP: 0.372, SLG: 0.463							0-0 F9		0-0 SF7	3 1 2 2 0 0 0		
<b>Wes Westrum, R</b> (1, 2) OBP: 0.323, SLG: 0.327 <b>Foster Castleman, R</b> (9, PH) OBP: 0.333, SLG: 0.333		0-0 F7		0-0 K		0-0 F4		0-0 F7	0-0 3-H	3 0 0 0 0 1 1 1 0 0 0 0 0 1		
<b>Ruben Gomez, R</b> (1, 1) OBP: 0.209, SLG: 0.258 <b>Mary Grissom, R</b> (8, 1) OBP: 0.160, SLG: 0.125 <b>Ray Katt, R</b> (9, PH) OBP: 0.310, SLG: 0.450			0-0 1-3		0-0 1B 1B		0-0 F5		0-3 K	3 0 1 0 0 0 0 0 0 0 0 0 0 0 1 0 0 0 0 1 1		
<b>Inning Stats</b>	R: 0 H: 0 E: 0 LOB: 1 K: 0 BB: 1 S: 3 P: 7	R: 0 H: 1 E: 0 LOB: 1 K: 0 BB: 1 S: 3 P: 7	R: 0 H: 0 E: 0 LOB: 0 K: 1 BB: 0 S: 5 P: 5	R: 0 H: 1 E: 0 LOB: 1 K: 0 BB: 0 S: 4 P: 4	R: 1 H: 3 E: 0 LOB: 2 K: 1 BB: 0 S: 8 P: 8	R: 0 H: 0 E: 0 LOB: 0 K: 1 BB: 0 S: 5 P: 5	R: 0 H: 0 E: 0 LOB: 0 K: 0 BB: 0 S: 3 P: 3	R: 0 H: 0 E: 0 LOB: 1 K: 0 BB: 1 S: 3 P: 7	R: 1 H: 2 E: 1 LOB: 1 K: 1 BB: 0 S: 7 P: 7	1B: 4 SF: 1 2B: 2 SAC: 0 3B: 0 DP: 0 HR: 1 HBP: 0	WP: 0 PA: 36 PB: 0 SB: 0 CS: 0	
<b>PITCHER</b> <b>Warren Spahn, L</b> (1, 1) ERA: 2.96	IP WLS BF H R ER SO BB IBB HBP BLK WP HR S P ERA WHIP	9.0 W 36 7 2 2 4 3 0 0 0 0 1 41 53 2.00 1.111										

**New York Giants @ Milwaukee Braves**  
**Milwaukee County Stadium, Milwaukee, WI**  
 Sat Aug 28 1954, 4:33 AM EDT  
 Att: 41,654 - Unknown

[livebaseballscorecards.com](http://livebaseballscorecards.com)

**AB 32**  
**R 2**  
**H 7**  
**RBI 2**  
**BB 3**  
**SO 4**  
**LOB 12**



Batter	1	2	3	4	5	6	7	8	9
<b>Bill Bruton, L</b> OBP: 0.345, SLG: 0.369 (1, 8) X	0-0 G3		0-0 FC4-6 1B		0-0 CS 1B		0-0 F6	0-0 F6	
<b>Danny O'Connell, R</b> OBP: 0.323, SLG: 0.353 (1, 5) X	0-0 F9		0-0 1B 2-3		0-0 1-2 1B			0-0 F9	
<b>Bobby Thomson, R</b> OBP: 0.469, SLG: 0.633 (1, 7) X	0-0 F9		0-0 1-3 3-H 1B		0-3 K			0-0 5-3 1B	
<b>Joe Adcock, R</b> OBP: 0.363, SLG: 0.528 (1, 3) X		0-0 5-3	0-0 F5		0-0 4-3			0-0 5-3 1-2	
<b>Andy Pafko, R</b> OBP: 0.333, SLG: 0.441 (1, 9) X		0-0 F7		0-0 F8		0-3 K		4-0 1B IBB	
<b>Del Crandall, R</b> OBP: 0.315, SLG: 0.415 (1, 2) X		4-0 BB		0-0 F8		0-0 5-3		0-0 1-2 2-H 1B	
<b>Johnny Logan, R</b> OBP: 0.340, SLG: 0.376 (1, 6) X		0-0 F9		0-0 1B			0-3 K	0-0 1-3 2-H 1B	
<b>Jack Dittmer, L</b> OBP: 0.222, SLG: 0.239 (1, 4) X			4-0 FC1-6 BB		0-0 F6		0-0 F4	4-0 1B IBB	
<b>Warren Spahn, L</b> OBP: 0.295, SLG: 0.316 (1, 1) X			0-0 FC1-6 FC4-6 1-2		0-3 K		4-0 BB	0-0 1-3 2-H 3-H 1B	

Inning Stats	R: 0	H: 0	E: 0	K: 0	S: 3	P: 3	R: 0	H: 0	E: 0	K: 0	S: 3	P: 7	R: 1	H: 2	E: 1	K: 0	S: 5	R: 0	H: 1	E: 0	K: 0	S: 4	P: 4	R: 0	H: 2	E: 0	K: 2	S: 8	P: 8	R: 0	H: 0	E: 0	K: 1	S: 5	P: 5	R: 0	H: 0	E: 0	K: 1	S: 5	P: 9	R: 4	H: 4	E: 0	K: 0	S: 7	P: 15
	LOB: 0	BB: 0	BB: 0	BB: 1	BB: 0	BB: 1	LOB: 1	LOB: 1	LOB: 0	LOB: 0	LOB: 1	LOB: 2	LOB: 2	LOB: 1	LOB: 1	LOB: 0	LOB: 1	LOB: 0	LOB: 0	LOB: 0	LOB: 1	LOB: 1	LOB: 0	LOB: 1	LOB: 2	LOB: 1	LOB: 1	LOB: 0	LOB: 0	LOB: 1	LOB: 0	LOB: 0	LOB: 1	LOB: 0	LOB: 0	LOB: 1	LOB: 0	LOB: 1	LOB: 2	LOB: 2	LOB: 15						

PITCHER	IP	WLS	BF	H	R	ER	SO	BB	IBB	HBP	BLK	WP	HR	S	P	ERA	WHIP
<b>Ruben Gomez, R</b> ERA: 3.0 (1, 1)	7.2	L	34	8	5	4	4	3	1	0	0	0	0	38	54	4.70	1.435
<b>Mary Grissom, R</b> ERA: 2.51 (8, 1)	0.1		3	1	0	0	0	0	1	0	0	0	0	2	6	0.00	3.000

AB R H RBI BB SO LOB

5	1	1	0	0	0	4
4	0	2	0	0	0	0
4	1	2	1	0	1	1
4	0	0	0	0	0	3
3	1	0	0	1	1	0
3	1	1	1	1	0	0
4	1	2	1	0	1	1
2	0	0	0	2	0	1
3	0	1	2	1	1	1

WP	PA	37
1B: 9	SF: 0	
2B: 0	SAC: 0	
3B: 0	DP: 0	
HR: 0	HBP: 0	
WP: 0	PA: 37	
PB: 0		
SB: 0		
CS: 1		

**New York Giants @ Milwaukee Braves**  
Milwaukee County Stadium, Milwaukee, WI  
Sat Aug 28 1954, 4:33 AM EDT  
Att. 41,654 - Unknown

AB	32
R	5
H	9
RBI	5
BB	5
SO	4
LOB	11



ERA	WHIP
4.70	1.435
0.00	3.000

Batter	1	2	3	4	5	6	7	8	9	10	11	AB	R	H	RBI	BB	SO	LOB	TOP							
Davey Williams, R OBP: 0.286, SLG: 0.324 (1, 4)	0-3 K		0-0 6-3		0-0 F9		0-0 1B		0-0 F9		0-0 F8	6	0	1	1	0	1	1								
Whitey Lockman, L OBP: 0.315, SLG: 0.380 (1, 3)	0-0 3-1			0-0 G3		0-0 4-3	0-0 F8		0-0 F8		0-0 6-3	6	0	0	0	0	0	2								
Alvin Dark, R OBP: 0.322, SLG: 0.446 (1, 6)	0-0 F8			0-0 1B 1B		0-0 F7		0-0 1B 3B 1B	0-0 6-3		0-0 2B	6	1	3	0	0	0	0								
Willie Mays, R OBP: 0.403, SLG: 0.685 (1, 8)		0-0 HR		0-0 1B 1-2		4-0 BB		0-0 1B 1-3		0-0 6-3	4-0 IBB	4	1	3	1	2	0	0								
Don Mueller, L OBP: 0.356, SLG: 0.441 (1, 9)		0-0 4-3		0-0 F2		0-0 G3		0-0 6-3		0-0 3B 1B	0-0 F9	6	1	1	0	0	0	6								
Monte Irvin, R OBP: 0.369, SLG: 0.437 Dusty Rhodes, L OBP: 0.440, SLG: 0.816 (8, PH) (8, 7)		0-3 K		0-0 4-3		0-3 K		0-0 3B 3-H		0-0 3B 1-H		3	0	0	0	0	2	2								
Hank Thompson, L OBP: 0.373, SLG: 0.460 Billy Gardner, R OBP: 0.269, SLG: 0.299 (8, PR) (8, 5)		0-0 F6		0-0 F8		4-0 1B BB BB		4-0 BB IBB		0-3 K		2	1	0	0	2	0	0								
Wes Westrum, R OBP: 0.321, SLG: 0.324 Bobby Hofman, R OBP: 0.310, SLG: 0.489 Joey Amalfitano, R OBP: 0.154, SLG: 0.120 Ray Katt, R OBP: 0.319, SLG: 0.450 (7, 2)		0-3 K		0-3 K		4-0 1B BB BB		4-0 BB IBB		4-0 IBB		2	0	0	0	0	2	0								
Don Liddle, L OBP: 0.384, SLG: 0.192 Windy McCall, L OBP: 0.286, SLG: 0.286 Foster Castleman, R OBP: 0.286, SLG: 0.286 Hoyt Wilhelm, R OBP: 0.286, SLG: 0.321 Bill Taylor, L OBP: 0.154, SLG: 0.120 Marv Grissom, R OBP: 0.209, SLG: 0.258 Ruben Gomez, R OBP: 0.209, SLG: 0.258 (11, 1)		0-3 K		0-3 K		4-0 BB		0-3 K		0-3 K		1	0	0	0	1	1	0								
Inning Stats	R: 0 E: 0 K: 1 S: 5	H: 0 LOB: 0 BB: 0 P: 5	R: 1 E: 0 K: 1 S: 6	H: 1 LOB: 0 BB: 0 P: 6	R: 0 E: 0 K: 2 S: 7	H: 0 LOB: 0 BB: 0 P: 7	R: 0 E: 0 K: 0 S: 5	H: 2 LOB: 2 BB: 0 P: 5	R: 0 E: 0 K: 1 S: 5	H: 0 LOB: 1 BB: 1 P: 9	R: 0 E: 0 K: 0 S: 3	H: 0 LOB: 1 BB: 1 P: 7	R: 1 E: 0 K: 2 S: 8	H: 1 LOB: 2 BB: 2 P: 16	R: 1 E: 0 K: 1 S: 7	H: 3 LOB: 3 BB: 2 P: 15	R: 0 E: 0 K: 0 S: 3	H: 0 LOB: 0 BB: 0 P: 3	R: 1 E: 0 K: 2 S: 9	H: 2 LOB: 2 BB: 1 P: 13	R: 0 E: 0 K: 0 S: 4	H: 1 LOB: 2 BB: 1 P: 8	1B: 6 2B: 1 3B: 2 HR: 1	SF: 0 SAC: 0 DP: 0 HBP: 0	WP: 0 PB: 0 SB: 0 CS: 0	PA: 50
PITCHER	IP	WLS	BF	H	R	ER	SO	BB	IBB	HBP	BLK	WP	HR	S	P	ERA	WHIP									
Harvey Haddix, L ERA: 3.58 (1, 1)	7.0		29	4	2	2	7	4	0	0	0	0	1	39	55	2.57	1.143									
Brooks Lawrence, R ERA: 3.78 (8, 1)	0.2		6	3	1	1	0	1	1	0	0	0	0	4	12	13.50	6.000									
Royce Lint, L ERA: 4.89 (8, 1)	1.1		4	0	0	0	1	0	0	0	0	0	0	6	6	0.00	0.000									
Gerry Staley, R ERA: 5.56 (10, 1)	1.2		9	3	1	1	2	0	1	0	0	0	0	12	16	5.40	1.800									
Al Brazle, L ERA: 4.4 (11, 1)	0.1	W	2	0	0	0	0	0	1	0	0	0	0	1	5	0.00	0.000									

New York Giants @ St. Louis Cardinals  
Sportsman's Park, St. Louis, MO  
Sun Aug 29 1954, 4:33 AM EDT  
Unknown

AB	42
R	4
H	10
RBI	4
BB	8
SO	10
LOB	19



1B	6	SF	0
2B	1	SAC	0
3B	2	DP	0
HR	1	HBP	0

Batter	1	2	3	4	5	6	7	8	9	10	11	AB R H RBI BB SO LOB	BOTTOM																		
Alex Grammas, R (1, 6) OBP: 0.301, SLG: 0.295	0-0 2B SF9 1B		0-0 FC3-6 1B		0-0 6-3		4-0 PB BB			0-0 F4	0-0 1-2 2-3 3-H 1B	5 1 3 1 1 0 0	<b>New York Giants @ St. Louis Cardinals</b> Sportsman's Park, St. Louis, MO Sun Aug 29 1954, 4:33 AM EDT Unknown																		
Wally Moon, L (1, 8) OBP: 0.384, SLG: 0.453	0-3 K		0-0 FC3-6 1-2f S		0-0 F3		0-3 K 1-2			0-0 F7		5 0 0 0 0 2 3																			
Stan Musial, L (1, 9) OBP: 0.443, SLG: 0.648	0-0 1-3 2B		0-0 F9 1-2		0-0 HR				0-0 F3		HR	5 2 3 2 0 0 1																			
Ray Jablonski, R (1, 5) OBP: 0.357, SLG: 0.450	0-0 SF9 3-H			0-0 BB 3B	0-0 6-3				0-0 F9		F8	4 0 1 1 0 0 0																			
Red Schoendienst, S (1, 4) OBP: 0.369, SLG: 0.433	0-0 3-1			0-0 5-3		0-0 F8			0-0 1B			5 0 2 0 0 0 2																			
Rip Repulski, R (1, 7) OBP: 0.324, SLG: 0.453		0-0 F7		4-0 BB 1B BB		0-0 F7			0-0 F6		FC1-5 BB FC1-5 1B IBB	3 2 0 0 2 0 0																			
Bill Sami, R (1, 2) OBP: 0.346, SLG: 0.463		0-3 K		4-0 1B 1-2 3-H BB		0-0 F6			0-3 K		FC1-5 1B BB 1-2 2-3f	4 0 0 0 1 2 2																			
Joe Cunningham, L (1, 3) OBP: 0.379, SLG: 0.477		0-3 K		0-0 1-3 2-H 1B		0-3 K			4-0 2B BB		1-2 2-3 BB	3 0 1 1 2 2 0																			
Harvey Haddix, L (1, 1) Joe Frazier, L (7, PH) Brooks Lawrence, R (8, 1) Royce Lint, L (8, 1) Solly Hemus, L (9, PH) Gerry Staley, R (10, 1) Al Brazle, L (11, 1) Peanuts Lowrey, R (11, PH)			0-0 1-3	0-0 F6		0-3 K			0-0 1-H 2B		0-0 F8	2 0 0 0 0 0 2 1 0 0 0 0 0 1 0 1 0 1 0 0 0 0 0 0 0 0 0 0 0 0 0 0 0 0 0 0 1 0 0 0 0 0 0 1 0 0 0 0 0 3																			
<b>Inning Stats</b>	R: 1 E: 0 K: 1 S: 7	H: 2 LOB: 1 BB: 0 P: 7	R: 0 E: 0 K: 2 S: 7	H: 0 LOB: 0 BB: 0 P: 7	R: 0 E: 0 K: 0 S: 4	H: 1 LOB: 1 BB: 0 P: 4	R: 1 E: 0 K: 0 S: 4	H: 2 LOB: 2 BB: 2 P: 12	R: 1 E: 0 K: 0 S: 4	H: 1 LOB: 0 BB: 0 P: 4	R: 0 E: 0 K: 0 S: 3	H: 0 LOB: 0 BB: 0 P: 3		R: 0 E: 0 K: 3 S: 9	H: 0 LOB: 1 BB: 1 P: 13	R: 0 E: 0 K: 0 S: 3	H: 1 LOB: 1 BB: 0 P: 3	R: 0 E: 0 K: 1 S: 5	H: 1 LOB: 2 BB: 1 P: 9	R: 1 E: 0 K: 0 S: 4	H: 1 LOB: 0 BB: 0 P: 4	R: 1 E: 0 K: 0 S: 4	H: 2 LOB: 3 BB: 2 P: 12	1B: 5 2B: 3 3B: 1 HR: 2	SF: 1 SAC: 0 DP: 0 HBP: 0	WP: 0 PB: 1 SB: 1 CS: 0	PA: 46				
<b>PITCHER</b>	IP WLS BF H R ER SO BB IBB HBP BLK WP HR S P ERA WHIP																														
Don Liddle, L (1, 1) ERA: 2.86	5.0	22	6	3	3	3	2	0	0	0	0	0	1	26	34	5.40	1.600														
Windy McCall, L (6, 1) ERA: 2.76	1.0	3	0	0	0	0	0	0	0	0	0	0	0	3	3	0.00	0.000														
Hoyt Wilhelm, R (7, 1) ERA: 2.63	1.0	4	0	0	0	3	1	0	0	0	0	0	0	9	13	0.00	1.000														
Marv Grissom, R (8, 1) ERA: 2.62	3.0	L 13	4	2	2	1	1	1	0	0	0	1	13	21	6.00	1.667															
Ruben Gomez, R (11, 1) ERA: 2.99	0.2	4	1	0	0	0	1	0	0	0	0	0	0	3	7	0.00	3.000														

AB	39
R	5
H	11
RBI	5
BB	6
SO	7
LOB	13



Batter	1	2	3	4	5	6	7	8	9	AB R H RBI BB SO LOB	TOP											
Whitey Lockman, L (1, 3) OBP: 0.316, SLG: 0.379	0-0 F8		0-0 F7		0-0 FC6-4 1B	4-0 1-2 2-3 BB		0-0 F3		4 0 1 0 1 0 0	<b>New York Giants @ St. Louis Cardinals</b> Sportsman's Park, St. Louis, MO Sun Aug 29 1954, 4:38 AM EDT Att: 30,477 - Unknown											
Alvin Dark, R (1, 6) OBP: 0.323, SLG: 0.445	0-0 G6-3 1B		0-0 1B		0-0 FC6-4 1-2f	0-0 F2		0-0 6-3		5 0 2 0 0 0 4												
Don Mueller, L (1, 9) OBP: 0.356, SLG: 0.441	0-0 G6-3 1-2f		0-0 6-3			0-0 F9	0-0 E8 WP 1B	0-0 2B 1B		5 1 2 0 0 0 2												
Dusty Rhodes, L (1, 7) OBP: 0.455, SLG: 0.889		0-0 HR		0-0 4-3		0-0 HR	0-0 HR 2B	0-0 2B		5 3 4 2 0 0 0												
Willie Mays, R (1, 8) OBP: 0.403, SLG: 0.686		0-3 K		0-0 F9		0-0 WP BB FC5-4 1B	0-0 F7		0-0 F1 3B	5 1 2 0 0 1 1												
Hank Thompson, L (1, 5) OBP: 0.378, SLG: 0.468		4-0 6-3 BB		4-0 BB BB BB BB BB	4-0 BB BB	4-0 FC5-4 1-2 1B BB	0-0 2-H HR		0-0 F1	2 2 1 2 3 0 1												
Davey Williams, R (1, 4) OBP: 0.285, SLG: 0.321		0-0 6-3		0-0 1-3		4-0 1-2 2-3 BB FC5-4	0-0 E8		0-3 K	4 0 0 0 1 1 2												
Wes Westrum, R (1, 2) OBP: 0.318, SLG: 0.321		0-3 K		0-0 5-3		0-0 1-2f 2-3 3-H BB 1B	0-0 F9			2 0 0 0 0 1 1												
Bill Taylor, L (6, PH) OBP: 0.258, SLG: 0.321										0 0 0 0 0 0 0												
Bobby Hofman, R (6, PH) OBP: 0.307, SLG: 0.483										1 0 0 1 0 0 2												
Ruben Gomez, R (6, PR) OBP: 0.209, SLG: 0.258										0 0 0 0 0 0 0												
Ray Katt, R (6, 2) OBP: 0.317, SLG: 0.447										1 0 0 0 0 0 1												
Al Worthington, R (1, 1)			0-3 K		0-0 6-3		0-0 1-2 3-H BB 1B	0-3 K		2 0 0 0 0 1 0												
Al Corwin, R (5, 1)										0 0 0 0 0 0 0												
Foster Castleman, R (6, PH) OBP: 0.375, SLG: 0.375										1 0 1 1 0 0 0												
Joey Amalfitano, R (6, PR)										0 0 0 0 0 0 0												
Hoyt Wilhelm, R (6, 1)										1 0 0 0 0 1 1												
<b>Inning Stats</b>	R: 0 E: 0 K: 0 S: 3	H: 1 LOB: 0 BB: 0 P: 3	R: 1 E: 0 K: 2 S: 8	H: 1 LOB: 1 BB: 1 P: 12	R: 0 E: 0 K: 1 S: 6	H: 1 LOB: 1 BB: 0 P: 6	R: 0 E: 0 K: 0 S: 3	H: 0 LOB: 1 BB: 1 P: 7	R: 0 E: 0 K: 0 S: 4	H: 1 LOB: 1 BB: 0 P: 4	R: 3 E: 0 K: 0 S: 6	H: 3 LOB: 3 BB: 3 P: 18	R: 3 E: 2 K: 1 S: 9	H: 3 LOB: 1 BB: 0 P: 9	R: 0 E: 0 K: 0 S: 4	H: 2 LOB: 2 BB: 0 P: 4	R: 0 E: 0 K: 1 S: 5	H: 1 LOB: 0 BB: 0 P: 5	1B: 7 2B: 2 3B: 1 HR: 3	SF: 0 SAC: 0 DP: 1 HBP: 0	WP: 3 PB: 0 SB: 0 CS: 0	PA: 43
<b>PITCHER</b>	IP WLS BF H R ER SO BB IBB HBP BLK WP HR S P ERA WHIP																					
Joe Presko, R (1, 1) ERA: 6.52	5.1 L 25 6 4 4 3 4 0 0 0 1 2 27 43 6.75 1.875																					
Royce Lint, L (6, 1) ERA: 4.86	0.1 3 1 0 0 0 1 0 0 0 0 0 2 6 0.00 6.000																					
Cot Deal, R (6, 1) ERA: 6.37	1.1 8 3 3 3 1 0 0 0 0 1 1 10 10 20.25 2.250																					
Ben Wade, R (8, 1) ERA: 8.44	2.0 7 3 0 0 1 0 0 0 0 0 0 9 9 0.00 1.500																					

livebaseballscorecards.com

AB	38
R	7
H	13
RBI	6
BB	5
SO	5
LOB	15











**New York Giants @ St. Louis Cardinals**  
 Sportsman's Park, St. Louis, MO

Tue Aug 31 1954, 4:33 AM EDT  
 Att: 14,081 - Unknown

[livebaseballscorecards.com](http://livebaseballscorecards.com)

<b>AB</b>	<b>34</b>
<b>R</b>	<b>5</b>
<b>H</b>	<b>11</b>
<b>RBI</b>	<b>5</b>
<b>BB</b>	<b>2</b>
<b>SO</b>	<b>4</b>
<b>LOB</b>	<b>14</b>



AB	R	H	RBI	BB	SO	LOB
4	1	1	0	1	1	1
5	1	1	0	0	0	2
2	1	1	0	1	0	1
4	1	2	2	0	1	2
3	1	2	2	0	0	1
4	0	1	1	0	0	1
4	0	2	0	0	0	2
4	0	1	0	0	0	2
2	0	0	0	0	2	2
2	0	0	0	0	0	0

Batter	1	2	3	4	5	6	7	8	9
<b>Whitey Lockman, L</b> (1, 3) OBP: 0.319, SLG: 0.383	0-3 K		0-0 5-3 2B 1B	0-0 6-3		4-0 BB			0-0 3-1
<b>Alvin Dark, R</b> (1, 6) OBP: 0.322, SLG: 0.442	0-0 F9		0-0 5-3 1-2		0-0 BB 1B 1B	0-0 F8			0-0 F5
<b>Hank Thompson, L</b> (1, 5) OBP: 0.385, SLG: 0.474	0-0 1B		0-0 F2		4-0 1B SF8 BB		1-0 G4-3 HBP		
<b>Dusty Rhodes, L</b> (1, 7) OBP: 0.454, SLG: 0.862	0-0 G3		0-0 1B 2B		0-0 L1-6 1B 1B		0-3 K		
<b>Willie Mays, R</b> (1, 8) OBP: 0.402, SLG: 0.687		0-0 G3 3B	0-0 1B		0-0 SF8		0-0 G4-3		
<b>Don Mueller, L</b> (1, 9) OBP: 0.355, SLG: 0.438		0-0 G3	0-0 G3		0-0 1B			0-0 5-3	
<b>Ray Katt, R</b> (1, 2) OBP: 0.314, SLG: 0.436		0-0 FC5-4 1B		0-0 5-3	0-0 L1-6			0-0 G6-4-3 1B	
<b>Davey Williams, R</b> (1, 4) OBP: 0.285, SLG: 0.322		0-0 FC5-4		0-0 2B		0-0 F7		0-0 G6-4-3	
<b>Don Liddle, L</b> (1, 1) OBP: 0.343, SLG: 0.179	0-3 K		0-3 K		0-0 1-3			0-0 F7	
<b>Windy McCall, L</b> (5, 1)									

Inning Stats	R: 0	H: 1	E: 0	K: 1	S: 6	P: 6
<b>Ralph Beard, R</b> (1, 1) ERA: 3.51	2.2	14	6	3	3	2
<b>Gerry Staley, R</b> (3, 1) ERA: 5.63	1.2	10	4	2	2	1
<b>Ben Wade, R</b> (5, 1) ERA: 8.18	1.2	5	0	0	0	0
<b>Al Brazle, L</b> (7, 1) ERA: 4.23	3.0	9	1	0	0	1

PITCHER	IP	WLS	BF	H	R	ER	SO	BB	IBB	HBP	BLK	WP	HR	S	P	ERA	WHIP
<b>Ralph Beard, R</b> (1, 1) ERA: 3.51	2.2		14	6	3	3	2	0	0	0	0	0	0	18	18	10.12	2.250
<b>Gerry Staley, R</b> (3, 1) ERA: 5.63	1.2	L	10	4	2	2	1	1	0	0	0	0	0	11	15	10.80	3.000
<b>Ben Wade, R</b> (5, 1) ERA: 8.18	1.2		5	0	0	0	0	1	0	0	0	0	0	4	8	0.00	0.600
<b>Al Brazle, L</b> (7, 1) ERA: 4.23	3.0		9	1	0	0	1	0	0	1	0	0	0	10	11	0.00	0.333

WP: 0	PA: 38
PB: 0	
SB: 0	
CS: 0	

Batter	1	2	3	4	5	6	7	8	9	AB	R	H	RBI	BB	SO	LOB
Alex Grammas, R (1, 6) OBP: 0.298, SLG: 0.292	0-0 6-3		0-0 5-3		0-0 F7		0-0 F8			4	0	0	0	0	0	0
Rip Repulski, R (1, 8) OBP: 0.326, SLG: 0.454	0-0 5-3			0-0 1B SF8 1B	0-3 K		0-0 6-3			4	1	1	0	0	1	0
Stan Musial, L (1, 7) OBP: 0.439, SLG: 0.639	0-0 F6			0-0 1B 1-2 1B	0-3 K		0-0 F5			4	1	1	0	0	1	1
Ray Jablonski, R (1, 5) OBP: 0.355, SLG: 0.445		0-0 F9		0-0 1B 1-2 2-3 1B		0-0 BB BB 1B		0-0 F6		4	1	2	0	0	0	0
Red Schoendienst, S (1, 4) OBP: 0.366, SLG: 0.431		0-0 2B		0-0 SF8		0-0 F5		0-0 F6		3	0	1	1	0	0	1
Joe Frazier, L (1, 9) OBP: 0.409, SLG: 0.544		1-0 G6-4-3 HBP		0-0 F8		4-0 BB 1-2 BB		0-0 F2		2	0	0	0	1	0	2
Bill Sarni, R (1, 2) OBP: 0.341, SLG: 0.455		0-0 G6-4-3		0-0 1B 1-3 2-H 1B		0-0 F9			0-0 F8	4	0	1	1	0	0	4
Joe Cunningham, L (1, 3) OBP: 0.378, SLG: 0.465			0-0 6-3	0-0 1B 1-3 3-H 1B		4-0 BB 1-2 2-3 BB		0-3 K		3	0	1	1	1	1	0
Ralph Beard, R (1, 1) Gerry Steiny, R (3, 1) Ben Wade, R (5, 1) Solly Hemus, L (6, PH) Al Brazie, L (7, 1) Peanuts Lowrey, R (9, PH)			0-3 K		0-3 K		0-0 F4		0-0 5-3	0	0	0	0	0	0	0

Inning Stats	R: 0	H: 0	E: 0	K: 0	S: 3	P: 3	R: 0	H: 1	E: 0	K: 0	S: 3	P: 4	R: 0	H: 0	E: 0	K: 1	S: 5	R: 3	H: 5	E: 0	K: 0	S: 7	P: 7	R: 0	H: 0	E: 1	K: 3	S: 10	P: 10	R: 0	H: 1	E: 0	K: 0	S: 4	P: 12	R: 0	H: 0	E: 0	K: 0	S: 3	P: 3	R: 0	H: 0	E: 0	K: 0	S: 3	P: 3	R: 0	H: 0	E: 0	K: 1	S: 5	P: 5	1B: 6	SF: 1	2B: 1	SAC: 0	3B: 0	DP: 1	HR: 0	HBP: 1	WP: 0	PA: 36
PITCHER	IP	WLS	BF	H	R	ER	SO	BB	IBB	HBP	BLK	WP	HR	S	P	ERA	WHIP																																														
Don Liddle, L (1, 1) ERA: 3.01	4.0		17	6	3	3	1	0	0	1	0	0	0	18	19	6.75	1.500																																														
Windy McCall, L (5, 1) ERA: 2.49	5.0	W	19	1	0	0	4	2	0	0	0	0	0	25	33	0.00	0.600																																														

**BOTTOM**

**New York Giants @ St. Louis Cardinals**  
 Sportsman's Park, St. Louis, MO  
 Tue Aug 31 1954, 4:33 AM EDT  
 Att. 14,081 - Unknown

livebaseballscorecards.com

<b>AB</b>	<b>32</b>
<b>R</b>	<b>3</b>
<b>H</b>	<b>7</b>
<b>RBI</b>	<b>3</b>
<b>BB</b>	<b>2</b>
<b>SO</b>	<b>5</b>
<b>LOB</b>	<b>11</b>





BOTTOM

New York Giants @ Cincinnati Redlegs  
Crosley Field, Cincinnati, OH

AB	31
R	9
H	13
RBI	9
BB	10
SO	2
LOB	24



WP	0	PA	45
PB	0		
SB	0		
CS	0		

Wed Sep 01 1954, 3:33 AM EDT  
Att. 17,369 - Unknown

livebaseballscorecards.com

AB	3	R	1	H	0	RBI	0	BB	1	SO	1	LOB	4
	0	1	0	0	1	0	0	0	0	0	0		

2	2	1	0	2	0	1							
---	---	---	---	---	---	---	--	--	--	--	--	--	--

4	2	2	0	1	0	3							
---	---	---	---	---	---	---	--	--	--	--	--	--	--

5	1	4	3	0	0	0							
---	---	---	---	---	---	---	--	--	--	--	--	--	--

2	1	1	0	3	1	3							
---	---	---	---	---	---	---	--	--	--	--	--	--	--

5	0	2	2	0	0	7							
---	---	---	---	---	---	---	--	--	--	--	--	--	--

3	1	1	2	0	0	0							
---	---	---	---	---	---	---	--	--	--	--	--	--	--

3	0	2	1	2	0	0							
---	---	---	---	---	---	---	--	--	--	--	--	--	--

2	0	0	1	0	0	3							
---	---	---	---	---	---	---	--	--	--	--	--	--	--

2	0	0	0	0	0	3							
---	---	---	---	---	---	---	--	--	--	--	--	--	--

0	0	0	0	0	0	0							
---	---	---	---	---	---	---	--	--	--	--	--	--	--

1B	12	SF	3	WP	0	PA	45
2B	3	SAC	1	PB	0		
3B	0	DP	3	SB	0		
HR	0	HBP	0	CS	0		

Batter	1	2	3	4	5	6	7	8	9
Bobby Adams, R OBP: 0.362, SLG: 0.373 Rocky Bridges, R OBP: 0.365, SLG: 0.289 (9, 5)	4-0 1B BB	0-0 F9	0-0 5-3		0-3 K			4-0 1B SH 1B BB	
Roy McMillan, R OBP: 0.300, SLG: 0.309 (1, 6)	0-0 F2		4-0 1B BB BB	0-0 1B 1B	4-0 1-2 BB			0-0 SH 1B 1B 1-2 1B	
Gus Bell, L OBP: 0.344, SLG: 0.468 (1, 8)	0-0 1B 1-3 1B		4-0 1B BB 1-2 1B	0-0 F8	0-0 4-3			0-0 1B 1B 1-2 SF8 2-3 1B	
Ted Kluszewski, L OBP: 0.399, SLG: 0.642 (1, 3)	0-0 1-3 3-H 1B		0-0 1B SF8 1-3 2-H 1B	0-0 BB 1-3 1B		0-0 F8		0-0 SF8 1B 1-2 1B 2-3 1B 3-H	
Jim Greengrass, R OBP: 0.331, SLG: 0.505 (1, 7)	4-0 F9-3 IBB		4-0 1B IBB	4-0 1-2 BB		0-0 G6-4-3 1B		0-0 K	
Johnny Temple, R OBP: 0.381, SLG: 0.362 (1, 4)	0-0 F9-3		0-0 FC3-6 1B 1-2 2-3 3-H 1B	0-0 L1-3		0-0 G6-4-3		0-0 SF8 1B 1-2 1B 2-3 1B 3-H	
Wally Post, R OBP: 0.284, SLG: 0.411 (1, 9)		0-0 6-3	0-0 SF8		0-0 1B SF9 2B			0-0 F8	0-0 SF8 1-2 1B 2-3 3-H
Andy Seminick, R OBP: 0.372, SLG: 0.403 (1, 2)		4-0 BB	0-0 FC3-6 1-2 2-H 1B		0-0 BB 2-3 1B			0-0 6-3	4-0 IBB
Joe Nuxhall, L OBP: 0.289, SLG: 0.324 Art Fowler, R OBP: 0.194, SLG: 0.091 Frank Smith, R (9, 1)		0-0 F7	0-0 FC3-6 1-2 2-3		0-0 SF9 3-H			0-0 4-3	0-0 1-3

Inning Stats	R: 1	H: 2	E: 0	K: 0	S: 4	R: 0	H: 0	E: 0	K: 0	S: 3	R: 0	H: 0	E: 0	K: 0	S: 6	R: 4	H: 3	E: 0	K: 0	S: 6	R: 0	H: 2	E: 0	K: 0	S: 4	R: 1	H: 2	E: 0	K: 1	S: 7	R: 0	H: 1	E: 0	K: 0	S: 3	R: 0	H: 0	E: 0	K: 0	S: 3	R: 3	H: 3	E: 1	K: 1	S: 9	R: 0	H: 0	E: 0	K: 0	S: 3
--------------	------	------	------	------	------	------	------	------	------	------	------	------	------	------	------	------	------	------	------	------	------	------	------	------	------	------	------	------	------	------	------	------	------	------	------	------	------	------	------	------	------	------	------	------	------	------	------	------	------	------

PITCHER	IP	WLS	BF	H	R	ER	SO	BB	IBB	HBP	BLK	WP	HR	S	P	ERA	WHIP
Jim Hearn, R ERA: 4.24 (1, 1)	0.1		4	2	1	1	0	1	0	0	0	0	0	3	7	27.00	9.000
Al Worthington, R ERA: 5.59 (1, 1)	1.2	L	8	0	2	2	0	3	1	0	0	0	0	4	20	10.80	1.800
Al Corwin, R ERA: 4.88 (3, 1)	0.1		5	3	2	2	0	0	1	0	0	0	0	4	8	54.00	9.000
Mary Grissom, R ERA: 2.64 (3, 1)	2.2		13	4	1	1	1	2	0	0	0	0	0	13	21	3.38	2.250
Hoyt Wilhelm, R ERA: 2.56 (6, 1)	2.0		6	1	0	0	0	0	0	0	0	0	0	6	6	0.00	0.500

PITCHER	IP	WLS	BF	H	R	ER	SO	BB	IBB	HBP	BLK	WP	HR	S	P	ERA	WHIP
Ruben Gomez, R ERA: 3.04 (8, 1)	0.0		3	1	3	1	0	1	0	0	0	0	0	2	6		
Don Liddle, L ERA: 2.98 (8, 1)	1.0		6	2	0	0	1	0	1	0	0	0	0	7	11	0.00	2.000

Batter	1	2	3	4	5	6	7	8	9	AB R H RBI BB SO LOB	TOP
<b>Jim Gilliam, S</b> (1, 4) <small>OBP: 0.355, SLG: 0.417</small>	4-2 	0-0 			1-2 		0-1 		1-1 	4 2 1 0 1 0 0	
<b>Pee Wee Reese, R</b> (1, 6) <small>OBP: 0.399, SLG: 0.458</small>	0-0 	3-2 			2-2 		2-1 		2-1 	5 0 2 1 0 0 1	
<b>Duke Snider, L</b> (1, 8) <small>OBP: 0.435, SLG: 0.657</small>	1-0 	2-3 			3-3 		2-3 		3-2 	5 1 1 1 0 3 2	
<b>Gil Hodges, R</b> (1, 3) <small>OBP: 0.383, SLG: 0.587</small>	0-0 		0-1 		0-2 			2-3 	3-3 	5 1 1 1 0 2 2	
<b>Sandy Amoros, L</b> (1, 7) <small>OBP: 0.330, SLG: 0.468</small>	4-1 		2-0 		2-2 			2-3 		3 0 1 0 1 1 0	
<b>Carl Furillo, R</b> (1, 9) <small>OBP: 0.363, SLG: 0.437</small>	1-1 		2-1 		1-0 			4-2 		3 0 1 1 1 0 1	
<b>Jackie Robinson, R</b> (1, 5) <small>OBP: 0.415, SLG: 0.516</small>	2-1 			2-2 		1-2 		4-1 		3 0 0 0 1 0 3	
<b>Rube Walker, L</b> (1, 2) <small>OBP: 0.295, SLG: 0.340</small>		2-0 		0-0 		4-0 		4-0 		2 0 0 0 2 0 0	
<b>Billy Loes, R</b> (1, 1) <small>OBP: 0.160, SLG: 0.125</small>			1-2 		2-1 		3-3 		0-1 	3 0 0 0 0 1 2	
<b>Jim Hughes, R</b> (6, 1) <small>OBP: 0.143, SLG: 0.143</small>										0 0 0 0 0 0 0	
<b>Walt Moryn, L</b> (8, PH) <small>OBP: 0.348, SLG: 0.469</small>										1 0 0 0 0 0 3	
<b>Clem Labine, R</b> (8, 1) <small>OBP: 0.161, SLG: 0.037</small>										0 0 0 0 0 0 0	
<b>Inning Stats</b>	R: 2 H: 2 E: 0 LOB: 2 K: 0 BB: 2 S: 10 P: 22	R: 1 H: 2 E: 0 LOB: 1 K: 1 BB: 0 S: 14 P: 22	R: 0 H: 0 E: 0 LOB: 0 K: 0 BB: 0 S: 5 P: 9	R: 0 H: 0 E: 0 LOB: 0 K: 0 BB: 0 S: 7 P: 11	R: 0 H: 0 E: 0 LOB: 0 K: 1 BB: 0 S: 11 P: 17	R: 1 H: 2 E: 0 LOB: 2 K: 1 BB: 1 S: 16 P: 27	R: 0 H: 0 E: 0 LOB: 0 K: 1 BB: 0 S: 7 P: 11	R: 0 H: 0 E: 0 LOB: 3 K: 2 BB: 3 S: 13 P: 29	R: 0 H: 1 E: 0 LOB: 1 K: 1 BB: 0 S: 10 P: 19	1B: 5 SF: 0 2B: 0 SAC: 0 3B: 1 DP: 0 HR: 1 HBP: 0	WP: 1 PA: 40 PB: 0 SB: 0 CS: 0
<b>PITCHER</b> <b>Sal Maglie, R</b> (1, 1) <small>ERA: 3.39</small> <b>Hoyt Wilhelm, R</b> (7, 1) <small>ERA: 2.47</small>	IP WLS BF H R ER SO BB IBB HBP BLK WP HR S P ERA WHIP 6.0 0 27 6 4 4 3 2 1 0 0 1 1 63 108 6.00 1.333 3.0 W 13 1 0 0 4 3 0 0 0 0 0 0 30 59 0.00 1.333	<b>PITCHER</b> IP WLS BF H R ER SO BB IBB HBP BLK WP HR S P ERA WHIP									

**Brooklyn Dodgers @ New York Giants**  
 Polo Grounds, New York, NY  
 Fri Sep 03 1954, 3:33 AM EDT  
 Att. 46,611 - Unknown

[livebaseballscorecards.com](http://livebaseballscorecards.com)

AB	34
R	4
H	7
RBI	4
BB	6
SO	7
LOB	14















Batter	1	2	3	4	5	6	7	8	9	AB R H RBI BB SO LOB
Whitey Lockman, L (1, 3) OBP: 0.326, SLG: 0.388	4-0 HR BB		0-0 1B 1B	4-0 2B BB			0-0 P6		0-0 1-3	3 3 1 0 2 0 0
Alvin Dark, R (1, 6) OBP: 0.333, SLG: 0.456	0-0 F7		0-0 F6	0-0 2B			0-0 G3-6-3 1B		0-0 WP 1B	5 1 3 2 0 0 2
Hank Thompson, L (1, 5) OBP: 0.395, SLG: 0.501	0-0 HR		0-0 1B 1B	0-0 3-1			0-0 G3-6-3 1-2f		0-0 1B	5 2 3 3 0 0 2
Willie Mays, R (1, 8) OBP: 0.403, SLG: 0.683	0-0 F4		0-0 1B 1B						0-0 1B 3B	4 1 2 1 0 0 0
Dusty Rhodes, L (1, 7) OBP: 0.447, SLG: 0.812	0-3 K		0-0 1B						0-0 G3	4 0 1 1 0 2 1
Don Mueller, L (1, 9) OBP: 0.353, SLG: 0.431			0-0 G6-4-3						0-0 WP 1B	4 0 1 1 0 0 2
Davey Williams, R (1, 4) OBP: 0.287, SLG: 0.326									0-0 F8	4 0 1 0 0 0 1
Ray Katt, R (1, 2) OBP: 0.328, SLG: 0.451									0-0 F8	4 1 1 0 0 0 2
Don Liddle, L (1, 1) OBP: 0.316, SLG: 0.161									0-0 F3	3 0 0 0 0 0 2
Mary Grissom, R (7, 1) OBP: 0.172, SLG: 0.111									0-0 F7	1 0 0 0 0 0 0

Inning Stats	R: 2 E: 0 K: 1 S: 6	H: 1 LOB: 0 BB: 1 P: 10	R: 0 E: 0 K: 0 S: 4	H: 1 LOB: 1 BB: 0 P: 4	R: 2 E: 0 K: 0 S: 6	H: 4 LOB: 1 BB: 0 P: 6	R: 2 E: 0 K: 0 S: 5	H: 2 LOB: 1 BB: 1 P: 9	R: 0 E: 0 K: 1 S: 5	H: 0 LOB: 0 BB: 0 P: 5	R: 0 E: 0 K: 0 S: 3	H: 0 LOB: 0 BB: 0 P: 3	R: 0 E: 0 K: 0 S: 3	H: 1 LOB: 0 BB: 0 P: 3	R: 1 E: 0 K: 0 S: 5	H: 2 LOB: 1 BB: 0 P: 5	R: 1 E: 0 K: 0 S: 4	H: 2 LOB: 1 BB: 0 P: 4	1B: 10 2B: 1 3B: 1 HR: 1	SF: 0 SAC: 0 DP: 2 HBP: 0	WP: 2 PB: 0 SB: 0 CS: 0	PA: 39
--------------	------------------------------	----------------------------------	------------------------------	---------------------------------	------------------------------	---------------------------------	------------------------------	---------------------------------	------------------------------	---------------------------------	------------------------------	---------------------------------	------------------------------	---------------------------------	------------------------------	---------------------------------	------------------------------	---------------------------------	-----------------------------------	------------------------------------	----------------------------------	--------

PITCHER	IP	WLS	BF	H	R	ER	SO	BB	IBB	HBP	BLK	WP	HR	S	P	ERA	WHIP
Murry Dickson, R (1, 1) ERA: 3.73	3.2	L	20	8	6	6	1	2	0	0	0	0	1	20	28	14.73	2.727
Bob Miller, R (4, 1) ERA: 4.72	3.1		10	1	0	0	1	0	0	0	0	0	0	12	12	0.00	0.300
Steve Ridzik, R (8, 1) ERA: 3.91	2.0		9	4	2	2	0	0	0	0	0	2	0	9	9	9.00	2.000

**TOP**

**New York Giants @ Philadelphia Phillies**  
**Connie Mack Stadium, Philadelphia, PA**  
 Mon Sep 06 1954, 3:33 AM EDT  
 Unknown

<b>AB</b>	<b>37</b>
<b>R</b>	<b>8</b>
<b>H</b>	<b>13</b>
<b>RBI</b>	<b>8</b>
<b>BB</b>	<b>2</b>
<b>SO</b>	<b>2</b>
<b>LOB</b>	<b>12</b>



livebaseballscorecards.com

BOTTOM

New York Giants @ Philadelphia Phillies  
Connie Mack Stadium, Philadelphia, PA  
Mon Sep 06 1954, 3:33 AM EDT  
Unknown

livebaseballscorecards.com

AB	34
R	4
H	9
RBI	4
BB	2
SO	3
LOB	9



WP	0	PA	36
PB	0	SB	0
CS	0		

AB R H RBI BB SO LOB

4 0 0 0 0 0 1

3 0 0 0 0 0 0

1 0 0 0 0 1 0

4 1 1 0 0 1 0

4 0 0 0 0 0 1

2 0 1 0 0 0 0

2 1 1 1 0 0 0

4 1 1 0 0 0 2

4 1 4 1 0 0 0

3 0 0 0 1 0 4

1 0 1 2 0 0 0

1 0 0 0 0 1 0

0 0 0 0 1 0 0

0 0 0 0 0 0 0

1 0 0 0 0 0 1

1B	7	SF	0
2B	2	SAC	0
3B	1	DP	1
HR	0	HBP	0

Batter	1	2	3	4	5	6	7	8	9
Richie Ashburn, L (1, 8) OBP: 0.439, SLG: 0.374	0-0 F7		0-0 L4		0-0 6-3		0-0 F8-3		
Danny Schell, R (1, 7) OBP: 0.325, SLG: 0.437	0-0 F2		0-0 L7		0-0 P3		0-3 K		
Johnny Wyrostek, L (7, PH) OBP: 0.313, SLG: 0.379									
Stan Lopata, R (1, 2) OBP: 0.372, SLG: 0.505	0-0 5-3		0-0 5-3			0-0 3B 1B		0-3 K	
Granny Hamner, R (1, 4) OBP: 0.361, SLG: 0.490		0-0 F7		0-0 F2		0-0 F9		0-0 6-3	
Del Ennis, R (1, 9) OBP: 0.318, SLG: 0.463		0-0 F7		0-0 E1 1B		0-0 2B 3B		0-0 G3	
Mel Clark, R (5, 9) OBP: 0.281, SLG: 0.320									
Bobby Morgan, R (1, 6) OBP: 0.376, SLG: 0.460		0-0 BB 1B 1B		0-0 E1 1B		0-0 F9		0-0 F8	
Willie Jones, R (1, 5) OBP: 0.345, SLG: 0.412		0-0 BB 1B		0-0 1B		0-0 2B		0-0 E8 1B	
Earl Torgeson, L (1, 3) OBP: 0.363, SLG: 0.373		4-0 BB 1B BB		0-0 4-3		0-0 5-3		0-0 6-3	
Murry Dickson, R (1, 1) OBP: 0.178, SLG: 0.194		0-0 BB							
Bob Miller, R (4, 1) OBP: 0.200, SLG: 0.234						0-3 K			
Floyd Baker, L (7, PH) OBP: 0.295, SLG: 0.256									
Steve Ridzik, R (8, 1) OBP: 0.227, SLG: 0.318		1-3 2-H 3-H 1B							
Smoky Burgess, L (9, PH) OBP: 0.418, SLG: 0.497									

Inning Stats	R	H	E	K	S	P	BB	IBB	HBP	BLK	WP	HR	S	P	ERA	WHIP
	0	0	0	0	3	3	0	0	0	0	0	0	27	31	6.00	1.500
	2	3	0	0	5	5	2	0	0	0	0	0	13	17	0.00	0.667

PITCHER	IP	WLS	BF	H	R	ER	SO	BB	IBB	HBP	BLK	WP	HR	S	P	ERA	WHIP
Don Liddle, L (1, 1) ERA: 3.15	6.0	W	26	8	4	4	1	1	0	0	0	0	0	27	31	6.00	1.500
Mary Grissom, R (7, 1) ERA: 2.59	3.0	S	10	1	0	0	2	1	0	0	0	0	0	13	17	0.00	0.667

Batter	1	2	3	4	5	6	7	8	9	10	11	AB R H RBI BB SO LOB	TOP														
<b>Whitey Lockman, L</b> (1, 3) OBP: 0.323, SLG: 0.384	0-0 4-3		0-0 P6		0-3 K		0-0 6-3			0-0 F3		5 0 0 0 0 1 2	<b>New York Giants @ Philadelphia Phillies</b> Connie Mack Stadium, Philadelphia, PA Mon Sep 06 1954, 3:38 AM EDT Att. 35,272 - Unknown														
<b>Alvin Dark, R</b> (1, 6) OBP: 0.332, SLG: 0.459	0-0 1-3			0-0 F8		0-0 1-3		0-0 HR		0-0 F8		5 1 1 1 0 0 0															
<b>Hank Thompson, L</b> (1, 5) OBP: 0.391, SLG: 0.495	0-0 F9			0-3 K		0-3 K		0-0 P4		0-0 L4		5 0 0 0 0 2 0															
<b>Willie Mays, R</b> (1, 8) OBP: 0.403, SLG: 0.682		0-0 F6		0-0 1B 2B		4-0 S BB		0-0 5-3		0-0 F8		4 1 1 0 1 0 0															
<b>Dusty Rhodes, L</b> (1, 7) OBP: 0.439, SLG: 0.790		0-0 F3		0-0 1B		0-3 K 1-2		0-0 F7		0-3 K		5 0 1 1 0 2 1															
<b>Don Mueller, L</b> (1, 9) OBP: 0.352, SLG: 0.430		0-0 F8		0-0 F9			0-0 SH5-3 HR 1B		0-0 F8			4 1 1 0 0 0 1															
<b>Davey Williams, R</b> (1, 4) OBP: 0.285, SLG: 0.324			0-0 6-3		0-0 P4		0-0 SH5-3 1-2		0-0 F9			3 0 0 0 0 0 0															
<b>Ray Katt, R</b> (1, 2) OBP: 0.326, SLG: 0.452			0-0 2B		0-0 6-3		0-0 5-3		0-0 5-3			4 0 1 0 0 0 1															
<b>Windy McCall, L</b> (1, 1) <b>Hoyt Wilhelm, R</b> (6, 1) <b>Montie Irvin, R</b> (7, PH) <b>Don Liddle, L</b> (7, 1) <b>Al Corwin, R</b> (7, 1) <b>Marv Grissom, R</b> (8, 1) <b>Foster Castleman, R</b> (10, PH) <b>Al Worthington, R</b> (10, 1)			0-3 K		0-0 E3		0-0 2-H HR		0-3 K			2 0 0 0 0 1 1 0 0 0 0 0 0 0 1 1 1 2 0 1 0 0 0 0 1 0 0 0 0 0 0 0 0															
<b>Inning Stats</b>	R: 0 E: 0 K: 0 S: 3	H: 0 LOB: 0 BB: 0 P: 3	R: 0 E: 0 K: 0 S: 3	H: 0 LOB: 0 BB: 0 P: 3	R: 0 E: 0 K: 1 S: 6	H: 1 LOB: 1 BB: 0 P: 6	R: 1 E: 0 K: 1 S: 7	H: 2 LOB: 1 BB: 0 P: 7	R: 0 E: 1 K: 1 S: 6	H: 0 LOB: 1 BB: 0 P: 6	R: 0 E: 0 K: 2 S: 7	H: 0 LOB: 1 BB: 1 P: 11		R: 2 E: 0 K: 0 S: 5	H: 2 LOB: 0 BB: 0 P: 5	R: 1 E: 0 K: 0 S: 4	H: 1 LOB: 0 BB: 0 P: 4	R: 0 E: 0 K: 0 S: 3	H: 0 LOB: 0 BB: 0 P: 3	R: 0 E: 0 K: 1 S: 5	H: 0 LOB: 0 BB: 0 P: 5	R: 0 E: 0 K: 1 S: 5	H: 0 LOB: 0 BB: 0 P: 5	1B: 2 2B: 2 3B: 0 HR: 2	SF: 0 SAC: 1 DP: 0 HBP: 0	WP: 0 PB: 0 SB: 1 CS: 0	PA: 41
<b>PITCHER</b> <b>Robin Roberts, R</b> (1, 1) ERA: 3.16	IP 11.0	WLS W	BF 41	H 6	R 4	ER 4	SO 7	BB 1	IBB 0	HBP 0	BLK 0	WP 0		HR 2	S 54	P 58	ERA 3.27	WHIP 0.636									

livebaseballscores.com

AB	39
R	4
H	6
RBI	4
BB	1
SO	7
LOB	6



Batter	1	2	3	4	5	6	7	8	9	10	11	AB	R	H	RBI	BB	SO	LOB
Richie Ashburn, L (1.8) OBP: 0.440, SLG: 0.376	0-0 E 1B		0-0 6-3			0-0 6-3	0-0 SH1-4 1B		0-0 3-1		0-0 4-3 1B	6	1	3	0	0	0	0
Mel Clark, R (1.7) OBP: 0.285, SLG: 0.323	0-0 E4 CS 1-3			0-0 F8		0-0 2B E 1B	0-0 SH1-4 1-2		0-0 1B		0-0 4-3 1-2	5	1	2	0	0	0	2
Stan Lopata, R (1.2) OBP: 0.375, SLG: 0.511	0-3 K 1-2			0-0 2B 1B		0-0 E 2B	0-0 P6		0-0 L7		4-0 1B IBB	3	0	2	0	0	1	2
Curt Simmons, L (6. PR) OBP: 0.210, SLG: 0.179												0	1	0	0	0	0	0
Smoky Burgess, L (7.2) OBP: 0.417, SLG: 0.494												2	0	0	0	1	0	2
Granny Hamner, R (1.4) OBP: 0.360, SLG: 0.488	0-0 F8			0-0 F8		4-0 E 1B IBB	0-0 F9		0-3 K		0-0 1-2 2-H	5	1	1	1	1	1	4
Del Ennis, R (1.9) OBP: 0.319, SLG: 0.465		0-0 5-3		0-0 2B		0-0 E5 1B 5-3		0-3 K		0-0 F9-3 1B		5	1	2	1	0	1	1
Bobby Morgan, R (1.6) OBP: 0.374, SLG: 0.459		0-0 F3		0-3 K		0-0 5-3 1-2		0-0 2B		0-0 F9-3 1-2		5	0	1	0	0	1	6
Willie Jones, R (1.5) OBP: 0.345, SLG: 0.411		0-0 F2				0-0 P5 BB 1B		0-0 P3		0-0 1B		5	0	2	2	0	0	1
Earl Torgeson, L (1.3) OBP: 0.363, SLG: 0.371			0-3 K			0-0 P6 BB 1-2		4-0 BB IBB		0-3 K2-3		2	0	0	0	1	1	0
Johnny Wyrostek, L (7.3) OBP: 0.314, SLG: 0.377												1	0	0	0	1	1	1
Robin Roberts, S (1.1) OBP: 0.167, SLG: 0.196			0-0 6-3			0-0 1-3	0-0 F9		0-0 F7		0-3 K	5	0	0	0	0	1	4

BOTTOM

New York Giants @ Philadelphia Phillies  
 Connie Mack Stadium, Philadelphia, PA  
 Mon Sep 06 1954: 3:38 AM EDT  
 Att. 35,272 - Unknown

livebaseballscores.com

AB	44
R	5
H	13
RBI	4
BB	4
SO	7
LOB	23



Inning	R	H	E	K	S	IP	WLS	BF	H	R	ER	SO	BB	IBB	HBP	BLK	WP	HR	S	P	ERA	WHIP	
1	0	1	1	1	6																		
2	0	0	0	0	3																		
3	0	0	0	1	5																		
4	0	2	0	1	7																		
5	0	0	0	0	3																		
6	4	3	1	0	7																		
7	0	1	0	0	4																		
8	0	1	0	1	6																		
9	0	1	0	1	6																		
10	0	2	0	0	6																		
11	1	2	0	1	6																		

1B:	10	SF:	0
2B:	5	SAC:	1
3B:	0	DP:	2
HR:	0	HBP:	0
WP:	0	PA:	49
PB:	0		
SB:	0		
CS:	1		

PITCHER	IP	WLS	BF	H	R	ER	SO	BB	IBB	HBP	BLK	WP	HR	S	P	ERA	WHIP
Windy McCall, L (1.1) ERA: 2.41	5.1		21	5	2	1	3	0	0	0	0	0	0	27	27	1.69	0.938
Hoyt Wilhelm, R (6.1) ERA: 2.51	0.2		6	1	2	0	0	1	1	0	0	0	0	4	12	0.00	3.000
Don Liddle, L (7.1) ERA: 3.13	0.2		3	1	0	0	0	0	0	0	0	0	0	3	3	0.00	1.500
Al Corwin, R (7.1) ERA: 4.6	0.2		3	1	0	0	1	0	0	0	0	0	0	5	5	0.00	1.500
Marv Grissom, R (8.1) ERA: 2.55	1.2		7	1	0	0	1	0	1	0	0	0	0	8	12	0.00	0.600
Al Worthington, R (10.1) ERA: 5.56	1.2		9	4	1	1	2	0	1	0	0	0	0	12	16	5.40	2.400

Batter	1	2	3	4	5	6	7	8	9	10	11	AB R H RBI BB SO LOB	TOP														
Davey Williams, R OBP: 0.284, SLG: 0.322 (1, 4)	X 0-0 F1		X 0-0 F9		X 0-0 4-3			X 0-0 F3			B B B B 4-0 SH2-4 2B BB	4 1 0 0 1 0 1	<p><b>New York Giants @ Philadelphia Phillies</b>  <b>Connie Mack Stadium, Philadelphia, PA</b></p> <p>Tue Sep 07 1954, 3:33 AM EDT  Att. 13,535 - Unknown</p> <p>livebaseballscorecards.com</p> <table border="1"> <tr><td>AB</td><td>36</td></tr> <tr><td>R</td><td>3</td></tr> <tr><td>H</td><td>6</td></tr> <tr><td>RBI</td><td>2</td></tr> <tr><td>BB</td><td>4</td></tr> <tr><td>SO</td><td>3</td></tr> <tr><td>LOB</td><td>11</td></tr> </table> 	AB	36	R	3	H	6	RBI	2	BB	4	SO	3	LOB	11
AB	36																										
R	3																										
H	6																										
RBI	2																										
BB	4																										
SO	3																										
LOB	11																										
Alvin Dark, R OBP: 0.331, SLG: 0.458 (1, 6)	X 0-0 F8		X 0-0 1B			S S S 0-3 K			X 0-0 F8		X 0-0 SH2-4 1-2	4 0 1 0 0 1 0															
Hank Thompson, L OBP: 0.388, SLG: 0.490 Eric Rodin, R (11, PH)	S S S 0-3 K			X 0-0 4-3		X 0-0 F4			X 0-0 F4		S S S 0-3 K	4 0 0 0 0 1 0 1 0 0 0 0 1 1 0 0 0 0 0 0 0															
Billy Gardner, R OBP: 0.266, SLG: 0.295 (11, 5)																											
Willie Mays, R OBP: 0.407, SLG: 0.681 (1, 8)		B B B B 4-0 1B G5-4-3 BB		B B B B 4-0 BB		X 0-0 F8			X 0-0 FC6-4 1B		X 0-0 2B IBB	2 2 1 0 3 0 0															
Monte Irvin, R OBP: 0.373, SLG: 0.448 (1, 7)		X 0-0 G5-4-3 1-3 1B		X 0-0 F9			X 0-0 F8		X 0-0 FC6-4 1-2f		X 0-0 2B 1-H 2-H	5 0 2 2 0 0 2															
Bobby Hofman, R OBP: 0.294, SLG: 0.448 Whitey Lockman, L OBP: 0.322, SLG: 0.383 (1, 3) (8, 3)	X 0-0 G5-4-3 1-2f 3-H		X 0-0 F3				X 0-0 1-3			X 0-0 5-3	X 0-0 4-3	3 0 0 0 0 0 2 2 0 0 0 0 0 1															
Don Mueller, L OBP: 0.353, SLG: 0.430 (1, 9)	X 0-0 FC6-4 1B			X 0-0 E5 SH3			X 0-0 5-3			X 0-0 FC6-4 1B		4 0 2 0 0 0 0															
Ray Katt, R OBP: 0.321, SLG: 0.444 (1, 2)	X 0-0 FC6-4 1-2f			X 0-0 SH3 1-2				X 0-0 F9		X 0-0 F8		3 0 0 0 0 0 2															
Ruben Gomez, R OBP: 0.192, SLG: 0.236 Hoyt Wilhelm, R OBP: 0.056, SLG: 0.056 (1, 1) (11, 1)			X 0-0 F7		X 0-0 F3			X 0-0 F9		X 0-0 FC6-4 1-2f		4 0 0 0 0 0 2 0 0 0 0 0 0 0															
<b>Inning Stats</b>	R: 0 H: 0 E: 0 LOB: 0 K: 1 BB: 0 S: 5 P: 5	R: 1 H: 2 E: 0 LOB: 1 K: 0 BB: 1 S: 4 P: 8	R: 0 H: 1 E: 0 LOB: 1 K: 0 BB: 0 S: 3 P: 3	R: 0 H: 0 E: 0 LOB: 1 K: 0 BB: 1 S: 3 P: 7	R: 0 H: 0 E: 1 LOB: 1 K: 0 BB: 0 S: 4 P: 4	R: 0 H: 0 E: 0 LOB: 0 K: 1 BB: 0 S: 5 P: 5	R: 0 H: 0 E: 0 LOB: 0 K: 0 BB: 0 S: 3 P: 3	R: 0 H: 0 E: 0 LOB: 0 K: 0 BB: 0 S: 3 P: 3	R: 0 H: 1 E: 0 LOB: 1 K: 0 BB: 0 S: 4 P: 4	R: 0 H: 1 E: 0 LOB: 1 K: 0 BB: 0 S: 4 P: 4	R: 2 H: 1 E: 0 LOB: 1 K: 1 BB: 2 S: 6 P: 14	1B: 5 SF: 0 2B: 1 SAC: 2 3B: 0 DP: 1 HR: 0 HBP: 0	WP: 0 PA: 42 PB: 0 SB: 0 CS: 0														
<b>PITCHER</b> Curt Simmons, L ERA: 2.91 (1, 1)	IP WLS BF H R ER SO BB IBB HBP BLK WP HR S P ERA WHIP																										



BOTTOM

New York Giants @ Philadelphia Phillies  
Connie Mack Stadium, Philadelphia, PA  
Tue Sep 07 1954, 3:33 AM EDT  
Att. 13,535 - Unknown

livebaseballscores.com

AB 41  
R 1  
H 12  
RBI 1  
BB 6  
SO 5  
LOB 26



WP: 0 PA: 48  
PB: 0  
SB: 0  
CS: 0

AB R H RBI BB SO LOB

4 0 2 0 2 1 2

5 0 2 0 1 0 3

5 0 2 0 0 0 4  
0 0 0 0 0 0 0  
1 0 0 0 0 0 3

4 1 3 1 1 0 1

4 0 0 0 0 0 5

3 0 1 0 2 0 2

5 0 1 0 0 0 5

5 0 0 0 0 3 1

4 0 0 0 0 1 0  
1 0 1 0 0 0 0

1B: 11 SF: 0  
2B: 0 SAC: 0  
3B: 0 BB: 0  
HR: 1 HBP: 1

11

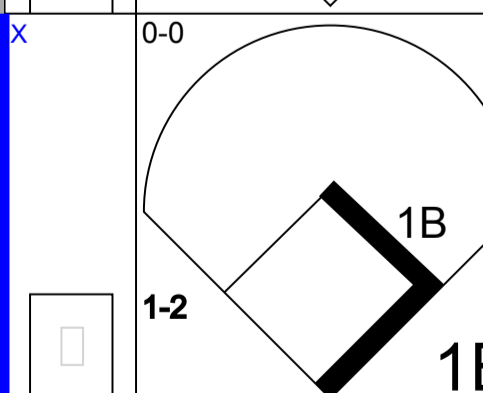
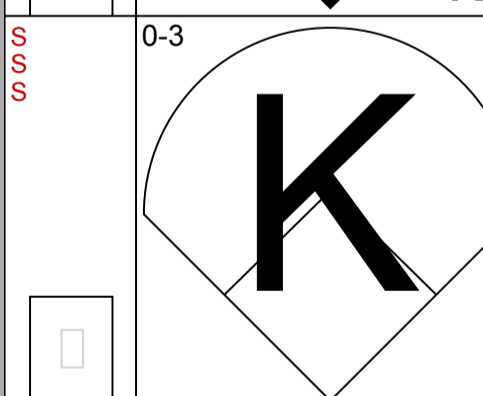
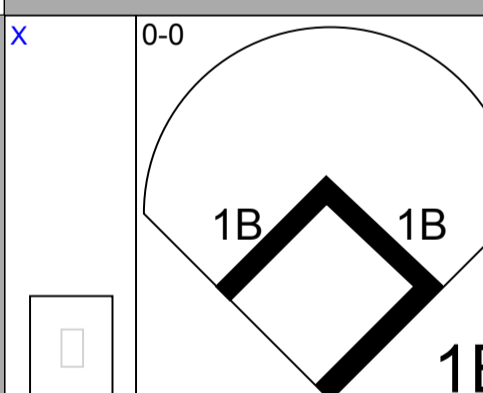
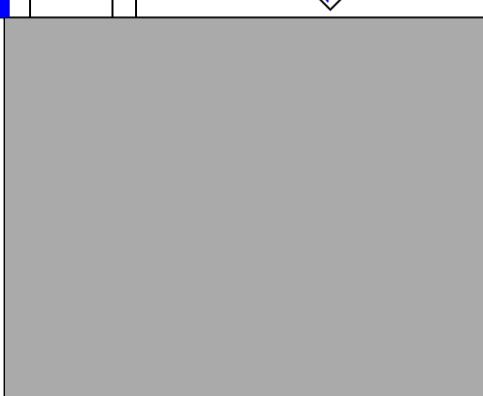
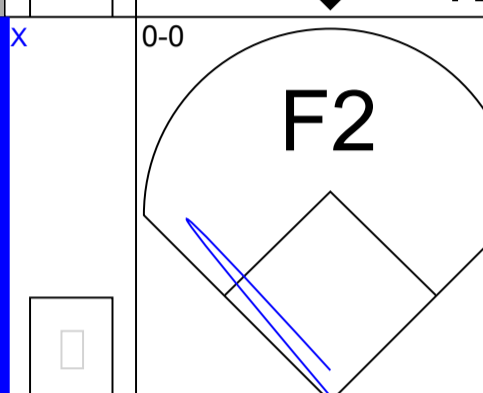
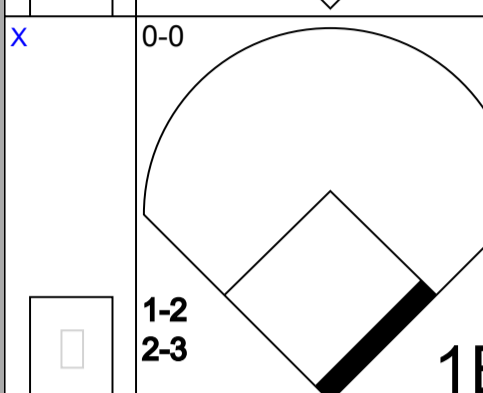
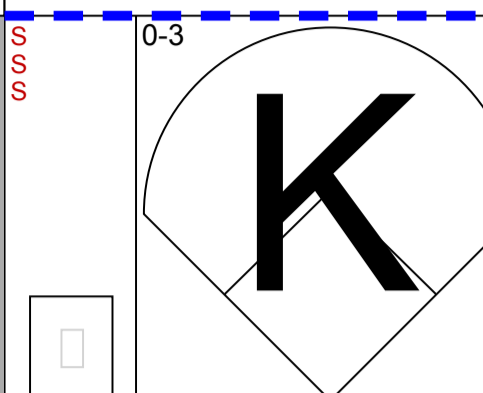

10

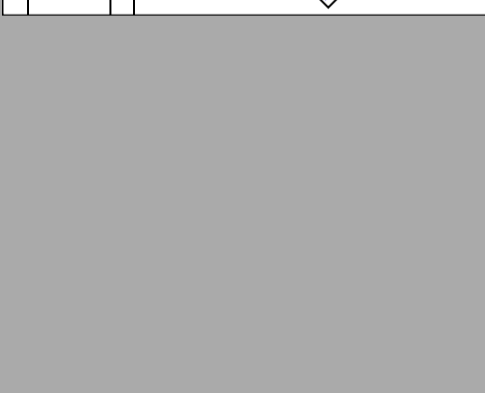
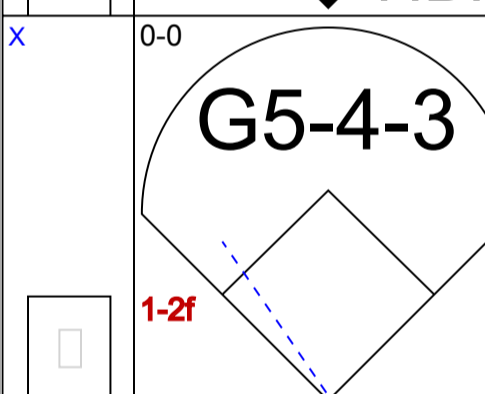
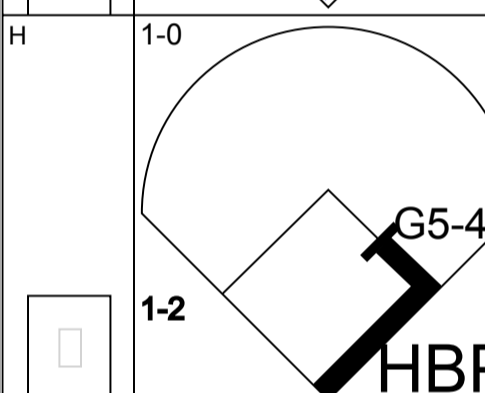
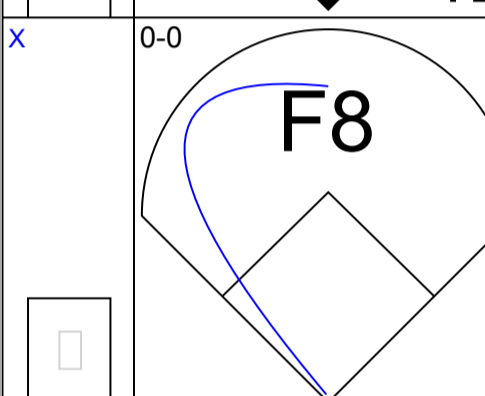
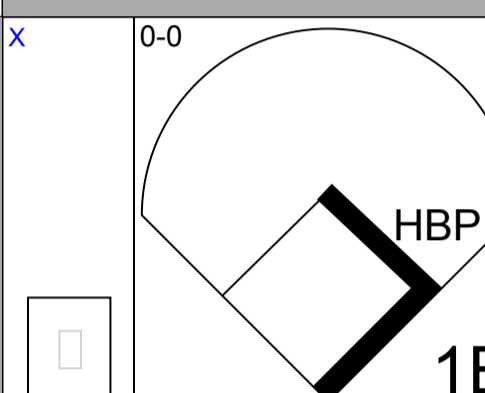
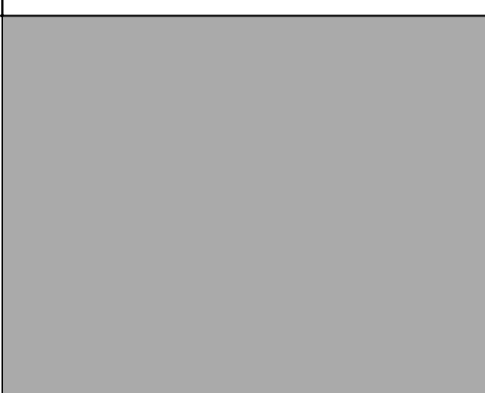

9

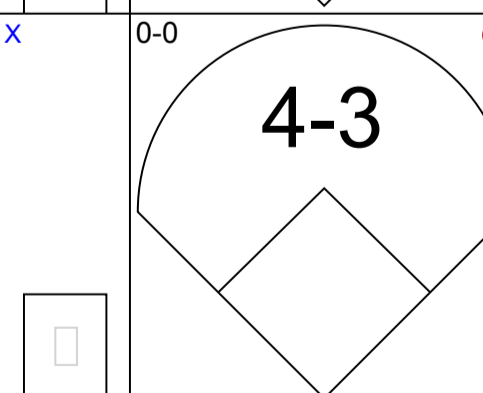
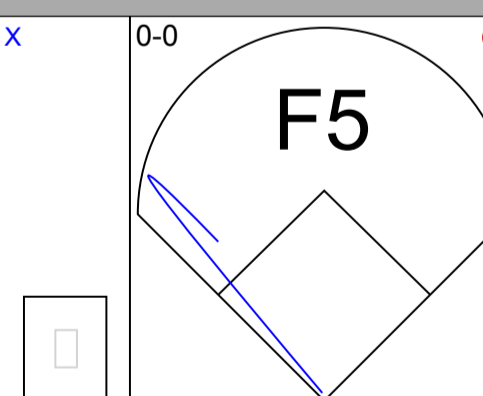
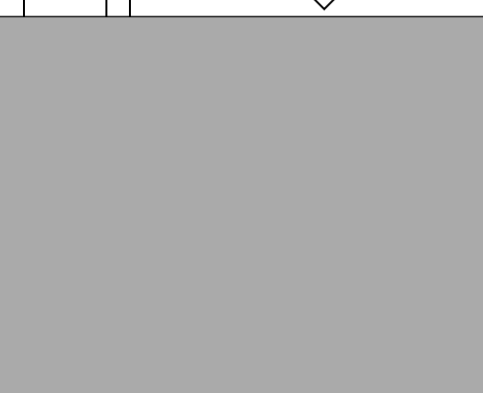
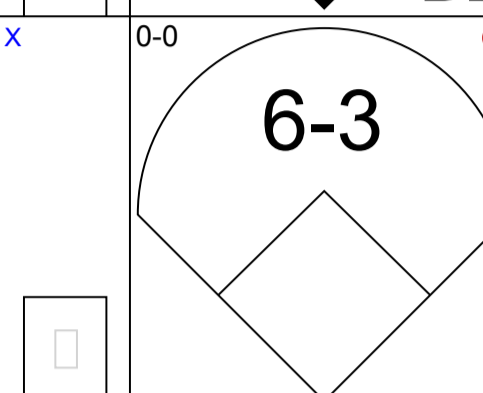
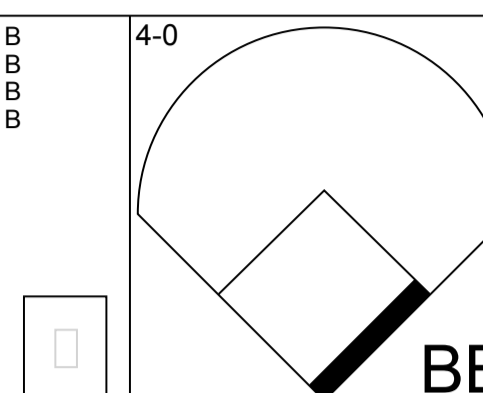

8

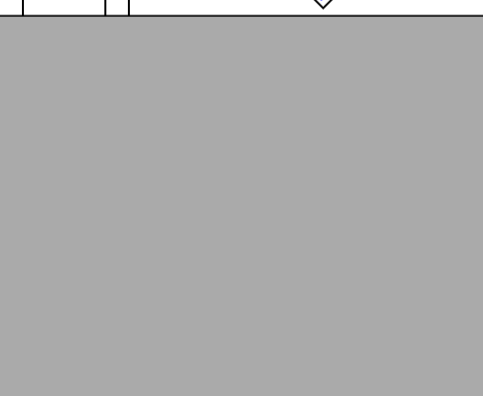
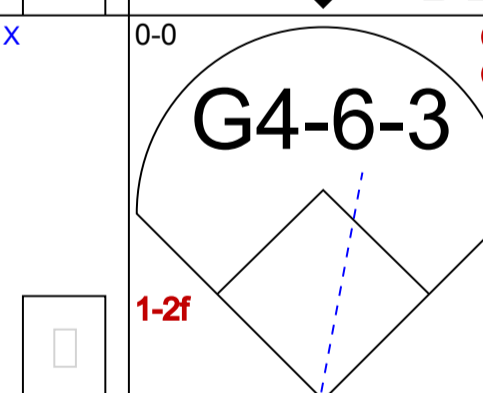
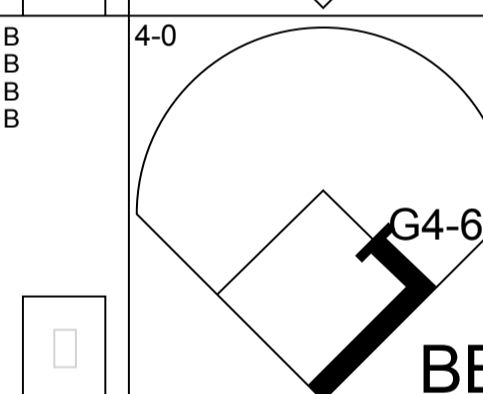
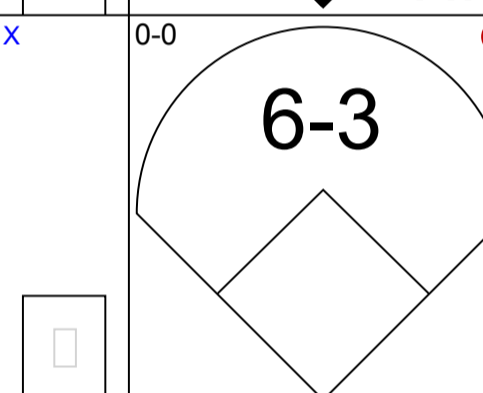
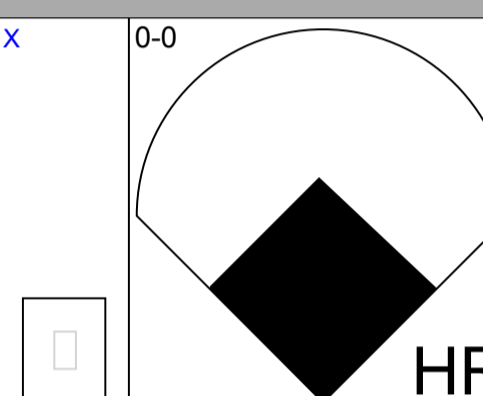
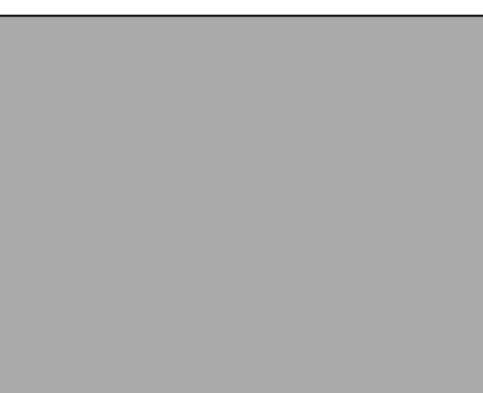

7

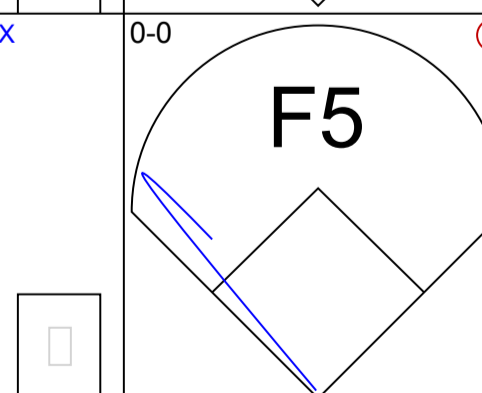
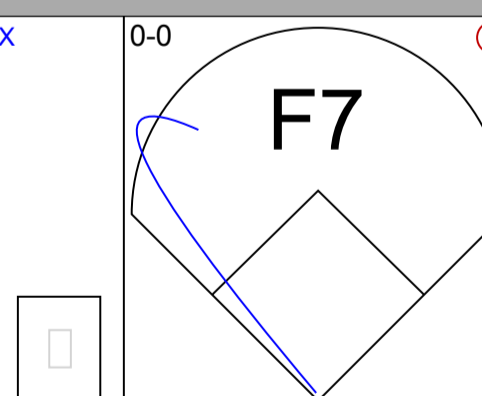
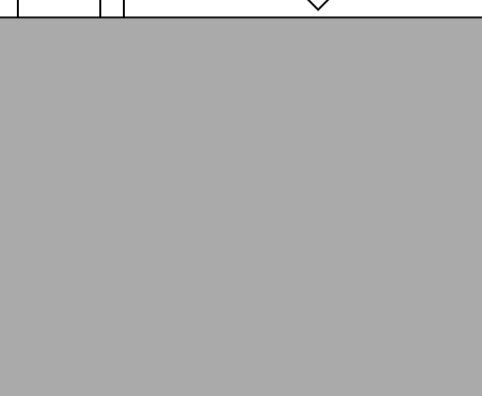
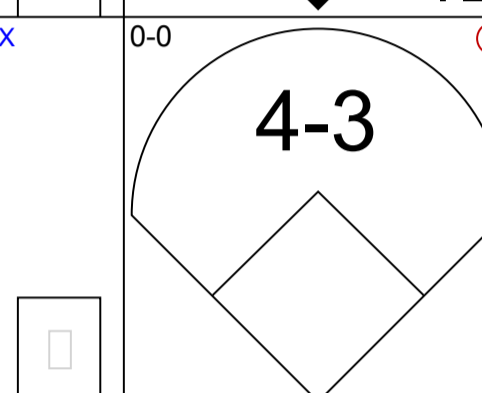
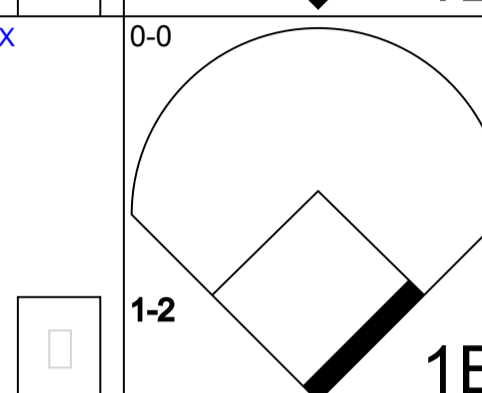
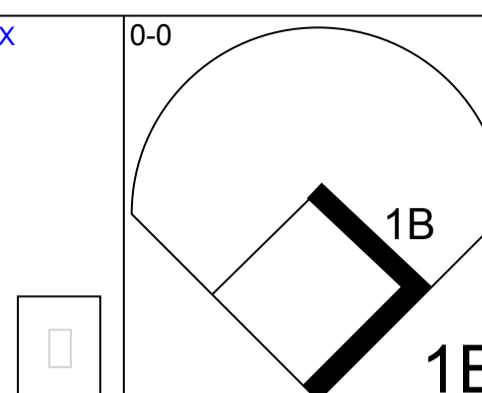

6

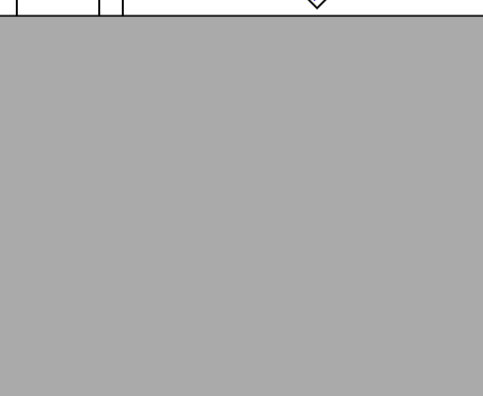
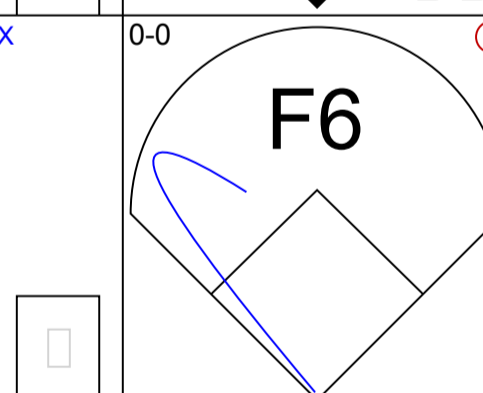
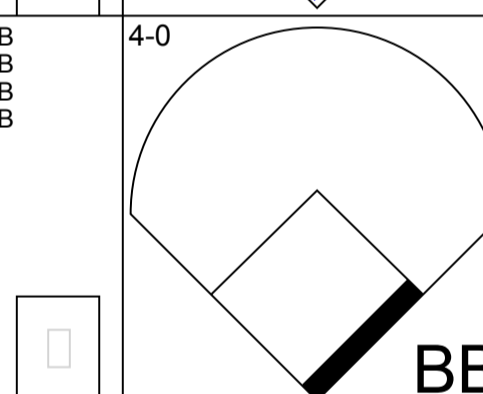
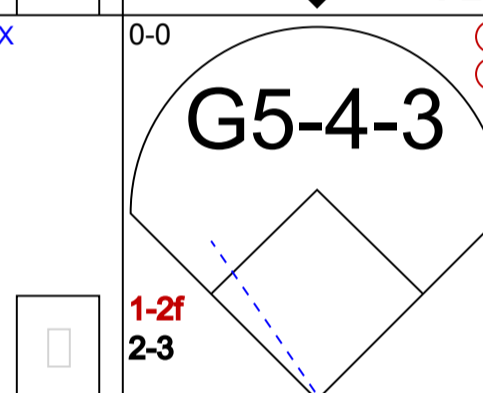
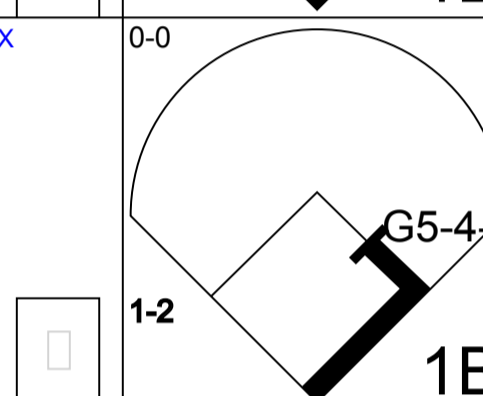
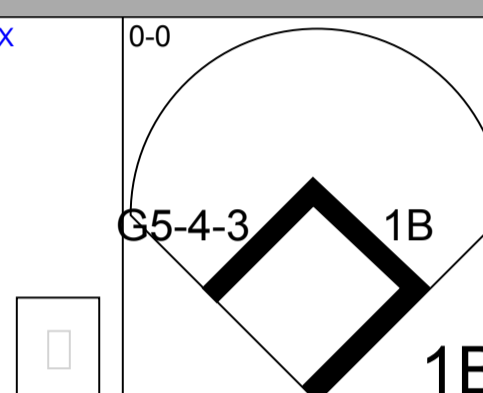
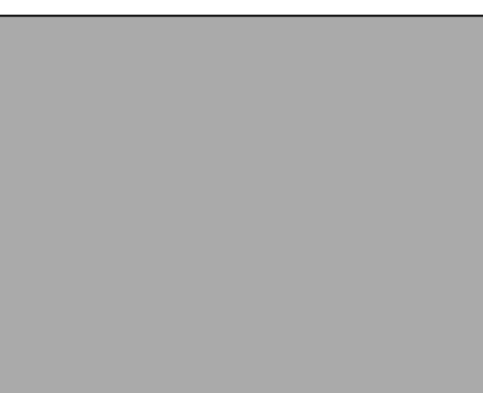

5

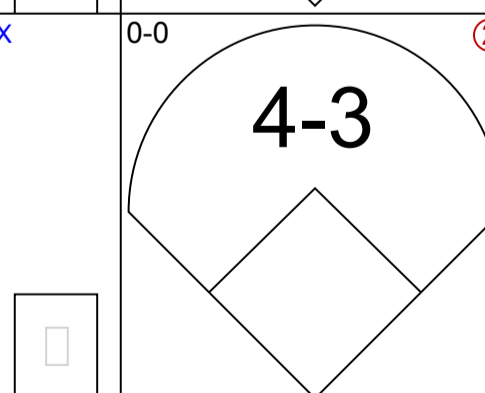
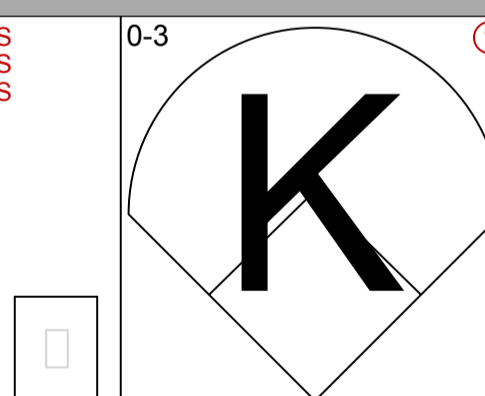
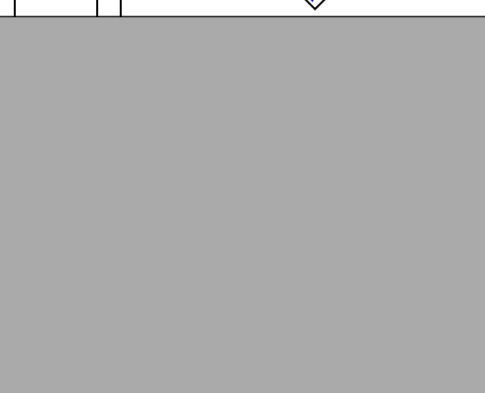
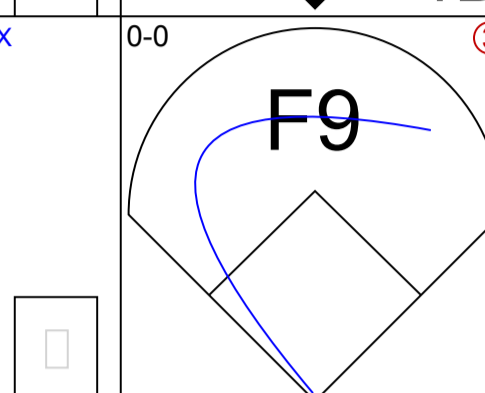
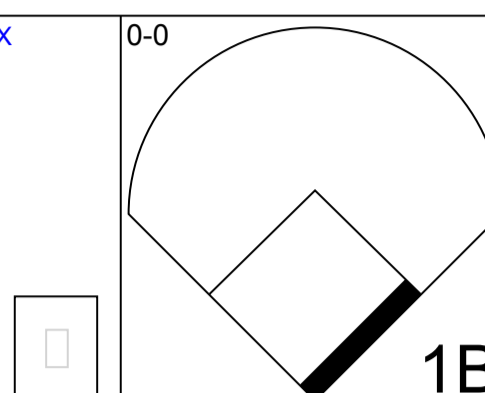

4

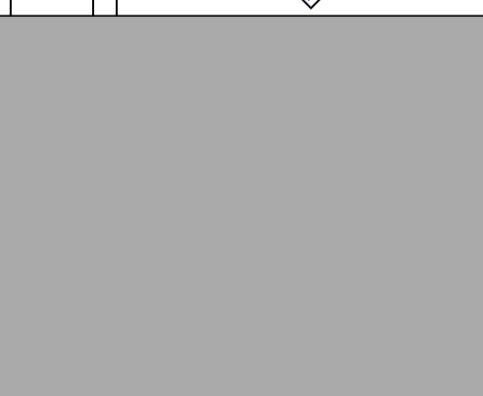
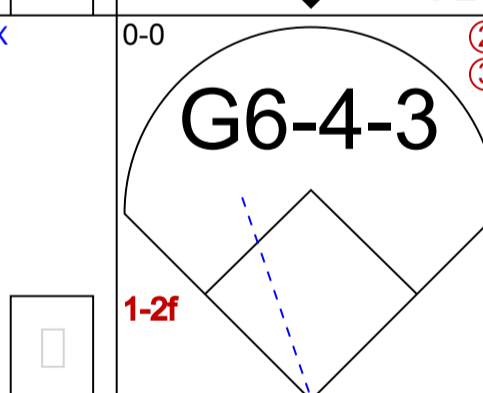
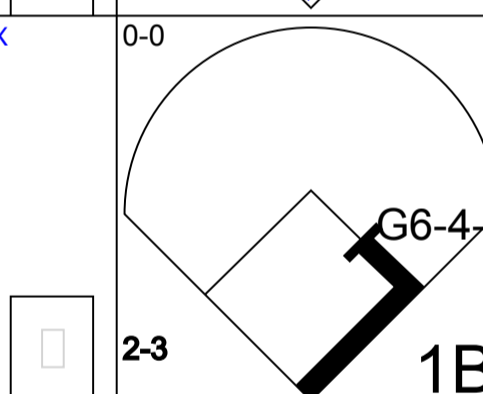
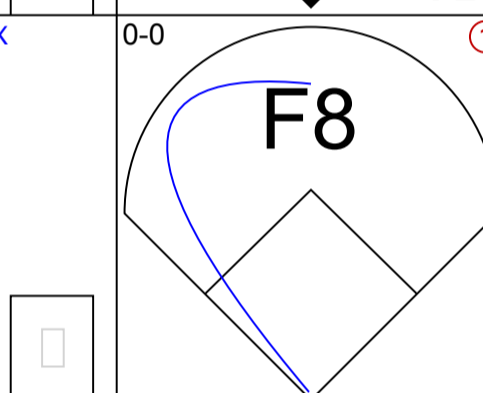
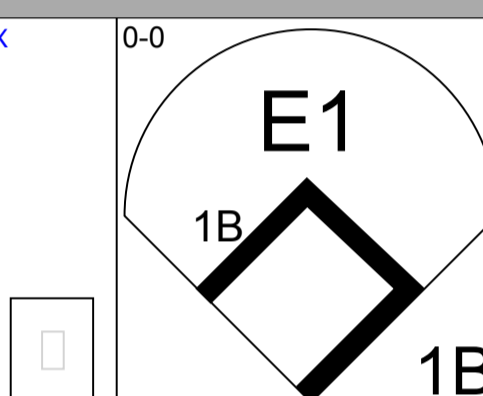
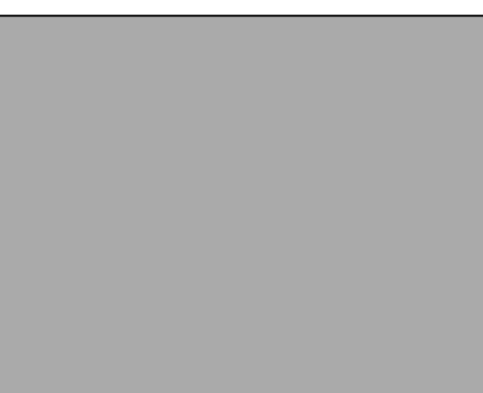

3

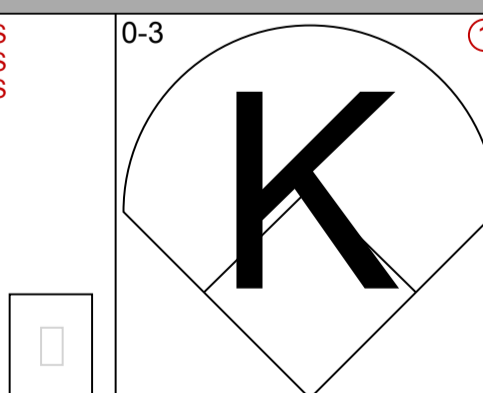
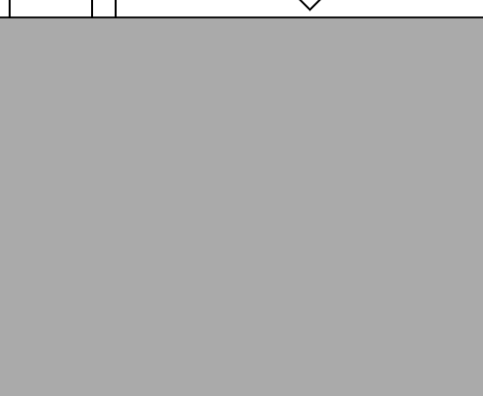
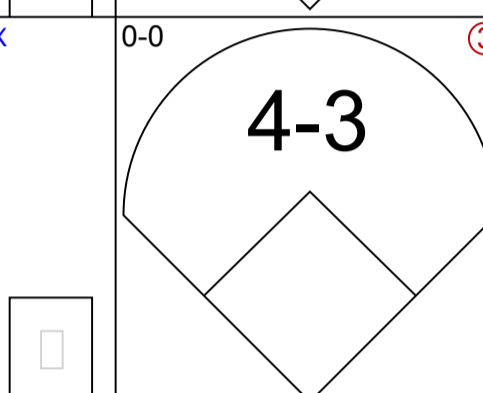
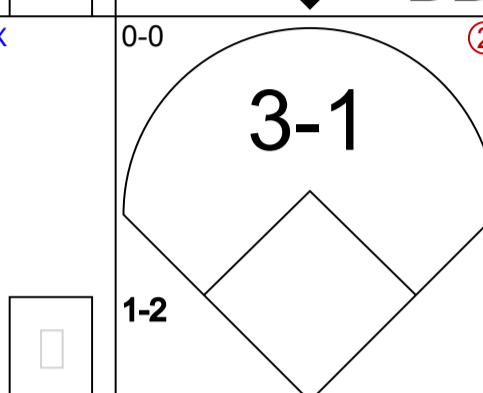
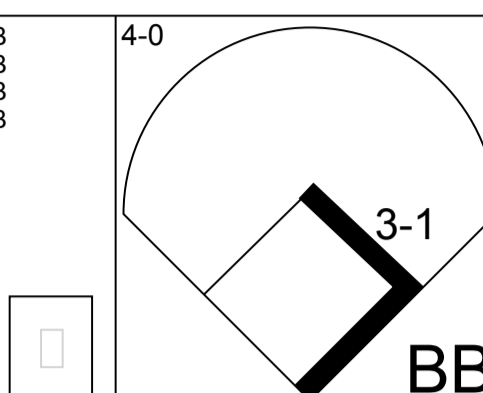

2

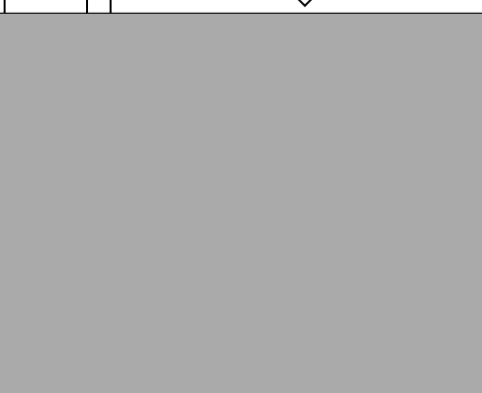
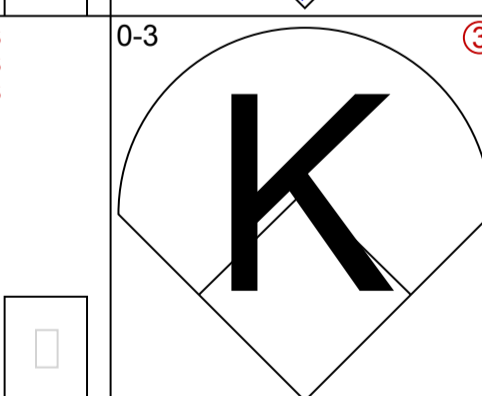
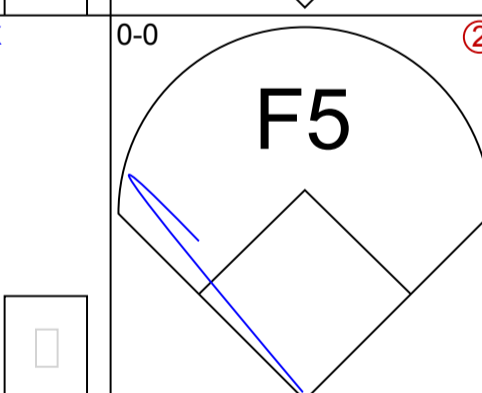
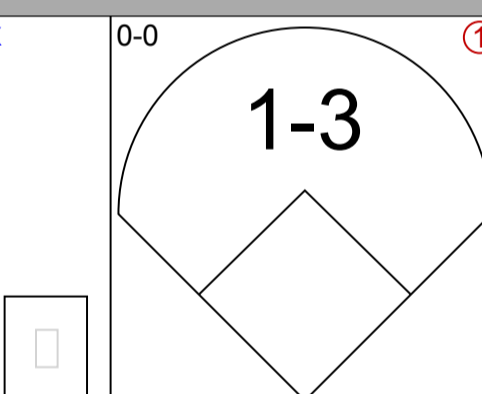
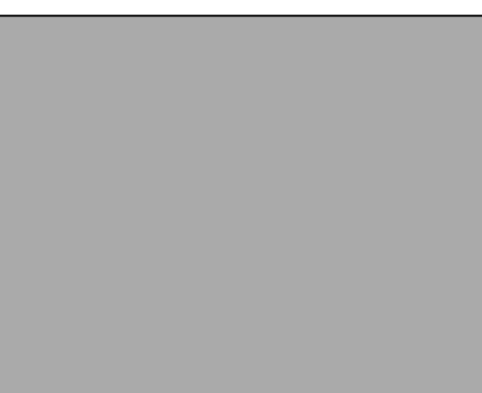

1

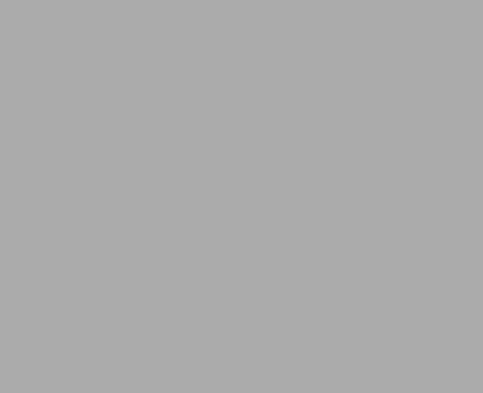
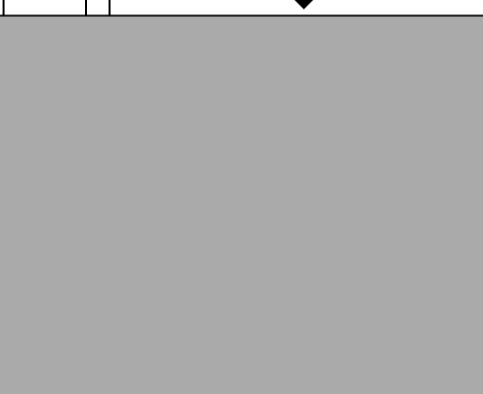
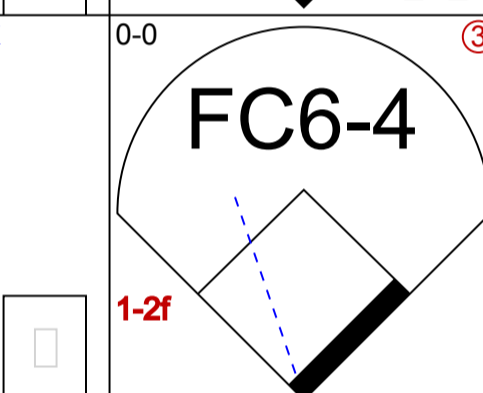
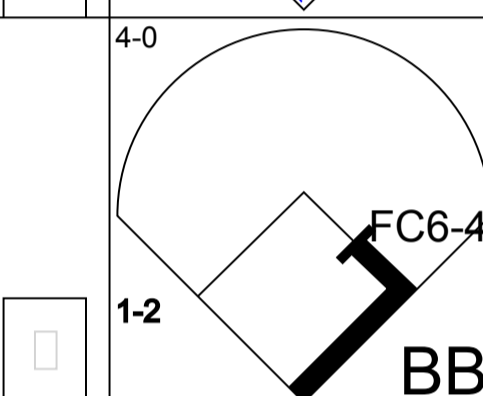
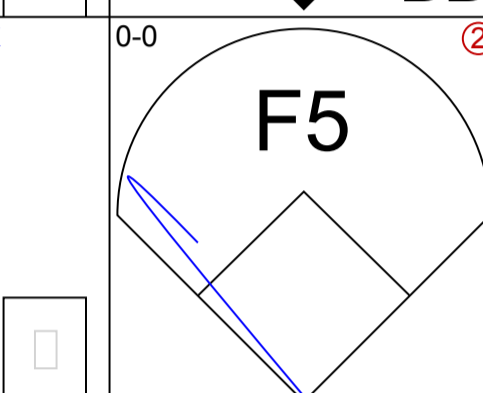
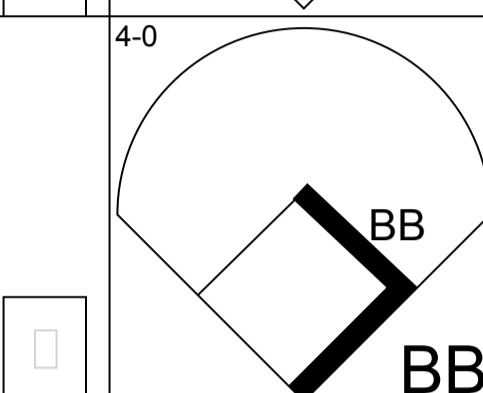
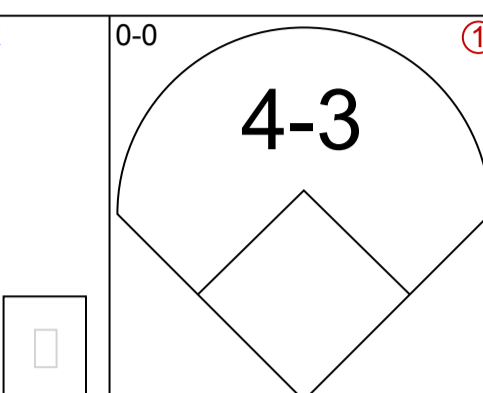

Batter

Richie Ashburn, L (1, 8)

Mel Clark, R (1, 7)

Smoky Burgess, L (1, 2)

Earl Torgeson, L (10, PR)

Stan Lopata, R (11, 2)

Granny Hamner, R (1, 4)

Del Ennis, R (1, 9)

Bobby Morgan, R (1, 6)

Willie Jones, R (1, 5)

Johnny Wyrostek, L (1, 3)

Curt Simmons, L (1, 1)

Floyd Baker, L (11, PH)

Inning Stats

PITCHER

Ruben Gomez, R (1, 1)

Hoyt Wilhelm, R (11, 1)

0-0

4-0

0-0

4-0

0-0

0-0

0-0

0-3

0-3

R: 0 H: 0  
E: 0 LOB: 2  
K: 0 BB: 2  
S: 3 P: 11

IP WLS BF H R ER SO BB IBB HBP BLK WP HR S P ERA WHIP

10.1 W 45 11 1 1 4 6 0 1 0 0 1 46 71 0.87 1.645

0.2 S 3 1 0 0 1 0 0 0 0 0 0 5 5 0.00 1.500

0-0

0-0

0-0

0-0

0-0

0-0

0-0

0-3

0-3

R: 0 H: 0  
E: 0 LOB: 0  
K: 1 BB: 0  
S: 5 P: 5

R: 0 H: 2  
E: 1 LOB: 1  
K: 0 BB: 0  
S: 4 P: 4

R: 0 H: 1  
E: 0 LOB: 1  
K: 1 BB: 0  
S: 6 P: 6

R: 0 H: 2  
E: 0 LOB: 2  
K: 0 BB: 1  
S: 4 P: 8

4-0

0-0

0-0

0-0

0-0

0-0

0-0

0-3

0-3

R: 0 H: 0  
E: 0 LOB: 1  
K: 1 BB: 1  
S: 5 P: 9

R: 0 H: 2  
E: 1 LOB: 1  
K: 0 BB: 0  
S: 4 P: 4

R: 0 H: 1  
E: 0 LOB: 1  
K: 1 BB: 0  
S: 6 P: 6

R: 0 H: 2  
E: 0 LOB: 2  
K: 0 BB: 1  
S: 4 P: 8

0-0

0-0

0-0

0-0

0-0

0-0

0-0

0-3

0-3

R: 0 H: 0  
E: 0 LOB: 1  
K: 1 BB: 1  
S: 5 P: 9

R: 0 H: 2  
E: 1 LOB: 1  
K: 0 BB: 0  
S: 4 P: 4

R: 0 H: 1  
E: 0 LOB: 1  
K: 1 BB: 0  
S: 6 P: 6

R: 0 H: 2  
E: 0 LOB: 2  
K: 0 BB: 1  
S: 4 P: 8

0-0

0-0

0-0

0-0

0-0

0-0

0-0

0-3

0-3

R: 0 H: 0  
E: 0 LOB: 1  
K: 1 BB: 1  
S: 5 P: 9

R: 0 H: 2  
E: 1 LOB: 1  
K: 0 BB: 0  
S: 4 P: 4

R: 0 H: 1  
E: 0 LOB: 1  
K: 1 BB: 0  
S: 6 P: 6

R: 0 H: 2  
E: 0 LOB: 2  
K: 0 BB: 1  
S: 4 P: 8

0-0

0-0

0-0

0-0

0-0

0-0

0-0

0-3

0-3

R: 0 H: 0  
E: 0 LOB: 1  
K: 1 BB: 1  
S: 5 P: 9

R: 0 H: 2  
E: 1 LOB: 1  
K: 0 BB: 0  
S: 4 P: 4

R: 0 H: 1  
E: 0 LOB: 1  
K: 1 BB: 0  
S: 6 P: 6

R: 0 H: 2  
E: 0 LOB: 2  
K: 0 BB: 1  
S: 4 P: 8

0-0

0-0

0-0

0-0

0-0

0-0

0-0

0-3

0-3

R: 0 H: 0  
E: 0 LOB: 1  
K: 1 BB: 1  
S: 5 P: 9

R: 0 H: 2  
E: 1 LOB: 1  
K: 0 BB: 0  
S: 4 P: 4

R: 0 H: 1  
E: 0 LOB: 1  
K: 1 BB: 0  
S: 6 P: 6

R: 0 H: 2  
E: 0 LOB: 2  
K: 0 BB: 1  
S: 4 P: 8

0-0

0-0

0-0

0-0

0-0

0-0

0-0

0-3

0-3

R: 0 H: 0  
E: 0 LOB: 1  
K: 0 BB: 1  
S: 3 P: 7

R: 0 H: 2  
E: 0 LOB: 2  
K: 0 BB: 1  
S: 4 P: 8

R: 0 H: 1  
E: 0 LOB: 0  
K: 0 BB: 1  
S: 3 P: 7

R: 0 H: 2  
E: 0 LOB: 2  
K: 0 BB: 1  
S: 4 P: 8

4-0

0-0

0-0

0-0

0-0

0-0

0-0

0-3

0-3

R: 0 H: 0  
E: 0 LOB: 1  
K: 0 BB: 1  
S: 3 P: 7

R: 0 H: 2  
E: 0 LOB: 2  
K: 0 BB: 1  
S: 4 P: 8

R: 0 H: 1  
E: 0 LOB: 0  
K: 0 BB: 1  
S: 3 P: 7

R: 0 H: 2  
E: 0 LOB: 2  
K: 0 BB: 1  
S: 4 P: 8

0-0

0-0

0-0

0-0

0-0

0-0

0-0

0-3

0-3

R: 0 H: 0  
E: 0 LOB: 1  
K: 0 BB: 1  
S: 3 P: 7

R: 0 H: 2  
E: 0 LOB: 2  
K: 0 BB: 1  
S: 4 P: 8

R: 0 H: 1  
E: 0 LOB: 0  
K: 0 BB: 1  
S: 3 P: 7





Batter	1	2	3	4	5	6	7	8	9	AB R H RBI BB SO LOB	TOP									
Bob Talbot, R OBP: 0.296, SLG: 0.332 (1, 8)	0-3 K		0-0 F8		0-0 4-3			0-0 1B		4 0 1 0 0 1 0										
Gene Baker, R OBP: 0.328, SLG: 0.429 (1, 4)	0-0 6-3		4-0 BB		0-3 K			0-3 K		3 0 0 0 1 2 1										
Randy Jackson, R OBP: 0.337, SLG: 0.462 (1, 5)	0-0 F7		0-3 K				0-0 1-3	0-3 K		4 0 0 0 0 2 2										
Hank Sauer, R OBP: 0.377, SLG: 0.565 (1, 9)		0-0 6-3		0-0 F4		0-0 F8		0-0 F8		4 0 0 0 0 0 0										
14 Ernie Banks, R OBP: 0.331, SLG: 0.438 (1, 6)		0-0 1B		0-0 S 1B 1B		0-0 F8		0-0 E5 BB 1B		4 2 2 0 0 0 0										
Ralph Kiner, R OBP: 0.375, SLG: 0.495 (1, 7)		0-3 K		0-3 K 1-2		0-0 1-3		0-0 F3		4 0 0 0 0 2 3										
Steve Bilko, R OBP: 0.289, SLG: 0.347 Dee Fondy, L OBP: 0.327, SLG: 0.403 (9, PH) (9, 3)		0-0 F2		0-0 1B 2-H		0-3 K		4-0 1B BB 1-2		3 0 1 1 0 1 1 0 0 0 0 1 0 0										
Clyde McCullough, R OBP: 0.305, SLG: 0.474 (1, 2)			0-0 HR	0-0 F2		0-0 F6		0-0 1-3 2-H 1B		4 1 2 2 0 0 1										
Bob Rush, R OBP: 0.324, SLG: 0.451 Jim Davis, S OBP: 0.229, SLG: 0.036 Hal Jeffcoat, R OBP: 0.300, SLG: 0.556 (1, 1) (8, 1) (8, 1)			0-0 1-3		0-3 K			0-3 K		3 0 0 0 0 2 0 0 0 0 0 0 0 0 0 0 0 0 0 0 0										
<b>Inning Stats</b>	R: 0 E: 0 K: 1 S: 5	H: 0 LOB: 0 BB: 0 P: 5	R: 0 E: 0 K: 1 S: 6	H: 1 LOB: 1 BB: 0 P: 6	R: 1 E: 0 K: 1 S: 6	H: 1 LOB: 1 BB: 1 P: 10	R: 1 E: 0 K: 1 S: 7	H: 2 LOB: 1 BB: 0 P: 7	R: 0 E: 0 K: 2 S: 7	H: 0 LOB: 0 BB: 0 P: 7	R: 0 E: 0 K: 1 S: 5	H: 0 LOB: 0 BB: 0 P: 5	R: 0 E: 0 K: 3 S: 10	H: 1 LOB: 1 BB: 0 P: 10	R: 1 E: 1 K: 0 S: 4	H: 1 LOB: 2 BB: 1 P: 8	1B: 5 2B: 0 3B: 0 HR: 1	SF: 0 SAC: 0 DP: 0 HBP: 0	WP: 0 PB: 0 SB: 1 CS: 0	PA: 35
<b>PITCHER</b>	IP WLS BF H R ER SO BB IBB HBP BLK WP HR S P ERA WHIP																			
Johnny Antonelli, L ERA: 2.31 Marv Grissom, R ERA: 2.48 (1, 1) (9, 1)	8.0 L 30 5 2 2 10 1 0 0 0 0 1 49 53 2.25 0.750																			

Chicago Cubs @ New York Giants  
Polo Grounds, New York, NY  
Thu Sep 09 1954, 3:38 AM EDT  
Att. 14,580 - Unknown

livebaseballscorecards.com

AB	33
R	3
H	6
RBI	3
BB	2
SO	10
LOB	8



BOTTOM

Chicago Cubs @ New York Giants  
Polo Grounds, New York, NY  
Thu Sep 09 1954, 3:38 AM EDT  
Att. 14,580 - Unknown

livebaseballscores.com

AB	33
R	0
H	5
RBI	0
BB	2
SO	6
LOB	14



WP	0	PA	35
PB	0		
SB	2		
CS	0		

AB R H RBI BB SO LOB

4 0 1 0 0 1 0

4 0 0 0 0 0 2

2 0 0 0 1 1 0

0 0 0 0 1 0 0

0 0 0 0 0 0 0

0 0 0 0 0 0 0

4 0 1 0 0 0 4

4 0 0 0 0 0 1

4 0 1 0 0 1 1

4 0 1 0 0 1 2

2 0 0 0 0 1 1

1 0 1 0 0 0 0

0 0 0 0 0 0 0

1 0 0 0 0 0 1

2 0 0 0 0 1 1

1 0 0 0 0 0 1

1B: 5 SF: 0

2B: 0 SAC: 0

3B: 0 DP: 0

HR: 0 HBP: 0

Batter	1	2	3	4	5	6	7	8	9
Whitey Lockman, L (1, 3) OBP: 0.322, SLG: 0.382	0-3 K		0-0 F4			0-0 F4		0-0 BB FC3-2 1B	
Alvin Dark, R (1, 6) OBP: 0.330, SLG: 0.459	0-0 F8			0-0 6-3		0-0 F4		0-0 FC3-2 BB	
Hank Thompson, L (1, 5) OBP: 0.368, SLG: 0.494	4-0			0-3 K		0-0 3-1		4-0 BB	
Bobby Hofman, R (8, PH) OBP: 0.298, SLG: 0.440								1-2 BB	
Al Corwin, R (8, PR)								1-2 2-3 BB	
Mary Grissom, R (9, 1) OBP: 0.172, SLG: 0.111	BB								
Willie Mays, R (1, 8) OBP: 0.405, SLG: 0.675	0-0 1-3			0-0 S 1B		0-0 6-3		0-0 4-3	
Monte Irvin, R (1, 7) OBP: 0.371, SLG: 0.454		0-0 F7		0-0 F2		0-0 E5 S		0-0 5-3	
Don Mueller, L (1, 9) OBP: 0.354, SLG: 0.431		0-3 K			0-0 FC3-6 1B	0-0 F3		0-0 F7	
Joe Garagiola, L (1, 2) OBP: 0.400, SLG: 0.408		0-3 K			0-0 FC3-6 1B	0-0 3-1		0-0 1B	
Davey Williams, R (1, 4) OBP: 0.286, SLG: 0.322			0-3 K		0-0 FC3-6	0-0 FC3-6		0-0 FC1-6 1B	
Bill Taylor, L (8, PH) OBP: 0.258, SLG: 0.317					1-2	1-2		0-0 F5	
Billy Gardner, R (8, PR) OBP: 0.266, SLG: 0.295									
Bob Lennon, L (9, PH)									
Johnny Antonelli, L (1, 1) OBP: 0.163, SLG: 0.202			0-0 4-3		0-3 K			0-0 FC1-6 1B FC3-2	
Dusty Rhodes, L (8, PH) OBP: 0.436, SLG: 0.784									

Inning Stats	R: 0	H: 0	E: 0	K: 1	S: 5	R: 0	H: 0	E: 0	K: 2	S: 7	R: 0	H: 0	E: 0	K: 1	S: 5	R: 0	H: 1	E: 0	K: 1	S: 6	R: 0	H: 1	E: 1	K: 1	S: 6	R: 0	H: 0	E: 0	K: 0	S: 3	R: 0	H: 0	E: 1	K: 0	S: 4	R: 0	H: 2	E: 0	K: 0	S: 5	R: 0	H: 1	E: 0	K: 0	S: 4		
	LOB: 1	BB: 1	P: 9	LOB: 0	BB: 0	P: 7	LOB: 0	BB: 0	P: 5	LOB: 1	BB: 0	P: 6	LOB: 1	BB: 0	P: 6	LOB: 0	BB: 0	P: 3	LOB: 1	BB: 0	P: 4	LOB: 3	BB: 1	P: 9	LOB: 1	BB: 0	P: 4	LOB: 0	BB: 0	P: 4	LOB: 0	BB: 0	P: 4	LOB: 0	BB: 1	P: 9	LOB: 1	BB: 0	P: 4	1B: 5	SF: 0	2B: 0	SAC: 0	3B: 0	DP: 0	HR: 0	HBP: 0

PITCHER	IP	WLS	BF	H	R	ER	SO	BB	IBB	HBP	BLK	WP	HR	S	P	ERA	WHIP
Bob Rush, R (1, 1) ERA: 3.97	7.1	W	28	4	0	0	6	1	0	0	0	0	0	39	43	0.00	0.682
Jim Davis, L (8, 1) ERA: 3.52	0.1		2	0	0	0	0	1	0	0	0	0	0	1	5	0.00	3.000
Hal Jeffcoat, R (8, 1) ERA: 5.07	1.1	S	5	1	0	0	0	0	0	0	0	0	0	5	5	0.00	0.750

PITCHER

IP	WLS	BF	H	R	ER	SO	BB	IBB	HBP	BLK	WP	HR	S	P	ERA	WHIP
Bob Rush, R (1, 1) ERA: 3.97	7.1	W	28	4	0	0	6	1	0	0	0	0	39	43	0.00	0.682
Jim Davis, L (8, 1) ERA: 3.52	0.1		2	0	0	0	0	1	0	0	0	0	1	5	0.00	3.000
Hal Jeffcoat, R (8, 1) ERA: 5.07	1.1	S	5	1	0	0	0	0	0	0	0	0	5	5	0.00	0.750





Batter	1	2	3	4	5	6	7	8	9	AB R H RBI BB SO LOB	TOP	
<b>Chuck Harmon, R</b> (1, 5) <small>OBP: 0.280, SLG: 0.314</small> <b>Rocky Bridges, R</b> (7, 5) <small>OBP: 0.322, SLG: 0.250</small> <b>Andy Seminick, R</b> (9, PH) <small>OBP: 0.372, SLG: 0.402</small> <b>Dick Murphy, L</b> (9, PR)	 <small>0-3</small>	 <small>0-0</small>			 <small>0-0</small>		 <small>0-0</small>		 <small>0-0</small>	3 1 1 1 0 1 0 0 0 0 0 0 0 0 1 0 1 0 0 0 0 0 0 0 0 0 0 0		
<b>Roy McMillan, R</b> (1, 6) <small>OBP: 0.300, SLG: 0.312</small>	 <small>0-0</small>		 <small>0-0</small>		 <small>0-0</small>		 <small>0-0</small>		 <small>0-3</small>	5 0 0 0 0 1 3		
<b>Gus Bell, L</b> (1, 8) <small>OBP: 0.343, SLG: 0.467</small>	 <small>4-0</small>		 <small>0-0</small>		 <small>0-0</small>			 <small>4-0</small>		2 0 0 0 2 0 1		
<b>Ted Kluszewski, L</b> (1, 3) <small>OBP: 0.401, SLG: 0.654</small>	 <small>0-0</small>		 <small>0-0</small>			 <small>0-0</small>		 <small>0-0</small>		4 1 1 1 0 0 2		
<b>Jim Greengrass, R</b> (1, 7) <small>OBP: 0.330, SLG: 0.502</small>		 <small>0-0</small>		 <small>0-3</small>		 <small>0-0</small>		 <small>0-3</small>		4 0 0 0 0 2 1		
<b>Lloyd Merriman, L</b> (1, 9) <small>OBP: 0.404, SLG: 0.341</small> <b>Wally Post, R</b> (7, 9) <small>OBP: 0.283, SLG: 0.415</small>		 <small>0-0</small>		 <small>0-0</small>		 <small>0-0</small>		 <small>0-0</small>		3 0 0 0 0 0 0 1 0 0 0 0 0 1		
<b>Johnny Temple, R</b> (1, 4) <small>OBP: 0.384, SLG: 0.364</small>		 <small>0-0</small>		 <small>4-0</small>		 <small>0-0</small>		 <small>0-0</small>		3 1 1 0 1 0 0		
<b>Hobie Landrith, L</b> (1, 2) <small>OBP: 0.330, SLG: 0.388</small> <b>Bobby Adams, R</b> (9, PH) <small>OBP: 0.360, SLG: 0.370</small>		 <small>0-0</small>		 <small>0-0</small>		 <small>0-0</small>		 <small>0-0</small>		3 1 1 0 0 0 1 1 0 1 0 0 0 0		
<b>Jackie Collum, L</b> (1, 1) <small>OBP: 0.286, SLG: 0.538</small> <b>Howie Judson, R</b> (7, 1) <small>OBP: 0.120, SLG: 0.083</small> <b>Cliff Ross, L</b> (8, 1) <b>Bob Borkowski, R</b> (9, PH) <small>OBP: 0.324, SLG: 0.417</small>		 <small>0-0</small>		 <small>0-0</small>		 <small>0-0</small>		 <small>0-0</small>		3 1 2 3 0 0 0 0 0 0 0 0 0 0 0 0 0 0 0 0 0 1 0 0 0 0 0 1		
<b>Inning Stats</b>	R: 0 H: 0 E: 0 LOB: 1 K: 1 BB: 1 S: 5 P: 9	R: 3 H: 3 E: 0 LOB: 0 K: 0 BB: 0 S: 6 P: 6	R: 0 H: 0 E: 0 LOB: 0 K: 0 BB: 0 S: 3 P: 3	R: 0 H: 0 E: 0 LOB: 1 K: 1 BB: 1 S: 5 P: 9	R: 0 H: 1 E: 0 LOB: 1 K: 0 BB: 0 S: 4 P: 4	R: 1 H: 1 E: 0 LOB: 0 K: 0 BB: 0 S: 4 P: 4	R: 1 H: 1 E: 0 LOB: 0 K: 0 BB: 0 S: 4 P: 4	R: 0 H: 0 E: 0 LOB: 1 K: 1 BB: 1 S: 5 P: 9	R: 0 H: 2 E: 0 LOB: 2 K: 1 BB: 0 S: 7 P: 7	1B: 5 SF: 0 2B: 0 SAC: 1 3B: 0 DP: 0 HR: 3 HBP: 0	WP: 0 PA: 38 PB: 0 SB: 0 CS: 0	
<b>PITCHER</b> <b>Ruben Gomez, R</b> (1, 1) <small>ERA: 3.08</small> <b>Johnny Antonelli, L</b> (8, 1) <small>ERA: 2.29</small>	IP WLS BF H R ER SO BB IBB HBP BLK WP HR S P ERA WHIP											<b>PITCHER</b> IP WLS BF H R ER SO BB IBB HBP BLK WP HR S P ERA WHIP

**Cincinnati Redlegs @ New York Giants**  
 Polo Grounds, New York, NY  
 Sat Sep 11 1954, 3:33 AM EDT  
 Att. 3,171 - Unknown

[livebaseballscorecards.com](http://livebaseballscorecards.com)

<b>AB</b>	<b>34</b>
<b>R</b>	<b>5</b>
<b>H</b>	<b>8</b>
<b>RBI</b>	<b>5</b>
<b>BB</b>	<b>3</b>
<b>SO</b>	<b>4</b>
<b>LOB</b>	<b>10</b>





Batter	1	2	3	4	5	6	7	8	9	AB	R	H	RBI	BB	SO	LOB
Davey Williams, R OBP: 0.285, SLG: 0.317 (1, 4)	4-0 SH2-4 BB BB	0-0 6-3		0-0 F7		0-0 4-3		0-0 SH3		3	0	0	0	1	0	2
Alvin Dark, R OBP: 0.333, SLG: 0.461 (1, 6)	4-0 SH2-4 BB 1-2		0-0 L5-4 BB 1B		0-0 FC6-4 1B SF9 1B		0-0 2B HR 1B	0-0 E6 FC4-6		4	2	3	0	1	0	1
Bobby Hofman, R OBP: 0.310, SLG: 0.446 Dusty Rhodes, L OBP: 0.428, SLG: 0.768 (1, 3) (7, PH) (8, 7)	0-0 SH2-4 1-2 2-3		4-0 1B BB 1-2		0-0 FC6-4 1B 1-2		0-0 F6 1-2 2-3	0-0 FC4-6 1-2 2-3		1	0	1	0	1	0	0
Willie Mays, R OBP: 0.405, SLG: 0.672 (1, 8)	4-0 G5-4-3 IBB		0-0 L5-4 2-3		0-0 FC6-4 SF9 WP 1-2 2-3		0-0 HR 2B 1-3	0-0 F7		4	2	1	0	1	0	6
Monte Irvin, R OBP: 0.372, SLG: 0.453 Hank Thompson, L OBP: 0.387, SLG: 0.493 Wes Westrum, R OBP: 0.320, SLG: 0.317 (1, 7) (7, PH) (8, 2)	0-0 G5-4-3 1-2		0-0 1B 1-2		4-0 WP BB 1-2		0-0 F6			2	0	1	0	1	0	3
Don Mueller, L OBP: 0.354, SLG: 0.430 (1, 9)		0-0 2B 6-3 1B		0-0 4-1		0-0 SF9 2-3 3-H		4-0 HR BB		2	2	1	1	1	0	2
Ray Katt, R OBP: 0.332, SLG: 0.453 Whitey Lockman, L OBP: 0.321, SLG: 0.386 (1, 2) (7, PH) (8, 3)		0-0 F8		0-0 2B		0-3 K 1-2 3-H		0-0 HR 1-H 2-H 3-H		3	0	1	0	0	1	2
Billy Gardner, R OBP: 0.267, SLG: 0.305 (1, 5)		0-0 6-3 1-3 2B		0-3 K		0-3 K		0-3 K		4	0	1	0	0	3	1
Ruben Gomez, R OBP: 0.184, SLG: 0.227 Johnny Antonelli, L OBP: 0.172, SLG: 0.202 (1, 1) (8, 1)		0-0 6-3 2-3 3-H		0-0 5-3		0-0 F6		4-0 FC4-6 SH3 BB		3	0	0	1	0	0	2

Inning Stats	R: 0	H: 0	E: 0	K: 0	S: 2	R: 1	H: 2	E: 0	K: 0	S: 5	R: 0	H: 2	E: 0	K: 0	S: 4	R: 0	H: 1	E: 0	K: 1	S: 6	R: 2	H: 2	E: 0	K: 1	S: 7	R: 0	H: 0	E: 0	K: 1	S: 5	R: 4	H: 3	E: 0	K: 1	S: 8	R: 0	H: 0	E: 1	K: 0	S: 4	1B: 6	2B: 4	3B: 0	HR: 1	SF: 1	SAC: 2	DP: 2	HBP: 0	WP: 1	PA: 40
--------------	------	------	------	------	------	------	------	------	------	------	------	------	------	------	------	------	------	------	------	------	------	------	------	------	------	------	------	------	------	------	------	------	------	------	------	------	------	------	------	------	-------	-------	-------	-------	-------	--------	-------	--------	-------	--------

PITCHER	IP	WLS	BF	H	R	ER	SO	BB	IBB	HBP	BLK	WP	HR	S	P	ERA	WHIP
Jackie Collum, L ERA: 3.96 (1, 1)	6.0		29	8	4	4	3	4	1	0	0	1	0	30	50	6.00	2.000
Howie Judson, R ERA: 3.67 (7, 1)	1.1	L	9	2	3	3	1	2	0	0	0	0	1	9	17	20.25	3.000
Cliff Ross, L ERA: (8, 1)	0.2		2	0	0	0	0	0	0	0	0	0	0	2	2	0.00	0.000

**BOTTOM**

**Cincinnati Redlegs @ New York Giants**  
Polo Grounds, New York, NY

Sat Sep 11 1954, 3:33 AM EDT  
Att. 3,171 - Unknown

AB	30
R	7
H	10
RBI	6
BB	7
SO	4
LOB	24



PITCHER	IP	WLS	BF	H	R	ER	SO	BB	IBB	HBP	BLK	WP	HR	S	P	ERA	WHIP
---------	----	-----	----	---	---	----	----	----	-----	-----	-----	----	----	---	---	-----	------



BOTTOM

St. Louis Cardinals @ New York Giants  
Polo Grounds, New York, NY  
Sun Sep 12 1954, 3:33 AM EDT  
Att. 19,491 - Unknown

livebaseballscorecards.com

AB 33  
R 3  
H 7  
RBI 3  
BB 5  
SO 8  
LOB 17



WP: 1 PA: 39  
PB: 1  
SB: 0  
CS: 0

AB R H RBI BB SO LOB

5	0	2	0	0	0	2
3	1	1	0	2	1	2
4	1	1	2	0	1	2
1	0	0	0	0	0	1
3	1	0	0	1	1	1
2	0	1	0	2	0	0
3	0	0	0	0	1	2
1	0	0	0	0	1	2
4	0	1	1	0	0	2
0	0	0	0	0	0	0
0	0	0	0	0	0	0
0	0	0	0	0	0	0
0	0	0	0	0	0	0
1	0	0	0	0	0	0
1	0	0	0	0	0	0

Batter	1	2	3	4	5	6	7	8	9
Davey Williams, R (1, 4) OBP: 0.286, SLG: 0.318	0-0 F8		0-0 5-3		0-0 G6-4-3		0-0 1B		0-0 1B
Alvin Dark, R (1, 6) OBP: 0.335, SLG: 0.461	4-0 FC5-4 BB		0-0 1B			4-0 WP HR BB	0-0 G3		0-3 K
Bobby Hofman, R (1, 3) OBP: 0.308, SLG: 0.467 Hank Thompson, L (9, PH) OBP: 0.386, SLG: 0.492	0-0 FC5-4		0-3 K			0-0 HR		0-0 F7	0-0 4-3
Willie Mays, R (1, 8) OBP: 0.404, SLG: 0.668	0-3 K			0-0 F4		0-0 F7		4-0 BB 1B BB	
Monte Irvin, R (1, 7) OBP: 0.375, SLG: 0.453		0-0 FC6-5 PB 1B		0-0 F9		4-0 G3 BB		4-0 1B BB	
Don Mueller, L (1, 9) OBP: 0.352, SLG: 0.428 Dusty Rhodes, L (8, PH) OBP: 0.425, SLG: 0.762		0-3 K		0-0 1-3		0-0 G3		0-3 K	
Ray Katt, R (1, 2) OBP: 0.330, SLG: 0.448 Ruben Gomez, R (8, PR) OBP: 0.184, SLG: 0.227 Wes Westrum, R (9, 2) OBP: 0.320, SLG: 0.317		0-0 FC6-5 FC5-4			0-0 F4	0-0 4-3		0-0 1B	
Billy Gardner, R (1, 5) OBP: 0.269, SLG: 0.306 Eric Rodin, R (8, PH) OBP: 0.083, SLG: 0.053		0-0 FC5-4			0-0 HBP 1B			0-3 K	0-3 K
Windy McCall, L (1, 1) Jim Hearn, R (3, 1) George Spengler, R (4, 1) Foster Castleman, R (5, PH) Al Corwin, R (5, PR) Hoyt Wilhelm, R (6, 1) Whitey Lockman, L (9, PH) OBP: 0.320, SLG: 0.385			0-3 K		1-0 G6-4-3 HBP		0-0 4-3		0-0 F5

Inning Stats	R: 0	H: 0	E: 0	K: 1	S: 5	H: 0	LOB: 1	BB: 1	P: 9	R: 0	H: 1	E: 0	K: 1	S: 6	R: 0	H: 1	E: 0	K: 2	S: 8	R: 0	H: 0	E: 0	K: 0	S: 3	R: 0	H: 1	E: 0	K: 0	S: 3	R: 2	H: 1	E: 0	K: 0	S: 4	R: 0	H: 1	E: 0	K: 1	S: 6	R: 1	H: 1	E: 0	K: 2	S: 8	R: 0	H: 1	E: 0	K: 1	S: 6	1B: 6	SF: 0	2B: 0	SAC: 0	3B: 0	DP: 1	HR: 1	HBP: 1	WP: 1	PA: 39
--------------	------	------	------	------	------	------	--------	-------	------	------	------	------	------	------	------	------	------	------	------	------	------	------	------	------	------	------	------	------	------	------	------	------	------	------	------	------	------	------	------	------	------	------	------	------	------	------	------	------	------	-------	-------	-------	--------	-------	-------	-------	--------	-------	--------

PITCHER	IP	WLS	BF	H	R	ER	SO	BB	IBB	HBP	BLK	WP	HR	S	P	ERA	WHIP
Harvey Haddix, L (1, 1) ERA: 3.57	8.0	W	35	6	3	3	7	5	0	1	0	1	1	43	64	3.38	1.375
Al Brazle, L (9, 1) ERA: 4.29	0.1		2	1	0	0	0	0	0	0	0	0	0	2	2	0.00	3.000
Brooks Lawrence, R (9, 1) ERA: 3.71	0.2	S	2	0	0	0	1	0	0	0	0	0	0	4	4	0.00	0.000

PITCHER	IP	WLS	BF	H	R	ER	SO	BB	IBB	HBP	BLK	WP	HR	S	P	ERA	WHIP
---------	----	-----	----	---	---	----	----	----	-----	-----	-----	----	----	---	---	-----	------

Batter	1	2	3	4	5	6	7	8	9	AB R H RBI BB SO LOB	TOP									
Alex Grammas, R (1, 6) OBP: 0.325, SLG: 0.330	0-0 G3-6-3 1B		0-0 F8-3 1B		0-0 F5			0-0 6-3		4 0 2 0 0 0 0										
Red Schoendienst, S (1, 4) OBP: 0.363, SLG: 0.425	0-0 F9		0-0 F8-3 1-2			0-0 F8		0-0 1-3		4 0 0 0 0 0 2										
Stan Musial, L (1, 9) OBP: 0.432, SLG: 0.622	0-0 G3-6-3 1-2f		0-0 6-3			0-0 6-3		4-0 FC6-4 BB		3 0 0 0 1 0 1										
Ray Jablonski, R (1, 5) OBP: 0.350, SLG: 0.431		0-0 6-3		0-0 1-3		0-0 F9		0-0 F6		4 0 0 0 0 0 1										
Rip Repulski, R (1, 7) OBP: 0.327, SLG: 0.446		0-0 BB 1B 1B		0-0 BB 1B		0-0 F7		0-0 FC6-4 1-2f		4 0 2 0 0 0 1										
Wally Moon, L (1, 8) OBP: 0.375, SLG: 0.440		0-0 BB 1B		4-0 FC6-4 BB 1-2		0-0 F8				2 0 1 0 1 0 0										
Bill Sarni, R (1, 2) OBP: 0.333, SLG: 0.449		0-3 K		0-0 FC6-4 1-2f		0-0 5-3				3 0 0 0 0 1 3										
Joe Cunningham, L (1, 3) OBP: 0.380, SLG: 0.444		4-0 BB 1-2 2-3 BB		0-0 F5		0-3 K				2 0 0 0 1 1 0										
Gordon Jones, R (1, 1) OBP: 0.190, SLG: 0.200		0-0 6-3		0-0 1-3				0-0 5-3		2 0 0 0 0 0 3										
Peanuts Lowrey, R (8, PH) OBP: 0.235, SLG: 0.207										1 0 0 0 0 0 0										
Al Brazle, L (8, 1)										0 0 0 0 0 0 0										
<b>Inning Stats</b>	R: 0 E: 0 K: 0 S: 3	H: 1 LOB: 0 BB: 0 P: 3	R: 0 E: 0 K: 1 S: 7	H: 2 LOB: 3 BB: 1 P: 11	R: 0 E: 0 K: 0 S: 3	H: 1 LOB: 0 BB: 0 P: 3	R: 0 E: 0 K: 0 S: 3	H: 1 LOB: 1 BB: 1 P: 7	R: 0 E: 0 K: 0 S: 3	H: 0 LOB: 0 BB: 0 P: 3	R: 0 E: 0 K: 0 S: 3	H: 0 LOB: 0 BB: 0 P: 3	R: 0 E: 0 K: 0 S: 5	H: 0 LOB: 0 BB: 0 P: 5	R: 0 E: 0 K: 0 S: 3	H: 0 LOB: 1 BB: 1 P: 7	1B: 5 2B: 1 3B: 0 HR: 0	SF: 0 SAC: 0 DP: 2 HBP: 0	WP: 0 PB: 0 SB: 0 CS: 0	PA: 32
<b>PITCHER</b> Johnny Antonelli, L (1, 1) ERA: 2.21	IP: 9.0 WLS: W BF: 32 H: 5 R: 0 ER: 0 SO: 2 BB: 3 IBB: 0 HBP: 0 BLK: 0 WP: 0 HR: 0 S: 33 P: 45 ERA: 0.00 WHIP: 0.889																			
<b>PITCHER</b>	IP	WLS	BF	H	R	ER	SO	BB	IBB	HBP	BLK	WP	HR	S	P	ERA	WHIP			

St. Louis Cardinals @ New York Giants  
Polo Grounds, New York, NY  
Mon Sep 13 1954, 3:33 AM EDT  
Att. 6,448 - Unknown

livebaseballscorecards.com

AB 29  
R 0  
H 5  
RBI 0  
BB 3  
SO 2  
LOB 11



Batter	1	2	3	4	5	6	7	8	9
Whitey Lockman, L (1, 3) OBP: 0.320, SLG: 0.384	0-0 4-3	0-0 G3			0-0 1-2 1B		0-0 1-3		
Alvin Dark, R (1, 6) OBP: 0.333, SLG: 0.458	0-0 F7		0-0 F9		0-0 F8		0-3 K		
Willie Mays, R (1, 8) OBP: 0.405, SLG: 0.669	0-0 1B 2B		0-0 2B 1B		0-0 F7		0-0 F6		
Dusty Rhodes, L (1, 7) OBP: 0.423, SLG: 0.753 Monte Irvin, R (8, PH) OBP: 0.374, SLG: 0.452 (9, 7)	0-0 1B 1B		0-3 K		0-0 3-1		0-0 6-3		
Don Mueller, L (1, 9) OBP: 0.353, SLG: 0.430	0-0 1-2 1B		0-0 1-H 2B		0-0 F8		0-0 4-3		
Bobby Hofman, R (1, 5) OBP: 0.309, SLG: 0.458 Billy Gardner, R (6, PR) OBP: 0.269, SLG: 0.306 (7, 5)	0-0 6-3				0-0 F7	4-0 BB			
Davey Williams, R (1, 4) OBP: 0.284, SLG: 0.316		0-0 1-3			0-0 6-3		0-0 F9		
Ray Katt, R (1, 2) OBP: 0.325, SLG: 0.441		0-0 F8			0-0 F6		0-0 4-3		
Johnny Antonelli, L (1, 1) OBP: 0.188, SLG: 0.217		0-0 1B			0-0 1B		0-3 K		

Inning Stats	R: 1	H: 3	E: 0	LOB: 2	K: 0	P: 6	R: 0	H: 1	E: 0	LOB: 1	K: 0	P: 4	R: 0	H: 2	E: 0	LOB: 2	K: 1	P: 6	R: 0	H: 0	E: 0	LOB: 0	K: 0	P: 3	R: 0	H: 2	E: 0	LOB: 2	K: 0	P: 5	R: 0	H: 0	E: 0	LOB: 1	K: 0	P: 7	R: 0	H: 0	E: 0	LOB: 0	K: 2	P: 7	R: 0	H: 0	E: 0	LOB: 0	K: 0	P: 3
	6	2	0	0	0	0	0	1	0	0	0	0	0	0	0	0	0	0	0	0	0	0	0	0	0	0	0	0	0	0	0	0	0	0	0	0	0	0	0	0	0	0	0	0	0	0	0	

PITCHER	IP	WLS	BF	H	R	ER	SO	BB	IBB	HBP	BLK	WP	HR	S	P	ERA	WHIP
Gordon Jones, R (1, 1) ERA: 2.08	7.0	L	29	8	1	1	3	1	0	0	0	0	0	34	38	1.29	1.286
Al Brazle, L (8, 1) ERA: 4.24	1.0		3	0	0	0	0	0	0	0	0	0	0	3	3	0.00	0.000

**BOTTOM**

**St. Louis Cardinals @ New York Giants**  
Polo Grounds, New York, NY  
Mon Sep 13 1954, 3:33 AM EDT  
Att. 6,448 - Unknown

AB	31
R	1
H	8
RBI	1
BB	1
SO	3
LOB	12



1B	6	SF	0	WP	0	PA	32
2B	2	SAC	0	PB	0		
3B	0	DP	0	SB	0		
HR	0	HBP	0	CS	0		

livebaseballscorecards.com

Batter	1	2	3	4	5	6	7	8	9	AB R H RBI BB SO LOB	TOP	
Bill Bruton, L (1, 8) OBP: 0.343, SLG: 0.368	0-0 G4-6-3 1B	0-0 3-1			0-0 F8		0-0 F8			4 0 1 0 0 0 4		
Jack Dittmer, L (1, 4) OBP: 0.333, SLG: 0.440	0-0 G4-6-3 1-2f		0-0 F7		0-0 F8			0-0 E4 G5-4-3 BB		4 0 0 0 0 0 2		
Eddie Mathews, L (1, 5) OBP: 0.419, SLG: 0.591	4-0 BB		0-0 F3		0-0 1B 1B			4-0 BB G5-4-3 1-2		2 1 1 0 2 0 0		
Del Crandall, R (1, 2) OBP: 0.309, SLG: 0.443	0-0 F8		0-0 4-3		0-0 F8			0-0 G5-4-3 1-2f 2-3		4 0 0 0 0 0 4		
Andy Pafko, R (1, 9) OBP: 0.331, SLG: 0.421		0-0 2B 1B		0-0 6-3		0-0 1B 1B		0-0 F7		4 0 2 0 0 0 1		
Bobby Thomson, R (1, 7) OBP: 0.356, SLG: 0.388		0-3 K		0-3 K		0-0 G6-4-3 1B		0-3 K		4 0 1 1 0 3 1		
Johnny Logan, R (1, 6) OBP: 0.335, SLG: 0.370		0-0 1-3 2B		0-0 F8		0-0 G6-4-3 1-2f		0-0 F7		4 0 1 0 0 0 2		
George Metkovich, L (1, 3) OBP: 0.339, SLG: 0.319		4-0 IBB			0-0 FC1-5 2B		0-3 K		0-3 K	3 0 1 0 1 2 0		
Gene Conley, R (1, 1) OBP: 0.156, SLG: 0.169		0-3 K			0-0 FC1-5 2-3		0-3 K			3 0 0 0 0 2 4		
Chet Nichols, S (8, 1) OBP: 0.094, SLG: 0.094										0 0 0 0 0 0 0		
Bob Buhl, R (8, 1) OBP: 0.100, SLG: 0.036										0 0 0 0 0 0 0		
<b>Inning Stats</b>	R: 0 E: 0 K: 0 S: 3 H: 1 LOB: 1 BB: 1 P: 7	R: 0 E: 0 K: 2 S: 9 H: 2 LOB: 3 BB: 1 P: 13	R: 0 E: 0 K: 0 S: 3 H: 0 LOB: 0 BB: 0 P: 3	R: 0 E: 0 K: 1 S: 5 H: 0 LOB: 0 BB: 0 P: 5	R: 0 E: 0 K: 0 S: 4 H: 1 LOB: 1 BB: 0 P: 4	R: 1 E: 0 K: 0 S: 5 H: 3 LOB: 1 BB: 0 P: 5	R: 0 E: 0 K: 2 S: 7 H: 0 LOB: 0 BB: 0 P: 7	R: 0 E: 1 K: 0 S: 3 H: 0 LOB: 1 BB: 1 P: 7	R: 0 E: 0 K: 2 S: 7 H: 0 LOB: 0 BB: 0 P: 7	1B: 5 2B: 2 3B: 0 HR: 0 SF: 0 SAC: 0 DP: 3 HBP: 0	WP: 0 PB: 0 SB: 0 CS: 0 PA: 35	
<b>PITCHER</b>	IP WLS BF H R ER SO BB IBB HBP BLK WP HR S P ERA WHIP											
Sal Maglie, R (1, 1) ERA: 3.34	7.0 28 7 1 1 5 1 1 0 0 0 0 36 44 1.29 1.143											
Hoyt Wilhelm, R (8, 1) ERA: 2.29	2.0 W 7 0 0 0 2 1 0 0 0 0 0 0 10 14 0.00 0.500											

Milwaukee Braves @ New York Giants  
Polo Grounds, New York, NY  
Tue Sep 14 1954, 3:33 AM EDT  
Att: 31,331 - Unknown

livebaseballscorecards.com

AB 32  
R 1  
H 7  
RBI 1  
BB 3  
SO 7  
LOB 18

Batter	1	2	3	4	5	6	7	8	9
Whitey Lockman, L (1, 3) OBP: 0.319, SLG: 0.389	0-0 4-3		0-0 F8		0-0 F9		0-0 HR		
Alvin Dark, R (1, 6) OBP: 0.331, SLG: 0.455	0-3 K		0-0 5-3		0-0 F2		0-0 F5		
Don Mueller, L (1, 9) OBP: 0.354, SLG: 0.431	0-0 F8		0-0 F4		0-0 1B			0-0 WP BB 1B	
Dusty Rhodes, L (1, 7) OBP: 0.431, SLG: 0.750		4-0 FC5-4 BB		0-0 BB 1B	0-3 K			4-0 WP 1B BB	
Willie Mays, R (1, 8) OBP: 0.404, SLG: 0.665		0-0 FC5-4 PB 1B 1-2f		0-0 F8		0-0 1-3		4-0 1B 2-3 IBB	
Hank Thompson, L (1, 5) OBP: 0.390, SLG: 0.493		0-0 PB 1B		4-0 1-2 BB		4-0 G6-4-3 BB		0-0 1-3 2-H 3-H 4-0 1B	
Bobby Hofman, R (8, PH) OBP: 0.315, SLG: 0.463									
Billy Gardner, R (9, 5) OBP: 0.269, SLG: 0.306									
Davey Williams, R (1, 4) OBP: 0.284, SLG: 0.314		0-3 K		0-0 F9		0-0 G6-4-3			
Wes Westrum, R (1, 2) OBP: 0.319, SLG: 0.313		4-0 IBB		0-0 F7			0-3 K	0-3 K	
Sal Maglie, R (1, 1) OBP: 0.197, SLG: 0.131		0-0 F8			0-0 1B		0-3 K	0-3 K	
Bill Taylor, L (7, PH) OBP: 0.250, SLG: 0.306									
Hoyt Wilhelm, R (8, 1) OBP: 0.050, SLG: 0.050									

Inning Stats	R: 0 E: 0 K: 1 S: 5	H: 0 LOB: 0 BB: 0 P: 5	R: 0 E: 0 K: 1 S: 6	H: 1 LOB: 3 BB: 2 P: 14	R: 0 E: 0 K: 0 S: 3	H: 0 LOB: 0 BB: 0 P: 3	R: 0 E: 0 K: 0 S: 4	H: 1 LOB: 2 BB: 1 P: 8	R: 0 E: 0 K: 1 S: 7	H: 2 LOB: 2 BB: 0 P: 7	R: 0 E: 0 K: 0 S: 2	H: 0 LOB: 0 BB: 1 P: 6	R: 1 E: 0 K: 2 S: 8	H: 1 LOB: 0 BB: 0 P: 8	R: 1 E: 0 K: 2 S: 8	H: 2 LOB: 3 BB: 3 P: 20
--------------	------------------------------	---------------------------------	------------------------------	----------------------------------	------------------------------	---------------------------------	------------------------------	---------------------------------	------------------------------	---------------------------------	------------------------------	---------------------------------	------------------------------	---------------------------------	------------------------------	----------------------------------

PITCHER	IP	WLS	BF	H	R	ER	SO	BB	IBB	HBP	BLK	WP	HR	S	P	ERA	WHIP
Gene Conley, R (1, 1) ERA: 2.96	7.0	L	32	6	2	2	5	4	2	0	0	1	1	36	60	2.57	1.429
Chet Nichols, L (8, 1) ERA: 4.18	0.1		1	1	0	0	0	0	0	0	0	0	0	1	1	0.00	3.000
Bob Buhl, R (8, 1) ERA: 3.99	0.2		3	0	0	0	2	0	1	0	0	0	0	6	10	0.00	0.000

**BOTTOM**

**Milwaukee Braves @ New York Giants**  
Polo Grounds, New York, NY

Tue Sep 14 1954, 3:33 AM EDT  
Att. 31,331 - Unknown

AB	R	H	RBI	BB	SO	LOB
4	1	1	1	0	0	1
4	0	0	0	0	1	1
4	1	2	0	0	0	0
2	0	1	0	2	1	2
3	0	0	0	1	0	2
1	0	1	0	2	0	0
1	0	1	1	0	0	0
0	0	0	0	0	0	0
3	0	0	0	1	1	5
3	0	0	0	1	2	5
2	0	1	0	0	0	3
1	0	0	0	0	1	0
1	0	0	0	0	1	3

AB	29
R	2
H	7
RBI	2
BB	7
SO	7
LOB	22

livebaseballscorecards.com

**AB 29**  
**R 2**  
**H 7**  
**RBI 2**  
**BB 7**  
**SO 7**  
**LOB 22**



WP	PA
1	36
1	36
0	36
0	36

Batter	1	2	3	4	5	6	7	8	9	AB R H RBI BB SO LOB	TOP											
Bill Bruton, L (1, 8) OBP: 0.340, SLG: 0.364	0-0 F8		0-0 E6 1B		0-0 F5		0-3 K		0-0 FC6 1B 1-2f	5 0 0 0 0 1 3	<p>Milwaukee Braves @ New York Giants</p> <p>Polo Grounds, New York, NY</p> <p>Thu Sep 16 1954, 3:33 AM EDT</p> <p>Unknown</p>											
Jack Dittmer, L (1, 4) OBP: 0.329, SLG: 0.432	0-0 F8		0-0 F7		0-0 1B		0-0 3-1		0-0 F7	5 0 1 0 0 0 4												
Eddie Mathews, L (1, 5) OBP: 0.420, SLG: 0.590	4-0 BB		0-0 1B 1-3		0-0 F5			0-0 F7	0-0 FC6-4 1B 1-3	4 0 2 0 1 0 1												
Del Crandall, R (1, 2) OBP: 0.308, SLG: 0.439	0-3 K		0-0 1-3					0-0 4-3	4-0 1B BB E	4 1 0 0 1 1 5												
Andy Pafko, R (1, 9) OBP: 0.331, SLG: 0.420		0-0 F8		0-0 6-3		0-0 F8		0-0 E SF9 1B 1-2		4 1 1 0 0 0 0												
Jim Pendleton, R (1, 7) OBP: 0.224, SLG: 0.266		0-0 6-3		0-0 F8		0-3 K		0-0 E5 1-3 2-H		4 0 0 0 0 1 1												
Johnny Logan, R (1, 6) OBP: 0.336, SLG: 0.373		4-0 BB		0-0 1B			0-0 E 1B	0-0 SF9 3-H		2 0 2 1 1 0 0												
George Metkovich, L (1, 3) OBP: 0.336, SLG: 0.316		0-0 G3		0-3 K			0-0 E1 1B 1-3	0-0 F4		4 0 1 0 0 1 3												
Warren Spahn, L (1, 1) OBP: 0.275, SLG: 0.290			0-0 F8		0-0 G3		0-0 1-3		0-0 FC6 1B	2 0 0 0 0 0 0												
Ernie Johnson, R (5, 1) OBP: 0.273, SLG: 0.273										0 0 0 0 0 0 0												
Charlie White, L (7, PH) OBP: 0.293, SLG: 0.308										1 0 0 0 0 0 2												
Bob Buhl, R (7, 1) OBP: 0.100, SLG: 0.036										0 0 0 0 0 0 0												
Danny O'Connell, R (9, PH) OBP: 0.325, SLG: 0.360										1 0 1 0 0 0 0												
<b>Inning Stats</b>	R: 0 E: 0 K: 1 S: 5	H: 0 LOB: 1 BB: 1 P: 9	R: 0 E: 0 K: 0 S: 3	H: 0 LOB: 1 BB: 1 P: 7	R: 0 E: 1 K: 0 S: 5	H: 1 LOB: 2 BB: 0 P: 5	R: 0 E: 0 K: 1 S: 6	H: 1 LOB: 1 BB: 0 P: 6	R: 0 E: 0 K: 1 S: 4	H: 1 LOB: 1 BB: 0 P: 4	R: 0 E: 0 K: 1 S: 5	H: 0 LOB: 0 BB: 0 P: 5	R: 0 E: 1 K: 1 S: 7	H: 2 LOB: 2 BB: 0 P: 7	R: 2 E: 1 K: 0 S: 5	H: 1 LOB: 1 BB: 1 P: 9	R: 0 E: 0 K: 0 S: 5	H: 2 LOB: 2 BB: 0 P: 5	1B: 8 2B: 0 3B: 0 HR: 0	SF: 1 SAC: 0 DP: 0 HBP: 0	WP: 0 PB: 0 SB: 0 CS: 0	PA: 40
<b>PITCHER</b> Ruben Gomez, R (1, 1) ERA: 2.95	IP: 9.0 WLS: W BF: 40 H: 8 R: 2 ER: 0 SO: 4 BB: 3 IBB: 0 HBP: 0 BLK: 0 WP: 0 HR: 0 S: 45 P: 57 ERA: 0.00 WHIP: 1.222											<b>PITCHER</b>	IP: 9.0 WLS: W BF: 40 H: 8 R: 2 ER: 0 SO: 4 BB: 3 IBB: 0 HBP: 0 BLK: 0 WP: 0 HR: 0 S: 45 P: 57 ERA: 0.00 WHIP: 1.222									

livebaseballscorecards.com

AB	36
R	2
H	8
RBI	1
BB	3
SO	4
LOB	19





Batter	1	2	3	4	5	6	7	8	9	AB	R	H	RBI	BB	SO	LOB
Whitey Lockman, L (1, 3) OBP: 0.320, SLG: 0.389	0-0 SH2-3 2B 1B		0-0 E2 SH3-4 SF8 1B		0-3 K	0-0 1-3		0-0 6-3		5	2	2	0	0	1	0
Alvin Dark, R (1, 6) OBP: 0.330, SLG: 0.453	0-0 SH2-3 1-2		0-0 SH3-4		0-0 F8		0-0 F2			2	0	0	0	0	0	0
Bobby Hofman, R (1, 5) OBP: 0.320, SLG: 0.464	0-0 F7		0-0 SF8		0-0 BB 1B		4-0 1B SF8 BB			2	1	1	1	1	0	1
Billy Gardner, R (7, PR) OBP: 0.269, SLG: 0.306										0	1	0	0	0	0	0
Hank Thompson, L (8, 5) OBP: 0.390, SLG: 0.493										0	0	0	0	0	0	0
Willie Mays, R (1, 8) OBP: 0.408, SLG: 0.665	4-0 2B IBB		4-0 BB		4-0 1B 1B BB		0-0 1B			1	2	1	0	3	0	0
Monte Irvin, R (1, 7) OBP: 0.375, SLG: 0.456	0-0 1-H 2-H 2B		0-0 F6		0-0 1B 1B		0-0 SF8			3	0	2	4	0	0	1
Don Mueller, L (1, 9) OBP: 0.355, SLG: 0.430	0-0 6-3			0-0 4-3		0-0 1-3 2-H 1B		4-0 IBB		3	0	1	1	1	0	1
Davey Williams, R (1, 4) OBP: 0.284, SLG: 0.314		0-0 1-3		0-0 1B 1B		0-0 F8		0-0 1-3		4	0	1	0	0	0	4
Wes Westrum, R (1, 2) OBP: 0.318, SLG: 0.312		0-0 5-3		0-0 G6-4-3 1-2 1B		0-0 5-3		0-0 4-3		4	0	1	0	0	0	0
Ruben Gomez, R (1, 1) OBP: 0.175, SLG: 0.215		0-0 F8		0-0 G6-4-3 1-2f		0-0 F6		0-0 1-3		4	0	0	0	0	0	2

Inning Stats	R: 2	H: 2	E: 0	K: 0	S: 5	LOB: 1	BB: 1	P: 9	R: 0	H: 0	E: 0	K: 0	S: 3	LOB: 0	BB: 0	P: 3	R: 1	H: 1	E: 1	K: 0	S: 4	LOB: 1	BB: 1	P: 8	R: 0	H: 2	E: 0	K: 0	S: 4	LOB: 1	BB: 0	P: 4	R: 2	H: 3	E: 0	K: 1	S: 8	LOB: 2	BB: 1	P: 12	R: 0	H: 0	E: 0	K: 0	S: 3	LOB: 0	BB: 0	P: 3	R: 1	H: 1	E: 0	K: 0	S: 4	LOB: 2	BB: 2	P: 12	R: 0	H: 0	E: 0	K: 0	S: 3	LOB: 0	BB: 0	P: 3
--------------	------	------	------	------	------	--------	-------	------	------	------	------	------	------	--------	-------	------	------	------	------	------	------	--------	-------	------	------	------	------	------	------	--------	-------	------	------	------	------	------	------	--------	-------	-------	------	------	------	------	------	--------	-------	------	------	------	------	------	------	--------	-------	-------	------	------	------	------	------	--------	-------	------

PITCHER	IP	WLS	BF	H	R	ER	SO	BB	IBB	HBP	BLK	WP	HR	S	P	ERA	WHIP
Warren Spahn, L (1, 1) ERA: 3.2	4.2	L	24	8	5	4	1	2	1	0	0	0	0	23	35	7.71	2.143
Ernie Johnson, R (5, 1) ERA: 2.93	1.1		4	0	0	0	0	0	0	0	0	0	0	4	4	0.00	0.000
Bob Buhl, R (7, 1) ERA: 4.0	2.0		9	1	1	1	0	1	1	0	0	0	0	7	15	4.50	1.000

**BOTTOM**

**Milwaukee Braves @ New York Giants**  
Polo Grounds, New York, NY  
Thu Sep 16 1954, 3:33 AM EDT  
Unknown

AB	28
R	6
H	9
RBI	6
BB	5
SO	1
LOB	9



WP	PA	ERA	WHIP
0	37		





Batter	1	2	3	4	5	6	7	8	9	AB R H RBI BB SO LOB	TOP											
<b>Richie Ashburn, L</b> (1, 8) OBP: 0.441, SLG: 0.376	0-0 F2			0-0 5-3	0-3 K			0-0 SH5-4 1B	0-0 4-3	5 1 1 0 0 1 3												
<b>Mel Clark, R</b> (1, 7) OBP: 0.292, SLG: 0.358	0-0 6-3			0-0 HR 1B		0-0 F5		0-0 SH5-4 1B		4 2 2 0 0 0 0												
<b>Stan Lopata, R</b> (1, 2) OBP: 0.377, SLG: 0.538	0-3 K			0-0 HR		0-0 1-3		0-0 SH5-4		3 1 1 2 0 1 0												
<b>Granny Hamner, R</b> (1, 4) OBP: 0.357, SLG: 0.482		0-0 5-3		0-0 F8		0-0 6-3		4-0 1B IBB		3 0 0 0 1 0 0												
<b>Del Ennis, R</b> (1, 9) OBP: 0.319, SLG: 0.447		0-0 F8		0-0 F8			0-3 K	0-0 L4-3 1B		4 0 1 2 0 1 0												
<b>Bobby Morgan, R</b> (1, 6) OBP: 0.366, SLG: 0.436		0-0 F7			0-3 K		0-0 WP BB 1B	0-0 L4-3		4 0 1 0 0 1 2												
<b>Willie Jones, R</b> (1, 5) OBP: 0.341, SLG: 0.401			0-3 K		4-0 FC1-5 1B BB		4-0 WP BB		0-3 K2-3	2 0 0 0 2 2 0	AB 32											
<b>Johnny Wyrostek, L</b> (1, 3) OBP: 0.309, SLG: 0.360			0-3 K		0-0 FC1-5 1B		0-3 K		4-0 FC1-6 BB	2 0 1 0 0 1 0	R 4											
<b>Danny Schell, R</b> (7, PH) OBP: 0.323, SLG: 0.433					1-2 1B		1-2 2-3			1 0 0 0 0 1 2	H 7											
<b>Earl Torgeson, L</b> (7, 3) OBP: 0.364, SLG: 0.371					0-0 FC1-5		0-0 6-3			0 0 0 0 1 0 0	RBI 4											
<b>Robin Roberts, S</b> (1, 1) OBP: 0.157, SLG: 0.184			0-0 F5		1-2 2-3f				0-0 FC1-6	4 0 0 0 0 0 5	BB 4											
<b>Inning Stats</b>	R: 0 E: 0 K: 1 S: 5	H: 0 LOB: 0 BB: 0 P: 5	R: 0 E: 0 K: 0 S: 3	H: 0 LOB: 0 BB: 0 P: 3	R: 0 E: 0 K: 2 S: 7	H: 0 LOB: 0 BB: 0 P: 7	R: 2 E: 0 K: 0 S: 5	H: 2 LOB: 0 BB: 0 P: 5	R: 0 E: 0 K: 2 S: 8	H: 1 LOB: 2 BB: 1 P: 12	R: 0 E: 0 K: 0 S: 3	H: 0 LOB: 0 BB: 0 P: 3	R: 0 E: 0 K: 2 S: 8	H: 1 LOB: 2 BB: 1 P: 12	R: 2 E: 0 K: 0 S: 5	H: 3 LOB: 1 BB: 1 P: 9	R: 0 E: 0 K: 1 S: 5	H: 0 LOB: 1 BB: 1 P: 9	1B: 6 2B: 1 3B: 0 HR: 1	SF: 0 SAC: 1 DP: 1 HBP: 0	WP: 1 PB: 0 SB: 0 CS: 0	PA: 37
<b>PITCHER</b>	IP WLS BF H R ER SO BB IBB HBP BLK WP HR S P ERA WHIP																					
<b>Johnny Antonelli, L</b> (1, 1) ERA: 2.29	7.1 L 32 7 4 4 7 2 1 0 0 1 1 43 55 4.91 1.227																					
<b>Hoyt Wilhelm, R</b> (8, 1) ERA: 2.18	1.2 5 0 0 0 1 1 0 0 0 0 0 0 6 10 0.00 0.600																					

Philadelphia Phillies @ New York Giants  
Polo Grounds, New York, NY  
Fri Sep 17 1954, 3:33 AM EDT  
Att. 11,540 - Unknown

AB	32
R	4
H	7
RBI	4
BB	4
SO	8
LOB	12



Batter	1	2	3	4	5	6	7	8	9	AB R H RBI BB SO LOB
Whitey Lockman, L (1, 3) OBP: 0.317, SLG: 0.383	0-0 4-3	0-0 F2			0-0 F9		0-0 F8		0-0 F2	5 0 0 0 0 0 4
Alvin Dark, R (1, 6) OBP: 0.329, SLG: 0.455	0-3 K		0-0 F8		0-0 E5 1B		0-0 F5			4 1 0 0 0 1 1
Don Mueller, L (1, 9) OBP: 0.357, SLG: 0.433	0-0 1B		0-0 4-3		0-0 1B 2-4-2 1B			0-0 SH1-4 1B		4 0 3 2 0 0 0
Dusty Rhodes, L (1, 7) OBP: 0.425, SLG: 0.729	0-0 F6		0-0 F7		0-0 1B			0-0 SH1-4		3 0 1 0 0 0 1
Willie Mays, R (1, 8) OBP: 0.407, SLG: 0.667		0-0 F7		0-0 F5	0-0 2-4-2	0-0 F4		0-0 F8		4 0 0 0 0 0 1
Hank Thompson, L (1, 5) OBP: 0.389, SLG: 0.488		4-0 2B FC6-4 BB		0-3 K		4-0 FC4-6 BB		0-0 4-3		2 1 0 0 2 1 1
Davey Williams, R (1, 4) OBP: 0.285, SLG: 0.322		0-0 FC6-4 1-3 2B		0-0 4-3		0-0 FC4-6 1-2f			0-0 F7	4 0 1 0 0 0 1
Wes Westrum, R (1, 2) OBP: 0.314, SLG: 0.304		4-0 FC6-4 BB			0-0 F3	0-0 4-3			0-0 1B	2 0 0 0 1 0 1
Bobby Hofman, R (9, PH) OBP: 0.328, SLG: 0.469										1 0 1 0 0 0 0
Billy Gardner, R (9, PR) OBP: 0.269, SLG: 0.306										0 0 0 0 0 0 0
Johnny Antonelli, L (1, 1) OBP: 0.192, SLG: 0.221		0-0 FC6-4			0-0 E 1B		0-0 F4		0-0 F5	3 1 1 1 0 0 2
Hoyt Wilhelm, R (8, 1) OBP: 0.048, SLG: 0.048										0 0 0 0 0 0 0
Joe Garagiola, L (9, PH) OBP: 0.396, SLG: 0.403										1 0 0 0 0 0 1

Inning Stats	R: 0	H: 1	E: 0	LOB: 1	K: 1	BB: 0	S: 6	P: 6	R: 1	H: 1	E: 0	LOB: 2	K: 0	BB: 2	S: 4	P: 12	R: 0	H: 0	E: 0	LOB: 0	K: 0	BB: 0	S: 3	P: 3	R: 0	H: 0	E: 1	LOB: 2	K: 0	BB: 0	S: 6	P: 6	R: 0	H: 0	E: 0	LOB: 1	K: 0	BB: 1	S: 3	P: 7	R: 0	H: 0	E: 0	LOB: 0	K: 0	BB: 0	S: 3	P: 3	R: 0	H: 1	E: 0	LOB: 1	K: 0	BB: 0	S: 4	P: 4	R: 0	H: 1	E: 0	LOB: 1	K: 0	BB: 0	S: 4	P: 4	R: 0	H: 1	E: 0	LOB: 1	K: 0	BB: 0	S: 4	P: 4
PITCHER Robin Roberts, R (1, 1) ERA: 3.06	IP	WLS	BF	H	R	ER	SO	BB	IBB	HBP	BLK	WP	HR	S	P	ERA	WHIP	IP	WLS	BF	H	R	ER	SO	BB	IBB	HBP	BLK	WP	HR	S	P	ERA	WHIP	IP	WLS	BF	H	R	ER	SO	BB	IBB	HBP	BLK	WP	HR	S	P	ERA	WHIP																					

**BOTTOM**

**Philadelphia Phillies @ New York Giants**  
Polo Grounds, New York, NY

Fri Sep 17 1954, 3:33 AM EDT  
Att. 11,540 - Unknown

AB	33
R	3
H	7
RBI	3
BB	3
SO	2
LOB	13



WP: 0	PA: 37
PB: 0	SB: 0
CS: 0	

Batter	1	2	3	4	5	6	7	8	9	AB R H RBI BB SO LOB	TOP	
<b>Richie Ashburn, L</b> (1, 8) OBP: 0.441, SLG: 0.378	0-0 3-1 2B		0-0 5-3			4-0 BB BB		0-0 6-3		3 0 1 0 1 0 0		
<b>Mel Clark, R</b> (1, 7) OBP: 0.291, SLG: 0.353	0-0 3-1 2-3			0-0 5-3		4-0 1-2 BB G6-4-3		0-0 1-3		3 0 0 0 1 0 1		
<b>Stan Lopata, R</b> (1, 2) OBP: 0.375, SLG: 0.533	0-3 K			0-0 F5		0-0 F8				4 0 1 0 0 1 3		
<b>Granny Hamner, R</b> (1, 4) OBP: 0.356, SLG: 0.480	0-0 5-3			4-0 FC6-4 BB		0-0 G6-4-3 1-2f				3 0 0 0 1 0 4		
<b>Del Ennis, R</b> (1, 9) OBP: 0.317, SLG: 0.444		0-0 4-3		0-0 FC6-4 1-2f			0-0 5-3		0-3 K	4 0 0 0 0 1 2		
<b>Bobby Morgan, R</b> (1, 6) OBP: 0.363, SLG: 0.432		0-0 5-3			0-0 1-3		0-0 6-3		0-0 1-3	4 0 0 0 0 0 1		
<b>Willie Jones, R</b> (1, 5) OBP: 0.341, SLG: 0.406		0-0 F6			0-0 HR		0-0 E6			3 1 1 1 0 0 0		
<b>Johnny Wyrostek, L</b> (1, 3) OBP: 0.306, SLG: 0.356			0-3 K		0-0 3-1		0-0 3-1			3 0 0 0 0 1 1		
<b>Murry Dickson, R</b> (1, 1) OBP: 0.190, SLG: 0.205 <b>Bob Miller, R</b> (2, 1) OBP: 0.204, SLG: 0.235 <b>Stan Palys, R</b> (5, PH) OBP: 0.450, SLG: 0.250 <b>Steve Ridzik, R</b> (5, 1) OBP: 0.227, SLG: 0.318 <b>Smoky Burgess, L</b> (8, PH) OBP: 0.419, SLG: 0.506 <b>Ron Mizosinski, R</b> (8, 1) OBP: 0.091, SLG: 0.091		0-0 4-3		0-0 F8				0-0 F7		0 0 0 0 0 0 0 1 0 0 0 0 0 0 1 0 0 0 0 0 0 0 0 0 0 0 0 0 1 0 0 0 0 0 0 0 0 0 0 0 0 0		
<b>Inning Stats</b>	R: 0 E: 0 K: 1 S: 6 H: 1 LOB: 1 BB: 0 P: 6	R: 0 E: 0 K: 0 S: 3 H: 0 LOB: 0 BB: 0 P: 3	R: 0 E: 0 K: 1 S: 5 H: 0 LOB: 0 BB: 0 P: 5	R: 0 E: 0 K: 0 S: 3 H: 0 LOB: 1 BB: 1 P: 7	R: 1 E: 0 K: 0 S: 4 H: 1 LOB: 0 BB: 0 P: 4	R: 0 E: 0 K: 0 S: 2 H: 0 LOB: 1 BB: 2 P: 10	R: 0 E: 1 K: 0 S: 4 H: 0 LOB: 1 BB: 0 P: 4	R: 0 E: 0 K: 0 S: 3 H: 0 LOB: 0 BB: 0 P: 3	R: 0 E: 0 K: 1 S: 6 H: 1 LOB: 1 BB: 0 P: 6	1B: 1 2B: 1 3B: 0 HR: 1 SF: 0 SAC: 0 DP: 1 HBP: 0	WP: 0 PB: 0 SB: 0 CS: 0 PA: 33	
<b>PITCHER</b>	<b>Don Liddle, L</b> (1, 1) ERA: 3.29 <b>Mary Grissom, R</b> (6, 1) ERA: 2.43	IP WLS BF H R ER SO BB IBB HBP BLK WP HR S P ERA WHIP	5.0 W 20 2 1 1 2 3 0 0 0 0 0 1 21 33 1.80 1.000	4.0 S 13 1 0 0 1 0 0 0 0 0 0 0 15 15 0.00 0.250	<b>PITCHER</b>	IP WLS BF H R ER SO BB IBB HBP BLK WP HR S P ERA WHIP						

Philadelphia Phillies @ New York Giants  
Polo Grounds, New York, NY  
Sat Sep 18 1954, 3:33 AM EDT  
Att. 7,988 - Unknown

livebaseballscorecards.com

AB 30  
R 1  
H 3  
RBI 1  
BB 3  
SO 3  
LOB 12



BOTTOM

Philadelphia Phillies @ New York Giants  
Polo Grounds, New York, NY

livebaseballscorecards.com

AB	34
R	9
H	13
RBI	9
BB	3
SO	2
LOB	14



WP:	0	PA:	38
PB:	0		
SB:	0		
CS:	0		

Sat Sep 18 1954, 3:33 AM EDT  
Att. 7,988 - Unknown

AB R H RBI BB SO LOB

5 0 1 1 0 0 3

5 1 2 2 0 0 2

4 2 3 1 0 0 1

2 2 1 3 2 0 1

4 0 1 0 0 0 2

4 0 0 0 0 0 3

4 2 2 1 0 1 1

3 1 1 0 0 1 1

1 1 1 1 1 0 0

2 0 1 0 0 0 0

1B:	11	SF:	0
2B:	0	SAC:	1
3B:	0	DP:	2
HR:	2	HBP:	0

Batter	1	2	3	4	5	6	7	8	9
Whitey Lockman, L OBP: 0.316, SLG: 0.381 (1, 3)	0-0 F6	0-0 G4-6-3 1B		0-0 G3		0-0 4-3		0-0 G1-6-3	
Alvin Dark, R OBP: 0.329, SLG: 0.455 (1, 6)	0-0 F9	0-0 G4-6-3		0-0 1B		0-0 1B HR		0-0 F5	
Don Mueller, L OBP: 0.360, SLG: 0.440 (1, 9)	0-0 IHR		0-0 1B	0-0 3-4-3		0-0 1B HR			
Willie Mays, R OBP: 0.409, SLG: 0.672 (1, 8)	4-0 BB		0-0 F5		4-0 1B FC4-6	0-0 BB		0-0 1B HR	
Hank Thompson, L OBP: 0.388, SLG: 0.486 (1, 5)	0-0 G3		0-0 F3		0-0 1B FC4-6	0-0 F4			
Monte Irvin, R OBP: 0.372, SLG: 0.451 (1, 7)		0-0 6-3	0-0 F8		0-0 F2		0-0 5-3		
Davey Williams, R OBP: 0.287, SLG: 0.324 (1, 4)		0-0 1B 1B		0-0 G3 SH2-3 1B	0-0 FC4-6		0-3 K		
Ray Katt, R OBP: 0.325, SLG: 0.439 (1, 2)		0-0 1B 1B		0-0 SH2-3	0-0 F5		0-3 K		
Don Liddle, L OBP: 0.341, SLG: 0.182 Mary Grissom, R OBP: 0.212, SLG: 0.161 (6, 1)		0-0 1B 1B		4-0 1B G3 BB		0-0 5-3		0-0 G1-6-3 1B	

Inning Stats	R: 1	H: 1	E: 0	K: 0	S: 4	LOB: 1	BB: 1	P: 8	R: 2	H: 4	E: 0	K: 0	S: 6	LOB: 1	BB: 0	P: 6	R: 0	H: 1	E: 0	K: 0	S: 4	LOB: 1	BB: 0	P: 4	R: 2	H: 2	E: 0	K: 0	S: 5	LOB: 1	BB: 1	P: 9	R: 1	H: 1	E: 0	K: 0	S: 4	LOB: 1	BB: 1	P: 8	R: 3	H: 3	E: 0	K: 0	S: 6	LOB: 0	BB: 0	P: 6	R: 0	H: 0	E: 0	K: 2	S: 7	LOB: 0	BB: 0	P: 7	R: 0	H: 1	E: 0	K: 0	S: 3	LOB: 0	BB: 0	P: 3
--------------	------	------	------	------	------	--------	-------	------	------	------	------	------	------	--------	-------	------	------	------	------	------	------	--------	-------	------	------	------	------	------	------	--------	-------	------	------	------	------	------	------	--------	-------	------	------	------	------	------	------	--------	-------	------	------	------	------	------	------	--------	-------	------	------	------	------	------	------	--------	-------	------

PITCHER	IP	WLS	BF	H	R	ER	SO	BB	IBB	HBP	BLK	WP	HR	S	P	ERA	WHIP
Murry Dickson, R ERA: 3.92 (1, 1)	1.1	L	10	5	3	3	0	1	0	0	0	0	0	9	13	20.25	4.500
Bob Miller, R ERA: 4.59 (2, 1)	2.2		11	3	2	2	0	1	0	0	0	0	0	10	14	6.75	1.500
Steve Ridzik, R ERA: 4.13 (5, 1)	3.0		14	4	4	4	2	1	0	0	0	0	1	17	21	12.00	1.667
Ron Mrozinski, L ERA: 4.79 (8, 1)	1.0		3	1	0	0	0	0	0	0	0	0	0	3	3	0.00	1.000

Batter	1	2	3	4	5	6	7	8	9	AB R H RBI BB SO LOB	TOP	
Whitey Lockman, L (1, 3) OBP: 0.318, SLG: 0.384	4-0 SH3-4 1B 1B BB		1-3 K		0-0 6-3		1-2 2B		1-2 6-3 SH1-4 1B	4 1 2 1 1 1 1		
Alvin Dark, R (1, 6) OBP: 0.329, SLG: 0.454	1-2 1B 1B 1B		0-0 6-3			1-0 F8	0-1 F8		0-0 SH1-4	4 1 1 0 0 0 1		
Don Mueller, L (1, 9) OBP: 0.359, SLG: 0.439	1-1 SH3-4		0-1 F4			1-1 2B 1B	0-0 L8		0-0 6-3	4 1 1 0 0 0 2		
Willie Mays, R (1, 8) OBP: 0.411, SLG: 0.673	2-1 1B 1B			1-0 CS 1B		2-3 K		0-0 1B 2B	3-3 K	5 1 3 1 0 2 2		
Hank Thompson, L (1, 5) OBP: 0.391, SLG: 0.491	0-0 G6-4-3 1B			2-3 K 1-2		0-0 2B 2B		0-1 2B SF9 1B		4 2 3 2 0 1 1		
Monte Irvin, R (1, 7) OBP: 0.373, SLG: 0.457	1-0 G6-4-3			2-1 F2		2-2 2B		2-0 SF9 2B		4 0 2 2 0 0 2		
Davey Williams, R (1, 4) OBP: 0.286, SLG: 0.323					0-2 SH3-4 1B		1-1 F6		3-2 6-3	4 0 1 0 0 0 3		
Wes Westrum, R (1, 2) OBP: 0.313, SLG: 0.304					0-1 F9		0-0 SH3-4 2B 1B		1-2 SF9	3 1 1 1 0 0 1		
Sal Maglie, R (1, 1) OBP: 0.191, SLG: 0.127					0-1 SH3-4		0-0 SH3-4		1-3 K	2 0 0 0 0 2 1		
<b>Inning Stats</b>	R: 2 H: 3 E: 0 LOB: 1 K: 0 BB: 1 S: 10 P: 19	R: 0 H: 0 E: 0 LOB: 0 K: 1 BB: 0 S: 9 P: 12	R: 0 H: 0 E: 0 LOB: 0 K: 1 BB: 0 S: 6 P: 7	R: 0 H: 1 E: 0 LOB: 0 K: 1 BB: 0 S: 6 P: 11	R: 0 H: 1 E: 0 LOB: 1 K: 0 BB: 0 S: 8 P: 8	R: 2 H: 3 E: 0 LOB: 1 K: 1 BB: 0 S: 14 P: 21	R: 1 H: 2 E: 0 LOB: 1 K: 0 BB: 0 S: 8 P: 9	R: 2 H: 3 E: 0 LOB: 1 K: 1 BB: 0 S: 13 P: 20	R: 0 H: 1 E: 0 LOB: 1 K: 1 BB: 0 S: 8 P: 12	1B: 9 SF: 1 2B: 5 SAC: 4 3B: 0 DP: 1 HR: 0 HBP: 0	WP: 0 PA: 40 PB: 0 SB: 0 CS: 1	
<b>PITCHER</b>	IP WLS BF H R ER SO BB IBB HBP BLK WP HR S P ERA WHIP											
Carl Erskine, R (1, 1) ERA: 4.08	7.0 L 30 10 5 5 4 1 0 0 0 0 0 0 61 87 6.43 1.571											
Jim Hughes, R (8, 1) ERA: 3.31	1.0 6 3 2 2 1 0 0 0 0 0 0 0 13 20 18.00 3.000											
Pete Wojey, R (9, 1) ERA: 3.25	1.0 4 1 0 0 0 1 0 0 0 0 0 0 8 12 0.00 1.000											

**New York Giants @ Brooklyn Dodgers**  
 Ebbets Field, Brooklyn, NY  
 Mon Sep 20 1954, 3:33 AM EDT  
 Att: 26,982 - Unknown

AB	34
R	7
H	14
RBI	7
BB	1
SO	6
LOB	14





Batter	1	2	3	4	5	6	7	8	9	AB	R	H	RBI	BB	SO	LOB
--------	---	---	---	---	---	---	---	---	---	----	---	---	-----	----	----	-----

<b>Jim Gilliam, S</b> <small>OBP: 0.360, SLG: 0.417</small> (1, 4) 	4-0 		0-0 <b>B1-3</b> 		0-0 		2-1 <b>F8</b> 			3	0	1	0	1	0	0
<b>Pee Wee Reese, R</b> <small>OBP: 0.405, SLG: 0.459</small> (1, 6) 	4-1 		4-2 		1-2 <b>1-3</b> 		2-1 <b>L1</b> 			2	1	0	0	2	0	1
<b>Duke Snider, L</b> <small>OBP: 0.424, SLG: 0.642</small> (1, 8) 	1-0 <b>G4-6-3</b> 		4-0 		0-0 <b>6-3</b> 		1-3 			3	0	0	0	1	1	3
<b>Gil Hodges, R</b> <small>OBP: 0.370, SLG: 0.571</small> (1, 3) 	1-3 		3-1 		1-2 		1-2 <b>F7</b> 			4	0	2	1	0	1	1
<b>Sandy Amoros, L</b> <small>OBP: 0.359, SLG: 0.492</small> (1, 7) 		0-0 <b>L9</b> 	0-0 <b>4-1</b> 		0-1 <b>G3</b> 		2-2 <b>4-3</b> 			4	0	0	0	0	0	3
<b>Carl Furillo, R</b> <small>OBP: 0.357, SLG: 0.439</small> (1, 9) 		2-2 <b>L6</b> 		0-2 	0-0 <b>L3</b> 		0-1 <b>4-3</b> 			4	0	1	0	0	0	1
<b>Jackie Robinson, R</b> <small>OBP: 0.419, SLG: 0.515</small> (1, 5) 		1-0 		2-2 	1-0 <b>F6</b> 		4-1 			3	0	1	0	1	0	2
<b>Roy Campanella, R</b> <small>OBP: 0.293, SLG: 0.412</small> (1, 2) 		2-3 <b>K</b> 		2-1 <b>6-3</b> 		1-2 <b>F2</b> 		1-2 <b>1-3</b> 		4	0	0	0	0	1	2
<b>Carl Erskine, R</b> <small>OBP: 0.198, SLG: 0.186</small> <b>George Shuba, L</b> <small>OBP: 0.240, SLG: 0.323</small> (7, PH) <b>Jim Hughes, R</b> <small>OBP: 0.200, SLG: 0.200</small> <b>Pete Wojey, R</b> (9, 1)		0-1 <b>F4</b> 		0-3 		2-3 				2	0	0	0	0	1	0

Inning Stats	R: 0	H: 0	E: 0	K: 1	S: 5	R: 0	H: 1	E: 0	K: 1	S: 9	R: 0	H: 1	E: 0	K: 0	S: 8	R: 0	H: 1	E: 0	K: 0	S: 8	R: 0	H: 1	E: 0	K: 1	S: 8	R: 0	H: 1	E: 0	K: 0	S: 7	R: 0	H: 0	E: 0	K: 1	S: 9	R: 0	H: 0	E: 0	K: 1	S: 8	R: 0	H: 0	E: 0	K: 0	S: 9	R: 0	H: 0	E: 0	K: 0	S: 9	1B: 3	2B: 2	3B: 0	HR: 0	SF: 0	SAC: 0	DP: 1	HBP: 0	WP: 0	PB: 0	SB: 0	CS: 1	PA: 35
--------------	------	------	------	------	------	------	------	------	------	------	------	------	------	------	------	------	------	------	------	------	------	------	------	------	------	------	------	------	------	------	------	------	------	------	------	------	------	------	------	------	------	------	------	------	------	------	------	------	------	------	-------	-------	-------	-------	-------	--------	-------	--------	-------	-------	-------	-------	--------

PITCHER	IP	WLS	BF	H	R	ER	SO	BB	IBB	HBP	BLK	WP	HR	S	P	ERA	WHIP
<b>Sal Maglie, R</b> <small>ERA: 3.24</small> (1, 1)	9.0	W	35	5	1	1	5	5	0	0	0	0	0	71	120	1.00	1.111

**BOTTOM**

**New York Giants @ Brooklyn Dodgers**  
 Ebbets Field, Brooklyn, NY  
 Mon Sep 20 1954, 3:33 AM EDT  
 Att. 26,982 - Unknown

<b>AB</b>	<b>30</b>
<b>R</b>	<b>1</b>
<b>H</b>	<b>5</b>
<b>RBI</b>	<b>1</b>
<b>BB</b>	<b>5</b>
<b>SO</b>	<b>5</b>
<b>LOB</b>	<b>13</b>



PITCHER	IP	WLS	BF	H	R	ER	SO	BB	IBB	HBP	BLK	WP	HR	S	P	ERA	WHIP
---------	----	-----	----	---	---	----	----	----	-----	-----	-----	----	----	---	---	-----	------





Batter	1	2	3	4	5	6	7	8	9	AB R H RBI BB SO LOB	TOP	
Whitey Lockman, L (1, 3) OBP: 0.318, SLG: 0.381 Joey Amalfitano, R (2, 5)	4-2 BB 1B BB	0-0 4-3			0-3 K			1-3 K		1 0 0 0 1 0 1 2 0 0 0 0 2 1		
Alvin Dark, R (1, 6) OBP: 0.328, SLG: 0.452 Billy Gardner, R (2, 6) OBP: 0.266, SLG: 0.294	3-2 BB 1-2 1B		3-3 K		2-3 K			1-3 K		1 0 1 0 0 0 0 3 0 0 0 0 3 1		
Don Mueller, L (1, 9) OBP: 0.359, SLG: 0.438 Bill Taylor, L (3, 9) OBP: 0.243, SLG: 0.297	0-2 F6		0-1 F9		0-3 K			3-3 K		2 0 0 0 0 0 2 2 0 0 0 0 2 1		
Willie Mays, R (1, 8) OBP: 0.413, SLG: 0.672 Eric Rodin, R (3, PR) (3, 8)	1-2 F9		3-2 FC5-4 1B		0-0 F2			1-1 5-3		2 0 1 0 0 0 2 2 0 0 0 0 0 0		
Monte Irvin, R (1, 7) OBP: 0.371, SLG: 0.450	4-2 BB 1-2 2-3 BB		1-0 FC5-4		3-1 F9			2-3 K		3 0 0 0 0 1 1 1		
Bobby Hofman, R (1, 5) OBP: 0.324, SLG: 0.475 (2, 3)	3-3 K		0-1 4-3		2-1 4-3			4-0 BB		3 0 0 0 0 1 1 3		
Davey Williams, R (1, 4) OBP: 0.284, SLG: 0.321 Hank Thompson, L (6, 4) OBP: 0.390, SLG: 0.490 Dusty Rhodes, L (9, PH) OBP: 0.420, SLG: 0.720		1-2 F8	3-2 L5		2-3 K			1-3 K		2 0 0 0 0 0 0 1 0 0 0 0 1 0 1 0 0 0 0 1 1		
Ray Katt, R (1, 2) OBP: 0.315, SLG: 0.423		1-3 K	0-0 F2		3-3 K			3-3 K		3 0 0 0 0 2 0		
Johnny Antonelli, L (1, 1) OBP: 0.198, SLG: 0.227 Mary Grissom, R (6, 1) OBP: 0.206, SLG: 0.156 Hoyt Wilhelm, R (8, 1) OBP: 0.048, SLG: 0.048		1-3 K	0-1 1B		0-1 1B			1-3 K		2 0 1 0 0 1 0 1 0 0 0 0 1 0 0 0 0 0 0 0 0		
<b>Inning Stats</b>	R: 0 H: 1 E: 0 LOB: 3 K: 1 BB: 2 S: 17 P: 32	R: 0 H: 0 E: 1 LOB: 1 K: 2 BB: 0 S: 10 P: 13	R: 0 H: 1 E: 0 LOB: 1 K: 1 BB: 0 S: 9 P: 16	R: 0 H: 0 E: 0 LOB: 0 K: 0 BB: 0 S: 7 P: 10	R: 0 H: 1 E: 0 LOB: 1 K: 3 BB: 0 S: 12 P: 14	R: 0 H: 0 E: 0 LOB: 0 K: 0 BB: 0 S: 5 P: 10	R: 0 H: 0 E: 0 LOB: 0 K: 3 BB: 0 S: 9 P: 15	R: 0 H: 0 E: 0 LOB: 0 K: 3 BB: 0 S: 9 P: 14	R: 0 H: 0 E: 0 LOB: 1 K: 2 BB: 1 S: 11 P: 19	1B: 3 SF: 0 2B: 0 SAC: 0 3B: 0 DP: 0 HR: 0 HBP: 0	WP: 0 PA: 34 PB: 0 SB: 0 CS: 0	
<b>PITCHER</b> Karl Spooner, L (1, 1) ERA:	IP WLS BF H R ER SO BB IBB HBP BLK WP HR S P ERA WHIP	9.0 W 34 3 0 0 15 3 0 0 0 0 0 0 89 143 0.00 0.667										
<b>PITCHER</b>	IP WLS BF H R ER SO BB IBB HBP BLK WP HR S P ERA WHIP											

**New York Giants @ Brooklyn Dodgers**  
 Ebbets Field, Brooklyn, NY  
 Wed Sep 22 1954, 3:33 AM EDT  
 Att. 3,256 - Unknown

[livebaseballscorecards.com](http://livebaseballscorecards.com)

**AB 31**  
**R 0**  
**H 3**  
**RBI 0**  
**BB 3**  
**SO 15**  
**LOB 13**





Batter	1	2	3	4	5	6	7	8	9	AB R H RBI BB SO LOB
Whitey Lockman, L (1, 3) OBP: 0.317, SLG: 0.379	4-0 BB G6-4-3		0-0 FC5-4 1-2f			0-0 F7		0-0 F2		3 0 0 0 1 0 1
Alvin Dark, R (1, 6) OBP: 0.327, SLG: 0.450	0-0 L5		0-0 4-3			0-0 3B 1B		0-0 F8		4 1 1 0 0 0 2
Don Mueller, L (1, 9) OBP: 0.362, SLG: 0.444	0-0 G6-4-3 1-2f			0-0 PB 1B		0-0 3B		0-0 1B		4 0 3 1 0 0 1
Willie Mays, R (1, 8) OBP: 0.411, SLG: 0.669		0-0 G3 1B		0-0 F7 1-2		0-0 F8		0-0 P3		4 0 1 0 0 0 3
Hank Thompson, L (1, 5) OBP: 0.391, SLG: 0.489		0-0 G3 1-2		0-0 F8		4-0 FC6-4 BB		0-0 FC4-6 1B		3 0 1 0 1 0 2
Monte Irvin, R (1, 7) OBP: 0.368, SLG: 0.446		0-0 F4		0-0 F8		0-0 FC6-4 1-2f		0-0 F8		4 0 0 0 0 0 5
Davey Williams, R (1, 4) OBP: 0.284, SLG: 0.320		0-0 F7			0-0 L1-3 1B		0-0 F9		0-0 FC4-6 1-2f	4 0 1 0 0 0 2
Joe Garagiola, L (1, 2) OBP: 0.393, SLG: 0.395			0-3 K		0-0 L1-3 1-2		0-0 1-3		4-0 IBB	3 0 0 0 1 1 1
Don Liddle, L (1, 1) OBP: 0.333, SLG: 0.189			0-0 FC5-4 1B		0-3 K		0-0 5-3		0-3 K	4 0 1 0 0 2 2

Inning Stats	R: 0 E: 0 K: 0 S: 2	H: 0 LOB: 0 BB: 1 P: 6	R: 0 E: 0 K: 0 S: 4	H: 1 LOB: 1 BB: 0 P: 4	R: 0 E: 0 K: 1 S: 6	H: 1 LOB: 1 BB: 0 P: 6	R: 0 E: 0 K: 0 S: 4	H: 1 LOB: 1 BB: 0 P: 4	R: 0 E: 0 K: 1 S: 5	H: 1 LOB: 0 BB: 0 P: 5	R: 1 E: 0 K: 0 S: 5	H: 2 LOB: 2 BB: 1 P: 9	R: 0 E: 0 K: 0 S: 3	H: 0 LOB: 0 BB: 0 P: 3	R: 0 E: 0 K: 0 S: 4	H: 1 LOB: 1 BB: 1 P: 4	R: 0 E: 1 K: 1 S: 6	H: 1 LOB: 2 BB: 1 P: 10	1B: 7 2B: 1 3B: 1 HR: 0	SF: 0 SAC: 0 DP: 2 HBP: 0
--------------	------------------------------	---------------------------------	------------------------------	---------------------------------	------------------------------	---------------------------------	------------------------------	---------------------------------	------------------------------	---------------------------------	------------------------------	---------------------------------	------------------------------	---------------------------------	------------------------------	---------------------------------	------------------------------	----------------------------------	----------------------------------	------------------------------------

PITCHER	IP	WLS	BF	H	R	ER	SO	BB	IBB	HBP	BLK	WP	HR	S	P	ERA	WHIP
Murry Dickson, R (1, 1) ERA: 3.82	8.0	L	31	7	1	1	2	2	0	0	0	0	0	33	41	1.12	1.125
Bob Miller, R (9, 1) ERA: 4.56	1.0		5	1	0	0	1	0	1	0	0	0	0	6	10	0.00	1.000

**TOP**

**New York Giants @ Philadelphia Phillies**  
**Connie Mack Stadium, Philadelphia, PA**

Fri Sep 24 1954, 3:33 AM EDT  
Unknown

<b>AB</b>	<b>33</b>
<b>R</b>	<b>1</b>
<b>H</b>	<b>8</b>
<b>RBI</b>	<b>1</b>
<b>BB</b>	<b>3</b>
<b>SO</b>	<b>3</b>
<b>LOB</b>	<b>19</b>

Batter	1	2	3	4	5	6	7	8	9	AB	R	H	RBI	BB	SO	LOB
Richie Ashburn, L (1, 8) OBP: 0.441, SLG: 0.375	0-3 K		0-0 1B		0-0 FC6-4			0-0 F5		4	0	1	0	0	1	2
Mel Clark, R (1, 7) OBP: 0.303, SLG: 0.371	0-0 6-3		0-3 K2-3			0-0 2B		0-0 P5		4	0	1	0	0	1	2
Stan Lopata, R (1, 2) OBP: 0.370, SLG: 0.547	0-0 F8			0-0 1-3		0-0 F8		0-0 F8		4	0	0	0	0	0	1
Granny Hamner, R (1, 4) OBP: 0.351, SLG: 0.469		0-0 F8		0-0 6-3		0-0 6-3		0-0 F3		4	0	0	0	0	0	1
Del Ennis, R (1, 9) Earl Torgeson, L (9, PR) OBP: 0.318, SLG: 0.449 OBP: 0.364, SLG: 0.371		0-0 P4		0-0 F8		0-0 F3		0-0 1B		4	0	1	0	0	0	1
Bobby Morgan, R (1, 6) OBP: 0.357, SLG: 0.422		0-0 6-3			0-0 F7		0-0 F9		0-0 F9	4	0	0	0	0	0	1
Willie Jones, R (1, 5) OBP: 0.340, SLG: 0.402			0-0 G5-4-3 1B		4-0 BB 1B		0-0 6-3			2	0	1	0	1	0	0
Johnny Wyrostek, L (1, 3) OBP: 0.312, SLG: 0.361			0-0 G5-4-3 1-2f		0-0 F7		0-0 F3			3	0	0	0	0	0	2
Murry Dickson, R (1, 1) Danny Schell, R (8, PH) Bob Miller, R (9, 1) OBP: 0.210, SLG: 0.215 OBP: 0.322, SLG: 0.432 OBP: 0.204, SLG: 0.235			4-0 BB 1B		0-0 FC6-4 1-2 1B			0-0 P3		1	0	1	0	1	0	0
										1	0	0	0	0	0	0
										0	0	0	0	0	0	0

Inning Stats	R: 0	H: 0	E: 0	K: 1	S: 5	R: 0	H: 0	E: 0	K: 0	S: 3	R: 0	H: 2	E: 0	K: 1	S: 6	R: 0	H: 0	E: 0	K: 0	S: 3	R: 0	H: 1	E: 0	K: 0	S: 4	R: 0	H: 1	E: 0	K: 0	S: 4	R: 0	H: 0	E: 0	K: 0	S: 3	R: 0	H: 0	E: 0	K: 0	S: 3	R: 0	H: 1	E: 0	K: 0	S: 4	1B: 4	SF: 0	2B: 1	3B: 0	HR: 0	WP: 0	PB: 0	SB: 0	CS: 0	PA: 33
PITCHER Don Liddle, L (1, 1) ERA: 3.06	IP	WLS	BF	H	R	ER	SO	BB	IBB	HBP	BLK	WP	HR	S	P	ERA	WHIP	IP	WLS	BF	H	R	ER	SO	BB	IBB	HBP	BLK	WP	HR	S	P	ERA	WHIP	IP	WLS	BF	H	R	ER	SO	BB	IBB	HBP	BLK	WP	HR	S	P	ERA	WHIP				

**BOTTOM**

**New York Giants @ Philadelphia Phillies**  
**Connie Mack Stadium, Philadelphia, PA**

Fri Sep 24 1954, 3:33 AM EDT  
 Unknown

livebaseballscorecards.com

AB	31
R	0
H	5
RBI	0
BB	2
SO	2
LOB	10



Batter	1	2	3	4	5	6	7	8	9	AB R H RBI BB SO LOB	TOP		
Whitey Lockman, L (1, 3) OBP: 0.316, SLG: 0.377 Joey Amalfitano, R (3, 5) Hank Thompson, L (8, PH) OBP: 0.390, SLG: 0.488	0-0 E6 FC5-4		0-0 4-3			0-3 K		0-0 F2		2 0 0 0 0 0 0 1 0 0 0 0 1 0 1 0 0 0 0 0 0			
Alvin Dark, R (1, 6) Billy Gardner, R (3, 6) OBP: 0.261, SLG: 0.288	0-0 FC5-4 FC6-4 1-2f		0-0 F5			0-0 F6		0-0 6-3		2 0 0 0 0 0 1 2 0 0 0 0 0 0			
Don Mueller, L (1, 9) OBP: 0.363, SLG: 0.444	0-0 F9			0-0 4-3			0-0 FC5-4 FC6-4 1B		0-0 1B	4 1 2 0 0 0 1			
Willie Mays, R (1, 8) OBP: 0.410, SLG: 0.666	0-0 FC6-4 1-2f			0-0 6-3			0-0 FC5-4 1-2 1B		0-3 K	4 0 1 0 0 1 2			
Monte Irvin, R (1, 7) OBP: 0.365, SLG: 0.442		0-3 K		0-0 6-3			0-0 FC5-4 FC6-4 1-2f 2-3		0-0 F8	4 0 0 0 0 1 3			
Bobby Hofman, R (1, 5) OBP: 0.315, SLG: 0.460		0-0 F6			0-0 6-3		0-0 FC6-4 1-2f 3-H		0-0 F9	4 0 0 1 0 0 2			
Davey Williams, R (1, 4) OBP: 0.284, SLG: 0.319		0-0 F7			0-3 K		BB 0-0 BB			2 0 0 0 1 1 0			
Ray Katt, R (1, 2) OBP: 0.315, SLG: 0.437			0-0 HR		0-0 P4		0-0 F4			3 1 1 1 0 0 2			
Windy McCall, L (1, 1) George Spencer, R (2, 1) Eric Rodin, R (3, PH) Al Worthington, R (3, 1) Dusty Rhodes, L (8, PH) Hoyt Wilhelm, R (8, 1) OBP: 0.418, SLG: 0.715 OBP: 0.048, SLG: 0.048			0-0 6-3			0-0 F8		0-3 K		0 0 0 0 0 0 0 0 0 0 0 0 0 0 1 0 0 0 0 0 0 1 0 0 0 0 0 0 1 0 0 0 0 1 0 0 0 0 0 0 0 0			
<b>Inning Stats</b>	R: 0 H: 0 E: 1 LOB: 1 K: 0 BB: 0 S: 4 P: 4	R: 0 H: 0 E: 0 LOB: 0 K: 1 BB: 0 S: 5 P: 5	R: 1 H: 1 E: 0 LOB: 0 K: 0 BB: 0 S: 4 P: 4	R: 0 H: 0 E: 0 LOB: 0 K: 0 BB: 0 S: 3 P: 3	R: 0 H: 0 E: 0 LOB: 0 K: 1 BB: 0 S: 5 P: 5	R: 0 H: 0 E: 0 LOB: 0 K: 1 BB: 0 S: 5 P: 5	R: 1 H: 2 E: 1 LOB: 2 K: 0 BB: 1 S: 5 P: 9	R: 0 H: 0 E: 0 LOB: 0 K: 1 BB: 0 S: 5 P: 5	R: 0 H: 1 E: 0 LOB: 1 K: 1 BB: 0 S: 6 P: 6	1B: 3 SF: 0 2B: 0 SAC: 0 3B: 0 DP: 0 HR: 1 HBP: 0	WP: 0 PA: 33 PB: 0 SB: 0 CS: 0		
<b>PITCHER</b>	IP WLS BF H R ER SO BB IBB HBP BLK WP HR S P ERA WHIP											<b>PITCHER</b>	IP WLS BF H R ER SO BB IBB HBP BLK WP HR S P ERA WHIP
Ron Mrozinski, L (1, 1) ERA: 4.5	6.2 W 25 3 2 2 3 1 0 0 0 0 0 1 30 34 2.70 0.600												
Robin Roberts, R (7, 1) ERA: 2.98	2.1 S 8 1 0 0 2 0 0 0 0 0 0 0 12 12 0.00 0.429												

New York Giants @ Philadelphia Phillies  
 Connie Mack Stadium, Philadelphia, PA

Fri Sep 24 1954, 3:38 AM EDT  
 Att. 12,165 - Unknown

livebaseballscorecards.com

AB	32
R	2
H	4
RBI	2
BB	1
SO	5
LOB	11





BOTTOM

New York Giants @ Philadelphia Phillies  
Connie Mack Stadium, Philadelphia, PA

Fri Sep 24 1954, 3:38 AM EDT  
Att. 12,165 - Unknown

livebaseballscorecards.com

AB	27
R	4
H	5
RBI	3
BB	4
SO	3
LOB	11



WP:	0	PA:	33
PB:	0	SB:	0
CS:	0		

AB R H RBI BB SO LOB

4 0 3 2 0 0 0

3 0 0 0 0 0 3

4 0 0 0 0 0 1

4 1 1 0 0 1 0

3 1 1 0 1 0 0

3 1 0 0 1 0 1

3 0 0 0 0 0 3

1 1 0 1 2 0 0

1 0 0 0 0 1 3

1 0 0 0 0 1 0

1B:	4	SF:	0
2B:	1	SAC:	2
3B:	0	DP:	0
HR:	0	HBP:	0

R:	0	H:	0
E:	0	LOB:	0
K:	0	BB:	0
S:	3	P:	3

R:	4	H:	2
E:	1	LOB:	1
K:	1	BB:	3
S:	7	P:	19

R:	0	H:	1
E:	0	LOB:	2
K:	0	BB:	1
S:	4	P:	8

R:	0	H:	0
E:	0	LOB:	0
K:	1	BB:	0
S:	5	P:	5

R:	0	H:	0
E:	0	LOB:	0
K:	0	BB:	0
S:	3	P:	3

R:	0	H:	1
E:	0	LOB:	1
K:	1	BB:	0
S:	6	P:	6

R:	0	H:	0
E:	0	LOB:	0
K:	0	BB:	0
S:	3	P:	3

R:	0	H:	0
E:	0	LOB:	0
K:	0	BB:	0
S:	3	P:	3

R:	0	H:	0
E:	0	LOB:	0
K:	0	BB:	0
S:	3	P:	3

R:	0	H:	0
E:	0	LOB:	0
K:	0	BB:	0
S:	3	P:	3

R:	0	H:	0
E:	0	LOB:	0
K:	0	BB:	0
S:	3	P:	3

R:	0	H:	0
E:	0	LOB:	0
K:	0	BB:	0
S:	3	P:	3

R:	0	H:	0
E:	0	LOB:	0
K:	0	BB:	0
S:	3	P:	3

R:	0	H:	0
E:	0	LOB:	0
K:	0	BB:	0
S:	3	P:	3

R:	0	H:	0
E:	0	LOB:	0
K:	0	BB:	0
S:	3	P:	3

R:	0	H:	0
E:	0	LOB:	0
K:	0	BB:	0
S:	3	P:	3

R:	0	H:	0
E:	0	LOB:	0
K:	0	BB:	0
S:	3	P:	3

R:	0	H:	0
E:	0	LOB:	0
K:	0	BB:	0
S:	3	P:	3

R:	0	H:	0
E:	0	LOB:	0
K:	0	BB:	0
S:	3	P:	3

R:	0	H:	0
E:	0	LOB:	0
K:	0	BB:	0
S:	3	P:	3

R:	0	H:	0
E:	0	LOB:	0
K:	0	BB:	0
S:	3	P:	3

R:	0	H:	0
E:	0	LOB:	0
K:	0	BB:	0
S:	3	P:	3

R:	0	H:	0
E:	0	LOB:	0
K:	0	BB:	0
S:	3	P:	3

R:	0	H:	0
E:	0	LOB:	0
K:	0	BB:	0
S:	3	P:	3

R:	0	H:	0
E:	0	LOB:	0
K:	0	BB:	0
S:	3	P:	3

R:	0	H:	0
E:	0	LOB:	0
K:	0	BB:	0
S:	3	P:	3

R:	0	H:	0
E:	0	LOB:	0
K:	0	BB:	0
S:	3	P:	3

R:	0	H:	0
E:	0	LOB:	0
K:	0	BB:	0
S:	3	P:	3

R:	0	H:	0
E:	0	LOB:	0
K:	0	BB:	0
S:	3	P:	3

R:	0	H:	0
E:	0	LOB:	0
K:	0	BB:	0
S:	3	P:	3

R:	0	H:	0
E:	0	LOB:	0
K:	0	BB:	0
S:	3	P:	3

R:	0	H:	0
E:	0	LOB:	0
K:	0	BB:	0
S:	3	P:	3

R:	0	H:	0
E:	0	LOB:	0
K:	0	BB:	0
S:	3	P:	3

R:	0	H:	0
E:	0	LOB:	0
K:	0	BB:	0
S:	3	P:	3

R:	0	H:	0
E:	0	LOB:	0
K:	0	BB:	0
S:	3	P:	3

R:	0	H:	0
E:	0	LOB:	0
K:	0	BB:	0
S:	3	P:	3

R:	0	H:	0
E:	0	LOB:	0
K:	0	BB:	0
S:	3	P:	3

R:	0	H:	0
E:	0	LOB:	0
K:	0	BB:	0
S:	3	P:	3

R:	0	H:	0
E:	0	LOB:	0
K:	0	BB:	0
S:	3	P:	3

R:	0	H:	0
E:	0	LOB:	0
K:	0	BB:	0
S:	3	P:	3

R:	0	H:	0
E:	0	LOB:	0
K:	0	BB:	0
S:	3	P:	3

R:	0	H:	0
E:	0	LOB:	0
K:	0	BB:	0
S:	3	P:	3

R:	0	H:	0
E:	0	LOB:	0
K:	0	BB:	0
S:	3	P:	3

R:	0	H:	0
E:	0	LOB:	0
K:	0	BB:	0
S:	3	P:	3

R:	0	H:	0
E:	0	LOB:	0
K:	0	BB:	0
S:	3	P:	3

R:	0	H:	0
E:	0	LOB:	0
K:	0	BB:	0
S:	3	P:	3

R:	0	H:	0
E:	0	LOB:	0
K:	0	BB:	0
S:	3	P:	3

R:	0	H:	0
E:	0	LOB:	0
K:	0	BB:	0
S:	3	P:	3

R:	0	H:	0
E:	0	LOB:	0
K:	0	BB:	0
S:	3	P:	3

R:	0	H:	0
E:	0	LOB:	0
K:	0	BB:	0
S:	3	P:	3

R:	0	H:	0
E:	0	LOB:	0
K:	0	BB:	0
S:	3	P:	3

R:	0	H:	0
E:	0	LOB:	0
K:	0	BB:	0
S:	3	P:	3

R:	0	H:	0
E:	0	LOB:	0
K:	0	BB:	0
S:	3	P:	3

R:	0	H:	0
E:	0	LOB:	0
K:	0	BB:	0
S:	3	P:	3

R:	0	H:	0
E:	0	LOB:	0
K:	0	BB:	0
S:	3	P:	3

R:	0	H:	0
E:	0	LOB:	0
K:	0	BB:	0
S:	3	P:	3

R:	0	H:	0
E:	0	LOB:	0
K:	0	BB:	0
S:	3	P:	3

R:	0	H:	0
E:	0	LOB:	0
K:	0	BB:	0
S:	3	P:	3

R:	0	H:	0
E:	0	LOB:	0
K:	0	BB:	0
S:	3	P:	3

R:	0	H:	0
E:	0	LOB:	0
K:	0	BB:	0
S:	3	P:	3

R:	0	H:	0
E:	0	LOB:	0
K:	0	BB:	0
S:	3	P:	3

R:	0	H:	0
E:	0	LOB:	0
K:	0	BB:	0
S:	3	P:	3

R:	0	H:	0
E:	0	LOB:	0
K:	0	BB:	0
S:	3	P:	3

R:	0	H:	0
E:	0	LOB:	0
K:	0	BB:	0
S:	3	P:	3

R:	0	H:	0
E:	0	LOB:	0
K:	0	BB:	0
S:	3	P:	3

R:	0	H:	0
E:	0	LOB:	0
K:	0	BB:	0
S:	3	P:	3

R:	0	H:	0
E:	0	LOB:	0
K:	0	BB:	0
S:	3	P:	3

R:	0	H:	0
E:	0	LOB:	0
K:	0	BB:	0
S:	3	P:	3

R:	0	H:	0
E:	0	LOB:	0
K:	0	BB:	0
S:	3	P:	3

R:	0	H:	0
E:	0	LOB:	0
K:	0	BB:	0
S:	3	P:	3

R:	0	H:	0
E:	0	LOB:	0
K:	0	BB:	0
S:	3	P:	3

R:	0	H:	0
E:	0	LOB:	0
K:	0	BB:	0
S:	3	P:	3

R:	0	H:	0
E:	0	LOB:	0
K:	0	BB:	0
S:	3	P:	3

R:	0	H:	0
E:	0	LOB:	0
K:	0	BB:	0
S:	3	P:	3

Batter	1	2	3	4	5	6	7	8	9	10	11	AB R H RBI BB SO LOB	TOP											
<b>Whitey Lockman, L</b> (1, 3) OBP: 0.315, SLG: 0.377	0-0 4-3		0-3 K			0-0 4-3		0-0 E9 1B 2B		0-3 K		5 1 1 0 0 2 1	<b>New York Giants @ Philadelphia Phillies</b> Connie Mack Stadium, Philadelphia, PA Sat Sep 25 1954, 3:33 AM EDT Att: 6,310 - Unknown											
<b>Alvin Dark, R</b> (1, 6) OBP: 0.325, SLG: 0.447	0-0 F4			0-0 F8		0-3 K		0-0 1B 1B		0-0 G3		5 0 1 1 0 1 1												
<b>Don Mueller, L</b> (1, 9) OBP: 0.363, SLG: 0.444	0-0 F8			0-0 F9			0-0 BB 1B	0-0 1B 1B			0-0 F6	5 0 2 0 0 0 0												
<b>Willie Mays, R</b> (1, 8) OBP: 0.409, SLG: 0.661		0-3 K		0-0 F4			4-0 1-2 BB	0-0 F8			0-0 F7	4 0 0 0 1 1 2												
<b>Monte Irvin, R</b> (1, 7) OBP: 0.363, SLG: 0.438		1-0 FC4-6 HBP			0-0 6-3		0-3 K		0-0 5-3		0-0 F8	4 0 0 0 0 1 2												
<b>Hank Thompson, L</b> (1, 5) OBP: 0.389, SLG: 0.484		0-0 F5			4-0 F7-4-3 BB		0-0 F5		0-0 4-3			3 0 0 0 1 0 3												
<b>Davey Williams, R</b> (1, 4) OBP: 0.284, SLG: 0.317		0-0 FC4-6			0-0 F7-4-3		0-0 F8		4-0 BB			3 0 0 0 1 0 4												
<b>Wes Westrum, R</b> (1, 2) OBP: 0.315, SLG: 0.305			0-0 F7			4-0 4-3 SH1-4 BB		0-0 G4-6-3 1B		0-0 F8		3 0 1 0 1 0 1												
<b>Sal Maglie, R</b> (1, 1) OBP: 0.191, SLG: 0.127			0-0 4-3			0-0 SH1-4		0-0 G4-6-3		0-0 F6		0 0 0 0 0 0 0												
<b>Bob Lemon, L</b> (3, PH)						0-0 1-2						1 0 0 0 0 0 0												
<b>Ruben Gomez, R</b> (3, 1)												0 0 0 0 0 0 0												
<b>Hoyt Wilhelm, R</b> (6, 1)												0 0 0 0 0 0 0												
<b>Bobby Hofman, R</b> (8, PH)												1 0 0 0 0 0 0												
<b>George Spencer, R</b> (8, 1)												0 0 0 0 0 0 0												
<b>Ray Katt, R</b> (10, PH)												1 0 0 0 0 0 0												
<b>Windy McCall, L</b> (10, 1)												0 0 0 0 0 0 0												
<b>Inning Stats</b>	R: 0 E: 0 K: 0 S: 3	H: 0 LOB: 0 BB: 0 P: 3	R: 0 E: 0 K: 1 S: 5	H: 0 LOB: 1 BB: 0 P: 6	R: 0 E: 0 K: 1 S: 5	H: 0 LOB: 0 BB: 0 P: 5	R: 0 E: 0 K: 0 S: 3	H: 0 LOB: 0 BB: 0 P: 3	R: 0 E: 0 K: 0 S: 2	H: 0 LOB: 0 BB: 1 P: 6	R: 0 E: 0 K: 1 S: 5	H: 1 LOB: 2 BB: 1 P: 10	R: 1 E: 1 K: 0 S: 6	H: 4 LOB: 2 BB: 0 P: 6	R: 0 E: 0 K: 0 S: 3	H: 0 LOB: 1 BB: 1 P: 7	R: 0 E: 0 K: 1 S: 5	H: 0 LOB: 0 BB: 0 P: 5	R: 0 E: 0 K: 0 S: 3	H: 0 LOB: 0 BB: 0 P: 3	1B: 4 2B: 2 3B: 0 HR: 0	SF: 0 SAC: 1 DP: 2 HBP: 1	WP: 0 PB: 0 SB: 0 CS: 0	PA: 41
<b>PITCHER</b> <b>Curt Simmons, L</b> (1, 1) ERA: 2.81	IP 11.0	WLS W	BF 41	H 5	R 1	ER 1	SO 5	BB 4	IBB 0	HBP 1	BLK 0	WP 0	HR 0	S 46	P 63	ERA 0.82	WHIP 0.818							

livebaseballscorecards.com

AB	35
R	1
H	5
RBI	1
BB	4
SO	5
LOB	15



Batter	1	2	3	4	5	6	7	8	9	10	11	AB R H RBI BB SO LOB
Richie Ashburn, L (1, 8) OBP: 0.439, SLG: 0.377	0-0 F7	0-0 FC4-6			0-0 4-3		0-0 6-3		0-0 F8			5 0 0 0 0 0 3
Mel Clark, R (1, 7) OBP: 0.293, SLG: 0.358	0-3 K		0-0 6-3		0-0 F2		0-0 F4		0-0 4-3			5 0 0 0 0 1 0
Smoky Burgess, L (1, 2) OBP: 0.429, SLG: 0.512	0-0 5-3		0-0 1B		0-0 1B		4-0 BB		0-0 F2			4 0 2 0 1 0 0
Granny Hamner, R (1, 4) OBP: 0.353, SLG: 0.470		0-0 G3	0-0 1B	0-0 1B	0-0 FC6-4		0-0 F9		0-0 F6			5 1 3 0 0 0 1
Del Ennis, R (1, 9) OBP: 0.318, SLG: 0.445		0-0 G3	0-0 F6		0-0 FC6-4		4-0 BB		0-3 K			4 0 0 0 1 1 5
Bobby Morgan, R (1, 6) OBP: 0.359, SLG: 0.420		0-0 E	0-0 F7		0-0 SH3-4		0-0 FC3-6		0-0 FC3-6			4 1 2 1 1 0 3
Willie Jones, R (1, 5) OBP: 0.337, SLG: 0.398		0-0 E3		0-0 6-3		0-0 SH3-4		0-3 K				3 0 0 0 0 1 2
Johnny Wroostek, L (1, 3) OBP: 0.315, SLG: 0.355		4-0 FC4-6		0-3 K		0-0 3-1		0-0 F7				3 0 0 0 1 1 2
Stan Lopata, R (11, PH) OBP: 0.367, SLG: 0.539		IBB		K		2-3						0 0 0 0 1 0 0
Curt Simmons, L (1, 1) OBP: 0.202, SLG: 0.176		0-3 K		0-0 G3		0-0 4-3						4 0 0 0 0 2 4
Danny Schell, R (11, PH) OBP: 0.324, SLG: 0.434		K							0-3 K			1 0 1 1 0 0 0

Inning Stats	R: 0	H: 0	E: 0	K: 1	S: 5	R: 1	H: 2	E: 1	K: 1	S: 8	R: 0	H: 2	E: 0	K: 0	S: 5	R: 0	H: 2	E: 0	K: 0	S: 5	R: 0	H: 1	E: 0	K: 0	S: 4	R: 0	H: 0	E: 0	K: 1	S: 3	R: 0	H: 0	E: 0	K: 1	S: 5	R: 0	H: 0	E: 0	K: 1	S: 5	R: 0	H: 0	E: 0	K: 1	S: 2	R: 1	H: 1	E: 0	K: 0	S: 2	1B: 7	SF: 0	2B: 1	SAC: 2	3B: 0	DP: 0	HR: 0	HBP: 0	WP: 0	PA: 45
--------------	------	------	------	------	------	------	------	------	------	------	------	------	------	------	------	------	------	------	------	------	------	------	------	------	------	------	------	------	------	------	------	------	------	------	------	------	------	------	------	------	------	------	------	------	------	------	------	------	------	------	-------	-------	-------	--------	-------	-------	-------	--------	-------	--------

PITCHER	IP	WLS	BF	H	R	ER	SO	BB	IBB	HBP	BLK	WP	HR	S	P	ERA	WHIP
Sal Maglie, R (1, 1) ERA: 3.26	2.0		10	2	1	1	2	0	1	0	0	0	0	13	17	4.50	1.000
Ruben Gomez, R (3, 1) ERA: 2.88	3.0		13	4	0	0	1	0	0	0	0	0	0	15	15	0.00	1.333
Hoyt Wilhelm, R (6, 1) ERA: 2.1	2.0		8	1	0	0	0	1	0	0	0	0	0	7	11	0.00	1.000
George Spencer, R (8, 1) ERA: 4.5	2.0		7	0	0	0	2	1	0	0	0	0	0	10	14	0.00	0.500
Windy McCall, L (10, 1) ERA: 3.25	1.1	L	7	1	1	1	1	1	1	0	0	0	0	7	15	6.75	1.500

BOTTOM

New York Giants @ Philadelphia Phillies  
 Connie Mack Stadium, Philadelphia, PA  
 Sat Sep 25 1954, 3:33 AM EDT  
 Att: 6,310 - Unknown

livebaseballscores.com

AB	38
R	2
H	8
RBI	2
BB	5
SO	6
LOB	20



Batter	1	2	3	4	5	6	7	8	9	10	11	AB R H RBI BB SO LOB	TOP	
Whitey Lockman, L (1, 3) OBP: 0.317, SLG: 0.375	0-0 6-3		0-0 F5		0-0 4-3		0-0 FC5-4 BB		0-0 FC6-4 IBB		0-0 FC6-4 1B IBB	3 0 0 0 3 0 0	<b>New York Giants @ Philadelphia Phillies</b> Connie Mack Stadium, Philadelphia, PA Sun Sep 26 1954, 3:33 AM EST Att: 7,992 - Unknown	
Alvin Dark, R (1, 6) OBP: 0.325, SLG: 0.446 Billy Gardner, R (3, 6) OBP: 0.261, SLG: 0.287	0-0 4-3		0-0 4-3			0-0 F4	0-0 FC5-4		0-0 FC6-4		0-0 FC6-4 1B	2 0 0 0 0 0 0 4 0 1 1 0 0 4		
Don Mueller, L (1, 9) OBP: 0.363, SLG: 0.444	0-0 1B		0-0 F5			0-0 F7		0-0 F8		0-0 2B	0-0 FC6-4	6 0 2 0 0 0 2		
Dusty Rhodes, L (1, 7) OBP: 0.410, SLG: 0.695	0-0 1B			0-0 F2		0-0 F8		0-0 3-1		0-0 F2	0-0 G3	6 0 1 0 0 0 3		
Willie Mays, R (1, 8) OBP: 0.412, SLG: 0.667		0-0 4-3 E 1B		0-0 4-3			0-0 G3 3B	0-0 2B		0-0 IBB		4 1 3 0 1 0 0		
Hank Thompson, L (1, 5) OBP: 0.389, SLG: 0.482 Joey Amalfitano, R (7, 5)		0-0 E3 4-3 1-2		0-0 S BB			0-0 G3 3-H	0-0 1-3		0-3 K		2 0 0 1 1 0 1 2 0 0 0 0 1 3		
Davey Williams, R (1, 4) OBP: 0.284, SLG: 0.316		0-0 4-3 1-2 2-3		0-0 F6 1-2			0-0 1B SF9 1B		0-0 6-3	0-0 F8		5 1 1 0 0 0 5		
Wes Westrum, R (1, 2) OBP: 0.315, SLG: 0.305 Marv Grissom, R (7, 1) OBP: 0.206, SLG: 0.156 Bill Taylor, L (9, PH) OBP: 0.239, SLG: 0.292 Al Worthington, R (9, 1) George Spencer, R (9, 1)		0-3 K			0-0 F2		0-0 BB 1B		0-3 K		0-3 K	3 0 1 0 0 1 2 0 0 0 0 0 0 0 1 0 0 0 0 1 0 0 0 0 0 0 0 0 1 0 0 0 0 1 0		
Johnny Antonelli, L (1, 1) OBP: 0.196, SLG: 0.224 Jim Hearn, R (3, 1) OBP: 0.167, SLG: 0.200 Joe Garagiola, L (7, PH) OBP: 0.397, SLG: 0.415 (7, 2)		0-0 F9			0-0 F4		0-0 SF9 3-H		0-0 2B		0-0 1B 2B	1 0 0 0 0 0 2 1 0 0 0 0 0 0 2 1 2 1 0 0 0		
<b>Inning Stats</b>	R: 0 H: 2 E: 0 LOB: 2 K: 0 BB: 0 S: 4 P: 4	R: 0 H: 1 E: 1 LOB: 2 K: 1 BB: 0 S: 7 P: 7	R: 0 H: 0 E: 0 LOB: 0 K: 0 BB: 0 S: 3 P: 3	R: 0 H: 0 E: 0 LOB: 1 K: 0 BB: 1 S: 3 P: 7	R: 0 H: 0 E: 0 LOB: 0 K: 0 BB: 0 S: 3 P: 3	R: 0 H: 0 E: 0 LOB: 0 K: 0 BB: 0 S: 3 P: 3	R: 2 H: 3 E: 0 LOB: 2 K: 0 BB: 1 S: 6 P: 10	R: 0 H: 1 E: 0 LOB: 1 K: 0 BB: 0 S: 4 P: 4	R: 0 H: 1 E: 0 LOB: 2 K: 1 BB: 1 S: 6 P: 10	R: 0 H: 1 E: 0 LOB: 2 K: 1 BB: 1 S: 6 P: 10	R: 1 H: 2 E: 0 LOB: 2 K: 1 BB: 1 S: 7 P: 11	1B: 6 SF: 1 2B: 4 SAC: 0 3B: 1 DP: 0 HR: 0 HBP: 0		WP: 0 PA: 49 PB: 0 SB: 1 CS: 0
<b>PITCHER</b> Robin Roberts, R (1, 1) ERA: 2.97	IP 11.0 WLS L BF 49 H 11 R 3 ER 3 SO 4 BB 2 IBB 3 HBP 0 BLK 0 WP 0 HR 0 S 52 P 72 ERA 2.46 WHIP 1.182													

livebaseballscorecards.com

AB	43
R	3
H	11
RBI	3
BB	5
SO	4
LOB	22



BOTTOM

New York Giants @ Philadelphia Phillies

Connie Mack Stadium, Philadelphia, PA

Sun Sep 26 1954, 3:33 AM EST

Att: 7,992 - Unknown

livebaseballscores.com

AB	33
R	2
H	7
RBI	1
BB	14
SO	5
LOB	23



WP:	0	PA:	50
PB:	0		
SB:	0		
CS:	1		

Batter	1	2	3	4	5	6	7	8	9	10	11	AB	R	H	RBI	BB	SO	LOB
Richie Ashburn, L OBP: 0.441, SLG: 0.376 (1, 8)	5-3		1-3		G6-4-3 2-3 1B	IBB			BB SH1-4 BB	IBB		3	0	1	0	3	0	0
Mel Clark, R OBP: 0.291, SLG: 0.352 (1, 7)	F9		BB BB		G6-4-3 1-2f 3-H	F9			SH1-4 1-2	6-3		4	0	0	0	1	0	6
Stan Lopata, R OBP: 0.372, SLG: 0.541 Smoky Burgess, L OBP: 0.432, SLG: 0.510 (1, 2) (5, PH) (6, 2)	1B		1-2 BB		BB BB BB	BB		F8	BB IBB			1	0	1	0	1	0	0
Granny Hamner, R OBP: 0.351, SLG: 0.466 (1, 4)	F6		3-1		F8	F8		G5-4-3 BB	F8			5	0	0	0	1	0	7
Del Ennis, R OBP: 0.318, SLG: 0.442 (1, 9)		CS 1B			6-3	6-3		G5-4-3 1-2f	BB 1-2 2-3			5	0	1	0	1	0	1
Bobby Morgan, R OBP: 0.357, SLG: 0.418 (1, 6)	F2		1-3			2B SH4-3 1B		F2	4-3			5	1	1	0	0	0	4
Willie Jones, R OBP: 0.342, SLG: 0.402 (1, 5)		BB				SH4-3 1-3 2B			BB			2	0	2	0	3	0	0
Johnny Wyrostek, L OBP: 0.314, SLG: 0.351 (1, 3)	K		K			SH4-3 IBB		F8		SH1-4		3	0	0	0	1	2	3
Robin Roberts, S OBP: 0.155, SLG: 0.189 (1, 1)			K			1B G6-4-3 2B		K		K		4	1	1	1	0	3	2

Inning Stats	R: 0	H: 1	E: 0	LOB: 1	K: 0	BB: 0	S: 4	P: 4	R: 0	H: 1	E: 0	LOB: 1	K: 1	BB: 1	S: 5	P: 9	R: 0	H: 0	E: 0	LOB: 2	K: 1	BB: 2	S: 5	P: 13	R: 0	H: 1	E: 0	LOB: 1	K: 1	BB: 0	S: 6	P: 6	R: 1	H: 2	E: 0	LOB: 1	K: 0	BB: 1	S: 4	P: 8	R: 1	H: 2	E: 0	LOB: 3	K: 0	BB: 2	S: 5	P: 13	R: 0	H: 0	E: 0	LOB: 0	K: 0	BB: 1	S: 2	P: 6	R: 0	H: 0	E: 0	LOB: 1	K: 1	BB: 1	S: 5	P: 9	R: 0	H: 0	E: 0	LOB: 3	K: 0	BB: 3	S: 3	P: 15	R: 0	H: 0	E: 0	LOB: 2	K: 1	BB: 2	S: 5	P: 13	R: 0	H: 0	E: 0	LOB: 0	K: 0	BB: 1	S: 2	P: 6	R: 0	H: 0	E: 0	LOB: 0	K: 0	BB: 1	S: 2	P: 6
--------------	------	------	------	--------	------	-------	------	------	------	------	------	--------	------	-------	------	------	------	------	------	--------	------	-------	------	-------	------	------	------	--------	------	-------	------	------	------	------	------	--------	------	-------	------	------	------	------	------	--------	------	-------	------	-------	------	------	------	--------	------	-------	------	------	------	------	------	--------	------	-------	------	------	------	------	------	--------	------	-------	------	-------	------	------	------	--------	------	-------	------	-------	------	------	------	--------	------	-------	------	------	------	------	------	--------	------	-------	------	------

PITCHER	IP	WLS	BF	H	R	ER	SO	BB	IBB	HBP	BLK	WP	HR	S	P	ERA	WHIP
Johnny Antonelli, L ERA: 2.3 (1, 1)	2.0		8	2	0	0	1	1	0	0	0	0	0	9	13	0.00	1.500
Jim Hearn, R ERA: 4.22 (3, 1)	4.0		21	5	2	2	2	3	2	0	0	0	0	20	40	4.50	2.000
Marv Grissom, R ERA: 2.35 (7, 1)	2.0		7	0	0	0	1	2	0	0	0	0	0	7	15	0.00	1.000
Al Worthington, R ERA: 3.5 (9, 1)	0.2		5	0	0	0	0	2	1	0	0	0	0	2	14	0.00	3.000
George Spencer, R ERA: 3.65 (9, 1)	2.1	W	9	0	0	0	1	2	1	0	0	0	0	8	20	0.00	0.857





Batter	1	2	3	4	5	6	7	8	9	AB R H RBI BB SO LOB	TOP									
Al Smith, R (1, 7) OBP: 0.500, SLG: 0.750	0-0 HR	0-3 K		4-0 FC5-4 BB		0-0 F3			0-0 FC6-4 1B	4 1 2 1 1 1 2										
Bobby Avila, R (1, 4) OBP: 0.300, SLG: 0.222	0-0 6-3	0-0 F5		0-0 FC5-4 1-2f					0-0 FC6-4 1B	4 0 1 0 1 0 2										
Larry Doby, L (1, 8) OBP: 0.300, SLG: 0.125	0-3 K		0-3 K		0-0 F7				0-3 K	5 0 0 0 0 3 3										
Al Rosen, R (1, 5) Rudy Regalado, R (7, PR)	4-0 1B BB BB		0-0 6-3		0-0 1B				0-0 FC6-4 1-2f 2-3	3 0 1 0 1 0 1 1 0 0 0 0 0 2										
Vic Wertz, L (1, 3) OBP: 0.700, SLG: 1.000	4-0 1B 1-2 BB		0-0 BB 1B		0-0 F7				0-0 F7	3 0 1 0 2 0 3										
Wally Westlake, R (1, 9) OBP: 0.500, SLG: 0.333	0-0 1-2 2-3 1B		4-0 FC6-4 BB		0-3 K				0-0 6-3	3 0 1 0 1 1 3										
George Strickland, R (1, 6) Dave Philley, S (8, PH) Sam Dente, R (8, 6)	0-0 P3		0-0 FC6-4 1-2f		0-3 K				0-3 K	3 0 0 0 0 1 5 1 0 0 0 0 1 0 0 0 0 0 0 0 0	AB 34 R 1 H 8 RBI 1 BB 6 SO 9 LOB 21									
Jim Hegan, R (1, 2) OBP: 0.125, SLG: 0.250		0-0 SH5-3 2B		0-0 F8		0-0 L9			0-3 K	4 0 1 0 0 1 0										
Early Wynn, S (1, 1) Hank Majeski, R (8, PH) Don Mossi, L (8, 1)		0-0 SH5-3 2-3		0-3 K		0-0 2B			0-0 6-3	2 0 1 0 0 1 0 1 0 0 0 0 0 0 0 0 0 0 0 0 0										
<b>Inning Stats</b>	R: 1 E: 0 K: 1 S: 7	H: 2 LOB: 3 BB: 2 P: 15	R: 0 E: 0 K: 1 S: 6	H: 1 LOB: 1 BB: 0 P: 6	R: 0 E: 0 K: 1 S: 6	H: 1 LOB: 2 BB: 1 P: 10	R: 0 E: 0 K: 1 S: 5	H: 0 LOB: 1 BB: 1 P: 9	R: 0 E: 0 K: 1 S: 6	H: 1 LOB: 1 BB: 0 P: 6	R: 0 E: 0 K: 0 S: 3	H: 0 LOB: 2 BB: 2 P: 11	R: 0 E: 0 K: 2 S: 7	H: 0 LOB: 0 BB: 0 P: 7	R: 0 E: 0 K: 1 S: 7	H: 2 LOB: 2 BB: 0 P: 7	1B: 5 2B: 2 3B: 0 HR: 1	SF: 0 SAC: 1 DP: 0 HBP: 0	WP: 0 PB: 0 SB: 0 CS: 0	PA: 41
<b>PITCHER</b> Johnny Antonelli, L (1, 1) ERA: 1.0	IP 9.0 WLS W BF 41 H 8 R 1 ER 1 SO 9 BB 6 IBB 0 HBP 0 BLK 0 WP 0 HR 1 S 53 P 77 ERA 1.00 WHIP 1.556											<b>PITCHER</b>	IP WLS BF H R ER SO BB IBB HBP BLK WP HR S P ERA WHIP							

Cleveland Indians @ New York Giants  
Polo Grounds, New York, NY  
Thu Sep 30 1954, 3:33 AM EST  
Att: 49,099 - Unknown

livebaseballscorecards.com





Batter	1	2	3	4	5	6	7	8	9	AB R H RBI BB SO LOB	TOP											
Whitey Lockman, L (1, 3) OBP: 0.214, SLG: 0.154	0-0 FC4-6 1B	0-0 F4		0-0 6-3		4-0 SH3-4 1B BB		0-0 G3		4 1 1 0 1 0 1												
Alvin Dark, R (1, 6) OBP: 0.385, SLG: 0.333	0-3 K		0-0 1B FC5-2-5-2 1B	0-0 L9		0-0 SH3-4 1-2		0-0 1-3		4 0 1 0 0 1 1												
Don Mueller, L (1, 9) OBP: 0.286, SLG: 0.286	0-0 FC4-6 1B 1-2f		0-0 1B FC5-2-5-2 1B	0-0 P4		0-0 P5			0-0 1B 1B	5 2 2 0 0 0 2												
Willie Mays, R (1, 8) OBP: 0.462, SLG: 0.300	0-0 BB 1B 2-H		0-0 1B FC5-2-5-2 1-3 3-H	0-0 F8		0-0 1B 2-H			0-0 1B L6-3 1-3	5 1 3 2 0 0 2												
Hank Thompson, L (1, 5) OBP: 0.538, SLG: 0.444	4-0 1-2 BB		4-0 1B SH IBB	0-0 P5		0-0 FC6-4 1B 2B			0-0 L6-3 1-2	3 2 1 0 2 0 3												
Monte Irvin, R (1, 7) Dusty Rhodes, L (3, PH) OBP: 0.714, SLG: 1.667 (3, 7)	0-0 F2		0-0 1B G1-3 SH 1-3 2-H 3-H	4-0 FC6-4 IBB		0-3 K			0-3 K	1 0 0 0 0 0 2 3 0 1 2 1 2 1												
Davey Williams, R (1, 4)			0-0 SH G1-3 1-2 3-H	0-0 FC6-4 1B 1-2f 2-3		0-0 6-3				2 0 0 1 1 0 2												
Wes Westrum, R (1, 2) OBP: 0.364, SLG: 0.300			0-3 K 1-2	0-0 G1-3 1-2 2-3		0-3 K 1B 1-2 3-H				4 0 1 1 0 2 3												
Ruben Gomez, R (1, 1) Hoyt Wilhelm, R (8, 1)			0-0 L8	0-3 K		0-3 K			0-0 P6	4 0 0 0 0 2 5 0 0 0 0 0 0 0												
<b>Inning Stats</b>	R: 1 E: 1 K: 1 S: 7	H: 2 LOB: 2 BB: 1 P: 11	R: 0 E: 0 K: 1 S: 5	H: 0 LOB: 1 BB: 1 P: 9	R: 3 E: 1 K: 1 S: 9	H: 3 LOB: 2 BB: 1 P: 13	R: 0 E: 0 K: 0 S: 3	H: 0 LOB: 0 BB: 0 P: 3	R: 1 E: 0 K: 1 S: 7	H: 2 LOB: 2 BB: 1 P: 11	R: 1 E: 0 K: 0 S: 4	H: 1 LOB: 1 BB: 1 P: 8	R: 0 E: 0 K: 2 S: 7	H: 0 LOB: 0 BB: 0 P: 7	R: 0 E: 0 K: 0 S: 3	H: 0 LOB: 0 BB: 0 P: 3	R: 0 E: 0 K: 1 S: 6	H: 2 LOB: 1 BB: 0 P: 6	1B: 9 2B: 2 3B: 0 HR: 0	SF: 0 SAC: 2 DP: 1 HBP: 0	WP: 1 PB: 0 SB: 0 CS: 0	PA: 42
<b>PITCHER</b>	IP WLS BF H R ER SO BB IBB HBP BLK WP HR S P ERA WHIP																					
Mike Garcia, R (1, 1) ERA: 9.0	3.0 L 18 5 4 3 3 2 1 0 0 1 0 21 33 9.00 2.333																					
Art Houtteman, R (4, 1) ERA: 4.5	2.0 9 2 1 1 1 0 1 0 0 0 0 10 14 4.50 1.000																					
Ray Narleski, R (6, 1) ERA: 3.0	3.0 11 1 1 1 2 1 0 0 0 0 0 14 18 3.00 0.667																					
Don Mossi, L (9, 1) ERA:	1.0 4 2 0 0 0 1 0 0 0 0 0 6 6 0.00 2.000																					

**New York Giants @ Cleveland Indians**  
**Cleveland Municipal Stadium, Cleveland, OH**  
 Fri Oct 01 1954, 3:33 AM EST  
 Att: 71,555 - Unknown

AB	35
R	6
H	10
RBI	6
BB	5
SO	7
LOB	22



WP: 1	PA: 42
PB: 0	
SB: 0	
CS: 0	

ERA	WHIP



Batter	1	2	3	4	5	6	7	8	9	AB R H RBI BB SO LOB	TOP										
Whitey Lockman, L (1, 3) OBP: 0.158, SLG: 0.111	0-3 K	0-0 CS	0-0 3-1	0-0 G1-3		0-0 B3		0-0 F9		5 0 0 0 0 1 1											
Alvin Dark, R (1, 6) OBP: 0.444, SLG: 0.412	0-0 F9		0-0 1B 2B 1B		0-0 1B BB 1B	0-0 G3		0-0 4-3 SH1-4 1B		5 2 3 0 0 0 0											
Don Mueller, L (1, 9) OBP: 0.389, SLG: 0.389	0-0 1B		0-0 2B 1B		0-0 BB BB 1B	0-0 G1-3		0-0 SH1-4		4 1 3 0 0 0 0											
Willie Mays, R (1, 8) OBP: 0.444, SLG: 0.357	0-0 F3		0-0 FC5 2B		4-0 1B BB		0-0 G3		0-0 4-3	4 1 1 1 1 0 2											
Hank Thompson, L (1, 5) OBP: 0.611, SLG: 0.455		4-0 2B E BB	4-0 IBB		4-0 SH3-4 SF9 BB		0-0 G6-4-3 1B		0-0 5-3	2 2 1 1 3 0 1											
Monte Irvin, R (1, 7) OBP: 0.222, SLG: 0.333		0-0 E SF 2B	0-3 K		0-0 SF9 SH3-4 1B		0-0 G6-4-3			4 1 2 2 0 1 4											
Davey Williams, R (1, 4) OBP: 0.222, SLG: 0.333		0-0 L3	0-0 FC5		0-0 SH3-4			4-0 SH3-4 BB		2 0 0 0 1 0 4											
Wes Westrum, R (1, 2) OBP: 0.286, SLG: 0.273		0-0 SF CS		0-3 K	0-0 SF9			0-0 SH3-4		1 0 0 2 0 1 0											
Don Liddle, L (1, 1) Hoyt Wilhelm, R (7, 1) Johnny Antonelli, L (8, 1)	0-3 K	0-3 K	0-3 K	0-3 K	0-0 4-3			0-3 K		3 0 0 0 0 2 2 1 0 0 0 0 1 1 0 0 0 0 0 0 0											
<b>Inning Stats</b>	R: 0 E: 0 K: 1 S: 6	H: 1 LOB: 1 BB: 0 P: 6	R: 2 E: 2 K: 1 S: 6	H: 1 LOB: 0 BB: 1 P: 10	R: 1 E: 0 K: 1 S: 8	H: 3 LOB: 3 BB: 1 P: 12	R: 0 E: 0 K: 2 S: 7	H: 0 LOB: 0 BB: 0 P: 7	R: 4 E: 0 K: 0 S: 6	H: 3 LOB: 1 BB: 2 P: 14	R: 0 E: 0 K: 0 S: 3	H: 0 LOB: 0 BB: 0 P: 3	R: 0 E: 0 K: 0 S: 3	H: 1 LOB: 0 BB: 0 P: 3	R: 0 E: 0 K: 1 S: 5	H: 0 LOB: 1 BB: 1 P: 9	R: 0 E: 0 K: 0 S: 4	H: 1 LOB: 1 BB: 0 P: 4	1B: 8 2B: 2 3B: 0 HR: 0	SF: 2 SAC: 3 DP: 1 HBP: 0	WP: 0 PA: 42 PB: 0 SB: 0 CS: 1
<b>PITCHER</b>	IP WLS BF H R ER SO BB IBB HBP BLK WP HR S P ERA WHIP	IP WLS BF H R ER SO BB IBB HBP BLK WP HR S P ERA WHIP	IP WLS BF H R ER SO BB IBB HBP BLK WP HR S P ERA WHIP	IP WLS BF H R ER SO BB IBB HBP BLK WP HR S P ERA WHIP	IP WLS BF H R ER SO BB IBB HBP BLK WP HR S P ERA WHIP	IP WLS BF H R ER SO BB IBB HBP BLK WP HR S P ERA WHIP	IP WLS BF H R ER SO BB IBB HBP BLK WP HR S P ERA WHIP	IP WLS BF H R ER SO BB IBB HBP BLK WP HR S P ERA WHIP	IP WLS BF H R ER SO BB IBB HBP BLK WP HR S P ERA WHIP	IP WLS BF H R ER SO BB IBB HBP BLK WP HR S P ERA WHIP	IP WLS BF H R ER SO BB IBB HBP BLK WP HR S P ERA WHIP	IP WLS BF H R ER SO BB IBB HBP BLK WP HR S P ERA WHIP	IP WLS BF H R ER SO BB IBB HBP BLK WP HR S P ERA WHIP	IP WLS BF H R ER SO BB IBB HBP BLK WP HR S P ERA WHIP	IP WLS BF H R ER SO BB IBB HBP BLK WP HR S P ERA WHIP	IP WLS BF H R ER SO BB IBB HBP BLK WP HR S P ERA WHIP	IP WLS BF H R ER SO BB IBB HBP BLK WP HR S P ERA WHIP	IP WLS BF H R ER SO BB IBB HBP BLK WP HR S P ERA WHIP	IP WLS BF H R ER SO BB IBB HBP BLK WP HR S P ERA WHIP	IP WLS BF H R ER SO BB IBB HBP BLK WP HR S P ERA WHIP	IP WLS BF H R ER SO BB IBB HBP BLK WP HR S P ERA WHIP

**New York Giants @ Cleveland Indians**  
**Cleveland Municipal Stadium, Cleveland, OH**

Sat Oct 02 1954, 3:33 AM EST  
 Att: 78,102 - Unknown

livebaseballscorecards.com

<b>AB</b>	31
<b>R</b>	7
<b>H</b>	10
<b>RBI</b>	6
<b>BB</b>	5
<b>SO</b>	6
<b>LOB</b>	15



**BOTTOM**

**New York Giants @ Cleveland Indians**  
 Cleveland Municipal Stadium, Cleveland, OH

Sat Oct 02 1954, 3:33 AM EST  
 Att. 78,102 - Unknown

livebaseballscorecards.com

<b>AB</b>	<b>35</b>
<b>R</b>	<b>4</b>
<b>H</b>	<b>6</b>
<b>RBI</b>	<b>4</b>
<b>BB</b>	<b>2</b>
<b>SO</b>	<b>6</b>
<b>LOB</b>	<b>17</b>



<b>WP:</b>	1	<b>PA:</b>	37
<b>PB:</b>	0		
<b>SB:</b>	0		
<b>CS:</b>	0		

AB R H RBI BB SO LOB

3	0	0	0	0	0	1
1	0	0	0	0	0	2
1	0	0	0	0	0	1
4	0	0	0	0	1	0
4	0	0	0	0	1	1
4	0	1	0	0	0	0
4	1	2	0	0	1	2
4	0	0	0	0	2	4
3	1	0	0	1	0	2
3	1	1	0	1	0	2
1	0	0	0	0	0	1
0	0	0	0	0	0	0
0	0	0	0	0	0	0
1	1	1	3	0	0	0
0	0	0	0	0	0	0
1	0	1	1	0	0	0
0	0	0	0	0	0	0
1	0	0	0	0	1	1

1B:	4	SF:	0
2B:	1	SAC:	0
3B:	0	DP:	1
HR:	1	HBP:	0

Batter	1	2	3	4	5	6	7	8	9
Al Smith, R (1, 7) OBP: 0.353, SLG: 0.429 Dave Pope, L (7, PH) Dale Mitchell, L (9, PH)	0-0 P4		0-0 G5-4-3		0-0 F8		0-0 P1-3		0-0 F5
Bobby Avila, R (1, 4) OBP: 0.235, SLG: 0.133	0-0 L4			0-0 P6		0-0 F8		0-3 K	
Larry Doby, L (1, 8) OBP: 0.222, SLG: 0.125	0-3 K			0-0 4-3		0-0 1-3		0-0 L8	
Al Rosen, R (1, 5) OBP: 0.308, SLG: 0.250		0-0 4-3		0-0 5-3		0-0 5-3		0-0 1-3	
Vic Wertz, L (1, 3) OBP: 0.556, SLG: 0.938		0-0 WP			0-0 F8		0-0 1B	0-3 K	
Wally Westlake, R (1, 9) OBP: 0.250, SLG: 0.143		0-0 6-3			0-0 F3		0-3 K	0-3 K	
Sam Dente, R (1, 6)		0-0 L8			0-0 E1		0-0 L7	4-0 BB	
Jim Hegan, R (1, 2) OBP: 0.214, SLG: 0.231			4-0 BB		0-0 E4		0-0 1B	0-0 F3	
Bob Lemon, L (1, 1) Hal Newhouser, L (5, 1) Ray Narjeski, R (5, 1) Hank Majeski, R (5, PH) Don Mossi, L (6, 1) Rudy Regalado, R (7, PH) Mike Garcia, R (8, 1) Dave Philley, S (9, PH)			0-0 P6		0-0 HR		0-0 1B	0-3 K	

Inning Stats	R: 0	H: 0	E: 0	K: 1	S: 5	R: 0	H: 1	E: 0	K: 0	S: 4	R: 0	H: 0	E: 0	K: 0	S: 2	R: 0	H: 0	E: 0	K: 0	S: 3	R: 3	H: 1	E: 2	K: 0	S: 6	R: 0	H: 0	E: 0	K: 0	S: 3	R: 1	H: 3	E: 0	K: 1	S: 8	R: 0	H: 1	E: 1	K: 3	S: 11	R: 0	H: 0	E: 0	K: 1	S: 5	1B: 4	SF: 0	2B: 1	3B: 0	HR: 1
--------------	------	------	------	------	------	------	------	------	------	------	------	------	------	------	------	------	------	------	------	------	------	------	------	------	------	------	------	------	------	------	------	------	------	------	------	------	------	------	------	-------	------	------	------	------	------	-------	-------	-------	-------	-------

PITCHER	IP	WLS	BF	H	R	ER	SO	BB	IBB	HBP	BLK	WP	HR	S	P	ERA	WHIP
Don Liddle, L (1, 1) ERA: 1.29	6.2	W	27	5	4	1	2	1	0	0	0	1	1	30	34	1.35	0.900
Hoyt Wilhelm, R (7, 1) ERA:	0.2		4	1	0	0	1	0	0	0	0	0	0	6	6	0.00	1.500
Johnny Antonelli, L (8, 1) ERA: 0.84	1.2	S	6	0	0	0	3	1	0	0	0	0	0	11	15	0.00	0.600